

IBM i
7.4

*Database
Db2 for i SQL Reference*



Note

Before using this information and the product it supports, read the information in [“Notices” on page 2001](#).

This edition applies to IBM i 7.4 (product number 5770-SS1) and to all subsequent releases and modifications until otherwise indicated in new editions. This version does not run on all reduced instruction set computer (RISC) models nor does it run on CISC models.

This document may contain references to Licensed Internal Code. Licensed Internal Code is Machine Code and is licensed to you under the terms of the IBM License Agreement for Machine Code.

© **Copyright International Business Machines Corporation 1998, 2018.**

US Government Users Restricted Rights – Use, duplication or disclosure restricted by GSA ADP Schedule Contract with IBM Corp.

Contents

About SQL reference.....	xix
Standards compliance.....	xix
Assumptions relating to examples of SQL statements.....	xx
How to read the syntax diagrams.....	xxi
Conventions used in this book.....	xxiii
SQL accessibility.....	xxiii
PDF file for SQL reference.....	xxv
What's new for IBM i 7.4.....	xxvii
Chapter 1. Concepts.....	1
Relational database.....	1
Structured Query Language.....	2
Schemas.....	4
Tables.....	4
Keys.....	5
Constraints.....	5
Unique constraints.....	6
Referential constraints.....	6
Check constraints.....	8
Indexes.....	8
Triggers.....	9
Views.....	11
User-defined types.....	11
Aliases.....	12
Packages and access plans.....	12
Routines.....	12
Sequences.....	14
Authorization, privileges and object ownership.....	15
Catalog.....	17
Application processes, concurrency, and recovery.....	17
Locking, commit, and rollback.....	19
Unit of work.....	20
Rolling back work.....	21
Threads.....	22
Isolation level.....	23
Repeatable read.....	25
Read stability.....	25
Cursor stability.....	26
Uncommitted read.....	26
No commit.....	26
Comparison of isolation levels.....	26
Storage Structures.....	28
Character conversion.....	28
Character sets and code pages.....	31
Coded character sets and CCSIDs.....	32
Default CCSID.....	32
Collating sequence.....	33
Distributed relational database.....	35

Application servers.....	36
CONNECT (type 1) and CONNECT (type 2).....	37
Remote unit of work.....	37
Application-directed distributed unit of work.....	38
Data representation considerations.....	41
Chapter 2. Language elements.....	43
Characters.....	43
Tokens.....	44
Identifiers.....	46
SQL identifiers.....	46
System identifiers.....	46
Host identifiers.....	47
Naming conventions.....	48
SQL path.....	57
Qualification of unqualified object names.....	57
Unqualified alias, constraint, external program, index, mask, nodegroup, package, permission, sequence, table, trigger, view, and XSR object names.....	57
Unqualified function, procedure, specific name, type, and variables.....	59
SQL names and system names: special considerations.....	59
Aliases.....	60
Authorization IDs and authorization names.....	61
Procedure resolution.....	63
Data types.....	65
Nulls.....	66
Numbers.....	66
Subnormal numbers and underflow.....	68
Character strings.....	69
Character encoding schemes.....	70
Graphic strings.....	71
Graphic encoding schemes.....	72
Binary strings.....	72
Large objects.....	73
Limitations on use of strings.....	74
Datetime values.....	74
Date.....	74
Time.....	75
Timestamp.....	75
Datetime variables.....	75
String representations of datetime values.....	75
Date strings.....	75
Time strings.....	77
Timestamp strings.....	79
XML Values.....	80
DataLink values.....	81
Row ID values.....	82
User-defined types.....	82
Promotion of data types.....	85
Casting between data types.....	87
Assignments and comparisons.....	91
Numeric assignments.....	92
String assignments.....	94
Binary string assignments.....	95
Character and graphic string assignments.....	95
Datetime assignments.....	97
XML assignments.....	98
DataLink assignments.....	98

Row ID assignments.....	99
Distinct type assignments.....	100
Array type assignments.....	101
Assignments to LOB locators.....	101
Numeric comparisons.....	101
String comparisons.....	102
Datetime comparisons.....	104
XML comparisons.....	105
DataLink comparisons.....	105
Row ID comparisons.....	105
Distinct type comparisons.....	105
Array type comparisons.....	106
Rules for result data types.....	107
Conversion rules for operations that combine strings.....	112
Constants.....	114
Integer constants.....	114
Decimal constants.....	114
Floating-point constants.....	114
Decimal floating-point constants.....	114
Character-string constants.....	115
Graphic-string constants.....	116
Binary-string constants.....	117
Datetime constants.....	118
Decimal point.....	118
Delimiters.....	119
Special registers.....	121
CURRENT CLIENT_ACCTNG.....	123
CURRENT CLIENT_APPLNAME.....	123
CURRENT CLIENT_PROGRAMID.....	123
CURRENT CLIENT_USERID.....	124
CURRENT CLIENT_WRKSTNNAME.....	124
CURRENT DATE.....	125
CURRENT DEBUG MODE.....	125
CURRENT DECFLOAT ROUNDING MODE.....	126
CURRENT DEGREE.....	127
CURRENT IMPLICIT XMLPARSE OPTION.....	127
CURRENT PATH.....	128
CURRENT SCHEMA.....	129
CURRENT SERVER.....	129
CURRENT TEMPORAL SYSTEM_TIME.....	129
CURRENT TIME.....	130
CURRENT TIMESTAMP.....	131
CURRENT USER.....	131
CURRENT TIMEZONE.....	131
SESSION_USER.....	132
SYSTEM_USER.....	132
USER.....	132
Column names.....	133
Qualified column names.....	133
Correlation names.....	133
Column name qualifiers to avoid ambiguity.....	135
Table designators.....	135
Avoiding undefined or ambiguous references.....	136
Column name qualifiers in correlated references.....	137
Unqualified column names in correlated references.....	138
Variables.....	139
Global variables.....	139
References to host variables.....	140

Variables in dynamic SQL.....	143
References to LOB or XML variables.....	144
References to LOB or XML locator variables.....	144
References to LOB or XML file reference variables.....	145
References to XML variables.....	145
Host structures.....	146
Host structure arrays.....	147
Functions.....	148
Types of functions.....	148
Function invocation.....	149
Function resolution.....	150
Determining the best fit.....	151
Best fit considerations.....	157
Expressions.....	159
Without operators.....	160
With arithmetic operators.....	160
Two integer operands.....	160
Integer and decimal operands.....	161
Two decimal operands.....	161
Decimal arithmetic in SQL.....	161
Floating-point operands.....	162
Decimal floating-point operands.....	162
General arithmetic operation rules for DECFLOAT.....	163
Distinct type operands.....	164
With the concatenation operator.....	164
Scalar fullselect.....	166
Datetime operands and durations.....	166
Datetime arithmetic in SQL.....	168
Date arithmetic.....	168
Time arithmetic.....	170
Timestamp arithmetic.....	171
Precedence of operations.....	172
ARRAY constructor	173
ARRAY element specification.....	174
CASE expression.....	175
CAST specification.....	177
OLAP specifications.....	182
ROW CHANGE expression.....	193
Sequence reference.....	194
XMLCAST specification.....	198
Predicates.....	199
Basic predicate.....	200
Quantified predicate.....	202
BETWEEN predicate.....	204
DISTINCT predicate.....	205
EXISTS predicate.....	207
IN predicate.....	208
IS JSON predicate.....	210
JSON_EXISTS predicate.....	212
sql-json-path-expression.....	214
LIKE predicate.....	216
NULL predicate.....	220
REGEXP_LIKE predicate.....	221
Trigger event predicates.....	227
Search conditions.....	228

Chapter 3. Built-in global variables..... 231

CLIENT_HOST.....	232
CLIENT_IPADDR.....	233
CLIENT_PORT.....	234
JOB_NAME.....	235
PACKAGE_NAME.....	236
PACKAGE_SCHEMA.....	237
PACKAGE_VERSION.....	238
PROCESS_ID.....	239
ROUTINE_SCHEMA.....	240
ROUTINE_SPECIFIC_NAME.....	241
ROUTINE_TYPE.....	242
SERVER_MODE_JOB_NAME.....	243
THREAD_ID.....	244

Chapter 4. Built-in functions..... 245

Aggregate functions.....	259
ARRAY_AGG.....	260
AVG.....	262
CORR or CORRELATION.....	263
COUNT.....	264
COUNT_BIG.....	265
COVARIANCE or COVAR.....	266
COVAR_SAMP or COVARIANCE_SAMP.....	267
GROUPING.....	268
JSON_ARRAYAGG.....	269
JSON_OBJECTAGG.....	274
LISTAGG.....	278
MAX.....	281
MEDIAN.....	282
MIN.....	283
PERCENTILE_CONT.....	284
PERCENTILE_DISC.....	286
Regression functions.....	288
STDDEV_POP or STDDEV.....	291
STDDEV_SAMP.....	292
SUM.....	293
VAR_POP or VARIANCE or VAR.....	294
VAR_SAMP or VARIANCE_SAMP.....	295
XMLAGG.....	296
XMLGROUP.....	298
Scalar functions.....	301
ABS or ABSVAL.....	302
ACOS.....	303
ADD_MONTHS.....	304
ANTILOG.....	306
ARRAY_MAX_CARDINALITY.....	307
ARRAY_TRIM.....	308
ASCII.....	309
ASIN.....	310
ATAN.....	311
ATANH.....	312
ATAN2.....	313
BIGINT.....	314
BINARY.....	316
BITAND, BITANDNOT, BITOR, BITXOR, and BITNOT.....	317
BIT_LENGTH.....	319
BLOB.....	320

BSON_TO_JSON.....	321
CARDINALITY.....	322
CEILING or CEIL.....	323
CHAR.....	324
CHARACTER_LENGTH or CHAR_LENGTH.....	330
CHR.....	331
CLOB.....	332
COALESCE.....	337
COMPARE_DECFLOAT.....	338
CONCAT.....	339
CONTAINS.....	340
COS.....	343
COSH.....	344
COT.....	345
CURDATE.....	346
CURTIME.....	347
DATABASE.....	348
DATAPARTITIONNAME.....	349
DATAPARTITIONNUM.....	350
DATE.....	351
DAY.....	353
DAYNAME.....	354
DAYOFMONTH.....	355
DAYOFWEEK.....	356
DAYOFWEEK_ISO.....	357
DAYOFYEAR.....	358
DAYS.....	359
DBCLOB.....	360
DBPARTITIONNAME.....	366
DBPARTITIONNUM.....	367
DECFLOAT.....	368
DECFLOAT_FORMAT.....	370
DECFLOAT_SORTKEY.....	372
DECIMAL or DEC.....	373
DECRYPT_BIT, DECRYPT_BINARY, DECRYPT_CHAR and DECRYPT_DB.....	376
DEGREES.....	379
DIFFERENCE.....	380
DIGITS.....	381
DLCOMMENT.....	382
DLINKTYPE.....	383
DLURLCOMPLETE.....	384
DLURLPATH.....	385
DLURLPATHONLY.....	386
DLURLSCHEME.....	387
DLURLSERVER.....	388
DLVALUE.....	389
DOUBLE_PRECISION or DOUBLE.....	391
ENCRYPT_AES.....	393
ENCRYPT_RC2.....	396
ENCRYPT_TDES.....	399
EXP.....	402
EXTRACT.....	403
FLOAT.....	407
FLOOR.....	408
GENERATE_UNIQUE.....	409
GET_BLOB_FROM_FILE.....	410
GET_CLOB_FROM_FILE.....	411
GET_DBCLOB_FROM_FILE.....	412

GET_XML_FILE.....	413
GETHINT.....	414
GRAPHIC.....	415
GREATEST.....	421
HASH_MD5, HASH_SHA1, HASH_SHA256, and HASH_SHA512.....	422
HASH_ROW.....	424
HASH_VALUES.....	425
HASHED_VALUE.....	426
HEX.....	427
HEXTORAW.....	428
HOUR.....	429
IDENTITY_VAL_LOCAL.....	430
IFNULL.....	434
INSERT.....	435
INSTR.....	437
INTEGER or INT.....	438
INTERPRET.....	440
JSON_ARRAY.....	444
JSON_OBJECT.....	448
JSON_QUERY.....	452
JSON_TO_BSON.....	457
JSON_VALUE.....	458
JULIAN_DAY.....	462
LAND.....	463
LAST_DAY.....	464
LCASE.....	465
LEAST.....	466
LEFT.....	467
LENGTH.....	469
LN.....	471
LNOT.....	472
LOCATE.....	473
LOCATE_IN_STRING.....	475
LOG10.....	477
LOR.....	478
LOWER.....	479
LPAD.....	480
LTRIM.....	483
MAX.....	485
MAX_CARDINALITY.....	486
MICROSECOND.....	487
MIDNIGHT_SECONDS.....	488
MIN.....	489
MINUTE.....	490
MOD.....	491
MONTH.....	493
MONTHNAME.....	494
MONTHS_BETWEEN.....	495
MQREAD.....	497
MQREADCLOB.....	499
MQRECEIVE.....	501
MQRECEIVECLOB.....	503
MQSEND.....	505
MULTIPLY_ALT.....	507
NEXT_DAY.....	509
NORMALIZE_DECFLOAT.....	511
NOW.....	512
NULLIF.....	513

NVL.....	514
OCTET_LENGTH.....	515
OVERLAY.....	516
PI.....	519
POSITION.....	520
POSSTR.....	522
POWER or POW.....	524
QUANTIZE.....	525
QUARTER.....	527
RADIANS.....	528
RAISE_ERROR.....	529
RANDOM or RAND.....	530
REAL.....	531
REGEXP_COUNT.....	533
REGEXP_INSTR.....	535
REGEXP_REPLACE.....	537
REGEXP_SUBSTR.....	539
REPEAT.....	541
REPLACE.....	543
RID.....	545
RIGHT.....	546
ROUND.....	548
ROUND_TIMESTAMP.....	550
ROWID.....	553
RPAD.....	554
RRN.....	557
RTRIM.....	558
SCORE.....	560
SECOND.....	563
SIGN.....	565
SIN.....	566
SINH.....	567
SMALLINT.....	568
SOUNDEX.....	569
SPACE.....	570
SQRT.....	571
STRIP.....	572
STRLEFT.....	573
STRPOS.....	574
STRRIGHT.....	575
SUBSTR.....	576
SUBSTRING.....	578
TABLE_NAME.....	580
TABLE_SCHEMA.....	581
TAN.....	582
TANH.....	583
TIME.....	584
TIMESTAMP.....	585
TIMESTAMP_FORMAT.....	587
TIMESTAMP_ISO.....	592
TIMESTAMPDIFF.....	593
TO_CHAR.....	596
TO_CLOB.....	597
TO_DATE.....	598
TO_NUMBER.....	599
TO_TIMESTAMP.....	600
TOTALORDER.....	601
TRANSLATE.....	602

TRIM.....	604
TRIM_ARRAY.....	606
TRUNCATE or TRUNC.....	607
TRUNC_TIMESTAMP.....	609
UCASE.....	610
UPPER.....	611
VALUE.....	612
VARBINARY.....	613
VARBINARY_FORMAT.....	614
VARCHAR.....	616
VARCHAR_BIT_FORMAT.....	621
VARCHAR_FORMAT.....	622
VARCHAR_FORMAT_BINARY.....	630
VARGRAPHIC.....	631
VERIFY_GROUP_FOR_USER.....	637
WEEK.....	639
WEEK_ISO.....	640
WRAP.....	641
XMLATTRIBUTES.....	643
XMLCOMMENT.....	644
XMLCONCAT.....	645
XMLDOCUMENT.....	647
XMLELEMENT.....	648
XMLFOREST.....	651
XMLNAMESPACES.....	654
XMLPARSE.....	656
XMLPI.....	657
XMLROW.....	658
XMLSERIALIZE.....	660
XMLTEXT.....	664
XMLVALIDATE.....	665
XOR.....	669
XSLTRANSFORM.....	670
YEAR.....	675
ZONED.....	676
Table functions.....	679
BASE_TABLE.....	680
JSON_TABLE.....	682
M _Q READALL.....	692
M _Q READALLCLOB.....	694
M _Q RECEIVEALL.....	696
M _Q RECEIVEALLCLOB.....	699
XMLTABLE.....	702
Chapter 5. Procedures.....	711
CREATE_WRAPPED.....	712
XDBDECOMPXML.....	714
XSR_ADDSCHEMADOC.....	716
XSR_COMPLETE.....	718
XSR_REGISTER.....	720
XSR_REMOVE.....	722
Chapter 6. Queries.....	723
Authorization.....	723
subselect.....	724
select-clause.....	725
Select list notation.....	725

Applying the select list.....	726
Null attributes of result columns.....	727
Names of result columns.....	728
Data types of result columns.....	728
from-clause.....	730
table-reference.....	730
joined-table.....	738
Hierarchical queries.....	741
hierarchical-query-clause.....	742
pseudo columns.....	745
CONNECT_BY_ROOT.....	746
PRIOR.....	747
SYS_CONNECT_BY_PATH.....	749
where-clause.....	750
group-by-clause.....	751
having-clause.....	764
order-by-clause.....	765
offset-clause.....	767
fetch-clause.....	768
Examples of a subselect.....	769
fullselect.....	771
Examples of a fullselect.....	775
select-statement.....	777
common-table-expression.....	778
Recursion example: bill of materials.....	781
update-clause.....	784
read-only-clause.....	785
optimize-clause.....	786
isolation-clause.....	787
concurrent-access-resolution-clause.....	789
Examples of a select-statement.....	790
Chapter 7. Statements.....	793
How SQL statements are invoked.....	800
Embedding a statement in an application program.....	800
Dynamic preparation and execution.....	801
Static invocation of a select-statement.....	801
Dynamic invocation of a select-statement.....	801
Interactive invocation.....	802
SQL diagnostic information.....	802
Detecting and processing error and warning conditions in host language applications.....	802
SQL comments.....	803
ALLOCATE CURSOR.....	805
ALLOCATE DESCRIPTOR.....	806
ALTER FUNCTION (external scalar).....	808
ALTER FUNCTION (external table).....	813
ALTER FUNCTION (SQL scalar).....	818
ALTER FUNCTION (SQL table).....	826
ALTER MASK.....	834
ALTER PERMISSION.....	836
ALTER PROCEDURE (external).....	838
ALTER PROCEDURE (SQL).....	843
ALTER SEQUENCE.....	853
ALTER TABLE.....	858
ALTER TRIGGER.....	910
ASSOCIATE LOCATORS.....	913
BEGIN DECLARE SECTION.....	918

CALL.....	920
CLOSE.....	928
COMMENT.....	930
COMMIT.....	940
compound (dynamic).....	943
CONNECT (type 1).....	952
CONNECT (type 2).....	957
CREATE ALIAS.....	961
CREATE FUNCTION.....	965
CREATE FUNCTION (external scalar).....	970
CREATE FUNCTION (external table).....	990
CREATE FUNCTION (sourced).....	1008
CREATE FUNCTION (SQL scalar).....	1018
CREATE FUNCTION (SQL table).....	1032
CREATE INDEX.....	1045
CREATE MASK.....	1054
CREATE PERMISSION.....	1060
CREATE PROCEDURE.....	1064
CREATE PROCEDURE (external).....	1065
CREATE PROCEDURE (SQL).....	1080
CREATE SCHEMA.....	1093
CREATE SEQUENCE.....	1098
CREATE TABLE.....	1105
CREATE TRIGGER.....	1160
CREATE TYPE.....	1178
CREATE TYPE (array).....	1179
CREATE TYPE (distinct).....	1184
CREATE VARIABLE.....	1192
CREATE VIEW.....	1198
DEALLOCATE DESCRIPTOR.....	1206
DECLARE CURSOR.....	1207
DECLARE GLOBAL TEMPORARY TABLE.....	1215
DECLARE PROCEDURE.....	1236
DECLARE STATEMENT.....	1246
DECLARE VARIABLE.....	1248
DELETE.....	1251
DESCRIBE.....	1258
DESCRIBE CURSOR.....	1263
DESCRIBE INPUT.....	1265
DESCRIBE PROCEDURE.....	1268
DESCRIBE TABLE.....	1274
DISCONNECT.....	1278
DROP.....	1280
END DECLARE SECTION.....	1295
EXECUTE.....	1296
EXECUTE IMMEDIATE.....	1301
FETCH.....	1303
FREE LOCATOR.....	1310
GET DESCRIPTOR.....	1311
GET DIAGNOSTICS.....	1324
GRANT (function or procedure privileges).....	1349
GRANT (package privileges).....	1357
GRANT (schema privileges).....	1360
GRANT (sequence privileges).....	1363
GRANT (table or view privileges).....	1366
GRANT (type privileges).....	1374
GRANT (variable privileges).....	1377
GRANT (XML schema privileges).....	1380

HOLD LOCATOR.....	1383
INCLUDE.....	1385
INSERT.....	1387
LABEL.....	1399
LOCK TABLE.....	1408
MERGE.....	1410
OPEN.....	1421
PREPARE.....	1427
REFRESH TABLE.....	1445
RELEASE (connection).....	1447
RELEASE SAVEPOINT.....	1449
RENAME.....	1450
REVOKE (function or procedure privileges).....	1453
REVOKE (package privileges).....	1459
REVOKE (schema privileges).....	1461
REVOKE (sequence privileges).....	1463
REVOKE (table or view privileges).....	1465
REVOKE (type privileges).....	1469
REVOKE (variable privileges).....	1471
REVOKE (XML schema privileges).....	1473
ROLLBACK.....	1475
SAVEPOINT.....	1479
SELECT.....	1481
SELECT INTO.....	1482
SET CONNECTION.....	1485
SET CURRENT DEBUG MODE.....	1488
SET CURRENT DECFLOAT ROUNDING MODE.....	1490
SET CURRENT DEGREE.....	1492
SET CURRENT IMPLICIT XMLPARSE OPTION.....	1495
SET CURRENT TEMPORAL SYSTEM_TIME.....	1497
SET DESCRIPTOR.....	1498
SET ENCRYPTION PASSWORD.....	1503
SET OPTION.....	1505
SET PATH.....	1524
SET RESULT SETS.....	1527
SET SCHEMA.....	1530
SET SESSION AUTHORIZATION.....	1533
SET TRANSACTION.....	1536
SET variable.....	1539
SIGNAL.....	1542
TAG.....	1545
TRANSFER OWNERSHIP.....	1546
TRUNCATE.....	1549
UPDATE.....	1552
VALUES.....	1563
VALUES INTO.....	1564
WHENEVER.....	1567

Chapter 8. SQL procedural language (SQL PL)..... 1569

SQL control statements.....	1569
References to SQL parameters and SQL variables.....	1571
References to SQL condition names.....	1572
References to SQL cursor names.....	1573
References to SQL labels.....	1574
Summary of 'name' scoping in nested compound statements.....	1575
SQL-procedure-statement.....	1576
assignment-statement.....	1580

CALL statement.....	1584
CASE statement.....	1586
compound-statement.....	1588
FOR statement.....	1596
GET DIAGNOSTICS statement.....	1598
GOTO statement.....	1606
IF statement.....	1608
INCLUDE statement.....	1610
ITERATE statement.....	1613
LEAVE statement.....	1615
LOOP statement.....	1616
PIPE statement.....	1618
REPEAT statement.....	1620
RESIGNAL statement.....	1622
RETURN statement.....	1626
SIGNAL statement.....	1629
WHILE statement.....	1633

Appendix A. SQL limits..... 1635

Appendix B. Characteristics of SQL statements.....1643

Actions allowed on SQL statements.....	1644
SQL statement data access classification for routines.....	1647
Considerations for using distributed relational database.....	1650
CONNECT (type 1) and CONNECT (type 2) differences.....	1654

Appendix C. SQLCA (SQL communication area)..... 1657

Field descriptions.....	1657
INCLUDE SQLCA declarations.....	1663

Appendix D. SQLDA (SQL descriptor area).....1667

Field descriptions in an SQLDA header.....	1668
Field descriptions in an occurrence of SQLVAR.....	1673
SQLTYPE and SQLLEN.....	1677
CCSID values in SQLDATA or SQLNAME.....	1680
Unrecognized and unsupported SQLTYPES.....	1680
INCLUDE SQLDA declarations.....	1681

Appendix E. CCSID values.....1687

Appendix F. Db2 for i catalog views..... 1701

IBM i catalog tables and views.....	1705
SYSCATALOGS.....	1707
SYSCHKCST.....	1708
SYSCOLAUTH.....	1709
SYSCOLUMNS.....	1710
SYSCOLUMNS2.....	1718
SYSCOLUMNS2_SESSION.....	1729
SYSCOLUMNSTAT.....	1730
SYSCONTROLS.....	1733
SYSCONTROLSDEP.....	1735
SYSCST.....	1736
SYSCSTCOL.....	1738
SYSCSTDEP.....	1739
SYSDUMMY1.....	1740
SYSFIELDS.....	1741

SYSFUNCS.....	1745
SYSHISTORYTABLES.....	1750
SYSINDEXES.....	1751
SYSINDEXSTAT.....	1753
SYSJARCONTENTS.....	1761
SYSJAROBJECTS.....	1762
SYSKEYCST.....	1763
SYSKEYS.....	1764
SYSMQTSTAT.....	1765
SYSPACKAGE.....	1769
SYSPACKAGEAUTH.....	1771
SYSPACKAGESTAT.....	1772
SYSPACKAGESTMTSTAT.....	1778
SYSPARMS.....	1780
SYSPARTITIONDISK.....	1784
SYSPARTITIONINDEXDISK.....	1786
SYSPARTITIONINDEXES.....	1788
SYSPARTITIONINDEXSTAT.....	1795
SYSPARTITIONMQTS.....	1801
SYSPARTITIONSTAT.....	1805
SYSPERIODS.....	1809
SYSPROCS.....	1810
SYSPROGRAMSTAT.....	1813
SYSPROGRAMSTMTSTAT.....	1822
SYSREFCST.....	1824
SYSROUTINEAUTH.....	1825
SYSROUTINEDEP.....	1826
SYSROUTINES.....	1827
SYSSCHEMAAUTH.....	1833
SYSSCHEMAS.....	1834
SYSSEQUENCEAUTH.....	1835
SYSSEQUENCES.....	1836
SYSTABAUTH.....	1838
SYSTABLEDEP.....	1839
SYSTABLEINDEXSTAT.....	1840
SYSTABLES.....	1845
SYSTABLESTAT.....	1849
SYSTRIGCOL.....	1852
SYSTRIGDEP.....	1853
SYSTRIGGERS.....	1854
SYSTRIGUPD.....	1858
SYSTYPES.....	1859
SYSUDTAUTH.....	1863
SYSVARIABLEAUTH.....	1864
SYSVARIABLEDEP.....	1865
SYSVARIABLES.....	1866
SYSVIEWDEP.....	1872
SYSVIEWS.....	1874
SYSXSROBJECTAUTH.....	1876
XSRANNOTATIONINFO.....	1877
XSROBJECTCOMPONENTS.....	1878
XSROBJECTHIERARCHIES.....	1879
XSROBJECTS.....	1880
ODBC and JDBC catalog views.....	1882
SQLCOLPRIVILEGES.....	1883
SQLCOLUMNS.....	1884
SQLFOREIGNKEYS.....	1894
SQLFUNCTIONCOLS.....	1895

SQLFUNCTIONS.....	1904
SQLPRIMARYKEYS.....	1905
SQLPROCEDURECOLS.....	1906
SQLPROCEDURES.....	1915
SQLSCHEMAS.....	1916
SQLSPECIALCOLUMNS.....	1917
SQLSTATISTICS.....	1923
SQLTABLEPRIVILEGES.....	1925
SQLTABLES.....	1926
SQLTYPEINFO.....	1927
SQLUDTS.....	1935
ANS and ISO catalog views.....	1937
AUTHORIZATIONS.....	1938
CHARACTER_SETS.....	1939
CHECK_CONSTRAINTS.....	1940
COLUMN_PRIVILEGES.....	1941
COLUMNS.....	1942
INFORMATION_SCHEMA_CATALOG_NAME.....	1947
PARAMETERS.....	1948
REFERENTIAL_CONSTRAINTS.....	1952
ROUTINES.....	1953
ROUTINE_PRIVILEGES.....	1962
SCHEMATA.....	1963
SEQUENCES.....	1964
SQL_FEATURES.....	1965
SQL_LANGUAGES.....	1966
SQL_SIZING.....	1967
TABLE_CONSTRAINTS.....	1968
TABLE_PRIVILEGES.....	1969
TABLES.....	1970
UDT_PRIVILEGES.....	1971
USAGE_PRIVILEGES.....	1972
USER_DEFINED_TYPES.....	1973
VARIABLE_PRIVILEGES.....	1977
VIEWS.....	1978
Appendix G. Text search argument syntax.....	1979
Examples: Simple text search.....	1981
Advanced text search operators.....	1982
Example: Using the CONTAINS function and SCORE function.....	1983
XML text search.....	1985
XML text search grammar.....	1985
Examples: XPath text search.....	1987
Text search language options.....	1989
Appendix H. Terminology differences.....	1991
Appendix I. Reserved schema names and reserved words.....	1993
Reserved schema names.....	1993
Reserved words.....	1994
Appendix J. Related information.....	1999
Notices.....	2001
Programming interface information.....	2002
Trademarks.....	2002
Terms and conditions.....	2003

Index..... 2005

About SQL reference

This book defines Structured Query Language (SQL) as supported by Db2® for IBM® i. It contains reference information for the tasks of system administration, database administration, application programming, and operation. This manual includes syntax, usage notes, keywords, and examples for each of the SQL statements used on the system.

Standards compliance

Db2 for i conforms with IBM and industry SQL Standards.

Distributed relational database architecture

- Open Group Publications: DRDA V5 Vol. 1: Distributed Relational Database Architecture(DRDA), at <https://publications.opengroup.org/c112>
- Open Group Publications: DRDA V5 Vol. 2: Formatted Data Object Content Architecture(FD:OCA), at <https://publications.opengroup.org/c113>
- Open Group Publications: DRDA V5 Vol. 3: Distributed Data Management Architecture (DDM), at <https://publications.opengroup.org/c114>

Character data representation architecture

- Character Data Representation Architecture Reference and Registry, at <http://www-01.ibm.com/software/globalization/cdra/>

Unicode standard

- The Unicode Standard, at <http://www.unicode.org>

SQL standards

Db2 for i conforms with the following industry standards for SQL:

- *ISO/IEC 9075-1:2016, Information technology - Database languages - SQL - Part 1: Framework (SQL/ Framework)*
- *ISO/IEC 9075-2:2016, Information technology - Database languages - SQL - Part 2: Foundation (SQL/ Foundation)*
- *ISO/IEC 9075-3:2016, Information technology - Database languages - SQL - Part 3: Call-Level Interface (SQL/CLI)*
- *ISO/IEC 9075-4:2016, Information technology - Database languages - SQL - Part 4: Persistent Stored Modules (SQL/PSM)*
- *ISO/IEC 9075-10:2016, Information technology - Database languages - SQL - Part 10: Object Language Bindings (SQL/OLB)*
- *ISO/IEC 9075-11:2016, Information technology - Database languages - SQL - Part 11: Information and Definition Schemas (SQL/Schemata)*
- *ISO/IEC 9075-14:2016, Information technology - Database languages - SQL - Part 14: XML-Related Specifications (SQL/XML)*

Db2 for i conforms with the following industry technical report for SQL:

- *ISO/IEC TR 19075-6:2016, Information technology - Database languages - SQL Technical Reports - Part 6: SQL support for JavaScript Object Notation (JSON)*

For strict adherence to the standards, consider using the standards options. Standards options can be specified through the following interfaces:

<i>Table 1. Standards Option Interfaces</i>	
SQL Interface	Specification
Embedded SQL	SQLCURREULE(*STD) parameter on the Create SQL Program (CRTSQLxxx) commands. The SET OPTION statement can also be used to set the SQLCURREULE values. (For more information about CRTSQLxxx commands, see Embedded SQL Programming .)
Run SQL Statements	SQLCURREULE(*STD) parameter on the Run SQL Statements (RUNSQLSTM) command. (For more information about the RUNSQLSTM command, see SQL Programming .)
Call Level Interface (CLI) on the server	SQL_ATTR_HEX_LITERALS connection attribute (For more information about CLI, see SQL Call Level Interfaces (ODBC) .)
JDBC or SQLJ on the server using IBM Developer Kit for Java™	Translate Hex connection property object (For more information about JDBC and SQLJ, see IBM Developer Kit for Java .)
ODBC on a client using the IBM i Access Family ODBC Driver	Hex Parser Option in ODBC Setup (For more information about ODBC, see IBM i Access .)
OLE DB on a client using the IBM i Access Family OLE DB Provider	Hex Parser Option Connection Object Properties (For more information about OLE DB, see IBM i Access .)
ADO .NET on a client using the IBM i Access Family ADO .NET Provider	HexParserOption in Connection Object Properties (For more information about ADO .NET, see IBM i Access .)
JDBC on a client using the IBM Toolbox for Java	Interpret SQL hexadecimal constants as binary data in JDBC Setup (For more information about JDBC, see IBM i Access .) (For more information about the IBM Toolbox for Java, see IBM Toolbox for Java .)

Assumptions relating to examples of SQL statements

The examples of SQL statements shown in this guide assume the following.

- SQL keywords are highlighted.
- Table names used in the examples are the sample tables provided in the [SQL Programming](#) topic collection. Table names that are not provided in that appendix should use schemas that you create. You can create a set of sample tables in your own schema by issuing the following SQL statement:

```
CALL QSYS.CREATE_SQL_SAMPLE ('your-schema-name')
```

Some examples use tables containing XML data. You can create these tables in your own schema by issuing the following SQL statement:

```
CALL QSYS.CREATE_XML_SAMPLE ('your-schema-name')
```

- The SQL naming convention is used.
- For COBOL examples, the APOST and APOSTSQL precompiler options are assumed (although they are not the default in COBOL). Character-string constants within SQL and host language statements are delimited by apostrophes (').
- A collating sequence of *HEX is used.

Whenever the examples vary from these assumptions, it is stated.

How to read the syntax diagrams

The following rules apply to the syntax diagrams used in this book.



- Read the syntax diagrams from left to right, from top to bottom, following the path of the line.

The  symbol indicates the beginning of the syntax diagram.



The  symbol indicates that the syntax is continued on the next line.

The  symbol indicates that the syntax is continued from the previous line.



The  symbol indicates the end of the syntax diagram.

Diagrams of syntactical units start with the  symbol and end with the  symbol.



- Required items appear on the horizontal line (the main path).

 *required_item* 

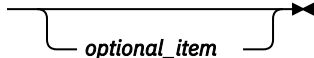
- Optional items appear below the main path.

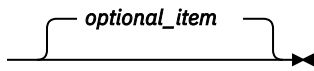

 *required_item* 

If an item appears above the main path, that item is optional, and has no effect on the execution of the statement and is used only for readability.



 *required_item* 

- If more than one item can be chosen, they appear vertically, in a stack.

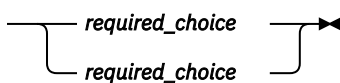
If one of the items must be chosen, one item of the stack appears on the main path.

 *required_item* 

If choosing one of the items is optional, the entire stack appears below the main path.

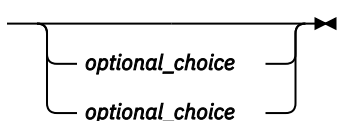
 *required_item* 

If one of the items is the default, it will appear above the main path and the remaining choices will be shown below.

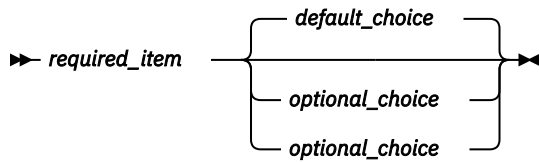

If an optional item has a default when it is not specified, the default appears above the main path.

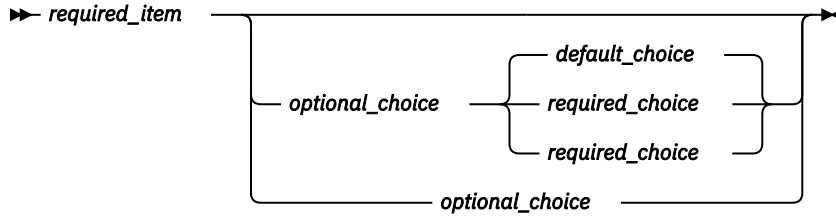

- An arrow returning to the left, above the main line, indicates an item that can be repeated.

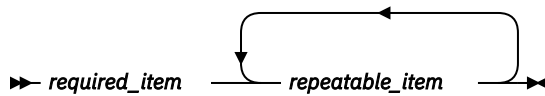

If the repeat arrow contains a comma, you must separate repeated items with a comma.

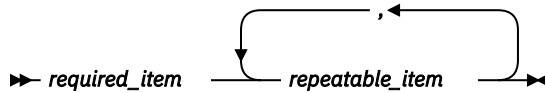

A repeat arrow above a stack indicates that the items in the stack can be repeated.

- Keywords appear in uppercase (for example, FROM). They must be spelled exactly as shown. Variables appear in all lowercase letters (for example, *column-name*). They represent user-supplied names or values.
- If punctuation marks, parentheses, arithmetic operators, or other such symbols are shown, you must enter them as part of the syntax.
- The syntax diagrams only contain the preferred or standard keywords. If nonstandard synonyms are supported in addition to the standard keywords, they are described in the **Notes** sections instead of the syntax diagrams. For maximum portability, use the preferred or standard keywords.
- Sometimes a single variable represents a larger fragment of the syntax. For example, in the following diagram, the variable `parameter-block` represents the whole syntax fragment that is labeled **parameter-block**:

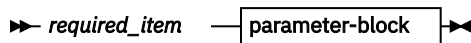

parameter-block

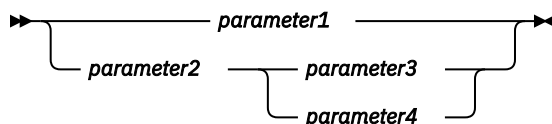

Conventions used in this book

This section specifies some conventions which are used throughout this manual.

Highlighting conventions

Bold	Indicates SQL keywords used in examples and when introducing descriptions involving the keyword.
<i>Italics</i>	Indicates one of the following: <ul style="list-style-type: none">• Variables that represent items from a syntax diagram.• The introduction of a new term.• A reference to another source of information.

Conventions for describing mixed data values

When mixed data values are shown in the examples, the following conventions apply:

Convention	Meaning
S_0	Represents the EBCDIC <i>shift-out</i> control character (X' 0E')
S_I	Represents the EBCDIC <i>shift-in</i> control character (X' 0F')
<i>sbc-string</i>	Represents a string of zero or more single-byte characters
<i>dbc-string</i>	Represents a string of zero or more double-byte characters
⌘	Represents a DBCS apostrophe (EBCDIC X' 427D')
G	Represents a DBCS G (EBCDIC X' 42C7')

Conventions for describing mixed data values description

Conventions for describing mixed data values. Shift-out character represented by X' 0E', shift-in characters represented by X' 0F', single-byte characters represented by *sbc-string*, double-byte characters represented by *dbc-string*, DBCS apostrophe represented by EBCDIC X' 427D, and DBCS G represented by EBCDIC X' 42C7.

Conventions for describing Unicode data

When a specific Unicode UTF-16 code point is referenced, it can be expressed as U+n, where n is 4 to 6 hexadecimal digits. Leading zeros are omitted, unless the code point has fewer than 4 hexadecimal digits. For example, the following values are valid representations of a UTF-16 code point:

```
U+00001 U+0012 U+0123 U+1234 U+12345 U+123456
```

SQL accessibility

IBM is committed to providing interfaces and documentation that are easily accessible to the disabled community.

For general information about IBM's Accessibility support visit the [Accessibility Center](http://www.ibm.com/able) at <http://www.ibm.com/able>. 🌐

SQL accessibility support falls in two main categories.

- System i® Navigator is graphical user interface to the IBM i operating system and Db2 for i. For information about the Accessibility features supported in Windows graphical user interfaces, see Accessibility in the Windows Help Index.
- Online documentation, online help, and prompted SQL interfaces can be accessed by a Windows Reader program such as the IBM Home Page Reader. For information about the IBM Home Page Reader and other tools, visit the [Accessibility Center](#) .

The IBM Home Page Reader can be used to access all descriptive text in this book, all articles in the SQL Information Center, and all SQL messages. Due to the complex nature of SQL syntax diagrams, however, the reader will skip syntax diagrams. Two alternatives are provided for better ease of use:

- Interactive SQL and Query Manager

Interactive SQL and Query Manager are traditional file interfaces that provide prompting for SQL statements. These are part of the IBM Db2 Query Manager and SQL Development Kit for i. For more information about Interactive SQL and Query Manager, see the [SQL Programming and Query Manager](#)

[Use](#)  topics.

- SQL Assist

SQL Assist is a graphical user interface that provides a prompted interface to SQL statements. This is part of System i Navigator. For more information, see the System i Navigator online help and the Information Center.

PDF file for SQL reference

Use this to view and print a PDF of this information.

To view or download the PDF version of this document, select [SQL reference](#).

Saving PDF files

To save a PDF on your workstation for viewing or printing:

1. Right-click the PDF link in your browser.
2. Click the option that saves the PDF locally.
3. Navigate to the directory in which you want to save the PDF.
4. Click **Save**.

Downloading Adobe Reader

You need Adobe Reader installed on your system to view or print these PDFs. You can download a free copy from the [Adobe Web site \(http://get.adobe.com/reader/\)](http://get.adobe.com/reader/) .

What's new for IBM i 7.4

This topic highlights the changes made to this topic collection for IBM i 7.4.

The major new features covered in this book include:

- New HASH functions using the MD5, SHA1, SHA-256 and SHA-512 algorithms: [“HASH_MD5, HASH_SHA1, HASH_SHA256, and HASH_SHA512” on page 422](#). The function previously named HASH has been renamed to HASH_VALUES: [“HASH_VALUES” on page 425](#)
- New trigger attribute for Db2 Mirror: [“CREATE TRIGGER” on page 1160](#), [“ALTER TRIGGER” on page 910](#)
- CREATE INDEX allows index columns to be renamed: [“CREATE INDEX” on page 1045](#)
- INSERT a row containing only default values: [“INSERT” on page 1387](#)
- The SET *transition-variable* statement has been merged into the *assignment-statement*: [“assignment-statement” on page 1580](#)

In addition, the following enhancements are new since the initial release of 7.3:

- New OLAP function: PERCENT_RANK: [“OLAP specifications” on page 182](#)
- IS JSON and JSON_EXISTS predicates: [“IS JSON predicate” on page 210](#) and [“JSON_EXISTS predicate” on page 212](#)
- LISTAGG aggregate function: [“LISTAGG” on page 278](#)
- DECFLOAT_FORMAT scalar function: [“DECFLOAT_FORMAT” on page 370](#)
- JSON publishing and scalar functions: [“JSON_ARRAYAGG” on page 269](#), [“JSON_OBJECTAGG” on page 274](#), [“JSON_ARRAY” on page 444](#), [“JSON_OBJECT” on page 448](#), [“JSON_QUERY” on page 452](#), and [“JSON_VALUE” on page 458](#)
- EXTRACT function has more options: [“EXTRACT” on page 403](#)
- LTRIM and RTRIM functions support a second argument: [“LTRIM” on page 483](#) and [“RTRIM” on page 558](#)
- NOW function allows optional precision: [“NOW” on page 512](#)
- REPLACE function's third argument is optional: [“REPLACE” on page 543](#)
- VARCHAR_FORMAT supports 2 new timestamp format string elements for microseconds and milliseconds: [“VARCHAR_FORMAT” on page 622](#)
- JSON_TABLE table function: [“JSON_TABLE” on page 682](#)
- LIMIT and OFFSET restrictions removed: [“fetch-clause” on page 768](#) and [“offset-clause” on page 767](#)
- The table correlation name for nested table expressions, table functions, JSON_TABLE, XMLTABLE, and UNNEST is optional: [“table-reference” on page 730](#)
- Functions can be defined as STATEMENT DETERMINISTIC: [“CREATE FUNCTION \(external scalar\)” on page 970](#), [“CREATE FUNCTION \(external table\)” on page 990](#), [“CREATE FUNCTION \(SQL scalar\)” on page 1018](#), [“CREATE FUNCTION \(SQL table\)” on page 1032](#)
- Unqualified functions, variables, and types within an SQL procedure or function will record a value of CURRENT PATH in SYSROUTINEDEP: [“CREATE PROCEDURE \(SQL\)” on page 1080](#), [“CREATE FUNCTION \(SQL scalar\)” on page 1018](#), and [“CREATE FUNCTION \(SQL table\)” on page 1032](#)
- CREATE TRIGGER allows dynamic statements to use 3-part names: [“CREATE TRIGGER” on page 1160](#)
- DELETE and UPDATE allow ORDER BY, FETCH, and OFFSET: [“DELETE” on page 1251](#) and [“UPDATE” on page 1552](#)
- GRANT and REVOKE on schemas: [“GRANT \(schema privileges\)” on page 1360](#) and [“REVOKE \(schema privileges\)” on page 1461](#)
- INCLUDE statement supported for SQL procedures, functions, and triggers: [“INCLUDE statement” on page 1610](#)

- SYSPARTITIONSTAT returns the TEXT value and information about partial transactions: [“SYSPARTITIONSTAT” on page 1805](#)
- SYSPROGRAMSTAT returns module name: [“SYSPROGRAMSTAT” on page 1813](#)

What's new as of April 2021

- SYSCOLUMNS2 view returns attributes for DDS created files: [“SYSCOLUMNS2” on page 1718](#)
- SYSPACKAGESTAT returns an indication that the package contains single use statements: [“SYSPACKAGESTAT” on page 1772](#)

What's new as of October 2020

- For CREATE FUNCTION, an external name that is a service program name does not require a library qualifier when the string form of the name is used. [“Naming conventions” on page 48](#)
- The SELECTIVITY clause allows user hints for individual predicates: [“Search conditions” on page 228](#)
- CREATE SEQUENCE supports the FOR SYSTEM NAME clause: [“CREATE SEQUENCE” on page 1098](#)
- DROP supports the IF EXISTS clause: [“DROP” on page 1280](#)
- The WHENEVER statement can call an internal procedure when a monitored condition is encountered: [“WHENEVER” on page 1567](#)
- SYSCOLUMNS2_SESSION view returns columns in QTEMP: [“SYSCOLUMNS2_SESSION” on page 1729](#)

What's new as of April 2020

- The language used to define SQL functions, procedures, and triggers is referred to as SQL PL (SQL Procedural Language)
- Synonyms for existing functions: [“ARRAY_MAX_CARDINALITY” on page 307](#) and [“ARRAY_TRIM” on page 308](#)
- HASH_ROW function performs a hash of all the column values for a row: [“HASH_ROW” on page 424](#)
- INTERPRET function assigns a data type to binary data: [“INTERPRET” on page 440](#)
- JSON_TABLE, JSON_QUERY, JSON_VALUE, JSON_TO_BSON, and BSON_TO_JSON have been modified to support a JSON expression that is an array: [“JSON_TABLE” on page 682](#), [“JSON_QUERY” on page 452](#), [“JSON_VALUE” on page 458](#), [“JSON_TO_BSON” on page 457](#), [“BSON_TO_JSON” on page 321](#)
- Weakly typed distinct types have been implemented: [“CREATE TYPE \(distinct\)” on page 1184](#)
- Extended indicators can be used in OPEN and EXECUTE to allow omitting host variables from the USING list: [“OPEN” on page 1421](#), [“EXECUTE” on page 1296](#)
- TAG statement added to complement WHENEVER statement for fully free form ILE RPG: [“TAG” on page 1545](#)
- Extended indicators supported in SQL PL: [“assignment-statement” on page 1580](#)
- Documented table SYSDUMMY1: [“SYSDUMMY1” on page 1740](#)
- Variable length segment and blocked insert information added to SYSPARTITIONSTAT and SYSTABLESTAT views: [“SYSPARTITIONSTAT” on page 1805](#), [“SYSTABLESTAT” on page 1849](#)

What's new as of October 2019



- ISNULL and NOTNULL are synonyms for the IS NULL and IS NOT NULL predicates: [“NULL predicate” on page 220](#)
- Synonyms for existing functions: NVL, POW, RANDOM, STRLEFT, STRRIGHT, STRPOS, TO_CLOB. [“NVL” on page 514](#), [“POWER or POW” on page 524](#), [“RANDOM or RAND” on page 530](#), [“STRLEFT” on page 573](#), [“STRRIGHT” on page 575](#), [“STRPOS” on page 574](#), and [“TO_CLOB” on page 597](#)
- CREATE FUNCTION (SQL scalar), CREATE_FUNCTION (SQL table), and CREATE PROCEDURE (SQL) support the PROGRAM NAME clause to allow the program or service program name to be specified:

[“CREATE FUNCTION \(SQL scalar\)” on page 1018](#), [“CREATE FUNCTION \(SQL table\)” on page 1032](#), and [“CREATE PROCEDURE \(SQL\)” on page 1080](#)

- CREATE FUNCTION (external scalar), CREATE_FUNCTION (external table), and CREATE PROCEDURE (external) removed the limit of 32 routine attributes that can be saved in the associated program or service program object.
- Additional index invalidation information added to SYSINDEXSTAT, SYSPARTITIONINDEXES, and SYSPARTITIONINDEXSTAT: [“SYSINDEXSTAT” on page 1753](#), [“SYSPARTITIONINDEXES” on page 1788](#), and [“SYSPARTITIONINDEXSTAT” on page 1795](#)

How to see what's new or changed

To help you see where technical changes have been made, this information uses:

- The  image to mark where new or changed information begins.
- The  image to mark where new or changed information ends.

To find other information about what's new or changed this release, see the [Memo to users](#).

Chapter 1. Concepts

This chapter provides a high-level view of concepts that are important to understand when using Structured Query Language (SQL). The reference material contained in the rest of this manual provides a more detailed view.

Relational database

A *relational database* is a database that can be perceived as a set of tables and can be manipulated in accordance with the relational model of data. The relational database contains a set of objects used to store, access, and manage data. The set of objects includes tables, views, indexes, aliases, user defined types, functions, procedures, sequences, variables, and packages.

There are three types of relational databases a user can access from an IBM i.

system relational database

There is one default relational database on an IBM i. The system relational database is always local to that IBM i. It consists of all the database objects that exist on disk attached to the IBM i that are not stored on independent auxiliary storage pools. For more information on independent auxiliary storage pools, see the [System Management](#) category of the IBM i Information Center.

The name of the system relational database is, by default, the same as the IBM i system name. However, a different name can be assigned through the use of the ADDRDBDIRE (Add RDB Directory Entry) command or System i Navigator.

user relational database

The user may create additional relational databases on an IBM i by configuring independent auxiliary storage pools on the system. Each primary independent auxiliary storage pool is a relational database. It consists of all the database objects that exist on the independent auxiliary storage pool disks. Additionally, all database objects in the system relational database of the IBM i product to which the independent auxiliary storage pool is connected are logically included in a user relational database. Thus, the name of any schema created in a user relational database must not already exist in that user relational database or in the associated system relational database.

Although the objects in the system relational database are logically included in a user relational database, certain dependencies between the objects in the system relational database and the user relational database are not allowed:

- A view must be created into a schema that exists in the same relational database as its referenced tables and views, except that a view created into QTEMP can reference tables and views in the user relational database.
- An index must be created into a schema that exists in the same relational database as its referenced table.
- A trigger or constraint must be created into a schema that exists in the same relational database as its base table.
- The parent table and dependent table in a referential constraint must both exist in the same relational database.
- Any object in the system relational database can only reference functions, procedures, and types in the same system relational database. However, objects in the user relational database may reference functions, procedures, and types in the system relational database or the same user relational database. However, operations on such an object may fail if the other relational database is not available. For example, if a user relational database is varied off and then varied on to another system.

A user relational database is local to an IBM i while the independent auxiliary storage pool is varied on. Independent auxiliary storage pools can be varied off on one IBM i and then varied on to another IBM i. Hence, a user relational databases may be local to a given IBM i at one point in time and remote

at a different point in time. For more information on independent auxiliary storage pools, see the [System Management](#) category of the IBM i Information Center.

The name of the user relational database is, by default, the same as the independent auxiliary storage pool name. However, a different name can be assigned through the use of the ADDRDBDIRE (Add RDB Directory Entry) command or System i Navigator.

remote relational database

Relational databases on other IBM i and non-IBM i products can be accessed remotely. These relational databases must be registered through the use of the ADDRDBDIRE (Add RDB Directory Entry) command or System i Navigator.

The database manager is the name used generically to identify the IBM i Licensed Internal Code and the Db2 for i portion of the code that manages the relational database.

Structured Query Language

Structured Query Language (SQL) is a standardized language for defining and manipulating data in a relational database. In accordance with the relational model of data, the database is perceived as a set of tables, relationships are represented by values in tables, and data is retrieved by specifying a result table that can be derived from one or more base tables.

SQL statements are executed by a database manager. One of the functions of the database manager is to transform the specification of a result table into a sequence of internal operations that optimize data retrieval. This transformation occurs when the SQL statement is *prepared*. This transformation is also known as *binding*.

All executable SQL statements must be prepared before they can be executed. The result of preparation is the executable or *operational form* of the statement. The method of preparing an SQL statement and the persistence of its operational form distinguish *static SQL* from *dynamic SQL*.

Static SQL

The source form of a *static SQL* statement is embedded within an application program written in a host language such as COBOL, C, or Java. The statement is prepared before the program is executed and the operational form of the statement persists beyond the execution of the program.

A source program containing static SQL statements must be processed by an SQL precompiler before it is compiled. The precompiler checks the syntax of the SQL statements, turns them into host language comments, and generates host language statements to call the database manager.

The preparation of an SQL application program includes precompilation, the preparation of its static SQL statements, and compilation of the modified source program.

Dynamic SQL

Programs containing embedded *dynamic SQL* statements must be precompiled like those containing static SQL, but unlike static SQL, the dynamic SQL statements are constructed and prepared at run time. The source form of the statement is a character or graphic string that is passed to the database manager by the program using the static SQL PREPARE or EXECUTE IMMEDIATE statement. A statement prepared using the PREPARE statement can be referenced in a DECLARE CURSOR, DESCRIBE, or EXECUTE statement. The operational form of the statement persists for the duration of the connection or until the last SQL program leaves the call stack.

SQL statements embedded in a REXX application are dynamic SQL statements. SQL statements submitted to the interactive SQL facility and to the Call Level Interface (CLI) are also dynamic SQL statements.

Extended Dynamic SQL

An extended dynamic SQL statement is neither fully static nor fully dynamic. The QSQPRCED API provides users with extended dynamic SQL capability. Like dynamic SQL, statements can be prepared, described,

and executed using this API. Unlike dynamic SQL, SQL statements prepared into a package by this API persist until the package or statement is explicitly dropped. For more information, see the [Database and File APIs](#) information in the **Programming** category of the IBM i Information Center.

Interactive SQL

An interactive SQL facility is associated with every database manager. Essentially, every interactive SQL facility is an SQL application program that reads statements from a workstation, prepares and executes them dynamically, and displays the results to the user. Such SQL statements are said to be issued *interactively*.

The interactive facilities for Db2 for i are invoked by the STRSQL command, the STRQM command, or the Run SQL Script support of System i Navigator. For more information about the interactive facilities for

SQL, see the [SQL Programming and Query Manager Use](#)  books.

SQL Call Level Interface and Open Database Connectivity

The DB2® Call Level Interface (CLI) is an application programming interface in which functions are provided to application programs to process dynamic SQL statements. DB2 CLI allows users of any of the ILE languages to access SQL functions directly through procedure calls to a service program provided by Db2 for i. CLI programs can also be compiled using an Open Database Connectivity (ODBC) Software Developer's Kit, available from Microsoft or other vendors, enabling access to ODBC data sources. Unlike using embedded SQL, no precompilation is required. Applications developed using this interface may be executed on a variety of databases without being compiled against each of the databases. Through the interface, applications use procedure calls at execution time to connect to databases, to issue SQL statements, and to get returned data and status information.

The DB2 CLI interface provides many features not available in embedded SQL. For example:

- CLI provides function calls which support a consistent way to query and retrieve database system catalog information across the DB2 family of database management systems. This reduces the need to write application server specific catalog queries.
- Stored procedures called from application programs written using CLI can return result sets to those programs.

For a complete description of all the available functions, and their syntax, see [SQL Call Level Interfaces \(ODBC\)](#) book.

Java DataBase Connectivity (JDBC) and embedded SQL for Java (SQLJ) programs

Db2 for i implements two standards-based Java programming APIs: Java Database Connectivity (JDBC) and embedded SQL for Java (SQLJ). Both can be used to create Java applications and applets that access DB2.

JDBC calls are translated to calls to DB2 CLI through Java native methods. You can access Db2 for i databases through two JDBC drivers: IBM Developer Kit for Java driver or IBM Toolbox for Java JDBC driver. For specific information about the IBM Toolbox for Java JDBC driver, see [IBM Toolbox for Java](#).

Static SQL cannot be used by JDBC. SQLJ applications use JDBC as a foundation for such tasks as connecting to databases and handling SQL errors, but can also contain embedded static SQL statements in the SQLJ source files. An SQLJ source file has to be translated with the SQLJ translator before the resulting Java source code can be compiled.

For more information about JDBC and SQLJ applications, refer to the [Developer Kit for Java](#) book.

OLE DB and ADO (ActiveX Data Object)

IBM i Access for Windows includes OLE DB Providers, along with the Programmer's Toolkit to allow DB2 client/server application development quick and easy from the Windows client PC. For more information, refer to the IBM i Access for Windows OLE DB provider in the IBM i Information Center.

.NET

IBM i Access for Windows include a .NET Provider to allow DB2 client/server application development quick and easy from the Windows client PC. For more information, refer to the IBM i Access for Windows .NET provider in the IBM i Information Center.

Schemas

The objects in a relational database are organized into sets called schemas. A schema provides a logical classification of objects in a relational database.

A *schema name* is used as the qualifier of SQL object names such as tables, views, indexes, and triggers. A schema is also called a collection or library.

A schema has a name and may have a different system name. The system name is the name used by the IBM i operating system. Either name is acceptable wherever a schema-name is specified in SQL statements.

A schema is distinct from, and should not be confused with, an XML schema, which is a standard that describes the structure and validates the content of XML documents.

Each database manager supports a set of schemas that are reserved for use by the database manager. Such schemas are called *system schemas*. The schema SESSION and all schemas that start with 'SYS' and 'Q' are *system schemas*.

User objects must not be created in *system schemas*, other than SESSION. SESSION is always used as the schema name for declared temporary tables. Users should not create schemas that start with 'SYS' or 'Q'.

A schema is also an object in the relational database. It is explicitly created using the CREATE SCHEMA statement.¹ For more information, see [“CREATE SCHEMA” on page 1093](#).

An object that is contained in a schema is assigned to the schema when the object is created. The schema to which it is assigned is determined by the name of the object if specifically qualified with a schema name or by the default schema name if not qualified.

For example, a user creates a schema called C:

```
CREATE SCHEMA C
```

The user can then issue the following statement to create a table called X in schema C:

```
CREATE TABLE C.X (COL1 INT)
```

Tables

Tables are logical structures maintained by the database manager. Tables are made up of columns and rows. There is no inherent order of the rows within a table. At the intersection of every column and row is a specific data item called a *value*. A *column* is a set of values of the same type. A *row* is a sequence of values such that the *n*th value is a value of the *n*th column of the table.

There are three types of tables:

- A *base table* is created with the CREATE TABLE statement and is used to hold persistent user data. For more information see [“CREATE TABLE” on page 1105](#).

A base table has a name and may have a different system name. The system name is the name used by the IBM i operating system. Either name is acceptable wherever a *table-name* is specified in SQL statements.

¹ A schema can also be created using the CRTLIB CL command, however, the catalog views and journal and journal receiver created by using the CREATE SCHEMA statement will not be created with CRTLIB.

A column of a base table has a name and may have a different system column name. The system column name is the name used by the IBM i operating system. Either name is acceptable wherever *column-name* is specified in SQL statements. For more information see [“CREATE TABLE” on page 1105](#).

A *materialized query table* is a base table created with the CREATE TABLE statement and used to contain data that is derived (materialized) from a *select-statement*. A source table is a base table, view, table expression, or user-defined table function. The *select-statement* specifies the query that is used to refresh the data in the materialized query table.

Materialized query tables can be used to improve the performance of SQL queries. If the database manager determines that a portion of a query could be resolved by using the data in a materialized query table, the query may be rewritten by the database manager to use the materialized query table. For more information about creating materialized query tables, see [“CREATE TABLE” on page 1105](#).

A *temporal table* associates time-based state information with every change to the data in the table. The database stores the historical rows (deleted rows or the original values of rows that have been updated) in a *history table* so you can query the past state of your data. For more information about creating temporal tables, see [“ADD VERSIONING USE HISTORY TABLE history-table-name” on page 892](#).

A *partitioned table* is a table whose data is contained in one or more local partitions (members). There are two mechanisms that can be specified to determine into which partition a specific row will be inserted. Range partitioning allows a user to specify different ranges of values for each partition. When a row is inserted, the values specified in the row are compared to the specified ranges to determine which partition is appropriate. Hash partitioning allows a user to specify a partitioning key on which a hash algorithm is used to determine which partition is appropriate. The *partitioning key* is a set of one or more columns in a partitioned table that are used to determine in which partition a row belongs.

A *distributed table* is a table whose data is partitioned across a nodegroup. A *nodegroup* is an object that provides a logical grouping of a set of two or more systems. The *partitioning key* is a set of one or more columns in a distributed table that are used to determine on which system a row belongs. For more information about distributed tables, see the [DB2 Multisystem book](#).

- A *result table* is a set of rows that the database manager selects or generates from a query. For information on queries, see [Chapter 6, “Queries,” on page 723](#).
- A *declared temporary table* is created with a DECLARE GLOBAL TEMPORARY TABLE statement and is used to hold temporary data on behalf of a single application. This table is dropped implicitly when the application disconnects from the database.

Keys

A *key* is one or more expressions that are identified as such in the description of an index, unique constraint, or a referential constraint. The same expression can be part of more than one key.

A *composite key* is an ordered set of expressions of the same base table. The ordering of the expressions is not constrained by their ordering within the base table. The term *value* when used with respect to a composite key denotes a composite value. Thus, a rule such as "the value of the foreign key must be equal to the value of the primary key" means that each component of the value of the foreign key must be equal to the corresponding component of the value of the primary key.

Constraints

A *constraint* is a rule that the database manager enforces.

There are three types of constraints:

- A *unique constraint* is a rule that forbids duplicate values in one or more columns within a table. Unique and primary keys are the supported unique constraints. For example, a unique constraint can be defined on the supplier identifier in the supplier table to ensure that the same supplier identifier is not given to two suppliers.
- A *referential constraint* is a logical rule about values in one or more columns in one or more tables. For example, a set of tables shares information about a corporation's suppliers. Occasionally, a supplier's ID changes. You can define a referential constraint stating that the ID of the supplier in a table must match

a supplier ID in the supplier information. This constraint prevents insert, update, or delete operations that would otherwise result in missing supplier information.

- A *check constraint* sets restrictions on data added to a specific table. For example, a check constraint can ensure that the salary level for an employee is at least \$20 000 whenever salary data is added or updated in a table containing personnel information.

Unique constraints

A *unique constraint* is the rule that the values of a key are valid only if they are unique. A key that is constrained to have unique values is called a *unique key*. A unique constraint is enforced by using a unique index. The unique index is used by the database manager to enforce the uniqueness of the values of the key during the execution of INSERT and UPDATE statements.

There are two types of unique constraints:

- Unique keys can be defined as a primary key using a CREATE TABLE or ALTER TABLE statement. A base table cannot have more than one primary key. A CHECK constraint will be added implicitly to enforce the rule that the NULL value is not allowed in the columns that make up the primary key. A unique index on a primary key is called a *primary index*.
- Unique keys can be defined using the UNIQUE clause of the CREATE TABLE or ALTER TABLE statement. A base table can have more than one set of UNIQUE keys. Multiple null values are allowed.

A unique key that is referenced by the foreign key of a referential constraint is called the *parent key*. A parent key is either a primary key or a UNIQUE key. When a base table is defined as a parent in a referential constraint, the default parent key is its primary key.

The unique index that is used to enforce a unique constraint is implicitly created when the unique constraint is defined. Alternatively, it can be defined by using the CREATE UNIQUE INDEX statement.

For more information about defining unique constraints, see [“ALTER TABLE” on page 858](#) or [“CREATE TABLE” on page 1105](#).

Referential constraints

Referential integrity is the state of a database in which all values of all foreign keys are valid. A *foreign key* is a key that is part of the definition of a referential constraint.

A *referential constraint* is the rule that the values of the foreign key are valid only if:

- They appear as values of a parent key, or
- Some component of the foreign key is null.

The base table containing the parent key is called the *parent table* of the referential constraint, and the base table containing the foreign key is said to be a *dependent* of that table.

Referential constraints are optional and can be defined in CREATE TABLE statements and ALTER TABLE statements. Referential constraints are enforced by the database manager during the execution of INSERT, UPDATE, and DELETE statements. The enforcement is effectively performed at the completion of the statement except for delete and update rules of RESTRICT which are enforced as rows are processed.

Referential constraints with a delete or update rule of RESTRICT are always enforced before any other referential constraints. Other referential constraints are enforced in an order independent manner. That is, the order does not affect the result of the operation. Within an SQL statement:

- A row can be marked for deletion by any number of referential constraints with a delete rule of CASCADE.
- A row can only be updated by one referential constraint with a delete rule of SET NULL or SET DEFAULT.
- A row that was updated by a referential constraint cannot also be marked for deletion by another referential constraint with a delete rule of CASCADE.

The rules of referential integrity involve the following concepts and terminology:

Parent key

A primary key or unique key of a referential constraint.

Parent row

A row that has at least one dependent row.

Parent table

A base table that is a parent in at least one referential constraint. A base table can be defined as a parent in an arbitrary number of referential constraints.

Dependent table

A base table that is a dependent in at least one referential constraint. A base table can be defined as a dependent in an arbitrary number of referential constraints. A dependent table can also be a parent table.

Descendent table

A base table is a descendent of base table T if it is a dependent of T or a descendent of a dependent of T.

Dependent row

A row that has at least one parent row.

Descendent row

A row is a descendent of row p if it is a dependent of p or a descendent of a dependent of p.

Referential cycle

A set of referential constraints such that each table in the set is a descendent of itself.

Self-referencing row

A row that is a parent of itself.

Self-referencing table

A base table that is a parent and a dependent in the same referential constraint. The constraint is called a *self-referencing constraint*.

The insert rule of a referential constraint is that a nonnull insert value of the foreign key must match some value of the parent key of the parent table. The value of a composite foreign key is null if any component of the value is null.

The update rule of a referential constraint is specified when the referential constraint is defined. The choices are NO ACTION and RESTRICT. The update rule applies when a row of the parent or dependent table is updated. The update rule of a referential constraint is that a nonnull update value of a foreign key must match some value of the parent key of the parent table. The value of a composite foreign key is treated as null if any component of the value is null.

The delete rule of a referential constraint is specified when the referential constraint is defined. The choices are RESTRICT, NO ACTION, CASCADE, SET NULL or SET DEFAULT. SET NULL can be specified only if some column of the foreign key allows null values.

The delete rule of a referential constraint applies when a row of the parent table is deleted. More precisely, the rule applies when a row of the parent table is the object of a delete or propagated delete operation (defined below) and that row has dependents in the dependent table of the referential constraint. Let P denote the parent table, let D denote the dependent table, and let p denote a parent row that is the object of a delete or propagated delete operation. If the delete rule is:

- RESTRICT or NO ACTION, an error is returned and no rows are deleted
- CASCADE, the delete operation is propagated to the dependents of p in D
- SET NULL, each nullable column of the foreign key of each dependent of p in D is set to null
- SET DEFAULT, each column of the foreign key of each dependent of p in D is set to its default value

Each referential constraint in which a table is a parent has its own delete rule, and all applicable delete rules are used to determine the result of a delete operation. Thus, a row cannot be deleted if it has dependents in a referential constraint with a delete rule of RESTRICT or NO ACTION, or if the deletion cascades to any of its descendants that are dependents in a referential constraint with the delete rule of RESTRICT or NO ACTION.

The deletion of a row from parent table P involves other tables and may affect rows of these tables:

- If table D is a dependent of P and the delete rule is RESTRICT or NO ACTION, D is involved in the operation but is not affected by the operation.
- If D is a dependent of P and the delete rule is SET NULL, D is involved in the operation, and rows of D may be updated during the operation.
- If D is a dependent of P and the delete rule is SET DEFAULT, D is involved in the operation, and rows of D may be updated during the operation.
- If D is a dependent of P and the delete rule is CASCADE, D is involved in the operation and rows of D may be deleted during the operation.

If rows of D are deleted, the delete operation on P is said to be propagated to D. If D is also a parent table, the actions described in this list apply, in turn, to the dependents of D.

Any base table that may be involved in a delete operation on P is said to be *delete-connected* to P. Thus, a base table is delete-connected to base table P if it is a dependent of P or a dependent of a base table to which delete operations from P cascade.

For more information on defining referential constraints, see [“ALTER TABLE” on page 858](#) or [“CREATE TABLE” on page 1105](#).

Check constraints

A *check constraint* is a rule that specifies which values are allowed in every row of a base table. The definition of a check constraint contains a search condition that must not be FALSE for any row of the base table.

Each column referenced in the search condition of a check constraint on a table T must identify a column of T. For more information about search conditions, see [“Search conditions” on page 228](#).

A base table can have more than one check constraint. Each check constraint defined on a base table is enforced by the database manager when either of the following occur:

- A row is inserted into that base table.
- A row of that base table is updated.

A check constraint is enforced by applying its search condition to each row that is inserted or updated in that base table. An error is returned if the result of the search condition is FALSE for any row.

For more information about defining check constraints, see [“ALTER TABLE” on page 858](#) or [“CREATE TABLE” on page 1105](#).

Indexes

An *index* is a set of pointers to rows of a base table. Each index is based on the values of data in one or more table columns. An index is an object that is separate from the data in the table. When an index is created, the database manager builds this structure and maintains it automatically.

An index has a name and may have a different system name. The system name is the name used by the IBM i operating system. Either name is acceptable wherever an *index-name* is specified in SQL statements. For more information, see [“CREATE INDEX” on page 1045](#).

The database manager uses two types of indexes:

- Binary radix tree index

Binary radix tree indexes provide a specific order to the rows of a table. The database manager uses them to:

- Improve performance. In most cases, access to data is faster than without an index.
- Ensure uniqueness. A table with a unique index cannot have rows with identical keys.

- Encoded vector index

Encoded vector indexes do not provide a specific order to the rows of a table. The database manager only uses these indexes to improve performance.

An encoded vector access path works with the help of encoded vector indexes and provides access to a database file by assigning codes to distinct key values and then representing these values in an array. The elements of the array can be 1, 2, or 4 bytes in length, depending on the number of distinct values that must be represented. Because of their compact size and relative simplicity, encoded vector access paths provide for faster scans that can be more easily processed in parallel.

An *index* is created with the CREATE INDEX statement. For more information about creating indexes, see [“CREATE INDEX” on page 1045](#).

For more information about indexes, see [IBM Db2 for i indexing methods and strategies](#) .

Triggers

A *trigger* defines a set of actions that are executed automatically whenever a delete, insert, or update operation occurs on a specified table or view. When such an SQL operation is executed, the trigger is said to be activated.

The set of actions can include almost any operation allowed on the system. A few operations are not allowed, such as:

- Commit or rollback (if the same commitment definition is used for the trigger actions and the triggering event)
- CONNECT, SET CONNECTION, DISCONNECT, and RELEASE statements
- SET SESSION AUTHORIZATION

For a complete list of restrictions, see [“CREATE TRIGGER” on page 1160](#) and the [Database Programming book](#).

Triggers can be used along with referential constraints and check constraints to enforce data integrity rules. Triggers are more powerful than constraints because they can also be used to cause updates to other tables, automatically generate or transform values for inserted or updated rows, or invoke functions that perform operations both inside and outside of database manager. For example, instead of preventing an update to a column if the new value exceeds a certain amount, a trigger can substitute a valid value and send a notice to an administrator about the invalid update.

Triggers are a useful mechanism to define and enforce transitional business rules that involve different states of the data (for example, salary cannot be increased by more than 10 percent). Such a limit requires comparing the value of a salary before and after an increase. For rules that do not involve more than one state of the data, consider using referential and check constraints.

Triggers also move the application logic that is required to enforce business rules into the database, which can result in faster application development and easier maintenance because the business rule is no longer repeated in several applications, but one version is centralized to the trigger. With the logic in the database, for example, the previously mentioned limit on increases to the salary column of a table, database manager checks the validity of the changes that any application makes to the salary column. In addition, the application programs do not need to be changed when the logic changes.

For more information about creating triggers, see [“CREATE TRIGGER” on page 1160](#).²

Triggers are optional and are defined using the CREATE TRIGGER statement or the **Add Physical File Trigger (ADDPFTRG)** CL command. Triggers are dropped using the DROP TRIGGER statement or the **Remove Physical File Trigger (RMVPFTRG)** CL command. For more information about creating triggers, see the CREATE TRIGGER statement. For more information about triggers in general, see the [“CREATE TRIGGER” on page 1160](#) statement or the [SQL Programming and the Database Programming books](#).

² The ADDPFTRG CL command also defines a trigger, including triggers that are activated on any read operation.

There are a number of criteria that are defined when creating a trigger which are used to determine when a trigger should be activated.

- The *subject table* (also known as the triggering table) defines the table or view for which the trigger is defined.
- The *trigger event* defines a specific SQL operation that modifies the subject table. The operation could be delete, insert, or update.
- The *trigger activation time* defines whether the trigger should be activated before or after the trigger event is performed on the subject table.

The statement that causes a trigger to be activated will include a *set of affected rows*. These are the rows of the subject table that are being deleted, inserted or updated. The *trigger granularity* defines whether the actions of the trigger will be performed once for the statement or once for each of the rows in the set of affected rows.

The *trigger action* consists of an optional search condition and a set of SQL statements that are executed whenever the trigger is activated. The SQL statements are only executed if no search condition is specified or the specified search condition evaluates to true.

The triggered action may refer to the values in the set of affected rows. This is supported through the use of *transition variables*. Transition variables use the names of the columns in the subject table qualified by a specified name that identifies whether the reference is to the old value (prior to the update) or the new value (after the update). The new value can also be changed using the SET transition-variable statement in before update or insert triggers. Another means of referring to the values in the set of affected rows is using *transition tables*. Transition tables also use the names of the columns of the subject table but have a name specified that allows the complete set of affected rows to be treated as a table. Transition tables can only be used in after triggers. Separate transition tables can be defined for old and new values.

Multiple triggers can be specified for a combination of table, event, or activation time. The order in which the triggers are activated is the same as the order in which they were created. Thus, the most recently created trigger will be the last trigger activated.

The activation of a trigger may cause *trigger cascading*. This is the result of the activation of one trigger that executes SQL statements that cause the activation of other triggers or even the same trigger again. The triggered actions may also cause updates as a result of the original modification, which may result in the activation of additional triggers. With trigger cascading, a significant chain of triggers may be activated causing significant change to the database as a result of a single delete, insert or update statement.

The actions performed in the trigger are considered to be part of the operation that caused the trigger to be executed. Thus, when the isolation level is anything other than NC (No Commit) and the trigger actions are performed using the same commitment definition as the trigger event:

- The database manager ensures that the operation and the triggers executed as a result of that operation either all complete or are backed out. Operations that occurred prior to the triggering operation are not affected.
- The database manager effectively checks all constraints (except for a constraint with a RESTRICT delete rule) after the operation and the associated triggers have been executed.

A trigger has an attribute that specifies whether it is allowed to delete or update a row that has already been inserted or updated within the SQL statement that caused the trigger to be executed.

- If ALWREPCHG(*YES) is specified when the trigger is defined, then within an SQL statement:
 - The trigger is allowed to update or delete any row that was inserted or already updated by that same SQL statement. This also includes any rows inserted or updated by a trigger or referential constraint caused by the same SQL statement.
- If ALWREPCHG(*NO) is specified when the trigger is defined, then within an SQL statement:
 - A row can be deleted by a trigger only if that row has not been inserted or updated by that same SQL statement. If the isolation level is anything other than NC (No Commit) and the trigger actions are performed using the same commitment definition as the trigger event, this also includes any inserts or updates by a trigger or referential constraint caused by the same SQL statement.

- A row can be updated by a trigger only if that row has not already been inserted or updated by that same SQL statement. If the isolation level is anything other than NC (No Commit) and the trigger actions are performed using the same commitment definition as the trigger event, this also includes any inserts or updates by a trigger or referential constraint caused by the same SQL statement.

All triggers created by using the CREATE TRIGGER statement implicitly have the ALWREPCHG(*YES) attribute.

Views

A *view* provides an alternative way of looking at the data in one or more tables.

A view is a named specification of a result table. The specification is a SELECT statement that is effectively executed whenever the view is referenced in an SQL statement. Thus, a view can be thought of as having columns and rows just like a base table. For retrieval, all views can be used just like base tables. Whether a view can be used in an insert, update, or delete operation depends on its definition.

An index cannot be created for a view. However, an index created for a table on which a view is based may improve the performance of operations on the view.

When the column of a view is directly derived from a column of a base table, that column inherits any constraints that apply to the column of the base table. For example, if a view includes a foreign key of its base table, INSERT and UPDATE operations using that view are subject to the same referential constraints as the base table. Likewise, if the base table of a view is a parent table, DELETE operations using that view are subject to the same rules as DELETE operations on the base table. A view also inherits any triggers that apply to its base table. For example, if the base table of a view has an update trigger, the trigger is fired when an update is performed on the view.

A view has a name and may have a different system name. The system name is the name used by the IBM i operating system. Either name is acceptable wherever a *view-name* is specified in SQL statements.

A column of a view has a name and may have a different system column name. The system column name is the name used by the IBM i operating system. Either name is acceptable wherever *column-name* is specified in SQL statements.

A *view* is created with the CREATE VIEW statement. For more information about creating views, see [“CREATE VIEW” on page 1198](#).

User-defined types

A *user-defined type* is a data type that is defined to the database using a CREATE statement.

There are two types of user-defined data type:

- Distinct type
- Array type

A *distinct type* is a user-defined type that shares its internal representation with a built-in data type (its source type). A distinct type is defined to use either strong typing or weak typing rules. A strongly typed distinct type is considered to be a separate and incompatible data type for most operations. A weakly typed distinct type is always considered to be the same as its source type. A distinct type is created with an SQL CREATE TYPE (Distinct) statement. A distinct type can be used to define a column of a table, or a parameter of a routine. For more information, see [“CREATE TYPE \(distinct\)” on page 1184](#) and [“User-defined types” on page 82](#).

An *array type* is a user-defined type that defines a one column array of a built-in data type. An array type is created with an SQL CREATE TYPE (Array) statement. An array type can be used as a parameter of a procedure or scalar function and as a variable in an SQL procedure or SQL scalar function. For more information, see [“CREATE TYPE \(array\)” on page 1179](#) and [“User-defined types” on page 82](#).

Aliases

An *alias* is an alternate name for a table or view.

An alias can be used to reference a table or view in cases where an existing table or view can be referenced.³ However, the option of referencing a table or view by an alias is not explicitly shown in the syntax diagrams or mentioned in the description of SQL statements. Like tables and views, an alias may be created, dropped, and have a comment or label associated with it. No authority is necessary to use an alias. Access to the tables and views that are referred to by the alias, however, still requires the appropriate authorization for the current statement.

An alias has a name and may have a different system name. The system name is the name used by the IBM i operating system. Either name is acceptable wherever an *alias-name* is specified in SQL statements.

An *alias* is created with the CREATE ALIAS statement. For more information about creating aliases, see [“CREATE ALIAS” on page 961](#).

Packages and access plans

A *package* is an object that contains control structures used to execute SQL statements.

Packages are produced during distributed program preparation. The control structures can be thought of as the bound or operational form of SQL statements.⁴ All control structures in a package are derived from the SQL statements embedded in a single source program.

In this book, the term *access plan* is used in general for packages, procedures, functions, triggers, and programs or service programs that contain control structures used to execute SQL statements. For example, the description of the DROP statement says that dropping an object also invalidates any access plans that reference the object (see [“DROP” on page 1280](#)). This means that any packages, procedures, functions, triggers, and programs or service programs containing control structures referencing the dropped object are invalidated.

An invalidated *access plan* will be implicitly rebuilt the next time its associated SQL statement is executed. For example, if an index is dropped that is used in an *access plan* for a SELECT INTO statement, the next time that SELECT INTO statement is executed, the access plan will be rebuilt.

A package can also be created by the Process Extended Dynamic SQL (QSQPRCED) API. Packages created by the Process Extended Dynamic SQL (QSQPRCED) API can only be used by the Process Extended Dynamic SQL (QSQPRCED) API. They cannot be used at an application server through DRDA protocols. For more information, see the [Database and File APIs](#) information in the **Programming** category of the IBM i Information Center.

The QSQPRCED API is used by IBM i Access for Windows to create packages for caching SQL statements executed via ODBC, JDBC, SQLJ, OLD DB, and .NET interfaces.

Routines

A *routine* is an executable SQL object.

There are two types of routines.

Functions

A *function* is a routine that can be invoked from within other SQL statements and returns a value or a table. For more information, see [“Functions” on page 148](#).

³ You cannot use an alias in all contexts. For example, an alias that refers to an individual member of a database file cannot be used in most SQL schema statements. For more information, see [“CREATE ALIAS” on page 961](#).

⁴ For non-distributed SQL programs, non-distributed service programs, SQL functions, and SQL procedures, the control structures used to execute SQL statements are stored in the associated space of the object.

Functions are classified as either SQL functions or external functions. SQL functions are written using SQL statements, which are also known collectively as SQL procedural language, SQL PL. External functions reference a host language program which may or may not contain SQL statements.

A *function* is created with the CREATE FUNCTION statement. For more information about creating functions, see [“CREATE FUNCTION” on page 965](#).

Procedures

A *procedure* (sometimes called a *stored procedure*) is a routine that can be called to perform operations that can include both host language statements and SQL statements.

Procedures are classified as either SQL procedures or external procedures. SQL procedures are written using SQL statements, which are also known collectively as SQL procedural language, SQL PL. External procedures reference a host language program which may or may not contain SQL statements.

A *procedure* is created with the CREATE PROCEDURE statement. For more information about creating procedures, see [“CREATE PROCEDURE” on page 1064](#).

Procedures in SQL provide the same benefits as procedures in a host language. That is, a common piece of code need only be written and maintained once and can be called from several programs. Both host languages and SQL can call procedures that exist on the local system. However, SQL can also call a procedure that exists on a remote system. In fact, the major benefit of procedures in SQL is that they can be used to enhance the performance characteristics of distributed applications.

Assume that several SQL statements must be executed at a remote system. There are two ways this can be done. Without procedures, when the first SQL statement is executed, the application requester will send a request to an application server to perform the operation. It then waits for a reply that indicates whether the statement is executed successfully or not and optionally returns results. When the second and each subsequent SQL statement is executed, the application requester will send another request and wait for another reply.

If the same SQL statements are stored in a procedure at an application server, a CALL statement can be executed that references the remote procedure. When the CALL statement is executed, the application requester will send a single request to the current server to call the procedure. It will then wait for a single reply that indicates whether the procedure executed successfully or not and optionally returns results.

The following two figures illustrate the way stored procedures can be used in a distributed application to eliminate some of the remote requests. [Figure 1 on page 13](#) shows a program making many remote requests.

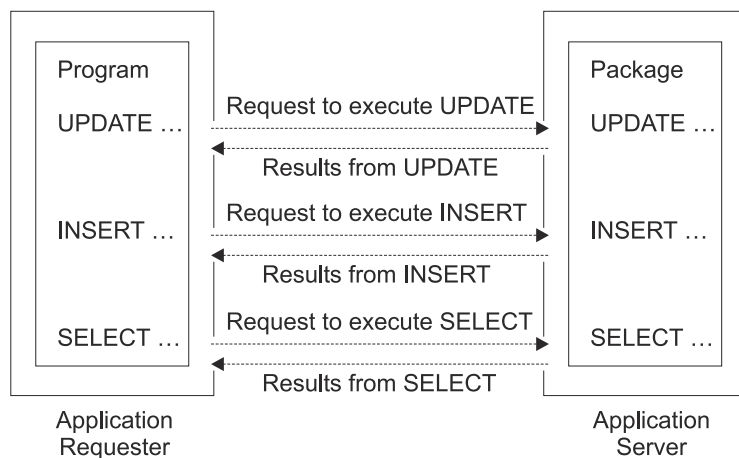

Figure 1. Application Without Remote Procedure

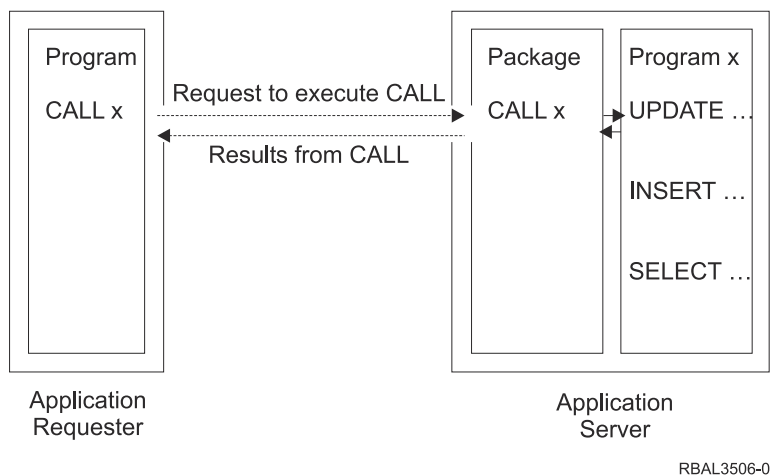

Figure 2. Application With Remote Procedure

Sequences

A sequence is a stored object that simply generates a sequence of numbers in a monotonically ascending (or descending) order. Sequences provide a way to have the database manager automatically generate unique integer and decimal primary keys, and to coordinate keys across multiple rows and tables.

A sequence can be used to exploit parallelization, instead of programmatically generating unique numbers by locking the most recently used value and then incrementing it.

Sequences are ideally suited to the task of generating unique key values. One sequence can be used for many tables, or a separate sequence can be created for each table requiring generated keys. A sequence has the following properties:

- Can have guaranteed, unique values, assuming that the sequence is not reset and does not allow the values to cycle.
- Can have increasing or decreasing values within a defined range.
- Can have an increment value other than 1 between consecutive values (the default is 1).
- Is recoverable.

Values for a given sequence are automatically generated by the database manager. Use of a sequence in the database avoids the performance bottleneck that results when an application implements sequences outside the database. The counter for the sequence is incremented (or decremented) independently from the transaction.

In some cases, gaps can be introduced in a sequence. A gap can occur when a given transaction increments a sequence two times. The transaction may see a gap in the two numbers that are generated because there may be other transactions concurrently incrementing the same sequence. A user may not realize that other users are drawing from the same sequence. Furthermore, it is possible that a given sequence can appear to have generated gaps in the numbers, because a transaction that may have generated a sequence number may have rolled back. Updating a sequence is not part of a transaction's unit of recovery.

A sequence is created with a CREATE SEQUENCE statement. A sequence can be referenced using a *sequence-reference*. A sequence reference can appear most places that an expression can appear. A sequence reference can specify whether the value to be returned is a newly generated value, or the previously generated value. For more information, see [“Sequence reference” on page 194](#) and [“CREATE SEQUENCE” on page 1098](#).

Although there are similarities, a sequence is different than an identity column. A sequence is an object, whereas an identity column is a part of a table. A sequence can be used with multiple tables, but an identity column is part of a single table.

Authorization, privileges and object ownership

Users (identified by an authorization ID) can successfully execute SQL statements only if they have the authority to perform the specified function. To create a table, a user must be authorized to create tables; to alter a table, a user must be authorized to alter the table; and so forth.

The two forms of authorization are administrative authority and privileges.

Administrative authority

The holder of an administrative authority is charged with the task of managing the relational database and is responsible for the safety and integrity of the data.

database administrator authority

The *database administrator authority* provides a user with the ability to create and manage all objects in a relational database. Those with *database administrator authority* implicitly have all privileges on all objects in the relational database.

The security officer and all users with *ALLOBJ authority have *database administrator authority*.

security administrator authority

The *security administrator authority* provides a user the ability to manage security in a relational database. The *security administrator authority* possesses the ability to grant and revoke all relational database privileges and authorities and transfer ownership of objects. Those with *security administrator authority* also manage security policies by enforcing row and column access control for tables that contain sensitive data.

The *security administrator authority* has no inherent privilege to access data stored in tables.

Users with the function usage QIBM_DB_SECADM have *security administrator authority*.

Privileges

Privileges are those activities that a user is allowed to perform. Authorized users can create objects, have access to objects they own, and can pass on *privileges* on their own objects to other users by using the GRANT statement.

Privileges may be granted to specific users or to PUBLIC. PUBLIC specifies that a privilege is granted to a set of users (authorization IDs). The set consists of those users (including future users) that do not have privately granted privileges on the table or view. This affects private grants. For example, if SELECT has been granted to PUBLIC, and UPDATE is then granted to HERNANDZ, this private grant prevents HERNANDZ from having the SELECT privilege.

The REVOKE statement can be used to REVOKE previously granted *privileges*. A revoke of a privilege from an authorization ID revokes the privilege granted by all authorization IDs. Revoking a privilege from an authorization ID will not revoke that same privilege from any other authorization IDs that were granted the privilege by that authorization ID.

Row permissions and column masks

A *row permission* expresses an access control rule for a row of a specific table. A row permission is in the form of a search condition that describes to which rows users have access. Row permissions are applied after table privileges (like SELECT or INSERT) are checked.

A *column mask* expresses an access control rule for a specific column in a table. A column mask is in the form of a CASE expression that describes to which column values users have access. Column masks are applied after table privileges (like SELECT or INSERT) are checked.

Row permissions and column masks can be created, changed, and dropped only by those with Database Security Administrator authority by using the CREATE MASK, CREATE PERMISSION, ALTER MASK, ALTER PERMISSION, and DROP statements. The definition of a permission or a mask can reference other objects. Those with Database Security Administrator authority do not need additional privileges to reference those objects, such as SELECT privilege to retrieve from a table or EXECUTE privilege to invoke

a user-defined function, in the definition of the row permission or column mask. Multiple row permissions and column masks can be created for a table. Only one column mask can be created for each column in a table. A row permission or a column mask can be created before row or column access control is enforced for a table. The definition of the row permission and the column mask is stored in the Db2 catalog. However, the permission and the mask do not take effect until the ALTER TABLE statement with the ACTIVATE ROW ACCESS CONTROL clause is used to enforce row access control or the ACTIVATE COLUMN ACCESS CONTROL clause is used to enforce column access control on the table.

When an ALTER TABLE statement is used to explicitly activate row access control for a table, a default row permission is implicitly created for the table which prevents all access to the table. After row access controls have been activated for a table, if the table is referenced explicitly in a data change statement and if multiple row permissions are defined for the table, a row access control search condition is derived by using the logical OR operator with the search condition of each defined row permission.

When an ALTER TABLE statement is used to explicitly activate column access control for a table, access to the table is not restricted. However, if the table is referenced in an SQL statement, all column masks that have been created for the table are applied to mask the column values that are referenced in the output of the queries or to determine the column values that are used in the data change statements.

The authorization ID for the SQL statement that references a table with row permissions or column masks does not need authority to reference objects that are specified in the definitions of those row permissions or column masks.

Ownership

When an object is created, the authorization ID of the statement must have the privilege to create objects in the implicitly or explicitly specified schema. The authorization ID of a statement has the privilege to create objects in the schema if:

- it is the owner of the schema, or
- it has the CREATEIN privilege on the schema.

When an object is created, one authorization ID is assigned *ownership* of the object. Ownership gives the user complete control over the object, including the privilege to drop the object. The privileges on the object can be granted by the owner, and can be revoked from the owner. In this case, the owner may temporarily be unable to perform an operation that requires that privilege. Because he is the owner, however, he is always allowed to grant the privilege back to himself.

When an object is created:

- If SQL names were specified, the *owner* of the object is the user profile with the same name as the schema into which the object is created, if a user profile with that name exists. Otherwise, the *owner* of the object is the user profile or group user profile of the thread executing the statement.
- If system names were specified, the *owner* of the object is the user profile or group user profile of the thread executing the statement.

Authority granted to *PUBLIC on SQL objects depends on the naming convention that is used at the time of object creation. If *SYS naming convention is used, *PUBLIC acquires the create authority (CRTAUT) of the library into which the object was created. If *SQL naming convention is used, *PUBLIC acquires *EXCLUDE authority.

In the Authorization sections of this book, it is assumed that the owner of an object has not had any privileges revoked from that object since it was initially created. If the object is a view, it is also assumed that the owner of the view has not had the system authority *READ revoked from any of the tables or views that this view is directly or indirectly dependent on. The owner has system authority *READ for all tables and views referenced in the view definition, and if a view is referenced, all tables and views referenced in its definition, and so forth. For more information about authority and privileges, see [Security Reference](#).

Catalog

The database manager maintains a set of tables containing information about objects in the database. These tables and views are collectively known as the *catalog*. The *catalog tables* contain information about objects such as tables, views, indexes, packages, and constraints.

Tables and views in the catalog are similar to any other database tables and views. Any user that has the SELECT privilege on a catalog table or view can read the data in the catalog table or view. A user cannot directly modify a catalog table or view, however. The database manager ensures that the catalog contains accurate descriptions of the objects in the database at all times.

The database manager provides a set of views that provide more consistency with the catalog views of other IBM SQL products and another set of catalog views that provide compatibility with the catalog views of the ANSI and ISO standard (called *Information Schema* in the standard).

If a schema is created using the CREATE SCHEMA statement, the schema will also contain a set of views that only contain information about objects in the schema.

For more information about catalog tables and views, see [Appendix F, “Db2 for i catalog views,”](#) on page 1701.

Application processes, concurrency, and recovery

All SQL programs execute as part of an *application process*. In the IBM i operating system, an application process is called a job. In the case of ODBC, JDBC, OLE DB, .NET, and DRDA, the application process ends when the connection ends even though the job they are using does not end and may be reused.

An application process is made up of one or more activation groups. Each activation group involves the execution of one or more programs. Programs run under a non-default activation group or the default activation group. All programs except those created by ILE compilers run under the default activation group. For example, LANGUAGE JAVA external functions run under the default activation group.

For more information about activation groups, see the book [ILE Concepts](#) .

An application process that uses commitment control can run with one or more commitment definitions. A commitment definition provides a means to scope commitment control at an activation group level or at a job level. At any given time, an activation group that uses commitment control is associated with only one of the commitment definitions.

A commitment definition can be explicitly started through the Start Commitment Control (STRCMTCTL) command. If not already started, a commitment definition is implicitly started when the first SQL statement is executed under an isolation level different than COMMIT(*NONE). More than one activation group can share a job commitment definition.

[Figure 3 on page 18](#) shows the relationship of an application process, the activation groups in that application process, and the commitment definitions. Activation groups A and B run with commitment control scoped to the activation group. These activation groups have their own commitment definitions. Activation group C does not run with any commitment control and does not have a commitment definition.

Application Process Without Job-Level Commitment Definition

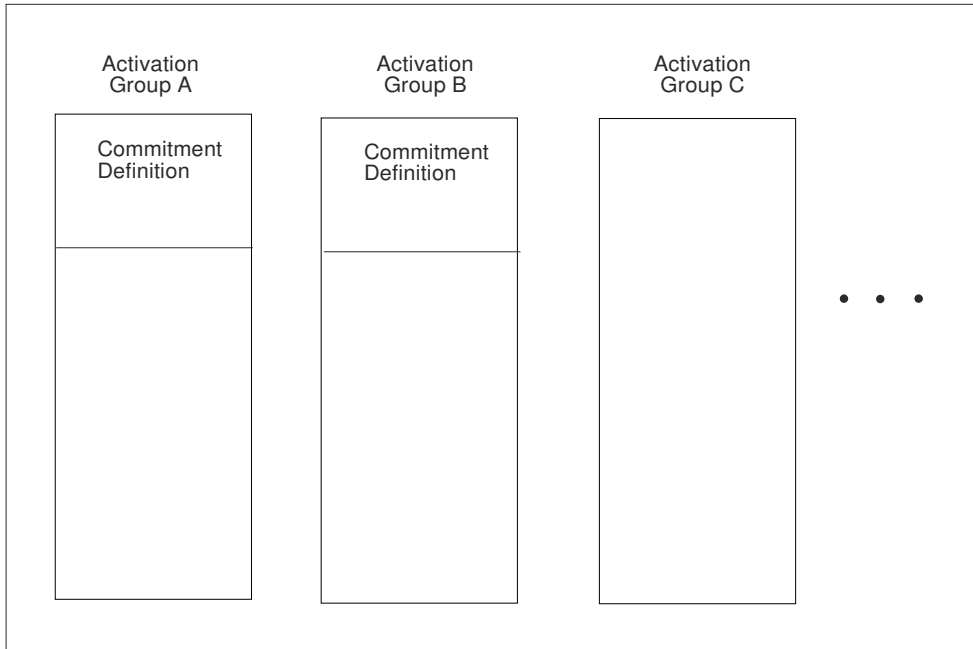

RV3F004-0

Figure 3. Activation Groups without Job Commitment Definition

Figure 4 on page 19 shows an application process, the activation groups in that application process, and the commitment definitions. Some of the activation groups are running with the job commitment definition. Activation groups A and B are running under the job commitment definition. Any commit or rollback operation in activation group A or B affects both because the commitment control is scoped to the same commitment definition. Activation group C in this example has a separate commitment definition. Commit and rollback operations performed in this activation group only affect operations within C.

Application Process With Job-Level Commitment Control

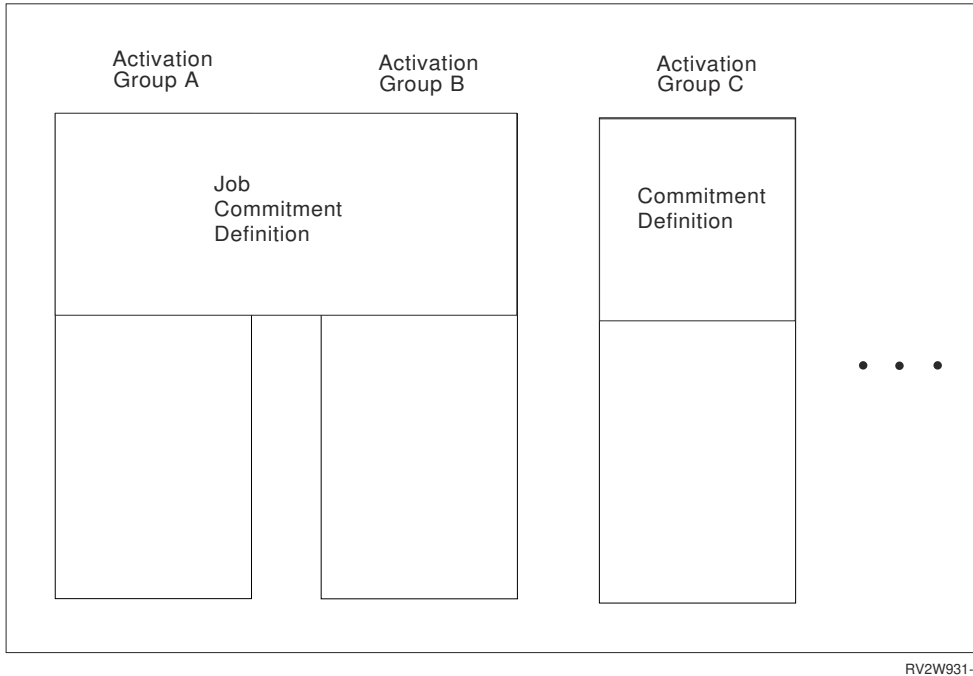

Figure 4. Activation Groups with Job Commitment Definition

For more information about commitment definitions, see the [Commitment control](#) topic.

Locking, commit, and rollback

Application processes and activation groups that use different commitment definitions can request access to the same data at the same time. *Locking* is used to maintain data integrity under such conditions. Locking prevents such things as two application processes updating the same row of data simultaneously.

The database manager acquires locks to keep the uncommitted changes of one activation group undetected by activation groups that use a different commitment definition. Object locks and other resources are allocated to an activation group. Row locks are allocated to a commitment definition.

When an activation group other than the default activation group ends *normally*, the database manager releases all locks obtained by the activation group. A user can also explicitly request that most locks be released sooner. This operation is called *commit*. Object locks associated with cursors that remain open after commit are not released.

The recovery functions of the database manager provide a means of backing out of uncommitted changes made in a commitment definition. The database manager may implicitly back out uncommitted changes under the following situations:

- When the application process ends, all changes performed under the commitment definition associated with the default activation group are backed out. When an activation group other than the default activation group ends *abnormally*, all changes performed under the commitment definition associated with that activation group are backed out.
- When using Distributed Unit of Work and a failure occurs while attempting to commit changes on a remote system, all changes performed under the commitment definition associated with remote connection are backed out.
- When using Distributed Unit of Work and a request to back out is received from a remote system because of a failure at that site, all changes performed under the commitment definition associated with remote connection are backed out.

A user can also explicitly request that their database changes be backed out. This operation is called *rollback*.

Locks acquired by the database manager on behalf of an activation group are held until the unit of work is ended. A lock explicitly acquired by a LOCK TABLE statement can be held past the end of a unit of work if COMMIT HOLD or ROLLBACK HOLD is used to end the unit of work.

A cursor can implicitly lock the row at which the cursor is positioned. This lock prevents:

- Other cursors associated with a different commitment definition from locking the same row.
- A DELETE or UPDATE statement associated with a different commitment definition from locking the same row.

Unit of work

A *unit of work* (also known as a *transaction*, *logical unit of work*, or *unit of recovery*) is a recoverable sequence of operations. Each commitment definition involves the execution of one or more units of work. At any given time, a commitment definition has a single unit of work.

A unit of work is started either when the commitment definition is started, or when the previous unit of work is ended by a commit or rollback operation. A unit of work is ended by a commit operation, a rollback operation, or the ending of the activation group. A commit or rollback operation affects only the database changes made within the unit of work that the commit or rollback ends. While changes remain uncommitted, other activation groups using different commitment definitions running under isolation levels COMMIT(*CS), COMMIT(*RS), and COMMIT(*RR) cannot perceive the changes. The changes can be backed out until they are committed. Once changes are committed, other activation groups running in different commitment definitions can access them, and the changes can no longer be backed out.

The start and end of a unit of work defines points of consistency within an activation group. For example, a banking transaction might involve the transfer of funds from one account to another. Such a transaction would require that these funds be subtracted from the first account, and added to the second. Following the subtraction step, the data is inconsistent. Only after the funds are added to the second account is consistency established again. When both steps are complete, the commit operation can be used to end the unit of work. After the commit operation, the changes are available to activation groups that use different commitment definitions.

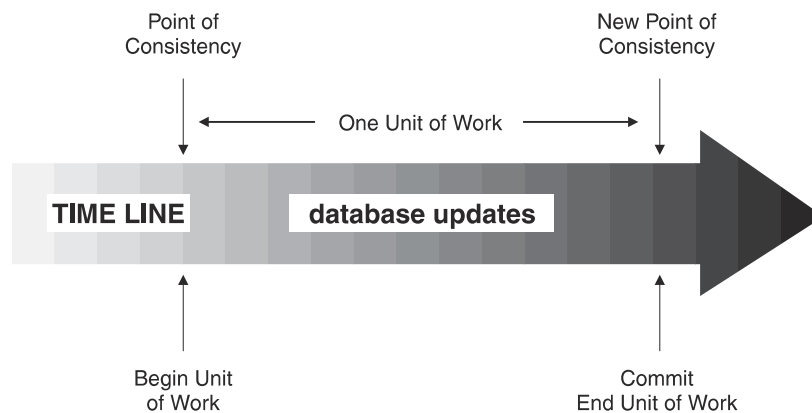

RV3F181-0

Figure 5. Unit of Work with a Commit Statement

Rolling back work

The database manager can back out all changes made in a unit of work or only selected changes. Only backing out all changes results in a point of consistency.

Rolling back all changes

The SQL ROLLBACK statement without the TO SAVEPOINT clause causes a full rollback operation. If such a rollback operation is successfully executed, database manager backs out uncommitted changes to restore the data consistency that it assumes existed when the unit of work was initiated. That is, the database manager undoes the work, as shown in the diagram below:

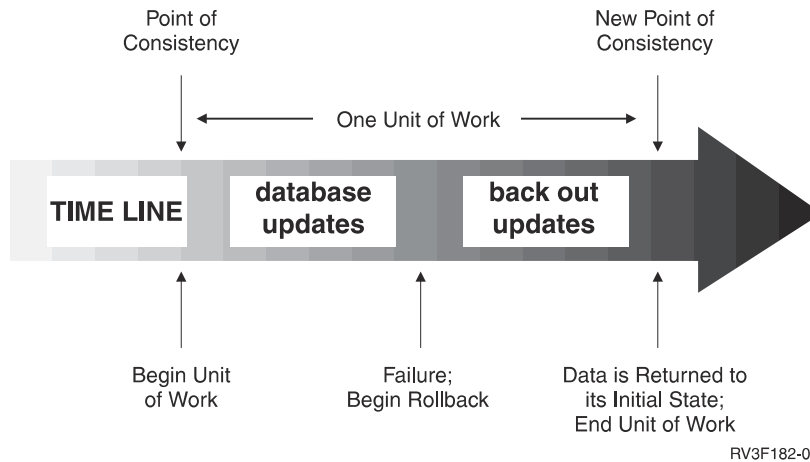

Figure 6. Unit of Work with a Rollback Statement

Rolling back selected changes using savepoints

A *savepoint* represents the state of data at some particular time during a unit of work. An application process can set savepoints within a unit of work, and then as logic dictates, roll back only the changes that were made after a savepoint was set. For example, part of a reservation transaction might involve booking an airline flight and then a hotel room. If a flight gets reserved but a hotel room cannot be reserved, the application process might want to undo the flight reservation without undoing any database changes made in the transaction prior to making the flight reservation. SQL programs can use the SQL SAVEPOINT statement to set savepoints, the SQL ROLLBACK statement with the TO SAVEPOINT clause to undo changes to a specific savepoint or the last savepoint that was set, and the RELEASE SAVEPOINT statement to delete a savepoint.

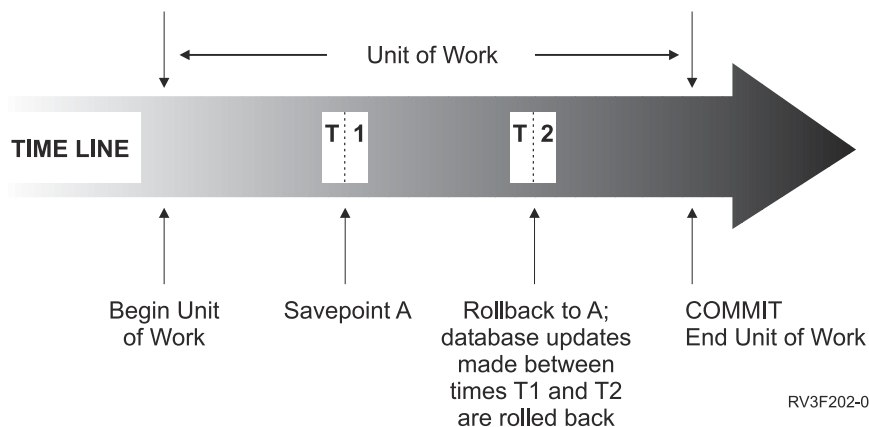

Figure 7. Unit of Work with a Rollback Statement and a Savepoint Statement

Threads

In the IBM i operating system, an application process can also consist of one or more threads. By default, a thread shares the same commitment definitions and locks as the other threads in the job. Thus, each thread can operate on the same unit of work so that when one thread commits or rolls back, it can commit or rollback all changes performed by all threads. This type of processing is useful if multiple threads are cooperating to perform a single task in parallel.

In other cases, it is useful for a thread to perform changes independent from other threads in the job. In this case, the thread would not want to share commitment definitions or lock with the other threads. Furthermore, a job can use SQL server mode in order to take more fine grain control of multiple database connections and transaction information. A typical multi-threaded job may require this control. There are several ways to accomplish this type of processing:

- Make sure the programs running in the thread use a separate activation group (be careful not to use ACTGRP(*NEW)).
- Make sure that the job is running in SQL server mode before issuing the first SQL statement. SQL server mode can be activated for a job by using one of the following mechanisms before data access occurs in the application:
 - Use the ODBC API, `SQLSetEnvAttr()` and set the `SQL_ATTR_SERVER_MODE` attribute to `SQL_TRUE` before doing any data access.
 - Use the Change Job API, `QWTCHGJB()`, and set the 'Server mode for Structured Query Language' key before doing any data access.
 - Use JAVA to access the database via JDBC. JDBC automatically uses server mode to preserve required semantics of JDBC.

When SQL server mode is established, all SQL statements are passed to an independent server job that will handle the requests. Server mode behavior for SQL behavior includes:

- For embedded SQL, each thread in a job implicitly gets one and only one connection to the database (and thus its own committable transaction).
- For ODBC/CLI, JDBC, OLE DB, and .NET, each connection represents a stand-alone connection to the database and can be committed and used as a separate entity.

For more information, see [SQL Call Level Interface \(ODBC\)](#).

The following SQL support is not threadsafe:

- Remote access through DRDA
- ALTER FUNCTION
- ALTER PROCEDURE
- ALTER SEQUENCE
- ALTER TABLE
- COMMENT
- CREATE ALIAS
- CREATE FUNCTION
- CREATE INDEX
- CREATE PROCEDURE
- CREATE SCHEMA
- CREATE SEQUENCE
- CREATE TABLE
- CREATE TRIGGER
- CREATE TYPE
- CREATE VARIABLE

- CREATE VIEW
- DECLARE GLOBAL TEMPORARY TABLE
- DROP
- GRANT
- LABEL
- REFRESH TABLE
- RENAME
- REVOKE

For more information, see [Multithreaded applications](#) in the Programming topic of the IBM i Information Center.

Isolation level

The *isolation level* used during the execution of SQL statements determines the degree to which the activation group is isolated from concurrently executing activation groups.

Thus, when activation group P executes an SQL statement, the isolation level determines:

- The degree to which rows retrieved by P and database changes made by P are available to other concurrently executing activation groups.
- The degree to which database changes made by concurrently executing activation groups can affect P.

The isolation level can be explicitly specified on a DELETE, INSERT, SELECT INTO, UPDATE, or select-statement. If the isolation level is not explicitly specified, the isolation level used when the SQL statement is executed is the *default isolation level*.

Db2 for i provides several ways to specify the *default isolation level*:

<i>Table 2. Default Isolation Level Interfaces</i>	
SQL Interface	Specification
Embedded SQL	<p>COMMIT parameter on the Create SQL Program (CRTSQLxxx) commands. The SET OPTION statement can also be used to set the COMMIT values.</p> <p>(For more information about CRTSQLxxx commands, see Embedded SQL Programming.)</p>
SQL functions and procedures	<p>Static SQL statements in SQL functions and procedures use the isolation level that was in effect at the time the SQL function or procedure was created. The SET OPTION statement (COMMIT) can be used to set the isolation level.</p>
Run SQL Statements	<p>COMMIT parameter on the Run SQL Statements (RUNSQLSTM) command.</p> <p>(For more information about the RUNSQLSTM command, see SQL Programming.)</p>

Table 2. Default Isolation Level Interfaces (continued)

SQL Interface	Specification
SET TRANSACTION SQL statement	<p>Overrides the default isolation level within a unit of work. When the unit of work ends, the isolation level returns to the value it had at the beginning of the unit of work. This statement overrides any other specification of isolation level for static and dynamic SQL statements in the unit of work.</p> <p>(For more information about the SET TRANSACTION statement, see “SET TRANSACTION” on page 1536.)</p>
<i>isolation-clause</i>	<p>The <i>isolation-clause</i> on the SELECT, SELECT INTO, INSERT, UPDATE, DELETE, and DECLARE CURSOR statements overrides the default isolation level for a specific statement or cursor. The isolation level is in effect only for the execution of the statement containing the <i>isolation-clause</i> and has no effect on any pending changes in the current unit of work.</p> <p>(For more information about the <i>isolation-clause</i>, see “isolation-clause” on page 787.)</p>
Call Level Interface (CLI) on the server	<p>SQL_ATTR_COMMIT or SQL_TXN_ISOLATION environment variable or connection options</p> <p>(For more information about CLI, see SQL Call Level Interfaces (ODBC).)</p>
JDBC or SQLJ on the server using IBM IBM Developer Kit for Java	<p>transaction isolation property object</p> <p>(For more information about JDBC and SQLJ, see IBM Developer Kit for Java.)</p>
ODBC on a client using the IBM i Access Family ODBC Driver	<p>Commit Mode in ODBC Setup</p> <p>(For more information about ODBC, see IBM i Access.)</p>
JDBC on a client using the IBM Toolbox for Java	<p>Isolation Level in JDBC Setup</p> <p>(For more information about JDBC, see IBM i Access.)</p> <p>(For more information about the IBM Toolbox for Java, see IBM Toolbox for Java.)</p>
OLE DB on a client using the IBM i Access Family OLE DB Provider	<p>IsolationLevel Connection Object Property</p> <p>(For more information about OLE DB, see IBM i Access.)</p>
ADO .NET on a client using the IBM i Access Family ADO .NET Provider	<p>IsolationLevel in Connection Object Properties</p> <p>(For more information about ADO .NET, see IBM i Access.)</p>

These isolation levels are supported by automatically locking the appropriate data. Depending on the type of lock, this limits or prevents access to the data by concurrent activation groups that use different commitment definitions. Each database manager supports at least two types of locks:

Share

Limits concurrent activation groups that use different commitment definitions to read-only operations on the data.

Exclusive

Prevents concurrent activation groups using different commitment definitions from updating or deleting the data. Prevents concurrent activation groups using different commitment definitions that are running COMMIT(*RS), COMMIT(*CS), or COMMIT(*RR) from reading the data. Concurrent activation groups using different commitment definitions that are running COMMIT(*UR) or COMMIT(*NC) are allowed to read the data.

The following descriptions of isolation levels refer to locking data in row units. Individual implementations can lock data in larger physical units than base table rows. However, logically, locking occurs at the base-table row level across all products. Similarly, a database manager can escalate a lock to a higher level. An activation group is guaranteed at least the minimum requested lock level.

For a detailed description of record lock durations, see the discussion and table in the [Commitment control](#) topic of the [SQL Programming](#) topic collection.

Db2 for i supports five isolation levels. For all isolation levels except No Commit, the database manager places exclusive locks on every row that is inserted, updated, or deleted. This ensures that any row changed during a unit of work is not changed by any other activation group that uses a different commitment definition until the unit of work is complete.

Repeatable read

The Repeatable Read (RR) isolation level ensures:

- Any row read during a unit of work is not changed by other activation groups that use different commitment definitions until the unit of work is complete.⁵
- Any row changed (or a row that is currently locked with an UPDATE row lock) by another activation group using a different commitment definition cannot be read until it is committed.

In addition to any exclusive locks, an activation group running at level RR acquires at least share locks on all the rows it reads. Furthermore, the locking is performed so that the activation group is completely isolated from the effects of concurrent activation groups that use different commitment definitions.

In the SQL 2003 Core standard, Repeatable Read is called Serializable.

Db2 for i supports repeatable read through COMMIT(*RR). Repeatable read isolation level is supported by locking the tables containing any rows that are read or updated.

Read stability

Like level RR, level Read Stability (RS) ensures that:

- Any row read during a unit of work is not changed by other activation groups that use different commitment definitions until the unit of work is complete.⁶
- Any row changed (or a row that is currently locked with an UPDATE row lock) by another activation group using a different commitment definition cannot be read until it is committed.

Unlike RR, RS does not completely isolate the activation group from the effects of concurrent activation groups that use a different commitment definition. At level RS, activation groups that issue the same query more than once might see additional rows. These additional rows are called *phantom rows*.

For example, a phantom row can occur in the following situation:

1. Activation group P1 reads the set of rows *n* that satisfy some search condition.

⁵ For **WITH HOLD** cursors, these rules apply to when the rows were actually read. For read-only **WITH HOLD** cursors, the rows may have actually been read in a prior unit of work.

⁶ For **WITH HOLD** cursors, these rules apply to when the rows were actually read. For read-only **WITH HOLD** cursors, the rows may have actually been read in a prior unit of work.

2. Activation group P2 then INSERTs one or more rows that satisfy the search condition and COMMITs those INSERTs.
3. P1 reads the set of rows again with the same search condition and obtains both the original rows and the rows inserted by P2.

In addition to any exclusive locks, an activation group running at level RS acquires at least share locks on all the rows it reads.

In the SQL 2003 Core standard, Read Stability is called Repeatable Read.

Db2 for i supports read stability through COMMIT(*ALL) or COMMIT(*RS).

Cursor stability

Like levels RR and RS, level Cursor Stability (CS) ensures that any row that was changed (or a row that is currently locked with an UPDATE row lock) by another activation group using a different commitment definition cannot be read until it is committed. Unlike RR and RS, level CS only ensures that the current row of every updatable cursor is not changed by other activation groups using different commitment definitions. Thus, the rows that were read during a unit of work can be changed by other activation groups that use a different commitment definition. In addition to any exclusive locks, an activation group running at level CS may acquire a share lock for the current row of every cursor.

In the SQL 2003 Core standard, Cursor Stability is called Read Committed.

Db2 for i supports cursor stability through COMMIT(*CS).

Uncommitted read

For a SELECT INTO, a FETCH with a read-only cursor, subquery, or fullselect used in an INSERT statement, level Uncommitted Read (UR) allows:

- Any row read during the unit of work to be changed by other activation groups that run under a different commitment definition.
- Any row changed (or a row that is currently locked with an UPDATE row lock) by another activation group running under a different commitment definition to be read even if the change has not been committed.

For other operations, the rules of level CS apply.

In the SQL 2003 Core standard, Uncommitted Read is called Read Uncommitted.

Db2 for i supports uncommitted read through COMMIT(*CHG) or COMMIT(*UR).

No commit

For all operations, the rules of level UR apply to No Commit (NC) except:

- Commit and rollback operations have no effect on SQL statements. Cursors are not closed, and LOCK TABLE locks are not released. However, connections in the release-pending state are ended.
- Any changes are effectively committed at the end of each successful change operation and can be immediately accessed or changed by other application groups using different commitment definitions.

Db2 for i supports No Commit through COMMIT(*NONE) or COMMIT(*NC).

Note: *(For distributed applications.)* When a requested isolation level is not supported by an application server, the isolation level is escalated to the next highest supported isolation level. For example, if RS is not supported by an application server, the RR isolation level is used.

Comparison of isolation levels

The following table summarizes information about isolation levels.

	NC	UR	CS	RS	RR
Can the application see uncommitted changes made by other application processes?	Yes	Yes	No ²	No ²	No
Can the application update uncommitted changes made by other application processes?	No	No	No	No	No
Can the re-execution of a statement be affected by other application processes? <i>See phenomenon P3 (phantom) below.</i>	Yes	Yes	Yes	Yes	No
Can “updated” rows be updated by other application processes?	Yes	No	No	No	No
Can “updated” rows be read by other application processes that are running at an isolation level other than UR and NC?	Yes	No	No	No	No
Can “updated” rows be read by other application processes that are running at the UR or NC isolation level?	Yes	Yes	Yes	Yes	Yes
Can “accessed” rows be updated by other application processes? For RS, “accessed rows” typically means rows selected. For RR, see the product-specific documentation. <i>See phenomenon P2 (nonrepeatable read) below.</i>	Yes	Yes	Yes	No	No
Can “accessed” rows be read by other application processes?	Yes	Yes	Yes	Yes	Yes
Can “current” row be updated or deleted by other application processes? <i>See phenomenon P1 (dirty-read) below.</i>	See Note 1	See Note 1	See Note 1	No	No

Note 1: This depends on whether the cursor that is positioned on the “current” row is updatable:

- If the cursor is updatable, the current row cannot be updated or deleted by other application processes
- If the cursor is not updatable,
 - For UR or NC, the current row can be updated or deleted by other application processes.
 - For CS, the current row may be updatable in some circumstances.

Note 2: The USE CURRENTLY COMMITTED clause should be used. In addition, when a query is implemented using a table scan, use the QAQQINI option CONCURRENT_ACCESS_BEHAVIOR with a value of *STRICTSCAN.

Examples of Phenomena:

P1

Dirty Read. Unit of work UW1 modifies a row. Unit of work UW2 reads that row before UW1 performs a COMMIT. UW1 then performs a ROLLBACK. UW2 has read a nonexistent row.

P2

Nonrepeatable Read. Unit of work UW1 reads a row. Unit of work UW2 modifies that row and performs a COMMIT. UW1 then re-reads the row and obtains the modified data value.

P3

Phantom. Unit of work UW1 reads the set of n rows that satisfies some search condition. Unit of work UW2 then INSERTs one or more rows that satisfies the search condition. UW1 then repeats the initial read with the same search condition and obtains the original rows plus the inserted rows.

Storage Structures

The IBM i product is an object-based system. All database objects in Db2 for i (tables and indexes for example) are objects in the IBM i operating system. The single-level storage manager manages all storage of objects of the database, so database specific storage structures (for example, table spaces) are unnecessary.

A distributed table allows data to be spread across different database partitions. The partitions included are determined by the nodegroup specified when the table is created or altered. A nodegroup is a group of one or more IBM i products. A partitioning map is associated with each nodegroup. The partitioning map is used by the database manager to determine which system from the nodegroup will store a given row of data. For more information about nodegroups and data partitioning see the [DB2 Multisystem](#) book.

A table can also include columns that register links to data that are stored in external files. The mechanism for this is the DataLink data type. A DataLink value which is recorded in a regular table points to a file that is stored in an external file server.

The Db2 File Manager on a file server works in conjunction with Db2 to provide the following optional functionality:

- Referential integrity to ensure that files currently linked to Db2 are not deleted or renamed.
- Security to ensure that only those with suitable SQL privileges on the DataLink column can read the files linked to that column.

The DataLinker comprises the following facilities:

DataLinks File Manager

Registers all the files in a particular file server that are linked to Db2.

DataLinks Filter

Filters file system commands to ensure that registered files are not deleted or renamed. Optionally, filters commands to ensure that proper access authority exists.

Character conversion

A *string* is a sequence of bytes that may represent characters. Within a string, all the characters are represented by a common coding representation. In some cases, it might be necessary to convert these characters to a different coding representation. The process of conversion is known as *character conversion*.

Character conversion can occur when an SQL statement is executed remotely.⁷ Consider, for example, these two cases:

⁷ Character conversion, when required, is automatic and is transparent to the application when it is successful. A knowledge of conversion is, therefore, unnecessary when all the strings involved in a

- The values of variables sent from the application requester to the current server.
- The values of result columns sent from the current server to the application requester.

In either case, the string could have a different representation at the sending and receiving systems. Conversion can also occur during string operations on the same system.

Note that SQL statements are strings and are therefore subject to character conversion.

The following list defines some of the terms used when discussing character conversion.

character set

A defined set of characters. For example, the following character set appears in several code pages:

- 26 non-accented letters A through Z
- 26 non-accented letters a through z
- digits 0 through 9
- . , ; ? () ' " / - _ & + = < >

code page

A set of assignments of characters to code points. In EBCDIC, for example, "A" is assigned code point X'C1' and "B" is assigned code point X'C2'. Within a code page, each code point has only one specific meaning.

code point

A unique bit pattern that represents a character within a code page.

coded character set

A set of unambiguous rules that establish a character set and the one-to-one relationships between the characters of the set and their coded representations.

encoding scheme

A set of rules used to represent character data. For example:

- Single-byte EBCDIC
- Single-byte ASCII
- Double-byte EBCDIC
- Mixed single- and double-byte ASCII⁸
- Unicode (UTF-8, UCS-2, and UTF-16 universal coded character sets).

substitution character

A unique character that is substituted during character conversion for any characters in the source coding representation that do not have a match in the target coding representation.

Unicode

A universal encoding scheme for written characters and text that enables the exchange of data internationally. It provides a character set standard that can be used all over the world. It uses a 16-bit encoding form that provides code points for more than 65,000 characters and an extension called UTF-16 that allows for encoding as many as a million more characters. It provides the ability to encode all characters used for the written languages of the world and treats alphabetic characters, ideographic characters, and symbols equivalently because it specifies a numeric value and a name for each of its characters. It includes punctuation marks, mathematical symbols, technical symbols, geometric shapes, and dingbats. Three encoding forms are supported:

- UTF-8: Unicode Transformation Format, a 8-bit encoding form designed for ease of use with existing ASCII-based systems. UTF-8 data is stored in character data types. The CCSID value for data in UTF-8 format is 1208.

statement's execution are represented in the same way. Thus, for many readers, character conversion may be irrelevant.

⁸ UTF-8 unicode data is also mixed data. In this book, however, mixed data refer to mixed single- and double-byte data.

A UTF-8 character can be 1,2,3 or 4 bytes in length. A UTF-8 data string can contain any combination of SBCS and DBCS data, including surrogates and combining characters.

- UCS-2: Universal Character Set coded in 2 octets, which means that characters are represented in 16-bits per character. UCS-2 data is stored in graphic data types. The CCSID value for data in UCS-2 format is 13488.

UCS-2 is a subset of UTF-16. UCS-2 is identical to UTF-16 except that UTF-16 also supports combining characters and surrogates. Since UCS-2 is a simpler form of UTF-16, UCS-2 data will typically perform better than UTF-16.⁹

- UTF-16: Unicode Transformation Format, a 16-bit encoding form designed to provide code values for over a million characters. UTF-16 data is stored in graphic data types. The CCSID value for data in UTF-16 format is 1200.

Both UTF-8 and UTF-16 data can contain *combining characters*. Combining character support allows a resulting character to be comprised of more than one character. After the first character, hundreds of different non-spacing accent characters (umlauts, accents, etc.) can follow in the data string. The resulting character may already be defined in the character set. In this case, there are multiple representations for the same character. For example, in UTF-16, an *é* can be represented either by X'00E9' (the normalized representation) or X'00650301' (the non-normalized combining character representation).

Since multiple representations of the same character will not compare equal, it is usually not a good idea to store both forms of the characters in the database. *Normalization* is a process that replaces the string of combining characters with equivalent characters that do not include combining characters. After normalization has occurred, only one representation of any specific character will exist in the data. For example, in UTF-16, any instances of X'00650301' (the non-normalized combining character representation of *é*) will be converted to X'00E9' (the normalized representation of *é*).¹⁰

In order to properly handle UTF-8 in predicates, normalization may occur.

Both UTF-8 and UTF-16 can contain 4 byte characters called *surrogates*. Surrogates are 4 byte sequences that can address one million more characters than would be available in a 2 byte character set.

⁹ UCS-2 can contain surrogates and combining characters, however, they are not recognized as such. Each 16-bits is considered to be a character.

¹⁰ Since normalization can significantly affect performance (from 2.5 to 25 percent extra CPU), the default in column definitions is NOT NORMALIZED.

Character sets and code pages

The following example shows how a typical character set might map to different code points in two different code pages.

Code-Page: pp1 (ASCII)

	0	1	2	3	4	5		E	F
0				0	@	P		Â	
1				1	A	Q		Ã	α
2			”	2	B	R		Å	β
3				3	C	S		Á	γ
4				4	D	T		Ä	δ
5			%	5	E	U		Ä	ε
E			.	>	N			5/8	ö
F			/	*	O			®	

Code Point: 2F

Character-Set ss1
(in code-page pp1)

Code-Page: pp2 (EBCDIC)

	0	1		A	B	C	D	E	F
0					#				0
1					\$	A	J		1
2				s	%	B	K	S	2
3				t	—	C	L	T	3
4				u	*	D	M	U	4
5				v	(E	N	V	5
E					!	:	Ä	}	
F				Ä	¢	:	Á	{	

Character-Set ss1
(in code-page pp2)

RV2F976-3

Even with the same encoding scheme there are many different coded character sets, and the same code point can represent a different character in different coded character sets. Furthermore, a byte in a character string does not necessarily represent a character from a single-byte character set (SBCS). Character strings are also used for mixed data (a mixture of single-byte characters and double-byte characters) and for data that is not associated with any character set (called bit data). This is not the case with graphic strings; the database manager assumes that every pair of bytes in every graphic string represents a character from a double-byte character set (DBCS) or universal coded character set (UCS-2 or UTF-16).

A coded character set identifier (CCSID) in a native encoding scheme is one of the coded character sets in which data may be stored at that site. A CCSID in a foreign encoding scheme is one of the coded character sets in which data cannot be stored at that site. For example, Db2 for i can store data in a CCSID with an EBCDIC encoding scheme, but not in an ASCII encoding scheme.

A variable containing data in a foreign encoding scheme (other than Unicode) is always converted to a CCSID in the native encoding scheme when the variable is used in a function or in the *select-list*. A variable containing data in a foreign encoding scheme is also effectively converted to a CCSID in the native encoding scheme when used in comparison or in an operation that combines strings. Which CCSID in the native encoding scheme the data is converted to is based on the foreign CCSID and the default CCSID.

For details on character conversion, see:

- [“Conversion rules for assignments” on page 96](#)
- [“Conversion rules for comparison:” on page 103](#)
- [“Conversion rules for operations that combine strings” on page 112](#)

- [“Data representation considerations”](#) on page 41.

Coded character sets and CCSIDs

IBM's Character Data Representation Architecture (CDRA) deals with the differences in string representation and encoding. The *Coded Character Set Identifier (CCSID)* is a key element of this architecture. A CCSID is a 2-byte (unsigned) binary number that uniquely identifies an encoding scheme and one or more pairs of character sets and code pages.

A CCSID is an attribute of strings, just as length is an attribute of strings. All values of the same string column have the same CCSID.

Character conversion is described in terms of CCSIDs of the source and target. Each database manager provides support to identify valid source and target combinations and to perform the conversion from one coded character set to another. In some cases, no conversion is necessary even though the strings involved have different CCSIDs.

Different types of conversions may be supported by the database manager. Round-trip conversions attempt to preserve characters in one CCSID that are not defined in the target CCSID so that if the data is subsequently converted back to the original CCSID, the same original characters result. Enforced subset match conversions do not attempt to preserve such characters. For more information, see IBM's Character Data Representation Architecture (CDRA).

Default CCSID

Every application server and application requester has a default CCSID (or default CCSIDs in installations that support DBCS data).

The CCSID of the following types of strings is determined at the current server:

- String constants (including string constants that represent datetime values) when the CCSID of the source is in a foreign encoding scheme
- Special registers with string values (such as USER and CURRENT SERVER)
- CAST specifications where the result is a character or graphic string
- Results of CHAR, DATAPARTITIONNAME, DAYNAME, DBPARTITIONNAME, DIGITS, HEX, MONTHNAME, SOUNDEX, SPACE, and VARCHAR_FORMAT scalar functions
- Results of DECRYPT_CHAR, DECRYPT_DB, CHAR, GRAPHIC, VARCHAR, and VARGRAPHIC scalar functions when a CCSID is not specified as an argument
- Results of the CLOB and DBCLOB scalar functions when a CCSID is not specified as an argument¹¹
- String columns defined by the CREATE TABLE or ALTER TABLE statements when an explicit CCSID is not specified for the column¹¹
- String columns defined by the DECLARE GLOBAL TEMPORARY TABLE statement when an explicit CCSID is not specified for the column¹¹
- Distinct types when the source type is a character or graphic string type
- String parameters defined by CREATE FUNCTION or CREATE PROCEDURE statements when an explicit CCSID is not specified for the parameter¹¹

If one of the types of strings above is used in a CREATE VIEW statement, the default CCSID is determined at the time the view is created.

¹¹ If the default CCSID is 65535, the CCSID used will be the value of the DFTCCSID job attribute (or an associated CCSID of the DFTCCSID). If there is no associated mixed data CCSID,

- the CCSID used when FOR MIXED DATA is specified will be 65535,
- the CCSID for GRAPHIC and VARGRAPHIC will be 65535, and
- the CCSID for DBCLOB will be 1200.

In a distributed application, the default CCSID of variables is determined by the application requester. In a non-distributed application, the default CCSID of variables is determined by the application server. On the IBM i operating system, the default CCSID is determined by the CCSID job attribute. For more information about CCSIDs, see the [Work with CCSIDs](#) topic in the Globalization topic collection.

Collating sequence

A collating sequence (also called a sort sequence) defines how characters in a character set relate to each other when they are compared and ordered.

Different collating sequences are useful for those who want their data ordered for a specific language. For example, lists can be ordered as they are normally seen for a specific language. A collating sequence can also be used to treat certain characters as equivalent, for instance, **a** and **A**. A collating sequence works on all comparisons that involve:

- SBCS character data (including bit data)
- the SBCS portion of mixed data
- Unicode data (UTF-8, UCS-2, or UTF-16).

SBCS collating sequence support is implemented using a 256-byte table. Each byte in the table corresponds to a code point or character in a SBCS code page. Because the collating sequence is applicable to character data, a CCSID must be associated with the table. The bytes in the collating sequence table are set based on how each code point is to compare to other code points in that code page. For example, if the characters **a** and **A** are to be treated as equivalents for comparisons, the bytes in the collating sequence table for their code points contain the same value, or weight.

UCS-2 collating sequence support is implemented using a multi-byte table. A pair of bytes within the table corresponds to a character in the UCS-2 code page. Only a subset of the thousands of characters in UCS-2 are typically represented in the table. Only those characters that are to compare differently (and possibly other characters in the same ward) will be represented in the table. The bytes in the collating sequence table are set based on how each character is to compare with other characters in UCS-2.

When two or more bytes (or pair of bytes for UCS-2) in a collating sequence table have the same value, the collating sequence is a shared-weight collating sequence. If every byte (or pair of bytes for UCS-2) in a collating sequence table has a unique value, the collating sequence is a unique-weight collating sequence. For many languages, unique- and shared-weight collating sequences are shipped on the system as part of the operating system. If you need collating sequences for other languages or needs, you define them using the Create Table (CRTTBL) command.

UTF-8 and UTF-16 collating sequence support is implemented using ICU (International Components for Unicode). This is a standard API to sort Unicode. The API produces the same result for normalized and non-normalized data and returns a sort weight based on language specific rules. The IBM i operating system supports ICU 2.3.1, ICU 3.4, and ICU 4.0 collating sequences, but ICU 3.4 or ICU 4.0 should be used. The ICU collating sequence table I34en_us (United States locale) will sort data differently than I34fr_FR (French locale).

If ICU is used, the LIKE predicate and the LOCATE, POSITION, POSSTR, and POSITION scalar functions are not supported.

If ICU 2.3.1 is used, the query cannot contain:

- EXCEPT or INTERSECT operations,
- VALUES in a fullselect,
- OLAP specifications,
- recursive common table expressions,
- ORDER OF,
- scalar fullselects (scalar subselects are supported),
- full outer join,
- LOBs in a GROUP BY,

- grouping sets or super groups,
- ORDER BY or FETCH clause in a subselect,
- OFFSET clause, or FETCH clause with a variable for N rows,
- CORRELATION, COVARIANCE, COVARIANCE_SAMP, LISTAGG, MEDIAN, PERCENTILE_CONT, PERCENTILE_DISC, or Regression aggregate functions,
- VERIFY_GROUP_FOR_USER, LOCATE_IN_STRING, LTRIM or RTRIM with 2 arguments, EXTRACT function with EPOCH, HASH functions,
- BSON_TO_JSON, JSON_ARRAY, JSON_ARRAYAGG, JSON_OBJECT, JSON_OBJECTAGG, JSON_QUERY, JSON_TABLE, JSON_TO_BSON, and JSON_VALUE functions, and the IS JSON and JSON_EXISTS predicates,
- CONTAINS or SCORE functions,
- XMLAGG, XMLATTRIBUTES, XMLCOMMENT, XMLCONCAT, XMLDOCUMENT, XMLELEMENT, XMLFOREST, XMLGROUP, XMLNAMESPACES, XMLPI, XMLROW, or XMLTEXT functions,
- default values for user defined functions,
- global variables, or
- references to arrays.

An ICU collating sequence table will generally produce results that are more culturally correct, however:

- The performance of SQL statements that use an ICU collating sequence table will generally perform worse than when using either an SBCS or UCS-2 collating sequence table. Indexes can be created with an ICU collating sequence table, however, to improve performance. In this case, the index key values will contain the ICU weighted value which will greatly reduce the number of times the system's ICU support is called.
- The storage necessary for indexes that use an ICU collating sequence table will generally be greater than when using either an SBCS or UCS-2 collating sequence table. The key values can be up to 3 times longer than the length of SBCS data used to produce the key and up to 6 times longer than the length of DBCS data used to produce the key.

It is important to remember that the data itself is not altered by the collating sequence. Instead, a weighted representation of the data is used for the comparison. In SQL, a collating sequence is specified on the CRTSQLxxx, STRSQL, and RUNSQLSTM commands. The SET OPTION statement can be used to specify the collating sequence within the source of a program containing embedded SQL. The collating sequence applies to all character comparisons performed in the SQL statements. The default collating sequence on the system is the internal sequence that occurs when the hexadecimal representation of characters are used. This is the sequence you get when the SRTSEQ(*HEX) is specified. For programs precompiled with a release of the product that is earlier than Version 2 Release 3, the collating sequence is *HEX.

Collating sequences do not apply to FOR BIT DATA or binary string columns.

The collating sequence is not allowed for an index or unique constraint that contains a key column with a field procedure.

The *collating sequence* is explicitly specified through the following interfaces:

<i>Table 3. Collating Sequence Interfaces</i>	
SQL Interface	Specification
Embedded SQL	SRTSEQ parameter on the Create SQL Program (CRTSQLxxx) commands. The SET OPTION statement can also be used to set the SRTSEQ values. (For more information about CRTSQLxxx commands, see Embedded SQL Programming .)

<i>Table 3. Collating Sequence Interfaces (continued)</i>	
SQL Interface	Specification
Run SQL Statements	SRTSEQ parameter on the Run SQL Statements (RUNSQLSTM) command. (For more information about the RUNSQLSTM command, see SQL Programming .)
Call Level Interface (CLI) on the server	SQL_ATTR_JOB_SORT_SEQUENCE environment variable (For more information about CLI, see SQL Call Level Interfaces (ODBC) .)
JDBC or SQLJ on the server using IBM IBM Developer Kit for Java	job.sort.sequence property object (For more information about JDBC and SQLJ, see IBM Developer Kit for Java .)
ODBC on a client using the IBM i Access Family ODBC Driver	Sort Type in ODBC Setup (For more information about ODBC, see IBM i Access .)
JDBC on a client using the IBM Toolbox for Java	Sort Sequence Table in JDBC Setup (For more information about JDBC, see IBM i Access .) (For more information about the IBM Toolbox for Java, see IBM Toolbox for Java .)
OLE DB on a client using the IBM i Access Family OLE DB Provider	Sort Sequence Connection Object Properties (For more information about OLE DB, see IBM i Access .)
ADO .NET on a client using the IBM i Access Family ADO .NET Provider	SortSequence in Connection Object Properties (For more information about ADO .NET, see IBM i Access .)

For more information about CCSIDs, see the [Work with CCSIDs](#) topic in the Globalization section of the IBM i Information Center. For more information about collating sequences and the sequences shipped with the system, see the [DB2 and SQL collating sequence](#) topic in the IBM i Information Center.

Distributed relational database

A *distributed relational database* consists of a set of tables and other objects that are spread across different but interconnected computer systems or logical partitions on the same computer system. Each computer system has a relational database manager that manages the tables in its environment. The database managers communicate and cooperate with each other in a way that allows a database manager to execute SQL statements on another computer system.

Distributed relational databases are built on formal requester-server protocols and functions. An *application requester* supports the application end of a connection. It transforms a database request from the application into communication protocols suitable for use in the distributed database network. These requests are received and processed by an *application server* at the other end of the connection.¹² Working together, the application requester and application server handle the communication and

¹² This is also known as a *an application server*.

location considerations so that the application is isolated from these considerations and can operate as if it were accessing a local database. A simple distributed relational database environment is illustrated in Figure 8 on page 36.

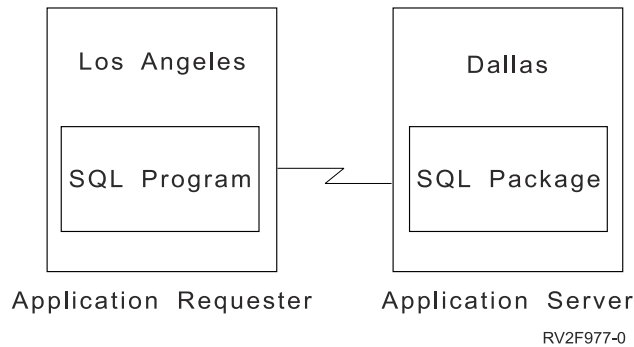



Figure 8. A Distributed Relational Database Environment

For more information about Distributed Relational Database Architecture™ (DRDA) communication protocols, see [Open Group Publications: DRDA Vol. 1: Distributed Relational Database Architecture \(DRDA\)](#) 

Application servers

An activation group must be connected to the application server of a database manager before SQL statements can be executed.

A *connection* is an association between an activation group and a local or remote application server. A connection is also known as a session or an SQL session. Connections are managed by the application. The CONNECT statement can be used to establish a connection to an application server and make that application server the current server of the activation group.

An implicit CONNECT operation may also establish a connection to the application server:

- An implicit CONNECT operation may occur when invoking a program, service program, or the STRSQL command. The application server is determined by the RDB parameter on the CRTSQLxxx and STRSQL commands.

An implicit CONNECT operation will not occur if an implicit or explicit CONNECT operation has already successfully or unsuccessfully occurred in the activation group. Thus, an activation group cannot be implicitly connected to an application server more than once.

- An implicit CONNECT operation may occur when using a three-part object name or an alias that is defined to reference a three-part name of a table or view.

An implicit CONNECT operation is only allowed if all the objects referenced in the SQL statement refer to the same relational database. The only exceptions are:

- The target table of an INSERT statement may be in one relational database and the tables referenced in the *select-statement* of the INSERT may be in another relational database.
- The new table for a CREATE TABLE or DECLARE GLOBAL TEMPORARY TABLE statement may be in one relational database and the tables referenced in the *select-statement* may be in another relational database.

The implicit CONNECT changes the current server for the statement. At the end of the statement the connection is set back to the prior current server.

- When creating three-part qualified SQL stored procedures or SQL functions, objects in the procedure body must exist on both the DRDA client and DRDA server. If the procedure body objects do not exist, object not found errors may be signalled.

An application server can be local to, or remote from, the environment where the activation group is started. (An application server is present, even when distributed relational databases are not used.) This environment includes a local directory that describes the application servers that can be identified in a

CONNECT statement. For more information about the directory, see the relational database folders in System i Navigator or the directory commands (ADDRDBDIRE, CHGRDBDIRE, DSPRDBDIRE, RMVRDBDIRE, and WRKRDBDIRE) in the following IBM i Information Center topics:

- [SQL Programming](#)
- [Distributed Database Programming](#)
- [CL commands](#)

To execute a static SQL statement that references tables or views, an application server uses the bound form of the statement. This bound statement is taken from a package that the database manager previously created through a bind operation. The appropriate package is determined by the combination of:

- The name of the package specified by the SQLPKG parameter on the CRTSQLxxx commands. See [Embedded SQL Programming](#) for a description of the CRTSQLxxx commands.
- The internal consistency token that makes certain the package and program were created from the same source at the same time.

A Db2 relational database product may support a feature that is not supported by the version of the Db2 product that is connecting to the application server. Some of these features are product-specific, and some are shared by more than one product.

For the most part, an application can use the statements and clauses that are supported by the database manager of the application server to which it is currently connected, even though that application is running via the application requester of a database manager that does not support some of those statements and clauses. Restrictions are listed in [Appendix B, “Characteristics of SQL statements,”](#) on page 1643.

CONNECT (type 1) and CONNECT (type 2)

There are two types of CONNECT statements with the same syntax but different semantics. CONNECT (type 1) is used for remote unit of work. CONNECT (type 2) is used for distributed unit of work.

See [“CONNECT \(type 1\) and CONNECT \(type 2\) differences”](#) on page 1654 for a summary of the differences.

Remote unit of work

The *remote unit of work* facility provides for the remote preparation and execution of SQL statements. An activation group at computer system A can connect to an application server at computer system B. Then, within one or more units of work, that activation group can execute any number of static or dynamic SQL statements that reference objects at B. After ending a unit of work at B, the activation group can connect to an application server at computer system C, and so on.

Most SQL statements can be remotely prepared and executed with the following restrictions:

- All objects referenced in a single SQL statement must be managed by the same application server.
- All of the SQL statements in a unit of work must be executed by the same application server.

Remote unit of work connection management

An activation group is in one of three states at any time:

- Connectable and connected
- Unconnectable and connected
- Connectable and unconnected

The following diagram shows the state transitions:

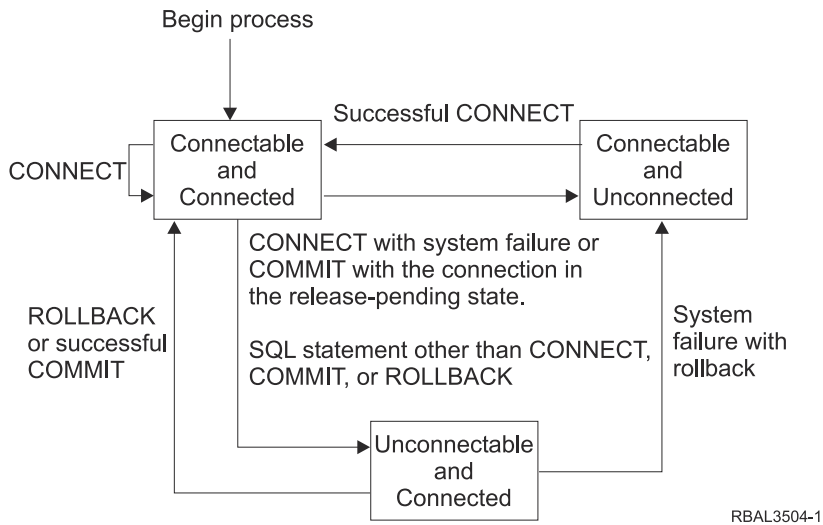

Figure 9. Remote Unit of Work Activation Group Connection State Transition

The initial state of an activation group is *connectable and connected*.

The connectable and connected state

An activation group is connected to an application server and CONNECT statements can be executed. The activation group enters this state when it completes a rollback or successful commit from the unconnectable and connected state, or a CONNECT statement is successfully executed from the connectable and unconnected state.

The unconnectable and connected state

An activation group is connected to an application server, but a CONNECT statement cannot be successfully executed to change application servers. The activation group enters this state from the connectable and connected state when it executes any SQL statement other than CONNECT, COMMIT, or ROLLBACK.

The connectable and unconnected state

An activation group is not connected to an application server. The only SQL statement that can be executed is CONNECT.

The activation group enters this state when:

- The connection was previously released and a successful COMMIT is executed.
- The connection is disconnected using the SQL DISCONNECT statement.
- The connection was in a connectable state, but the CONNECT statement was unsuccessful.

Consecutive CONNECT statements can be executed successfully because CONNECT does not remove the activation group from the connectable state. A CONNECT to the application server to which the activation group is currently connected is executed like any other CONNECT statement. CONNECT cannot execute successfully when it is preceded by any SQL statement other than CONNECT, COMMIT, DISCONNECT, SET CONNECTION, RELEASE, or ROLLBACK (unless running with COMMIT(*NC)). To avoid an error, execute a commit or rollback operation before a CONNECT statement is executed.

Application-directed distributed unit of work

The *application-directed distributed unit of work facility* also provides for the remote preparation and execution of SQL statements in the same fashion as remote unit of work. Like remote unit of work, an activation group at computer system A can connect to an application server at computer system B and execute any number of static or dynamic SQL statements that reference objects at B before ending the

unit of work. All objects referenced in a single SQL statement must be managed by the same application server. However, unlike remote unit of work, any number of application servers can participate in the same unit of work. A commit or rollback operation ends the unit of work.

Distributed unit of work is fully supported for APPC and TCP/IP connections.

Application-directed distributed unit of work connection management

At any time:

- An activation group is always in the *connected* or *unconnected* state and has a set of zero or more connections. Each connection of an activation group is uniquely identified by the name of the application server of the connection.
- An SQL connection is always in one of the following states:
 - Current and held
 - Current and release-pending
 - Dormant and held
 - Dormant and release-pending

Initial state of an activation group:

An activation group is initially in the connected state and has exactly one connection. The initial state of a connection is *current and held*.

The following diagram shows the state transitions:

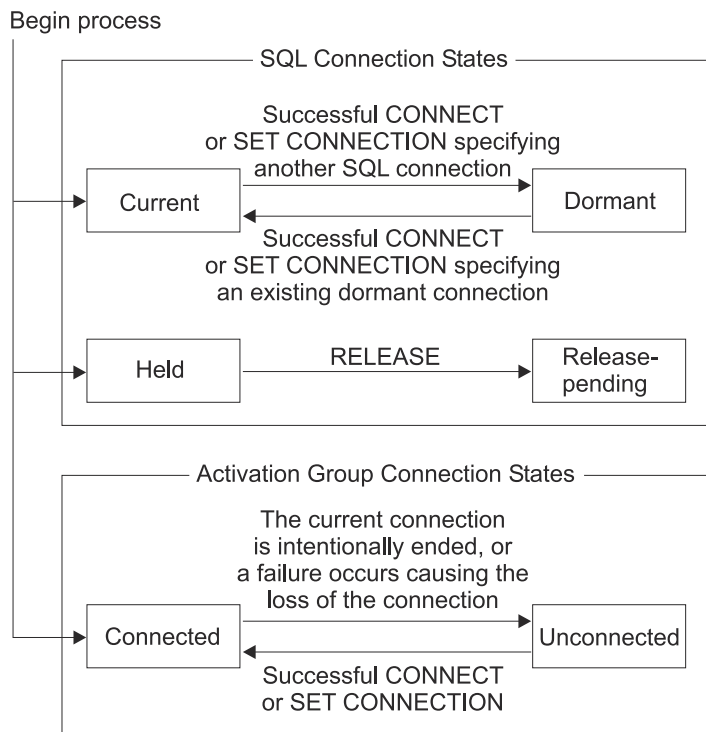

RBAL3503-0

Figure 10. Application-Directed Distributed Unit of Work Connection and Activation Group Connection State Transitions

Connection states

If an application process successfully executes a CONNECT statement:

- The current connection is placed in the dormant state and held state.
- The server name is added to the set of connections and the new connection is placed in the current and held state.

If the server name is already in the set of existing connections of the activation group, an error is returned.

A connection in the dormant state is placed in the current state using the SET CONNECTION statement. When a connection is placed in the current state, the previous current connection, if any, is placed in the dormant state. No more than one connection in the set of existing connections of an activation group can be current at any time. Changing the state of a connection from current to dormant or from dormant to current has no effect on its held or release-pending state.

A connection is placed in the release-pending state by the RELEASE statement. When an activation group executes a commit operation, every release-pending connection of the activation group is ended. Changing the state of a connection from held to release-pending has no effect on its current or dormant state. Thus, a connection in the release-pending state can still be used until the next commit operation. There is no way to change the state of a connection from release-pending to held.

Activation group connection states

A different application server can be established by the explicit or implicit execution of a CONNECT statement. The following rules apply:

- An activation group cannot have more than one connection to the same application server at the same time.
- When an activation group executes a SET CONNECTION statement, the specified location name must be an existing connection in the set of connections of the activation group.
- When an activation group executes a CONNECT statement, the specified server name must not be an existing connection in the set of connections of the activation group.

If an activation group has a current connection, the activation group is in the *connected* state. The CURRENT SERVER special register contains the name of the application server of the current connection. The activation group can execute SQL statements that refer to objects managed by that application server.

An activation group in the unconnected state enters the connected state when it successfully executes a CONNECT or SET CONNECTION statement.

If an activation group does not have a current connection, the activation group is in the *unconnected* state. The CURRENT SERVER special register contents are equal to blanks. The only SQL statements that can be executed are CONNECT, DISCONNECT, SET CONNECTION, RELEASE, COMMIT, and ROLLBACK.

An activation group in the connected state enters the unconnected state when its current connection is intentionally ended or the execution of an SQL statement is unsuccessful because of a failure that causes a rollback operation at the current server and loss of the connection. Connections are intentionally ended when an activation group successfully executes a commit operation and the connection is in the release-pending state, or when an application process successfully executes the DISCONNECT statement.

When a connection is ended

When a connection is ended, all resources that were acquired by the activation group through the connection and all resources that were used to create and maintain the connection are deallocated. For example, if application process P has placed the connection to application server X in the application server state, all cursors of P at X will be closed and deallocated when the connection is ended during the next commit operation.

A connection can also be ended as a result of a communications failure in which case the activation group is placed in the unconnected state. All connections of an activation group are ended when the activation group ends.

Data representation considerations

Different systems represent data in different ways. When data is moved from one system to another, data conversion must sometimes be performed. Products supporting DRDA will automatically perform any necessary conversions at the receiving system.

With numeric data, the information needed to perform the conversion is the data type and the sending system's environment type. For example, when a floating-point variable from a Db2 for i application requester is assigned to a column of a table at an z/OS[®] application server, the number is converted from IEEE format to System/370* format.

With character and graphic data, the data type and the environment type of the sending system are not sufficient. Additional information is needed to convert character and graphic strings. String conversion depends on both the coded character set of the data and the operation to be done with that data. String conversions are done in accordance with the IBM Character Data Representation Architecture (CDRA). For more information about character conversion, refer to the book *Character Data Representation Architecture Reference and Registry*, SC09-2190.

Chapter 2. Language elements

This section defines the basic syntax of SQL and language elements that are common to many SQL statements.

Characters

The basic symbols of keywords and operators in the SQL language are single-byte characters that are part of all character sets supported by the IBM relational database products.

Characters of the language are classified as letters, digits, or special characters.¹³

A *letter* is any of the 26 uppercase (A through Z) and 26 lowercase (a through z) letters of the English alphabet.¹⁴

A *digit* is any of the characters 0 through 9.

A *special character* is any of the characters listed below:

	space or blank	-	minus sign
"	quotation mark or double-quote or double quotation mark	.	period
%	percent	/	slash
&	ampersand	:	colon
'	apostrophe or single quote or single quotation mark	;	semicolon
(left parenthesis	<	less than
)	right parenthesis	=	equals
*	asterisk	>	greater than
+	plus sign	?	question mark
,	comma	_	underline or underscore
	vertical bar ¹⁶	^	caret
!	exclamation mark ¹⁵	[left bracket
{	left brace]	right bracket
}	right brace	¬	not ¹⁵

¹³ Note that if the SQL statement is encoded as Unicode data, all characters of the statement except for string constants will be converted to single-byte characters prior to processing. Tokens representing string constants may be processed as UTF-16 graphic strings without conversion to single-byte.

¹⁴ Letters also include three code points reserved as alphabetic extenders for national languages (#, @, and \$ in the United States). These three code points should be avoided because they represent different characters depending on the CCSID.

¹⁵ Using the not symbol (¬) and the exclamation point symbol (!) might inhibit code portability between IBM relational database products. Avoid using them because they are variant characters. Instead of ¬= or != use <>. Instead of ¬> or !> use <=. Instead of ¬< or !< use >=.

¹⁶ Using the vertical bar (|) character might inhibit code portability between IBM relational database products. Use the CONCAT operator instead of the concatenation operator (||).

Tokens

The basic syntactical units of the language are called *tokens*. A token consists of one or more characters, excluding blanks, control characters, and characters within a string constant or delimited identifier. (These terms are defined later.)

Tokens are classified as *ordinary* or *delimiter* tokens:

- An *ordinary token* is a numeric constant, an ordinary identifier, a host identifier, or a keyword.

Examples

```
1      .1      +2      SELECT      E      3
```

- A *delimiter token* is a string constant, a delimited identifier, an operator symbol, or any of the special characters shown in the syntax diagrams. A question mark (?) is also a delimiter token when it serves as a parameter marker, as explained under “PREPARE” on page 1427.

Examples

```
,      'Myst Island'      "fld1"      =      .
```

Spaces:

A *space* is a sequence of one or more blank characters.

Control Characters:

A *control character* is a special character that is used for string alignment. The following table contains the control characters that are handled by the database manager:

Control Character	EBCDIC Hex Value	UTF-8 Hex Value	UCS-2 and UTF-16 Hex Value
Tab	05	09	U+0009
Form Feed	0C	0C	U+000C
Carriage Return	0D	0D	U+000D
New Line	15	C285	U+0085
Line Feed (New line)	25	0A	U+000A
DBCS Space	—	—	U+3000

Tokens, other than string constants and certain delimited identifiers, must not include a control character or space. A control character or space can follow a token. A delimiter token, a control character, or a space *must* follow every ordinary token. If the syntax does not allow a delimiter token to follow an ordinary token, then a control character or a space must follow that ordinary token. The following examples illustrate the rule that is stated in this paragraph.

Here are some examples of combinations of the above ordinary tokens that, in effect, change the tokens:

```
1.1      .1+2      SELECTE      .1E      E3      SELECT1
```

This demonstrates why ordinary tokens must be followed by a delimiter token or a space.

Here are some examples of combinations of the above ordinary tokens and the above delimiter tokens that, in effect, change the tokens:

```
1.      .3
```

The period (.) is a delimiter token when it is used as a separator in the qualification of names. Here the dot is used in combination with an ordinary token of a numeric constant. Thus, the syntax does not allow an ordinary token to be followed by a delimiter token. Instead, the ordinary token must be followed by a space.

If the decimal point has been defined to be the comma, as described in [“Decimal point” on page 118](#), the comma is interpreted as a decimal point in numeric constants. Here are some examples of these numeric constants:

```
1,2      ,1      1,      1,e1
```

If '1,2' and '1,e1' are meant to be two items, both the ordinary token (1) and the delimiter token (,) must be followed by a space, to prevent the comma from being interpreted as a decimal point. Although the comma is usually a delimiter token, the comma is part of the number when it is interpreted as a decimal point. Therefore, the syntax does not allow an ordinary token (1) to be followed by a delimiter token (,). Instead, an ordinary token must be followed by a space.

Comments:

Dynamic SQL statements can include SQL comments. Static SQL statements can include host language comments or SQL comments. Comments may be specified wherever a space may be specified, except within a delimiter token or between the keywords EXEC and SQL. In Java, SQL comments are not allowed within embedded Java expressions. There are two types of SQL comments:

simple comments

Simple comments are introduced by two consecutive hyphens (--). Simple comments cannot continue past the end of the line. For more information, see [“SQL comments” on page 803](#).

bracketed comments

Bracketed comments are introduced by /* and end with */. A bracketed comment can continue past the end of the line. For more information, see [“SQL comments” on page 803](#).

Uppercase and Lowercase:

Any token in an SQL statement may include lowercase letters, but a lowercase letter in an ordinary token is folded to uppercase, except for variables in the C and Java languages, which have case-sensitive identifiers. Delimiter tokens are never folded to uppercase. Thus, the statement:

```
select * from EMP where lastname = 'Smith';
```

is equivalent, after folding, to:

```
SELECT * FROM EMP WHERE LASTNAME = 'Smith';
```

Identifiers

An *identifier* is a token used to form a name. An identifier in an SQL statement is an SQL identifier, a system identifier, or a host identifier.

Note: \$, @, #, and all other variant characters should not be used in identifiers because the code points used to represent them vary depending on the CCSID of the string in which they are contained. If they are used, unpredictable results may occur. For more information about variant characters, see the [DB2 and SQL sort sequence](#) topic.

SQL identifiers

There are two types of SQL identifiers: *ordinary identifiers* and *delimited identifiers*.

- An *ordinary identifier* is an uppercase letter followed by zero or more characters, each of which is an uppercase letter, a digit, or the underscore character. Note that ordinary identifiers are converted to uppercase. An ordinary identifier should not be a reserved word. See [Appendix I, “Reserved schema names and reserved words,”](#) on page 1993 for a list of reserved words. If a reserved word is used as an identifier in SQL, it should be specified in uppercase and should be a delimited identifier or specified in a variable.
- A *delimited identifier* is a sequence of one or more characters enclosed within SQL escape characters. The sequence must consist of one or more characters. Leading blanks in the sequence are significant. Trailing blanks in the sequence are not significant. The length of a delimited identifier does not include the two SQL escape characters. Note that delimited identifiers are not converted to uppercase. The escape character is the quotation mark (") except in the following cases where the escape character is the apostrophe ('):
 - Interactive SQL when the SQL string delimiter is set to the quotation mark in COBOL syntax checking statement mode
 - Dynamic SQL in a COBOL program when the CRTSQLCBL or CRTSQLCBLI parameter OPTION(*QUOTESQL) specifies that the string delimiter is the quotation mark (")
 - COBOL application program when the CRTSQLCBL or CRTSQLCBLI parameter OPTION(*QUOTESQL) specifies that the string delimiter is the quotation mark (")

The following characters are not allowed within delimited identifiers:

- X'00' through X'3F' and X'FF'

System identifiers

A system identifier is used to form the name of system objects in the IBM i operating system. There are two types of system identifiers: ordinary identifiers and delimited identifiers.

- The rules for forming a system ordinary identifier are identical to the rules for forming an SQL ordinary identifier.
- The rules for forming a system delimited identifier are identical to those for forming SQL delimited identifiers, except:
 - The following special characters are not allowed in a delimited system identifier:
 - A blank (X'40')
 - An asterisk (X'5C')
 - An apostrophe (X'7D')
 - A question mark (X'6F')
 - A quotation mark (X'7F')
 - The bytes required for the escape characters are included in the length of the identifier unless the characters within the delimiters would form an ordinary identifier.

For example, “PRIVILEGES” is in uppercase and the characters within the delimiters form an ordinary identifier; therefore, it has a length of 10 bytes and is a valid system name for a column. Alternatively, “privileges” is in lowercase, has a length of 12 bytes, and is not a valid system name for a column because the bytes required for the delimiters must be included in the length of the identifier.

Examples

```
WKLYSAL    WKLY_SAL    "WKLY_SAL"    "UNION"    "wkly_sal"
```

See [“Naming conventions” on page 48](#) for information on the maximum length of identifiers.

Host identifiers

A *host-identifier* is a name declared in the host program.

The rules for forming a host-identifier are the rules of the host language; except that DBCS characters cannot be used. For example, the rules for forming a host-identifier in a COBOL program are the same as the rules for forming a user-defined word in COBOL. Names beginning with the characters 'SQ', 'SQL', 'sql', 'RDI', or 'DSN' should not be used because precompilers generate host variables that begin with these characters. In Java, do not use names beginning with ' __sJT_ '.

See [Table 5 on page 55](#) for the limits on the maximum size of the host identifier name imposed by Db2 for i.

¹⁷ 'SQ' is allowed in C, COBOL, and PL/I; it should not be used in RPG.

Naming conventions

The rules for forming a name depend on the type of the object designated by the name and the naming option (*SQL or *SYS). The naming option is specified on the CRTSQLxxx, RUNSQLSTM, and STRSQL commands. The SET OPTION statement can be used to specify the naming option within the source of a program containing embedded SQL. The syntax diagrams use different terms for different types of names.

The following list defines these terms.

alias-name

A qualified or unqualified name that designates an alias. The qualified form of an *alias-name* depends on the naming option. For SQL naming, the qualified form is a *schema-name* followed by a period (.) and an SQL identifier. For system naming, the qualified form is a *schema-name* followed by a slash (/) followed by an SQL identifier¹⁸.

The unqualified form of an *alias-name* is an SQL identifier. The unqualified form is implicitly qualified based on the rules specified in [“Qualification of unqualified object names” on page 57](#).

An *alias-name* can specify either the name of the alias or the system object name of the alias.

array-type-name

A qualified or unqualified name that designates an array type. The qualified form of a *array-type-name* depends upon the naming option. For SQL naming, the qualified form is a *schema-name* followed by a period (.) and an SQL identifier. For system naming, the qualified form is a *schema-name* followed by a slash (/) followed by an SQL identifier¹⁸.

The unqualified form of a *array-type-name* is an SQL identifier. The unqualified form is implicitly qualified based on the rules specified in [“Qualification of unqualified object names” on page 57](#).

For system naming, *array-type-names* cannot be qualified when used in a parameter data type of an SQL routine or in an SQL variable declaration in an SQL procedure.

authorization-name

A system identifier that designates a user or group of users. An *authorization-name* is a user profile name on the server. It must not be a delimited identifier that includes lowercase letters or special characters. See [“Authorization IDs and authorization names” on page 61](#) for the distinction between an *authorization-name* and an authorization ID.

column-name

A qualified or unqualified name that designates a column of a table or a view. The unqualified form of a *column-name* is an SQL identifier. The qualified form is a qualifier followed by a period and an SQL identifier. The qualifier is a table name, a view name, or a correlation name.

For system naming, column names can be qualified using the form *schema-name/table-name.column-name* when the name is used in the COMMENT and LABEL statements. If column names need to be qualified and correlation names are allowed in the statement, a correlation name can be used to qualify the column. The period form of qualification can also be used.

A *column-name* can specify either the column name or the system column name of a column of a table or view. If a *column-name* is delimited, the delimiters are considered to be part of the name when determining the length of the name.

constraint-name

A qualified or unqualified name that designates a constraint on a table. The qualified form of a *constraint-name* depends on the naming option. For SQL naming, the qualified form is a *schema-name* followed by a period (.) and an SQL identifier. For system naming, the qualified form is a *schema-name* followed by a slash (/) followed by an SQL identifier¹⁸.

The unqualified form of a *constraint-name* is an SQL identifier. The unqualified form is implicitly qualified based on the rules specified in [“Qualification of unqualified object names” on page 57](#).

The implicit or explicit qualifier must be the same as the schema name of the table.

¹⁸ For system naming, the qualified form that uses a period is also accepted.

correlation-name

An SQL identifier that designates a table, a view, or individual rows of a table or view.

cursor-name

An SQL identifier that designates an SQL cursor.

descriptor-name

A variable name or string constant that designates an SQL descriptor area (SQLDA). A variable that designates an SQL descriptor area must not have an indicator variable. The form *:host-variable:indicator-variable* is not allowed. See [“References to host variables” on page 140](#) for a description of a variable.

distinct-type-name

A qualified or unqualified name that designates a distinct type. The qualified form of a *distinct-type-name* depends upon the naming option. For SQL naming, the qualified form is a *schema-name* followed by a period (.) and an SQL identifier. For system naming, the qualified form is a *schema-name* followed by a slash (/) followed by an SQL identifier¹⁸.

The unqualified form of a *distinct-type-name* is an SQL identifier. The unqualified form is implicitly qualified based on the rules specified in [“Qualification of unqualified object names” on page 57](#).

For system naming, *distinct-type-names* cannot be qualified when used in a parameter data type of an SQL routine or in an SQL variable declaration in an SQL function, SQL procedure, or trigger.

external-program-name

A qualified name, unqualified name, or a character string that designates an external program. The qualified form of an *external-program-name* depends on the naming option. For SQL naming, the qualified form is a *system-schema-name* followed by a period (.) and a system identifier. For system naming, the qualified form is a *system-schema-name* followed by a slash (/) followed by a system identifier¹⁸.

The unqualified form of an *external-program-name* is a system identifier. The unqualified form is implicitly qualified based on the rules specified in [“Qualification of unqualified object names” on page 57](#).

For a service program name, the qualified form depends on the naming option. For SQL naming the qualified form is a *system-schema-name* followed by a period (.), followed by a system identifier for the service program name, followed by a left parenthesis, followed by an IBM i entry-point-name, followed by a right parenthesis (library-name.service-program-name(entry-point-name)). For system naming, the qualified form is a *system-schema-name* followed by a slash (/) followed by a system identifier for the service program name, followed by a left parenthesis, followed by an IBM i entry-point-name, followed by a right parenthesis (library-name/service-program-name(entry-point-name))¹⁸. If the entry point name contains lowercase characters, it must be enclosed in quotes.

The unqualified form of an service program name is a system identifier followed by a left parenthesis, followed by an IBM i entry-point-name, followed by a right parenthesis. The unqualified form is implicitly qualified based on the rules specified in [“Qualification of unqualified object names” on page 57](#).

The format of the character string form is either:

- A IBM i qualified program name ('library-name/program-name').
- A IBM i qualified source file name, followed by a left parenthesis, followed by an IBM i member name, and a right parenthesis ('library-name/source-file-name(member-name)'). This form is only valid when calling a REXX procedure.
- A IBM i qualified or unqualified service program name, followed by a left parenthesis, followed by an IBM i entry-point-name, followed by a right parenthesis ('library-name/service-program-name(entry-point-name)' or 'service-program-name(entry-point-name)').
- In Java, an optional *jar-name*, followed by a class identifier, followed by an exclamation point or period, followed by a method identifier ('class-id!method-id' or 'class-id.method-id').

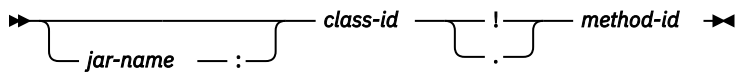

jar-name

The *jar-name* is a case-sensitive string that identifies the jar schema when it was installed in the database. It can be either a simple identifier, or a schema qualified identifier. Examples are 'myJar' and 'myCollection.myJar'.

class-id

The *class-id* identifies the class identifier of the Java object. If the class is part of a Java package, the class identifier must include the complete Java package prefix. For example, if the class identifier is 'myPackage.StoredProcs', the Java virtual machine will look in the following directory for the StoredProcs class:

```
'/QIBM/UserData/OS400/SQLLib/
Function/myPackage/StoredProcs/'
```

method-id

The *method-id* identifies the method name of the public, static Java method to be invoked.

This form is only valid for Java procedures and Java functions.

function-name

A qualified or unqualified name that designates a user-defined function, a cast function that was generated when a strongly typed distinct type was created, or a built-in function. The qualified form of a *function-name* depends upon the naming option. For SQL naming, the qualified form is a *schema-name* followed by a period (.) and an SQL identifier. For system naming, the qualified form is a *schema-name* followed by a slash (/) followed by an SQL identifier¹⁸.

In a CREATE, COMMENT, DROP, GRANT, or REVOKE statement, the *schema-name* can be qualified with a *server-name*. In all other contexts, a *server-name* is not allowed.

The unqualified form of a *function-name* is an SQL identifier. The unqualified form is implicitly qualified based on the rules specified in [“Qualification of unqualified object names”](#) on page 57.

For system naming, functions names can only be qualified in the form *schema-name/function-name* when the name is used in a CREATE, COMMENT, DROP, GRANT, or REVOKE statement. The period form of qualification can be used in an expression.

host-label

A token that designates a label in a host program.

host-variable

A sequence of tokens that designates a host variable. A *host-variable* includes at least one *host-identifier*, as explained in [“References to host variables”](#) on page 140.

index-name

A qualified or unqualified name that designates an index. The qualified form of an *index-name* depends upon the naming option. For SQL naming, the qualified form is a *schema-name* followed by a period (.) and an SQL identifier. For system naming, the qualified form is a *schema-name* followed by a slash (/) followed by an SQL identifier¹⁸.

The unqualified form of an *index-name* is an SQL identifier. The unqualified form is implicitly qualified based on the rules specified in [“Qualification of unqualified object names”](#) on page 57.

mask-name

A qualified or unqualified name that designates a column mask. The qualified form of a *mask-name* depends upon the naming option. For SQL naming, the qualified form is a *schema-name* followed by a period (.) and an SQL identifier. For system naming, the qualified form is a *schema-name* followed by a slash (/) followed by an SQL identifier¹⁸.

The unqualified form of a *mask-name* is an SQL identifier. The unqualified form is implicitly qualified based on the rules specified in [“Qualification of unqualified object names” on page 57](#).

member-name

An unqualified identifier that designates a member of a database file. A member is also a partition of a partitioned table.

nodegroup-name

A qualified or unqualified name that designates a nodegroup. A nodegroup is a group of IBM i products across which a table will be distributed. For more information about distributed tables and nodegroups, see [DB2 Multisystem](#).

The qualified form of a *nodegroup-name* depends on the naming option. For SQL naming, the qualified form is a *schema-name* followed by a period (.) and a system identifier. For system naming, the qualified form is a *schema-name* followed by a slash (/) followed by a system identifier¹⁸.

The unqualified form of a *nodegroup-name* is a system identifier. The unqualified form is implicitly qualified based on the rules specified in [“Qualification of unqualified object names” on page 57](#).

package-name

A qualified or unqualified name that designates a package. The qualified form of a *package-name* depends upon the naming option. For SQL naming, the qualified form is a *schema-name* followed by a period (.) and a system identifier. For system naming, the qualified form is a *schema-name* followed by a slash (/) followed by a system identifier¹⁸.

The unqualified form of a *package-name* is a system identifier. The unqualified form is implicitly qualified based on the rules specified in [“Qualification of unqualified object names” on page 57](#).

parameter-name

An SQL identifier that designates a parameter for a function or procedure. If the *parameter-name* is for a procedure, the identifier may be preceded by a colon.

partition-name

An unqualified identifier that designates a partition of a partitioned table.

permission-name

A qualified or unqualified name that designates a row permission. The qualified form of a *permission-name* depends upon the naming option. For SQL naming, the qualified form is a *schema-name* followed by a period (.) and an SQL identifier. For system naming, the qualified form is a *schema-name* followed by a slash (/) followed by an SQL identifier¹⁸.

The unqualified form of a *permission-name* is an SQL identifier. The unqualified form is implicitly qualified based on the rules specified in [“Qualification of unqualified object names” on page 57](#).

procedure-name

A qualified or unqualified name that designates a procedure. The qualified form of a *procedure-name* depends upon the naming option. For SQL naming, the qualified form is a *schema-name* followed by a period (.) and an SQL identifier. For system naming, the qualified form is a *schema-name* followed by a slash (/) followed by an SQL identifier¹⁸.

The unqualified form of a *procedure-name* is an SQL identifier. The unqualified form is implicitly qualified based on the rules specified in [“Qualification of unqualified object names” on page 57](#).

savepoint-name

An unqualified identifier that designates a savepoint.

schema-name

A qualified or unqualified name that provides a logical grouping for SQL objects. A schema name is used as a qualifier of the name of a table, view, index, procedure, function, trigger, sequence, variable, constraint, alias, type, or package. The unqualified form of a *schema-name* is a system identifier. The qualified form of a *schema-name* depends on the naming option.

For SQL naming, the unqualified schema name in an SQL statement is implicitly qualified by the *server-name*. The qualified form is a *server-name* followed by a (.) and a system identifier.

For system naming, the unqualified schema name in an SQL statement is implicitly qualified by the *server-name*. The qualified form is a *server-name* followed by a slash (/) and an SQL identifier¹⁸.

If the *server-name* is used to qualify the name of the schema, the *server-name* may identify any supported remote server. Otherwise, the schema name is implicitly qualified with the current server.

Note: *schema-name* refers to either a schema created by the CREATE SCHEMA statement or to an IBM i library.

sequence-name

A qualified or unqualified name that designates a sequence. The qualified form of a *sequence-name* depends upon the naming option. For SQL naming, the qualified form is a *schema-name* followed by a period (.) and an SQL identifier. For system naming, the qualified form is a *schema-name* followed by a slash (/) followed by an SQL identifier¹⁸. For system naming, a *sequence-name* cannot be qualified with a slash when used in a NEXT VALUE or PREVIOUS VALUE expression (the slash-qualified form is only allowed in SQL schema statements). The period form of qualification can be used in a NEXT VALUE or PREVIOUS VALUE expression.

The unqualified form of a *sequence-name* is an SQL identifier. The unqualified form is implicitly qualified based on the rules specified in [“Qualification of unqualified object names” on page 57](#).

A *sequence-name* can specify either the name of the sequence or the system object name of the sequence.

server-name

An SQL identifier that designates an application server. The identifier must start with a letter and must not include lowercase letters or special characters.

A *server-name* may be the actual name of the relational database or a relational database alias. For more information see the Add RDB Directory Entry (ADDRDBDIRE) CL command. If a three-part name is specified directly in an SQL statement (other than the base table specified in a CREATE ALIAS statement) it can use either the actual relational database name or the relational database alias name.

For example, if the actual name of the relational database is ABC and a relational database alias name of MYABC also references ABC:

```
SELECT * FROM ABC.SCHEMA1.T1 -- This is valid.  
SELECT * FROM MYABC.SCHEMA1.T1 -- This is also valid.
```

specific-name

A qualified or unqualified name that uniquely identifies a procedure or function. The qualified form of a *specific-name* depends upon the naming option. For SQL naming, the qualified form is a *schema-name* followed by a period (.) and an SQL identifier. For system naming, the qualified form is a *schema-name* followed by a slash (/) followed by an SQL identifier¹⁸.

The unqualified form of a *specific-name* is an SQL identifier. The unqualified form is implicitly qualified based on the rules specified in [“Qualification of unqualified object names” on page 57](#).

SQL-condition-name

An SQL identifier that designates a condition in an SQL procedure, SQL function, or trigger body.

SQL-descriptor-name

A variable name or character or graphic string constant that designates an SQL descriptor that was allocated using the ALLOCATE DESCRIPTOR statement.

If a variable is used to designate the SQL descriptor:

- The variable must not be a CLOB or DBCLOB.
- If the variable is a graphic string, it must be a Unicode graphic string.

- The length of the contents of the variable must not exceed the maximum length for an *SQL-descriptor-name*.
- An indicator variable must not be specified. The form *:host-variable:indicator-variable* is not allowed.
- The contents of the variable are case-sensitive and are not converted to uppercase.

Leading and trailing blanks are trimmed from the variable or string. See [“References to host variables” on page 140](#) for a description of a variable.

If a string constant is used to designate the SQL descriptor, the length of the constant must not exceed the maximum length for an *SQL-descriptor-name*.

SQL-label

An unqualified name that designates a label in an SQL procedure, SQL function, or trigger body. An *SQL-label* is an SQL identifier.

SQL-parameter-name

A qualified or unqualified name that designates a parameter in an SQL routine body. The unqualified form of an *SQL-parameter-name* is an SQL identifier. The qualified form is a *procedure-name* followed by a period (.) and an SQL identifier.

SQL-variable-name

A qualified or unqualified name that designates a variable in an SQL routine body. The unqualified form of an *SQL-variable-name* is an SQL identifier. The qualified form is an *SQL-label* followed by a period (.) and an SQL identifier.

statement-name

An SQL identifier that designates a prepared SQL statement.

system-column-name

An unqualified name that designates the IBM i column name of a table or a view. A *system-column-name* is a system identifier. *System-column-names* can be delimited identifiers, but the characters within the delimiters must not include lowercase letters or special characters.

system-object-name

An unqualified name that designates the IBM i name of a table, view, index, sequence, variable, or alias. A *system-object-name* is a system identifier.

If the unqualified name of the table, view, index, sequence, variable, or alias is a valid system identifier, the *system-object-name* of the table, view, index, sequence, variable, or alias is the unqualified name of the table, view, index, sequence, or alias.

system-schema-name

An unqualified name that designates the IBM i name of a schema. A *system-schema-name* is a system identifier.

If the unqualified name of the schema is a valid system identifier, the *system-schema-name* of the schema is the unqualified name of the schema.

table-name

A qualified or unqualified name that designates a table. The qualified form of a *table-name* depends upon the naming option. For SQL naming, the qualified form is a *schema-name* followed by a period (.) and an SQL identifier. For system naming, the qualified form is a *schema-name* followed by a slash (/) followed by an SQL identifier¹⁸.

The unqualified form of a *table-name* is an SQL identifier. The unqualified form is implicitly qualified based on the rules specified in [“Qualification of unqualified object names” on page 57](#).

A *table-name* can specify either the name of the table or the system object name of the table.

trigger-name

A qualified or unqualified name that designates a trigger on a table. The qualified form of a *trigger-name* depends on the naming option. For SQL naming, the qualified form is a *schema-name* followed by a period (.) and a system identifier. For system naming, the qualified form is a *schema-name* followed by a slash (/) followed by an SQL identifier¹⁸.

The unqualified form of a *trigger-name* is an SQL identifier. The unqualified form is implicitly qualified based on the rules specified in [“Qualification of unqualified object names”](#) on page 57.

variable-name

A qualified or unqualified name that designates a global variable. The qualified form of a *variable-name* depends upon the naming option. For SQL naming, the qualified form is a *schema-name* followed by a period (.) and an SQL identifier. For system naming, the qualified form is a *schema-name* followed by a slash (/) followed by an SQL identifier¹⁸. For system naming, a *variable-name* cannot be qualified with a slash when used in an expression (the slash-qualified form is only allowed in SQL schema statements). The period form of qualification can be used in an expression.

The unqualified form of a *variable-name* is an SQL identifier. The unqualified form is implicitly qualified based on the rules specified in [“Qualification of unqualified object names”](#) on page 57.

A *variable-name* can specify either the name of the variable or the system object name of the variable.

version-id

An identifier of 1 to 64 characters that is assigned to a package when the package is created. A *version-id* is only assigned when packages are created from a server other than Db2 for i.

view-name

A qualified or unqualified name that designates a view. The qualified form of a *view-name* depends upon the naming option. For SQL naming, the qualified form is a *schema-name* followed by a period (.) and an SQL identifier. For system naming, the qualified form is a *schema-name* followed by a slash (/) followed by an SQL identifier¹⁸.

The unqualified form of a *view-name* is an SQL identifier. The unqualified form is implicitly qualified based on the rules specified in [“Qualification of unqualified object names”](#) on page 57.

A *view-name* can specify either the name of the view or the system object name of the view.

xsobject-name

A qualified or unqualified name that designates an object in the XML schema repository. The qualified form of an *xsobject-name* depends upon the naming option. For SQL naming, the qualified form is a *schema-name* followed by a period (.) and an SQL identifier. For system naming, the qualified form is a *schema-name* followed by a slash (/) followed by an SQL identifier¹⁸.

The unqualified form of an *xsobject-name* is an SQL identifier. The unqualified form is implicitly qualified based on the rules specified in [“Qualification of unqualified object names”](#) on page 57.

Table 5. Identifier Length Limits (in bytes)

Identifier Type	Maximum Length
Longest authorization name ¹⁹	10
Longest correlation name	128
Longest cursor name	128
Longest external program name (string form)	279
Longest external program name (unqualified form) ²⁰	10
Longest host identifier	64
Longest package version-id	64
Longest partition name	10
Longest savepoint name	128
Longest schema name	128
Longest server name	18
Longest SQL condition name	128
Longest SQL descriptor name	128
Longest SQL label	128
Longest statement name	128
Longest unqualified alias name	128
Longest unqualified array type name	128
Longest unqualified column name	128
Longest unqualified constraint name	128
Longest unqualified distinct type name	128
Longest unqualified function name	128
Longest unqualified index name	128
Longest unqualified mask name	128
Longest unqualified nodegroup name	10
Longest unqualified package name	10
Longest unqualified permission name	128
Longest unqualified procedure name	128
Longest unqualified sequence name	128
Longest unqualified specific name	128
Longest unqualified SQL parameter name	128
Longest unqualified SQL variable name	128
Longest unqualified system column name	10
Longest unqualified system object name	10
Longest unqualified system schema name	10

Table 5. Identifier Length Limits (in bytes) (continued)

Identifier Type	Maximum Length
Longest unqualified table and view name	128
Longest unqualified trigger name	128
Longest unqualified variable name	128
Longest unqualified XSR object name	128

¹⁹ As an application requester, the system can send an authorization name of up to 255 bytes.

²⁰ For REXX procedures, the limit is 33.

SQL path

The *SQL path* is an ordered list of schema names. The database manager uses the path to resolve the schema name for unqualified type names (built-in types, distinct types, and array types), function names, variable names, and procedure names that appear in any context other than as the main object of an ALTER, CREATE, DROP, COMMENT, LABEL, GRANT, or REVOKE statement.

For example, if the SQL path is SMITH, XGRAPHIC, QSYS, QSYS2 and an unqualified distinct type name MYTYPE was specified, database manager looks for MYTYPE first in schema SMITH, then XGRAPHIC, and then QSYS and QSYS2.

The SQL path used depends on the SQL statement:

- For static SQL statements (except for a CALL *variable* statement), the path used is the value of the SQLPATH parameter on the CRTSQLxxx command. The SQLPATH can also be set using the SET OPTION statement.

The path stored in programs, modules, service programs, routines, and triggers, is composed entirely of the *system-schema-names* associated with the schema names in the path. If the *system-schema-name* of a schema is renamed, it may be necessary to recreate these objects if they use SQL statements that depend on the path.

- For dynamic SQL statements (and for a CALL *variable* statement), the path used is the value of the CURRENT PATH special register. For more information about the CURRENT PATH special register, see [“CURRENT PATH” on page 128](#).

If the SQL path is not explicitly specified, the SQL path is the system path followed by the run-time authorization ID of the statement.

For more information about the SQL path for dynamic SQL, see [“CURRENT PATH” on page 128](#).

Qualification of unqualified object names

Unqualified object names are implicitly qualified. The rules for qualifying a name differ depending on the type of object that the name identifies.

Unqualified alias, constraint, external program, index, mask, nodegroup, package, permission, sequence, table, trigger, view, and XSR object names

Unqualified alias, constraint, external program, index, mask, nodegroup, package, permission, sequence, table, trigger, view, and XSR object names are implicitly qualified by the *default schema*.

The *default schema* is specified as follows:

- For static SQL statements:
 - If the DFTRDBCOL parameter is specified on the CRTSQLxxx command (or with the SET OPTION statement), the *default schema* is the *schema-name* that is specified for that parameter.
 - In all other cases, the *default schema* is based on the naming convention.
 - For SQL naming, the *default schema* is the authorization identifier of the statement.
 - For system naming, the *default schema* is the job library list (*LIBL).
- For dynamic SQL statements the *default schema* depends on whether a *default schema* has been explicitly specified. The mechanism for explicitly specifying this depends on the interface used to dynamically prepare and execute SQL statements.
 - If a *default schema* is not explicitly specified:
 - For SQL naming, the *default schema* is the run-time authorization identifier.
 - For system naming, the *default schema* is the job library list (*LIBL).
 - The *default schema* is explicitly specified through the following interfaces:

<i>Table 6. Default Schema Interfaces</i>	
SQL Interface	Specification
Embedded SQL	DFTRDBCOL parameter and DYNDFTCOL(*YES) on the Create SQL Program (CRTSQLxxx) and Create SQL Package (CRTSQLPKG) commands. The SET OPTION statement can also be used to set the DFTRDBCOL and DYNDFTCOL values. (For more information about CRTSQLxxx commands, see Embedded SQL Programming .)
Run SQL Statements	DFTRDBCOL parameter on the Run SQL Statements (RUNSQLSTM) command. (For more information about the RUNSQLSTM command, see SQL Programming .)
Call Level Interface (CLI) on the server	SQL_ATTR_DEFAULT_LIB or SQL_ATTR_DBC_DEFAULT_LIB environment or connection variables (For more information about CLI, see SQL Call Level Interfaces (ODBC) .)
JDBC or SQLJ on the server using IBM IBM Developer Kit for Java	libraries property object (For more information about JDBC and SQLJ, see IBM Developer Kit for Java .)
ODBC on a client using the IBM i Access Family ODBC Driver	SQL Default Schema in ODBC Setup (For more information about ODBC, see IBM i Access .)
JDBC on a client using the IBM Toolbox for Java	SQL Default Schema in JDBC Setup (For more information about JDBC, see IBM i Access .) (For more information about the IBM Toolbox for Java, see IBM Toolbox for Java .)
OLE DB on a client using the IBM i Access Family OLE DB Provider	DefaultCollection in Connection Object Properties (For more information about OLE DB, see IBM i Access .)
ADO .NET on a client using the IBM i Access Family ADO .NET Provider	DefaultCollection in Connection Object Properties (For more information about ADO .NET, see IBM i Access .)
All interfaces	SET SCHEMA or QSQCHGDC (Change Dynamic Default Collection) API (For more information about QSQCHGDC, see the File APIs category.)

Unqualified function, procedure, specific name, type, and variables

The qualification of function, procedure, specific name, type (built-in types, distinct types, and array types), and variables, depends on the SQL statement in which the unqualified name appears.

- If an unqualified name is the main object of an ALTER, CREATE, COMMENT, LABEL, DROP, GRANT, or REVOKE statement, the name is implicitly qualified using the same rules as for qualifying unqualified table names (See [“Unqualified alias, constraint, external program, index, mask, nodegroup, package, permission, sequence, table, trigger, view, and XSR object names”](#) on page 57).
- Otherwise, the implicit schema name is determined as follows:
 - For type names, database manager searches the SQL path and selects the first schema in the path such that the data type exists in the schema.
 - For variable names, database manager searches the SQL path and selects the first schema in the path such that the schema contains an authorized variable with the same name
 - For procedure names, database manager searches the SQL path and selects the first schema in the path such that the schema contains an authorized procedure with the same name and number of parameters.
 - For function names, database manager uses the SQL path in conjunction with function resolution, as described under [“Function resolution”](#) on page 150.
 - For specific names specified for sourced functions, see [“CREATE FUNCTION \(sourced\)”](#) on page 1008.

SQL names and system names: special considerations

The CL command Override Database File (OVRDBF) can be specified to override an SQL or system name with another object name for local data manipulation SQL statements. Overrides are ignored for data definition SQL statements and data manipulation SQL statements executing at a remote relational database.

See the [Database file management](#) topic for more information about the override function.

Aliases

An *alias* can be thought of as an alternative name for a table, partition of a table, view, or member of a database file. A table or view in an SQL statement can be referenced by its name or by an alias. An alias can refer to a table, partition of a table, view, or database file member within the same or a remote relational database.

An alias can be used wherever a table or view name can be used, except:

- Do not use an alias name where a new table or view name is expected, such as in the CREATE TABLE or CREATE VIEW statements. For example, if an alias name of PERSONNEL is created, then a subsequent statement such as CREATE TABLE PERSONNEL will cause an error.
- An alias that refers to an individual partition of a table or member of a database file can only be used in a select statement, CREATE INDEX, DELETE, INSERT, MERGE, SELECT INTO, SET variable, UPDATE, or VALUES INTO statement.

Aliases can also help avoid using file overrides. Not only does an alias perform better than an override, but an alias is also a permanent object that only need be created once.

An alias can be created even though the object that the alias refers to does not exist. However, the object must exist when a statement that references the alias is executed. A warning is returned if the object does not exist when the alias is created. An alias cannot refer to another alias.

Statements that use three-part names and refer to distributed data, result in DRDA access to the remote relational database. When an application program uses three-part name aliases for remote objects and DRDA access, the application program must be bound at each location that is specified in the three-part names. Also, each alias needs to be defined at the local site. An alias at a remote site can refer to yet another server as long as a referenced alias eventually refers to a table or view.

The option of referring to a table, partition of a table, view, or database file member by an alias name is not explicitly shown in the syntax diagrams or mentioned in the description of the SQL statements.

A new alias cannot have the same fully-qualified name as an existing table, view, index, file, or alias.

The effect of using an alias in an SQL statement is similar to that of text substitution. The alias, which must be defined before the SQL statement is executed, is replaced at statement preparation time by the qualified base table, partition of a table, view, or database file member name. For example, if PBIRD.SALES is an alias for DSPN014.DIST4_SALES_148, then at statement run time:

```
SELECT * FROM PBIRD.SALES
```

effectively becomes

```
SELECT * FROM DSPN014.DIST4_SALES_148
```

The effect of dropping an alias and recreating it to refer to another table depends on the statement that references the alias.

- SQL Data or SQL Data Change statements that refer to that alias will be implicitly rebound when they are next run.
- Indexes that reference the alias are not affected.
- Materialized query tables or views that reference the alias are not affected.

For syntax toleration of existing Db2 for z/OS applications, SYNONYM can be used in place of ALIAS in the CREATE ALIAS and DROP ALIAS statements.

Authorization IDs and authorization names

An *authorization ID* is a character string that is obtained by the database manager when a connection is established between the database manager and either an application process or a program preparation process. It designates a set of privileges. It may also designate a user or a group of users, but this property is not controlled by the database manager.

After a connection has been established, the authorization ID may be changed using the SET SESSION AUTHORIZATION statement.

Authorization ID's are used by the database manager to provide authorization checking of SQL statements.

When the authorization ID of the statement is the owner of the program or service program, that is known as adopted authority. The authorization ID adopts and uses the authority of the program owner in addition to the runtime authorization ID.

Multiple levels of adopted authority are possible when nested calls occur to programs or service programs that use the owner of the program as the statement authorization ID. Adopted authority is tracked at the thread level. The CURRENT USER special register can be used to return the authorization ID of the most recently adopted authority. The enforcement of statement authorization requirements will consider all levels of adopted authority. When a dynamic SQL statement is executed with DYNUSRPRF value of *USER, all levels of adopted authority are suppressed.

An authorization ID applies to every SQL statement. The authorization ID that is used for authorization checking for a static SQL statement depends on the USRPRF value specified on the precompiler command:

- If USRPRF(*OWNER) is specified, or if USRPRF(*NAMING) is specified and SQL naming mode is used, the authorization ID of the statement is the owner of the non-distributed SQL program. For distributed SQL programs, it is the owner of the SQL package.
- If USRPRF(*USER) is specified, or if USRPRF(*NAMING) is specified and system naming mode is used, the authorization ID of the statement is the authorization ID of the user running the non-distributed SQL program. For distributed SQL programs, it is the authorization ID of the user at the current server.

The authorization ID that is used for authorization checking for a dynamic SQL statement also depends on where and how the statement is executed:

- If the statement is prepared and executed from a non-distributed program:
 - If the USRPRF value is *USER and the DYNUSRPRF value is *USER for the program, the authorization ID that applies is the ID of the user running the non-distributed program. This is called the *run-time authorization ID*.
 - If the USRPRF value is *OWNER and the DYNUSRPRF value is *USER for the program, the authorization ID that applies is the ID of the user running the non-distributed program.
 - If the USRPRF value is *OWNER and the DYNUSRPRF value is *OWNER for the program, the authorization ID that applies is the ID of the owner of the non-distributed program.
- If the statement is prepared and executed from a distributed program:
 - If the USRPRF value is *USER and the DYNUSRPRF value is *USER for the SQL package, the authorization ID that applies is the ID of the user running the SQL package at the current server. This is also called the run-time authorization ID.
 - If the USRPRF value is *OWNER and the DYNUSRPRF value is *USER for the SQL package, the authorization ID that applies is the ID of the user running the SQL package at the current server.
 - If the USRPRF value is *OWNER and the DYNUSRPRF value is *OWNER for the SQL package, the authorization ID that applies is the ID of the owner of the SQL package at the current server.
- If the statement is issued interactively, the authorization ID that applies is the ID of the user that issued the Start SQL (STRSQL) command.

- If the statement is executed from the RUNSQLSTM command, the authorization ID that applies is the ID of the user that issued the RUNSQLSTM command.
- If the statement is executed from REXX, the authorization ID that applies is the ID of the user that issued the STRREXPRC command.

On the IBM i operating system, the run-time authorization ID is the user profile of the thread.

An *authorization-name* specified in an SQL statement should not be confused with the authorization ID of the statement. An authorization-name is an identifier that is used in GRANT and REVOKE statements to designate a target of the grant or revoke. The premise of a grant of privileges to *X* is that *X* will subsequently be the authorization ID of statements which require those privileges. A group user profile can also be used when checking authority for an SQL statement. For information about group user profiles, see [Security Reference](#).

Example

Assume SMITH is your user ID; then SMITH is the authorization ID when you execute the following statement interactively:

```
GRANT SELECT ON TDEPT TO KEENE
```

SMITH is the authorization ID of the statement. Thus, the authority to execute the statement is checked against SMITH.

KEENE is an authorization-name specified in the statement. KEENE is given the SELECT privilege on SMITH.TDEPT.

Procedure resolution

Given a procedure invocation, Db2 must decide which of the possible procedures with the same name to execute.

- Let A be the number of arguments in a procedure invocation.
- Let P be the number of parameters in a procedure signature.
- Let N be the number of parameters without a default.

Candidate procedures for resolution of a procedure invocation are selected based on the following criteria:

- Each candidate procedure has a matching name and an applicable number of parameters. An applicable number of parameters satisfies the condition $N \leq A \leq P$.
- Each candidate procedure has parameters such that for each named argument in the CALL statement there exists a parameter with a matching name that does not already correspond to a positional (or unnamed) argument.
- Each parameter of a candidate procedure that does not have a corresponding argument in the CALL statement, specified by either position or name, is defined with a default.
- Each candidate procedure from a set of one or more schemas has the EXECUTE privilege associated with the authorization ID of the CALL statement. The authorities of any objects referenced in a default expression are not considered.

In addition, the set of candidate procedures depends on how the procedure name is qualified.

- If the procedure name is unqualified, procedure resolution is done as follows:

Search all procedures with a schema in the SQL path for candidate procedures. If one or more candidate procedures are found in the schemas of the SQL path, then these candidate procedures are included in the candidate list. If there is a single candidate procedure in the list, resolution is complete. If there are multiple candidate procedures, choose the procedure whose schema is earliest in the SQL path. If there are still multiple candidate procedures, select the candidate procedure with the lowest number of parameters.

If there are no candidate procedures, an error is returned.

- If the procedure name is qualified, procedure resolution is done as follows:

Search within the schema specified by the qualifier for candidate procedures. If a single candidate procedure exists, resolution is complete. If there are multiple candidate procedures, choose the candidate procedure with the lowest number of parameters and resolution is complete. If the schema does not exist or there are no authorized candidate procedures, an error is returned.

Example 1: There are six FOO procedures, in four different schemas, registered as follows (note that not all required keywords appear):

```
CREATE PROCEDURE AUGUSTUS.FOO (INT) SPECIFIC FOO_1 ...
CREATE PROCEDURE AUGUSTUS.FOO (DOUBLE, DECIMAL(15, 3)) SPECIFIC FOO_2 ...
CREATE PROCEDURE JULIUS.FOO (INT) SPECIFIC FOO_3 ...
CREATE PROCEDURE JULIUS.FOO (INT, INT, INT) SPECIFIC FOO_4 ...
CREATE PROCEDURE CAESAR.FOO (INT, INT) SPECIFIC FOO_5 ...
CREATE PROCEDURE NERO.FOO (INT,INT) SPECIFIC FOO_6 ...
```

The procedure reference is as follows (where I1 and I2 are INTEGER values):

```
CALL FOO(I1, I2)
```

Assume that the application making this reference has an SQL path established as:

```
"JULIUS", "AUGUSTUS", "CAESAR"
```

Following through the algorithm, the procedure with specific name FOO_6 is eliminated as a candidate, because the schema "NERO" is not included in the SQL path. FOO_1, FOO_3, and FOO_4 are eliminated as

candidates, because they have the wrong number of parameters. The remaining candidates are considered in order, as determined by the SQL path. Note that the types of the arguments and parameters are ignored. The parameters of FOO_5 exactly match the arguments in the CALL, but FOO_2 is chosen because "AUGUSTUS" appears before "CAESAR" in the SQL path.

Example 2: The following examples illustrate procedure resolution using named parameters in the CALL statement:

```
CREATE PROCEDURE p1(i1 INT)...  
CREATE PROCEDURE p1(i1 INT DEFAULT 0, i2 INT DEFAULT 0)...  
  
CALL p1(i2=>1)
```

Since the argument names are taken into consideration during the candidate selection process, only the second version of p1 will be considered a candidate. Furthermore, it can be successfully called because i1 in this version of p1 is defined with a default, so only specifying i2 on the call to p1 is valid. The procedure will be passed a value of 0 for parameter i1.

```
CREATE PROCEDURE p2(i1 INT, i2 INT DEFAULT 0)...  
CREATE PROCEDURE p2(i1 INT DEFAULT 0, i2 INT DEFAULT 0, i3 INT DEFAULT 0)...  
  
CALL p2(i2=>1)
```

One of the criteria for a procedure parameter which does not have a corresponding argument in the CALL statement (specified by either position or name) is that the parameter is defined with a default value. Therefore, the first version of p2 is not considered a candidate since parameter i1 does not have a default defined. The second version of p2 will be selected and the default values for the first and third parameters will be passed.

Data types

The smallest unit of data that can be manipulated in SQL is called a *value*.

How values are interpreted depends on the *attributes* of their source, which includes the data type, length, precision, scale, and CCSID. The sources of values are:

- Columns
- Constants
- Expressions
- Functions
- Special registers
- Variables (such as host variables, SQL variables, global variables, parameter markers and parameters of routines)

The Db2 relational database products support both built-in data types and user-defined data types. This section describes the built-in data types. For a description of distinct types, see [“User-defined types” on page 82](#).

The following figure illustrates the various built-in data types supported by Db2 for i.

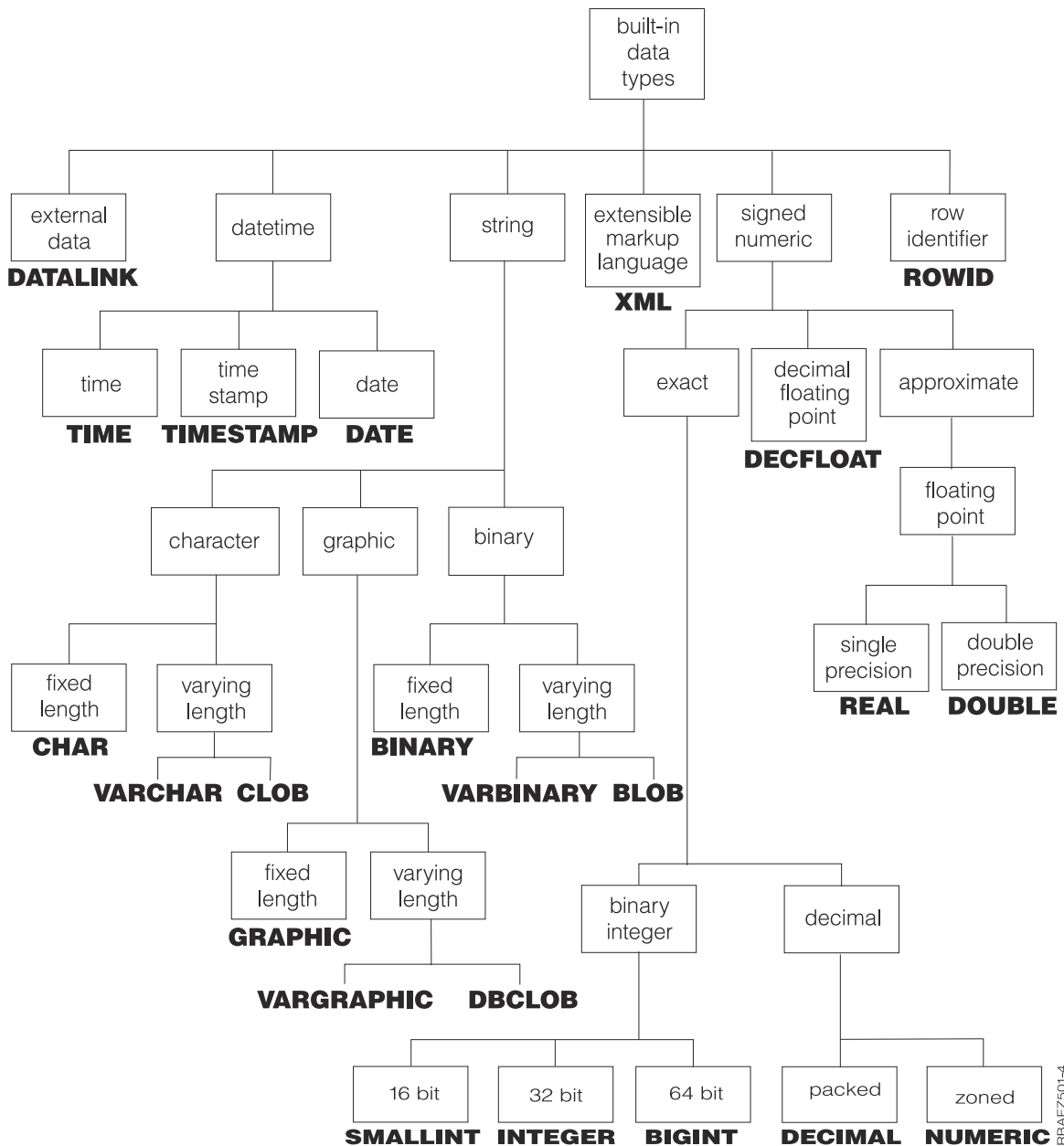

For information about specifying the data types of columns, see [“CREATE TABLE”](#) on page 1105.

Nulls

All data types include the null value. Distinct from all non-null values, the null value is a special value that denotes the absence of a (non-null) value.

Except for grouping operations, a null value is also distinct from another null value. Although all data types include the null value, some sources of values cannot provide the null value. For example, constants and columns that are defined as NOT NULL cannot contain null values, the COUNT and COUNT_BIG functions cannot return a null value, and ROWID columns cannot store a null value although a null value can be returned for a ROWID column as the result of a query.

Numbers

The numeric data types are binary integer, decimal, decimal floating-point, and floating-point.

The numeric data types are categorized as follows:

- Exact numerics: binary integer and decimal
- Decimal floating-point
- Approximate numerics: floating-point

Binary integer includes small integer, large integer, and big integer. Binary numbers are exact representations of integers. Decimal numbers are exact representations of numbers with a fixed precision and scale. Binary and decimal numbers are considered exact numeric types.

Decimal floating-point numbers can have a precision of 16 or 34. Decimal floating-point supports both exact representations of real numbers and approximations of real numbers and so is not considered either an exact numeric type or an approximate numeric type.

Floating-point includes single precision and double precision. Floating-point numbers are approximations of real numbers and are considered approximate numeric types.

All numbers have a *sign*, a *precision*, and a *scale*. For all numbers except decimal floating-point, if a column or expression is zero, the sign is positive. Decimal floating-point numbers include negative and positive zeros. Decimal floating-point has distinct values for a number and the same number with various exponents (for example: 0.0, 0.00, 0.0E5, 1.0, 1.00, 1.0000). The precision is the total number of digits excluding the sign. The scale is the total number of digits to the right of the decimal point. If there is no decimal point, the scale is zero.

Small integer

A *small integer* is a binary number composed of 2 bytes with a precision of 5 digits. The range of small integers is -32 768 to +32 767.

For small integers, decimal precision and scale are supported by COBOL, RPG, and IBM i system files. For information concerning the precision and scale of binary integers, see the [DDS Reference](#) topic.

Large integer

A *large integer* is a binary number composed of 4 bytes with a precision of 10 digits. The range of large integers is -2 147 483 648 to +2 147 483 647.

For large integers, decimal precision and scale are supported by COBOL, RPG, and IBM i system files. For information concerning the precision and scale of binary integers, see the [DDS Reference](#) topic.

Big integer

A *big integer* is a binary number composed of 8 bytes with a precision of 19 digits. The range of big integers is -9 223 372 036 854 775 808 to +9 223 372 036 854 775 807.

Decimal

A *decimal* value is a packed decimal or zoned decimal number with an implicit decimal point. The position of the decimal point is determined by the precision and the scale of the number. The scale, which is the number of digits in the fractional part of the number, cannot be negative or greater than the precision. The maximum precision is 63 digits.

All values of a decimal column have the same precision and scale. The range of a decimal variable or the numbers in a decimal column is $-n$ to $+n$, where the absolute value of n is the largest number that can be represented with the applicable precision and scale.

The maximum range is negative $10^{63}+1$ to 10^{63} minus 1.

Floating-point

A *single-precision floating-point* number is a 32-bit approximate representation of a real number. The range of magnitude is approximately $1.17549436 \times 10^{-38}$ to $3.40282356 \times 10^{38}$.

A *double-precision floating-point* number is a IEEE 64-bit approximate representation of a real number. The range of magnitude is approximately $2.2250738585072014 \times 10^{-308}$ to $1.7976931348623158 \times 10^{308}$.

Single-precision floating-point is generally accurate to 7 digits of precision. Double-precision floating-point is generally accurate to 15 digits of precision.

Decimal floating-point

A *decimal floating-point* number is an IEEE 754R number with a decimal point. The position of the decimal point is stored in each decimal floating-point value. The maximum precision is 34 digits. The range of a decimal floating-point number is either 16 or 34 digits of precision, and an exponent range of 10^{-383} to 10^{384} or 10^{-6143} to 10^{6144} respectively.

The minimum exponent, E_{\min} , for DECFLOAT values is -383 for DECFLOAT(16) and -6143 for DECFLOAT(34). The maximum exponent, E_{\max} , for DECFLOAT values is 384 for DECFLOAT(16) and 6144 for DECFLOAT(34).

In addition to the finite numbers, decimal floating-point numbers can also represent the following three special values (see “[Decimal floating-point constants](#)” on page 114 for more information):

- Infinity - A value that represents a number whose magnitude is infinitely large.
- Quiet NaN - A value that represents undefined results which does not cause an invalid number warning.
- Signaling NaN - A value that represents undefined results which will cause an invalid number warning if used in any numerical operation.²¹

When a number has one of these special values, its coefficient and exponent are undefined. The sign of an infinity is significant (that is, it is possible to have both positive and negative infinity). The sign of a NaN has no meaning for arithmetic operations.

See [Table 122](#) on page 1636 for more information.

Numeric variables

Small and large binary integer variables can be used in all host languages. Big integer variables can only be used in C, C++, ILE COBOL, and ILE RPG. Floating-point variables can be used in all host languages except RPG/400[®] and COBOL/400. Decimal variables can be used in all supported host languages. Decimal floating-point variables can only be used in C.

String representations of numeric values

When a decimal, decimal floating-point, or floating-point number is cast to a string (for example, using a CAST specification) the implicit decimal point is replaced by the default decimal separator character in effect when the statement was prepared. When a string is cast to a decimal, decimal floating-point, or floating-point value (for example, using a CAST specification), the default decimal separator character in effect when the statement was prepared is used to interpret the string.

Subnormal numbers and underflow

The decimal floating-point data type has a set of non-zero numbers that fall outside the range of normal decimal floating-point values. These numbers are called subnormal.

Non-zero numbers whose adjusted exponents are less than E_{\min} (-6143 for DECFLOAT(34) or -383 for DECFLOAT(16)), are called subnormal numbers. These subnormal numbers are accepted as operands for all operations and may result from any operation. If a result is subnormal before any rounding, the subnormal warning is returned.²²

²¹ The warning is only returned if *YES is specified for the SQL_DECFLOAT_WARNINGS query option.

²² The warning is only returned if *YES is specified for the SQL_DECFLOAT_WARNINGS query option.

For a subnormal result, the minimum value of the exponent becomes $E_{\min} - 1$, called E_{tiny} , where precision is the precision of the decimal floating-point number. Hence, the smallest value of the exponent $E_{\text{tiny}} = -6176$ for DECFloat(34) and -398 for DECFloat(16). As the exponent E_{tiny} gets smaller, the number of digits available in the mantissa also decreases. The number of digits available in the mantissa for subnormal numbers is $(\text{precision} - (-E_{\text{tiny}} + E_{\min}))$.

The result will be rounded, if necessary, to ensure that the exponent is no smaller than E_{tiny} . If, during this rounding, the result becomes inexact, an underflow warning is returned.²² A subnormal result does not always return the underflow warning but will always return the subnormal warning.

When a number underflows to zero during a calculation, its exponent will be E_{tiny} . The maximum value of the exponent is unaffected.

The maximum value of the exponent for subnormal numbers is the same as the minimum value of the exponent which can arise during operations that do not result in subnormal numbers. This occurs where the length of the coefficient in decimal digits is equal to the precision.

Character strings

A *character string* is a sequence of bytes. The length of the string is the number of bytes in the sequence. If the length is zero, the value is called the *empty string*. The empty string should not be confused with the null value.

Fixed-length character strings

When fixed-length character string distinct types, columns, and variables are defined, the length attribute is specified and all values have the same length. For a fixed-length character string, the length attribute must be between 1 through 32766 inclusive. See [Appendix A, “SQL limits,” on page 1635](#) for more information.

Varying-length character strings

The types of varying-length character strings are:

- VARCHAR
- CLOB

A *Character Large Object* (CLOB) column is useful for storing large amounts of character data, such as documents written using a single character set.

Distinct types, columns, and variables all have length attributes. When varying-length character-string distinct types, columns, and variables are defined, the maximum length is specified and this becomes the length attribute. Actual values may have a smaller length. For a varying-length character string, the length attribute must be between 1 through 32 740 inclusive. For a CLOB string, the length attribute must be between 1 through 2 147 483 647 inclusive. See [Appendix A, “SQL limits,” on page 1635](#) for more information.

For the restrictions that apply to the use of long varying-length strings, see [“Limitations on use of strings” on page 74](#).

Character-string variables

- Fixed-length character-string variables can be used in all host languages except REXX and Java. (In C or C++, fixed-length character-string variables are limited to a length of 1.)
- VARCHAR varying-length character-string variables can be used in C, C++, COBOL, PL/I, REXX, and RPG:
 - In PL/I, REXX, and ILE RPG, there is a varying-length character-string data type.
 - In COBOL, C, and C++ varying-length character strings are represented as structures.

- In C and C++, varying-length character-string variables can also be represented by NUL-terminated strings.
- In RPG/400, varying-length character-string variables can only be represented by VARCHAR columns included as a result of an externally described data structure.
- CLOB varying-length character-string variables can be defined in all host languages except REXX, RPG/400, and COBOL/400.
 - In ILE RPG, a CLOB varying-length character string is declared using the SQLTYPE keyword.
 - In all other languages, an SQL TYPE IS CLOB clause is used.

Character encoding schemes

Each character string is further defined as one of four types.

Bit data

Data that is not associated with a coded character set and is therefore never converted. The CCSID for bit data is 65535.

Note: Bit data is a form of character data. The pad character is a blank for assignments to bit data; the pad character is X'00' for assignments to binary data. It is recommended that the binary data type be used instead of character for bit data.

SBCS data

Data in which every character is represented by a single byte. Each SBCS data character string has an associated CCSID. If necessary, an SBCS string is converted before it is used in an operation with a character string that has a different CCSID.

Mixed data

Data that may contain a mixture of characters from a single-byte character set (SBCS) and a double-byte character set (DBCS). Each mixed string has an associated CCSID. If necessary, a mixed data character string is converted before an operation with a character string that has a different CCSID. If mixed data contains a DBCS character, it cannot be converted to SBCS data.

Unicode data

Data that contains characters represented by one or more bytes. Each Unicode character string is encoded using UTF-8. The CCSID for UTF-8 is 1208.

The database manager does not recognize subclasses of double-byte characters, and it does not assign any specific meaning to particular double-byte codes. However, if you choose to use mixed data, then two single-byte EBCDIC codes are given special meanings:

- X'0E', the “shift-out” character, is used to mark the beginning of a sequence of double-byte codes.
- X'0F', the “shift-in” character, is used to mark the end of a sequence of double-byte codes.

In order for the database manager to recognize double-byte characters in a mixed data character string, the following condition must be met:

- Within the string, the double-byte characters must be enclosed between paired shift-out and shift-in characters.

The pairing is detected as the string is read from left to right. The code X'0E' is recognized as a shift out character if X'0F' occurs later; otherwise, it is invalid. The first X'0F' following the X'0E' that is on a double-byte boundary is the paired shift-in character. Any X'0F' that is not on a double-byte boundary is not recognized.

There must be an even number of bytes between the paired characters, and each pair of bytes is considered to be a double-byte character. There can be more than one set of paired shift-out and shift-in characters in the string.

The length of a mixed data character string is its total number of bytes, counting two bytes for each double-byte character and one byte for each shift-out or shift-in character.

When the job CCSID indicates that DBCS is allowed, CREATE TABLE will create character columns as DBCS-Open fields, unless FOR BIT DATA, FOR SBCS DATA, or an SBCS CCSID is specified. The SQL user

will see these as character fields, but the system database support will see them as DBCS-Open fields. For a definition of a DBCS-Open field, see the [Database programming](#) topic collection.

Graphic strings

A *graphic string* is a sequence of double-byte characters. The length of the string is the number of its characters. Like character strings, graphic strings can be empty.

Fixed-length graphic strings

When fixed-length graphic-string distinct types, columns, and variables are defined, the length attribute is specified and all values have the same length. For a fixed-length graphic string, the length attribute must be between 1 through 16 383 inclusive. See [Appendix A, “SQL limits,”](#) on page 1635 for more information.

Varying-length graphic strings

- The types of varying-length graphic strings are:
- VARGRAPHIC
- DBCLOB

A *Double-Byte Character Large Object* (DBCLOB) column is useful for storing large amounts of double-byte character data, such as documents written using a double-byte character set.

Distinct types, columns, and variables all have length attributes. When varying-length graphic-string distinct types, columns, and variables are defined, the maximum length is specified and this becomes the length attribute. Actual values may have a smaller length. For a varying-length graphic string, the length attribute must be between 1 through 16 370 inclusive. For a DBCLOB string, the length attribute must be between 1 through 1 073 741 823 inclusive. See [Appendix A, “SQL limits,”](#) on page 1635 for more information.

For the restrictions that apply to the use of long varying-length strings, see [“Limitations on use of strings”](#) on page 74.

Graphic-string variables

- Fixed-length graphic-string variables can be defined in C, C++, ILE COBOL, and ILE RPG. (In C and C++, fixed-length graphic-string variables are limited to a length of 1.)

Although fixed-length graphic-string variables cannot be defined in PL/I, COBOL/400, and RPG/400, a character-string variable will be treated like a fixed-length graphic-string variable if it was generated in the source from a GRAPHIC column in the external definition of a file.

- VARGRAPHIC varying-length graphic-string variables can be defined in C, C++, ILE COBOL, REXX, and ILE RPG.
 - In REXX and ILE RPG, there is a varying-length graphic-string data type.
 - In C, C++, and ILE COBOL, varying-length graphic strings are represented as structures.
 - In C and C++, varying-length graphic-string variables can also be represented by NUL-terminated graphic strings.
 - Although varying-length graphic-string variables cannot be defined in PL/I, COBOL/400, and RPG/400, a character-string variable will be treated like a varying-length graphic-string variable if it was generated in the source from a VARGRAPHIC column in the external definition of a file.
- DBCLOB varying-length character-string variables can be defined in all host languages except REXX, RPG/400, and COBOL/400.
 - In ILE RPG, a DBCLOB varying-length character string is declared using the SQLTYPE keyword.
 - In all other languages, an SQL TYPE IS DBCLOB clause is used.

Graphic encoding schemes

Each graphic string is further defined as one of two types.

DBCS data

Data in which every character is represented by a character from the double-byte character set (DBCS) that does not include the shift-out or shift-in characters.

Every DBCS graphic string has a CCSID that identifies a double-byte coded character set. If necessary, a DBCS graphic string is converted before it is used in an operation with a DBCS graphic string that has a different DBCS CCSID.

Unicode data

Data that contains characters represented by two or more bytes. Each Unicode graphic string is encoded using either UCS-2 or UTF-16. UCS-2 is a subset of UTF-16. The CCSID for UCS-2 is 13488. The CCSID for UTF-16 is 1200.

NCHAR, NVARCHAR, and NCLOB are synonyms for Unicode graphic data with a CCSID of 1200.

When graphic-string variables are not explicitly tagged with a CCSID, the associated DBCS CCSID for the job CCSID is used. If no associated DBCS CCSID exists, the variable is tagged with 65535. A graphic-string variable is never implicitly tagged with a UTF-16 or UCS-2 CCSID. See the DECLARE VARIABLE statement for information on how to tag a graphic variable with a CCSID.

Binary strings

A *binary string* is a sequence of bytes. Unlike a character string which usually contains text data, a binary string is used to hold non-traditional data such as pictures. The length of a binary string is the number of bytes in the sequence. A binary string has a CCSID of 65535. Only character strings of FOR BIT DATA are compatible with binary strings.

Fixed-length binary strings

When fixed-length binary-string distinct types, columns, and variables are defined, the length attribute is specified and all values have the same length. For a fixed-length binary string, the length attribute must be between 1 through 32 766 inclusive. See [Appendix A, “SQL limits,” on page 1635](#) for more information.

Varying-length binary strings

The types of varying-length binary strings are:

- VARBINARY
- BLOB

A *Binary Large Object* (BLOB) column is useful for storing large amounts of noncharacter data, such as pictures, voice, and mixed media. Another use is to hold structured data for exploitation by distinct types and user-defined functions.

Distinct types, columns, and variables all have length attributes. When varying-length binary-string distinct types, columns, and variables are defined, the maximum length is specified and this becomes the length attribute. Actual values may have a smaller length. For a varying-length binary string, the length attribute must be between 1 through 32 740 bytes inclusive. For a BLOB string, the length attribute must be between 1 through 2 147 483 647 inclusive. See [Appendix A, “SQL limits,” on page 1635](#) for more information.

Binary-string variables

A variable with a binary string type can be defined in all host languages except REXX, RPG/400, and COBOL/400.

- BINARY fixed-length binary-string variables can be defined in all host languages except REXX, RPG/400, and COBOL/400.

- In ILE RPG, a BINARY fixed-length binary-string variable is declared using the SQLTYPE keyword.
- In all other languages, an SQL TYPE IS BINARY clause is used.
- VARBINARY varying-length binary-string variables can be defined in all host languages except REXX, RPG/400, and COBOL/400.
 - In ILE RPG, a VARBINARY varying-length binary-string variable is declared using the SQLTYPE keyword.
 - In all other languages, an SQL TYPE IS VARBINARY clause is used.
- BLOB varying-length binary-string variables can be defined in all host languages except REXX, RPG/400, and COBOL/400.
 - In ILE RPG, a BLOB varying-length binary-string variable is declared using the SQLTYPE keyword.
 - In all other languages, an SQL TYPE IS BLOB clause is used.

Large objects

The term *large object* and the generic acronym *LOB* are used to refer to any CLOB, DBCLOB, or BLOB data type.

Manipulating large objects with locators

Since LOB values can be very large, the transfer of these values from the database server to client application program variables can be time consuming. Also, application programs typically process LOB values a piece at a time, rather than as a whole. For these cases, the application can reference a LOB value via a large object locator (LOB locator).²³

A *large object locator* or LOB locator is a variable with a value that represents a single LOB value in the database server. LOB locators were developed to provide users with a mechanism by which they could easily manipulate very large objects in application programs without requiring them to store the entire LOB value on the client machine where the application program may be running.

For example, when selecting a LOB value, an application program could select the entire LOB value and place it into an equally large variable (which is acceptable if the application program is going to process the entire LOB value at once), or it could instead select the LOB value into a LOB locator. Then, using the LOB locator, the application program can issue subsequent database operations on the LOB value by supplying the locator value as input. The resulting output of the locator operation, for example the amount of data assigned to a client variable, would then typically be a small subset of the input LOB value.

LOB locators may also represent more than just base values; they can also represent the value associated with a LOB expression. For example, a LOB locator might represent the value associated with:

```
SUBSTR(lob_value_1 CONCAT lob_value_2 CONCAT lob_value_3, 42, 6000000)
```

For non-locator-based host variables in an application program, when a null value is selected into that host variable, the indicator variable is set to -1, signifying that the value is null. In the case of LOB locators, however, the meaning of indicator variables is slightly different. Since a LOB locator host variable itself can never be null, a negative indicator variable value indicates that the LOB value represented by the LOB locator is null. The null information is kept local to the client by virtue of the indicator variable value -- the server does not track null values with valid LOB locators.

It is important to understand that a LOB locator represents a value, not a row or location in the database. Once a value is selected into a LOB locator, there is no operation that one can perform on the original row or table that will affect the value which is referenced by the LOB locator. The value associated with a LOB locator is valid until the transaction ends, or until the LOB locator is explicitly freed, whichever comes first.

A LOB locator is only a mechanism used to refer to a LOB value during a transaction; it does not persist beyond the transaction in which it was created. Also, it is not a database type; it is never stored in the

²³ There is no ability within a Java application to distinguish between a CLOB or BLOB that is represented by a LOB locator and one that is not.

database and, as a result, cannot participate in views or check constraints. However, since a locator is a representation of a LOB type, there are SQLTYPEs for LOB locators so that they can be described within an SQLDA structure that is used by FETCH, OPEN, CALL, and EXECUTE statements.

For the restrictions that apply to the use of LOB strings, see [“Limitations on use of strings” on page 74](#).

Limitations on use of strings

Some varying-length string data types cannot be referenced in certain contexts.

The following varying-length string data types cannot be referenced in certain contexts:

- for character strings, any CLOB string
- for graphic strings, any DBCLOB string
- for binary strings, any BLOB string.

Table 7. Contexts for limitations on use of varying-length strings

Context of usage	LOB (CLOB, DBCLOB, or BLOB)
The CREATE INDEX statement	Not allowed
The definition of primary, unique, and foreign keys	Not allowed
Parameters of built-in functions	Some functions that allow varying-length character strings, varying-length graphic strings, or both types of strings as input arguments do not support CLOB or DBCLOB strings, or both as input. See the description of the individual functions in Chapter 4, “Built-in functions,” on page 245 for the data types that are allowed as input to each function.

Datetime values

Although datetime values can be used in certain arithmetic and string operations and are compatible with certain strings, they are neither strings nor numbers.

However, strings can represent datetime values; see [“String representations of datetime values” on page 75](#).

Date

A *date* is a three-part value (year, month, and day) designating a point in time under the Gregorian calendar, which is assumed to have been in effect from the year 1 A.D.

The range of the year part is 0001 to 9999.²⁴ The date formats *JUL, *MDY, *DMY, and *YMD can only represent dates in the range 1940 through 2039. The range of the month part is 1 to 12. The range of the day part is 1 to x, where x is 28, 29, 30, or 31, depending on the month and year.

The internal representation of a date is a string of 4 bytes that contains an integer. The integer (called the Scaliger number) represents the date.

The length of a DATE column as described in the SQLDA is 6, 8, or 10 bytes, depending on which format is used. These are the appropriate lengths for string representations for the value.

²⁴ Note that historical dates do not always follow the Gregorian calendar. Dates between 1582-10-04 and 1582-10-15 are accepted as valid dates although they never existed in the Gregorian calendar.

Time

A *time* is a three-part value (hour, minute, and second) designating a time of day using a 24-hour clock.

The range of the hour part is 0 to 24, while the range of the minute and second parts is 0 to 59. If the hour is 24, the minute and second specifications are both zero.

The internal representation of a time is a string of 3 bytes. Each byte consists of two packed decimal digits. The first byte represents the hour, the second byte the minute, and the last byte the second.

The length of a TIME column as described in the SQLDA is 8 bytes, which is the appropriate length for a string representation of the value.

Timestamp

A *timestamp* is a six or seven part value (year, month, day, hour, minute, second, and optional fractional second) that represents a date and time.

The time portion of a timestamp value can include a specification of fractional seconds. The number of digits in the fractional seconds is specified using an attribute in the range from 0 to 12 with a default of 6

The internal representation of a timestamp is a string of between 7 and 13 bytes. The first 4 bytes represent the date, the next 3 bytes the time, and the last 0 to 6 bytes the fractional seconds.

Datetime variables

Character string variables are normally used to contain date, time, and timestamp values.

The ILE RPG and ILE COBOL precompilers support datetime variables.

Date, time, and timestamp variables can also be specified in Java as `java.sql.Date`, `java.sql.Time`, and `java.sql.Timestamp`, respectively.

String representations of datetime values

Values whose data types are DATE, TIME, or TIMESTAMP are represented in an internal form that is transparent to the user of SQL. Dates, times, and timestamps, however, can also be represented by character or Unicode graphic strings.

To be retrieved, a datetime value can be assigned to a string variable. The format of the resulting string will depend on the *default date format* and the *default time format* in effect when the statement was prepared. The default date and time formats are set based on the date format (DATFMT), the date separator (DATSEP), the time format (TIMFMT), and the time separator (TIMSEP) parameters.

When a valid string representation of a datetime value is used in an operation with an internal datetime value, the string representation is converted to the internal form of the date, time, or timestamp before the operation is performed. The *default date format* and *default time format* specifies the date and time format that will be used to interpret the string. If the CCSID of the string represents a foreign encoding scheme (for example, ASCII), it is first converted to the coded character set identified by the default CCSID before the string is converted to the internal form of the datetime value.

The following sections define the valid string representations of datetime values.

Date strings

A string representation of a date is a character or a Unicode graphic string that starts with a digit and has a length of at least 6 characters. Trailing blanks can be included. Leading zeros can be omitted from the month and day portions when using the IBM SQL standard formats. Each IBM SQL standard format is identified by name and includes an associated abbreviation (for use by the CHAR function). Other formats do not have an abbreviation to be used by the CHAR function. The separators for two-digit year formats are controlled by the date separator (DATSEP) parameter.

Valid string formats for dates are listed in [Table 8 on page 76](#).

The database manager recognizes the string as a date when it is in one of the following formats:

- In the format specified by the default date format
- In one of the IBM SQL standard date formats
- In the unformatted Julian format

Table 8. Formats for String Representations of Dates

Format Name	Abbreviation	Date Format	Example
International Standards Organization (*ISO)	ISO	'yyyy-mm-dd'	'1987-10-12'
IBM USA standard (*USA)	USA	'mm/dd/yyyy'	'10/12/1987'
IBM European standard (*EUR)	EUR	'dd.mm.yyyy'	'12.10.1987'
Japanese industrial standard Christian era (*JIS)	JIS	'yyyy-mm-dd'	'1987-10-12'
Unformatted Julian	–	'yyyyddd'	'1987285'
Julian (*JUL)	–	'yy/ddd'	'87/285'
Month, day, year (*MDY)	–	'mm/dd/yy'	'10/12/87'
Day, month, year (*DMY)	–	'dd/mm/yy'	'12/10/87'
Year, month, day (*YMD)	–	'yy/mm/dd'	'87/12/10'

The default date format can be specified through the following interfaces:

Table 9. Default Date Format Interfaces

SQL Interface	Specification
Embedded SQL	<p>The DATFMT and DATSEP parameters are specified on the Create SQL Program (CRTSQLxxx) commands. The SET OPTION statement can also be used to specify the DATFMT and DATSEP parameters within the source of a program containing embedded SQL.</p> <p>(For more information about CRTSQLxxx commands, see the Embedded SQL programming topic collection.)</p>
Interactive SQL and Run SQL Statements	<p>The DATFMT and DATSEP parameters on the Start SQL (STRSQL) command or by changing the session attributes. The DATFMT and DATSEP parameters on the Run SQL Statements (RUNSQLSTM) command.</p> <p>(For more information about STRSQL and RUNSQLSTM commands, see SQL programming.)</p>
Call Level Interface (CLI) on the server	<p>SQL_ATTR_DATE_FMT and SQL_ATTR_DATE_SEP environment or connection variables</p> <p>(For more information about CLI, see SQL Call Level Interfaces (ODBC).)</p>
JDBC or SQLJ on the server using IBM IBM Developer Kit for Java	<p>Date Format and Date Separator connection property</p> <p>(For more information about JDBC and SQLJ, see IBM Developer Kit for Java.)</p>

Table 9. Default Date Format Interfaces (continued)

SQL Interface	Specification
ODBC on a client using the IBM i Access Family ODBC Driver	Date Format and Date Separator in the Advanced Server Options in ODBC Setup (For more information about ODBC, see IBM i Access .)
JDBC on a client using the IBM Toolbox for Java	Format in JDBC Setup (For more information about JDBC, see IBM i Access .) (For more information about the IBM Toolbox for Java, see IBM Toolbox for Java .)

Time strings

A string representation of a time is a character or a Unicode graphic string that starts with a digit and has a length of at least 4 characters. Trailing blanks can be included; a leading zero can be omitted from the hour part of the time and seconds can be omitted entirely. If you choose to omit seconds, an implicit specification of 0 seconds is assumed. Thus, 13.30 is equivalent to 13.30.00.

Valid string formats for times are listed in [Table 10 on page 77](#). Each IBM SQL standard format is identified by name and includes an associated abbreviation (for use by the CHAR function). The other format (*HMS) does not have an abbreviation to be used by the CHAR function. The separator for the *HMS format is controlled by the time separator (TIMSEP) parameter.

The database manager recognizes the string as a time when it is in one of the following formats:

- In the format specified by the default time format
- In one of the IBM SQL standard time formats

Table 10. Formats for String Representations of Times

Format Name	Abbreviation	Time Format	Example
International Standards Organization (*ISO)	ISO	'hh.mm.ss' ²⁵	'13.30.05'
IBM USA standard (*USA)	USA	'hh:mm AM' (or PM)	'1:30 PM'
IBM European standard (*EUR)	EUR	'hh.mm.ss'	'13.30.05'
Japanese industrial standard Christian era (*JIS)	JIS	'hh:mm:ss'	'13:30:05'
Hours, minutes, seconds (*HMS)	–	'hh:mm:ss'	'13:30:05'

The following additional rules apply to the USA time format:

- The hour must not be greater than 12 and cannot be 0 except for the special case of 00:00 AM.
- A single space character exists between the minutes portion of the time of day and the AM or PM.
- The minutes can be omitted entirely. If you choose to omit the minutes, an implicit specification of 0 minutes is assumed.

In the USA format, using the ISO format of the 24-hour clock, the correspondence between the USA format and the 24-hour clock is as follows:

²⁵ This is an earlier version of the ISO format. JIS can be used to get the current ISO format.

Table 11. USA Time Format

USA Format	24-Hour Clock
12:01 AM through 12:59 AM	00.01.00 through 00.59.00
01:00 AM through 11:59 AM	01:00.00 through 11:59.00
12:00 PM (noon) through 11:59 PM	12:00.00 through 23.59.00
12:00 AM (midnight)	24.00.00
00:00 AM (midnight)	00.00.00

The default time format can be specified through the following interfaces:

Table 12. Default Time Format Interfaces

SQL Interface	Specification
Embedded SQL	<p>The TIMFMT and TIMSEP parameters are specified on the Create SQL Program (CRTSQLxxx) commands. The SET OPTION statement can also be used to specify the TIMFMT and TIMSEP parameters within the source of a program containing embedded SQL.</p> <p>(For more information about CRTSQLxxx commands, see the Embedded SQL programming topic collection.)</p>
Interactive SQL and Run SQL Statements	<p>The TIMFMT and TIMSEP parameters on the Start SQL (STRSQL) command or by changing the session attributes. The TIMFMT and TIMSEP parameters on the Run SQL Statements (RUNSQLSTM) command.</p> <p>(For more information about STRSQL and RUNSQLSTM commands, see the SQL programming topic collection.)</p>
Call Level Interface (CLI) on the server	<p>SQL_ATTR_TIME_FMT and SQL_ATTR_TIME_SEP environment or connection variables</p> <p>(For more information about CLI, see the SQL Call Level Interfaces (ODBC) topic collection.)</p>
JDBC or SQLJ on the server using IBM IBM Developer Kit for Java	<p>Time Format and Time Separator connection property object</p> <p>(For more information about JDBC and SQLJ, see the IBM Developer Kit for Java topic collection.)</p>
ODBC on a client using the IBM i Access Family ODBC Driver	<p>Time Format and Time Separator in the Advanced Server Options in ODBC Setup</p> <p>(For more information about ODBC, see the IBM i Access Family topic collection.)</p>
JDBC on a client using the IBM Toolbox for Java	<p>Format in JDBC Setup</p> <p>(For more information about the IBM Toolbox for Java, see IBM Toolbox for Java topic collection.)</p>

Timestamp strings

A string representation of a timestamp is a character or a Unicode graphic string that starts with a digit and has a length of at least 14 characters.

The complete string representation of a timestamp has one of the following forms:

Table 13. Formats for String Representations of Timestamps

Format Name	Time Format	Example
ISO timestamp	'yyyy-mm-dd hh:mm:ss.nnnnnnnnnnnn'	'1990-03-02 08:30:00.010000000000'
IBM SQL	'yyyy-mm-dd-hh.mm.ss.nnnnnnnnnnnn'	'1990-03-02-08.30.00.010000000000'
14-26 character form	'yyyymmddhhmssnnnnnnnnnnn'	'19900302083000'

The following rules apply:

- Leading blanks are not allowed.
- Trailing blanks can be included.
- Leading zeros can be omitted from the month, day, hour, minute, and second part of the timestamp when using the timestamp form with separators. An implicit specification of 0 is assumed for any digit that is omitted.
- The hour can be 24 if the minutes, seconds, and any fractional seconds are all zeros.
- Trailing zeros can be truncated or omitted entirely from fractional seconds.
- The number of digits of fractional seconds can vary from 0 to 12. An implicit specification of 0 is assumed if fractional seconds are omitted.
- The separator character that follows the seconds element can be omitted if fractional seconds are not included.

If a string representation of a timestamp is implicitly cast to a value with a `TIMESTAMP` data type, the timestamp precision of the result of the cast is determined by the operation. Digits in the string beyond the timestamp precision of the cast are truncated or any missing digits needed to reach the timestamp precision of the cast are assumed to be zeros. For example `1990-3-2-8.30.00` is equivalent to `1990-03-02-8.30.00.000000000000`. A string representation of a timestamp can be given a different timestamp precision by explicitly casting the value to a timestamp with a specified precision. In the case of a constant, the precision can be maintained by preceding the string with the `TIMESTAMP` keyword. For example, `TIMESTAMP '2007-03-28-14.50.35.123'` has the `TIMESTAMP(3)` data type.

XML Values

An XML value represents well-formed XML in the form of an XML document, XML content, or an XML sequence.

An XML value that is stored in a table as a value of a column defined with the XML data type must be a well-formed XML document. XML values are processed in an internal representation that is not comparable to any string value including another XML value. The only predicate that can be applied to the XML data type is the IS NULL predicate.

An XML value can be transformed into a serialized string value representing an XML document using the XMLSERIALIZE function. Similarly, a string value that represents an XML document can be transformed into an XML value using the XMLPARSE function. An XML value can be implicitly parsed or serialized when exchanged with application string and binary data types.

The XML data type has no defined maximum length. It does have an effective maximum length when treated as a serialized string value that represents XML which is the same as the limit for LOB data values. Like LOBs, there are also XML locators and XML file reference variables.

Restrictions when using XML values: With a few exceptions, you can use XML values in the same contexts in which you can use other data types. XML values are valid in:

- CAST a parameter marker, XML, or NULL to XML
- XMLCAST a parameter marker, XML, or NULL to XML
- IS NULL predicate
- COUNT and COUNT_BIG aggregate functions
- COALESCE, IFNULL, HEX, LENGTH, CONTAINS, and SCORE scalar functions
- XML scalar functions
- A SELECT list without DISTINCT
- INSERT VALUES clause, UPDATE SET clause, and MERGE
- SET and VALUES INTO
- Procedure parameters
- User-defined function arguments and result
- Trigger correlation variables
- Parameter marker values for a dynamically prepared statement

XML values cannot be used directly in the following places. Where expressions are allowed, an XML value can be used, for example, as the argument of XMLSERIALIZE:

- A SELECT list containing the DISTINCT keyword
- A GROUP BY clause
- An ORDER BY clause
- A subselect of a fullselect that is not UNION ALL
- A basic, quantified, BETWEEN, DISTINCT, IN, or LIKE predicate
- An aggregate function with the DISTINCT keyword
- A primary, unique, or foreign key
- A check constraint
- An index column

No host languages have a built-in data type for the XML data type.

For information on the XML data model and XML values, see [SQL XML programming](#).

Determining the CCSID for XML

XML data can be defined with any EBCDIC single byte or mixed CCSID or a Unicode CCSID of 1208, 1200, or 13488. 65535 is not allowed as a CCSID for XML data. The CCSID can be explicitly specified when defining an XML data type. If it is not explicitly specified, the CCSID will be assigned using the value of the SQL_XML_DATA_CCSID QAQQINI file option. If this value has not been set, the default is 1208 (UTF-8).

The CCSID will be established for XML data types used in SQL schema statements when the statement is run.

XML host variables that do not have a DECLARE VARIABLE that assigns a CCSID will have their CCSID assigned as follows:

- If it is XML AS DBCLOB, the CCSID will be 1200.
- If it is XML AS CLOB and the SQL_XML_DATA_CCSID QAQQINI value is 1200 or 13488, the CCSID will be 1208.
- Otherwise, the SQL_XML_DATA_CCSID QAQQINI value will be used as the CCSID.

Since all implicit and explicit XMLPARSE functions are performed using UTF-8 (1208) defining data in this CCSID removes the need to convert the data to UTF-8.

DataLink values

A DataLink value is an encapsulated value that contains a logical reference from the database to a file stored outside the database.

The attributes of this encapsulated value are as follows:

link type

The currently supported type of link is a URL (Uniform Resource Locator).

scheme

For URLs, this is a value such as HTTP or FILE. The value, no matter what case it is entered in, is stored in the database in upper case.

file server name

The complete address of the file server. The value, no matter what case it is entered in, is stored in the database in upper case.

file path

The identity of the file within the server. The value is case sensitive and therefore it is not converted to upper case when stored in the database.

access control token

When appropriate, the access token is embedded within the file path. It is generated dynamically and is not a permanent part of the DataLink value that is stored in the database.

comment

Up to 254 bytes of descriptive information. This is intended for application specific uses such as further or alternative identification of the location of the data.

The characters used in a DataLink value are limited to the set defined for a URL. These characters include the uppercase (A through Z) and lower case (a through z) letters, the digits (0 through 9) and a subset of special characters (\$, -, _, @, ., &, +, !, *, ", ', (,), =, :, /, #, ?, ;, space, and comma).

The first four attributes are collectively known as the linkage attributes. It is possible for a DataLink value to have only a comment attribute and no linkage attributes. Such a value may even be stored in a column but, of course, no file will be linked to such a column.

It is important to distinguish between these DataLink references to files and the LOB file reference variables described in [“References to LOB or XML file reference variables”](#) on page 145. The similarity is that they both contain a representation of a file. However:

- DataLinks are retained in the database and both the links and the data in the linked files can be considered as a natural extension of data in the database.

- File reference variables exist temporarily and they can be considered as an alternative to a host program buffer.

Built-in scalar functions are provided to build a DataLink value (DLVALUE) and to extract the encapsulated values from a DataLink value (DLCOMMENT, DLLINKTYPE, DLURLCOMPLETE, DLURLPATH, DLURLPATHONLY, DLURLSCHEME, DLURLSERVER).

Row ID values

A *row ID* is a value that uniquely identifies a row in a table. A column or a variable can have a row ID data type. A ROWID column enables queries to be written that navigate directly to a row in the table.

Each value in a ROWID column must be unique. The database manager maintains the values permanently, even across table reorganizations. When a row is inserted into the table, the database manager generates a value for the ROWID column unless one is supplied. If a value is supplied, it must be a valid row ID value that was previously generated by either Db2 for z/OS or Db2 for i.

The internal representation of a row ID value is transparent to the user. The value is never subject to CCSID conversion because it is considered to contain BIT data. The length attribute of a ROWID column is 40.

User-defined types

A user-defined type is a data type that is defined to the database using a CREATE TYPE statement. There are two types of user-defined type: distinct types and array types.

Distinct types

A *distinct type* is a user-defined data type that shares its internal representation with a built-in data type (its "source type"). A distinct type is defined to use either strong typing or weak typing rules. Strong typing rules are the default.

A distinct type is created using [“CREATE TYPE \(distinct\)” on page 1184](#).

The name of a distinct type is qualified with a schema name. The implicit schema name for an unqualified name depends upon the context in which the distinct type appears. If an unqualified distinct type name is used:

- In a CREATE TYPE statement or the object of the DROP, COMMENT, LABEL, GRANT, or REVOKE statement, the database manager uses the normal process of qualification by authorization ID to determine the schema name. For more information about qualification rules, see [“Unqualified function, procedure, specific name, type, and variables” on page 59](#).
- In any other context, the database manager uses the SQL path to determine the schema name. The database manager searches the schemas in the path, in sequence, and selects the first schema that has a distinct type that matches. For a description of the SQL path, see [“SQL path” on page 57](#).

A distinct type is subject to the same restrictions as its source type. For example, a table can only have one ROWID column. Therefore, a table with a ROWID column cannot also have a column with distinct type that is sourced on a ROWID.

Strongly typed distinct type

A strongly typed distinct type is considered to be a separate and incompatible type for most operations. For example, the semantics for a picture type, a text type, and an audio type that all use the built-in data type BLOB for their internal representation are quite different.

For example, the following statement creates a distinct type named AUDIO:

```
CREATE TYPE AUDIO AS BLOB (1M)
```

Although AUDIO has the same representation as the built-in data type BLOB, it is considered to be a separate type that is not comparable to a BLOB or to any other type. This inability to compare AUDIO to other data types allows functions to be created specifically for AUDIO and assures that these functions cannot be applied to other data types (such as pictures or text).

A strongly typed distinct type does not automatically acquire the functions and operators of its source type, since these may not be meaningful. (For example, the LENGTH function for an AUDIO type might return the length of its object in seconds rather than in bytes.) Strong typing ensures that only the functions and operators that are explicitly defined for a distinct type can be applied to that distinct type. However, a function or operator of the source type can be applied to the distinct type by creating an appropriate user-defined function. The user-defined function must be sourced on the existing function that has the source type as a parameter. For example, the following series of SQL statements shows how to create a distinct type named MONEY based on data type DECIMAL(9,2), how to define the + operator for the distinct type, and how the operator might be applied to the distinct type:

```
CREATE TYPE MONEY AS DECIMAL(9,2)

CREATE FUNCTION "+" (MONEY, MONEY)
  RETURNS MONEY
  SOURCE "+" (DECIMAL(9,2), DECIMAL(9,2))

CREATE TABLE SALARY_TABLE
  (SALARY MONEY,
  COMMISSION MONEY)

SELECT "+" (SALARY, COMMISSION) FROM SALARY_TABLE
```

The database manager automatically generates functions for a distinct type that support casting from the source type to the distinct type and from the distinct type to the source type. For example, for the AUDIO type created above, these are the generated cast functions:

Name of generated cast function	Parameter list	Returns data type
<i>schema-name</i> .BLOB	<i>schema-name</i> .AUDIO	BLOB
<i>schema-name</i> .AUDIO	BLOB	<i>schema-name</i> .AUDIO

Weakly typed distinct type

A weakly typed distinct type is considered to be the same as its source type for all operations including function resolution. A weakly typed distinct type provides an alternative method of referring to a built-in data type.

The following example illustrates the creation of a distinct type named LAST_NAME:

```
CREATE TYPE LAST_NAME AS VARCHAR(50)
  WITH WEAK TYPE RULES
```

Weak typing means that LAST_NAME operates in the same way as its source type of VARCHAR(50).

Array types

An *array* is a structure that contains an ordered collection of data elements. All elements in an array have the same data type. The cardinality of the array is equal to the number of elements in the array.

The entire array can be referenced or an individual element of the array can be referenced by its ordinal position in the collection. If *N* is the cardinality of an array, the ordinal position associated with each element is an integer value greater than or equal to 1 and less than or equal to *N*.

An *array type* is a user-defined data type that is defined as an array. An SQL variable or SQL parameter can be defined as a user-defined array data type. Additionally, the result of an invocation of the TRIM_ARRAY function, or the result of a CAST specification, can be a user-defined array data type. An element of a user-defined array type can be referenced anywhere an expression returning the same data type as an element of that array can be used.

An unnamed array type is an array without an associated user-defined data type. The result of an invocation of the ARRAY_AGG aggregate function or an ARRAY constructor is an array without an associated user-defined data type. An element of an array without an associated user-defined array type cannot be directly referenced.

An array value can be empty (cardinality zero), null, or the individual elements in the array can be null or not null. An empty array is different than an array value of null, or an array for which all elements are the null value.

An array value cannot be stored in the database or be returned to an external application other than Java.

Promotion of data types

Data types can be classified into groups of related data types. Within such groups, an order of precedence exists where one data type is considered to precede another data type. This precedence enables the database manager to support the *promotion* of one data type to another data type that appears later in the precedence ordering. For example, the data type CHAR can be promoted to VARCHAR; INTEGER can be promoted to DOUBLE PRECISION; but CLOB is NOT promotable VARCHAR.

The database manager considers the promotion of data types when:

- performing function resolution (see “Function resolution” on page 150)
- casting distinct types (see “Casting between data types” on page 87)
- assigning distinct types to built-in data types (see “Distinct type comparisons” on page 105)

For each data type, Table 14 on page 85 shows the precedence list (in order) that the database manager uses to determine the data types to which each data type can be promoted. The table indicates that the best choice is the same data type and not promotion to another data type. Note that the table also shows data types that are considered equivalent during the promotion process. For example, CHARACTER and GRAPHIC are considered to be equivalent data types.

Table 14. Data Type Precedence Table

Data Type	Data Type Precedence List (in best-to-worst order)
SMALLINT	SMALLINT, INTEGER, BIGINT, decimal, real, double, DECFLOAT
INTEGER	INTEGER, BIGINT, decimal, real, double, DECFLOAT
BIGINT	BIGINT, decimal, real, double, DECFLOAT
decimal	decimal, real, double, DECFLOAT
real	real, double, DECFLOAT
double	double, DECFLOAT
DECFLOAT	DECFLOAT
CHAR or GRAPHIC	CHAR or GRAPHIC, VARCHAR or VARGRAPHIC, CLOB or DBCLOB
VARCHAR or VARGRAPHIC	VARCHAR or VARGRAPHIC, CLOB or DBCLOB
CLOB or DBCLOB	CLOB or DBCLOB
CHAR FOR BIT DATA	CHAR, VARCHAR, CLOB, BINARY, VARBINARY, BLOB
VARCHAR FOR BIT DATA	VARCHAR, CLOB, VARBINARY, BLOB
BINARY	BINARY, VARBINARY, BLOB, CHAR FOR BIT DATA, VARCHAR FOR BIT DATA
VARBINARY	VARBINARY, BLOB, VARCHAR FOR BIT DATA
BLOB	BLOB
DATE	DATE, TIMESTAMP
TIME	TIME
TIMESTAMP	TIMESTAMP
DATALINK	DATALINK
ROWID	ROWID

Table 14. Data Type Precedence Table (continued)

Data Type	Data Type Precedence List (in best-to-worst order)
XML	XML
ARRAY	ARRAY
udt	same udt

Note:

The lower case types above are defined as follows:

decimal

= DECIMAL(p,s) or NUMERIC(p,s)

real

= REAL or FLOAT(*n*) where *n* is a specification for single precision floating point

double

= DOUBLE, DOUBLE PRECISION, FLOAT or FLOAT(*n*) where *n* is a specification for double precision floating point

udt

= a strongly typed user-defined type (a weakly typed distinct type uses the source type to determine data type precedence)

Shorter and longer form synonyms of the data types listed are considered to be the same as the synonym listed.

Character and graphic strings are only compatible for Unicode data.

Casting between data types

There are many occasions when a value with a given data type needs to be cast (changed) to a different data type or to the same data type with a different length, precision, or scale.

Data type promotion, as described in “Promotion of data types” on page 85, is one example of when a value with one data type needs to be cast to a new data type. A data type that can be changed to another data type is *castable* from the source data type to the target data type.

The casting of one data type to another can occur implicitly or explicitly. The cast functions or CAST specification (see “CAST specification” on page 177) can be used to explicitly change a data type. The database manager might implicitly cast data types during assignments that involve a distinct type (see “Distinct type assignments” on page 100). In addition, when you create a sourced user-defined function, the data types of the parameters of the source function must be castable to the data types of the function that you are creating (see “CREATE FUNCTION (sourced)” on page 1008).

If truncation occurs when a character or graphic string is cast to another data type, a warning occurs if any non-blank characters are truncated. This truncation behavior is similar to retrieval assignment of character or graphic strings (see “Retrieval assignment:” on page 96).

If truncation occurs when a binary string is cast to another data type, a warning occurs. This truncation behavior is similar to retrieval assignment of binary strings (see “Retrieval assignment” on page 95).

For casts that involve an array type, the source and target data type must both be the same array type.

For casts that involve a strongly typed distinct type as either the data type to be cast to or from, Table 15 on page 87 shows the supported casts. For casts between built-in data types, Table 16 on page 89 shows the supported casts.

Table 15. Supported Casts When a Distinct Type is Involved

Data Type ...	Is Castable to Data Type ...
Distinct type <i>DT</i>	Source data type of distinct type <i>DT</i>
Source data type of distinct type <i>DT</i>	Distinct type <i>DT</i>
Distinct type <i>DT</i>	Distinct type <i>DT</i>
Data type <i>A</i>	Distinct type <i>DT</i> where <i>A</i> is promotable to the source data type of distinct type <i>DT</i> (see “Promotion of data types” on page 85)
INTEGER	Distinct type <i>DT</i> if <i>DT</i> 's source type is SMALLINT
DOUBLE	Distinct type <i>DT</i> if <i>DT</i> 's source data type is REAL
VARCHAR	Distinct type <i>DT</i> if <i>DT</i> 's source data type is CHAR or GRAPHIC
VARGRAPHIC	Distinct type <i>DT</i> if <i>DT</i> 's source data type is GRAPHIC or CHAR
VARBINARY	Distinct type <i>DT</i> if <i>DT</i> 's source data type is BINARY

Character and graphic strings are only compatible for Unicode data. Character bit data and graphic strings are not compatible.

When a strongly typed distinct type is involved in a cast, a cast function that was generated when the distinct type was created is used. How the database manager chooses the function depends on whether function notation or the CAST specification syntax is used. For details, see “Function resolution” on page 150, and “CAST specification” on page 177. Function resolution is used for both. However, in a CAST specification, when an unqualified distinct type is specified as the target data type, the database manager resolves the schema name of the distinct type and then uses that schema name to locate the cast function.

For casts involving a weakly typed distinct type as a target, the cast from data type must be castable to the source type of the weakly typed distinct type. The only context in which an operand is implicitly cast

to a weakly typed distinct type is when a source operand is assigned to a target with a data type that is a weakly typed distinct type.

The following table describes the supported casts between built-in data types.

Table 16. Supported Casts Between Built-In Data Types

Target Data Type →	SMALLINT	INTEGER	BIGINT	DECIMAL NUMERIC	REAL DOUBLE	DECFLOAT	CHAR VARCHAR CLOB	GRAPHIC VARGRAPHIC DBCLOB	BINARY VARBINARY BLOB	DATE	TIME	TIMESTAMP	ROWID	DATALINK	XML
Source Data Type ↓															
SMALLINT	Y	Y	Y	Y	Y	Y	Y	Y ¹	–	–	–	–	–	–	–
INTEGER	Y	Y	Y	Y	Y	Y	Y	Y ¹	–	–	–	–	–	–	–
BIGINT	Y	Y	Y	Y	Y	Y	Y	Y ¹	–	–	–	–	–	–	–
DECIMAL	Y	Y	Y	Y	Y	Y	Y	Y ¹	–	–	–	–	–	–	–
NUMERIC	Y	Y	Y	Y	Y	Y	Y	Y ¹	–	–	–	–	–	–	–
REAL	Y	Y	Y	Y	Y	Y	Y	Y ¹	–	–	–	–	–	–	–
DOUBLE	Y	Y	Y	Y	Y	Y	Y	Y ¹	–	–	–	–	–	–	–
DECFLOAT	Y	Y	Y	Y	Y	Y	Y	Y ¹	–	–	–	–	–	–	–
CHAR	Y	Y	Y	Y	Y	Y	Y	Y ¹	Y	Y	Y	Y	Y	–	–
VARCHAR	Y	Y	Y	Y	Y	Y	Y	Y ¹	Y	Y	Y	Y	Y	–	–
CLOB	Y	Y	Y	Y	Y	Y	Y	Y ¹	Y	Y	Y	Y	Y	–	–
GRAPHIC	Y ¹	Y ¹	Y ¹	Y ¹	Y ¹	Y ¹	Y ¹	Y	Y	Y ¹	Y ¹	Y ¹	–	–	–
VARGRAPHIC	Y ¹	Y ¹	Y ¹	Y ¹	Y ¹	Y ¹	Y ¹	Y	Y	Y ¹	Y ¹	Y ¹	–	–	–
DBCLOB	Y ¹	Y ¹	Y ¹	Y ¹	Y ¹	Y ¹	Y ¹	Y	Y	Y ¹	Y ¹	Y ¹	–	–	–
BINARY	–	–	–	–	–	–	Y	–	Y	–	–	–	–	–	–
VARBINARY	–	–	–	–	–	–	Y	–	Y	–	–	–	–	–	–
BLOB	–	–	–	–	–	–	Y	–	Y	–	–	–	–	–	–
DATE	–	Y	Y	Y	–	–	Y	Y ¹	–	Y	–	Y	–	–	–
TIME	–	Y	Y	Y	–	–	Y	Y ¹	–	–	Y	Y	–	–	–
TIMESTAMP	–	–	Y	Y	–	–	Y	Y ¹	–	Y	Y	Y	–	–	–
ROWID	–	–	–	–	–	–	Y	–	Y	–	–	–	Y	–	–
DATALINK	–	–	–	–	–	–	–	–	–	–	–	–	–	Y	–
XML	–	–	–	–	–	–	–	–	–	–	–	–	–	–	Y

Notes:

¹ Conversion is only supported for Unicode graphic. If the other data type is FOR BIT DATA, conversion is not supported.

The following table describes the rules for casting to a data type:

Table 17. Rules for Casting to a Data Type

Target Data Type	Rules
SMALLINT	See “SMALLINT” on page 568.
INTEGER	See “INTEGER or INT” on page 438.
BIGINT	See “BIGINT” on page 314.
DECIMAL	See “DECIMAL or DEC” on page 373.
NUMERIC	See “ZONED” on page 676.
REAL	See “REAL” on page 531.
DOUBLE	See “DOUBLE_PRECISION or DOUBLE” on page 391.
DECFLOAT	See “DECFLOAT” on page 368
CHAR	See “CHAR” on page 324.
VARCHAR	See the “VARCHAR” on page 616.
CLOB	See “CLOB” on page 332.
GRAPHIC	If the source data type is a character string, see the rules for string assignment to a variable in “Assignments and comparisons” on page 91. Otherwise, see “GRAPHIC” on page 415.
VARGRAPHIC	If the source data type is a character string, see the rules for string assignment to a variable in “Assignments and comparisons” on page 91. Otherwise, see “VARGRAPHIC” on page 631.
DBCLOB	See “DBCLOB” on page 360.
BINARY	See “BINARY” on page 316.
VARBINARY	See “VARBINARY” on page 613.
BLOB	See “BLOB” on page 320.
DATE	See “DATE” on page 351.
TIME	See “TIME” on page 584.
TIMESTAMP	See “TIMESTAMP” on page 585, using the precision of the target data type as the second argument. If the source data type is a DATE, the timestamp is composed of the specified date and a time of 00:00:00. If the source data type is a TIME, the timestamp is composed of the CURRENT_DATE and the specified time.
DATALINK	See the rules for DataLink assignments in “Assignments and comparisons” on page 91.
ROWID	See “ROWID” on page 553.
XML	See the rules for XML assignments in “Assignments and comparisons” on page 91.

Assignments and comparisons

The basic operations of SQL are assignment and comparison. Assignment operations are performed during the execution of CALL, INSERT, UPDATE, FETCH, SELECT, SET variable, and VALUES INTO statements. Comparison operations are performed during the execution of statements that include predicates and other language elements such as MAX, MIN, DISTINCT, GROUP BY, and ORDER BY.

The basic rule for both operations is that the data type of the operands involved must be compatible. The compatibility rule also applies to UNION, EXCEPT, INTERSECT, concatenation, CASE expressions, and the CONCAT, VALUE, COALESCE, IFNULL, MIN, and MAX scalar functions. The compatibility matrix is as follows:

Table 18. Data Type Compatibility

Operands	Binary Integer	Decimal Number	Floating Point	Decimal Floating Point	Character String	Graphic String	Binary String	Date	Time	Timestamp	DataLink	Row ID	XML ⁷	User-defined Type
Binary Integer	Y	Y	Y	Y	Y	1	—	—	—	—	—	—	—	3
Decimal Number ⁴	Y	Y	Y	Y	Y	1	—	—	—	—	—	—	—	3
Floating Point	Y	Y	Y	Y	Y	1	—	—	—	—	—	—	—	3
Decimal Floating-Point	Y	Y	Y	Y	Y	1	—	—	—	—	—	—	—	3
Character String	Y	Y	Y	Y	Y	1	2	—	—	—	—	—	—	3
Graphic String	1	1	1	1	1	Y	—	1	1	1	—	—	—	3
Binary String	—	—	—	—	2	—	Y	—	—	—	—	—	—	3
Date	—	—	—	—	—	1	—	Y	—	Y	—	—	—	3
Time	—	—	—	—	—	1	—	—	Y	—	—	—	—	3
Timestamp	—	—	—	—	—	1	—	Y	—	Y	—	—	—	3
DataLink	—	—	—	—	—	—	—	—	—	—	5	—	—	3
Row ID	—	—	—	—	—	—	—	—	—	—	—	6	—	3
XML ⁷	—	—	—	—	—	—	—	—	—	—	—	—	Y	3
User-defined Type	3	3	3	3	3	3	3	3	3	3	3	3	3	3

Table 18. Data Type Compatibility (continued)

Operands	Binary Integer	Decimal Number	Floating Point	Decimal Floating Point	Character String	Graphic String	Binary String	Date	Time	Timestamp	DataLink	Row ID	XML ⁷	User-defined Type
----------	----------------	----------------	----------------	------------------------	------------------	----------------	---------------	------	------	-----------	----------	--------	------------------	-------------------

Notes:

1. Only Unicode graphic strings are compatible. Unicode and FOR BIT DATA are not compatible.
2. Character strings, except those with FOR BIT DATA, are not compatible with binary strings. FOR BIT DATA character strings and binary strings are considered compatible and any padding is performed based on the data type of the target. For example, when assigning a FOR BIT DATA column value to a fixed-length binary variable, any necessary padding uses a pad byte of X'00'.
3. For detailed user-defined type information, see [“Distinct type assignments”](#) on page 100 and [“Distinct type comparisons”](#) on page 105.
A value with an array type is comparable only to a value that is defined with the same array type. A value with an array type can be assigned to an array of the same type. For additional information, see [“Array type assignments”](#) on page 101.
4. Decimal refers to both packed and zoned decimal.
5. A DataLink operand can only be assigned to another DataLink operand and cannot be compared to any data type.
6. A ROWID operand can only be assigned to another ROWID operand and cannot be compared to any data type.
7. Character and graphic strings can be assigned to XML columns. However, XML cannot be assigned to a character or graphic string column. For comparisons, XML can only be compared using the IS NULL predicate.

A basic rule for assignment operations is that a null value cannot be assigned to:

- a column that cannot contain null values
- a host variable that does not have an associated indicator variable
- a Java host variable that is a primitive type.

See [“References to host variables”](#) on page 140 for a discussion of indicator variables.

For any comparison that involves null values, see the description of the comparison operation for information about the specific handling of null values.

Numeric assignments

For numeric assignments, overflow is not allowed.

- When assigning to an exact numeric data type, overflow occurs if any digit of the whole part of the number would be eliminated. If necessary, the fractional part of a number is truncated.
- When assigning to an approximate numeric data type or decimal floating-point number, overflow occurs if the most significant digit of the whole part of the number is eliminated. For floating-point and decimal floating-point numbers, the whole part of the number is the number that would result if the floating-point or decimal floating-point number were converted to a decimal number with unlimited precision. If necessary, rounding may cause the least significant digits of the number to be eliminated.

For decimal floating-point numbers, truncation of the whole part of the number is allowed and results in infinity with a warning if *YES is specified for the SQL_DECFLOAT_WARNINGS query option.

For floating-point numbers, underflow is also not allowed. Underflow occurs for numbers between 1 and -1 if the most significant digit other than zero would be eliminated. For decimal floating point, underflow is allowed and depending on the rounding mode, results in zero or the smallest positive number or the largest negative number that can be represented. A warning is returned if *YES is specified for the SQL_DECFLOAT_WARNINGS query option.

For information about the decimal floating-point rounding mode, see [“CURRENT DECFLOAT ROUNDING MODE”](#) on page 126.

An overflow or underflow warning is returned instead of an error if an overflow or underflow occurs on assignment to a host variable with an indicator variable. In this case, the number is not assigned to the host variable and the indicator variable is set to negative 2.

Assignments to integer

When a decimal, floating-point, or decimal floating-point number is assigned to a binary integer column or variable, the fractional part of the number is eliminated. As a result, a number between 1 and -1 is reduced to 0.

Assignments to decimal

When an integer is assigned to a decimal column or variable, the number is first converted to a temporary decimal number and then, if necessary, to the precision and scale of the target. The precision and scale of the temporary decimal number is 5,0 for a small integer, 11,0 for a large integer, or 19,0 for a big integer.

When a decimal number is assigned to a decimal column or variable, the number is converted, if necessary, to the precision and the scale of the target. The necessary number of leading zeros is added, and in the fractional part of the decimal number the necessary number of trailing zeros is added, or the necessary number of trailing digits is eliminated.

When a floating-point number is assigned to a decimal column or variable, the number is first converted to a temporary decimal number of precision 63 and scale of $63 - (p-s)$ where p and s are the precision and scale of the decimal column or variable. Then, if necessary, the temporary number is truncated to the precision and scale of the target. As a result, a number between 1 and -1 that is less than the smallest positive number or greater than the largest negative number that can be represented in the decimal column or variable is reduced to 0.

When a decimal floating-point number is assigned to a decimal column or variable, the number is rounded to the precision and scale of the decimal column or variable. As a result, a number between 1 and -1 that is less than the smallest positive number or greater than the largest negative number that can be represented in the decimal column or variable is reduced to 0 or rounded to the smallest positive or largest negative value that can be represented in the decimal column or variable, depending on the rounding mode.

Note: Decimal refers to both packed and zoned decimal. A binary integer with scale follows the rules for a assignments to decimal.

Note: When fetching decimal data from a file that was *not* created by an SQL CREATE TABLE statement, a decimal field may contain data that is not valid. In this case, the data will be returned as stored, without any warning or error message being issued. A table that is created by the SQL CREATE TABLE statement does not allow decimal data that is not valid.

Assignments to floating-point

Floating-point numbers are approximations of real numbers. Hence, when an integer, decimal, floating-point, or decimal floating-point number is assigned to a floating-point column or variable, the result may not be identical to the original number. The number is rounded to the precision of the floating-point column or variable using floating-point arithmetic.

Assignments to decimal floating-point

When an integer number is assigned to a decimal floating-point column or variable, the number is first converted to a temporary decimal number and then to a decimal floating-point number. The precision and scale of the temporary decimal number is 5,0 for a small integer, 11,0 for a large integer, or 19,0 for a big integer. Rounding may occur when assigning a BIGINT to a DECFLOAT(16) column or variable.

When a decimal number is assigned to a decimal floating-point column or variable, the number is converted to the precision (16 or 34) of the target. Leading zeros are eliminated. Depending on the precision and scale of the decimal number and the precision of the target, the value might be rounded.

When a floating-point number is assigned to a decimal floating-point column or variable, the number is first converted to a temporary string representation of the floating-point number. The string representation of the number is then converted to decimal floating-point.

When a DECFLOAT(16) number is assigned to a DECFLOAT(34) column or variable, the resulting value is identical to the DECFLOAT(16) number.

When a DECFLOAT(34) number is assigned to a DECFLOAT(16) column or variable, the exponent of the source is converted to the corresponding exponent in the result format. The mantissa of the DECFLOAT(34) number is rounded to the precision of the target. For more information about the decimal floating-point rounding mode, see [“CURRENT DECFLOAT ROUNDING MODE”](#) on page 126.

Assignments to COBOL and RPG integers

Assignment to COBOL and RPG small or large integer host variables takes into account any scale specified for the host variable. However, assignment to integer host variables uses the full size of the integer. Thus, the value placed in the COBOL data item or RPG field might be larger than the maximum precision specified for the host variable.

Examples:

- In COBOL, assume that COL1 contains a value of 12345. The following SQL statement results in the value 12345 being placed in A, even though A has been defined with only 4 digits:

```
01 A PIC S9999 BINARY.  
EXEC SQL SELECT COL1  
        INTO :A  
        FROM TABLEX  
END-EXEC.
```

- Notice, however, that the following COBOL statement results in 2345 (and not 12345) being placed in A:

```
MOVE 12345 TO A.
```

Assignments from strings to numeric

When a string is assigned to a numeric data type, it is converted to the target numeric data type using the rules for a CAST specification. For more information, see [“CAST specification”](#) on page 177.

String assignments

There are two types of string assignments.

- *Storage assignment* is when a value is assigned to a column, a parameter of a function or procedure, or a transition variable.
- *Retrieval assignment* is when a value is assigned to a variable (but not a parameter or transition variable).²⁶

²⁶ If assigning to an SQL-variable or SQL-parameter and the standards option is specified, storage assignment rules apply. For information about the standards option, see [“Standards compliance”](#) on page xix.

Binary string assignments

The following rules apply when the assignment target is a binary string.

Storage assignment

The basic rule is that the length of a string assigned to a column, parameter of a function or procedure, or transition variable must not be greater than the length attribute of the column or parameter. If the string is longer than the length attribute of that column, parameter, or transition variable, an error is returned. Trailing hexadecimal zeroes (X'00') are normally included in the length of the string. For storage assignments, however, trailing hexadecimal zeroes are not included in the length of the string.

When a string is assigned to a fixed-length binary-string column, parameter, or transition variable and the length of the string is less than the length attribute of the target, the string is padded on the right with the necessary number of hexadecimal zeroes.

Retrieval assignment

The length of a string assigned to a variable (but not a parameter or transition variable) can be greater than the length attribute of the variable. When a string is assigned to a variable and the string is longer than the length attribute of the variable, the string is truncated on the right by the necessary number of bytes. When this occurs, an SQLSTATE of '01004' is assigned to the RETURNED_SQLSTATE condition area item in the SQL Diagnostics Area (or the value 'W' is assigned to the SQLWARN1 field of the SQLCA).

When a string is assigned to a fixed-length binary-string variable and the length of the string is less than the length attribute of the target, the string is padded on the right with the necessary number of hexadecimal zeroes.

When a string of length n is assigned to a varying-length string variable with a maximum length greater than n , the bytes after the n th byte of the variable are undefined.

Character and graphic string assignments

The following rules apply when the assignment target is a string.

When a datetime data type is involved, see [“Datetime assignments”](#) on page 97. For the special considerations that apply when a strongly typed distinct type is involved in an assignment, especially to a variable, see [“Distinct type assignments”](#) on page 100.

Assignments from numeric to strings

When a number is assigned to a string data type, it is converted to the target string data type using the rules for a CAST specification. For more information, see [“CAST specification”](#) on page 177.

Storage assignment:

The basic rule is that the length of a string assigned to a column, parameter of a function or procedure, or transition variable must not be greater than the length attribute of the column or parameter. If the string is longer than the length attribute of that column, parameter, or transition variable, an error is returned. Trailing blanks are normally included in the length of the string. For storage assignments, however, trailing blanks are not included in the length of the string.

When a string is assigned to a fixed-length string column, parameter, or transition variable and the length of the string is less than the length attribute of the target, the string is padded on the right with the necessary number of single-byte, double-byte, or UTF-16 or UCS-2 blanks.²⁷ The pad character is always a blank, even for bit data.

²⁷ UTF-16 or UCS-2 defines a blank character at code point X'0020' and X'3000'. The database manager pads with the blank at code point X'0020'. The database manager pads UTF-8 with a blank at code point X'20'

Retrieval assignment:

The length of a string assigned to a variable (but not a parameter or transition variable) can be greater than the length attribute of the variable. When a string is assigned to a variable and the string is longer than the length attribute of the variable, the string is truncated on the right by the necessary number of characters. When this occurs, an SQLSTATE of '01004' is assigned to the RETURNED_SQLSTATE condition area item in the SQL Diagnostics Area (or the value 'W' is assigned to the SQLWARN1 field of the SQLCA). Furthermore, if an indicator variable is provided, it is set to the original length of the string. If only the NUL-terminator is truncated for a C NUL-terminated host variable and the *NOCNULRQD option was specified on the CRTSQLCI or CRTSQLCPPI command (or CNULRQD(*NO) on the SET OPTION statement), an SQLSTATE of '01004' is assigned to the RETURNED_SQLSTATE condition area item in the SQL Diagnostics Area (or the value of 'N' is assigned to the SQLWARN1 field of the SQLCA) and a NUL is not placed in the variable.

When a string is assigned to a fixed-length variable and the length of the string is less than the length attribute of the target, the string is padded on the right with the necessary number of single-byte, double-byte, or UTF-16 or UCS-2 blanks.²⁷ The pad character is always a blank, even for bit data.

When a string of length n is assigned to a varying-length string variable with a maximum length greater than n , the characters after the n th character of the variable are undefined.

Assignments to mixed strings:

If a string contains mixed data, the assignment rules may require truncation within a sequence of double-byte codes. To prevent the loss of the shift-in character that ends the double-byte sequence, additional characters may be truncated from the end of the string, and a shift-in character added. In the truncated result, there is always an even number of bytes between each shift-out character and its matching shift-in character.

Assignments to C NUL-terminated strings:

When a string of length n is assigned to a C NUL-terminated string variable with a length greater than $n+1$:

- If the *CNULRQD option was specified on the CRTSQLCI or CRTSQLCPPI command (or CNULRQD(*YES) on the SET OPTION statement), the string is padded on the right with $x-n-1$ blanks where x is the length of the variable. The padded string is then assigned to the variable and the NUL-terminator is placed in the next character position.
- If the *NOCNULRQD precompiler option was specified on the CRTSQLCI or CRTSQLCPPI command (or CNULRQD(*NO) on the SET OPTION statement), the string is not padded on the right. The string is assigned to the variable and the NUL-terminator is placed in the next character position.

Conversion rules for assignments

A string assigned to a column, variable, or parameter is first converted, if necessary, to the coded character set of the target. Character conversion is necessary only if all of the following are true:

- The CCSIDs are different.
- Neither CCSID is 65535.
- The string is neither null nor empty.
- Conversion between the two CCSIDs is required. For more information, see [“Coded character sets and CCSIDs” on page 32](#).

An error occurs if:

- Conversion between the pair of CCSIDs is not defined. For more information, see [“Coded character sets and CCSIDs” on page 32](#).
- A character of the string cannot be converted, and the operation is assignment to a column or assignment to a host variable without an indicator variable. For example, a double-byte character (DBCS) cannot be converted to a column or host variable with a single-byte character (SBCS) CCSID.

A warning occurs if:

- A character of the string is converted to the substitution character.
- A character of the string cannot be converted, and the assignment is not to a column or to a host variable without an indicator variable. For example, a DBCS character cannot be converted to a host variable with an SBCS CCSID. In this case, the string is not assigned to the host variable and the indicator variable is set to -2.

Datetime assignments

A value that is assigned to a date, time, or timestamp column or variable must be a date, time, or timestamp or a valid string representation of a date, a time, or a timestamp.

A value assigned to a DATE column or a DATE variable must be a date or timestamp or a valid string representation of a date or timestamp. When a timestamp value is assigned to a DATE data type, the date portion is extracted and the time portion is ignored. A date can be assigned only to a DATE or TIMESTAMP column, a string column, a DATE or TIMESTAMP variable, or a string variable.

A value assigned to a TIME column or a TIME variable must be a time or timestamp or a valid string representation of a time or timestamp. When a timestamp value is assigned to a TIME data type, the date portion is ignored and the time portion is extracted with the fractional seconds truncated. A time can be assigned only to a TIME column, a string column, a TIME variable, or a string variable.

A value assigned to a TIMESTAMP column or a TIMESTAMP variable must be a date or timestamp or a valid string representation of a date or timestamp. If a string representation of a date or timestamp is used, it is implicitly cast to a timestamp with the same precision as the target timestamp. When a date value is assigned to a TIMESTAMP data type, the missing time information is assumed to be all zeros. A timestamp can be assigned to a DATE, TIME, or TIMESTAMP column, a string column, a DATE, TIME, or TIMESTAMP variable, or a string variable. When a timestamp value is assigned to a timestamp with lower precision, the excess fractional seconds are truncated. When a timestamp value is assigned to a timestamp with higher precision, missing digits are assumed to be zeros.

When a datetime value is assigned to a string variable or column, it is converted to its string representation. Leading zeros are not omitted from any part of the date, time, or timestamp. The required length of the target varies depending on the format of the string representation. If the length of the target is greater than required, it is padded on the right with blanks. If the length of the target is less than required, the result depends on the type of datetime value involved and on the type of target.

- If the target is a string column, truncation is not allowed. The following rules apply:

DATE

- The length attribute of the column must be at least 10 if the date format is *ISO, *USA, *EUR, or *JIS. If the date format is *YMD, *MDY, or *DMY, the length attribute of the column must be at least 8. If the date format is *JUL, the length of the variable must be at least 6.

TIME

- The length attribute of the column must be at least 8.

TIMESTAMP

- The length attribute of the column must be at least 19 for TIMESTAMP(0) and 20+p for TIMESTAMP(p).

- When the target is a variable, the following rules apply:

DATE

- The length of the variable must be at least 10 if the date format is *ISO, *USA, *EUR, or *JIS. If the date format is *YMD, *MDY, or *DMY, the length of the variable must be at least 8. If the date format is *JUL, the length of the variable must be at least 6.

TIME

- If the *USA format is used, the length of the variable must not be less than 8. This format does not include seconds.
- If the *ISO, *EUR, *JIS, or *HMS time format is used, the length of the variable must not be less than 5. If the length is 5, 6, or 7, the seconds part of the time is omitted from the result, and SQLWARN1 is set to 'W'. In this case, the seconds part of the time is assigned to the indicator variable if one is provided, and, if the length is 6 or 7, blank padding occurs so that the value is a valid string representation of a time.

TIMESTAMP

- The length of the variable must not be less than 19. If the length is between 19 and 31, the timestamp is truncated like a string, causing the omission of one or more digits of fractional seconds. If the length is 20, the trailing decimal point is replaced by a blank so that the value is a valid string representation of a timestamp with a precision of 0.

XML assignments

The following rules apply when the assignment target is XML.

The general rule for XML assignments is that only an XML value can be assigned to an XML column or an XML variable. There are exceptions to this rule as follows:

- **Processing of input XML variables:** This is a special case of the XML assignment rule because the variable is based on a string value. To make the assignment to XML within SQL, the string value is implicitly parsed into an XML value using the setting of the CURRENT IMPLICIT XMLPARSE OPTION special register. This determines whether to preserve or to strip whitespace, unless the variable is an argument of the XMLVALIDATE function which always strips unnecessary whitespace.
- **Assigning strings to input parameter markers of data type XML:** If an input parameter marker has an implicit or explicit data type of XML, the value assigned to that parameter marker could be a character string variable, graphic string variable, or binary string variable. In this case, the string value is implicitly parsed into an XML value using the setting of the CURRENT IMPLICIT XMLPARSE OPTION special register. This determines whether to preserve or to strip whitespace, unless the parameter marker is an argument of the XMLVALIDATE function which always strips unnecessary whitespace.
- **Assigning strings directly to XML columns in data change statements:** If assigning directly to a column of type XML in a data change statement, the assigned expression can also be a character string, a graphic string, or a binary string. In this case, the result of XMLPARSE (DOCUMENT *expression* STRIP WHITESPACE) is assigned to the target column. The supported string data types are defined by the supported arguments for the XMLPARSE function. This exception also applies to SQL parameters of type XML.
- **Assigning XML to strings on retrieval:** If retrieving XML values into variables using a FETCH or SELECT INTO in embedded SQL, the data type of the variable can be CLOB, DBCLOB, or BLOB. The XML value is implicitly serialized to a string encoded in the variable's CCSID. If using other application programming interfaces (such as CLI, JDBC, or .NET), XML values can be retrieved into the character, graphic, or binary string types that are supported by the application programming interface. In all these cases, the XML value is implicitly serialized to a string encoded in the CCSID determined by the QAQQINI file as described in “XML Values” on page 80.

For the FETCH, SELECT INTO, SET, and VALUES INTO statements, character string, graphic string, or binary string values cannot be retrieved into XML variables. For the INSERT, UPDATE, MERGE, SET, VALUES INTO, and CALL statements, values in XML variables cannot be assigned to columns, SQL variables, or SQL parameters of a character, graphic, or binary string data type.

DataLink assignments

The assignment of a value to a DataLink column results in the establishment of a link to a file unless the linkage attributes of the value are empty or the column is defined with NO LINK CONTROL. In cases where a linked value already exists in the column, that file is unlinked. Assigning a null value where a linked value already exists also unlinks the file associated with the old value.

If the application provides the same data location as already exists in the column, the link is retained. There are two reasons that this might be done:

- the comment is being changed
- if the table is placed in link pending state, the links in the table can be reinstated by providing linkage attributes identical to the ones in the column.

A DataLink value may be assigned to a column by using the DLVALUE scalar function. The DLVALUE scalar function creates a new DataLink value which can then be assigned a column. Unless the value contains only a comment or the URL is exactly the same, the act of assignment will link the file.

When assigning a value to a DataLink column, the following error conditions can occur:

- Data Location (URL) format is invalid
- File server is not registered with this database
- Invalid link type specified
- Invalid length of comment or URL

Note that the size of a URL parameter or function result is the same on both input or output and is bound by the length of the DataLink column. However, in some cases the URL value returned has an access token attached. In situations where this is possible, the output location must have sufficient storage space for the access token and the length of the DataLink column. Hence, the actual length of the comment and URL in its fully expanded form provided on input should be restricted to accommodate the output storage space. If the restricted length is exceeded, this error is raised.

When the assignment is also creating a link, the following errors can occur:

- File server not currently available.
- File does not exist.
- Referenced file cannot be accessed for linking.
- File already linked to another column.

Note that this error will be raised even if the link is to a different relational database.

In addition, when the assignment removes an existing link, the following errors can occur:

- File server not currently available.
- File with referential integrity control is not in a correct state according to the Db2 DataLinks File Manager.

A DataLink value may be retrieved from the database through the use of scalar functions (such as DLLINKTYPE and DLURLPATH). The results of these scalar functions can then be assigned to variables.

Note that usually no attempt is made to access the file server at retrieval time.²⁸It is therefore possible that subsequent attempts to access the file server through file system commands might fail.

A warning may be returned when retrieving a DataLink value because the table is in link pending state.

Row ID assignments

A row ID value can only be assigned to a column, parameter, or variable with a row ID data type. For the value of the ROWID column, the column must be defined as GENERATED BY DEFAULT or OVERRIDING SYSTEM VALUE must be specified. A unique constraint is implicitly added to every table that has a ROWID column that guarantees that every ROWID value is unique. The value that is specified for the column must be a valid row ID value that was previously generated by Db2 for z/OS or Db2 for i.

²⁸ It may be necessary to access the file server to determine the prefix name associated with a path. This can be changed at the file server when the mount point of a file system is moved. First access of a file on a server will cause the required values to be retrieved from the file server and cached at the database server for the subsequent retrieval of DataLink values for that file server. An error is returned if the file server cannot be accessed.

Distinct type assignments

The rules for assignments involving user-defined type values depend on whether the distinct type is a strongly typed distinct type or a weakly typed distinct type.

Strongly typed distinct type assignments

The rules that apply to the assignments of strongly typed distinct types to variables are different than the rules for all other assignments that involve strongly typed distinct types.

Assignments to variables

The assignment of a strongly typed distinct type to a variable is based on the source data type of the distinct type. Therefore, the value of a strongly typed distinct type is assignable to a variable only if the source data type of the distinct type is assignable to the variable.

Example:

Assume that distinct type AGE was created with the following SQL statement:

```
CREATE TYPE AGE AS SMALLINT
```

When the statement is executed, the following cast functions are also generated:

```
AGE (SMALLINT) RETURNS AGE  
AGE (INTEGER) RETURNS AGE  
SMALLINT (AGE) RETURNS SMALLINT
```

Next, assume that column STU_AGE was defined in table STUDENTS with distinct type AGE. Now, consider this valid assignment of a student's age to host variable HV_AGE, which has an INTEGER data type:

```
SELECT STU_AGE INTO :HV_AGE FROM STUDENTS WHERE STU_NUMBER = 200
```

The strongly typed distinct type value is assignable to the host variable HV_AGE because the source data type of the distinct type (SMALLINT) is assignable to the host variable (INTEGER).

Assignments other than to variables

A strongly typed distinct type can be either the source or target of an assignment. Assignment is based on whether the data type of the value to be assigned is castable to the data type of the target. [“Casting between data types” on page 87](#) shows which casts are supported when a distinct type is involved. Therefore, a strongly typed distinct type value can be assigned to any target other than a variable when:

- the target of the assignment has the same distinct type, or
- the distinct type is castable to the data type of the target.

Any value can be assigned to a strongly typed distinct type when:

- the value to be assigned has the same distinct type as the target, or
- the data type of the assigned value is castable to the target distinct type.

Example:

Assume that the source data type for distinct type AGE is SMALLINT:

```
CREATE TYPE AGE AS SMALLINT
```

Next, assume that two tables TABLE1 and TABLE2 were created with four identical column descriptions:

```
AGECOL    AGE  
SMINTCOL  SMALLINT  
INTCOL    INTEGER  
DECCOL    DEC(6,2)
```

Using the following SQL statement and substituting various values for X and Y to insert values into various columns of TABLE1 from TABLE2, [Table 19 on page 101](#) shows whether the assignments are valid.

```
INSERT INTO TABLE1 (Y) SELECT X FROM TABLE2
```

Table 19. Assessment of various assignments (for example on INSERT)

TABLE2.X	TABLE1.Y	Valid	Reason
AGECOL	AGECOL	Yes	Source and target are same distinct type
SMINTCOL	AGECOL	Yes	SMALLINT can be cast to AGE (because AGE's source type is SMALLINT)
INTCOL	AGECOL	Yes	INTEGER can be cast to AGE (because AGE's source type is SMALLINT)
DECCOL	AGECOL	No	DECIMAL cannot be cast to AGE
AGECOL	SMINTCOL	Yes	AGE can be cast to its source type SMALLINT
AGECOL	INTCOL	No	AGE cannot be cast to INTEGER
AGECOL	DECCOL	No	AGE cannot be cast to DECIMAL

Weakly typed distinct type assignments

The value of a weakly typed distinct type can be assigned according to the assignment rules for the source type of the weakly typed distinct type.

Array type assignments

For array types, the validity of an assignment to an SQL array variable or parameter is determined according to the following rules:

- If the right hand side of the assignment is an SQL array variable or parameter, the TRIM_ARRAY function, or a CAST expression, then its type must be the same type as the SQL array variable or parameter on the left hand side of the assignment.
- If the right hand side of the assignment is an array constructor or the ARRAY_AGG function, then it is implicitly cast to the type of the SQL array variable or parameter on the left hand side.

Assignments to LOB locators

When a LOB locator is used, it can refer to any string data. If a LOB locator is used for the first fetch of a cursor and the cursor is on a remote server, LOB locators must be used for all subsequent fetches unless the *NOOPTLOB precompile option is used.

Numeric comparisons

Numbers are compared algebraically; that is, with regard to sign. For example, -2 is less than $+1$.

If one number is an integer and the other number is decimal, the comparison is made with a temporary copy of the integer that has been converted to decimal.

When decimal or nonzero scale binary numbers with different scales are compared, the comparison is made with a temporary copy of one of the numbers that has been extended with trailing zeros so that its fractional part has the same number of digits as the other number.

If one number is floating point and the other is integer, decimal, or single-precision floating point, the comparison is made with a temporary copy of the second number converted to a double-precision floating-point number. However, if a single-precision floating-point column is compared to a constant and

the constant can be represented by a single-precision floating-point number, the comparison is made with a single-precision form of the constant.

Two floating-point numbers are equal only if the bit configurations of their normalized forms are identical.

If one number is DECFLOAT and the other number is integer, decimal, single precision floating-point, or double precision floating-point, the comparison is made with a temporary copy of the second number converted to DECFLOAT.

If one number is DECFLOAT(16) and the other is DECFLOAT(34), the DECFLOAT(16) value is converted to DECFLOAT(34) before the comparison.

The DECFLOAT data type supports both positive and negative zero. Positive and negative zero have different binary representations, but the equal (=) predicate will return true for comparisons of positive and negative zero.

The DECFLOAT data type allows for multiple bit representations of the same number. For example, 2.00 and 2.0 are two numbers that are numerically equal but have different bit representations. The = (equal) predicate will return true for a comparison of 2.0 = 2.00. Given that 2.0 = 2.00 is true, 2.0 < 2.00 is false. The behavior that is described here holds true for all comparisons of DECFLOAT values (such as for UNION, SELECT DISTINCT, COUNT DISTINCT, basic predicates, IN predicates, MIN, MAX, and so on.) For example:

```
SELECT 2.0 FROM SYSIBM.SYSDUMMY
UNION
SELECT 2.00 FROM SYSIBM.SYSDUMMY
```

yields one row of data. For this query, the value (2.0 or 2.00) that is returned is arbitrary.

The functions COMPARE_DECFLOAT and TOTALORDER can be used to perform comparisons at a binary level. For example, for a comparison of 2.0 <> 2.00. With these functions, decimal floating-point values are compared in the following order: -NaN < -sNaN < -Infinity < -0.10 < -0.100 < -0 < 0 < 0.100 < 0.10 < Infinity < sNaN < NaN

The DECFLOAT data type also supports the specification of positive and negative NaN (quiet and signaling), and positive and negative Infinity. From an SQL perspective, infinity = infinity, NaN = NaN, and sNaN = sNaN.

The DECFLOAT data type also supports the specification of positive and negative NaN (quiet and signaling), and positive and negative infinity.

The following rules are the comparison rules for these special values:

- Infinity compares equal only to infinity of the same sign (positive or negative)
- NaN compares equal only to NaN of the same sign (positive or negative)
- sNaN compares equal only to sNaN of the same sign (positive or negative)

When string and numeric data types are compared, the string is converted to the numeric data type with the same precision and scale, and must contain a valid string representation of a number.

String comparisons

There are two different types of string comparisons.

Binary string comparisons

Binary string comparisons always use a collating sequence of *HEX and the corresponding bytes of each string are compared. Additionally, two binary strings are equal only if the lengths of the two strings are identical. If the strings are equal up to the length of the shorter string length, the shorter string is considered less than the longer string even when the remaining bytes in the longer string are hexadecimal zeros. Note that binary strings cannot be compared to character strings unless the character string is cast to a binary string.

Character and graphic string comparisons

Character and Unicode graphic string comparisons use the collating sequence in effect when the statement is executed for all SBCS data and the single-byte portion of mixed data. If the collating sequence is *HEX, the corresponding bytes of each string are compared. For all other collating sequences, the corresponding bytes of the weighted value of each string are compared.

If the strings have different lengths, a temporary copy of the shorter string is padded on the right with blanks before comparison. The padding makes each string the same length. The pad character is always a blank, regardless of the collating sequence. For bit data, the pad character is also a blank. For DBCS graphic data, the pad character is a DBCS blank (x'4040'). For Unicode graphic data, the pad character is a UTF-16 blank.²⁹

Two strings are equal if any of the following are true:

- Both strings are empty.
- A *HEX collating sequence is used and all corresponding bytes are equal.
- A collating sequence other than *HEX is used and all corresponding bytes of the weighted value are equal.

An empty string is equal to a blank string. The relationship between two unequal strings is determined by a comparison of the first pair of unequal bytes (or bytes of the weighted value) from the left end of the string. This comparison is made according to the collating sequence in effect when the statement is executed.

In an application that will run in multiple environments, the same collating sequence (which depends on the CCSIDs of the environments) must be used to ensure identical results. The following table illustrates the differences between EBCDIC, ASCII, and the Db2 LUW default collating sequence for United States English by showing a list that is sorted according to each one.

Table 20. Collating Sequence Differences

ASCII and Unicode	EBCDIC	Db2 LUW Default
0000	@@@	0000
9999	co-op	9999
@@@@	coop	@@@@
COOP	piano forte	co-op
PIANO-FORTE	piano-forte	COOP
co-op	COOP	coop
coop	PIANO-FORTE	piano forte
piano forte	0000	PIANO-FORTE
piano-forte	9999	piano-forte

Two varying-length strings with different lengths are equal if they differ only in the number of trailing blanks. In operations that select one value from a set of such values, the value selected is arbitrary. The operations that can involve such an arbitrary selection are DISTINCT, MAX, MIN, UNION, EXCEPT, INTERSECT, and references to a grouping column. See [“group-by-clause” on page 751](#) for more information about the arbitrary selection involved in references to a grouping column.

Conversion rules for comparison:

When two strings are compared, one of the strings is first converted, if necessary, to the coded character set of the other string. Character conversion is necessary only if all of the following are true:

²⁹ UTF-16 defines a blank character at code point X'0020' and X'3000'. The database manager pads with the blank at code point X'0020'.

- The CCSIDs of the two strings are different.
- Neither CCSID is 65535.
- The string selected for conversion is neither null nor empty.
- Conversion between the two CCSIDs is required. For more information, see [“Coded character sets and CCSIDs”](#) on page 32.

If two strings with different encoding schemes are compared, any necessary conversion applies to the string as follows:

First Operand	Second Operand			
	SBCS Data	DBCS Data	Mixed Data	Unicode Graphic Data
SBCS Data	see below	second	second	second
DBCS Data	first	see below	second	second
Mixed Data	first	first	see below	second
Unicode Graphic Data	first	first	first	see below

Otherwise, the string selected for conversion depends on the type of each operand. The following table shows which operand is selected for conversion, given the operand types:

First Operand	Second Operand				
	Column Value	Derived Value	Special Register	Constant	Variable
Column Value	second	second	second	second	second
Derived Value	first	second	second	second	second
Special Register	first	first	second	second	second
Constant	first	first	first	second	second
Variable	first	first	first	first	second

A variable that contains data in a foreign encoding scheme is always effectively converted to the native encoding scheme before it is used in any operation. The above rules are based on the assumption that this conversion has already occurred.

An error is returned if a character of the string cannot be converted or if the conversion between the pair of CCSIDs is not defined. For more information, see [“Coded character sets and CCSIDs”](#) on page 32. A warning occurs if a character of the string is converted to the substitution character.

Datetime comparisons

A DATE, TIME, or TIMESTAMP value can be compared either with another value of the same data type, a datetime constant of the same data type, or with a string representation of that data type. A date value or a string representation of a date can also be compared with a TIMESTAMP, where the missing time information for the date value is assumed to be all zeros. All comparisons are chronological, which means the farther a point in time is from January 1, 0001, the greater the value of that point in time.

Comparisons involving TIME values and string representations of time values always include seconds. If the string representation omits seconds, zero seconds are implied. The time 24:00:00 compares greater than the time 00:00:00.

Comparisons involving `TIMESTAMP` values are evaluated according to the following rules:

- When comparing timestamp values with different precisions, the higher precision is used for the comparison and any missing digits for fractional seconds are assumed to be zero.
- When comparing a timestamp value with a string representation of a timestamp, the string representation is first converted to `TIMESTAMP(12)`.
- Timestamp comparisons are chronological without regard to representations that might be considered equivalent. Thus, the following predicate is true:

```
TIMESTAMP('1990-02-23-00.00.00') > '1990-02-22-24.00.00'
```

XML comparisons

The XML data type cannot be compared to any data type, including the XML data type.

DataLink comparisons

A `DATALINK` operand cannot be directly compared to any data type. The `DLCOMMENT`, `DLLINKTYPE`, `DLURLCOMPLETE`, `DLURLPATH`, `DLURLPATHONLY`, `DLURLSCHEME`, and `DLURLSERVER` scalar functions can be used to extract character string values from a datalink which can then be compared to other strings.

Row ID comparisons

A `ROWID` operand cannot be directly compared to any data type. To compare the bit representation of a `ROWID`, first cast the `ROWID` to a character string.

Distinct type comparisons

The rules for comparisons involving user-defined type values depend on whether the distinct type is a strongly typed distinct type or a weakly typed distinct type.

Strongly typed distinct type comparisons

A value with a strongly typed distinct type can be compared only to another value with exactly the same strongly typed distinct type.

For example, assume that distinct type `YOUTH` and table `CAMP_DB2_ROSTER` table were created with the following SQL statements:

```
CREATE TYPE YOUTH AS INTEGER WITH COMPARISONS
CREATE TABLE CAMP_DB2_ROSTER
( NAME          VARCHAR(20),
  ATTENDEE_NUMBER INTEGER NOT NULL,
  AGE           YOUTH,
  HIGH_SCHOOL_LEVEL YOUTH)
```

The following comparison is valid because `AGE` and `HIGH_SCHOOL_LEVEL` have the same distinct type:

```
SELECT * FROM CAMP_DB2_ROSTER
WHERE AGE > HIGH_SCHOOL_LEVEL
```

The following comparison is not valid:

```
SELECT * FROM CAMP_DB2_ROSTER          ***INCORRECT***
WHERE AGE > ATTENDEE_NUMBER
```

However, `AGE` can be compared to `ATTENDEE_NUMBER` by using a cast function or `CAST` specification to cast between the distinct type and the source type. All of the following comparisons are valid:

```
SELECT * FROM CAMP_DB2_ROSTER
WHERE AGE > YOUTH(ATTENDEE_NUMBER)

SELECT * FROM CAMP_DB2_ROSTER
WHERE AGE > CAST(ATTENDEE_NUMBER AS YOUTH)

SELECT * FROM CAMP_DB2_ROSTER
WHERE INTEGER(AGE) > ATTENDEE_NUMBER

SELECT * FROM CAMP_DB2_ROSTER
WHERE CAST(AGE AS INTEGER) > ATTENDEE_NUMBER
```

Weakly typed distinct type comparisons

Values with a weakly typed distinct type are compared according to the comparison rules for the source type of the distinct type. It is valid to compare different weakly typed distinct types if the underlying source types are comparable.

Array type comparisons

Comparisons of array type values are not supported.

Elements of arrays can be compared based on the comparison rules for the data type of the elements.

Rules for result data types

The data types of a result are determined by rules which are applied to the operands in an operation. This section explains those rules.

These rules apply to:

- Corresponding columns in UNION, UNION ALL, EXCEPT, or INTERSECT operations
- Result expressions of a CASE expression
- Arguments of the scalar functions COALESCE, IFNULL, MAX, MIN, and VALUE
- Expression values of the IN list of an IN predicate
- Arguments for the aggregation group ranges in OLAP specifications

For the result data type of expressions that involve the operators /, *, + and -, see [“With arithmetic operators”](#) on page 160. For the result data type of expressions that involve the CONCAT operator, see [“With the concatenation operator”](#) on page 164.

The data type of the result is determined by the data type of the operands. The data types of the first two operands determine an intermediate result data type, this data type and the data type of the next operand determine a new intermediate result data type, and so on. The last intermediate result data type and the data type of the last operand determine the data type of the result. For each pair of data types, the result data type is determined by the sequential application of the rules summarized in the tables that follow.

If neither operand column allows nulls, the result does not allow nulls. Otherwise, the result allows nulls.

If the data type and attributes of any operand column are not the same as those of the result, the operand column values are converted to conform to the data type and attributes of the result. The conversion operation is exactly the same as if the values were assigned to the result. For example,

- If one operand column is CHAR(10), and the other operand column is CHAR(5), the result is CHAR(10), and the values derived from the CHAR(5) column are padded on the right with five blanks.
- If the whole part of a number cannot be preserved then an error is returned.

Numeric operands

Numeric types are compatible with other numeric and character-string and graphic-string data types.

If one operand column is...	And the other operand is...	The data type of the result column is...
SMALLINT	SMALLINT or String	SMALLINT
INTEGER	SMALLINT, INTEGER, or String	INTEGER
BIGINT	SMALLINT, INTEGER, BIGINT, or String	BIGINT
DECIMAL(w,x)	SMALLINT	DECIMAL(p,x) where p = min(mp, x+max(w-x,5)) mp = 31 or 63 (See Note 1)
DECIMAL(w,x)	INTEGER	DECIMAL(p,x) where p = min(mp, x+max(w-x,11)) mp = 31 or 63 (See Note 1)
DECIMAL(w,x)	BIGINT	DECIMAL(p,x) where p = min(mp, x+max(w-x,19)) mp = 31 or 63 (See Note 1)

If one operand column is...	And the other operand is...	The data type of the result column is...
DECIMAL(w,x)	DECIMAL(y,z) or NUMERIC(y,z)	DECIMAL(p,s) where p = min(mp, max(x,z)+max(w-x,y-z)) s = max(x,z) mp = 31 or 63 (See Note 1)
DECIMAL(w,x)	String	DECIMAL(w,x)
NUMERIC(w,x)	SMALLINT	NUMERIC(p,x) where p = min(mp, x + max(w-x,5)) mp = 31 or 63 (See Note 1)
NUMERIC(w,x)	INTEGER	NUMERIC(p,x) where p = min(mp, x + max(w-x,11)) mp = 31 or 63 (See Note 1)
NUMERIC(w,x)	BIGINT	NUMERIC(p,x) where p = min(mp, x + max(w-x,19)) mp = 31 or 63 (See Note 1)
NUMERIC(w,x)	NUMERIC(y,z)	NUMERIC(p,s) where p = min(mp, max(x,z) + max(w-x, y-z)) s = max(x,z) mp = 31 or 63 (See Note 1)
NUMERIC(w,x)	String	NUMERIC(w,x)
NONZERO SCALE BINARY	NONZERO SCALE BINARY	NONZERO SCALE BINARY (If either operand is nonzero scale binary, both operands must be binary with the same scale.)
REAL	REAL	REAL
REAL	SMALLINT, INTEGER, BIGINT, DECIMAL, NUMERIC, or String	DOUBLE
DOUBLE	SMALLINT, INTEGER, BIGINT, DECIMAL, NUMERIC, REAL, DOUBLE, or String	DOUBLE
DECFLOAT(n)	REAL, DOUBLE, INTEGER, or SMALLINT	DECFLOAT(n)
DECFLOAT(n)	DECIMAL(p<=16,s) or NUMERIC(p<=16,s)	DECFLOAT(n)
DECFLOAT(n)	BIGINT, DECIMAL(p>16,s), or NUMERIC(p>16,s)	DECFLOAT(34)
DECFLOAT(n)	DECFLOAT(m)	DECFLOAT(max(n,m))

If one operand column is...	And the other operand is...	The data type of the result column is...
DECFLOAT(n)	String	DECFLOAT(34)

Notes:

1. The value of mp is 63 if:

- either w or y is greater than 31, or
- a value of 63 was specified for the maximum precision on the DECRESULT parameter of the CRTSQLxxx command, RUNSQLSTM command, or SET OPTION statement

Otherwise, the value of mp is 31.

Character and graphic string operands

Character and graphic strings are compatible with other character and graphic strings when there is a defined conversion between their corresponding CCSIDs. A character string and a graphic string are compatible if the encoding scheme of the graphic-string data type is Unicode and the character-string data type is not bit data.

If one operand column is...	And the other operand is...	The data type of the result column is...
CHAR(x)	CHAR(y)	CHAR(z) where z = max(x,y)
GRAPHIC(x)	CHAR(y) or GRAPHIC(y)	GRAPHIC(z) where z = max(x,y)
VARCHAR(x)	CHAR(y) or VARCHAR(y)	VARCHAR(z) where z = max(x,y)
VARCHAR(x)	GRAPHIC(y)	VARGRAPHIC(z) where z = max(x,y)
VARGRAPHIC(x)	CHAR(y), VARCHAR(y), GRAPHIC(y), or VARGRAPHIC(y)	VARGRAPHIC(z) where z = max(x,y)
CLOB(x)	CHAR(y), VARCHAR(y), or CLOB(y)	CLOB(z) where z = max(x,y)
CLOB(x)	GRAPHIC(y) or VARGRAPHIC(y)	DBCLOB(z) where z = max(x,y)
DBCLOB(x)	CHAR(y), VARCHAR(y), CLOB(y), GRAPHIC(y), VARGRAPHIC(y), or DBCLOB(y)	DBCLOB(z) where z = max(x,y)

When one of the operands has a CCSID of 1208, the length (x or y value) of every operand that does not have a CCSID of 1208 is doubled for determining the result length.

The CCSID of the result graphic string will be derived based on the [“Conversion rules for operations that combine strings”](#) on page 112.

Binary string operands

Binary strings are compatible only with other binary strings or character strings FOR BIT DATA. Other data types can be treated as a binary-string data type by using the BINARY, VARBINARY, or BLOB scalar functions to cast the data type to a binary string.

If one operand column is...	And the other operand is...	The data type of the result column is...
BINARY(x)	BINARY(y) or CHAR(y) FOR BIT DATA	BINARY(z) where z = max(x,y)

If one operand column is...	And the other operand is...	The data type of the result column is...
VARBINARY(x)	BINARY(y), VARBINARY(y), CHAR(y) FOR BIT DATA, or VARCHAR(y) FOR BIT DATA	VARBINARY(z) where z = max(x,y)
VARCHAR(x) FOR BIT DATA	BINARY(y)	VARBINARY(z) where z = max(x,y)
BLOB(x)	BINARY(y), VARBINARY(y), BLOB(y), CHAR(y) FOR BIT DATA, or VARCHAR(y) FOR BIT DATA	BLOB(z) where z = max(x,y)

Datetime operands

A DATE type is compatible with another DATE type or any character or Unicode graphic string expression that contains a valid string representation of a date. The data type of the result is DATE.

A TIME type is compatible with another TIME type or any character or Unicode graphic string expression that contains a valid string representation of a time. The data type of the result is TIME.

A TIMESTAMP type is compatible with another TIMESTAMP type, a DATE type, or any character or Unicode graphic string expression that contains a valid string representation of a date or a timestamp. The data type of the result is TIMESTAMP.

If one operand column is...	And the other operand is...	The data type of the result column is...
DATE	DATE, CHAR(y), VARCHAR(y), CLOB(y), GRAPHIC(y), VARGRAPHIC(y), or DBCLOB(y)	DATE
TIME	TIME, CHAR(y), VARCHAR(y), CLOB(y), GRAPHIC(y), VARGRAPHIC(y), or DBCLOB(y)	TIME
TIMESTAMP(x)	TIMESTAMP(y)	TIMESTAMP(max(x,y))
TIMESTAMP(x)	DATE, CHAR(y), VARCHAR(y), CLOB(y), GRAPHIC(y), VARGRAPHIC(y), or DBCLOB(y)	TIMESTAMP(x)

DataLink operands

A DataLink is compatible with another DataLink. However, DataLinks with NO LINK CONTROL are only compatible with other DataLinks with NO LINK CONTROL; DataLinks with FILE LINK CONTROL READ PERMISSION FS are only compatible with other DataLinks with FILE LINK CONTROL READ PERMISSION FS; and DataLinks with FILE LINK CONTROL READ PERMISSION DB are only compatible with other DataLinks with FILE LINK CONTROL READ PERMISSION DB. The data type of the result is DATALINK. The length of the result DATALINK is the largest length of all the data types.

If one operand column is...	And the other operand is...	The data type of the result column is...
DATALINK(x)	DATALINK(y)	DATALINK(z) where z = max(x,y)

ROWID operands

A ROWID is compatible with another ROWID. The data type of the result is ROWID.

XML operands

The XML data type is compatible only with another XML data type. The data type of the result is XML.

The result CCSID is the value from the SQL_XML_DATA_CCSID QAQQINI option setting as described in [“XML Values” on page 80](#).

Distinct type operands

A strongly typed distinct type value is compatible only with another value of the same distinct type. The data type of the result is the distinct type.

If both operands have the same weakly typed distinct type, the result is the weakly typed distinct type. Otherwise, if any operand is a weakly typed distinct type then the data type of the operand is considered to be the source data type and the result data type is determined based on the combination of built-in data type operands.

Conversion rules for operations that combine strings

The operations that combine strings are concatenation, UNION, UNION ALL, EXCEPT, and INTERSECT. (These rules also apply to the MAX, MIN, VALUE, COALESCE, IFNULL, and CONCAT scalar functions and CASE expressions.) In each case, the CCSID of the result is determined at bind time, and the execution of the operation may involve conversion of strings to the coded character set identified by that CCSID.

The CCSID of the result is determined by the CCSIDs of the operands. The CCSIDs of the first two operands determine an intermediate result CCSID, this CCSID and the CCSID of the next operand determine a new intermediate result CCSID, and so on. The last intermediate result CCSID and the CCSID of the last operand determine the CCSID of the result string or column. For each pair of CCSIDs, the result CCSID is determined by the sequential application of the following rules:

- If the CCSIDs are equal, the result is that CCSID.
- If either CCSID is 65535, the result is 65535.³⁰
- If one CCSID denotes data in an encoding scheme different from the other CCSID, the result is determined by the following table:

Table 23. Selecting the Encoding Scheme of the Intermediate Result

First Operand	Second Operand			
	SBCS Data	DBCS Data	Mixed Data	Unicode Graphic Data
SBCS Data	see below	second	second	second
DBCS Data	first	see below	second	second
Mixed Data	first	first	see below	second
Unicode Graphic Data	first	first	first	see below

- Otherwise, the resulting CCSID is determined by the following tables:

Table 24. Selecting the CCSID of the Intermediate Result

First Operand	Second Operand				
	Column Value	Derived Value	Constant	Special Register	Variable
Column Value	first	first	first	first	first
Derived Value	second	first	first	first	first
Constant	second	second	first	first	first
Special Register	second	second	first	first	first
Variable	second	second	second	second	first

A variable containing data in a foreign encoding scheme is effectively converted to the native encoding scheme before it is used in any operation. The above rules are based on the assumption that this conversion has already occurred.

³⁰ If either operand is a CLOB or DBCLOB, the resulting CCSID is the job default CCSID.

Note that an intermediate result is considered to be a derived value operand. For example, assume COLA, COLB, and COLC are columns with CCSIDs 37, 278, and 500, respectively. The result CCSID of COLA CONCAT COLB CONCAT COLC is determined as follows:

1. The result CCSID of COLA CONCAT COLB is first determined to be 37 because both operands are columns, so the CCSID of the first operand is chosen.
2. The result CCSID of “intermediate result” CONCAT COLC is determined to be 500, because the first operand is a derived value and the second operand is a column, so the CCSID of the second operand is chosen.

An operand of concatenation, or the result expression of the CASE expression, or the operands of the IN predicate, or the selected argument of the MAX, MIN, VALUE, COALESCE, IFNULL, or CONCAT scalar function is converted, if necessary, to the coded character set of the result string. Each string of an operand of UNION, UNION ALL, EXCEPT, or INTERSECT is converted, if necessary, to the coded character set of the result column. Character conversion is necessary only if all of the following are true:

- The CCSIDs are different.
- Neither CCSID is 65535.
- The string is neither null nor empty.
- Conversion between the two CCSIDs is required. For more information, see [“Coded character sets and CCSIDs” on page 32](#).

An error is returned if a character of the string cannot be converted or if the conversion between the pair of CCSIDs is not defined. For more information, see [“Coded character sets and CCSIDs” on page 32](#). A warning occurs if a character of a string is converted to the substitution character.

Constants

A *constant* (also called a *literal*) specifies a value. Constants are classified as string constants or numeric constants. String constants are further classified as character or graphic. Numeric constants are further classified as integer, floating point, or decimal.

All constants have the attribute NOT NULL. A negative sign in a numeric constant with a value of zero is ignored.

Integer constants

An *integer constant* specifies an integer as a signed or unsigned number with a maximum of 19 digits that does not include a decimal point. The data type of an integer constant is large integer if its value is within the range of a large integer. The data type of an integer constant is big integer if its value is outside the range of a large integer, but within the range of a big integer. A constant that is defined outside the range of big integer values is considered a decimal constant.

Examples

```
64      -15      +100      32767      720176      12345678901
```

In syntax diagrams, the term *integer* is used for a large integer constant that must not include a sign.

Decimal constants

A *decimal constant* specifies a decimal number as a signed or unsigned number that consists of no more than 63 digits and either includes a decimal point or is not within the range of binary integers.

The precision is the total number of digits (including leading and trailing zeros); the scale is the number of digits to the right of the decimal point (including trailing zeros). If the precision of the decimal constant is greater than the largest decimal precision and the scale is not greater than the largest decimal precision, then leading zeroes to the left of the decimal point are eliminated to reduce the precision to the largest decimal precision.

Examples

```
25.5      1000.      -15.      +37589.3333333333
```

Floating-point constants

A *floating-point constant* specifies a double-precision floating-point number as two numbers separated by an E. The first number can include a sign and a decimal point; the second number can include a sign but not a decimal point. The value of the constant is the product of the first number and the power of 10 specified by the second number; it must be within the range of floating-point numbers. The number of characters in the constant must not exceed 24. Excluding leading zeros, the number of digits in the first number must not exceed 17 and the number of digits in the second must not exceed 3.

Examples

```
15E1      2.E5      2.2E-1      +5.E+2
```

Decimal floating-point constants

A *decimal floating-point constant* specifies a decimal floating-point number as two numbers separated by an E. The first number can include a sign and a decimal point; the second number can include a sign but not a decimal point. The value of the constant is the product of the first number and the power of 10 specified by the second number; it must be within the range of DECFLOAT(34). The number of characters

in the constant must not exceed 42. Excluding leading zeros, the number of digits in the first number must not exceed 34 and the number of digits in the second must not exceed 4.

A constant specified as two numbers separated by E is a decimal floating-point constant only if:

- Excluding leading zeros, the number of digits in the first number exceeds 17 (precision).
- The exponent is outside of the range of double floating-point numbers (smaller than -308 or larger than 308).

In addition to numeric constants, the following reserved keywords can be used to specify decimal floating-point special values. These special values are: INFINITY, NAN, and SNAN. INFINITY represents infinity, a number whose magnitude is infinitely large. INFINITY can be preceded by an optional sign. INF can be specified in place of INFINITY. NAN represents Not a Number (NaN) and is sometimes called quiet NaN. It is a value that represents undefined results which does not cause a warning or exception. SNAN represents signaling NaN (sNaN). It is a value that represents undefined results which will cause a warning or exception if used in any operation that is defined in any numerical operation. Both NAN and SNAN can be preceded by an optional sign, but the sign is not significant for arithmetic operations. SNAN can be used in non-numerical operations without causing a warning or exception, for example in the VALUES list of an INSERT or as a constant compared in a predicate.

When one of the special values (INFINITY, INF, NAN, and SNAN) is used in a context where it could be interpreted as an identifier, such as a column name, cast a string constant representing the special value to decimal-floating point.

```
CAST('snan' AS DECFLOAT(34))
CAST('INF' AS DECFLOAT(34))
CAST('NaN' AS DECFLOAT(34))
```

Examples

```
1.8E308    -1.23456789012345678E-2    SNAN    -INFINITY
```

Character-string constants

A *character-string constant* specifies a varying-length character string.

The two forms of character-string constant follow:

- A sequence of characters that starts and ends with a string delimiter. The number of bytes between the string delimiters cannot be greater than 32740. Two consecutive string delimiters are used to represent one string delimiter within the character string. Two consecutive string delimiters that are not contained within a string represent the empty string.
- An X followed by a sequence of characters that starts and ends with a string delimiter. The characters between the string delimiters must be an even number of hexadecimal digits. Blanks between the string delimiters are ignored. The number of hexadecimal digits must not exceed 32762. A hexadecimal digit is a digit or any of the letters A through F (uppercase or lowercase). Under the conventions of hexadecimal notation, each pair of hexadecimal digits represents a character. This form of string constant allows you to specify characters that do not have a keyboard representation.

Character-string constants can contain mixed data. If the job CCSID supports mixed data, a character-string constant is classified as mixed data if it includes a DBCS substring. In all other cases, a character-string constant is classified as SBCS data.

The CCSID assigned to the constant is the CCSID of the SQL statement text containing the constant unless the SQL statement is encoded in Unicode or a foreign encoding scheme (such as ASCII). In this case, the SQL statement text is converted from Unicode or the foreign encoding scheme to the default CCSID of the current server. The CCSID assigned to the constant will be the default CCSID of the current server³¹.

The CCSID of the SQL statement text is defined in the following table.

³¹ If the default CCSID is 65535, the CCSID used will be the value of the DFTCCSID job attribute.

Table 25. CCSID of the SQL statement text for different interfaces

SQL Interface	CCSID of SQL statement text
Embedded SQL	<ul style="list-style-type: none"> For static statements, the CCSID of the source file for the CRTSQLxxx command. For dynamic statements, the CCSID of the variable specified on the PREPARE statement, or if a string constant is specified on the PREPARE statement, the CCSID of the source file for the CRTSQLxxx command.
RUNSQLSTM	The CCSID of the specified source file.
STRSQL and RUNSQL	The default CCSID of the current server.
Call Level Interface (CLI) on the server	<p>Unicode, if SQL_ATTR_UCS2, SQL_ATTR_UTF8, or wide APIs are specified.</p> <p>Otherwise, the default CCSID of the current server. The SQL_ATTR_NON_HEXCCSID environment variable can be used to specify the DFTCCSID job attribute instead.</p>
ODBC on a client using the IBM i Access Family ODBC Driver	<p>Unicode, if UNICODESQL is specified.</p> <p>Otherwise, the default CCSID of the current server. If the default CCSID is 65535, the CCSID used will be the value of the DFTCCSID job attribute.</p>
JDBC or SQLJ on the server using IBM Developer Kit for Java	Unicode
JDBC on a client using the IBM Toolbox for Java	Unicode
OLE DB on a client using the IBM i Access Family OLE DB Provider	Unicode
.ADO .NET on a client using the IBM i Access Family ODO .NET Provider	Unicode

Character-string constants are used to represent constant datetime values in assignments and comparisons. For more information see [“String representations of datetime values”](#) on page 75.

Examples

```
'Peggy' '14.12.1990' '32' 'DON'T CHANGE' '' X'FFFF'
```

Graphic-string constants

There are two types of graphic-string constants: DBCS and Unicode graphic-string constants.

DBCS graphic-string constants

A *graphic-string constant* is a varying-length graphic string. The length of the specified string cannot be greater than 16370. The forms of DBCS graphic-string constants are:

Context	Graphic String Constant	Empty String	Example
All contexts	G ' _s d b c s - s t r i n g _s ' _I	G ' _s _s ' _I G '' g ' _s _s ' _I g ''	G ' _s 元 気 _s ' _I
PL/I	_s ' d b c s - s t r i n g ' G _s _I	_s ' ' G _s _I	_s ' 元 気 ' G _s _I

R139F000-1

In the normal form, the SQL delimiters and the G is an SBCS character. The SBCS ' is the EBCDIC apostrophe, X'7D'.

In the PL/I form, the apostrophes and the G are DBCS characters. Two consecutive DBCS string delimiters are used to represent one string delimiter within the string. Note that this PL/I form is only valid for static statements embedded in PL/I programs.

A hexadecimal DBCS graphic constant is also supported. The form of the hexadecimal DBCS graphic constant is:

GX'ssss'

In this constant, **ssss** represents a string from 0 to 32760 hexadecimal digits. The number of characters between the string delimiters must be an even multiple of 4. Blanks between the string delimiters are ignored. Each group of 4 digits represents a single DBCS graphic character. The hexadecimal for shift-in and shift-out ('0E'X and '0F'X) are not included in the string.

The CCSID assigned to constants is the DBCS CCSID associated with the CCSID of the source unless the source is encoded in a foreign encoding scheme (such as ASCII). In this case, the CCSID assigned to the constant is the DBCS CCSID associated with the default CCSID of the current server when the SQL statement containing the constant is prepared. If there is no DBCS CCSID associated with the CCSID of the source, the CCSID is 65535.

For information about associated DBCS CCSIDs, see the Use DBCS CCSIDs topic in the IBM i Information Center. For information about the CCSID of the source, see Character String Constants.

Unicode graphic-string constants

There are two types of Unicode graphic-string constants: N and UX. The form of the Unicode graphic constant is:

N'ssss'

In the constant, **ssss** is a string of 16370 characters. The characters are converted from the source CCSID to the Unicode CCSID during processing.

The form of the hexadecimal Unicode graphic constant is:

UX'ssss'

In the constant, **ssss** represents a string from 0 to 32760 hexadecimal digits. The number of characters between the string delimiters must be an even multiple of 4. Blanks between the string delimiters are ignored. Each group of 4 or more digits represents a single Unicode graphic character.

The CCSID of a Unicode graphic-string constant is 13488 (UCS-2). If the standards option is specified, the CCSID is 1200 (UTF-16). For information about the standards option, see [“Standards compliance” on page xix](#).

Binary-string constants

A *binary-string constant* specifies a varying-length binary string.

The two forms of a binary-string constant are:

- A BX followed by a sequence of characters that starts and ends with a string delimiter. The characters between the string delimiters must be an even number of hexadecimal digits. Blanks between the string

delimiters are ignored. The number of hexadecimal digits must not exceed 32740. A hexadecimal digit is a digit or any of the letters A through F (uppercase or lowercase).

- An X followed by a sequence of characters that starts and ends with a string delimiter. The characters between the string delimiters must be an even number of hexadecimal digits. Blanks between the string delimiters are ignored. The number of hexadecimal digits must not exceed 32740. A hexadecimal digit is a digit or any of the letters A through F (uppercase or lowercase).

The CCSID assigned to the constant is 65535.

Note that the syntax of the second form of binary string constant is identical to the second form of a character constant. A constant of this form is only treated as a binary string constant if the standards option is specified. For information on the standards option, see [“Standards compliance”](#) on page xix.

Examples

```
BX'FFFF'  
X'FFFF'
```

Datetime constants

A *datetime constant* specifies a date, time, or timestamp.

Typically, character-string constants are used to represent constant datetime values in assignments and comparisons. For information on string representations of datetime values, see [“String representations of datetime values”](#) on page 75. However, the ANSI/ISO SQL standard form of a datetime constant can be used to specifically denote the constant as a *datetime constant* instead of a string constant.

The format for the three ANSI/ISO SQL standard datetime constants are:

- DATE 'yyyy-mm-dd'

The data type of the value is DATE.

- TIME 'hh:mm:ss'

The data type of the value is TIME.

- TIMESTAMP 'yyyy-mm-dd hh:mm:ss.nnnnnnnnnnn'

The data type of the value is TIMESTAMP(*p*), where *p* is the number of digits of fractional seconds.

Trailing zeros can be truncated or omitted entirely from fractional seconds.

Leading zeros must not be omitted from any part of a standard datetime constant.

Example

```
DATE '2003-09-03'
```

Decimal point

You can specify a *default decimal point*.

The *default decimal point* can be specified:

- To interpret numeric constants
- To determine the decimal point character to use when casting a character string to a number (for example, in the DECFLOAT, DECIMAL, DOUBLE_PRECISION, FLOAT, and REAL scalar functions and the CAST specification)
- To determine the decimal point character to use in the result when casting a number to a string (for example, in the CHAR, VARCHAR, CLOB, GRAPHIC, and VARGRAPHIC scalar functions and the CAST specification)

The default decimal point can be specified through the following interfaces:

Table 26. Default Decimal Point Interfaces

SQL Interface	Specification
Embedded SQL	<p>The *JOB, *PERIOD, *COMMA, or *SYSVAL value in the OPTION parameter is specified on the Create SQL Program (CRTSQLxxx) commands. The SET OPTION statement can also be used to specify the DECMPT parameter within the source of a program containing embedded SQL.</p> <p>(For more information about CRTSQLxxx commands, see Embedded SQL programming.)</p>
Interactive SQL and Run SQL Statements	<p>The DECPNT parameter on the Start SQL (STRSQL) command or by changing the session attributes. The DECMPT parameter on the Run SQL Statements (RUNSQLSTM) command.</p> <p>(For more information about STRSQL and RUNSQLSTM commands, see SQL programming.)</p>
Call Level Interface (CLI) on the server	<p>SQL_ATTR_DECIMAL_SEP environment or connection variables</p> <p>(For more information about CLI, see SQL Call Level Interfaces (ODBC).)</p>
JDBC or SQLJ on the server using IBM IBM Developer Kit for Java	<p>Decimal Separator connection property</p> <p>(For more information about JDBC and SQLJ, see IBM Developer Kit for Java.)</p>
ODBC on a client using the IBM i Access Family ODBC Driver	<p>Decimal Separator in the Advanced Server Options in ODBC Setup</p> <p>(For more information about ODBC, see IBM i Access.)</p>
JDBC on a client using the IBM Toolbox for Java	<p>Format in JDBC Setup</p> <p>(For more information about ODBC, see IBM i Access.)</p> <p>(For more information about the IBM Toolbox for Java, see IBM Toolbox for Java.)</p>

If the comma is the decimal point, the following rules apply:

- A period will also be allowed as a decimal point.
- A comma intended as a separator of numeric constants in a list must be followed by a space.
- A comma intended as a decimal point must not be followed by a space.

Thus, to specify a decimal constant without a fractional part, the trailing comma must be followed by a non-blank character. The non-blank character can be a separator comma, as in:

```
VALUES(9999999999, , 111)
```

Delimiters

*APOST and *QUOTE are mutually exclusive COBOL precompiler options that name the string delimiter within COBOL statements. *APOST names the apostrophe (') as the string delimiter; *QUOTE names the

quotation mark ("). *APOST and *QUOTE are mutually exclusive COBOL precompiler options that play a similar role for SQL statements embedded in COBOL programs. *APOST names the apostrophe (') as the SQL string delimiter; with this option, the quotation mark (") is the SQL escape character. *QUOTE names the quotation mark as the SQL string delimiter; with this option, the apostrophe is the SQL escape character. The values of *APOST and *QUOTE are respectively the same as the values of *APOST and *QUOTE.

In host languages other than COBOL, the usages are fixed. The string delimiter for the host language and for static SQL statements is the apostrophe ('); the SQL escape character is the quotation mark (").

Special registers

A *special register* is a storage area that is defined for an application process by database manager and is used to store information that can be referenced in SQL statements. A reference to a special register is a reference to a value provided by the current server. If the value is a string, its CCSID is a default CCSID of the current server.

The special registers can be referenced as follows:

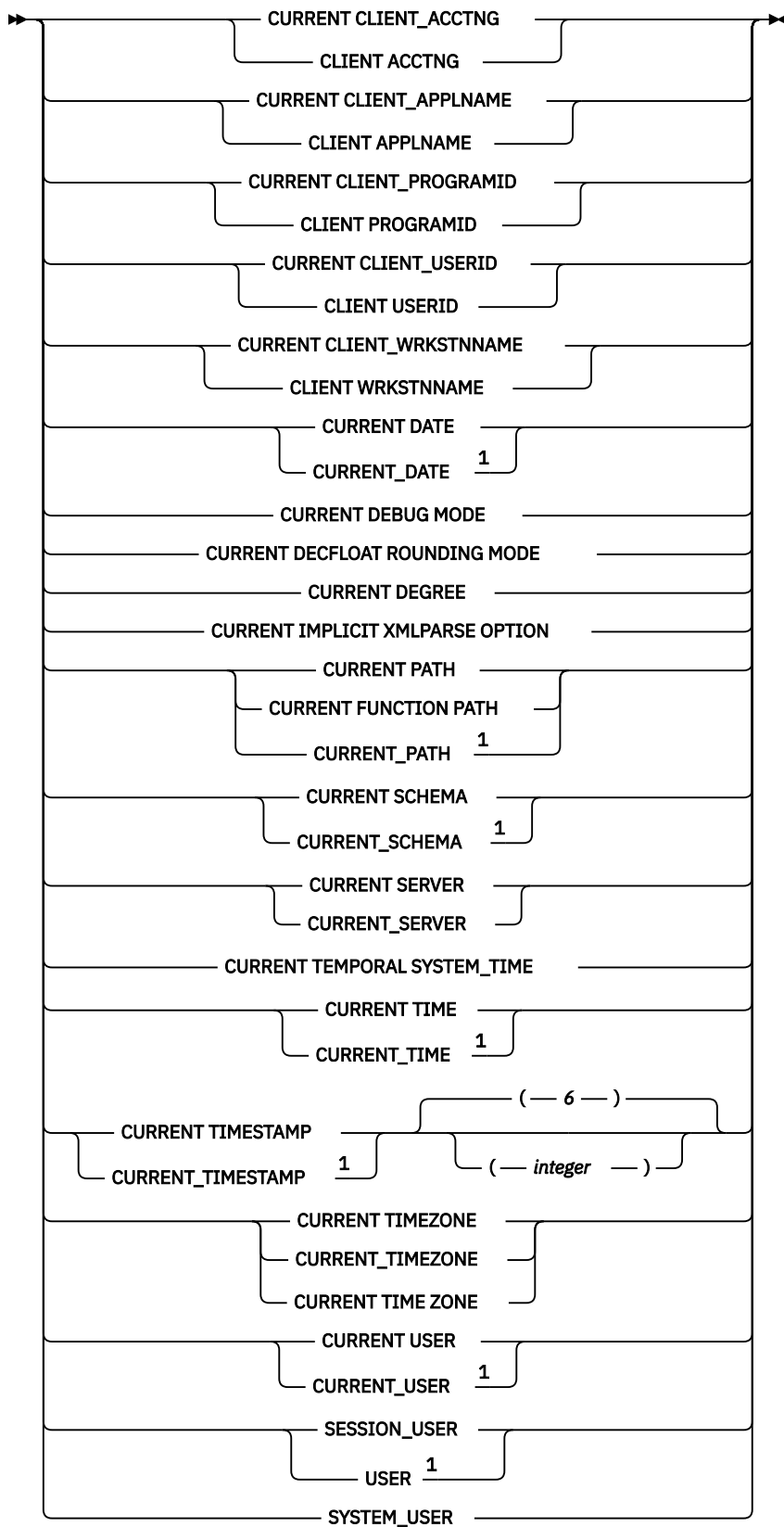

Notes:

¹ The SQL 2003 Core standard uses the form with the underscore.

The value of these special registers, except for CURRENT TEMPORAL SYSTEM_TIME, cannot be null.

CURRENT CLIENT_ACCTNG

The CURRENT CLIENT_ACCTNG special register specifies a VARCHAR(255) value that contains the value of the accounting string from the client information specified for the current connection.

The default value of this register is the empty string. The value of the accounting string can be changed through these interfaces:

- The [Set Client Information \(SQLESETI\)](#) API can change the client special register.
- The SYSPROC.WLM_SET_CLIENT_INFO procedure can change the client special register.
- In CLI, SQLSetConnectAttr() can be used to set the SQL_ATTR_INFO_ACCTSTR connection attribute.
- In ODBC, SQLSetConnectAttr() can be used to set the ODBC_ATTR_INFO_ACCTSTR connection attribute.
- In JDBC, the setClientInfo connection method can be used to set the ClientAccounting connection property.

Example

Get the current value of the accounting string for this connection

```
VALUES CURRENT_CLIENT_ACCTNG  
INTO :ACCT_STRING
```

CURRENT CLIENT_APPLNAME

The CURRENT CLIENT_APPLNAME special register specifies a VARCHAR(255) value that contains the value of the application name from the client information specified for the current connection.

The default value of this register is the empty string. The value of the application name can be changed through these interfaces:

- The Set Client Information (SQLESETI) API can change the client special register.
- The SYSPROC.WLM_SET_CLIENT_INFO procedure can change the client special register.
- In CLI, SQLSetConnectAttr() can be used to set the SQL_ATTR_INFO_APPLNAME connection attribute.
- In ODBC, SQLSetConnectAttr() can be used to set the ODBC_ATTR_INFO_APPLNAME connection attribute.
- In JDBC, the setClientInfo connection method can be used to set the ApplicationName connection property.

Example

Select the departments that are allowed to use the application being used in this connection.

```
SELECT DEPT  
FROM DEPT_APPL_MAP  
WHERE APPL_NAME = CURRENT_CLIENT_APPLNAME
```

CURRENT CLIENT_PROGRAMID

The CURRENT CLIENT_PROGRAMID special register specifies a VARCHAR(255) value that contains the value of the client program ID from the client information specified for the current connection.

The default value of this register is the empty string. The value of the client program ID can be changed through these interfaces:

- The Set Client Information (SQLESETI) API can change the client special register.
- The SYSPROC.WLM_SET_CLIENT_INFO procedure can change the client special register.

- In CLI, `SQLSetConnectAttr()` can be used to set the `SQL_ATTR_INFO_PROGRAMID` connection attribute.
- In ODBC, `SQLSetConnectAttr()` can be used to set the `ODBC_ATTR_INFO_PROGRAMID` connection attribute.
- In JDBC, the `setClientInfo` connection method can be used to set the `ClientProgramID` connection property.

Example

Get the program ID being used for this connection.

```
VALUES CURRENT CLIENT_PROGRAMID
INTO :PGM_ID
```

CURRENT CLIENT_USERID

The `CURRENT CLIENT_USERID` special register specifies a `VARCHAR(255)` value that contains the value of the client user ID from the client information specified for the current connection.

The default value of this register is the empty string. The value of the client user ID can be changed through these interfaces:

- The Set Client Information (`SQLESETI`) API can change the client special register.
- The `SYSPROC.WLM_SET_CLIENT_INFO` procedure can change the client special register.
- In CLI, `SQLSetConnectAttr()` can be used to set the `SQL_ATTR_INFO_USERID` connection attribute.
- In ODBC, `SQLSetConnectAttr()` can be used to set the `ODBC_ATTR_INFO_USERID` connection attribute.
- In JDBC, the `setClientInfo` connection method can be used to set the `ClientUser` connection property.

Example

Find out in which department the current client user ID works.

```
SELECT DEPT
FROM DEPT_USERID_MAP
WHERE USER_ID = CURRENT CLIENT_USERID
```

CURRENT CLIENT_WRKSTNNAME

The `CURRENT CLIENT_WRKSTNNAME` special register specifies a `VARCHAR(255)` value that contains the value of the workstation name from the client information specified for the current connection.

The default value of this register is the empty string. The value of the workstation name can be changed through these interfaces:

- The Set Client Information (`SQLESETI`) API can change the client special register.
- The `SYSPROC.WLM_SET_CLIENT_INFO` procedure can change the client special register.
- In CLI, `SQLSetConnectAttr()` can be used to set the `SQL_ATTR_INFO_WRKSTNNAME` connection attribute.
- In ODBC, `SQLSetConnectAttr()` can be used to set the `ODBC_ATTR_INFO_WRKSTNNAME` connection attribute.
- In JDBC, the `setClientInfo` connection method can be used to set the `ClientHostName` connection property.

Example

Get the workstation name being used for this connection.

```
VALUES CURRENT CLIENT_WRKSTNNAME
INTO :WS_NAME
```

CURRENT DATE

The CURRENT DATE special register specifies a date that is based on a reading of the time-of-day clock when the SQL statement is executed at the current server.

If this special register is used more than once within a single SQL statement, or used with CURRENT TIME, CURRENT TIMESTAMP, or the CURDATE, CURTIME, or NOW scalar functions within a single statement; all values are based on a single clock reading.³²

Example

Using the PROJECT table, set the project end date (PRENDATE) of the MA2111 project (PROJNO) to the current date.

```
UPDATE PROJECT
SET PRENDATE = CURRENT DATE
WHERE PROJNO = 'MA2111'
```

CURRENT DEBUG MODE

The CURRENT DEBUG MODE special register specifies whether SQL or Java procedures should be created or altered so they can be debugged by the Unified Debugger.

Any explicit specification of the DEBUG MODE or the DBGVIEW option in the SET OPTION statement on the CREATE PROCEDURE or ALTER PROCEDURE statement overrides the value in the CURRENT DEBUG MODE special register. CURRENT DEBUG MODE affects static and dynamic SQL statements. The data type of the register is VARCHAR(8). The valid values include:

DISALLOW

Procedures will be created so they cannot be debugged by the Unified Debugger. When the DEBUG MODE attribute of a procedure is DISALLOW, the procedure can be subsequently altered to change the DEBUG MODE attribute.

ALLOW

Procedures will be created so they can be debugged by the Unified Debugger. When the DEBUG MODE attribute of a procedure is ALLOW, the procedure can be subsequently altered to change the DEBUG MODE attribute.

DISABLE

Procedures will be created so they cannot be debugged by the Unified Debugger. When the DEBUG MODE attribute of a procedure is DISABLE, the procedure cannot be subsequently altered to change the DEBUG MODE attribute.

The value can be changed by invoking the SET CURRENT DEBUG MODE statement. For details about this statement, see [“SET CURRENT DEBUG MODE”](#) on page 1488.

The initial value of CURRENT DEBUG MODE is DISALLOW.

Example

The following statement prevents subsequent creates or alters of SQL or Java procedures from being debuggable:

```
SET CURRENT DEBUG MODE = DISALLOW
```

³² LOCALDATE can be specified as a synonym for CURRENT_DATE.

CURRENT DECFLOAT ROUNDING MODE

The CURRENT DECFLOAT ROUNDING MODE special register specifies the rounding mode that is used when DECFLOAT values are manipulated in dynamically prepared SQL statements.

The data type of the register is VARCHAR(128). The rounding modes supported are:

ROUND_CEILING

Round toward +infinity. If all of the discarded digits are zero or if the sign is negative, the result is unchanged other than the removal of the discarded digits. Otherwise, the result coefficient is incremented by one (rounded up).

ROUND_DOWN

Round toward zero (truncation). The discarded digits are ignored.

ROUND_FLOOR

Round toward -infinity. If all of the discarded digits are zero or if the sign is positive, the result is unchanged other than the removal of the discarded digits. Otherwise, the sign is negative and the result coefficient is incremented by one.

ROUND_HALF_DOWN

Round to nearest; if equidistant, round down. If the discarded digits represent greater than half (0.5) of the value of a one in the next left position, then the result coefficient is incremented by one (rounded up). Otherwise, the discarded digits are ignored.

ROUND_HALF_EVEN

Round to nearest; if equidistant, round so that the final digit is even. If the discarded digits represent greater than half (0.5) of the value of a one in the next left position, then the result coefficient is incremented by one (rounded up). If they represent less than half, then the result coefficient is not adjusted (that is, the discarded digits are ignored). Otherwise (they represent exactly half), the result coefficient is unaltered if its rightmost digit is even, or incremented by one (rounded up) if its rightmost digit is odd (to make an even digit).

ROUND_HALF_UP

Round to nearest; if equidistant, round up. If the discarded digits represent greater than or equal to half (0.5) of the value of a one in the next left position, then the result coefficient is incremented by one (rounded up). Otherwise, the discarded digits are ignored.

ROUND_UP

Round away from zero. If all of the discarded digits are zero, the result is unchanged other than the removal of discarded digits. Otherwise, the result coefficient is incremented by one (rounded up).

The initial value of CURRENT DECFLOAT ROUNDING MODE in an activation group is established by the first SQL statement that is executed in the activation group.

- If the first SQL statement in an activation group is executed from an SQL program or SQL package, the CURRENT DECFLOAT ROUNDING MODE special register is set to the value of the DECFLTRND parameter.
- Otherwise, the initial value is ROUND_HALF_EVEN.

The DECFLTRND parameter on the CRTSQLxxx command or SET OPTION is used for static SQL statements.

Example

Set the host variable APPL_ROUND (VARCHAR(128)) to the current rounding mode.

```
SELECT CURRENT DECFLOAT ROUNDING MODE
INTO   :APPL_ROUND
FROM   SYSIBM.SYSDUMMY1
```

CURRENT DEGREE

The CURRENT DEGREE special register specifies the degree of I/O or Symmetric MultiProcessing (SMP) parallelism for the execution of queries, index creates, index rebuilds, index maintenance, and reorganizes.

CURRENT DEGREE affects static and dynamic SQL statements. The data type of the register is CHAR(5). The valid values include:

1

No parallel processing is allowed.

2 through 32767

Specifies the degree of parallelism that will be used.

ANY

Specifies that the database manager can choose to use any number of tasks for either I/O or SMP parallel processing.

Use of parallel processing and the number of tasks used is determined based on the number of processors available in the system, this job's share of the amount of active memory available in the pool in which the job is run, and whether the expected elapsed time for the operation is limited by CPU processing or I/O resources. The database manager chooses an implementation that minimizes elapsed time based on the job's share of the memory in the pool.

NONE

No parallel processing is allowed.

MAX

The database manager can choose to use any number of tasks for either I/O or SMP parallel processing. MAX is similar to ANY except the database manager assumes that all active memory in the pool can be used.

IO

Any number of tasks can be used when the database manager chooses to use I/O parallel processing for queries. SMP is not allowed.

The initial value of CURRENT DEGREE is determined by the current degree in effect from the CHGQRYA CL command, PARALLEL_DEGREE parameter in the current query options file (QAQQINI), or the QQRYDEGREE system value.

The value can be changed by invoking the SET CURRENT DEGREE statement. For details about this statement, see [“SET CURRENT DEGREE” on page 1492](#).

Example

The following statement inhibits parallelism:

```
SET CURRENT DEGREE = '1'
```

CURRENT IMPLICIT XMLPARSE OPTION

The CURRENT IMPLICIT XMLPARSE OPTION special register specifies whitespace handling options that are to be used when serialized XML data is implicitly parsed by the Db2 server without validation.

An implicit non-validating parse operation occurs when an SQL statement is processing an XML host variable or an implicitly or explicitly typed XML parameter marker that is not an argument of the XMLVALIDATE function.

The data type of the register is VARCHAR(128). The supported values are:

STRIP WHITESPACE

Whitespace that is in the document to improve readability is removed. The whitespace characters are: blank, carriage return, line feed, and tab. All boundary whitespace (whitespace between elements) is removed.

PRESERVE WHITESPACE

No whitespace is removed.

The initial value of CURRENT IMPLICIT XMLPARSE OPTION is 'STRIP WHITESPACE'.

Example

Set the CURRENT IMPLICIT XMLPARSE OPTION to PRESERVE WHITESPACE.

```
SET CURRENT IMPLICIT XMLPARSE OPTION = PRESERVE WHITESPACE
```

CURRENT PATH

The CURRENT PATH special register specifies the SQL path used to resolve unqualified type names, function names, and procedure names in dynamically prepared SQL statements.

It is also used to resolve unqualified procedure names that are specified as variables in SQL CALL statements (CALL *variable*). The data type is VARCHAR(8843).

The CURRENT PATH special register contains the value of the SQL path, which is a list of one or more schema names. Each schema name is enclosed in delimiters and separated from the following schema by a comma (any delimiters within the string are repeated as they are in any delimited identifier). The delimiters and commas are included in the length of the special register. The maximum number of schema names in the path is 268.

If a schema name has a different system name, the schema name is returned in the CURRENT PATH special register even if the system name was explicitly specified in the SET PATH statement.

For information about when the SQL path is used to resolve unqualified names in both dynamic and static SQL statements and the effect of its value, see [“Unqualified function, procedure, specific name, type, and variables”](#) on page 59.

The initial value of the CURRENT PATH special register in an activation group is established by the first SQL statement that is executed.

- If the first SQL statement in an activation group is executed from an SQL program or SQL package and the SQLPATH parameter was specified on the CRTSQLxxx command, the path is the value specified in the SQLPATH parameter. The SQLPATH value can also be specified using the SET OPTION statement.
- Otherwise,
 - For SQL naming, "QSYS", "QSYS2", "SYSPROC", "SYSIBMADM", "*the value of the run-time authorization ID of the statement*".
 - For system naming, "*LIBL".

The value of the special register can be changed by executing the SET PATH statement. For details about this statement, see [“SET PATH”](#) on page 1524. For portability across the platforms, it is recommended that a SET PATH statement be issued at the beginning of an application.

Example

Set the special register so that schema SMITH is searched before schemas QSYS and QSYS2 (SYSTEM PATH).

```
SET CURRENT PATH SMITH, SYSTEM PATH
```

CURRENT SCHEMA

The CURRENT SCHEMA special register specifies a VARCHAR(128) value that identifies the schema name used to qualify unqualified database object references where applicable in dynamically prepared SQL statements.

CURRENT SCHEMA is not used to qualify names in programs where the DYNDFTCOL has been specified. If DYNDFTCOL is specified in a program, its schema name is used instead of the CURRENT SCHEMA schema name.³³

The initial value of CURRENT SCHEMA is the authorization ID of the current session user.

The value of the special register can be changed by executing the SET SCHEMA statement. For more information, see [“SET SCHEMA” on page 1530](#).

The DFTRDBCOL keyword controls the schema name used to qualify unqualified database object references where applicable for static SQL statements.

Example

Set the schema for object qualification to 'D123'.

```
SET CURRENT SCHEMA = 'D123'
```

CURRENT SERVER

The CURRENT SERVER special register specifies a VARCHAR(18) value that identifies the current application server.

CURRENT SERVER can be changed by the CONNECT (Type 1), CONNECT (Type 2), or SET CONNECTION statements, but only under certain conditions. See the description in [“CONNECT \(type 1\)” on page 952](#), [“CONNECT \(type 2\)” on page 957](#), and [“SET CONNECTION” on page 1485](#).

CURRENT SERVER cannot be specified unless the local relational database is named by adding the entry to the relational database directory using the ADDRDBDIRE or WRKRDBDIRE command.

Example

Set the host variable APPL_SERVE (VARCHAR(18)) to the name of the current server.

```
SELECT CURRENT SERVER  
INTO :APPL_SERVE  
FROM SYSIBM.SYSDUMMY1
```

CURRENT TEMPORAL SYSTEM_TIME

The CURRENT TEMPORAL SYSTEM_TIME special register specifies a TIMESTAMP(12) value that is used in the default SYSTEM_TIME period specification for references to system-period temporal tables.

When a system-period temporal table is referenced and the value in effect for the CURRENT TEMPORAL SYSTEM_TIME special register is not the null value, the following period specification is implicit:

```
FOR SYSTEM_TIME AS OF CURRENT TEMPORAL SYSTEM_TIME
```

The initial value of the special register in a user-defined function, procedure, or trigger is inherited from the invoking application. In other contexts the initial value of the special register is the null value.

The value of this special register can be changed by executing the SET CURRENT TEMPORAL SYSTEM_TIME statement. If the value of the special register is changed within a routine, that new value is not passed back to the invoking application.

³³ For compatibility with Db2 for z/OS, the special register CURRENT SQLID is treated as a synonym for CURRENT SCHEMA.

The setting for the SYSTIME option determines whether references to system-period temporal tables in both static SQL statements and dynamic SQL statements are affected by the value of the CURRENT TEMPORAL SYSTEM_TIME special register. The option can be set to YES or NO.

When the value of the CURRENT TEMPORAL SYSTEM_TIME special register is not null and the SYSTIME option is set to YES, FOR SYSTEM_TIME cannot be explicitly specified in a select-statement.

Examples

For the following examples, assume the table IN_TRAY is a system-period temporal table.

Example 1: Based on the state of the messages in IN_TRAY as of the date specified by the CURRENT TEMPORAL SYSTEM_TIME special register, list the user IDs and subject lines.

```
SELECT SOURCE, SUBJECT
FROM IN_TRAY
```

If the special register is set to a non-null value, the previous statement is equivalent to the following statement:

```
SELECT SOURCE, SUBJECT
FROM IN_TRAY
FOR SYSTEM_TIME AS OF CURRENT TEMPORAL SYSTEM_TIME
```

Example 2: List the user ID and subject line for the messages in IN_TRAY sent before the value specified by the CURRENT TEMPORAL SYSTEM_TIME special register, which has been set to a value of '2011-01-01-00.00.00.000000'.

```
SELECT SOURCE, SUBJECT
FROM IN_TRAY
WHERE RECEIVED < CURRENT TEMPORAL SYSTEM_TIME
```

Assuming that the CURRENT TEMPORAL SYSTEM_TIME special register is set to the null value, the following statement returns the same result.

```
SELECT SOURCE, SUBJECT
FROM IN_TRAY
FOR SYSTEM_TIME AS OF '2011-01-01-00.00.00.000000'
WHERE DATE(RECEIVED) < DATE('2011-01-01-00.00.00.000000')
```

CURRENT TIME

The CURRENT TIME special register specifies a time that is based on a reading of the time-of-day clock when the SQL statement is executed at the current server.

If this special register is used more than once within a single SQL statement, or used with CURRENT DATE, CURRENT TIMESTAMP, or the CURDATE, CURTIME, or NOW scalar functions within a single statement; all values are based on a single clock reading.³⁴

Example

Using the CL_SCHED table, select all the classes (CLASS_CODE) that start (STARTING) later today. Today's classes have a value of 3 in the DAY column.

```
SELECT CLASS_CODE FROM CL_SCHED
WHERE STARTING > CURRENT TIME AND DAY = 3
```

³⁴ LOCALTIME and LOCALTIME(0) can be specified as a synonyms for CURRENT_TIME.

CURRENT TIMESTAMP

The CURRENT TIMESTAMP special register specifies a timestamp that is based on a reading of the time-of-day clock when the SQL statement is executed at the current server.

If this special register is used more than once within a single SQL statement, or used with CURRENT DATE, CURRENT TIME, or the CURDATE, CURTIME, or NOW scalar functions within a single statement; all values are based on a single clock reading.³⁵

If a timestamp with a specific precision is desired, the special register can be referenced as CURRENT TIMESTAMP(*integer*), where *integer* can range from 0 to 12. The default precision is 6.

Example

Insert a row into the IN_TRAY sample table. The value of the RECEIVED column should be a timestamp that indicates when the row was inserted. The values for the other three columns come from the host variables SRC (CHAR(8)), SUB (CHAR(64)), and TXT (VARCHAR(200)).

```
INSERT INTO IN_TRAY
VALUES (CURRENT_TIMESTAMP, :SRC, :SUB, :TXT)
```

CURRENT USER

The CURRENT USER special register specifies the primary authorization ID that is to be used for statement authorization. The data type of the special register is VARCHAR(128).

When multiple authorization IDs have been adopted within a thread, the value of the most recently adopted authorization ID within the thread will be returned.

Example

Find the tables owned by the current statement authorization ID.

```
SELECT TABLE_SCHEMA, TABLE_NAME FROM QSYS2.SYSTABLES
WHERE TABLE_OWNER = CURRENT_USER AND TABLE_TYPE = 'T'
```

CURRENT TIMEZONE

The CURRENT TIMEZONE special register specifies the difference between UTC and local time at the current server.

The difference is represented by a time duration (a decimal number in which the first two digits are the number of hours, the next two digits are the number of minutes, and the last two digits are the number of seconds).³⁶ The number of hours is between -24 and 24 exclusive. Subtracting CURRENT TIMEZONE from a local time converts that local time to UTC.

Example

Using the IN_TRAY table, select all the rows from the table and adjust the value to UTC.

```
SELECT RECEIVED - CURRENT_TIMEZONE, SOURCE,
SUBJECT, NOTE_TEXT FROM IN_TRAY
```

³⁵ LOCALTIMESTAMP and LOCALTIMESTAMP(6) can be specified as a synonym for CURRENT_TIMESTAMP. LOCALTIMESTAMP(*n*) can be specified as a synonym for CURRENT_TIMESTAMP(*n*).

³⁶ Coordinated Universal Time, formerly known as GMT.

SESSION_USER

The SESSION_USER special register specifies the run-time authorization ID at the current server. The data type of the special register is VARCHAR(128).

The initial value of SESSION_USER for a new connection is the same as the value of the SYSTEM_USER special register.

The value can be changed by executing the SET SESSION AUTHORIZATION statement. For more information, see [“SET SESSION AUTHORIZATION” on page 1533](#).

Example

Select all notes from the IN_TRAY table that the user placed there himself.

```
SELECT * FROM IN_TRAY
WHERE SOURCE = SESSION_USER
```

SYSTEM_USER

The SYSTEM_USER special register specifies the authorization ID that connected to the current server. The data type of the special register is VARCHAR(128).

Example

Select all notes from the IN_TRAY table that the user placed there himself.

```
SELECT * FROM IN_TRAY
WHERE SOURCE = SYSTEM_USER
```

USER

The USER special register specifies the run-time authorization ID at the current server. The data type of the special register is VARCHAR(18).

The initial value of USER for a new connection is the same as the value of the SYSTEM_USER special register.

The value can be changed by executing the SET SESSION AUTHORIZATION statement. For more information, see [“SET SESSION AUTHORIZATION” on page 1533](#).

Example

Select all notes from the IN_TRAY table that the user placed there himself.

```
SELECT * FROM IN_TRAY
WHERE SOURCE = USER
```

Column names

The meaning of a column name depends on its context.

A column name can be used to:

- Declare the name of a column, as in a CREATE TABLE statement.
- Identify a column, as in a CREATE INDEX statement.
- Specify values of the column, as in the following contexts:
 - In an *aggregate function*, a column name specifies all values of the column in the group or intermediate result table to which the function is applied. Groups and intermediate result tables are explained under [Chapter 6, “Queries,” on page 723](#). For example, MAX(SALARY) applies the function MAX to all values of the column SALARY in a group.
 - In a *GROUP BY* or *ORDER BY* clause, a column name specifies all values in the intermediate result table to which the clause is applied. For example, ORDER BY DEPT orders an intermediate result table by the values of the column DEPT.
 - In an *expression*, a *search condition*, or a *scalar function*, a column name specifies a value for each row or group to which the construct is applied. For example, when the search condition CODE = 20 is applied to some row, the value specified by the column name CODE is the value of the column CODE in that row.
- Provide a column name for an expression to temporarily rename a column, as in the *correlation-clause* of a *table-reference* in a FROM clause, or in the AS clause in the *select-clause*.

Qualified column names

A qualifier for a column name can be a table name, a view name, an alias name, or a correlation name.

Whether a column name can be qualified depends on its context:

- In the COMMENT and LABEL statements, the column name must be qualified.
- Where the column name specifies values of the column, a column name can be qualified.
- In the *assignment-clause* of an UPDATE statement, it may be qualified.
- In the *column-name-list* of an INSERT statement, it may be qualified.
- In all other contexts, a column name must not be qualified.

Where a qualifier is optional it can serve two purposes. See [“Column name qualifiers to avoid ambiguity” on page 135](#) and [“Column name qualifiers in correlated references” on page 137](#) for details.

Correlation names

A *correlation name* can be defined in the FROM clause of a query and after the target *table-name* or *view-name* in an UPDATE or DELETE statement.

For example, the clause shown below establishes Z as a correlation name for X.MYTABLE:

```
FROM X.MYTABLE Z
```

A correlation name is associated with a table or view only within the context in which it is defined. Hence, the same correlation name can be defined for different purposes in different statements, or in different clauses of the same statement.

As a qualifier, a correlation name can be used to avoid ambiguity or to establish a correlated reference. A correlation name can also be used as a shorter name for a table or view. In the example that is shown above, Z might have been used merely to avoid having to enter X.MYTABLE more than once.

If a correlation name is specified for a table or view, any qualified reference to a column of that instance of the table or view must use the correlation name, rather than the table name or view name. For example,

the reference to EMPLOYEE.PROJECT in the following example is incorrect, because a correlation name has been specified for EMPLOYEE:

```
FROM EMPLOYEE E
WHERE EMPLOYEE . PROJECT= ' ABC '          ***INCORRECT***
```

The qualified reference to PROJECT should instead use the correlation name, “E”, as shown below:

```
FROM EMPLOYEE E
WHERE E . PROJECT= ' ABC '
```

Names specified in a FROM clause are either *exposed* or *non-exposed*. A correlation name is always an exposed name. A table name or view name is said to be *exposed* in that FROM clause if a correlation name is not specified. For example, in the following FROM clause, a correlation name is specified for EMPLOYEE but not for DEPARTMENT, so DEPARTMENT is an exposed name, and EMPLOYEE is not:

```
FROM EMPLOYEE E, DEPARTMENT
```

A table name or view name that is exposed in a FROM clause must not be the same as any other table name or view name exposed in that FROM clause or any correlation name in the FROM clause. The names are compared after qualifying any unqualified table or view names.

The first two FROM clauses shown below are correct, because each one contains no more than one reference to EMPLOYEE that is exposed:

1. Given the FROM clause:

```
FROM EMPLOYEE E1, EMPLOYEE
```

a qualified reference such as EMPLOYEE.PROJECT denotes a column of the second instance of EMPLOYEE in the FROM clause. A qualified reference to the first instance of EMPLOYEE must use the correlation name “E1” (E1.PROJECT).

2. Given the FROM clause:

```
FROM EMPLOYEE, EMPLOYEE E2
```

a qualified reference such as EMPLOYEE.PROJECT denotes a column of the first instance of EMPLOYEE in the FROM clause. A qualified reference to the second instance of EMPLOYEE must use the correlation name “E2” (E2.PROJECT).

3. Given the FROM clause:

```
FROM EMPLOYEE, EMPLOYEE          ***INCORRECT***
```

the two exposed table names included in this clause (EMPLOYEE and EMPLOYEE) are the same, and this is not allowed.

4. Given the following statement:

```
SELECT *
FROM EMPLOYEE E1, EMPLOYEE E2
WHERE EMPLOYEE . PROJECT= ' ABC '          ***INCORRECT***
```

the qualified reference EMPLOYEE.PROJECT is incorrect, because both instances of EMPLOYEE in the FROM clause have correlation names. Instead, references to PROJECT must be qualified with either correlation name (E1.PROJECT or E2.PROJECT).

5. Given the FROM clause:

```
FROM EMPLOYEE, X . EMPLOYEE
```

a reference to a column in the second instance of EMPLOYEE must use X.EMPLOYEE (X.EMPLOYEE.PROJECT). This FROM clause is only valid if the authorization ID of the statement is not X.

A correlation name specified in a FROM clause must not be the same as:

- Any other correlation name in that FROM clause
- Any unqualified table name or view name exposed in the FROM clause
- The second SQL identifier of any qualified table name or view name that is exposed in the FROM clause.

For example, the following FROM clauses are incorrect:

```
FROM EMPLOYEE E, EMPLOYEE E
FROM EMPLOYEE DEPARTMENT, DEPARTMENT      ***INCORRECT***
FROM X.T1, EMPLOYEE T1
```

The following FROM clause is technically correct, though potentially confusing:

```
FROM EMPLOYEE DEPARTMENT, DEPARTMENT EMPLOYEE
```

The use of a correlation name in the FROM clause also allows the option of specifying a list of column names to be associated with the columns of the result table. As with a correlation name, these listed column names become the exposed names of the columns that must be used for references to the columns throughout the query. If a column name list is specified, then the column names of the underlying table become non-exposed.

Given the FROM clause:

```
FROM DEPARTMENT D (NUM, NAME, MGR, ANUM, LOC)
```

a qualified reference such as D.NUM denotes the first column of the DEPARTMENT table that is defined in the table as DEPTNO. A reference to D.DEPTNO using this FROM clause is incorrect since the column name DEPTNO is a non-exposed column name.

If a list of columns is specified, it must consist of as many names as there are columns in the *table-reference*. Each column name must be unique and unqualified.

Column name qualifiers to avoid ambiguity

In the context of a function, a GROUP BY clause, an ORDER BY clause, an expression, or a search condition, a column name refers to values of a column in some target table or view in a DELETE or UPDATE statement or *table-reference* in a FROM clause.

The tables, views, and *table-references*³⁷ that might contain the column are called the *object tables* of the context. Two or more object tables might contain columns with the same name. One reason for qualifying a column name is to designate the object from which the column comes. For information about avoiding ambiguity between SQL parameters and variables and column names, see [“References to SQL parameters and SQL variables” on page 1571](#).

A nested table expression which is preceded by a LATERAL or TABLE keyword will consider *table-references* that precede it in the FROM clause as object tables. The *table-references* that follow the nested table expression are not considered as object tables.

Table designators

A qualifier that designates a specific object table is called a *table designator*. The clause that identifies the object tables also establishes the table designators for them.

For example, the object tables of an expression in a SELECT clause are named in the FROM clause that follows it:

```
SELECT CORZ.COLA, OWNY.MYTABLE.COLA
FROM OWNX.MYTABLE CORZ, OWNY.MYTABLE
```

Table designators in the FROM clause are established as follows:

³⁷ In the case of a *joined-table*, each *table-reference* within the *joined-table* is an object table.

- A name that follows a table or view name is both a correlation name and a table designator. Thus, CORZ is a table designator. CORZ is used to qualify the first column name in the select list.
- In SQL naming, an exposed table or view name is a table designator. Thus, OWNY.MYTABLE is a table designator. OWNY.MYTABLE is used to qualify the second column name in the select list.
- In system naming, the table designator for an exposed table or view name is the unqualified table or view name. In the following example MYTABLE is the table designator for OWNY/MYTABLE.

```
SELECT CORZ.COLA, MYTABLE.COLA
FROM OWNX/MYTABLE CORZ, OWNY/MYTABLE
```

Two or more object tables can be instances of the same table. In this case, distinct correlation names must be used to unambiguously designate the particular instances of the table. In the following FROM clause, X and Y are defined to refer, respectively, to the first and second instances of the table EMPLOYEE:

```
SELECT * FROM EMPLOYEE X,EMPLOYEE Y
```

Avoiding undefined or ambiguous references

When a column name refers to values of a column, it must be possible to resolve that column name to exactly one object table.

The following situations are considered errors:

- No object table contains a column with the specified name. The reference is undefined.
- The column name is qualified by a table designator, but the table designated does not include a column with the specified name. Again the reference is undefined.
- The name is unqualified and more than one object table includes a column with that name. The reference is ambiguous.
- The column name is qualified by a table designator, but the table designated is not unique in the FROM clause and both occurrences of the designated table include the column. The reference is ambiguous.
- The column name is in a nested table expression which is not preceded by the LATERAL or TABLE keyword or a table function or nested table expression that is the right operand of a right outer join, full outer join, or a right exception join and the column name does not refer to a column of a *table-reference* within the nested table expression's fullselect. The reference is undefined.

Avoid ambiguous references by qualifying a column name with a uniquely defined table designator. If the column is contained in several object tables with different names, the object table names can be used as designators. Ambiguous references can also be avoided without the use of the table designator by giving unique names to the columns of one of the object tables using the column name list following the correlation name.

When qualifying a column with the exposed table name form of a table designator, either the qualified or unqualified form of the exposed table name may be used. However, the qualifier used and the table used must be the same after fully qualifying the table name or view name and the table designator.

1. If the default schema is CORPDATA, then:

```
SELECT CORPDATA.EMPLOYEE.WORKDEPT
FROM EMPLOYEE
```

is a valid statement.

2. If the default schema is REGION, then:

```
SELECT CORPDATA.EMPLOYEE.WORKDEPT
FROM EMPLOYEE ***INCORRECT***
```

is invalid, because EMPLOYEE represents the table REGION.EMPLOYEE, but the qualifier for WORKDEPT represents a different table, CORPDATA.EMPLOYEE.

3. If the default schema is REGION, then:

```
SELECT EMPLOYEE.WORKDEPT
FROM CORPDATA.EMPLOYEE          ***INCORRECT***
```

is invalid, because EMPLOYEE in the select list represents the table REGION.EMPLOYEE, but the explicitly qualified table name in the FROM clause represents a different table, CORPDATA.EMPLOYEE. In this case, either omit the table qualifier in the select list, or define a correlation name for the table designator in the FROM clause and use that correlation name as the qualifier for column names in the statement.

Column name qualifiers in correlated references

A *subselect* is a form of a query that can be used as a component of various SQL statements.

Refer to Chapter 6, “Queries,” on page 723 for more information about subselects. A *subquery* is a form of a fullselect that is enclosed within parentheses. For example, a *subquery* can be used in a search condition. A fullselect used in the FROM clause of a query is called a *nested table expression*.

A subquery can include search conditions of its own, and these search conditions can, in turn, include subqueries. Therefore, an SQL statement can contain a hierarchy of subqueries. Those elements of the hierarchy that contain subqueries are said to be at a higher level than the subqueries they contain.

Every element of the hierarchy has a clause that establishes one or more table designators. This is the FROM clause, except in the highest level of an UPDATE or DELETE statement. A search condition, the select list, the join clause, an argument of a table function in a subquery, or a *nested table expression* that is preceded by the LATERAL keyword can reference not only columns of the tables identified by the FROM clause of its own element of the hierarchy, but also columns of tables identified at any level along the path from its own element to the highest level of the hierarchy. A reference to a column of a table identified at a higher level is called a *correlated reference*. A reference to a column of a table identified at the same level from a *nested table expression* through the use of the LATERAL keyword is called *lateral correlation*.

A correlated reference to column C of table T can be of the form C, T.C, or Q.C, if Q is a correlation name defined for T. However, a correlated reference in the form of an unqualified column name is not good practice. The following explanation is based on the assumption that a correlated reference is always in the form of a qualified column name and that the qualifier is a correlation name.

Q.C is a correlated reference only if these three conditions are met:

- Q.C is used in a search condition, select list, join clause, or an argument of a table function in a subquery.
- Q does not designate a table used in the FROM clause of that subquery, select list, join clause, or an argument of a table function in a subquery.
- Q does designate a table used at some higher level.

Q.C refers to column C of the table or view at the level where Q is used as the table designator of that table or view. Because the same table or view can be identified at many levels, unique correlation names are recommended as table designators. If Q is used to designate a table at more than one level, Q.C refers to the lowest level that contains the subquery that includes Q.C.

In the following statement, Q is used as a correlation name for T1 and T2, but Q.C refers to the correlation name associated with T2, because it is the lowest level that contains the subquery that includes Q.C.

```
SELECT *
FROM T1 Q
WHERE A < ALL (SELECT B
               FROM T2 Q
               WHERE B < ANY (SELECT D
                             FROM T3
                             WHERE D = Q.C))
```

Unqualified column names in correlated references

An unqualified column name can also be a correlated reference.

If the column:

- Is used in a search condition of a subquery
- Is not contained in a table used in the FROM clause of that subquery
- Is contained in a table used at some higher level

Unqualified correlated references are not recommended because it makes the SQL statement difficult to understand. The column will be implicitly qualified when the statement is prepared depending on which table the column was found in. Once this implicit qualification is determined it will not change until the statement is re-prepared. When an SQL statement that has an unqualified correlated reference is prepared or executed, a warning is returned (SQLSTATE 01545).

Variables

A *variable* in an SQL statement specifies a value that can be changed when the SQL statement is executed.

There are several types of *variables* used in SQL statements:

global variable

Global variables are either built-in global variables or user-defined global variables. For more information about how to refer to global variables see [“Global variables” on page 139](#).

host variable

Host variables are defined by statements of a host language. For more information about how to refer to host variables see [“References to host variables” on page 140](#).

transition variable

Transition variables are defined in a trigger and refer to either the old or new values of columns. For more information about how to refer to transition variables see [“CREATE TRIGGER” on page 1160](#).

SQL variable

SQL variables are defined by an SQL compound statement in an SQL function, SQL procedure, or trigger. For more information about SQL variables, see [“References to SQL parameters and SQL variables” on page 1571](#).

SQL parameter

SQL parameters are defined in an CREATE FUNCTION (SQL scalar), CREATE FUNCTION (SQL table), or CREATE PROCEDURE (SQL) statement. For more information about SQL parameters, see [“References to SQL parameters and SQL variables” on page 1571](#).

parameter marker

Variables cannot be referenced in dynamic SQL statements. Parameter markers are defined in an SQL descriptor and used instead. For more information about parameter markers, see [Parameter Markers in “PREPARE” on page 1427](#).

Global variables

Global variables are named memory variables that you can access and modify through SQL statements.

The Db2 database management system supports the following types of global variables:

Built-in global variable

A built-in global variable is part of the database management system, and is available to any SQL statement that runs on the database manager. For a list of the built-in global variables and information on these variables, see [Chapter 3, “Built-in global variables,” on page 231](#).

User-defined global variable

A user-defined global variable enables you to share relational data between SQL statements without the need for application logic to support this data transfer.

A user-defined global variable is associated with a specific session and contains a value that is specific to that session. A user-defined session global variable is available to any active SQL statement running against the database on which the variable was defined. A user-defined global variable can be associated with more than one session, but its value will be specific to each session. User-defined global variables are defined in the system catalog.

You can control access to global variables through the GRANT (Global Variable Privileges) and REVOKE (Global Variable Privileges) statements.

Global variable names are qualified names. If an unqualified global variable name is the main object of an ALTER, CREATE, COMMENT, DROP, GRANT, or REVOKE statement, the name is implicitly qualified using the same rules as for qualifying unqualified table names. Otherwise, the SQL path is used for name resolution.

For static SQL statements and SQL routines, global variables are resolved for a statement the first time all table references are resolved. In views, triggers, and other global variables, they are resolved when the

object is created. If resolution were to be performed again on any global variable, it could change the behavior if, for example, a new global variable had been added with the same name in a different schema that is also in the SQL path.

Global variables that are referenced in dynamic statements will be resolved when the statement is initially prepared. They will not be resolved again unless the statement needs to be refreshed because a table has changed.

The name of a global variable can be the same as the name of a column in a table or view that is referenced in an SQL statement, as well as the name of an SQL variable or an SQL parameter in an SQL routine. Names that are the same should be explicitly qualified. If the name is not qualified, or it is qualified but is still ambiguous, the following rules describe the precedence of resolution:

- The name is checked to see if it is the name of a column of any existing table or view referenced in the statement at the current server.
- If used in an SQL routine, the name is checked to see if it is the name of an SQL variable, SQL parameter, or transition variable.
- If not found by either of these rules, it is assumed to be a global variable.
- If the SQL_GVAR_BUILD_RULE QAQQINI option is *EXIST and the global variable does not exist at precompile time or when an SQL routine is being created, an error will be issued.

When a global variable is referenced in a trigger, view, routine, or global variable, a dependency on the fully qualified global variable name is recorded for the statement or object. Also, if applicable, the authorization ID being used for the statement is checked for the appropriate privilege on the global variable.

Global variables can be used in any SQL statement that allows a variable. Global variables can be referenced within any expression except in the following situations:

- Check constraints
- Materialized query tables (MQTs)
- Indexes
- A global variable is not allowed if the query specifies:
 - a distributed table,
 - a table with a read trigger, or
 - a logical file built over multiple physical file members.

Authorization: If a global variable is referenced in a statement, the privileges held by the authorization ID of the statement must include at least one of the following:

- For the global variable identified in the statement,
 - The READ privilege on the global variable if the global variable is referenced, and
 - The WRITE privilege on the global variable if the global variable is assigned a value, and
 - The USAGE privilege on the schema containing the global variable
- Database administrator authority

The value of a global variable can be changed using the FETCH, SET, SELECT INTO, or VALUES INTO statement. It can also be changed if it is an argument of an OUT or INOUT parameter in a CALL statement.

References to host variables

A *host variable* is a COBOL data item, an RPG field, or a PLI, REXX, C++, C, or Java variable that is referenced in an SQL statement. Host variables are defined by statements of the host language.

Host variables cannot be referenced in dynamic SQL statements; instead, parameter markers must be used. For more information on parameter markers, see [“Variables in dynamic SQL” on page 143](#).

A *host variable* in an SQL statement must identify a host variable described in the program according to the rules for declaring host variables.

All host variables used in an SQL statement should be declared in an SQL declare section in all host languages other than Java, REXX, and RPG. Variables do not have to be declared in REXX. In Java and RPG, there is no declare section, and host variables may be declared throughout the program. No variables may be declared outside an SQL declare section with names identical to variables declared inside an SQL declare section. An SQL declare section begins with BEGIN DECLARE SECTION and ends with END DECLARE SECTION.

For further information about using host variables, see the [Embedded SQL programming](#) topic.

A variable in the INTO clause of a FETCH, a SELECT INTO, a SET variable, a GET DESCRIPTOR, or a VALUES INTO statement identifies a host variable to which a value from a result column is assigned. A variable in the GET DIAGNOSTICS statement identifies a host variable to which a diagnostic value is assigned. A host variable in a CALL or in an EXECUTE statement can be an output argument that is assigned a value after execution of the procedure, an input argument that provides an input value for the procedure, or both an input and output argument. In all other contexts a variable specifies a value to be passed to the database manager from the application program.

Non-Java variable references:

The general form of a *variable* reference in all languages other than Java is:

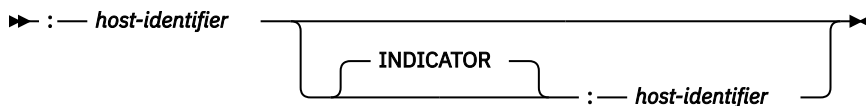

Each *host-identifier* must be declared in the source program. The first *host-identifier* designates the main variable, and the second *host-identifier* designates the associated indicator variable. An indicator variable must be a small integer. Depending on the operation, the main variable either provides a value to the database manager or is provided a value from the database manager. A given host variable can serve as both an input and an output variable in the same program.

The purposes of an indicator variable are to:

- Specify a non-null value. A 0 (zero), or positive value of the indicator variable specifies that the associated, first, *host-identifier* provides the value of this host variable reference.
- Specify the null value. A negative value of the indicator variable specifies the null value.
- On output, indicate that one of the following numeric conversion errors:

- Numeric conversion error (underflow or overflow)
- Arithmetic expression error (division by 0)
- A numeric value that is not valid

A -2 value of the indicator variable indicates a null result because of one of these warnings.

- On output, indicate one of the following string errors:

- Characters could not be converted
- Mixed data not properly formed

A -2 value of the indicator variable indicates a null result because of one of these warnings.

- On output, indicate one of the following datetime errors:

- Date or timestamp conversion error (a date or timestamp that is not within the valid range of the dates for the specified format)
- String representation of the datetime value is not valid

A -2 value of the indicator variable indicates a null result because of one of these warnings.

- On output, indicate one of the following miscellaneous errors:

- Argument of SUBSTR scalar function is out of range

– Argument of a decryption function contains a data type that is not valid.

A -2 value of the indicator variable indicates a null result because of one of these warnings.

- On output, record the original length of a string if the string is truncated on assignment to a host variable. If the string is truncated and there is no indicator variable, no error condition results.
- On output, record the seconds portion of a time if the time is truncated on assignment to a host variable. If the time is truncated and there is no indicator variable, no error condition results.

For example, if :V1:V2 is used to specify an insert or update value, and if V2 is negative, the value specified is the null value. If V2 is not negative the value specified is the value of V1.

Similarly, if :V1:V2 is specified in a CALL, FETCH, SELECT INTO, or VALUES INTO statement and the value returned is null, V1 is undefined, and V2 is set to a negative value. The negative value is:

- -1 if the value selected was the null value, or
- -2 if the null value was returned due to data mapping errors in the select list of an outer subselect.³⁸

If the value returned is not null, that value is assigned to V1 and V2 is set to zero (unless the assignment to V1 requires string truncation, in which case, V2 is set to the original length of the string). If an assignment requires truncation of the seconds part of time, V2 is set to the number of seconds.

If the second *host-identifier* is omitted, the *host variable* does not have an indicator variable. The value specified by the *host variable* :V1 is always the value of V1, and null values cannot be assigned to the variable. Thus, this form should not be used on output unless the corresponding result column cannot contain null values. If this form is used for an output host variable and the returned value is null, the database manager returns an error at run-time (SQLSTATE 23502).

An indicator variable for an input host variable in an INSERT, MERGE, or UPDATE statement can also be set to some special values to indicate that a target column is to be set to the default value, or to indicate that a value should not be assigned to a target column. These special values are only allowed when extended indicators are enabled. Extended indicators are enabled when the SET OPTION statement specified EXTIND = *YES, the precompile specified OPTION(*EXTIND), or when the WITH EXTENDED INDICATORS prepare attribute or cursor attribute has been specified for the statement.

When extended indicators are enabled, an input indicator variable in an INSERT, MERGE, or UPDATE statement specifies that the target column for the associated host variable is assigned one of the following types of values:

- A non-null value. A 0 (zero) or positive value specifies that the associated *host-identifier* provides the value of this host variable reference.
- NULL. A -1, -2, -3, -4, or -6 value specifies the null value.
- DEFAULT. A -5 value specifies the default value of the target column.
- UNASSIGNED. A -7 value specifies that this host variable is treated as if a value was not specified for assignment to the target column in the statement.

These indicator values can also be used in indicator structures with host structures. When extended indicators are enabled, indicator values other than positive values, zero, and the negative values listed previously must not be used. DEFAULT and UNASSIGNED extended indicator values must only be used in contexts where they are supported (INSERT, MERGE, and UPDATE statements). The DEFAULT and UNASSIGNED extended indicator values can only be used for an expression containing a single host parameter or a CAST of a single host parameter that is being assigned to a column. Output indicators are never set to extended indicator values.

When extended indicator variables are enabled, rules for data type validation in assignment and comparison are loosened for host variables where the associated indicator value is negative. Data type assignment and comparison validation rules are not enforced for host variables where the associated indicator value is NULL, DEFAULT, or ASSIGNED.

³⁸ It should be noted that although the null value returned for data mapping errors can be returned on certain scalar functions and for arithmetic expressions, the result column is not considered null capable unless an argument of the arithmetic expression or scalar function is null capable.

The unassigned extended indicator value can also be specified in the USING SUBSET clause for OPEN or EXECUTE to remove a host variable from the replacement variable list. Extended indicators do not need to be enabled for these statements to accept the extended indicator value.

An SQL statement that references host variables in C, C++, ILE RPG, and PL/I, must be within the scope of the declaration of those host variables. For host variables referenced in the SELECT statement of a cursor, that rule applies to the OPEN statement rather than to the DECLARE CURSOR statement.

The CCSID of a string host variable is either:

- The CCSID specified in the DECLARE VARIABLE statement, or
- If a DECLARE VARIABLE with a CCSID clause is not specified for the host variable, the default CCSID of the application requester at the time the SQL statement that contains the host variable is executed unless the CCSID is for a foreign encoding scheme other than Unicode (such as ASCII). In this case, the host variable is converted to the default CCSID of the current server.

Java variable references:

The general form of a host variable reference in Java is:

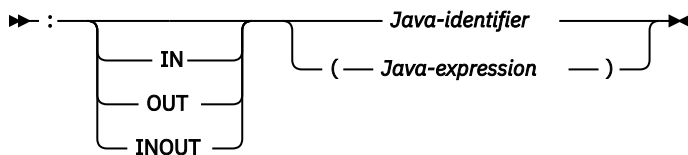

In Java, indicator variables are not used. Instead, instances of a Java class can be set to a null value. Variables defined as Java primitive types cannot be set to a null value.

If IN, OUT, or INOUT is not specified, the default depends on the context in which the variable is used. If the Java variable is used in an INTO clause, OUT is the default. Otherwise, IN is the default. For more information about Java variables, see [IBM Developer Kit for Java](#).

Example

Using the PROJECT table, set the host variable PNAME (VARCHAR(26)) to the project name (PROJNAME), the host variable STAFF (DECIMAL(5,2)) to the mean staffing level (PRSTAFF), and the host variable MAJPROJ (CHAR(6)) to the major project (MAJPROJ) for project (PROJNO) 'IF1000'. Columns PRSTAFF and MAJPROJ may contain null values, so provide indicator variables STAFF_IND (SMALLINT) and MAJPROJ_IND (SMALLINT).

```
SELECT PROJNAME, PRSTAFF, MAJPROJ
INTO :PNAME, :STAFF :STAFF_IND, :MAJPROJ :MAJPROJ_IND
FROM PROJECT
WHERE PROJNO = 'IF1000'
```

Variables in dynamic SQL

In dynamic SQL statements, parameter markers are used instead of variables. A parameter marker is a question mark (?) that represents a position in a dynamic SQL statement where the application will provide a value; that is, where a variable would be found if the statement string were a static SQL statement.

The following examples shows a static SQL that uses host variables and a dynamic statement that uses parameter markers:

```
INSERT INTO DEPT
VALUES( :HV_DEPTNO, :HV_DEPTNAME, :HV_MGRNO:IND_MGRNO, :HV_ADMRDEPT)

INSERT INTO DEPT
VALUES( ?, ?, ?, ? )
```

For more information about parameter markers, see [Parameter Markers](#), in “PREPARE” on page 1427.

References to LOB or XML variables

You can define regular LOB or XML variables, LOB or XML locator variables, and LOB or XML file reference variables.

Regular LOB or XML variables, LOB or XML locator variables, and LOB or XML file reference variables can be defined in the following host languages:

- C
- C++
- ILE RPG
- ILE COBOL
- PL/I (LOB only)

Where LOBs or XML are allowed, the term *variable* in a syntax diagram can refer to a regular variable, a locator variable, or a file reference variable. Since these variables are not native data types in host programming languages, SQL extensions are used and the precompilers generate the host language constructs necessary to represent each variable.

When it is possible to define a variable that is large enough to hold an entire LOB or XML value and the performance benefit of delaying the transfer of data from the server is not required, a LOB or XML locator is not needed. However, it is often not acceptable to store an entire LOB or XML value in temporary storage due to host language restrictions, storage restrictions, or performance requirements. When storing an entire LOB or XML value at one time is not acceptable, a LOB or XML value can be referred to by a LOB or XML locator and portions of the LOB or XML value can be accessed.

References to LOB or XML locator variables

A LOB or XML *locator variable* is a variable that contains the locator representing a LOB or XML value on the application server.

LOB or XML locator variables can be defined in the following host languages:

- C
- C++
- ILE RPG
- ILE COBOL
- PL/I (LOB only)

See [“Manipulating large objects with locators”](#) on page 73 for information about how locators can be used to manipulate LOB and XML values.

A locator variable in an SQL statement must identify a LOB or XML locator variable described in the program according to the rules for declaring locator variables. This is always indirectly through an SQL statement. For example, in C:

```
static volatile SQL TYPE IS CLOB_LOCATOR *loc1;
```

Like all other variables, a LOB or XML locator variable can have an associated indicator variable. Indicator variables for LOB or XML locator variables behave in the same way as indicator variables for other data types. When a null value is returned from the database, the indicator variable is set and the variable is unchanged. When the indicator variable associated with a LOB or XML locator is null, the value of the referenced LOB or XML is null. This means that a locator can never point to a null value.

If a locator variable does not currently represent any value, an error occurs when the locator variable is referenced.

At transaction commit or any transaction termination, all LOB or XML locators that were acquired by the transaction are released.

It is the application programmer's responsibility to guarantee that any LOB or XML locator is only used in SQL statements that are executed at the same application server that originally generated the LOB or XML locator. For example, assume that a LOB locator is returned from one application server and assigned to a LOB locator variable. If that LOB locator variable is subsequently used in an SQL statement that is executed at a different application server, unpredictable results will occur.

References to LOB or XML file reference variables

A LOB or XML *file reference variable* is used for direct file input and output for a LOB or XML.

A LOB or XML *file reference variable* can be defined in the following host languages:

- C
- C++
- ILE RPG
- ILE COBOL
- PL/I (LOB only)

Since these are not native data types, SQL extensions are used and the precompilers generate the host language constructs necessary to represent each variable.

A file reference variable represents (rather than contains) the file, just as a LOB or XML locator represents, rather than contains, the LOB or XML data. Database queries, updates, and inserts may use file reference variables to store or to retrieve single column values. The file referenced must exist at the application requester.

Like all other variables, a file reference variable can have an associated indicator variable. Indicator variables for file reference variables behave in the same way as indicator variables for other data types. When a null value is returned from the database, the indicator variable is set and the variable is unchanged. When the indicator variable associated with a file reference variable is null, the value of the referenced LOB or XML is null. This means that a file reference variable can never point to a null value.

The length attribute of a file reference variable is assumed to be the maximum length of a LOB or XML.

File reference variables are currently supported in the root (/), QOpenSys, and UDFS file systems. When a file is created, it is given the CCSID of the data that is being written to the file. Currently, mixed CCSIDs are not supported. To use a file created with a file reference variable, the file should be opened in binary mode.

For more information about file reference variables, see the [SQL programming](#) topic collection.

References to XML variables

XML variables are defined in host languages as a type of LOB variable.

Like LOBs, an XML variable can be defined as a string, locator, or file reference variable. It can be treated as CLOB, DBCLOB, or BLOB data. XML-supported CCSIDs can be assigned for CLOB and DBCLOB variables. This value is used to define the encoding of the XML data stored within the LOB variable. An XML variable defined as a BLOB will contain data that is encoded as specified within the data according to the XML 1.0 specification for determining encoding. For example, an XML variable that uses a CLOB storage structure can be defined in C as follows:

```
SQL TYPE IS XML AS CLOB(10K);
```

Although the application's XML variable declaration includes a LOB type specification, the variable declarations are considered the XML data type, not the LOB type that is used in the declaration. The application can also use non-XML variables in place of XML variables. For example, when a prepared statement is executed, the application might use a character variable to replace an XML parameter marker in the statement.

Although the XML data type is incompatible with all other data types, both XML and non-XML data types can be used for input to and output from XML data. Applications can use character, Unicode graphic, or binary variables as input or output variables in SQL statements.

Whenever an XML variable is used as input to an SQL statement, the value is implicitly parsed.

Host structures

A *host structure* is a COBOL group, PL/I, C, or C++ structure, or RPG data structure that is referenced in an SQL statement. In Java and REXX, there is no equivalent to a *host structure*.

Host structures are defined by statements of the host language, as explained in the [Embedded SQL programming](#) topic collection. As used here, the term host structure does not include an SQLCA or SQLDA.

The form of a host structure reference is identical to the form of a host variable reference. The reference `:S1:S2` is a host structure reference if `S1` names a host structure. If `S1` designates a host structure, `S2` must be either a small integer variable, or an array of small integer variables. `S1` is the host structure and `S2` is its indicator array.

A host structure can be referenced in any context where a list of host variables can be referenced. A host structure reference is equivalent to a reference to each of the host variables contained within the structure in the order which they are defined in the host language structure declaration. The *n*th variable of the indicator array is the indicator variable for the *n*th variable of the host structure.

In C, for example, if `V1`, `V2`, and `V3` are declared as variables within the structure `S1`, the statement:

```
EXEC SQL FETCH CURSOR1 INTO :S1;
```

is equivalent to:

```
EXEC SQL FETCH CURSOR1 INTO :V1, :V2, :V3;
```

If the host structure has *m* more variables than the indicator array, the last *m* variables of the host structure do not have indicator variables. If the host structure has *m* fewer variables than the indicator array, the last *m* variables of the indicator array are ignored. These rules also apply if a reference to a host structure includes an indicator variable or if a reference to a host variable includes an indicator array. If an indicator array or indicator variable is not specified, no variable of the host structure has an indicator variable.

In addition to structure references, individual host variables in the host structure or indicator variables in the indicator array can be referenced by qualified names. The qualified form is a host identifier followed by a period and another host identifier. The first host identifier must name a host structure, and the second host identifier must name a host variable within that host structure.

The general form of a host variable or host structure reference is:

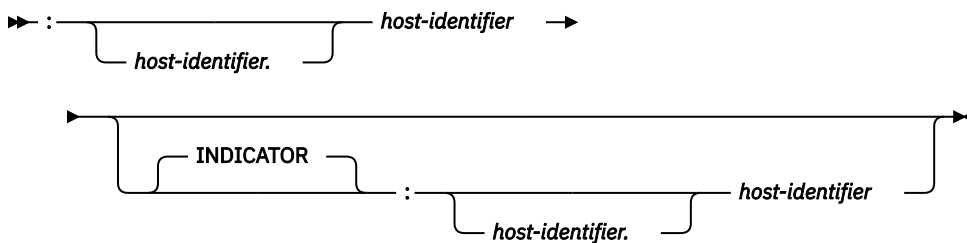

A *host-variable* in an expression must identify a host variable (not a structure) described in the program according to the rules for declaring host variables.

The following C example shows a references to host structure, host indicator array, and a host variable:

```
struct { char empno[7];
        struct { short int firstname_len;
                char firstname_text[12];
                } firstname;
        char midint,
        struct { short int lastname_len;
                char lastname_text[15];
                } lastname;
        char workdept[4];
```



```

        } pemp1;
short ind[14];
short eind
struct { short  ind1;
        short  ind2;
        } indstr;

.....
strcpy(pemp1.empno, "000220");
.....
EXEC SQL
  SELECT *
  INTO  :pemp1:ind
  FROM  corpdata.employee
  WHERE empno=:pemp1.empno;

```

In the example above, the following references to host variables and host structures are valid:

```

:pemp1      :pemp1.empno      :pemp1.empno:eind      :pemp1.empno:indstr.ind1

```

For more information about how to refer to host structures in C, C++, COBOL, PL/I, and RPG, see the [Embedded SQL programming](#) topic collection.

Host structure arrays

In PL/I, C++, and C, a host structure array is a structure name having a dimension attribute. In COBOL, it is a one-dimensional table. In RPG, it is an occurrence data structure. In ILE RPG, it can also be a data structure with the keyword DIM.

A host structure array can only be referenced in the FETCH statement when using a multiple-row fetch, or in an INSERT statement when using a multiple-row insert. Host structure arrays are defined by statements of the host language, as explained in the [Embedded SQL programming](#) topic collection.

The form of a host structure array is identical to the form of a host variable reference. The reference :S1:S2 is a reference to host structure array if S1 names a host structure array. If S1 designates a host structure, S2 must be either a small integer host variable, an array of small integer host variables, or a two dimensional array of small integer host variables. In the following example, S1 is the host structure array and S2 is its indicator array.

```

EXEC SQL FETCH CURSOR1 FOR 5 ROWS
      INTO :S1:S2;

```

The dimension of the host structure and the indicator array must be equal.

If the host structure has m more variables than the indicator array, the last m variables of the host structure do not have indicator variables. If the host structure has m fewer variables than the indicator array, the last m variables of the indicator array are ignored. If an indicator array or variable is not specified, no variable of the host structure array has an indicator variable.

The following diagram specifies the syntax of references to an array of host structures:

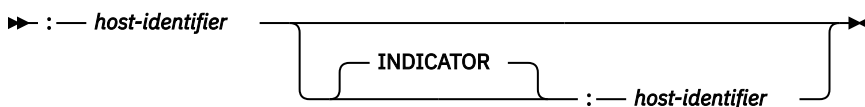

Arrays of host structures are not supported in REXX.

Functions

A *function* is an operation denoted by a function name followed by one or more operands that are enclosed in parentheses. It represents a relationship between a set of input values and a set of result values. The input values to a function are called *arguments*. For example, a function can be passed two input arguments that have date and time data types and return a value with a timestamp data type as the result.

Types of functions

There are several ways to classify functions.

One way to classify functions is as built-in, user-defined, or generated user-defined functions for distinct types.

- *Built-in functions* are functions that come with the database manager. These functions provide a single-value result. Built-in functions include operator functions such as "+", aggregate functions such as AVG, and scalar functions such as SUBSTR. For a list of the built-in aggregate and scalar functions and information about these functions, see [Chapter 4, “Built-in functions,” on page 245](#).

The *built-in functions* are part of schema QSYS2.³⁹

- *User-defined functions* are functions that are created using the CREATE FUNCTION statement and registered to the database manager in catalog table QSYS2.SYSROUTINES and catalog view QSYS2.SYSFUNCS. For more information, see [“CREATE FUNCTION” on page 965](#). These functions allow users to extend the function of the database manager by adding their own or third party vendor function definitions.

A user-defined function is either an *SQL*, *external*, or *sourced* function. An SQL function is defined to the database using only SQL statements. An external function is defined to the database with a reference to an external program or service program that is executed when the function is invoked. A sourced function is defined to the database with a reference to a built-in function or another user-defined function. Sourced functions can be used to extend built-in aggregate and scalar functions for use on distinct types.

A user-defined function resides in the schema in which it was created. The schema cannot be QSYS, QSYS2, QTEMP, SYSIBM, or SYSPROC.

- *Generated user-defined functions for distinct types* are functions that the database manager automatically generates when a strongly typed distinct type is created using the CREATE TYPE statement. These functions support casting from the distinct type to the source type and from the source type to the distinct type. The ability to cast between the data types is important because a strongly typed distinct type is compatible only with itself.

The generated cast functions reside in the same schema as the distinct type for which they were created. The schema cannot be QSYS, QSYS2, QTEMP, SYSIBM, or SYSPROC. For more information about the functions that are generated for a strongly typed distinct type, see [“CREATE TYPE \(distinct\)” on page 1184](#).

Another way to classify functions is as aggregate, scalar, or table functions, depending on the input data values and result values.

- An *aggregate function* receives a set of values for each argument (such as the values of a column) and returns a single-value result for the set of input values. Aggregate functions are sometimes called *column functions*. Built-in functions and user-defined sourced functions can be aggregate functions.

³⁹ *Built-in functions* are implemented internally by the database manager, so an associated program or service program object does not exist for a *built-in function*. Furthermore, the catalog does not contain information about *built-in functions*. However, *built-in functions* can be treated as if they exist in QSYS2 and a *built-in function* name can be qualified with QSYS2.

- A *scalar function* receives a single value for each argument and returns a single-value result. Built-in functions and user-defined functions can be scalar functions. Generated user-defined functions for distinct types are also scalar functions.
- A *table function* returns a table for the set of arguments it receives. Each argument is a single value. A table function can only be referenced in the FROM clause of a subselect. A table function can be defined as an external function or as an SQL function, but a table function cannot be a sourced function.

Table functions can be used to apply SQL language processing power to data that is not stored in the database or to allow access to such data as if it were stored in a table. For example, a table function can read a file, get data from the Web, or access a Lotus Notes® database and return a result table.

Function invocation

Each reference to a scalar or aggregate function (either built-in or user-defined) conforms to specific syntax.

The syntax is as follows: ⁴⁰

function-invocation

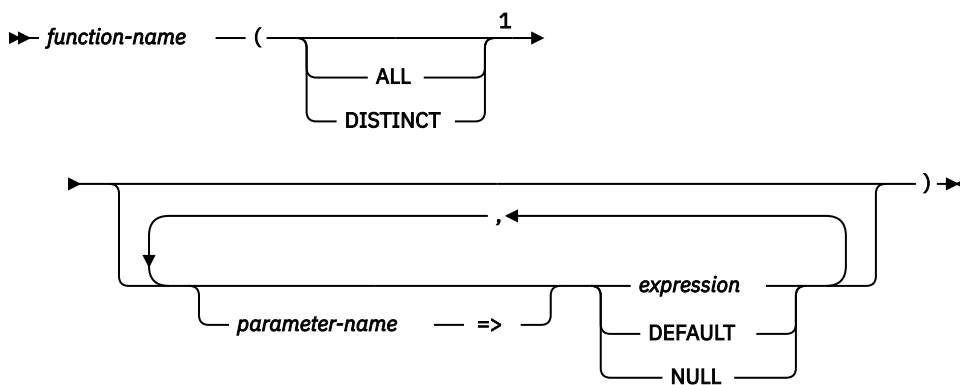

Notes:

- ¹ The ALL or DISTINCT keyword can be specified only for an aggregate function or a user-defined function that is sourced on an aggregate function.

Each reference to a table function conforms to the following syntax:

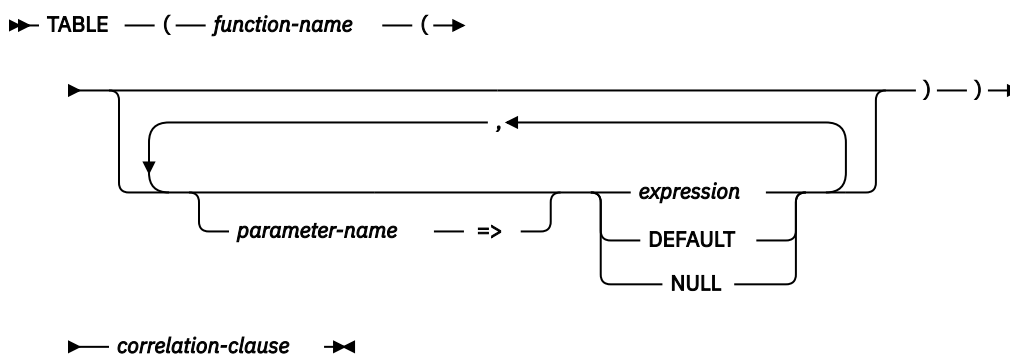

In the above syntax, *expression* is the same as it is for a scalar or aggregate function. See [“Expressions” on page 159](#) for other rules for *expression*.

An argument is a value passed to a function upon invocation or the specification of DEFAULT. When a function is invoked in SQL, it is passed a list of zero or more arguments. They are positional in that the

⁴⁰ A few functions allow keywords instead of expressions. For example, the CHAR function allows a list of keywords to indicate the desired date format. A few functions use keywords instead of commas in a comma separated list of expressions. For example, the EXTRACT, TRIM, and POSITION functions use keywords.

semantics of an argument are determined by its position in the argument list. A parameter is a formal definition of an input to a function. When a function is defined to the database, either internally (a built-in function) or by a user (a user-defined function), its parameters (zero or more) are specified, and the order of their definitions defines their positions and their semantics. Therefore, every parameter is a particular positional input to a function.

On invocation, an argument is assigned to a parameter using either the positional syntax or the named syntax. If using the positional syntax, an argument corresponds to a particular parameter according to its position in the list of arguments. If using the named syntax, an argument corresponds to a particular parameter by the name of the parameter. When an argument is assigned to a parameter using the named syntax, then all the arguments that follow it must also be assigned using the named syntax. The name of a named argument can appear only once in a function invocation. In cases where the data types of the arguments of the function invocation are not a match to the data types of the parameters of the selected function, the arguments are converted to the data type of the parameter at execution time using the same rules as assignment to columns. This includes the case where precision, scale, or length differs between the argument and the parameter. In cases where an argument of the function invocation is the specification of DEFAULT, the actual value used for the argument is the value specified as the default for the corresponding parameter in the function definition. If no default value was defined for the parameter, the null value is used. If an untyped expression (a parameter marker, a NULL keyword, or a DEFAULT keyword) is used as the argument, the data type associated with the argument is determined by the data type of the parameter of the selected function.

For SQL functions that are inlined and external functions, all references to date, time, or timestamp special register values in the argument list and in any default expressions will use one clock reading. For SQL functions that are not inlined, any references to date, time, or timestamp special register values in the argument list will use one clock reading for any default expressions and a separate clock reading for any references in the explicit arguments.

When the function is invoked, the value of each of its parameters is assigned, using storage assignment, to the corresponding parameter of the function. Control is passed to external functions according to the calling conventions of the host language. When execution of a user-defined aggregate or scalar function is complete, the result of the function is assigned, using storage assignment, to the result data type. For details on the assignment rules, see [“Assignments and comparisons”](#) on page 91.

Table functions can be referenced only in the FROM clause of a subselect. For more details on referencing a table function, see the description of the FROM clause in [“table-reference”](#) on page 730.

Function resolution

A function is invoked by its function name, which is implicitly or explicitly qualified with a schema name, followed by parentheses that enclose the arguments to the function.

Within the database, each function is uniquely identified by its function signature, which is its schema name, function name, the number of parameters, and the data types of the parameters. Thus, a schema can contain several functions that have the same name but each of which have a different number of parameters, or parameters with different data types. Or, a function with the same name, number of parameters, and types of parameters can exist in multiple schemas.

- **Overloading a function:** A function name for which there are multiple function instances with the same number of parameters in the same schema is called an overloaded function.
- **Overriding a function:** Functions can be overridden across the schemas of an SQL path, in which case there is more than one function with the same name and the same number of parameters in different schemas of the SQL path. These functions do not necessarily have different parameter data types.

When any function is invoked, the database manager must determine which function to execute. This process is called *function resolution*.

Determining the set of candidate functions:

- Let A be the number of arguments in a function invocation.
- Let P be the number of parameters in a function signature.

- Let N be the number of parameters in a function signature without a defined default.

Candidate functions for resolution of a function invocation are selected based on the following criteria:

- Each candidate function has a matching name and applicable number of parameters. An applicable number of parameters satisfies the condition $N \leq A \leq P$.
- Each parameter of a candidate function that does not have a corresponding argument in the function invocation, specified by either position or name, is defined with a default.
- Each candidate function from a set of one or more schemas has the EXECUTE privilege associated with the authorization ID of the statement invoking the function.

Function resolution is similar for functions that are invoked with a qualified or unqualified function name with the exception that for an unqualified name, the database manager needs to search more than one schema.

- *Qualified function resolution:* When a function is invoked with a function name and a schema name, the database manager only searches the specified schema for candidate functions.

If no candidate function in the schema is found, an error is returned. If a function is selected, its successful use depends on it being invoked in a context in which the returned result is allowed. For example, if the function returns an integer data type where a character data type is required, or returns a table where a table is not allowed, an error is returned.

- *Unqualified function resolution:* When a function is invoked with only a function name, the database manager needs to search more than one schema to resolve the function instance to execute. The SQL path contains the list of schemas to search. For each schema in the SQL path (see [“SQL path” on page 57](#)), the database manager selects candidate functions.

If no candidate function in any schema in the path is found, an error is returned. If a function is selected, its successful use depends on it being invoked in a context in which the returned result is allowed. For example, if the function returns an integer data type where a character data type is required, or returns a table where a table is not allowed, an error is returned.

After the database manager identifies the candidate functions, it selects the candidate with the best fit as the function instance to execute (see [“Determining the best fit” on page 151](#)). If more than one schema contains the function instance with the best fit (the function signatures are identical except for the schema name), the database manager selects the function whose schema is earliest in the SQL path.

Function resolution applies to all functions, including built-in functions. Built-in functions logically exist in schema QSYS2. If schema QSYS2 is not explicitly specified in the SQL path, the schema is implicitly assumed at the front of the path. When an unqualified function name is specified, the SQL path must be set to a list of schemas in the desired search order so that the intended function is selected.

In a CREATE VIEW or CREATE TABLE statement, function resolution occurs at the time the view or materialized query table is created. If another function with the same name is subsequently created, the view or materialized query table is not affected, even if the new function is a better fit than the one chosen at the time the view or materialized table was created. In a CREATE FUNCTION, CREATE PROCEDURE, CREATE TRIGGER, CREATE VARIABLE, CREATE MASK, or CREATE PERMISSION statement, function resolution occurs at the time the function, procedure, trigger, variable, mask, or permission is created. The schema of the function that was chosen is saved in the trigger, variable, mask, and permission. It is also saved in functions and procedures for default expressions. If another function with the same name is subsequently created, the function, procedure, trigger, variable, mask, permission, or routine default is only affected if the new function is a better fit than the one chosen at the time the object was created.

Determining the best fit

There might be more than one function with the same name that is a candidate for execution. In that case, the data types of the parameters, the position of the schema in the SQL path, and the total number of parameters of each function in the set of candidate functions are used to determine if the function meets the best fit requirements. Note that the data type of the result of the function or the type of function (aggregate, scalar, or table) under consideration does not enter into this determination.

If the set of candidate functions contains more than one function and named arguments are used in the function invocation, the ordinal position of the parameter corresponding to a named argument must be the same for all candidate functions.

The term *set of parameters* is used to refer to all of the parameters at the same position in the parameter lists (where such a parameter exists) for the set of candidate functions. The corresponding argument of a parameter is determined based on how the arguments are specified in the function invocation. For positional arguments, the corresponding argument to a parameter is the argument in the same position in the function invocation as the position of the parameter in the parameter list of the candidate function. For named arguments, the corresponding argument to a parameter is the argument with the same name as the parameter. In this case, the order of the arguments in the function invocation is not considered while determining the best fit. If the number of parameters in a candidate function is greater than the number of arguments in the function invocation, each parameter that does not have a corresponding argument is processed as if it does have a corresponding argument that has the DEFAULT keyword as the value.

The following steps are used to determine the function that is the best fit:

- Step 1: Considering arguments that are typed expressions

The database manager determines the function, or set of functions, that meet the best fit requirements for the invocation by comparing the data type of each parameter with the data type of the corresponding argument.

When determining whether the data type of a parameter is the same as the data type of its corresponding argument:

- Synonyms of data types match. For example, DOUBLE and FLOAT are considered to be the same.
- Attributes of a data type such as length, precision, scale, and CCSID are ignored. Therefore, CHAR(8) and CHAR(35) are considered to be the same, as are DECIMAL(11,2), and DECIMAL(4,3).
- The character and graphic types are considered to be the same. For example, the following are considered to be the same type: CHAR and GRAPHIC, VARCHAR and VARGRAPHIC, and CLOB and DBCLOB. CHAR(13) and GRAPHIC(8) are considered to be the same type.

A subset of the candidate functions is obtained by considering only those functions for which the data type of each argument of the function invocation that is not an untyped expression matches or is promotable to the data type of the corresponding parameter of the function instance. If the argument of the function invocation is an untyped expression, the data type of the corresponding parameter can be any data type. The precedence list for the promotion of data types in “Promotion of data types” on page 85 shows the data types that fit (considering promotion) for each data type in best-to-worst order. If this subset is not empty, then the best fit is determined using the Promotable process on this subset of candidate functions. If this subset is empty, then the best fit is determined using the Castable process on the original set of candidate functions.

Promotable process

This process determines the best fit only considering whether arguments in the function invocation match or can be promoted to the data type of the corresponding parameter of the function definition. For the subset of candidate functions, the parameter lists are processed from left to right, processing the set of parameters in the first position from the subset of candidate functions before moving on to the set of parameters in the second position, and so on. The following steps are used to eliminate candidate functions from the subset of candidate functions (only considering promotion):

1. If one candidate function has a parameter where the data type of the corresponding argument fits (only considering promotion) the data type of the parameter better than other candidate functions, those candidate functions that do not fit the function invocation equally well are eliminated. The precedence list for the promotion of data types in “Promotion of data types” on page 85 shows the data types that fit (considering promotion) for each data type in best-to-worst order.
2. If the data type of the corresponding argument is an untyped expression, no candidate functions are eliminated.

3. These steps are repeated for the next set of parameters from the remaining candidate functions until there are no more sets of parameters.

Castable process

This process determines the best fit first considering, for each parameter, if the data type of the corresponding argument in the function invocation matches or can be promoted to the data type of the parameter of the function definition. Then, for each set of parameters where no corresponding argument has a data type that was promotable, the database manager considers, for each parameter, if the data type of the corresponding argument can be implicitly cast for function resolution to the data type of the parameter.

For the set of candidate functions, the parameters in the parameter lists are processed from left to right, processing the set of parameters in the first position from all the candidate functions before moving on to the set of parameters in the second position, and so on. The following steps are used to eliminate candidate functions from the set of candidate functions (only considering promotion):

1. If one candidate function has a parameter where the data type of the corresponding argument fits (only considering promotion) the data type of the parameter better than other candidate functions, those candidate functions that do not fit the function invocation equally well are eliminated. The precedence list for the promotion of data types in [“Promotion of data types” on page 85](#) shows the data types that fit (considering promotion) for each data type in best-to-worst order.
2. If the data type for the corresponding argument is not promotable (which includes the case when the corresponding argument is an untyped expression) to the data type of the parameter of any candidate function, no candidate functions are eliminated.
3. These steps are repeated for the next set of parameters from the remaining candidate functions until there are no more sets of parameters.

If at least one set of parameters has no corresponding argument that fit (only considering promotion) and the corresponding argument for the set of parameters has a data type, the database manager compares each such set of parameters from left to right. The following steps are used to eliminate candidate functions from the set of candidate functions (considering implicit casting).

1. If all the data types of the set of parameters for all remaining candidate functions do not belong to the same data type precedence list, as specified in [“Promotion of data types” on page 85](#), an error is returned.
2. If the data type of the corresponding arguments cannot be implicitly cast to the data type of the parameters, as specified in [“Implicit casting for function resolution” on page 154](#), an error is returned.
3. If one candidate function has a parameter where the data type of the corresponding argument fits (considering implicit casting) the data type of the parameter better than other candidate functions, those candidate functions that do not fit the function invocation equally well are eliminated. The data type list in [“Implicit casting for function resolution” on page 154](#) shows the data type that fits (considering implicit casting) better.
4. These steps are repeated for the next set of parameters which has no corresponding argument that fits (only considering promotion) and the corresponding argument for the set of parameters has a data type until there are no more such sets of parameters or an error occurs.

- Step 2: Considering SQL path

If more than one candidate function remains, the database manager selects those candidate functions whose schema is earliest in the SQL path.

- Step 3: Considering number of arguments in the function invocation

If more than one candidate function remains and if one candidate function has a number of parameters that is less than or equal to the number of parameters of the other candidate functions, those candidate functions that have a greater number of parameters are eliminated.

- Step 4: Considering arguments that are untyped expressions

If more than one candidate function remains and at least one set of parameters has a corresponding argument that is an untyped expression, the database manager compares each such set of parameters from left to right. The following steps are used to eliminate candidate functions from the set of candidate functions:

1. If all the data types of the set of parameters for all remaining candidate functions do not belong to the same data type precedence list, as specified in [“Promotion of data types” on page 85](#), an error is returned.
2. If the data type of the parameter of one candidate function is further left in the data type ordering for implicit casting than other candidate functions, those candidate functions where the data type of the parameter is further right in the data type ordering are eliminated. The data type list in [“Implicit casting for function resolution” on page 154](#) shows the data type ordering for implicit casting.

If there are still multiple candidate functions, an error is returned.

Implicit casting for function resolution

Implicit casting for function resolution is not supported for arguments with a user-defined type or an XML, ROWID, or DATALINK data type. It is also not supported for built-in or user-defined cast functions. It is supported for the following cases:

- Any supported cast between built-in types, except for DATE, TIME, and TIMESTAMP to numeric data types. See [Table 16 on page 89](#).
- An untyped argument can be cast to any data type.

Similar to the data type precedence list for promotion, for implicit casting there is an order to the data types that are in the group of related data types. This order is used when performing function resolution that considers implicit casting. [Table 27 on page 154](#) shows the data type ordering for implicit casting for function resolution. The data types are listed in best-to-worst order (note that this is different than the ordering in the data type precedence list for promotion).

Data type group	Data type list for implicit casting for function resolution (in best-to-worst order)
Numeric data types	DECFLOAT, double, real, decimal, BIGINT, INTEGER, SMALLINT
Character and graphic string data types	VARCHAR or VARGRAPHIC, CHAR or GRAPHIC, CLOB or DBCLOB
Binary data types	VARBINARY, BINARY, BLOB, VARCHAR FOR BIT DATA, CHAR FOR BIT DATA
Datetime data types	TIMESTAMP, DATE, TIME

Note:

The lower case types above are defined as follows:

decimal

= DECIMAL(p,s) or NUMERIC(p,s)

real

= REAL or FLOAT(*n*) where *n* is a specification for single precision floating point

double

= DOUBLE, DOUBLE PRECISION, FLOAT or FLOAT(*n*) where *n* is a specification for double precision floating point

Examples

The following are examples of function resolution. (Note that not all required keywords are shown.)

Example 1: This is an example illustrating the SQL path considerations in function resolution. For this example, there are eight ACT functions, in three different schemas, registered as:

```
CREATE FUNCTION AUGUSTUS.ACT (CHAR(5), INT, DOUBLE) SPECIFIC ACT_1 ...
CREATE FUNCTION AUGUSTUS.ACT (INT, INT, DOUBLE) SPECIFIC ACT_2 ...
CREATE FUNCTION AUGUSTUS.ACT (INT, INT, DOUBLE, INT) SPECIFIC ACT_3 ...
CREATE FUNCTION JULIUS.ACT (INT, DOUBLE, DOUBLE) SPECIFIC ACT_4 ...
CREATE FUNCTION JULIUS.ACT (INT, INT, DOUBLE) SPECIFIC ACT_5 ...
CREATE FUNCTION JULIUS.ACT (SMALLINT, INT, DOUBLE) SPECIFIC ACT_6 ...
CREATE FUNCTION JULIUS.ACT (INT, INT, DECFLOAT) SPECIFIC ACT_7 ...
CREATE FUNCTION NERO.ACT (INT, INT, DEC(7,2)) SPECIFIC ACT_8 ...
```

The function reference is as follows (where I1 and I2 are INTEGER columns, and D is a DECIMAL column):

```
SELECT ... ACT(I1, I2, D) ...
```

Assume that the application making this reference has an SQL path established as:

```
"JULIUS", "AUGUSTUS", "CAESAR"
```

Following the function resolution rules:

- The function with specific name ACT_8 is eliminated as a candidate, because the schema NERO is not included in the SQL path.
- The function with specific name ACT_3 is eliminated as a candidate, because it has the wrong number of parameters. ACT_1 and ACT_6 are eliminated because, in both cases, the first argument cannot be promoted to the data type of the first parameter.
- Because there is more than one candidate remaining, the arguments are considered in order.
 - For the first argument, the remaining functions, ACT_2, ACT_4, ACT_5, and ACT_7 are an exact match with the argument type. No functions can be eliminated from consideration; therefore the next argument must be examined.
 - For this second argument, ACT_2, ACT_5, and ACT_7 are exact matches, but ACT_4 is not, so it is eliminated from consideration. The next argument is examined to determine some differentiation among ACT_2, ACT_5, and ACT_7.
 - For the third and last argument, neither ACT_2, ACT_5, nor ACT_7 match the argument type exactly. Although ACT_2 and ACT_5 are equally good, ACT_7 is not as good as the other two because the type DOUBLE is closer to DECIMAL than is DECFLOAT. ACT_7 is eliminated.
- There are two functions remaining, ACT_2 and ACT_5, with identical parameter signatures. The final tie-breaker is to see which function's schema comes first in the SQL path, and on this basis, ACT_5 is the function chosen.

Example 2: This is an example of a situation where function resolution will result in an error since more than one candidate function fits the invocation equally well, but the corresponding parameters for one of the arguments do not belong to the same type precedence list.

For this example, there are only three function in a single schema defined as follows:

```
CREATE FUNCTION CAESAR.ACT (INT, VARCHAR(5), VARCHAR(5)) SPECIFIC ACT_1 ...
CREATE FUNCTION CAESAR.ACT (INT, INT, DATE) SPECIFIC ACT_2 ...
CREATE FUNCTION CAESAR.ACT (INT, INT, DOUBLE) SPECIFIC ACT_3 ...
```

The function reference is as follows (where I1 and I2 are INTEGER columns, and VC is a VARCHAR column):

```
SELECT ... ACT(I1, I2, VC) ...
```

Assume that the application making this reference has an SQL path established as:

```
"CAESAR"
```

Following the function resolution rules:

- Each of the candidate functions is evaluated to determine if the data type of each input argument of the function invocation matches or is promotable to the data type of the corresponding parameter of the function instance:
 - For the first argument, all the candidate functions have an exact match with the parameter type.
 - For the second argument, ACT_1 is eliminated because INTEGER is not promotable to VARCHAR.
 - For the third argument, both ACT_2 and ACT_3 are eliminated since VARCHAR is not promotable to DATE or DOUBLE, so no candidate functions remain.
- Since the subset of candidate functions from above is empty, the candidate functions are considered using the castable process:
 - For the first argument, all the candidate functions have an exact match with the parameter type.
 - For the second argument, ACT_1 is eliminated since INTEGER is not promotable to VARCHAR. ACT_2 and ACT_3 are better candidates.
 - For the third argument, the data type of the corresponding parameters of ACT_2 and ACT_3 do not belong to the same data type precedence list, so an error is returned.

Example 3: This example illustrates a situation where function resolution will succeed using the castable process.

For this example, there are only three function in a single schema defined as follows:

```
CREATE FUNCTION CAESAR.ACT (INT, VARCHAR(5), VARCHAR(5)) SPECIFIC ACT_1 ...
CREATE FUNCTION CAESAR.ACT (INT, INT, DECFLOAT) SPECIFIC ACT_2 ...
CREATE FUNCTION CAESAR.ACT (INT, INT, DOUBLE) SPECIFIC ACT_3 ...
```

The function reference is as follows (where I1 and I2 are INTEGER columns, and VC is a VARCHAR column):

```
SELECT ... ACT(I1, I2, VC) ...
```

Assume that the application making this reference has an SQL path established as:

```
"CAESAR"
```

Following the function resolution rules:

- Each of the candidate functions is evaluated to determine if the data type of each input argument of the function invocation matches or is promotable to the data type of the corresponding parameter of the function instance:
 - For the first argument, all the candidate functions have an exact match with the parameter type.
 - For the second argument, ACT_1 is eliminated because INTEGER is not promotable to VARCHAR.
 - For the third argument, both ACT_2 and ACT_3 are eliminated since VARCHAR is not promotable to DECFLOAT or DOUBLE, so no candidate functions remain.
- Since the subset of candidate functions from above is empty, the candidate functions are considered using the castable process:
 - For the first argument, all the candidate functions have an exact match with the parameter type.
 - For the second argument, ACT_1 is eliminated since INTEGER is not promotable to VARCHAR. ACT_2 and ACT_3 are better candidates.
 - For the third argument, both DECFLOAT and DOUBLE are in the same data type precedence list and VARCHAR can be implicitly cast to both DECFLOAT and DOUBLE. Since DECFLOAT is a better fit for the purpose of implicit casting, ACT_2 is the best fit

Example 4: This example illustrates that during function resolution using the castable process that promotion of later arguments takes precedence over implicit casting.

For this example, there are only three function in a single schema defined as follows:

```
CREATE FUNCTION CAESAR.ACT (INT, INT, VARCHAR(5)) SPECIFIC ACT_1 ...
CREATE FUNCTION CAESAR.ACT (INT, INT, DECFLOAT) SPECIFIC ACT_2 ...
CREATE FUNCTION CAESAR.ACT (INT, INT, DOUBLE) SPECIFIC ACT_3 ...
```

The function reference is as follows (where I1 is an INTEGER columns, VC1 is a VARCHAR column, and C1 is a CHAR column):

```
SELECT ... ACT(I1, VC1, C1) ...
```

Assume that the application making this reference has an SQL path established as:

```
"CAESAR"
```

Following the function resolution rules:

- Each of the candidate functions is evaluated to determine if the data type of each input argument of the function invocation matches or is promotable to the data type of the corresponding parameter of the function instance:
 - For the first argument, all the candidate functions have an exact match with the parameter type.
 - For the second argument, all candidate functions are eliminated since VARCHAR is not promotable to INTEGER, so no candidate functions remain.
- Since the subset of candidate functions from above is empty, the candidate functions are considered using the castable process:
 - For the first argument, all the candidate functions have an exact match with the parameter type.
 - For the second argument, none of the candidate functions have a parameter to which the corresponding argument can be promoted, so no candidate functions are eliminated.
 - Since the third argument can be promoted to the parameter of ACT_1, but not to the parameters of ACT_2 or ACT_3, ACT_1 is the best fit.

Best fit considerations

Once the function is selected, there are still possible reasons why the use of the function may not be permitted. Each function is defined to return a result with a specific data type. If this result data type is not compatible within the context in which the function is invoked, an error will occur.

For example, given functions named STEP defined with different data types as the result:

```
STEP(SMALLINT) RETURNS DATE)
STEP(DOUBLE) RETURNS INTEGER
```

and the following function reference (where S is a SMALLINT column):

```
SELECT ... 3 +STEP(S)
```

then, because there is an exact match on argument type, the first STEP is chosen. An error occurs on the statement because the result type is DATE instead of a numeric type as required for an argument of the addition operator.

In cases where the arguments of the function invocation were not an exact match to the data types of the parameters of the selected function, the arguments are converted to the data type of the parameter at execution using the same rules as assignment to columns (see [“Assignments and comparisons”](#) on page 91). This includes the case where precision, scale, length, or CCSID differs between the argument and the parameter.

An error also occurs in the following examples:

- The function is referenced in the TABLE clause of a FROM clause, but the function selected by the function resolution step is a scalar or aggregate function.

- The function referenced in an SQL statement requires a scalar or aggregate function, but the function selected by the function resolution step is a table function.

Expressions

An expression specifies a value.

Authorization: The use of some of the expressions, such as a *scalar-fullselect*, *sequence-reference*, *function-invocation*, or *cast-specification* may require having the appropriate authorization. For these expressions, the privileges held by the authorization ID of the statement must include the following authorization:

- *global variable*. For information about authorization considerations, see [“Global variables”](#) on page 139.
- *scalar-fullselect*. For information about authorization considerations, see [Chapter 6, “Queries,”](#) on page 723.
- *sequence-reference*. The authorization to reference the sequence. For information about authorization considerations, see [“Notes”](#) on page 194.
- *function-invocation*. The authorization to execute a user-defined function. For information about authorization considerations, see [“Function invocation”](#) on page 149.
- *array-element-specification*. The authorization to reference an array type. For information about authorization considerations, see [“GRANT \(type privileges\)”](#) on page 1374.
- *cast-specification*. The authorization to reference a user-defined type. For information about authorization considerations, see [“CAST specification”](#) on page 177.

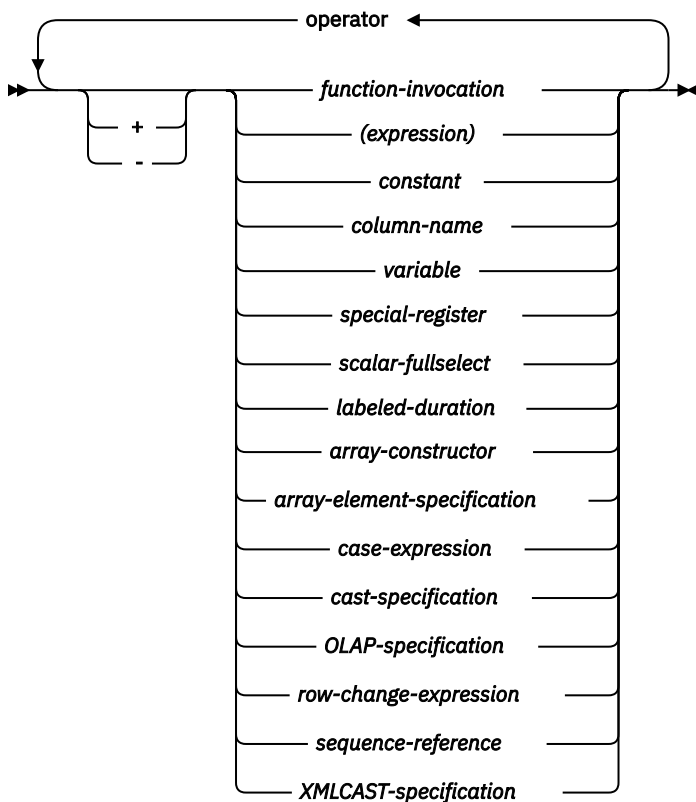

operator:

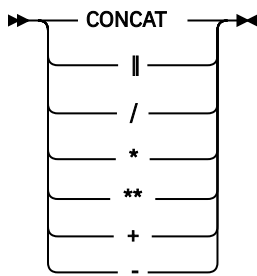

Without operators

If no operators are used, the result of the expression is the specified value.

Example

SALARY	:SALARY	'SALARY'	MAX(SALARY)
--------	---------	----------	-------------

With arithmetic operators

If arithmetic operators are used, the result of the expression is a number derived from the application of the operators to the values of the operands.

If any operand can be null, the result can be null. If any operand has the null value, the result of the expression is the null value.

If one operand of an arithmetic operator is numeric, the other operand can be a string. The string is first converted to the data type of the numeric operand and must contain a valid string representation of a number.

The prefix operator *+* (*unary plus*) does not change its operand. The prefix operator *-* (*unary minus*) reverses the sign of a nonzero non-decimal floating-point operand. The prefix operator *-* (*unary minus*) reverses the sign of all decimal floating-point operands, including zero and special values; that is, signaling and non-signaling NaNs and plus and minus infinity. If the data type of *A* is small integer, the data type of *- A* is large integer. The first character of the token following a prefix operator must not be a plus or minus sign.

The *infix operators*, *+*, *-*, ***, */*, and ****, specify addition, subtraction, multiplication, division, and exponentiation, respectively. The value of the second operand of division must not be zero, except if the calculation is performed using decimal floating-point arithmetic and the first operand is infinity or -infinity.

In COBOL, blanks must precede and follow a minus sign to avoid any ambiguity with COBOL host variable names (which allow use of a dash).

The result of an exponentiation (****) operator is a double-precision floating-point number. The result of the other operators depends on the type of the operand.

Operands with a NUMERIC data type are converted to DECIMAL operands prior to performing the arithmetic operation.

Two integer operands

If both operands of an arithmetic operator are integers with zero scale, the operation is performed in binary, and the result is a large integer unless either (or both) operand is a big integer, in which case the result is a big integer. Any remainder of division is lost. The result of an integer arithmetic operation (including *unary minus*) must be within the range of large or big integers. If either integer operand has nonzero scale, it is converted to a decimal operand with the same precision and scale.

Integer and decimal operands

If one operand is an integer with zero scale and the other is decimal, the operation is performed in decimal using a temporary copy of the integer that has been converted to a decimal number with precision and scale 0.

This is defined in the following table:

Operand	Precision of Decimal Copy
Column or variable: big integer	19
Column or variable: large integer	11
Column or variable: small integer	5
Constant (including leading zeros)	Same as the number of digits in the constant

If one operand is an integer with nonzero scale, it is first converted to a decimal operand with the same precision and scale.

Two decimal operands

If both operands are decimal, the operation is performed in decimal. The result of any decimal arithmetic operation is a decimal number with a precision and scale that are dependent on the operation and the precision and scale of the operands. If the operation is addition or subtraction and the operands do not have the same scale, the operation is performed with a temporary copy of one of the operands. The copy of the shorter operand is extended with trailing zeros so that its fractional part has the same number of digits as the longer operand.

Unless specified otherwise, all functions and operations that accept decimal numbers allow a precision of up to 63 digits. The result of a decimal operation must not have a precision greater than 63.

Decimal arithmetic in SQL

The following formulas define the precision and scale of the result of decimal operations in SQL. The symbols p and s denote the precision and scale of the first operand and the symbols p' and s' denote the precision and scale of the second operand.

The symbol mp denotes the maximum precision. The value of mp is 63 if:

- either p or p' is greater than 31, or
- a value of 63 was explicitly specified for the maximum precision.

Otherwise, the value of mp is 31.

The symbol ms denotes the maximum scale. The default value of ms is 31. ms can be explicitly set to any number from 0 to the maximum precision.

The symbol mds denotes the minimum divide scale. The default value of mds is 0, where 0 indicates that no minimum scale is specified. mds can be explicitly set to any number from 1 to $\min(ms, 9)$.

The maximum precision, maximum scale, and minimum divide scale can be explicitly specified on the DECRESULT parameter of the CRTSQLxxx command, RUNSQLSTM command, or SET OPTION statement. They can also be specified in ODBC data sources, JDBC properties, OLE DB properties, .NET properties.

Addition and subtraction

The scale of the result of addition and subtraction is $\max(s, s')$. The precision is $\min(mp, \max(p-s, p'-s') + \max(s, s') + 1)$.

Multiplication

The precision of the result of multiplication is $\min(mp, p+p')$ and the scale is $\min(ms, s+s')$.

Division

The precision of the result of division is $(p-s+s') + \max(mds, \min(ms, mp - (p-s+s')))$. The scale is $\max(mds, \min(ms, mp - (p-s+s')))$. The scale must not be negative.

Floating-point operands

If either operand of an arithmetic operator is floating point and neither operand is decimal floating-point, the operation is performed in floating point. The operands are first converted to double-precision floating-point numbers, if necessary. Thus, if any element of an expression is a floating-point number, the result of the expression is a double-precision floating-point number.

An operation involving a floating-point number and an integer is performed with a temporary copy of the integer converted to double-precision floating point. An operation involving a floating-point number and a decimal number is performed with a temporary copy of the decimal number that has been converted to double-precision floating point. The result of a floating-point operation must be within the range of floating-point numbers.

The order in which floating-point operands (or arguments to functions) are processed can slightly affect results because floating-point operands are approximate representations of real numbers. Since the order in which operands are processed may be implicitly modified by the optimizer (for example, the optimizer may decide what degree of parallelism to use and what access plan to use), an application should not depend on the results being precisely the same each time an SQL statement is executed that uses floating-point operands.

Decimal floating-point operands

If either operand of an arithmetic operator is decimal floating-point, the operation is performed in decimal floating-point.

Integer and DECFLOAT(n) operands

If one operand is a small integer or integer and the other is DECFLOAT, the operation is performed in DECFLOAT(n) using a temporary copy of the integer that has been converted to a DECFLOAT(n) number. If one operand is a big integer and the other is DECFLOAT, then a temporary copy of the big integer is converted to a DECFLOAT(34) number. The rules for two DECFLOAT operands are then applied.

Decimal and DECFLOAT(n) operands

If one operand is a decimal and the other is DECFLOAT, the operation is performed in DECFLOAT using a temporary copy of the decimal number that has been converted to a DECFLOAT number based on the precision of the decimal number. If the decimal number has a precision < 17, the decimal number is converted to DECFLOAT(16). Otherwise, the decimal number is converted to a DECFLOAT(34) number. The rules for two DECFLOAT operands are then applied.

Floating-point and DECFLOAT(n) operands

If one operand is floating-point (real or double) and the other is DECFLOAT, the operation is performed in DECFLOAT(n) using a temporary copy of the floating-point number that has been converted to a DECFLOAT(n) number.

Two DECFLOAT operands

If both operands are DECFLOAT(n), the operation is performed in DECFLOAT(n). If one operand is DECFLOAT(16) and the other is DECFLOAT(34), the operation is performed in DECFLOAT(34).

General arithmetic operation rules for DECFLOAT

The following general rules apply to all arithmetic operations on the DECFLOAT data type.

- Every operation on finite numbers is carried out (as described under the individual operations) as though an exact mathematical result is computed, using integer arithmetic on the coefficient where possible.

If the coefficient of the theoretical exact result has no more than the number of digits that reflect its precision (16 or 34), then (unless there is an underflow or overflow) it is used for the result without change. Otherwise, it is rounded (shortened) to exactly the number of digits that reflect its precision (16 or 34) and the exponent is increased by the number of digits removed.

Rounding uses the DECFLOAT rounding mode. For more information, see [“CURRENT DECFLOAT ROUNDING MODE”](#) on page 126.

If the value of the adjusted exponent of the result is less than E_{\min} , then a subnormal warning is returned.⁴¹ In this case, the calculated coefficient and exponent form the result, unless the value of the exponent is less than E_{tiny} , in which case the exponent will be set to E_{tiny} , the coefficient is rounded (possibly to zero) to match the adjustment of the exponent, and the sign is unchanged. If this rounding gives an inexact result then an underflow warning is returned.⁴¹

If the value of the adjusted exponent of the result is larger than E_{\max} then an overflow warning is returned. In this case, the result may be infinite. It will have the same sign as the theoretical result.

- Arithmetic using the special value Infinity follows the usual rules, where negative Infinity is less than every finite number and positive Infinity is greater than every finite number. Under these rules, an infinite result is always exact. The following arithmetic operations return a warning and result in NaN:⁴¹
 - Add +infinity to -infinity during an addition or subtraction operation
 - Multiply 0 or -0 by +infinity or -infinity
 - Divide either +infinity or -infinity by either +infinity or -infinity
- Signaling NaNs always raise a warning or error when used as an operand of an arithmetic operation and NaNs are returned.
- The result of an arithmetic operation which has an operand which is a NaN, is NaN. The sign of the result is copied from the first operand which is a NaN. Whenever the result is a NaN, the sign of the result depends only on the copied operand.
- The sign of the result of a multiplication or division will be negative only if the operands have different signs and neither is a NaN.
- The sign of the result of an addition or subtraction will be negative only if the result is less than zero and neither operand is a NaN.

In some instances, negative zero might be the result from arithmetic operations and numeric functions.

Examples involving special values

```
INFINITY + 1           = INFINITY
INFINITY + INFINITY    = INFINITY
INFINITY + -INFINITY   = NAN           -- warning
NAN + 1                = NAN
NAN + INFINITY         = NAN
1 - INFINITY           = -INFINITY
INFINITY - INFINITY    = NAN           -- warning
-INFINITY - -INFINITY  = NAN           -- warning
-0.0 - 0.0E1          = -0.0
-1.0 * 0.0E1          = -0.0
1.0E1 / 0              = INFINITY
-1.0E5 / 0.0          = -INFINITY
1.0E5 / -0             = -INFINITY
INFINITY / -INFINITY   = NAN           -- warning
INFINITY / 0           = INFINITY     -- warning
```

⁴¹ The warning is only returned if *YES is specified for the SQL_DECFLOAT_WARNINGS query option.

```
-INFINITY / 0          = -INFINITY  -- warning
-INFINITY / -0        = INFINITY    -- warning
```

Distinct type operands

A weakly typed distinct type operand can be used with arithmetic operators, provided that the source type of the weakly typed distinct type is supported by the arithmetic operator.

A strongly typed distinct type cannot be used with arithmetic operators even if its source data type is numeric. To perform an arithmetic operation, create a function with the arithmetic operator as its source. For example, if there were distinct types INCOME and EXPENSES, both of which had DECIMAL(8,2) data types, then the following user-defined function, REVENUE, could be used to subtract one from the other.

```
CREATE FUNCTION REVENUE ( INCOME, EXPENSES )
  RETURNS DECIMAL(8,2) SOURCE "-" ( DECIMAL, DECIMAL)
```

Alternately, the - (minus) operator could be overridden using a user-defined function to subtract the new data types.

```
CREATE FUNCTION "-" ( INCOME, EXPENSES )
  RETURNS DECIMAL(8,2) SOURCE "-" ( DECIMAL, DECIMAL)
```

Alternatively, the distinct type can be cast to a built-in type, and the result can be used as an operand of an arithmetic operator.

With the concatenation operator

If the concatenation operator (CONCAT or ||) is used, the result of the expression is a string.

The operands of concatenation must be compatible strings or numeric, date, time, or timestamp data types.⁴² An operand must not be a strongly typed distinct type. If an operand is a weakly typed distinct type, the source data type of the distinct type is used. If a numeric, date, time, or timestamp operand is specified, it is CAST to the equivalent character string prior to concatenation. Note that a binary string cannot be concatenated with a character string unless the character string is defined as FOR BIT DATA.

The data type of the result is determined by the data types of the operands. The data type of the result is summarized in the following table:

If one operand column is ...	And the other operand is ...	The data type of the result column is ...
DBCLOB(x)	CHAR(y)* or VARCHAR(y)* or CLOB(y)* or GRAPHIC(y) or VARGRAPHIC(y) or DBCLOB(y)	DBCLOB(z) where z = MIN(x + y, maximum length of a DBCLOB)
VARGRAPHIC(x)	CHAR(y)* or VARCHAR(y)* or GRAPHIC(y) or VARGRAPHIC(y)	VARGRAPHIC(z) where z = MIN(x + y, maximum length of a VARGRAPHIC)
GRAPHIC(x)	CHAR(y)* mixed data	VARGRAPHIC(z) where z = MIN(x + y, maximum length of a VARGRAPHIC)
GRAPHIC(x)	CHAR(y)* SBCS data or GRAPHIC(y)	GRAPHIC(z) where z = MIN(x + y, maximum length of a GRAPHIC)
CLOB(x)*	GRAPHIC(y) or VARGRAPHIC(y)	DBCLOB(z) where z = MIN(x + y, maximum length of a DBCLOB)

⁴² Using the vertical bar (|) character might inhibit code portability between relational database products. Use the CONCAT operator in place of the || operator. Alternatively, if conformance to SQL 2003 Core standard is of primary importance, use the || operator).

<i>Table 28. Result Data Types With Concatenation (continued)</i>		
If one operand column is ...	And the other operand is ...	The data type of the result column is ...
VARCHAR(x)*	GRAPHIC(y)	VARGRAPHIC(z) where z = MIN(x + y, maximum length of a VARGRAPHIC)
CLOB(x)	CHAR(y) or VARCHAR(y) or CLOB(y)	CLOB(z) where z = MIN(x + y, maximum length of a CLOB)
VARCHAR(x)	CHAR(y) or VARCHAR(y)	VARCHAR(z) where z = MIN(x + y, maximum length of a VARCHAR)
CHAR(x) mixed data	CHAR(y)	VARCHAR(z) where z = MIN(x + y, maximum length of a VARCHAR)
CHAR(x) SBCS data	CHAR(y)	CHAR(z) where z = MIN(x + y, maximum length of a CHAR)
BLOB(x)	BINARY(y) or VARBINARY(y) or BLOB(y) or CHAR(y) FOR BIT DATA or VARCHAR(y) FOR BIT DATA	BLOB(z) where z = MIN(x + y, maximum length of a BLOB)
VARBINARY(x)	BINARY(y) or VARBINARY(y) or CHAR(y) FOR BIT DATA or VARCHAR(y) FOR BIT DATA	VARBINARY(z) where z = MIN(x + y, maximum length of a VARBINARY)
BINARY(x)	VARCHAR(y) FOR BIT DATA	VARBINARY(z) where z = MIN(x + y, maximum length of a VARBINARY)
BINARY(x)	BINARY(y) or CHAR(y) FOR BIT DATA	BINARY(z) where z = MIN(x + y, maximum length of a BINARY)
Note:		
* Character strings are only allowed when the other operand is a graphic string if the graphic string is Unicode.		

<i>Table 29. Result Encoding Schemes With Concatenation</i>		
If one operand column is ...	And the other operand is ...	The data type of the result column is ...
Unicode data	Unicode data or DBCS or mixed or SBCS data	Unicode data
DBCS data	DBCS data	DBCS data
bit data	mixed or SBCS or bit data	bit data
mixed data	mixed or SBCS data	mixed data
SBCS data	SBCS data	SBCS data

If the sum of the lengths of the operands exceeds the maximum length attribute of the resulting data type:

- The length attribute of the result is the maximum length of the resulting data type.⁴³
- If only blanks are truncated no warning or error occurs.
- If non-blanks are truncated, an error occurs.

⁴³ If the expression is in the select-list, the length attribute may be further reduced in order to fit within the maximum record size. For more information, see [“Maximum row sizes”](#) on page 1154.

If either operand can be null, the result can be null, and if either is null, the result is the null value. Otherwise, the result consists of the first operand string followed by the second.

With mixed data this result will not have redundant shift codes "at the seam". Thus, if the first operand is a string ending with a "shift-in" character (X'0F'), while the second operand is a character string beginning with a "shift-out" character (X'0E'), these two bytes are eliminated from the result.

The actual length of the result is the sum of the lengths of the operands unless redundant shifts are eliminated; in which case, the actual length is two less than the sum of the lengths of the operands.

The CCSID of the result is determined by the CCSID of the operands as explained under [“Conversion rules for operations that combine strings”](#) on page 112. Note that as a result of these rules:

- If any operand is bit data, the result is bit data.
- If one operand is mixed data and the other is SBCS data, the result is mixed data. However, this does not necessarily mean that the result is well-formed mixed data.

Example

Concatenate the column FIRSTNME with a blank and the column LASTNAME.

```
FIRSTNME CONCAT ' ' CONCAT LASTNAME
```

Scalar fullselect

A scalar fullselect as supported in an expression is a fullselect, enclosed in parentheses, that returns a single row consisting of a single column value. If the fullselect does not return a row, the result of the expression is the null value. If the select list element is an expression that is simply a column name, the result column name is based on the name of the column. Otherwise, the result column is unnamed.

See [“fullselect”](#) on page 771 for more information.

A scalar fullselect is not allowed if the query specifies:

- a distributed table,
- a table with a read trigger, or
- a logical file built over multiple physical file members.

If the scalar fullselect is a subselect, it is also referred to as a scalar subselect. See [“subselect”](#) on page 724 for more information.

Datetime operands and durations

Datetime values can be incremented, decremented, and subtracted. These operations may involve decimal numbers called *durations*. A *duration* is a positive or negative number representing an interval of time.

There are four types of durations:

Labeled durations

The form a labeled duration is as follows:

labeled-duration:

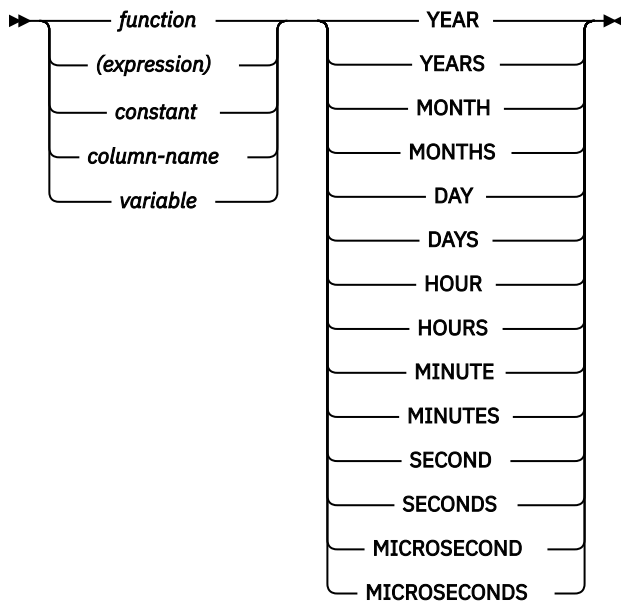

A *labeled duration* represents a specific unit of time as expressed by a number (which can be the result of an expression) followed by one of the seven duration keywords: YEARS, MONTHS, DAYS, HOURS, MINUTES, SECONDS, or MICROSECONDS⁴⁴. The number specified is converted as if it were assigned to a DECIMAL(15,0) number, except for SECONDS which uses DECIMAL(27,12) to allow 0 to 12 digits of fractional seconds to be included. The MICROSECONDS duration returns 6 digits of fractional seconds.

A labeled duration can only be used as an operand of an arithmetic operator in which the other operand is a value of data type DATE, TIME, or TIMESTAMP. Thus, the expression HIREDATE + 2 MONTHS + 14 DAYS is valid whereas the expression HIREDATE + (2 MONTHS + 14 DAYS) is not. In both of these expressions, the labeled durations are 2 MONTHS and 14 DAYS.

Date duration

A *date duration* represents a number of years, months, and days, expressed as a DECIMAL(8,0) number. To be properly interpreted, the number must have the format *yyyymmdd*, where *yyyy* represents the number of years, *mm* the number of months, and *dd* the number of days. The result of subtracting one date value from another, as in the expression HIREDATE - BRTHDATE, is a date duration.

Time duration

A *time duration* represents a number of hours, minutes, and seconds, expressed as a DECIMAL(6,0) number. To be properly interpreted, the number must have the format *hhmmss* where *hh* represents the number of hours, *mm* the number of minutes, and *ss* the number of seconds. The result of subtracting one time value from another is a time duration.

Timestamp duration

A *timestamp duration* represents a number of years, months, days, hours, minutes, seconds, and fractional seconds, expressed as a DECIMAL(14+s,s) number, where *s* is the number of digits of fractional seconds ranging from 0 to 12. To be properly interpreted, the number must have the format *yyyymmddhhmmss.zzzzzzzzzzzz*, where *yyyy*, *mm*, *dd*, *hh*, *mm*, *ss*, and *zzzzzzzzzzzz* represent, respectively, the number of years, months, days, hours, minutes, seconds, and fractional seconds. The result of subtracting one timestamp value from another is a timestamp duration with scale that matches the maximum timestamp precision of the timestamp operands.

⁴⁴ Note that the singular form of these keywords is also acceptable: YEAR, MONTH, DAY, HOUR, MINUTE, SECOND, and MICROSECOND.

Datetime arithmetic in SQL

The only arithmetic operations that can be performed on datetime values are addition and subtraction. If a datetime value is the operand of addition, the other operand must be a duration.

The specific rules governing the use of the addition operator with datetime values follow:

- If one operand is a date, the other operand must be a date duration or labeled duration of years, months, or days.
- If one operand is a time, the other operand must be a time duration or a labeled duration of hours, minutes, or seconds.
- If one operand is a timestamp, the other operand must be a duration. Any type of duration is valid.
- Neither operand of the addition operator can be an untyped parameter marker.

The rules for the use of the subtraction operator on datetime values are not the same as those for addition because a datetime value cannot be subtracted from a duration, and because the operation of subtracting two datetime values is not the same as the operation of subtracting a duration from a datetime value. The specific rules governing the use of the subtraction operator with datetime values follow:

- If the first operand is a date, the second operand must be a date, a timestamp, a date duration, a string representation of a date, a string representation of a timestamp, or a labeled duration of years, months, or days.
- If the second operand is a date, the first operand must be a date, a timestamp, a string representation of a date, or a string representation of a timestamp.
- If the first operand is a time, the second operand must be a time, a time duration, a string representation of a time, or a labeled duration of hours, minutes, or seconds.
- If the second operand is a time, the first operand must be a time, or string representation of a time.
- If the first operand is a timestamp, the second operand must be a date, a timestamp, a string representation of a date, a string representation of a timestamp, or a duration. If the second operand is a string representation of a timestamp, it is implicitly converted to a timestamp with the same precision as the first operand.
- If the second operand is a timestamp, the first operand must be a date, a timestamp, a string representation of a date, or a string representation of a timestamp. If the first operand is a string representation of a timestamp, it is implicitly converted to a timestamp with the same precision as the second operand.
- Neither operand of the subtraction operator can be an untyped parameter marker.

Date arithmetic

Dates can be subtracted, incremented, or decremented.

Subtracting dates

The result of subtracting one date (DATE2) from another (DATE1) is a date duration that specifies the number of years, months, and days between the two dates. The data type of the result is DECIMAL(8,0). If DATE1 is greater than or equal to DATE2, DATE2 is subtracted from DATE1. If DATE1 is less than DATE2, however, DATE1 is subtracted from DATE2, and the sign of the result is made negative. The following procedural description clarifies the steps involved in the operation $RESULT = DATE1 - DATE2$.

If $DAY(DATE2) \leq DAY(DATE1)$
then $DAY(RESULT) = DAY(DATE1) - DAY(DATE2)$.

If $DAY(DATE2) > DAY(DATE1)$
then $DAY(RESULT) = N + DAY(DATE1) - DAY(DATE2)$
where $N =$ the last day of $MONTH(DATE2)$.
 $MONTH(DATE2)$ is then incremented by 1.

If MONTH(DATE2) <= MONTH(DATE1)
then MONTH(RESULT) = MONTH(DATE1) - MONTH(DATE2).

If MONTH(DATE2) > MONTH(DATE1)
then MONTH(RESULT) = 12 + MONTH(DATE1) - MONTH(DATE2).
YEAR(DATE2) is then incremented by 1.

YEAR(RESULT) = YEAR(DATE1) - YEAR(DATE2).

For example, the result of DATE('3/15/2000') - '12/31/1999' is 215 (or, a duration of 0 years, 2 months, and 15 days).

Incrementing and decrementing dates

The result of adding a duration to a date, or of subtracting a duration from a date, is itself a date. (For the purposes of this operation, a month denotes the equivalent of a calendar page. Adding months to a date, then, is like turning the pages of a calendar, starting with the page on which the date appears.) The result must fall between the dates January 1, 0001 and December 31, 9999 inclusive.

If a duration of years is added or subtracted, only the year portion of the date is affected. The month is unchanged, as is the day unless the result would be February 29 of a non-leap-year. In this case, the day is changed to 28, an SQLSTATE of '01506' is assigned to the RETURNED_SQLSTATE condition area item in the SQL Diagnostics Area (or SQLWARN6 in the SQLCA is set to 'W') to indicate the end-of-month adjustment.

Similarly, if a duration of months is added or subtracted, only months and, if necessary, years are affected. The day portion of the date is unchanged unless the result would be invalid (September 31, for example). In this case, the day is set to the last day of the month, and SQLWARN6 in the SQLCA is set to 'W' to indicate the end-of-month adjustment.

Adding or subtracting a duration of days will, of course, affect the day portion of the date, and potentially the month and year. Adding a labeled duration of DAYS will not cause an end-of-month adjustment.

Date durations, whether positive or negative, may also be added to and subtracted from dates. As with labeled durations, the result is a valid date, and a warning indicator is set in the SQLCA whenever an end-of-month adjustment is necessary.

When a positive date duration is added to a date, or a negative date duration is subtracted from a date, the date is incremented by the specified number of years, months, and days, in that order. Thus DATE1 + X, where X is a positive DECIMAL(8,0) number, is equivalent to the expression:

- DATE1 + YEAR(X) YEARS + MONTH(X) MONTHS + DAY(X) DAYS

When a positive date duration is subtracted from a date, or a negative date duration is added to a date, the date is decremented by the specified number of days, months, and years, in that order. Thus, DATE1 - X, where X is a positive DECIMAL(8,0) number, is equivalent to the expression:

- DATE1 - DAY(X) DAYS - MONTH(X) MONTHS - YEAR(X) YEARS

Note: If one or more months is added to a given date and then the same number of months is subtracted from the result, the final date is not necessarily the same as the original date.

Also note that logically equivalent expressions may not produce the same result. For example:

- (DATE('2002-01-31') + 1 MONTH) + 1 MONTH will result in a date of 2002-03-28.

does not produce the same result as

- DATE('2002-01-31') + 2 MONTHS will result in a date of 2002-03-31.

The order in which labeled date durations are added to and subtracted from dates can affect the results. For compatibility with the results of adding or subtracting date durations, a specific order must be used. When labeled date durations are added to a date, specify them in the order of YEARS + MONTHS + DAYS. When labeled date durations are subtracted from a date, specify them in the order of DAYS - MONTHS - YEARS. For example, to add one year and one day to a date, specify:

- DATE1 + 1 YEAR + 1 DAY

To subtract one year, one month, and one day from a date, specify:

- DATE1 - 1 DAY - 1 MONTH - 1 YEAR

Time arithmetic

Times can be subtracted, incremented, or decremented.

Subtracting times

The result of subtracting one time (TIME2) from another (TIME1) is a time duration that specifies the number of hours, minutes, and seconds between the two times. The data type of the result is DECIMAL(6,0). If TIME1 is greater than or equal to TIME2, TIME2 is subtracted from TIME1. If TIME1 is less than TIME2, however, TIME1 is subtracted from TIME2, and the sign of the result is made negative. The following procedural description clarifies the steps involved in the operation RESULT = TIME1 - TIME2.

If SECOND(TIME2) <= SECOND(TIME1)
then SECOND(RESULT) = SECOND(TIME1) - SECOND(TIME2).

If SECOND(TIME2) > SECOND(TIME1)
then SECOND(RESULT) = 60 + SECOND(TIME1) - SECOND(TIME2).
MINUTE(TIME2) is then incremented by 1.

If MINUTE(TIME2) <= MINUTE(TIME1)
then MINUTE(RESULT) = MINUTE(TIME1) - MINUTE(TIME2).

If MINUTE(TIME2) > MINUTE(TIME1)
then MINUTE(RESULT) = 60 + MINUTE(TIME1) - MINUTE(TIME2).
HOUR(TIME2) is then incremented by 1.

HOUR(RESULT) = HOUR(TIME1) - HOUR(TIME2).

For example, the result of TIME('11:02:26') - '00:32:56' is 102930 (a duration of 10 hours, 29 minutes, and 30 seconds).

Incrementing and decrementing times

The result of adding a duration to a time, or of subtracting a duration from a time, is itself a time. Any overflow or underflow of hours is discarded, thereby ensuring that the result is always a time. If a duration of hours is added or subtracted, only the hours portion of the time is affected. The minutes and seconds are unchanged.

Similarly, if a duration of minutes is added or subtracted, only minutes and, if necessary, hours are affected. The seconds portion of the time is unchanged.

Adding or subtracting a duration of seconds will, of course, affect the seconds portion of the time, and potentially the minutes and hours.

Time durations, whether positive or negative, also can be added to and subtracted from times. The result is a time that has been incremented or decremented by the specified number of hours, minutes, and seconds, in that order. TIME1 + X, where "X" is a DECIMAL(6,0) number, is equivalent to the expression:

```
TIME1 + HOUR(X) HOURS + MINUTE(X) MINUTES + SECOND(X) SECONDS
```

Timestamp arithmetic

Timestamps can be subtracted, incremented, or decremented.

Subtracting timestamps

The result of subtracting one timestamp (TS2) from another (TS1) is a timestamp duration that specifies the number of years, months, days, hours, minutes, seconds, and fractional seconds between the two timestamps. The data type of the result is DECIMAL(14+s,s), where s is the maximum timestamp precision of TS1 and TS2. If TS1 is greater than or equal to TS2, TS2 is subtracted from TS1. If TS1 is less than TS2, however, TS1 is subtracted from TS2 and the sign of the result is made negative. The following procedural description clarifies the steps involved in the operation $RESULT = TS1 - TS2$.

If $SECOND(TS2,s) \leq SECOND(TS1,s)$
then $SECOND(RESULT,s) = SECOND(TS1,s) - SECOND(TS2,s)$.

If $SECOND(TS2,s) > SECOND(TS1,s)$
then $SECOND(RESULT,s) = 60 + SECOND(TS1,s) - SECOND(TS2,s)$
and $MINUTE(TS2)$ is incremented by 1.

The minutes part of the timestamps are subtracted as specified in the rules for subtracting times.

If $HOUR(TS2) \leq HOUR(TS1)$
then $HOUR(RESULT) = HOUR(TS1) - HOUR(TS2)$.

If $HOUR(TS2) > HOUR(TS1)$
then $HOUR(RESULT) = 24 + HOUR(TS1) - HOUR(TS2)$
and $DAY(TS2)$ is incremented by 1.

The date part of the timestamps is subtracted as specified in the rules for subtracting dates.

The result of subtracting a date (D1) from a timestamp (TS1) is the same as subtracting $TIMESTAMP(D1)$ from TS1. Similarly, the result of subtracting one timestamp (TS1) from a date (D2) is the same as subtracting TS1 from $TIMESTAMP(D2)$.

Incrementing and decrementing timestamps

The result of adding a duration to a timestamp, or of subtracting a duration from a timestamp, is itself a timestamp. The precision of the result timestamp matches the precision of the timestamp operand. Date and time arithmetic is performed as previously defined, except that an overflow or underflow of hours is carried into the date part of the result, which must be within the range of valid dates. Fractional seconds overflow into seconds. Thus, subtracting a duration, X, from a timestamp, $TIMESTAMP1$, where X is a DECIMAL(14+s,s) number is equivalent to the expression:

```
TIMESTAMP1 - YEAR(X) YEARS - MONTH(X) MONTHS - DAY(X) DAYS  
            - HOUR(X) HOURS - MINUTE(X) MINUTES  
            - SECOND(X,s) SECONDS
```

When subtracting a duration with non-zero scale, a labeled duration of MICROSECOND or MICROSECONDS, or a labeled duration of SECOND or SECONDS with a value that includes fractions of a second, the subtraction is performed as if the timestamp value has up to 12 fractional second digits. The resulting value is assigned to a timestamp value with the timestamp precision of the timestamp operand which could result in truncation of fractional second digits.

Precedence of operations

Expressions within parentheses are evaluated first. When the order of evaluation is not specified by parentheses, exponentiation is applied after prefix operators (such as -, unary minus) and before multiplication and division. Multiplication and division are applied before addition and subtraction. Operators at the same precedence level are applied from left to right.

The following table shows the priority of all operators.

Priority	Operators
1	+, - (when used for signed numeric values)
2	**
3	*, /, CONCAT,
4	+, - (when used between two operands)

Example 1:

In this example, the first operation is the addition in (SALARY + BONUS) because it is within parenthesis. The second operation is multiplication because it is at a higher precedence level than the second addition operator and it is to the left of the division operator. The third operation is division because it is at a higher precedence level than the second addition operator. Finally, the remaining addition is performed.

```
1.10 * (SALARY + BONUS) + SALARY / :VAR3
```

↑ ↑ ↑ ↑
2 1 4 3

Example 2:

In this example, the first operation (CONCAT) combines the character strings in the variables YYYYMM and DD into a string representing a date. The second operation (-) then subtracts that date from the date being processed in DATECOL. The result is a date duration that indicates the time elapsed between the two dates.

```
DATECOL - :YYYYMM CONCAT :DD
```

↑ ↑
2 1

ARRAY constructor

The ARRAY constructor returns an array specified by a list of expressions or a fullselect.

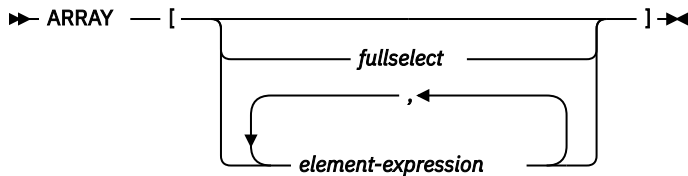

fullselect

A fullselect that returns a single column. The values returned by the fullselect are the elements of the array. The cardinality of the array is equal to the number of rows returned by the fullselect. An ORDER BY clause in the fullselect can be used to specify the order among the elements of the array; otherwise, the order is undefined. The attributes of the base type of the array are the same as the data type of the result column of the fullselect.

element-expression

An expression defining the value of an element within the array. The cardinality of the array is equal to the number of element expressions. The first *element-expression* is assigned to the array element with array index 1. The second *element-expression* is assigned to the array element with array index 2, and so on. All element expressions must have compatible data types. The attributes of the base type of the array are determined by all the operands as explained in [“Rules for result data types” on page 107](#).

If there is no expression within the brackets, the result is an empty array. The cardinality of an empty array is 0.

An ARRAY constructor can only be specified on the right side of a SET variable or *assignment-statement*.

Examples

- Set the array variable RECENT_CALLS of array type PHONENUMBERS to an array of fixed numbers.

```
SET RECENT_CALLS = ARRAY[9055553907, 4165554213, 4085553678]
```

- Set the array variable DEPT_PHONES of array type PHONENUMBERS to an array of phone numbers retrieved from the DEPARTMENT_INFO table.

```
SET DEPT_PHONES = ARRAY[SELECT DECIMAL(AREA_CODE CONCAT '555' CONCAT EXTENSION,16)
FROM DEPARTMENT_INFO
WHERE DEPTID = 624]
```

ARRAY element specification

The ARRAY element specification returns the element from an array specified by *expression*.

► *array-variable* [*expression*] ►
CAST (*parameter-marker* AS *array-type*)

array-variable

Specifies a variable or parameter of type array in an SQL procedure or SQL function.

CAST(*parameter-marker* AS *array-type*)

Specifies the array data type to be used for the parameter marker. The array data type passed for the parameter marker value must match this array data type exactly.

[*expression*]

Specifies the array index of the element that is to be extracted from the array. The array index must return a value that is an exact numeric with zero scale or DECFLOAT. Its value must be between 1 and the cardinality of the array.

The data type of the result is the data type specified for the array on the CREATE TYPE (Array) statement.

If *expression* is null or the array is null, the null value is returned.

CASE expression

CASE expressions allow an expression to be selected based on the evaluation of one or more conditions.

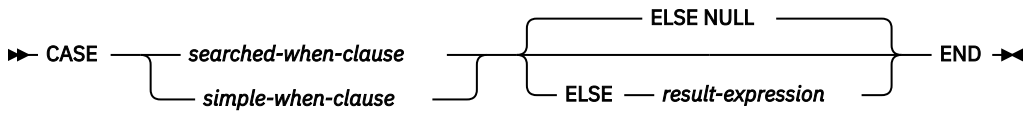

searched-when-clause

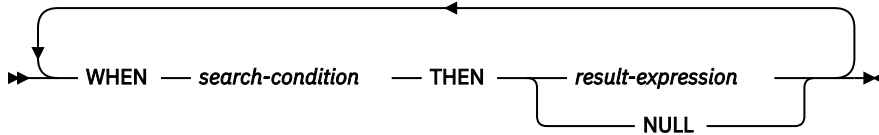

simple-when-clause

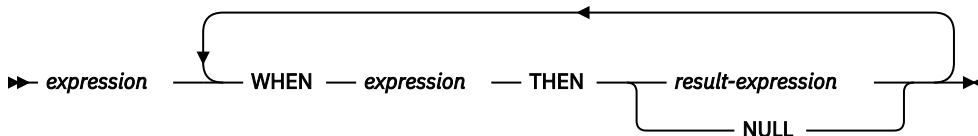

In general, the value of the *case-expression* is the value of the *result-expression* following the first (leftmost) *when-clause* that evaluates to true. If no *when-clause* evaluates to true and the ELSE keyword is present then the result is the value of the ELSE *result-expression* or NULL. If no *when-clause* evaluates to true and the ELSE keyword is not present then the result is NULL. Note that when a *when-clause* evaluates to unknown (because of nulls), the *when-clause* is not true and hence is treated the same way as a *when-clause* that evaluates to false.

searched-when-clause

Specifies a *search-condition* that is applied to each row or group of table data presented for evaluation, and the result when that condition is true.

simple-when-clause

Specifies that the value of the *expression* prior to the first WHEN keyword is tested for equality with the value of the *expression* that follows each WHEN keyword. It also specifies the result when that condition is true.

The data type of the *expression* prior to the first WHEN keyword must be compatible with the data types of the *expression* that follows each WHEN keyword.

result-expression or NULL

Specifies the value that follows the THEN keyword and ELSE keywords. There must be at least one *result-expression* in the CASE expression with a defined data type. NULL cannot be specified for every case.

All *result-expressions* must have compatible data types, where the attributes of the result are determined based on the [“Rules for result data types”](#) on page 107.

search-condition

Specifies a condition that is true, false, or unknown about a row or group of table data.

The *search-condition* must not include a subquery in an EXISTS or IN predicate.

If a CASE expression is used in a select list, the SET clause of an UPDATE or MERGE statement, or the VALUES clause of an INSERT or MERGE statement, and if *simple-when-clause* or *searched-when-clause* references a column for which column access control is activated, the masked value will be used instead of the column value.

There are two scalar functions, NULLIF and COALESCE, that are specialized to handle a subset of the functionality provided by CASE. The following table shows the equivalent expressions using CASE or these functions.

Table 30. Equivalent CASE Expressions

CASE Expression	Equivalent Expression
CASE WHEN e1=e2 THEN NULL ELSE e1 END	NULLIF(e1,e2)
CASE WHEN e1 IS NOT NULL THEN e1 ELSE e2 END	COALESCE(e1,e2)
CASE WHEN e1 IS NOT NULL THEN e1 ELSE COALESCE(e2,...,eN) END	COALESCE(e1,e2,...,eN)

Examples

- If the first character of a department number is a division in the organization, then a CASE expression can be used to list the full name of the division to which each employee belongs:

```
SELECT EMPNO, LASTNAME,
       CASE SUBSTR(WORKDEPT,1,1)
       WHEN 'A' THEN 'Administration'
       WHEN 'B' THEN 'Human Resources'
       WHEN 'C' THEN 'Accounting'
       WHEN 'D' THEN 'Design'
       WHEN 'E' THEN 'Operations'
       END
FROM EMPLOYEE
```

- The number of years of education are used in the EMPLOYEE table to give the education level. A CASE expression can be used to group these and to show the level of education.

```
SELECT EMPNO, FIRSTNAME, MIDINIT, LASTNAME,
       CASE
       WHEN EDLEVEL < 15 THEN 'SECONDARY'
       WHEN EDLEVEL < 19 THEN 'COLLEGE'
       ELSE 'POST GRADUATE'
       END
FROM EMPLOYEE
```

- Another interesting example of CASE statement usage is in protecting from division by 0 errors. For example, the following code finds the employees who earn more than 25% of their income from commission, but who are not fully paid on commission:

```
SELECT EMPNO, WORKDEPT, SALARY+COMM
FROM EMPLOYEE
WHERE (CASE WHEN SALARY=0 THEN NULL
        ELSE COMM/SALARY
        END) > 0.25
```

- The following CASE expressions are equivalent:

```
SELECT LASTNAME,
       CASE
       WHEN LASTNAME = 'Haas' THEN 'President'
       ...
       ELSE 'Unknown'
       END
FROM EMPLOYEE

SELECT LASTNAME,
       CASE LASTNAME
       WHEN 'Haas' THEN 'President'
       ...
       ELSE 'Unknown'
       END
FROM EMPLOYEE
```

CAST specification

The CAST specification returns the cast operand (the first operand) cast to the type specified by the *data-type*.

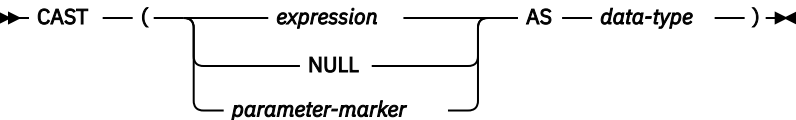

data-type

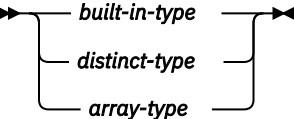

built-in-type

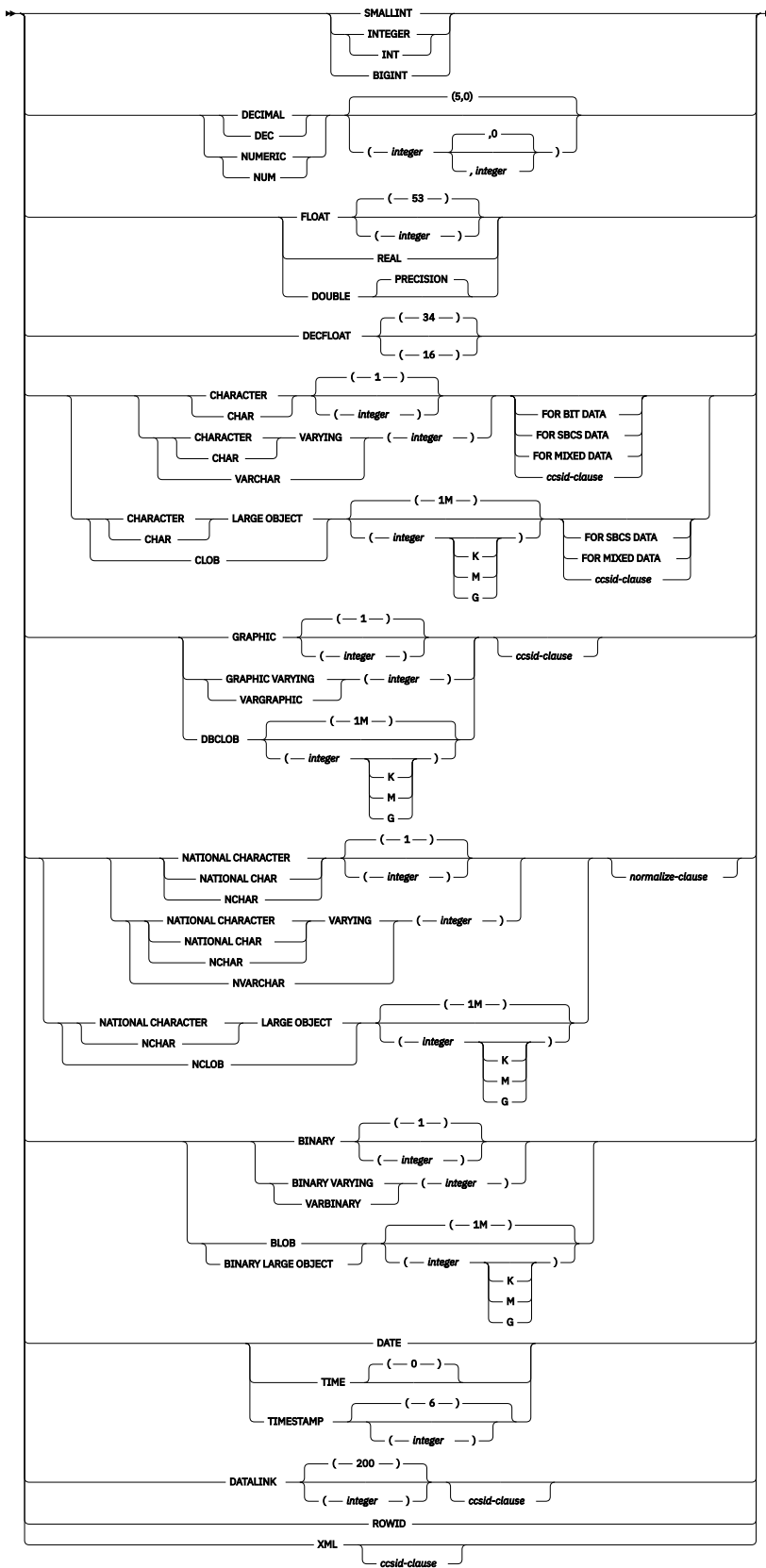

ccsid-clause

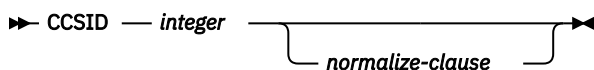

normalize-clause



The CAST specification returns the cast operand (the first operand) cast to the type specified by the *data-type*. If the data type of either operand is a distinct type, the privileges held by the authorization ID of the statement must include the USAGE privilege on the distinct type.

expression

Specifies that the cast operand is an expression other than NULL or a parameter marker. The result is the argument value converted to the specified target data type.

The supported casts are shown in [“Casting between data types”](#) on page 87, where the first column represents the data type of the cast operand (source data type) and the data types across the top represent the target data type of the CAST specification. If the cast is not supported, an error is returned.

When casting character or graphic strings to a character or graphic string with a different length, a warning is returned if truncation of other than trailing blanks occurs.

NULL

Specifies that the cast operand is the null value. The result is a null value that has the specified *data-type*.

parameter-marker

A parameter marker (specified as a question mark character) is normally considered an expression, but is documented separately in this case because it has a special meaning. If the cast operand is a *parameter-marker*, the specified *data-type* is considered a promise that the replacement will be assignable to the specified *data-type* (using storage assignment rules, see [“Assignments and comparisons”](#) on page 91). Such a parameter marker is called a *typed parameter marker*. Typed parameter markers will be treated like any other typed value for the purpose of DESCRIBE of a select list or for column assignment.

data-type

Specifies the data type of the result. If the data type is not qualified, the SQL path is used to find the appropriate data type. For more information, see [“Unqualified function, procedure, specific name, type, and variables”](#) on page 59. For a description of *data-type*, see [“CREATE TABLE”](#) on page 1105. (For portability across operating systems, when specifying a floating-point data type, use REAL or DOUBLE instead of FLOAT.)

Restrictions on the supported data types are based on the specified cast operand.

- For a cast operand that is an *expression*, see [Table 16](#) on page 89 for the target data types that are supported based on the data type of the cast operand.
- For a cast operand that is the keyword NULL, the target data type can be any data type.
- For a cast operand that is a parameter marker, the target data type can be any data type. If the data type is a distinct type, the application that uses the parameter marker will use the source data type of the distinct type. If the data type is an array type, the parameter marker must represent an array with a cardinality less than or equal to the maximum cardinality of the target array data type. The data type of the parameter marker must match the data type of the target array data type exactly.

If the CCSID attribute is not specified, then:

- If the *data-type* is BINARY, VARBINARY, or BLOB, a CCSID of 65535 is used.
- If FOR BIT DATA is specified, a CCSID of 65535 is used.
- If the *expression* is a character string, and the *data-type* is CHAR, VARCHAR, or CLOB:
 - If FOR SBCS DATA is specified,
 - If the CCSID of the *expression* is a Unicode CCSID, then the single-byte CCSID associated with the default CCSID of the job is used.

- Otherwise, the single-byte CCSID associated with the CCSID of the *expression* is used.⁴⁵
- If FOR MIXED DATA is specified,
 - If the CCSID of the *expression* is a Unicode CCSID, then the mixed-byte CCSID associated with the default CCSID of the job is used.
 - Otherwise, the mixed-byte CCSID associated with the CCSID of the *expression* is used.⁴⁵
- Otherwise,
 - If *expression* is SBCS data, the CCSID of the *expression* is used.⁴⁶⁴⁵
 - If *expression* is mixed data and the length attribute of the result is greater than or equal to 4, then the CCSID of the *expression* is used.
 - If *expression* is mixed data that is DBCS-open or DBCS-either and the length attribute of the result is less than 4, the CCSID of the result is the associated SBCS CCSID for the mixed data CCSID.
- If the *expression* is a graphic string or *expression* is a parameter marker, and the *data-type* is CHAR, VARCHAR, or CLOB:
 - If FOR SBCS DATA is specified, the single-byte CCSID associated with the default CCSID of the job is used.
 - If FOR MIXED DATA is specified, the mixed-byte CCSID associated with default CCSID of the job is used.
 - Otherwise,
 - If the default CCSID of the job is SBCS data, the default CCSID of the job is used.
 - If the default CCSID of the job is mixed data and the length attribute of the result is greater than or equal to 4, then the default CCSID of the job is used.
 - If the default CCSID of the job is mixed data that is DBCS-open or DBCS-either and the length attribute of the result is less than 4, the CCSID of the result is the associated SBCS CCSID for the mixed data CCSID.
- If the *expression* is a character string or parameter marker, and the *data-type* is GRAPHIC, VARGRAPHIC, DBCLOB, DATE, TIME, or TIMESTAMP; the CCSID 1200 is used.
- If the *expression* is a graphic string, and the *data-type* is GRAPHIC, VARGRAPHIC, or DBCLOB; the CCSID of the *expression* is used.
- If the *data-type* is XML, the CCSID value as specified by the SQL_XML_DATA_CCSID QAQQINI setting is used. See [“XML Values” on page 80](#) for more information.
- Otherwise, the default CCSID of the job is used.

If the CCSID attribute is specified, the data will be converted to that CCSID. If NORMALIZED is specified, the data will be normalized. If FOR MIXED DATA or a mixed CCSID is specified, the result length cannot be less than 4.

For information about which casts between data types are supported and the rules for casting to a data type see [“Casting between data types” on page 87](#).

Examples

- An application is only interested in the integer portion of the SALARY column (defined as DECIMAL(9,2)) from the EMPLOYEE table. The following CAST specification will convert the SALARY column to INTEGER.

```
SELECT EMPNO, CAST(SALARY AS INTEGER)
FROM EMPLOYEE
```

⁴⁵ For XSLTRANSFORM, if the CCSID of the *expression* is 65535, the default CCSID of the job is used.

⁴⁶ If the CCSID of the *expression* is 65535, casting to CLOB is not allowed.

- Assume that two strongly typed distinct types exist. T_AGE was sourced on SMALLINT and is the data type for the AGE column in the PERSONNEL table. R_YEAR was sourced on INTEGER and is the data type for the RETIRE_YEAR column in the same table. The following UPDATE statement could be prepared.

```
UPDATE PERSONNEL SET RETIRE_YEAR = ?  
WHERE AGE = CAST( ? AS T_AGE )
```

The first parameter is an untyped parameter marker that would have a data type of R_YEAR. An explicit CAST specification is not required in this case because the parameter marker value is assigned to the distinct type.

The second parameter marker is a typed parameter marker that is cast to distinct type T_AGE. An explicit CAST specification is required in this case because the parameter marker value is compared to the distinct type.

OLAP specifications

On-Line Analytical Processing (OLAP) specifications provide the ability to return ranking, row numbering, and other aggregate function information as a scalar value in a query result.

OLAP-specification

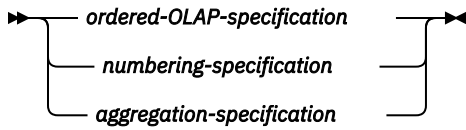

ordered-OLAP-specification

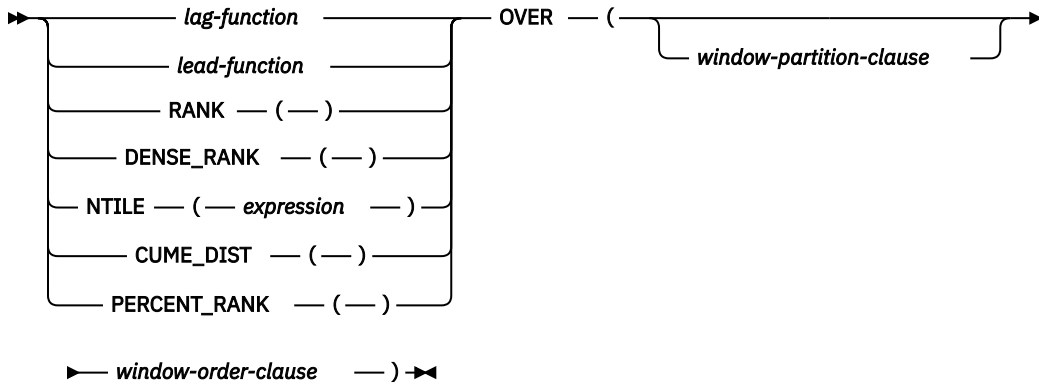

lag-function

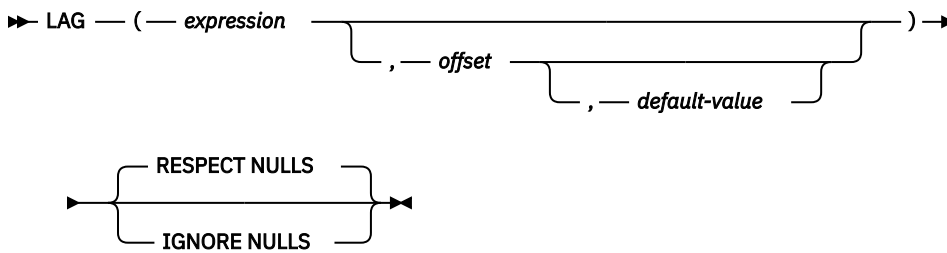

lead-function

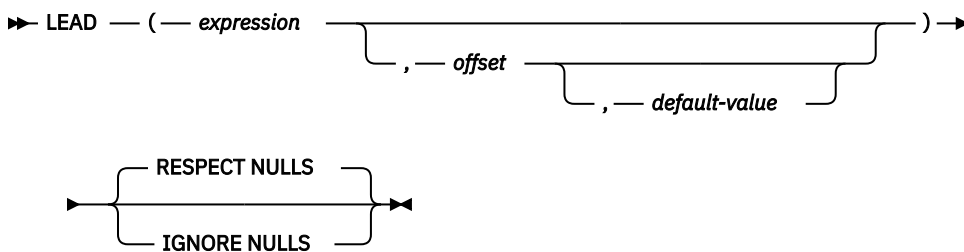

window-partition-clause

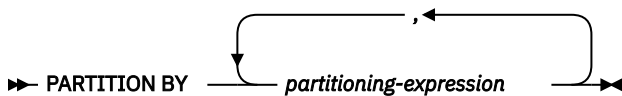

window-order-clause

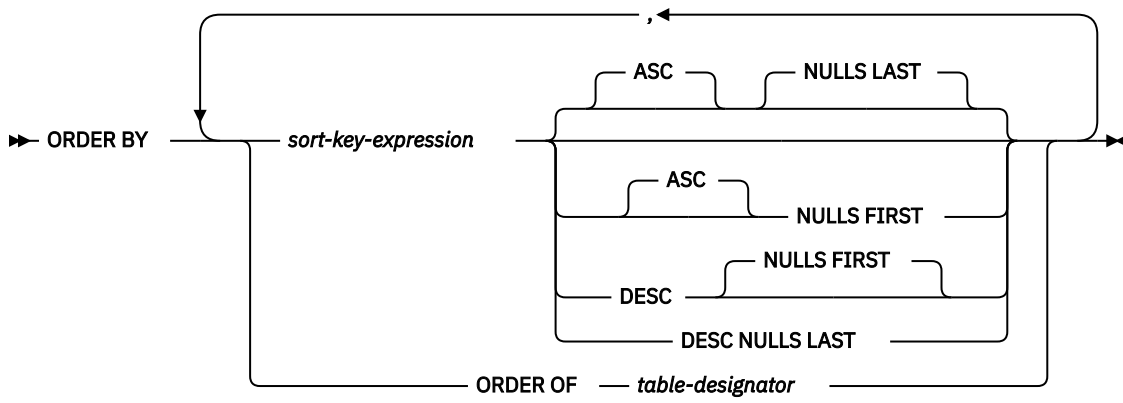

numbering-specification

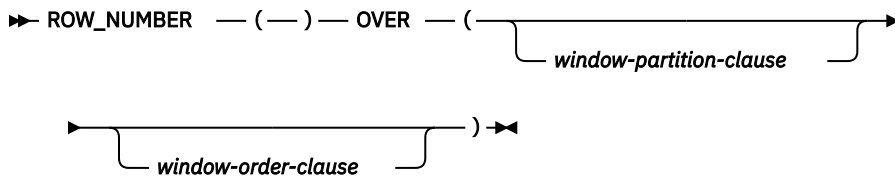

aggregation-specification

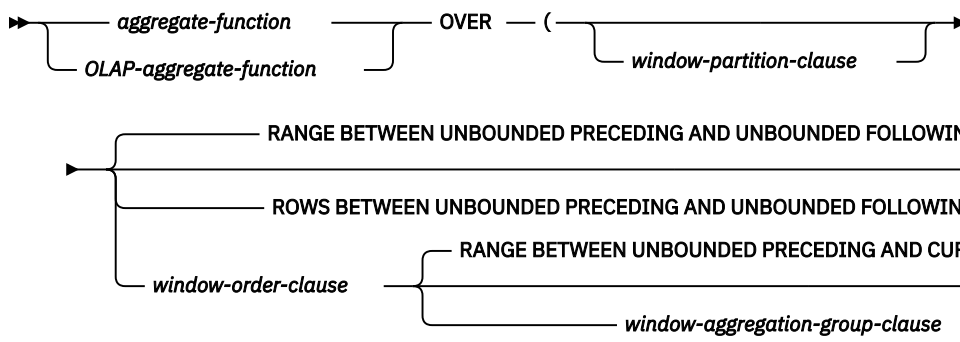

aggregate-function

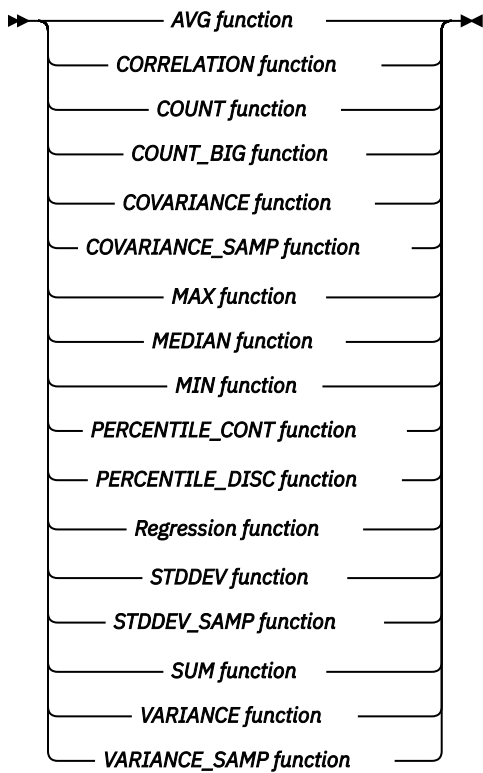

OLAP-aggregate-function

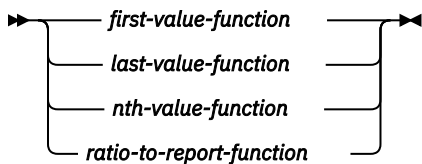

first-value-function



last-value-function

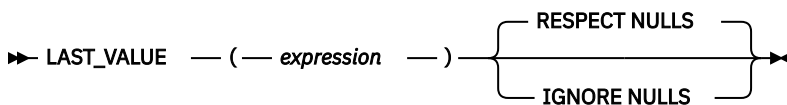

nth-value-function

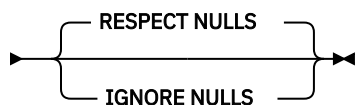
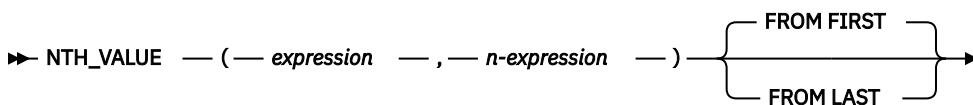

ratio-to-report-function

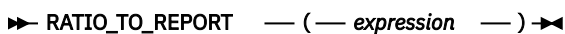

window-aggregation-group-clause

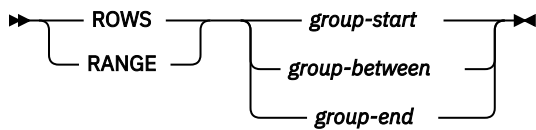

group-start

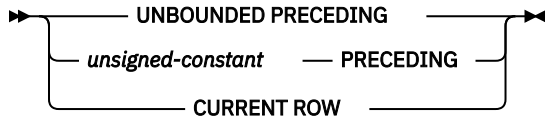

group-between



group-bound1

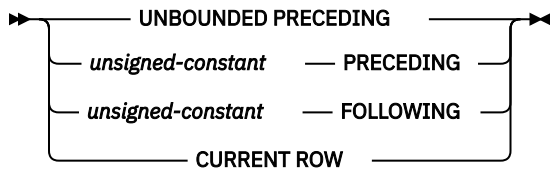

group-bound2

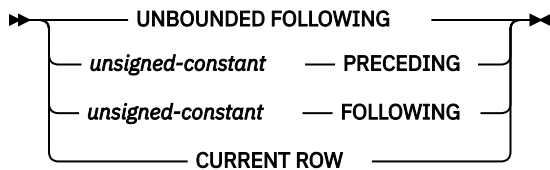

group-end



An OLAP specification can be included in an expression in a *select-clause* or the ORDER BY clause of a *select-statement*. The query result to which the OLAP specification is applied is the result table of the innermost subselect that includes the OLAP specification. OLAP specifications are sometimes referred to as *window functions*.

An OLAP specification is not valid in a WHERE, VALUES, GROUP BY, HAVING, or SET clause, or *join-condition* in an ON clause of a joined table. An OLAP specification cannot be used as an argument of an aggregate function in the *select-clause*.

When invoking an OLAP specification, a window is specified that defines the rows over which the function is applied, and in what order.

ordered-OLAP-specification

Specifies OLAP operations that require a *window-order-clause*.

LAG or LEAD

Returns an *expression* value computed using rows prior to or following the current row.

offset must be a positive integer or positive bigint constant. If *offset* is not specified, the value 1 is used.

default-value must be an expression that is castable to the type of *expression*. If *default-value* is not specified, the default value is the null value.

If IGNORE NULLS is specified, all rows where the *expression* value is the null value are not considered in the calculation.

LAG

The LAG function returns the *expression* value for the row at *offset* rows before the current row. If a *window-partition-clause* is specified, *offset* means *offset* rows before the current row and within the current partition.

LEAD

The LEAD function returns the *expression* value for the row at *offset* rows after the current row. If a *window-partition-clause* is specified, *offset* means *offset* rows after the current row and within the current partition.

If *offset* goes beyond the scope of the current partition, the *default-value* is returned.

The data type of the result is the data type of *expression*. The result can be null. If IGNORE NULLS is specified and all values in the window are null, the result is the null value.

RANK or DENSE_RANK

Specifies that the ordinal rank of a row within the window is computed. Rows that are not distinct with respect to the ordering within their window are assigned the same rank. The results of ranking may be defined with or without gaps in the numbers resulting from duplicate values.

The data type of the result is BIGINT. The result cannot be null.

RANK

Specifies that the rank of a row is defined as 1 plus the number of rows that strictly precede the row. Thus, if two or more rows are not distinct with respect to the ordering, then there will be one or more gaps in the sequential rank numbering.

DENSE_RANK

Specifies that the rank of a row is defined as 1 plus the number of preceding rows that are distinct with respect to the ordering. Therefore, there will be no gaps in the sequential rank numbering.

NTILE

Specifies that the quantile rank of a row within the window is computed.

The argument must be castable to a BIGINT. If *expression* does not return a SMALLINT, INTEGER, or BIGINT, it is cast to BIGINT before evaluating the function. It must have a value greater than zero. *expression* must not contain a *scalar-fullselect*, a column reference, or a user-defined function reference.

The result is the quantile rank of the current row. The argument determines the number of quantiles in the result, which is determined by dividing the number of rows in the window by the value of the argument. If the number of rows within the window is not evenly divisible by the argument, each quantile will have a least *n* rows, and quantiles 1 through *m* will each have *n+1* rows.

- *r* is the number of rows in the window
- *q* is the value of the argument
- $m = \text{MOD}(r, q)$
- $n = \text{TRUNC}(r, q)$

The data type of the result is SMALLINT, INTEGER, or BIGINT based on the value of the argument. If the argument can be null, the result can be null. If the argument is null, the result is the null value.

CUME_DIST

A cumulative distribution function that determines a percentile ranking for each row, expressed as a decimal fraction ranging from 0 to 1. Given the default ascending order of rows, CUME_DIST computes the number of rows that are ranked lower than or equal to the current row, including the current row, divided by the total number of rows in the partition. If the *window_order_clause* specifies descending order, CUME_DIST computes the number of rows that are ranked higher than or equal to the current row divided by the total number of rows in the partition.

For example, given default ordering, if there are ten rows in the partition and the current row ranks lower than six of those rows, the CUME_DIST result is 0.7 (six rows plus the current row = 7/10). The lowest-ranking row in a partition has a CUME_DIST value of 1.0, assuming default ascending order. If there is a single row in the partition, its CUME_DIST value is also 1.0.

The data type of the result is DECFLOAT(34). The result cannot be null.

PERCENT_RANK

The PERCENT_RANK function is a distribution function that returns a relative percentile rank of a row within an OLAP window, expressed as a value between 0.0 - 1.0. When the number of rows in the OLAP window is greater than 1, the result is computed as follows:

- The RANK of the current row in the OLAP window minus 1 divided by the number of rows in the OLAP window minus 1.

Otherwise, the result is 0.0.

The data type of the result is DECFLOAT(34). The result cannot be null.

numbering-specification

Specifies an OLAP operation that returns sequential numbers for each row.

ROW_NUMBER

Specifies that a sequential row number is computed for the row within the window defined by the ordering, starting with 1 for the first row. If the ORDER BY clause is not specified in the window, the row numbers are assigned to the rows in arbitrary order, as returned by the subselect (not according to any ORDER BY clause in the *select-statement*).

The data type of the result is BIGINT. The result cannot be null.

window-partition-clause

Defines the partition within which the OLAP operation is applied.

PARTITION BY (*partitioning-expression*,...)

Defines the partition within which the OLAP operation is applied. A *partitioning-expression* is an expression used in defining the partitioning of the result set. Each column name referenced in a *partitioning-expression* must unambiguously reference a column of the result table of the subselect that contains the OLAP specification. A *partitioning-expression* cannot include a *scalar-fullselect* or any function that is not deterministic or has an external action.

window-order-clause

Defines the ordering of rows within a partition that is used to determine the value of the OLAP specification. It does not define the ordering of the result table.

ORDER BY (*sort-key-expression*,...)

A *sort-key-expression* is an expression used in defining the ordering of the rows within a window partition. Each column name referenced in a *sort-key-expression* must unambiguously reference a column of the result table of the subselect, including the OLAP specification. A *sort-key-expression* cannot include a *scalar-fullselect* or any function that is not deterministic or that has an external action.

The sum of the length attributes of the *sort-key-expressions* must not exceed 3.5 gigabytes.

ASC

Specifies that the values of the *sort-key-expression* are used in ascending order.

DESC

Specifies that the values of the *sort-key-expression* are used in descending order.

NULLS FIRST

Specifies that the window ordering considers null values before all non-null values in the sort order.

NULLS LAST

Specifies that the window ordering considers null values after all non-null values in the sort order.

ORDER OF *table-designator*

Specifies that the same ordering used in *table-designator* should be applied to the result table of the subselect. There must be a table reference matching *table-designator* in the FROM clause of the subselect that specifies this clause and the table reference must identify a *nested-table-expression* or *common-table-expression*. The subselect (or fullselect) corresponding to the specified *table-designator* must include an ORDER BY clause that is dependent on the data. The ordering that is applied is the same as if the columns of the ORDER BY clause in the nested subselect (or fullselect) were included in the outer subselect (or fullselect), and these columns were specified in place of the ORDER OF clause.

OLAP-aggregate-function

Specifies a function that will compute a single value from the OLAP window.

FIRST_VALUE or LAST_VALUE

Returns the first or last value in an OLAP window.

If IGNORE NULLS is specified, all rows where the *expression* value is the null value are not considered in the calculation.

FIRST_VALUE

The result is the *expression* value for the first row in an OLAP window.

LAST_VALUE

The result is the *expression* value for the last row in an OLAP window.

The data type of the result is the data type of *expression*. The result can be null. If IGNORE NULLS is specified and all values in the window are null, the result is the null value.

NTH_VALUE

Returns the *expression* value for the *n*th row in an OLAP window.

n-expression must be an integer constant or variable with a value greater than zero.

If IGNORE NULLS is specified, all rows where the *expression* value is the null value are not considered in the calculation.

If FROM FIRST is specified, the *n*th value is computed counting forward from the beginning of the OLAP window.

If FROM LAST is specified, the *n*th value is computed counting backward from the end of the OLAP window.

The result is the *n*th value within the OLAP window as determined by *n-expression*.

The data type of the result is the data type of *expression*. The result can be null. If *n-expression* is null, then the result is the null value. If IGNORE NULLS is specified and all values in the window are null, the result is the null value.

FIRST_VALUE(*expression*) is equivalent to NTH_VALUE(*expression*, 1) FROM FIRST.

LAST_VALUE(*expression*) is equivalent to NTH_VALUE(*expression*, 1) FROM LAST.

RATIO_TO_REPORT

Returns the ratio of an argument to the sum of the arguments in an OLAP window. For example, the following functions are equivalent:

```
RATIO_TO_REPORT(expression) OVER (...)
CAST(expression AS DECFLOAT(34)) /
SUM(CAST(expression as DECFLOAT(34))) OVER(...)
```

The argument must be an expression that is castable to DECFLOAT(34). The division is performed using DECFLOAT(34).

The data type of the result is DECFLOAT(34). If the argument can be null, the result can be null; if the argument is null, the result is the null value.

window-aggregation-group-clause

The aggregation group of a given row is a set of rows that is defined in relation to the given row (in the ordering of the rows in the partition of the given row). *window-aggregation-group-clause* specifies the aggregation group. If this clause is not specified and a *window-order-clause* is also not specified, the aggregation group consists of all rows of the window partition. The aggregation group of all rows of the window partition can be explicitly specified using the RANGE or ROWS clauses.

If *window-order-clause* is specified but *window-aggregation-group-clause* is not specified, the window aggregation group consists of all rows that precede a given row of the partition of the given row or all rows that are peers of the given row in the window ordering of the window partition that is defined by the *window-order-clause*

ROW

Specifies that the aggregation group is defined by counting rows.

RANGE

Specifies that the aggregation group is defined by an offset from a sort key.

group-start

Specifies the starting point for the aggregation group. The aggregation group end is the CURRENT ROW. Specifying *group-start* is equivalent to specifying *group-between* as BETWEEN *group-start* AND CURRENT ROW.

group-between

Specifies that the aggregation group start and end based on either ROWS or RANGE.

group-end

Specifies the ending point for the aggregation group. The aggregation group start is the CURRENT ROW. Specifying *group-end* is equivalent to specifying *group-between* as BETWEEN CURRENT ROW AND *group-end*.

UNBOUNDED PRECEDING

Specifies that the entire partition that precedes the current row is included in the aggregation group. This can be specified with either the ROWS or RANGE clauses. Including the entire partition that precedes the current row can also be specified with multiple *sort-key-expressions* in the *window-order-clause*.

UNBOUNDED FOLLOWING

Specifies that the entire partition that follows the current row is included in the aggregation group. This can be specified with either the ROWS or RANGE clauses. Including the entire partition that follows the current row can also be specified with multiple *sort-key-expressions* in the *window-order-clause*.

CURRENT ROW

Specifies that the aggregation group starts or ends based on the current row. If ROWS is specified, the current row is the aggregation group boundary. If RANGE is specified, the aggregation group boundary includes the set of rows with the values specified for the *sort-key-expression* as the current row. This clause cannot be specified in *group-bound-2* if *group-bound-1* specifies *unsigned-constant* FOLLOWING.

***unsigned-constant* PRECEDING**

Specifies either the range or the number of rows that precede the current row. If ROWS is specified, *unsigned-constant* must be zero or a positive integer or positive bigint that indicates a number of rows. If RANGE is specified, the data type of *unsigned-constant* must be comparable to the data type of the *sort-key-expression* of the *window-order-clause*. Only one *sort-key-expression* is allowed, and the data type of *sort-key-expression* must allow subtraction. This clause cannot be specified in *group-bound-2* if *group-bound-1* is CURRENT ROW or *unsigned-constant* FOLLOWING.

***unsigned-constant* FOLLOWING**

Specifies either the range or the number of rows that follow the current row. If ROWS is specified, *unsigned-constant* must be zero or a positive integer or positive bigint that indicates a number of rows. If RANGE is specified, the data type of *unsigned-constant* must be comparable to the data type of the *sort-key-expression* of the *window-order-clause*. Only one *sort-key-expression* is allowed, and the data type of *sort-key-expression* must allow addition.

Notes

Comparisons: Partitioning and ordering are performed in accordance with the comparison rules described in [“Assignments and comparisons”](#) on page 91.

Collating sequence: If a collating sequence other than *HEX is in effect when the statement that contains the OLAP expression is executed, and the *partitioning-expressions* or the *sort-key-expressions* are SBCS data, mixed data, or Unicode data, then the results are determined using the weighted values. The weighted values are derived by applying the collating sequence to the *partitioning-expressions* and the *sort-key-expressions*.

Column masks: If a column that is referenced in the *partitioning-expression* or the *sort-key-expression* of the OLAP specification is defined to have a column mask, the column mask is not applied.

Restrictions: An OLAP specification is not allowed if the query specifies:

- a distributed table,
- a table with a read trigger, or
- a logical file built over multiple physical file members.

Determinism: An OLAP specification is non-deterministic.

Syntax alternatives:

- DENSERANK can be specified in place of DENSE_RANK.
- ROWNUMBER can be specified in place of ROW_NUMBER.
- IGNORE NULLS or RESPECT NULLS can be specified as a *string-constant* final argument to LAG, LEAD, FIRST_VALUE, and LAST_VALUE.

Examples

- Display the ranking of employees, in order by surname, according to their total salary (based on salary plus bonus) that have a total salary more than \$30,000:

```
SELECT EMPNO, LASTNAME, FIRSTNME, SALARY+BONUS AS TOTAL_SALARY,  
       RANK() OVER (ORDER BY SALARY+BONUS DESC) AS RANK_SALARY  
FROM EMPLOYEE  
WHERE SALARY+BONUS > 30000  
ORDER BY LASTNAME
```

Note that if the result is to be ordered by the ranking, then replace ORDER BY LASTNAME with:

```
ORDER BY RANK_SALARY
```

or:

```
ORDER BY RANK() OVER (ORDER BY SALARY+BONUS DESC)
```

- Rank the departments according to their average total salary:

```
SELECT WORKDEPT, AVG(SALARY+BONUS) AS AVG_TOTAL_SALARY,  
       RANK() OVER (ORDER BY AVG( SALARY+BONUS) DESC) AS RANK_AVG_SAL  
FROM EMPLOYEE  
GROUP BY WORKDEPT  
ORDER BY RANK_AVG_SAL
```

- Rank the employees within a department according to their education level. Having multiple employees with the same rank in the department should not increase the next ranking value:

```
SELECT WORKDEPT, EMPNO, LASTNAME, FIRSTNME, EDLEVEL,  
       DENSE_RANK() OVER (PARTITION BY WORKDEPT ORDER BY EDLEVEL DESC)  
       AS RANK_EDLEVEL  
FROM EMPLOYEE  
ORDER BY WORKDEPT, LASTNAME
```

- Provide row numbers in the result of a query:

```

SELECT ROW_NUMBER() OVER (ORDER BY WORKDEPT, LASTNAME ) AS NUMBER,
       LASTNAME, SALARY
FROM EMPLOYEE
ORDER BY WORKDEPT, LASTNAME

```

- List the top five wage earners:

```

SELECT EMPNO, LASTNAME, FIRSTNAME, TOTAL_SALARY, RANK_SALARY
FROM (SELECT EMPNO, LASTNAME, FIRSTNAME, SALARY+BONUS AS TOTAL_SALARY,
            RANK() OVER (ORDER BY SALARY+BONUS DESC) AS RANK_SALARY
      FROM EMPLOYEE) AS RANKED_EMPLOYEE
WHERE RANK_SALARY < 6
ORDER BY RANK_SALARY

```

Note that a nested table expression was used to first compute the result, including the rankings, before the rank could be used in the WHERE clause. A common table expression could also have been used.

- Compute the top 3 stock prices for stock ABC using NTH_VALUE:

```

SELECT Symbol, StockDate, Price,
       FIRST_VALUE(Price) OVER (PARTITION BY Symbol ORDER BY StockDate) AS FIRST_PRICE,
       NTH_VALUE(Price, 2) OVER (PARTITION BY Symbol ORDER BY StockDate) AS SECOND_PRICE,
       NTH_VALUE(Price, 3) OVER (PARTITION BY Symbol ORDER BY StockDate) AS THIRD_PRICE
FROM DailyStockData
WHERE StockDate BETWEEN CURRENT DATE - 1 MONTH AND CURRENT DATE
      AND Symbol = 'ABC'

```

- Compute the quartile rank using NTILE:

```

SELECT proc_id, total_sales,
       NTILE(4) OVER (ORDER BY total_sales DESC) AS Quartile
FROM Sales

```

- Calculate the 30 day moving average for the stocks 'ABC' and 'XYZ' during 2005:

```

WITH V1(SYMBOL, TRADINGDATE, MOVINGAVG30DAY) AS
(
  SELECT SYMBOL, TRADINGDATE,
         AVG(CLOSINGPRICE) OVER (PARTITION BY SYMBOL
                                ORDER BY TRADINGDATE
                                ROWS BETWEEN 29 PRECEDING AND CURRENT ROW)
      FROM DAILYSTOCKDATA
      WHERE SYMBOL IN ('ABC', 'XYZ')
            AND TRADINGDATE BETWEEN DATE('2005-01-01') - 2 MONTHS AND '2005-12-31'
)
SELECT SYMBOL, TRADINGDATE, MOVINGAVG30DAY
FROM V1
WHERE TRADINGDATE BETWEEN '2005-01-01' AND '2005-12-31'
ORDER BY SYMBOL, TRADINGDATE

```

- Display the difference between each employee's salary and the median of the salaries of that employee's department:

```

SELECT EMPNO, WORKDEPT, SALARY,
       SALARY - (MEDIAN(SALARY) OVER (PARTITION BY WORKDEPT))
FROM EMPLOYEE
ORDER BY WORKDEPT

```

- Display the difference between each employee's salary and the 90th percentile of salaries within that employee's department:

```

SELECT EMPNO, WORKDEPT, SALARY,
       SALARY - (PERCENTILE_CONT(0.9) WITHIN GROUP (ORDER BY SALARY)
                OVER (PARTITION BY WORKDEPT))
FROM EMPLOYEE
ORDER BY WORKDEPT

```

- Find the cumulative distribution and the relative percentile rank of each employee's salary within their department.

```

SELECT EMPNO, WORKDEPT, SALARY,
       CAST(CUME_DIST() OVER (PARTITION BY WORKDEPT ORDER BY SALARY) AS DECIMAL(4,3))
       AS CUME_DIST,

```

```
CAST(PERCENT_RANK() OVER (PARTITION BY WORKDEPT ORDER BY SALARY)
     AS DECIMAL(4,3))
AS PERCENT_RANK
FROM EMP
ORDER BY WORKDEPT, SALARY
```

ROW CHANGE expression

A ROW CHANGE expression returns a token or a timestamp that represents the last change to a row.

►► ROW CHANGE  FOR *table-designator* ◄◄

ROW CHANGE TIMESTAMP

Specifies that a timestamp is returned that represents the last time when a row was changed. If the row has not been changed, the result is the time that the initial value was inserted. If the table does not have a row change timestamp, this expression is not allowed.

ROW CHANGE TOKEN

Specifies that a token that is a BIGINT value is returned that represents a relative point in the modification sequence of a row. If the row has not been changed, the result is a token that represents when the initial value was inserted.

FOR *table-designator*

Specifies a table designator of the subselect. For more information about table designators, see [“Table designators” on page 135](#). In SQL naming, the table name may be qualified. In system naming, the table name cannot be qualified. The table designator cannot identify a table function or a *data-change-table-reference*. If the table designator identifies a view or a nested table expression, the expression returns the ROW CHANGE TOKEN or ROW CHANGE TIMESTAMP of its base table.

The result can be the null value. These expressions are not deterministic.

Example

- Find all rows that have been changed in the last day:

```
SELECT *  
FROM ORDERS  
WHERE ROW CHANGE TIMESTAMP FOR ORDERS > CURRENT_TIMESTAMP - 24 HOURS
```

Sequence reference

A sequence is referenced by using the NEXT VALUE and PREVIOUS VALUE expressions specifying the name of the sequence.

sequence-reference

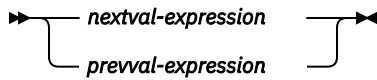

nextval-expression

➤ NEXT VALUE — FOR — *sequence-name* ➤

prevval-expression

➤ PREVIOUS VALUE — FOR — *sequence-name* ➤

A sequence is referenced by using the NEXT VALUE and PREVIOUS VALUE expressions specifying the name of the sequence.

nextval-expression

A NEXT VALUE expression generates and returns the next value for a specified sequence. A new value is generated for a sequence when a NEXT VALUE expression specifies the name of the sequence. However, if there are multiple instances of a NEXT VALUE expression specifying the same sequence name within a query, the sequence value is incremented only once for each row of the result, and all instances of NEXT VALUE return the same value for a row of the result. NEXT VALUE is a non-deterministic expression with external actions since it causes the sequence value to be incremented.

When the next value for the sequence is generated, if the maximum value for an ascending sequence or the minimum value for a descending sequence of the logical range of the sequence is exceeded and the NO CYCLE option is in effect, then an error is returned.

The data type and length attributes of the result of a NEXT VALUE expression are the same as for the specified sequence. The result cannot be null.

prevval-expression

A PREVIOUS VALUE expression returns the most recently generated value for the specified sequence for a previous statement within the current application process. This value can be repeatedly referenced by using PREVIOUS VALUE expressions and specifying the name of the sequence. There may be multiple instances of PREVIOUS VALUE expressions specifying the same sequence name within a single statement and they all return the same value.

A PREVIOUS VALUE expression can be used only if a NEXT VALUE expression specifying the same sequence name has already been referenced in the current application process.

The data type and length attributes of the result of a PREVIOUS VALUE expression are the same as for the specified sequence. The result cannot be null.

sequence-name

Identifies the sequence to be referenced. The *sequence-name* must identify a sequence that exists at the current server.

Notes

Authorization: If a sequence is referenced in a statement, the privileges held by the authorization ID of the statement must include at least one of the following:

- For the sequence identified in the statement,
 - The USAGE privilege on the sequence, and
 - The USAGE privilege on the schema containing the sequence
- Database administrator authority

For information about the system authorities corresponding to SQL privileges, see [Corresponding System Authorities When Checking Privileges to a Sequence](#).

Generating values with NEXT VALUE: When a value is generated for a sequence, that value is consumed, and the next time that a value is requested, a new value will be generated. This is true even when the statement containing the NEXT VALUE expression fails or is rolled back.

Scope of PREVIOUS VALUE: The PREVIOUS VALUE value persists until the next value is generated for the sequence in the current session, the sequence is dropped or altered, or the application session ends. The value is unaffected by COMMIT or ROLLBACK statements. The value of PREVIOUS VALUE cannot be directly set and is a result of executing the NEXT VALUE expression for the sequence.

A technique commonly used, especially for performance, is for an application or product to manage a set of connections and route transactions to an arbitrary connection. In these situations, the availability of the PREVIOUS VALUE for a sequence should only be relied on until the end of the transaction.

Use as a Unique Key Value: The same sequence number can be used as a unique key value in two separate tables by referencing the sequence number with a NEXT VALUE expression for the first row (this generates the sequence value), and a PREVIOUS VALUE expression for the other rows (the instance of PREVIOUS VALUE refers to the sequence value most recently generated in the current session), as shown below:

```
INSERT INTO ORDER (ORDERNO, CUSTNO)
VALUES (NEXT VALUE FOR ORDER_SEQ, 123456)

INSERT INTO LINE_ITEM (ORDERNO, PARTNO, QUANTITY)
VALUES (PREVIOUS VALUE FOR ORDER_SEQ, 987654, 1)
```

Allowed use of NEXT VALUE and PREVIOUS VALUE: NEXT VALUE and PREVIOUS VALUE expressions can be specified in the following places:

- Within the *select-clause* of a SELECT statement or SELECT INTO statement as long as the statement does not contain a DISTINCT keyword, a GROUP BY clause, an ORDER BY clause, a UNION keyword, an INTERSECT keyword, or EXCEPT keyword
- Within a VALUES clause of a *fullselect* (NEXT VALUE is not allowed)
- Within a VALUES clause of an INSERT statement
- Within the *select-clause* of the fullselect of an INSERT statement
- Within the SET clause of a searched or positioned UPDATE statement, though NEXT VALUE cannot be specified in the *select-clause* of the subselect of an expression in the SET clause

A PREVIOUS VALUE expression can be specified anywhere within a SET clause of an UPDATE statement, but a NEXT VALUE expression can be specified only in a SET clause if it is not within the *select-clause* of the fullselect of an expression. For example, the following uses of sequence expressions are supported:

```
UPDATE T SET C1 = (SELECT PREVIOUS VALUE FOR S1 FROM T)
UPDATE T SET C1 = PREVIOUS VALUE FOR S1
UPDATE T SET C1 = NEXT VALUE FOR S1
```

The following use of a sequence expression is not supported:

```
UPDATE T SET C1 = (SELECT NEXT VALUE FOR S1 FROM T)
```

- Within an *assignment-statement*, except within the *select-clause* of the fullselect of an expression. The following uses of sequence expressions are supported:

```
SET :ORDERNUM = NEXT VALUE FOR INVOICE
SET :ORDERNUM = PREVIOUS VALUE FOR INVOICE
```

The following use of a sequence expression is not supported:

```
SET :X = (SELECT NEXT VALUE FOR S1 FROM T)
```

```
SET :X = (SELECT PREVIOUS VALUE FOR S1 FROM T)
```

- Within a VALUES or VALUES INTO statement though not within the *select-clause* of the fullselect of an expression
- Within the *SQL-routine-body* of a CREATE PROCEDURE statement
- Within the *SQL-trigger-body* of a CREATE TRIGGER statement (PREVIOUS VALUE is not allowed)
- Within the argument list of a CALL statement.
- Within a default expression for CREATE PROCEDURE or CREATE FUNCTION. A function with a default containing NEXT VALUE or PREVIOUS VALUE can only be used in location where the NEXT VALUE or PREVIOUS VALUE can be specified directly.

Restrictions on the use of NEXT VALUE and PREVIOUS VALUE: NEXT VALUE and PREVIOUS VALUE expressions cannot be specified in the following places:

- Within a materialized query table definition in a CREATE TABLE or ALTER TABLE statement
- Within a CHECK constraint
- Within a view definition
- Within a CREATE INDEX statement
- Within the *SQL-routine-body* of a CREATE FUNCTION statement

In addition, the NEXT VALUE expression cannot be specified in the following places:

- CASE expression
- Parameter list of an aggregate function
- Subquery in a context other than those explicitly allowed
- SELECT statement for which the outer SELECT contains a DISTINCT operator or a GROUP BY clause
- SELECT statement for which the outer SELECT is combined with another SELECT statement using the UNION, INTERSECT, or EXCEPT operator
- SELECT statement that contains an OFFSET clause.
- Join condition of a join
- Nested table expression
- Parameter list of a table function
- *select-clause* of the fullselect of an expression in the SET clause of an UPDATE statement
- WHERE clause of the outermost SELECT statement or a DELETE, or UPDATE statement
- ORDER BY clause of the outermost SELECT statement
- IF, WHILE, DO . . . UNTIL, or CASE statements in an SQL routine

Using sequence expressions with a cursor: Normally, a SELECT NEXT VALUE FOR ORDER_SEQ FROM T1 would produce a result table containing as many generated values from the sequence ORDER_SEQ as the number of rows retrieved from T1. A reference to a NEXT VALUE expression in the SELECT statement of a cursor refers to a value that is generated for a row of the result table. A sequence value is generated for a NEXT VALUE expression each time a row is retrieved.

If blocking is done at a client in a DRDA environment, sequence values may get generated at the Db2 server before the processing of an application's FETCH statement. If the client application does not explicitly FETCH all the rows that have been retrieved from the database, the application will never see all those generated values of the sequence (as many as the rows that were not FETCHed). These values may constitute a gap in the sequence.

A reference to the PREVIOUS VALUE expression in a SELECT statement of a cursor is evaluated at OPEN time. In other words, a reference to the PREVIOUS VALUE expression in the SELECT statement of a cursor refers to the last value generated by this application process for the specified sequence prior to the opening of the cursor. Once evaluated at OPEN time, the value returned by PREVIOUS VALUE within the

body of the cursor will not change from FETCH to FETCH, even if NEXT VALUE is invoked within the body of the cursor. After the cursor is closed, the value of PREVIOUS VALUE will be the last NEXT VALUE generated by the application process.

Syntax alternatives: The keywords NEXTVAL and PREVVAL can be used as alternatives for NEXT VALUE and PREVIOUS VALUE respectively.

Examples

- Assume that there is a table called ORDER, and that a sequence called ORDER_SEQ is created as follows:

```
CREATE SEQUENCE ORDER_SEQ
  START WITH 1
  INCREMENT BY 1
  NO MAXVALUE
  NO CYCLE
  CACHE 24
```

Following are some examples of how to generate an ORDER_SEQ sequence number with a NEXT VALUE expression:

```
INSERT INTO ORDER (ORDERNO, CUSTNO)
  VALUES (NEXT VALUE FOR ORDER_SEQ, 123456)

UPDATE ORDER
  SET ORDERNO = NEXT VALUE FOR ORDER_SEQ
  WHERE CUSTNO = 123456

VALUES NEXT VALUE FOR ORDER
  INTO :HV_SEQ
```

XMLCAST specification

The XMLCAST specification returns the cast operand (the first operand) cast to the XML *data-type*.

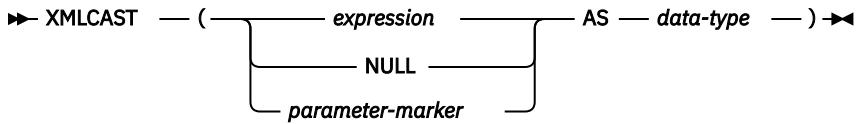

data-type

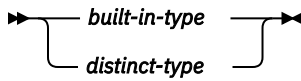

built-in-type

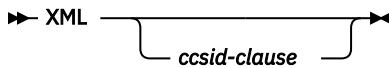

ccsid-clause



normalize-clause

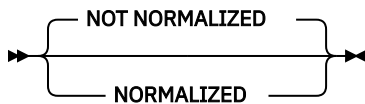

expression

Specifies that the cast operand is an expression other than NULL or a parameter marker. It must have a data type of XML. The result is the argument value converted to the specified XML target data type and CCSID.

NULL

Specifies that the cast operand is the null value. The result is a null value that has the XML data type.

parameter-marker

A parameter marker (specified as a question mark character) is normally considered an expression, but is documented separately in this case because it has a special meaning. If the cast operand is a *parameter-marker*, the XML data type is considered a promise that the replacement will be assignable to the XML data type. Such a parameter marker is called a *typed parameter marker*. Typed parameter markers will be treated like any other typed value for the purpose of DESCRIBE of a select list or for column assignment.

data-type

Specifies the data type of the result. The data type must be XML or a distinct type based on XML.

If the CCSID attribute is not specified, then the CCSID value as specified by the `SQL_XML_DATA_CCSID` QAQQINI setting is used. See [“XML Values” on page 80](#) for more information.

If the CCSID attribute is specified, the data will be converted to that CCSID. If `NORMALIZED` is specified, the data will be normalized.

Example

- Create a null XML value:

```
VALUES(XMLCAST(NULL AS XML))
```

Predicates

A *predicate* specifies a condition that is true, false, or unknown about a given value, row, or group.

The following rules apply to all types of predicates:

- Predicates are evaluated after the expressions that are operands of the predicate.
- All values specified in the same predicate must be compatible.
- The value of a variable may be null (that is, the variable may have a negative indicator variable).
- The CCSID conversion of operands of predicates involving two or more operands are done according to “Conversion rules for comparison:” on page 103.
- Use of a DataLink value is limited to the NULL predicate.

Row-value expression: The operand of several predicates (basic, quantified, and IN) can be a *row-value-expression*:

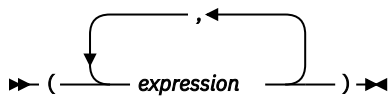

A *row-value-expression* returns a single row that consists of one or more column values. The values can be specified as a list of expressions. The number of columns that are returned by the *row-value-expression* is equal to the number of expressions that are specified in the list.

Basic predicate

A *basic predicate* compares two values or compares a set of values with another set of values.

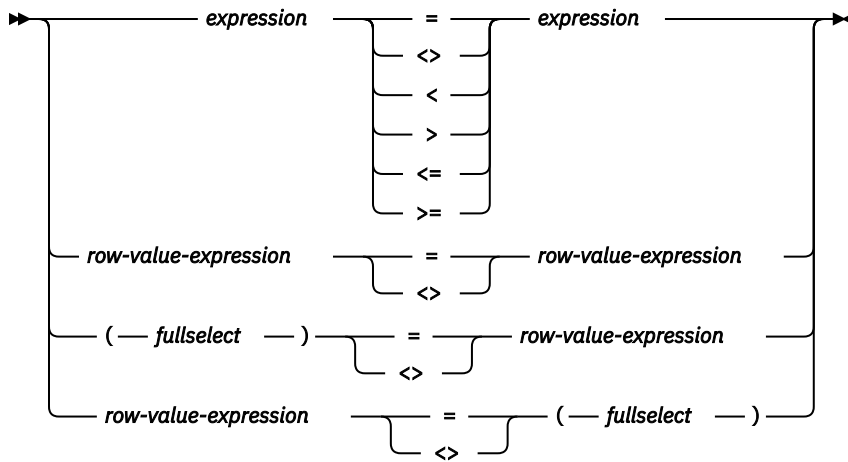

Note:

Other comparison operators are also supported.⁴⁷

Notes

When a single *expression* is specified on the left side of the operator, another *expression* must be specified on the right side. The data types of the corresponding expressions must be compatible. The value of the expression on the left side is compared with the value of the expression on the right side. If the value of either operand is null, the result of the predicate is unknown. Otherwise the result is either true or false.

When a *row-value-expression* is specified on the left side of the operator (= or <>) and another *row-value-expression* is specified on the right side of the operator, both *row-value-expressions* must have the same number of value expressions. The data types of the corresponding expressions of the *row-value-expressions* must be compatible. The value of each expression on the left side is compared with the value of its corresponding expression on the right side.

When a *row-value-expression* is specified and a *fullselect* is also specified:

- SELECT * is not allowed in the outermost select lists of the *fullselect*.
- The result table of the *fullselect* must have the same number of columns as the *row-value-expression*. The data types of the corresponding expressions of the *row-value-expression* and the *fullselect* must be compatible. The value of each expression on the left side is compared with the value of its corresponding expression on the right side.

The result of the predicate depends on the operator:

⁴⁷ The following forms of the comparison operators are also supported in basic and quantified predicates: !=, !<, !>, !=, !=, and !=> are supported. All these product-specific forms of the comparison operators are intended only to support existing SQL statements that use these operators and are not recommended for use when writing new SQL statements.

Some keyboards must use the hex values for the not (¬) symbol. The hex value varies and is dependent on the keyboard that is used. A not sign (¬) or the character that must be used in its place in certain countries or regions, can cause parsing errors in statements passed from one database server to another. The problem occurs if the statement undergoes character conversion with certain combinations of source and target CCSIDs. To avoid this problem, substitute an equivalent operator for any operator that includes a not sign. For example, substitute '<>' for '¬=', '<=' for '¬>', and '>=' for '¬<'.

- If the operator is =, the result of the predicate is:
 - True if all pairs of corresponding value expressions evaluate to true.
 - False if any one pair of corresponding value expressions evaluates to false.
 - Otherwise, unknown (that is, if at least one comparison of corresponding value expressions is unknown because of a null value and no pair of corresponding value expressions evaluates to false).
- If the operator is <>, the result of the predicate is:
 - True if any one pair of corresponding value expressions evaluates to false.
 - False if all pairs of corresponding value expressions evaluate to true.
 - Otherwise, unknown (that is, if at least one comparison of corresponding value expressions is unknown because of a null value and no pair of corresponding value expressions evaluates to true).

If the corresponding operands of the predicate are SBCS data, mixed data, or Unicode data, and if the collating sequence in effect at the time the statement is executed is not *HEX, then the comparison of the operands is performed using weighted values for the operands. The weighted values are based on the collating sequence.

For values *x* and *y*:

Predicate	Is true if and only if...
$x = y$	<i>x</i> is equal to <i>y</i>
$x <> y$	<i>x</i> is not equal to <i>y</i>
$x < y$	<i>x</i> is less than <i>y</i>
$x > y$	<i>x</i> is greater than <i>y</i>
$x >= y$	<i>x</i> is greater than or equal to <i>y</i>
$x <= y$	<i>x</i> is less than or equal to <i>y</i>

Examples

Example 1: Four examples of comparison predicates.

```
EMPNO = '528671'
PRTSTAFF <> :VAR1
SALARY + BONUS + COMM < 20000
SALARY > (SELECT AVG(SALARY)
          FROM EMPLOYEE)
```

Example 2: List the name, first name, and salary of the employee who is responsible for the 'OP1000' project.

```
SELECT LASTNAME, FIRSTNAME, SALARY
FROM EMPLOYEE X
WHERE EMPNO = ( SELECT RESPEMP
                FROM PROJA1 Y
                WHERE MAJPROJ = 'OP1000' )
```

Quantified predicate

A *quantified predicate* compares a value or values with a set of values.

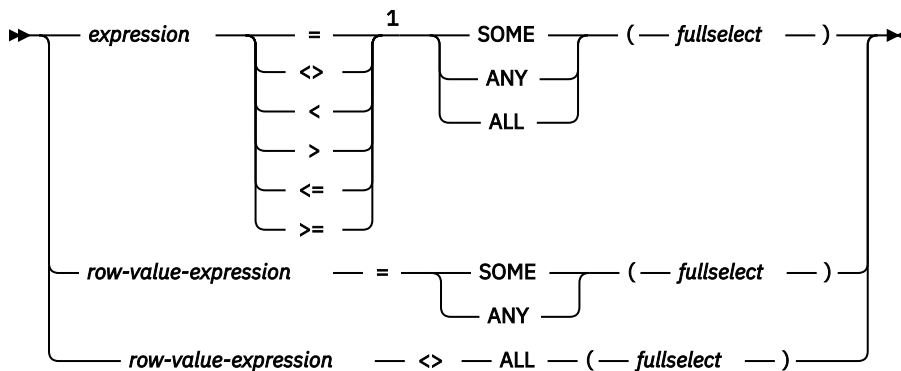

Notes:

¹ Other comparison operators are also supported. ⁴⁷

When *expression* is specified, the *fullselect* must return a single result column. The *fullselect* can return any number of values, whether null or not null. The result depends on the operator that is specified:

- When **ALL** is specified, the result of the predicate is:
 - True if the result of the *fullselect* is empty, or if the specified relationship is true for every value returned by the *fullselect*.
 - False if the specified relationship is false for at least one value returned by the *fullselect*.
 - Unknown if the specified relationship is not false for any values returned by the *fullselect* and at least one comparison is unknown because of a null value.
- When **SOME** or **ANY** is specified, the result of the predicate is:
 - True if the specified relationship is true for at least one value returned by the *fullselect*.
 - False if the result of the *fullselect* is empty, or if the specified relationship is false for every value returned by the *fullselect*.
 - Unknown if the specified relationship is not true for any of the values returned by the *fullselect* and at least one comparison is unknown because of a null value.

When *row-value-expression* is specified, the number of result columns returned by the *fullselect* must be the same as the number of value expressions specified by *row-value-expression*. The *fullselect* can return any number of rows of values. The data types of the corresponding expressions of the row value expressions must be compatible. The value of each expression from *row-value-expression* is compared with the value of the corresponding result column from the *fullselect*. `SELECT *` is not allowed in the outermost select lists of the *fullselect*. The value of the predicate depends on the operator that is specified:

- When **ALL** is specified, the result of the predicate is:
 - True if the result of the *fullselect* is empty or if the specified relationship is true for every row returned by *fullselect*.
 - False if the specified relationship is false for at least one row returned by the *fullselect*.
 - Unknown if the specified relationship is not false for any row returned by the *fullselect* and at least one comparison is unknown because of a null value.
- When **SOME** or **ANY** is specified, the result of the predicate is:
 - True if the specified relationship is true for at least one row returned by the *fullselect*.
 - False if the result of the *fullselect* is empty or if the specified relationship is false for every row returned by the *fullselect*.

- Unknown if the specified relationship is not true for any of the rows returned by the fullselect and at least one comparison is unknown because of a null value.

If the corresponding operands of the predicate are SBCS data, mixed data, or Unicode data, and if the collating sequence in effect at the time the statement is executed is not *HEX, then the comparison of the operands is performed using weighted values for the operands. The weighted values are based on the collating sequence.

Examples

Table **TBLA**

```
COLA
-----
 1
 2
 3
 4
null
```

Table **TBLB**

```
COLB
-----
 2
 3
```

Example 1

```
SELECT * FROM TBLA WHERE COLA = ANY(SELECT COLB FROM TBLB)
```

Results in 2,3. The fullselect returns (2,3). COLA in rows 2 and 3 equals at least one of these values.

Example 2

```
SELECT * FROM TBLA WHERE COLA > ANY(SELECT COLB FROM TBLB)
```

Results in 3,4. The fullselect returns (2,3). COLA in rows 3 and 4 is greater than at least one of these values.

Example 3

```
SELECT * FROM TBLA WHERE COLA > ALL(SELECT COLB FROM TBLB)
```

Results in 4. The fullselect returns (2,3). COLA in row 4 is the only one that is greater than both these values.

Example 4

```
SELECT * FROM TBLA WHERE COLA > ALL(SELECT COLB FROM TBLB WHERE COLB<0)
```

Results in 1,2,3,4 and null. The fullselect returns no values. Thus, the result of the predicate is true for all rows in TBLA.

Example 5

```
SELECT * FROM TBLA WHERE COLA > ANY(SELECT COLB FROM TBLB WHERE COLB<0)
```

Results in an empty result table. The fullselect returns no values. Thus, the result of the predicate is false for all rows in TBLA.

BETWEEN predicate

The BETWEEN predicate compares a value with a range of values.

► *expression* — **BETWEEN** — *expression* — **AND** — *expression* ►
└── NOT ─┘

If the data types of the operands are not the same, all values are converted to the data type that would result by applying the [“Rules for result data types”](#) on page 107.

If the operands of the BETWEEN predicate are strings with different CCSIDs, operands are converted as if the below logically-equivalent search conditions were specified.

The BETWEEN predicate:

```
value1 BETWEEN value2 AND value3
```

is logically equivalent to the search condition:

```
value1 >= value2 AND value1 <= value3
```

The BETWEEN predicate:

```
value1 NOT BETWEEN value2 AND value3
```

is logically equivalent to the search condition:

```
NOT(value1 BETWEEN value2 AND value3)
```

If the operands of the predicate are SBCS data, mixed data, or Unicode data, and if the collating sequence in effect at the time the statement is executed is not *HEX, then the comparison of the operands is performed using weighted values for the operands. The weighted values are based on the collating sequence.

Examples

```
EMPLOYEE.SALARY BETWEEN 20000 AND 40000  
SALARY NOT BETWEEN 20000 + :HV1 AND 40000
```

DISTINCT predicate

The DISTINCT predicate compares a value with another value.

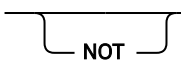
►► *expression* — IS —  — DISTINCT FROM — *expression* ►►

When the predicate is IS DISTINCT, the result of the predicate is true if the comparison of the expressions evaluates to true. Otherwise, the result of the predicate is false. The result cannot be unknown.

When the predicate IS NOT DISTINCT FROM, the result of the predicate is true if the comparison of the expressions evaluates to true (null values are considered equal to null values). Otherwise, the result of the predicate is false. The result cannot be unknown.

The DISTINCT predicate:

```
value1 IS NOT DISTINCT FROM value2
```

is logically equivalent to the search condition:

```
( value1 IS NOT NULL AND value2 IS NOT NULL AND value1 = value2 )  
OR  
( value1 IS NULL AND value2 IS NULL )
```

The DISTINCT predicate:

```
value1 IS DISTINCT FROM value2
```

is logically equivalent to the search condition:

```
NOT (value1 IS NOT DISTINCT FROM value2)
```

If the operands of the DISTINCT predicate are strings with different CCSIDs, operands are converted as if the above logically-equivalent search conditions were specified.

If the operands of the predicate are SBCS data, mixed data, or Unicode data, and if the collating sequence in effect at the time the statement is executed is not *HEX, then the comparison of the operands is performed using weighted values for the operands. The weighted values are based on the collating sequence.

Example

Assume that table T1 exists and it has a single column C1, and three rows with the following values for C1: 1, 2, null. The following query produces the following results:

```
SELECT * FROM T1  
WHERE C1 IS DISTINCT FROM :HV:IND
```

C1	:HV:IND	Result
1	2	True
2	2	False
1	Null	True
Null	Null	False

The following query produces the following results:

```
SELECT * FROM T1  
WHERE C1 IS NOT DISTINCT FROM :HV:IND
```

C1	:HV:IND	Result
1	2	False
2	2	True
1	Null	False
Null	Null	True

EXISTS predicate

The EXISTS predicate tests for the existence of certain rows.

►► EXISTS — (*fullselect*) ◄◄

The fullselect may specify any number of columns, and

- The result is true only if the number of rows specified by the fullselect is not zero.
- The result is false only if the number of rows specified by the fullselect is zero.
- The result cannot be unknown.

The values returned by the fullselect are ignored.

Example

```
EXISTS (SELECT *  
        FROM EMPLOYEE WHERE SALARY > 60000)
```

IN predicate

The IN predicate compares a value or values with a set of values.

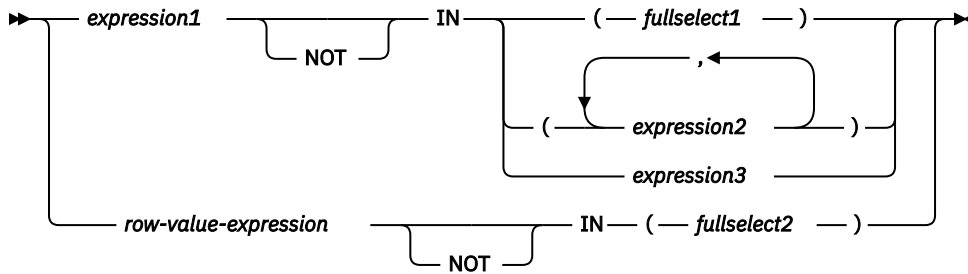

When *expression1* is specified, the IN predicate compares a value with a set of values. When *fullselect1* is specified, the fullselect must return a single result column, and can return any number of values, whether null or not null. The data type of *expression1* and the data type of the result column of the *fullselect1*, *expression2*, or *expression3* must be compatible. Each variable must identify a structure or variable that is described in accordance with the rule for declaring host structures or variables.

When a *row-value-expression* is specified, the IN predicate compares values with a collection of values.

- SELECT * is not allowed in the outermost select list of *fullselect2*.
- The result table of the *fullselect2* must have the same number of columns as *row-value-expression*. The data types of the corresponding expressions of *row-value-expression* and of its the corresponding result column of *fullselect2* must be compatible. The value of each expression in *row-value-expression* is compared with the value of its corresponding result column of *fullselect2*.

The value of the predicate depends on the operator that is specified:

- When the operator is IN, the result of the predicate is:
 - True if at least one row returned from the *fullselect2* is equal to the *row-value-expression*.
 - False if the result of *fullselect2* is empty or if no row returned from the *fullselect2* is equal to the *row-value-expression*.
 - Otherwise, unknown (that is, if the comparison of *row-value-expression* to the row returned from *fullselect2* evaluates to unknown because of a null value for at least one row returned from *fullselect2* and no row returned from *fullselect2* is equal to the *row-value-expression*).
- When the operator is NOT IN, the result of the predicate is:
 - True if the result of *fullselect2* is empty or if the *row-value-expression* is not equal to any of the rows returned by *fullselect2*.
 - False if the *row-value-expression* is equal to at least one row returned by *fullselect2*.
 - Otherwise, unknown (that is, if the comparison of *row-value-expression* to the row returned from *fullselect2* evaluates to unknown because of a null value for at least one row returned from *fullselect2* and the comparison of *row-value-expression* to the row returned from *fullselect2* is not true for any row returned by *fullselect2*).

An IN predicate is equivalent to other predicates as follows:

IN predicate	Equivalent predicate
expression IN (expression)	expression = expression
expression IN (fullselect)	expression = ANY (fullselect)
expression NOT IN (fullselect)	expression <> ALL (fullselect)

IN predicate

expression **IN** (expression1, expression2, ..., expressionn)

Equivalent predicate

expression **IN (SELECT * FROM R)**

Where T is a table with a single row and R is a temporary table formed by the following fullselect:

```
SELECT expression1 FROM T
UNION
SELECT expression2 FROM T
UNION
.
.
UNION
SELECT expressionn FROM T
```

row-value-expression **IN** (fullselect)

row-value-expression = **SOME** (fullselect)

row-value-expression **IN** (fullselect)

row-value-expression = **ANY** (fullselect)

row-value-expression **NOT IN** (fullselect)

row-value-expression **<> ALL** (fullselect)

If the operands of the IN predicate have different data types or attributes, the rules used to determine the data type for evaluation of the IN predicate are those for UNION, UNION ALL, EXCEPT, and INTERSECT. For a description, see [“Rules for result data types”](#) on page 107.

If the operands of the IN predicate are strings with different CCSIDs, the rules used to determine which operands are converted are those for operations that combine strings. For a description, see [“Conversion rules for operations that combine strings”](#) on page 112.

If the corresponding operands of the predicate are SBCS data, mixed data, or Unicode data, and if the collating sequence in effect at the time the statement is executed is not *HEX, then the comparison of the operands is performed using weighted values for the operands. The weighted values are based on the collating sequence.

Examples

```
DEPTNO IN ('D01', 'B01', 'C01')
```

```
EMPNO IN(SELECT EMPNO FROM EMPLOYEE WHERE WORKDEPT = 'E11')
```

IS JSON predicate

The IS JSON predicate determines whether a value is in a JSON format with the specified attributes.

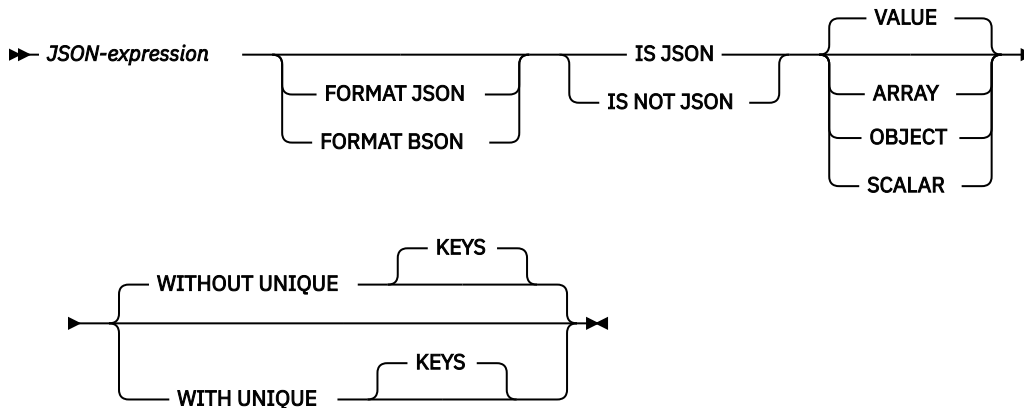

The result of the IS JSON predicate is true if the *JSON-expression* conforms to the JSON format specified by the item type and the UNIQUE KEYS clause. The result is false if the *JSON-expression* does not conform to the JSON format specified by the item type and the UNIQUE KEYS clause or if *JSON-expression* is the empty string. If NOT is specified, the result is reversed. If the value of *JSON-expression* is null, the result is unknown.

JSON-expression

An expression that returns a value that is a built-in string data type.

FORMAT JSON or FORMAT BSON

Specifies how *JSON-expression* is to be interpreted.

FORMAT JSON

JSON-expression contains JSON data. If *JSON-expression* is binary data, the data is interpreted as UTF-8 or UTF-16. Binary data cannot be encoded using an EBCDIC CCSID.

FORMAT BSON

JSON-expression contains the BSON representation of JSON data. When FORMAT BSON is specified, *JSON-expression* must be a binary string data type.

If the FORMAT clause is not specified and *JSON-expression* is a character or graphic string, *JSON-expression* is treated as JSON. If the FORMAT clause is not specified and *JSON-expression* is a binary string, *JSON-expression* is treated as BSON.

VALUE, ARRAY, OBJECT, or SCALAR

Specifies the type of JSON item to compare with the contents of *JSON-expression*.

VALUE

A valid JSON value of any of the types ARRAY, OBJECT, or SCALAR.

ARRAY

A valid JSON array which is a list of values separated by commas and enclosed in square brackets.

OBJECT

A valid JSON object which is a list of *key:value* pairs separated by commas and enclosed between a left brace and right brace.

SCALAR

A valid JSON value that is not a JSON array or a JSON object. A scalar value can be a character string, a number, or one of the JSON literals: `null`, `true`, or `false`.

WITHOUT UNIQUE KEYS or WITH UNIQUE KEYS

Specifies whether *JSON-expression* is considered to be valid JSON when keys are not unique. This clause is ignored if the JSON item is not a JSON object.

WITHOUT UNIQUE KEYS

A JSON object with keys that are not unique is valid JSON.

WITH UNIQUE KEYS

A JSON object with keys that are not unique is not valid JSON.

Example

- Create a trigger to ensure only a valid JSON object can be inserted into a JSON_DATA column.

```
CREATE TRIGGER VALIDATE_JSON BEFORE INSERT ON T
REFERENCING NEW AS N
FOR EACH ROW
IF N.JSON_DATA IS NOT JSON OBJECT THEN
  SIGNAL SQLSTATE '75007' SET MESSAGE_TEXT = 'Input is not valid JSON';
END IF
```

JSON_EXISTS predicate

The JSON_EXISTS predicate determines whether JSON data contains a JSON value that can be located using the specified *sql-json-path-expression*.

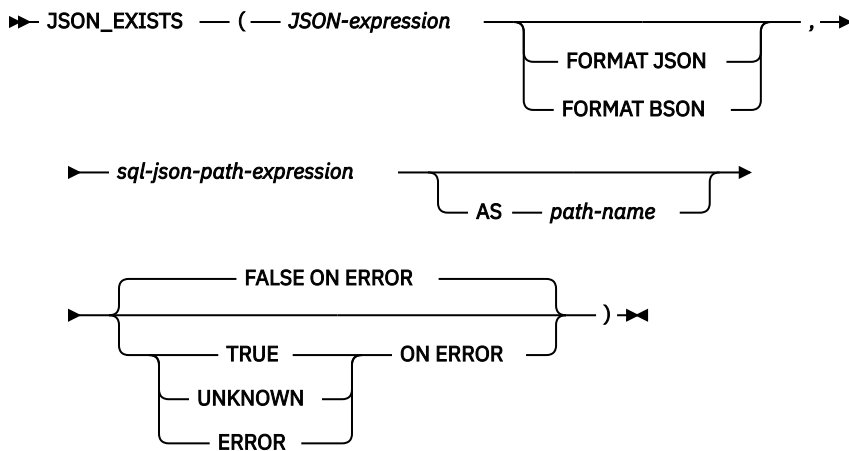

The result of the JSON_EXISTS predicate is true if at least one value can be located in *JSON-expression* using the *sql-json-path-expression*. If *sql-json-path-expression* uses strict mode and an error occurs, the result of the predicate is determined by the ON ERROR clause. The result of the JSON_EXISTS predicate is unknown if *JSON-expression* is the null value.

JSON-expression

An expression that returns a built-in string data type. If it is a character or graphic data type, it must contain correctly formatted JSON data. If it is a binary data type, it is interpreted according to the explicit or implicit FORMAT clause.

FORMAT JSON or FORMAT BSON

Specifies how *JSON-expression* is to be interpreted.

FORMAT JSON

JSON-expression contains JSON data. If *JSON-expression* is binary data, the data is interpreted as UTF-8 or UTF-16. Binary data cannot be encoded using an EBCDIC CCSID.

FORMAT BSON

JSON-expression contains the BSON representation of JSON data. When FORMAT BSON is specified, *JSON-expression* must be a binary string data type.

If the FORMAT clause is not specified and *JSON-expression* is a character or graphic string, *JSON-expression* is treated as JSON. If *JSON-expression* is a binary string, *JSON-expression* is treated as BSON.

sql-json-path-expression

An expression that returns a value that is a built-in character or graphic string data type. The string is interpreted as an SQL/JSON path expression and is used to locate a JSON value within the JSON data specified by *JSON-expression*. For information on the content of an SQL/JSON path expression, see [“sql-json-path-expression” on page 214](#).

If the value of *sql-json-path-expression* is the empty string, a string of all blanks, or the null value, no value can be located so the result of the predicate is false.

AS path-name

Specifies a name to be used to identify the *sql-json-path-expression*.

FALSE ON ERROR, TRUE ON ERROR, UNKNOWN ON ERROR, or ERROR ON ERROR

Specifies the result of the predicate when an error is encountered.

FALSE ON ERROR

The result is false if an error is encountered. This is the default.

TRUE ON ERROR

The result is true if an error is encountered.

UNKNOWN ON ERROR

The result is unknown if an error is encountered.

ERROR ON ERROR

An error is returned if an error is encountered.

Example

- Return rows for employees who do not have an emergency contact in their JSON_DATA column. COALESCE causes null values to be treated as an empty string. The FALSE ON ERROR clause is used so all rows that do not contain an emergency value will be returned.

```
SELECT empno, lastname FROM employee
WHERE NOT JSON_EXISTS(COALESCE(json_data, ''), 'strict $.emergency' FALSE ON ERROR);
```

sql-json-path-expression

An SQL/JSON path expression defines access to the elements of a JSON text.

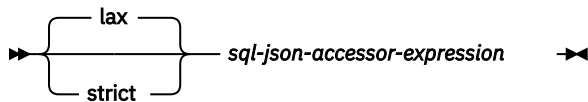

sql-json-accessor-expression

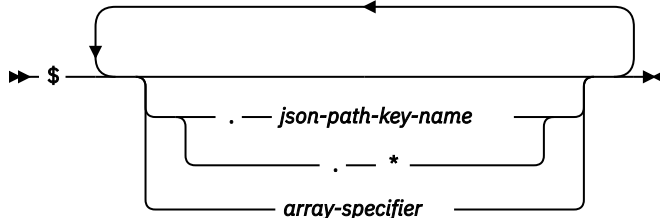

array-specifier

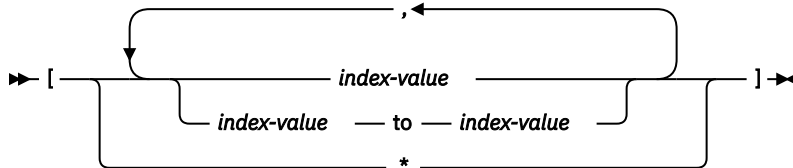

index-value

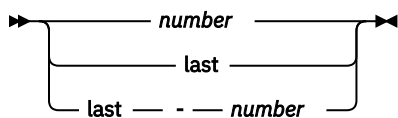

lax or strict

Specifies the JSON path mode.

lax

Specifies that certain structural errors are tolerated when navigating the current JSON text. These include:

- automatic unnesting of arrays
- automatic wrapping of scalar values to be a one element array if referenced as an array
- specification of nonexistent items, including array index values that are out of range

If an item does not exist, the SQL/JSON path expression returns an empty string which is handled according to the current ON EMPTY clause.

strict

Specifies that an error is reported when the specified path expression cannot be used to navigate the current JSON text. The error is handled according to the current ON ERROR clause.

sql-json-accessor-expression

\$

Specifies the start of the context item to which the rest of the SQL/JSON path expression is applied.

json-path-key-name

Specifies the key name of a *key,value* pair in the JSON text. If the name contains any special characters, it must be delimited with " characters.

*

Specifies that the values for all the keys will be returned as an SQL/JSON sequence.

array-specifier

Specifies a list of one or more array index values to apply to an array. The values can be specified as individual numbers or as ranges. They can be specified in any order and may contain duplicates, but the result will be returned in document order without duplicates. If a range of index values is specified and the from and to values are out of order, in `lax` mode all index values in the range are used; in `strict` mode it is an error.

index-value

Specifies an array index value.

number

An unsigned integer constant representing an array element. The first element of the array has an index of 0.

last

Indicates the last element of the array. This value cannot be specified as the first value in an index range.

last - number

Indicates a position relative to the last element of the array.

Indicates all array elements are to be selected.

Example

- Consider the following text:

```
{ "isbn": "123-456-222", "author": [ { "name": "Jones"}, {"name", "Smith"}]}
```

Here are the results of using various SQL/JSON path expressions to access items in the JSON text.

Path	Value
\$.isbn	"123-456-222"
\$.author[0].name	"Jones"
\$.author[1].name	"Smith"

LIKE predicate

The LIKE predicate searches for strings that have a certain pattern. The pattern is specified by a string in which the underscore and percent sign have special meanings. Trailing blanks in a pattern are a part of the pattern.

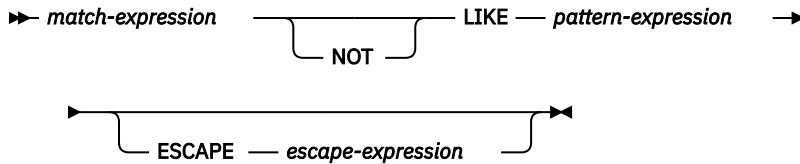

If the value of any of the arguments is null, the result of the LIKE predicate is unknown.

The *match-expression*, *pattern-expression*, and *escape-expression* must identify strings or numbers. A numeric argument is cast to a character string before evaluating the predicate. For more information about converting numeric to a character string, see “VARCHAR” on page 616. The values for *match-expression*, *pattern-expression*, and *escape-expression* must either all be binary strings or none can be binary strings. The three arguments can include a mixture of character strings and graphic strings.

None of the expressions can yield a strongly typed distinct type. However, it can be a function that casts a distinct type to its source type. If an expression yields a weakly typed distinct type, the source data type of the distinct type is used.

If the operands of the predicate are SBCS data, mixed data, or Unicode data, and if the collating sequence in effect at the time the statement is executed is not *HEX, then the comparison of the operands is performed using weighted values for the operands. The weighted values are based on the collating sequence. An ICU collating sequence is not allowed with a LIKE predicate.

With character strings, the terms *character*, *percent sign*, and *underscore* in the following discussion refer to single-byte characters. With graphic strings, the terms refer to double-byte or Unicode characters. With binary strings, the terms refer to the code points of those single-byte characters.

match-expression

An expression that specifies the string that is to be examined to see if it conforms to a certain pattern of characters.

LIKE pattern-expression

An expression that specifies the string that is to be matched.

Simple description: A simple description of the LIKE pattern is as follows:

- The underscore sign (`_`) represents any single character.
- The percent sign (`%`) represents a string of zero or more characters.
- Any other character represents itself.

If the *pattern-expression* needs to include either the underscore or the percent character, the *escape-expression* is used to specify a character to precede either the underscore or percent character in the pattern.

Rigorous description: Let *x* denote a value of *match-expression* and *y* denote the value of *pattern-expression*.

The string *y* is interpreted as a sequence of the minimum number of substring specifiers so each character of *y* is part of exactly one substring specifier. A substring specifier is an underscore, a percent sign, or any nonempty sequence of characters other than an underscore or a percent sign.

The result of the predicate is unknown if *x* or *y* is the null value. Otherwise, the result is either true or false. The result is true if *x* and *y* are both empty strings or if there exists a partitioning of *x* into substrings such that:

- A substring of *x* is a sequence of zero or more contiguous characters and each character of *x* is part of exactly one substring.
- If the *n*th substring specifier is an underscore, the *n*th substring of *x* is any single character.
- If the *n*th substring specifier is a percent sign, the *n*th substring of *x* is any sequence of zero or more characters.
- If the *n*th substring specifier is neither an underscore nor a percent sign, the *n*th substring of *x* is equal to that substring specifier and has the same length as that substring specifier.
- The number of substrings of *x* is the same as the number of substring specifiers.

It follows that if *y* is an empty string and *x* is not an empty string, the result is false. Similarly, it follows that if *x* is an empty string and *y* is not an empty string consisting of other than percent signs, the result is false.

The predicate `x NOT LIKE y` is equivalent to the search condition `NOT(x LIKE y)`.

If necessary, the CCSID of the *match-expression*, *pattern-expression*, and *escape-expression* are converted to the compatible CCSID between the *match-expression* and *pattern-expression*.

Mixed data: If the column is mixed data, the pattern can include both SBCS and DBCS characters. The special characters in the pattern are interpreted as follows:

- An SBCS underscore refers to one SBCS character.
- A DBCS underscore refers to one DBCS character.
- A percent sign (either SBCS or DBCS) refers to any number of characters of any type, either SBCS or DBCS.
- Redundant shifts in *match-expression* and *pattern-expression* are ignored.⁴⁸

Unicode data: For Unicode, the special characters in the pattern are interpreted as follows:

- An SBCS or DBCS underscore refers to one character (a character can be one or more bytes)
- A percent sign (either SBCS or DBCS) refers to a string of zero or more characters (a character can be one or more bytes).

When the LIKE predicate is used with Unicode data, the Unicode percent sign and underscore use the code points indicated in the following table:

Character	UTF-8	UTF-16 or UCS-2
Half-width %	X'25'	X'0025'
Full-width %	X'EFBC85'	X'FF05'
Half-width _	X'5F'	X'005F'
Full-width _	X'EFBCBF'	X'FF3F'

The full-width or half-width % matches zero or more characters. The full-width or half width _ character matches exactly one character. (For EBCDIC data, a full-width _ character matches one DBCS character.)

Binary data: If the column is binary data, the pattern contains bytes. The special bytes in the pattern are interpreted as follows:

- The code point for an SBCS underscore (X'6D') refers to one byte.
- The code point for an SBCS percent (X'6C') refers to any number of bytes.

⁴⁸ Redundant shifts are normally ignored. To guarantee that they are ignored, however, specify the `IGNORE_LIKE_REDUNDANT_SHIFTS` query attribute. See [Database Performance and Query Optimization](#) for information about setting query attributes.

Parameter marker:

When the pattern specified in a LIKE predicate is a parameter marker, and a fixed-length character variable is used to replace the parameter marker; specify a value for the variable that is the correct length. If a correct length is not specified, the select will not return the intended results.

For example, if the variable is defined as CHAR(10), and the value WYSE% is assigned to that variable, the variable is padded with blanks on assignment. The pattern used is

```
'WYSE%      '
```

This pattern requests the database manager to search for all values that start with WYSE and end with five blank spaces. If you intended to search for only the values that start with 'WYSE' you should assign the value 'WYSE%%%%%%%%%' to the variable.

ESCAPE *escape-expression*

An expression that specifies a character to be used to modify the special meaning of the underscore (`_`) and percent (`%`) characters in the pattern-expression. This allows the LIKE predicate to be used to match values that contain the actual percent and underscore characters. The following rules apply the use of the ESCAPE clause and the *escape-expression*:

- The *escape-expression* must be a string of length 1.⁴⁹
- The *pattern-expression* must not contain the escape character except when followed by the escape character, percent, or underscore.

For example, if '+' is the escape character, any occurrences of '+' other than '++', '+_', or '+%' in the *pattern-expression* is an error.

- The *escape-expression* can be a parameter marker.

The following example shows the effect of successive occurrences of the escape character, which in this case is the plus sign (+).

When the pattern string is...

+%

++%

+++%

The actual pattern is...

A percent sign

A plus sign followed by zero or more arbitrary characters

A plus sign followed by a percent sign

Examples

Example 1

Search for the string 'SYSTEMS' appearing anywhere within the PROJNAME column in the PROJECT table.

```
SELECT PROJNAME
FROM PROJECT
WHERE PROJECT.PROJNAME LIKE '%SYSTEMS%'
```

Example 2

Search for a string with a first character of 'J' that is exactly two characters long in the FIRSTNME column of the EMPLOYEE table.

```
SELECT FIRSTNME
FROM EMPLOYEE
WHERE EMPLOYEE.FIRSTNME LIKE 'J_'
```

Example 3

⁴⁹ If it is NUL-terminated, a C character string variable of length 2 can be specified.

In this example:

```
SELECT *
FROM TABLEY
WHERE C1 LIKE 'AAAA+%BBB%' ESCAPE '+'
```

'+' is the escape character and indicates that the search is for a string that starts with 'AAAA%BBB'. The '+' is interpreted as a single occurrence of '%' in the pattern.

Example 4

In the following table of EBCDIC examples, assume COL1 is mixed data. The table shows the results when the predicates in the first column are evaluated using the COL1 values from the second column:

Predicates	COL1 Values	Result
WHERE COL1 LIKE 'aaa 0AB%CS1'	'aaa 0ABDZC S1'	True
WHERE COL1 LIKE 'aaa 0AB S1% 0CS1'	'aaa 0AB S1 dzx 0CS1'	True
WHERE COL1 LIKE 'a% 0CS1'	'a 0CS1'	True
	'ax 0CS1'	True
	'ab 0DE S1 fg 0CS1'	True
WHERE COL1 LIKE 'a_0CS1'	'a% 0CS1'	True
	'a 0XC S1'	False
WHERE COL1 LIKE 'a_0__CS1'	'a 0XC S1'	True
	'ax 0CS1'	False
WHERE COL1 LIKE ' 0S1'	Empty string	True
WHERE COL1 LIKE 'ab 0CS1_'	'ab 0CS1 d'	True
	'ab 0S1 0CS1 d'	True

RV3F001-0

Example 5

Assume that a distinct type named ZIP_TYPE with a source data type of CHAR(5) exists and an ADDRZIP column with data type ZIP_TYPE exists in some table TABLEY. The following statement selects the row if the zip code (ADDRZIP) begins with '9555'.

```
SELECT *
FROM TABLEY
WHERE CHAR(ADDRZIP) LIKE '9555%'
```

Example 6

The RESUME column in sample table EMP_RESUME is defined as a CLOB. If the variable LASTNAME has a value of 'JONES', the following statement selects the RESUME column when the string JONES appears anywhere in the column.

```
SELECT RESUME
FROM EMP_RESUME
WHERE RESUME LIKE '%||LASTNAME||%'
```

NULL predicate

The NULL predicate tests for null values.

► *expression* — IS — NOT — NULL — ◄

The result of a NULL predicate cannot be unknown. If the value of the expression is null, the result is true. If the value is not null, the result is false.

If NOT is specified, the result is reversed.

Syntax alternatives: For compatibility with other SQL dialects, you can use ISNULL as a synonym for IS NULL and NOTNULL as a synonym for IS NOT NULL.

Examples

```
EMPLOYEE.PHONE IS NULL
```

```
SALARY IS NOT NULL
```

REGEXP_LIKE predicate

The REGEXP_LIKE predicate searches for a regular expression pattern in a string.

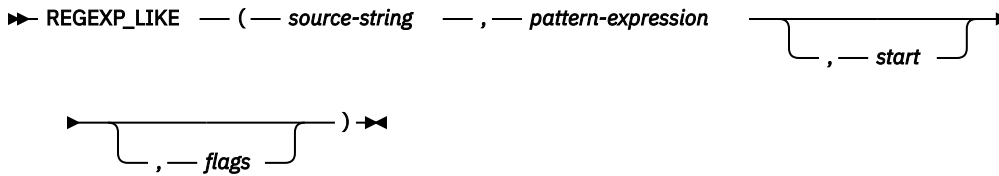

If the *pattern-expression* is found, the result is true. If the *pattern-expression* is not found, the result is false. If *source-string* and *pattern-expression* are empty strings, the result is true. If *source-string* or *pattern-expression* is the empty string (but not both), the result is false. If the value of any of the arguments is null, the result is unknown.

source-string

An expression that specifies the string in which the search is to take place. The expression must return a value that is a built-in character string, graphic string, numeric, or datetime data type. If the value is not a UTF-16 DBCLOB, it is implicitly cast to a UTF-16 DBCLOB before searching for the regular expression pattern. A character string with the FOR BIT DATA attribute or a binary string is not supported. The length of a string must not be greater than 1 gigabyte.

pattern-expression

An expression that specifies the regular expression string that is the pattern for the search. The expression must return a value that is a built-in character string, graphic string, numeric, or datetime data type. If the value is not a UTF-16 DBCLOB, it is implicitly cast to a UTF-16 DBCLOB before searching for the regular expression pattern. A character string with the FOR BIT DATA attribute or a binary string is not supported. The length of the string must not be greater than 32K.

A valid *pattern-expression* consists of a set of characters and control characters that describe the pattern of the search. For a description of the valid control characters, see [“Regular expression control characters”](#) on page 222.

start

An expression that specifies the position within *source-string* at which the search is to start. The expression must return a value of any built-in numeric, character-string, or graphic-string data type. The argument is cast to INTEGER before searching for the regular expression pattern. For more information about converting to INTEGER, see [“INTEGER or INT”](#) on page 438. The value of the integer must be greater than or equal to 1. If the value of the integer is greater than the actual length of the *source-string*, the result of the predicate is false.

flags

An expression that specifies flags that control aspects of the pattern matching. The expression must return a value that is a built-in character string or graphic string data type. A character string with the FOR BIT DATA attribute or a binary string is not supported. The string can include one or more valid flag values and the combination of flag values must be valid. An empty string is the same as the value 'c'.

For a description of the valid flag characters, see [“Regular expression flag values”](#) on page 221.

Regular expression flag values

The following table describes the supported flag values.

Flag value	Description
c	Specifies that matching is case sensitive. This is the default value if neither 'c' nor 'i' is specified. This value must not be specified with a value of 'i'.

Table 31. Flag Values (continued)

Flag value	Description
i	Specifies that matching is case insensitive. This value must not be specified with a value of 'c'.
m	Specifies that the input data could contain more than one line. By default, the '^' and the '\$' in a pattern will only match the start and the end, respectively, of the input string. If this flag is set, "^" and "\$" will also match at the start and end of each line within the input string.
n	Specifies that the '.' character in a pattern matches a line terminator in the input string. By default, the '.' in a pattern will not match a line terminator. A carriage-return and line-feed pair in the input string behaves as a single line terminator, and will match a single "." in a pattern.
s	Specifies that the '.' character in a pattern matches a line terminator in the input string. This is a synonym for the 'n' value.
x	Specifies that white space characters in a pattern are ignored, unless escaped.

Regular expression control characters

The regular expression processing is performed using the International Components for Unicode (ICU) regular expression API on Unicode data with regular expression patterns that use the control characters listed below.

Note that only halfwidth characters are recognized. Any fullwidth characters that correspond to the characters in these tables will not be recognized.

Table 32. Regular Expression Metacharacters

Character	Outside of sets	[Inside sets]	Description
\a	✓	✓	Match a BELL, \u0007
\A	✓		Match at the beginning of the input. Differs from ^ in that \A will not match after a new line within the input.
\b	✓		Match if the current position is a word boundary. Boundaries occur at the transitions between word (\w) and non-word (\W) characters, with combining marks ignored.
\B	✓		Match if the current position is not a word boundary.
\cX	✓	✓	Match a control-X character.
\d	✓	✓	Match any character with the Unicode General Category of Nd (Number, Decimal Digit.)
\D	✓	✓	Match any character that is not a decimal digit.
\e	✓	✓	Match an ESCAPE, \u001B.
\E	✓	✓	Terminates a \Q ... \E quoted sequence.
\f	✓	✓	Match a FORM FEED, \u000C.
\G	✓		Match if the current position is at the end of the previous match.
\n	✓	✓	Match a LINE FEED, \u000A.
\N{UNICODE CHARACTER NAME}	✓	✓	Match the named character.

Table 32. Regular Expression Metacharacters (continued)

Character	Outside of sets	[Inside sets]	Description
\p{UNICODE PROPERTY NAME}	✓	✓	Match any character with the specified Unicode Property.
\P{UNICODE PROPERTY NAME}	✓	✓	Match any character not having the specified Unicode Property.
\Q	✓	✓	Quotes all following characters until \E.
\r	✓	✓	Match a CARRIAGE RETURN, \u000D
\s	✓	✓	Match a white space character. White space is defined as [\t\n\f\r \p{Z}].
\S	✓	✓	Match a non-white space character.
\t	✓	✓	Match a HORIZONTAL TABULATION, \u0009.
\uhhhh	✓	✓	Match the character with the hex value hhhh.
\Uhhhhhhhh	✓	✓	Match the character with the hex value hhhhhhhh. Exactly eight hex digits must be provided, even though the largest Unicode code point is \U0010ffff.
\w	✓	✓	Match a word character. Word characters are [\p{Alphabetic}\p{Mark}\p{Decimal_Number}\p{Connector_Punctuation}\u200c\u200d].
\W	✓	✓	Match a non-word character.
\x{hhhh}	✓	✓	Match the character with hex value hhhh. From one to six hex digits may be supplied.
\xhh	✓	✓	Match the character with two digit hex value hh
\X	✓		Match a Grapheme Cluster
\Z	✓		Match if the current position is at the end of input, but before the final line terminator, if one exists.
\z	✓		Match if the current position is at the end of input.
\n	✓		Back Reference. Match whatever the nth capturing group matched. n must be a number > 1 and < total number of capture groups in the pattern.
\0ooo	✓	✓	Match an Octal character. 'ooo' is from one to three octal digits. 0377 is the largest allowed Octal character. The leading zero is required; it distinguishes Octal constants from back references.
[pattern]	✓	✓	Match any one character from the set.
.	✓		Match any character.
^	✓		Match at the beginning of a line.
\$	✓		Match at the end of a line.
\	✓		Quotes the following character. Characters that must be quoted to be treated as literals are * ? + [() { } ^ \$ \.

Table 32. Regular Expression Metacharacters (continued)

Character	Outside of sets	[Inside sets]	Description
\		✓	Quotes the following character. Characters that must be quoted to be treated as literals are [] \ Characters that may need to be quoted, depending on the context are - &

Table 33. Regular Expression Operators

Operator	Description
	Alternation. A B matches either A or B.
*	Match 0 or more times. Match as many times as possible.
+	Match 1 or more times. Match as many times as possible.
?	Match zero or one times. Prefer one
{n}	Match exactly n times
{n,}	Match at least n times. Match as many times as possible.
{n,m}	Match between n and m times. Match as many times as possible, but not more than m.
*?	Match 0 or more times. Match as few times as possible.
+?	Match 1 or more times. Match as few times as possible.
??	Match zero or one times. Prefer zero.
{n}?	Match exactly n times
{n,}?	Match at least n times, but no more than required for an overall pattern match
{n,m}?	Match between n and m times. Match as few times as possible, but not less than n.
*+	Match 0 or more times. Match as many times as possible when first encountered, do not retry with fewer even if overall match fails (Possessive Match)
++	Match 1 or more times. Possessive match
?+	Match zero or one times. Possessive match
{n}+	Match exactly n times
{n,}+	Match at least n times. Possessive Match.
{n,m}+	Match between n and m times. Possessive Match.
(...)	Capturing parentheses. Range of input that matched the parenthesized subexpression is available after the match.
(?: ...)	Non-capturing parentheses. Groups the included pattern, but does not provide capturing of matching text. Somewhat more efficient than capturing parentheses.
(?> ...)	Atomic-match parentheses. First match of the parenthesized subexpression is the only one tried; if it does not lead to an overall pattern match, back up the search for a match to a position before the "(?>"
(?# ...)	Free-format comment (?# comment).
(?= ...)	Look-ahead assertion. True if the parenthesized pattern matches at the current input position, but does not advance the input position.

Operator	Description
(?! ...)	Negative look-ahead assertion. True if the parenthesized pattern does not match at the current input position. Does not advance the input position.
(?<= ...)	Look-behind assertion. True if the parenthesized pattern matches text preceding the current input position, with the last character of the match being the input character just before the current position. Does not alter the input position. The length of possible strings matched by the look-behind pattern must not be unbounded (no * or + operators.)
(?<! ...)	Negative Look-behind assertion. True if the parenthesized pattern does not match text preceding the current input position, with the last character of the match being the input character just before the current position. Does not alter the input position. The length of possible strings matched by the look-behind pattern must not be unbounded (no * or + operators.)
(?ismwx-ismwx: ...)	Flag settings. Evaluate the parenthesized expression with the specified flags enabled or disabled.
(?ismwx-ismwx)	Flag settings. Change the flag settings. Changes apply to the portion of the pattern following the setting. For example, (?i) changes to a case insensitive match.

Example	Description
[abc]	Match any of the characters a, b or c
[^abc]	Negation - match any character except a, b or c
[A-M]	Range - match any character from A to M. The characters to include are determined by Unicode code point ordering.
[\u0000-\U0010ffff]	Range - match all characters.
[\p{Letter}] [\p{General_Category=Letter}] [\p{L}]	Characters with Unicode Category = Letter. All forms shown are equivalent.
[\P{Letter}]	Negated property. (Upper case \P) Match everything except Letters.
[\p{numeric_value=9}]	Match all numbers with a numeric value of 9. Any Unicode Property may be used in set expressions.
[\p{Letter}&&\p{script=cyrillic}]	Logical AND or intersection. Match the set of all Cyrillic letters.
[\p{Letter}-\p{script=latin}]	Subtraction. Match all non-Latin letters.
[[a-z][A-Z][0-9]] [[a-zA-Z0-9]]	Implicit Logical OR or Union of Sets. The examples match ASCII letters and digits. The two forms are equivalent.
[:script=Greek:]	Alternate POSIX-like syntax for properties. Equivalent to \p{script=Greek}

Notes

Prerequisites: In order to use the REGEXP_LIKE predicate, the International Components for Unicode (ICU) option must be installed

Processing: The regular expression processing is done using the International Components for Unicode (ICU) regular expression interface. For more information see, <http://userguide.icu-project.org/strings/regexp>.

If only three arguments are specified, the third argument may be a *start* or *flags* argument. If the third argument is a string, it is interpreted as a *flags* argument. Otherwise, it is interpreted as a *start* argument.

Examples

- *Example 1:* Select the employee number where the last name is spelled LUCCHESSEI, LUCHESSI, or LUCHESEI from the EMPLOYEE table without considering upper or lower case letters.

```
SELECT EMPNO FROM EMPLOYEE
WHERE REGEXP_LIKE(LASTNAME, 'luc+?hes+?i', 'i')
```

The result is 1 row with EMPNO value '000110'.

- *Example 2:* Select any invalid product identifier values from the PRODUCT table. The expected format is 'nnn-*nnn*-nn' where 'n' is a digit from 0 to 9.

```
SELECT PID FROM PRODUCT
WHERE NOT REGEXP_LIKE(pid, '[0-9]{3}-[0-9]{3}-[0-9]{2}')
```

The result is 0 rows because all the product identifiers match the pattern.

Trigger event predicates

A trigger event predicate is used in a triggered action to test the event that activated the trigger. It is only allowed in the triggered action of a CREATE TRIGGER statement.



DELETING

True if the trigger was activated by a delete operation. False otherwise.

INSERTING

True if the trigger was activated by an insert operation. False otherwise.

UPDATING

True if the trigger was activated by an update operation. False otherwise.

Notes

A trigger event predicate can be used anywhere in the triggered action of a CREATE TRIGGER statement.

Example

The following trigger, by using trigger event predicates in the routine body, increments the number of employees each time a new person is hired (that is, each time a new row is inserted into the EMPLOYEE table), decrements the number of employees each time an employee leaves the company, and raises an error when an update occurs that would result in a salary increase greater than ten percent of the current salary.

```
CREATE TRIGGER HIRED
AFTER INSERT OR DELETE OR UPDATE OF SALARY ON EMPLOYEE
REFERENCING NEW AS N OLD AS O FOR EACH ROW
BEGIN
  IF INSERTING
    THEN UPDATE COMPANY_STATS SET NBREMP = NBREMP + 1;
  END IF;
  IF DELETING
    THEN UPDATE COMPANY_STATS SET NBREMP = NBREMP - 1;
  END IF;
  IF UPDATING AND (N.SALARY > 1.1 * O.SALARY)
    THEN SIGNAL SQLSTATE '75000' SET MESSAGE_TEXT = 'Salary increase > 10%'
  END IF;
END
```

Search conditions

A *search condition* specifies a condition that is true, false, or unknown about a given row or group.

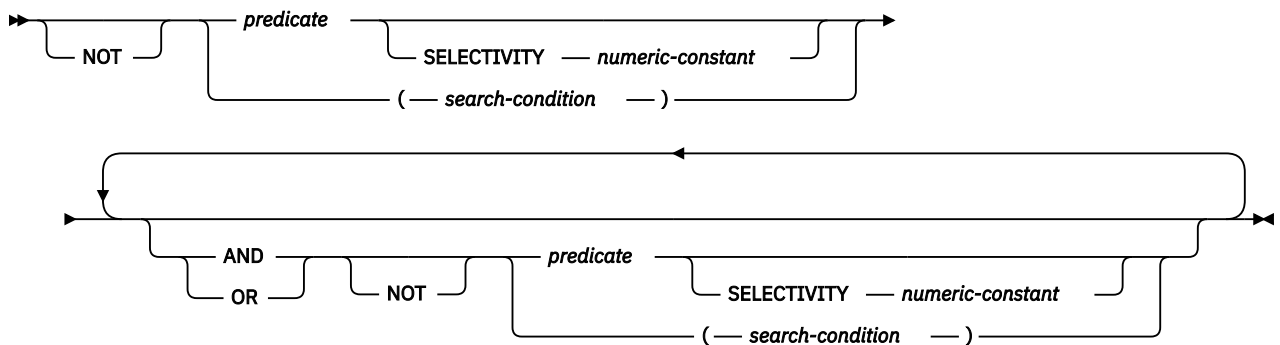

Description

SELECTIVITY numeric-constant

Specifies the expected selectivity percentage for the predicate. The selectivity value must be a numeric constant in the range from 0 to 1 (inclusive). For example, if you specify 0.01, the predicate is expected to filter out all but one percent of all the rows in the table. An error is returned if the **SELECTIVITY** clause is specified for a trigger event predicate, or if it is used with a *search-condition* that is part of a check constraint or in a **CREATE INDEX** statement.

Some predicates are rewritten during query processing. Since a **SELECTIVITY** clause cannot be properly applied to the rewritten predicates, the following predicates will usually ignore a user-supplied selectivity value:

- **DISTINCT** and **NOT DISTINCT**
- **NOT BETWEEN**
- **EXISTS**
- **IN** with a list of values
- *row-value-expression* compared to *row-value-expression*

The result of a search condition is derived by application of the specified *logical operators* (**AND**, **OR**, **NOT**) to the result of each specified predicate. If logical operators are not specified, the result of the search condition is the result of the specified predicate.

AND and **OR** are defined in the following table in which **P** and **Q** are any predicates:

Table 35. Truth Tables for **AND** and **OR**

P	Q	P AND Q	P OR Q
True	True	True	True
True	False	False	True
True	Unknown	Unknown	True
False	True	False	True
False	False	False	False
False	Unknown	False	Unknown
Unknown	True	Unknown	True
Unknown	False	False	Unknown

Table 35. Truth Tables for AND and OR (continued)

P	Q	P AND Q	P OR Q
Unknown	Unknown	Unknown	Unknown

NOT(true) is false, NOT(false) is true, and NOT(unknown) is unknown.

Search conditions within parentheses are evaluated first. If the order of evaluation is not specified by parentheses, NOT is applied before AND, and AND is applied before OR. The order in which operators at the same precedence level are evaluated is undefined to allow for optimization of search conditions.

Examples

In the examples, the numbers on the second line indicate the order in which the operators are evaluated.

Example 1

MAJPROJ = 'MA2100' **AND** DEPTNO = 'D11' **OR** DEPTNO = 'B03' **OR** DEPTNO = 'E11'

↑
↑
↑

1
2 or 3
2 or 3

Example 2

MAJPROJ = 'MA2100' **AND** (DEPTNO = 'D11' **OR** DEPTNO = 'B03') **OR** DEPTNO = 'E11'

↑
↑
↑

2
1
3

Chapter 3. Built-in global variables

This chapter contains semantic descriptions, rules, and examples of the use of the built-in global variables.

Built-in global variables are provided with the database manager and are used in SQL statements to retrieve scalar values associated with the variables.

As an example, the ROUTINE_TYPE global variable can be referenced in an SQL statement to retrieve the current routine type.

The authorization ID of any statement that retrieves the value of the global variable is required to have the READ privilege on the global variable and the USAGE privilege on the schema containing the global variable.

Example

To access the global variable CLIENT_HOST, run the following query:

```
SELECT SYSIBM.CLIENT_HOST  
FROM SYSIBM.SYSDUMMY1
```

The query returns the host name of the current client.

```
hote11nx93
```

CLIENT_HOST

This global variable contains the host name of the current client, as returned by the system.

This global variable has the following characteristics:

- It is read-only, with values maintained by system.
- The type is VARCHAR(255).
- The schema is SYSIBM.
- The scope of this global variable is session.

If the client connection originated from an application running on the local system, the value of the global variable is NULL. The server obtains the client IP address from the network when the connection is accepted. If the process did not originate from a remote system using TCP/IP, the value of the global variable is NULL.

CLIENT_IPADDR

This global variable contains the IP address of the current client, as returned by the system.

This global variable has the following characteristics:

- It is read-only, with values maintained by system.
- The type is VARCHAR(128).
- The schema is SYSIBM.
- The scope of this global variable is session.

CLIENT_PORT

This global variable contains the port number used by the current client to communicate with the server.

This global variable has the following characteristics:

- It is read-only, with values maintained by system.
- The type is INTEGER.
- The schema is SYSIBM.
- The scope of this global variable is session.

If the client did not connect by using the TCP/IP protocol, the value of the global variable is NULL.

JOB_NAME

This global variable contains the name of the current job.

This global variable has the following characteristics:

- It is read-only, with values maintained by system.
- The type is VARCHAR(28).
- The schema is QSYS2.
- The scope of this global variable is session.

PACKAGE_NAME

This global variable contains the name of the package currently being used for a DRDA connection.

This global variable has the following characteristics:

- It is read-only, with values maintained by system.
- The type is VARCHAR(128).
- The schema is SYSIBM.
- The scope of this global variable is session.

If there is no package currently executing, the value is NULL.

PACKAGE_SCHEMA

This global variable contains the schema name of the package currently being used for a DRDA connection.

This global variable has the following characteristics:

- It is read-only, with values maintained by system.
- The type is VARCHAR(128).
- The schema is SYSIBM.
- The scope of this global variable is session.

If there is no package currently executing, the value is NULL.

PACKAGE_VERSION

This global variable contains the version identifier of the package currently being used for a DRDA connection.

This global variable has the following characteristics:

- It is read-only, with values maintained by system.
- The type is VARCHAR(64).
- The schema is SYSIBM.
- The scope of this global variable is session.

If there is no package currently executing or the current executing package does not have a version identifier, the value is NULL. A package will have a version identifier only when it is created from a server other than Db2 for i.

PROCESS_ID

This global variable contains the process ID of the current job.

This global variable has the following characteristics:

- It is read-only, with values maintained by system.
- The type is INTEGER.
- The schema is QSYS2.
- The scope of this global variable is session.

Example

Review the details for this job.

```
SELECT USER, CURRENT SERVER, QSYS2.JOB_NAME, QSYS2.PROCESS_ID, QSYS2.THREAD_ID  
FROM SYSIBM.SYSDUMMY1
```

ROUTINE_SCHEMA

This global variable contains the schema name of the currently executing routine.

This global variable has the following characteristics:

- It is read-only, with values maintained by system.
- The type is VARCHAR(128).
- The schema is SYSIBM.
- The scope of this global variable is session.

If there is no routine currently executing, the value is NULL.

The value of ROUTINE_SCHEMA global variable is set only for procedures and functions. The value always reflects the schema name of the currently executing routine.

The value is not changed for functions that are inlined. The value remains the same as it was when the inline function was invoked.

ROUTINE_SPECIFIC_NAME

This global variable contains the name of the currently executing routine.

This global variable has the following characteristics:

- It is read-only, with values maintained by system.
- The type is VARCHAR(128).
- The schema is SYSIBM.
- The scope of this global variable is session.

If there is no routine currently executing, the value is NULL.

The value of ROUTINE_SPECIFIC_NAME global variable is set only for procedures and functions. The value always reflects the name of the currently executing routine.

The value is not changed for functions that are inlined. The value remains the same as it was when the inline function was invoked.

ROUTINE_TYPE

This global variable contains the type of the currently executing routine.

This global variable has the following characteristics:

- It is read-only, with values maintained by system.
- The type is CHAR(1).
- The schema is SYSIBM.
- The scope of this global variable is session.

The value of the global variable is 'P' for procedure or 'F' for function. If there is no routine currently executing, the value is NULL.

The value of ROUTINE_TYPE global variable is set only for procedures and functions. The value always reflects the type of the currently executing routine.

The value is not changed for functions that are inlined. The value remains the same as it was when the inline function was invoked.

SERVER_MODE_JOB_NAME

This global variable contains the name of the job that established the SQL server mode connection.

This global variable has the following characteristics:

- It is read-only, with values maintained by system.
- The type is VARCHAR(28).
- The schema is QSYS2.
- The scope of this global variable is session.

If there is no server mode connection, the value is NULL.

THREAD_ID

This global variable contains the thread ID of the current thread.

This global variable has the following characteristics:

- It is read-only, with values maintained by system.
- The type is BIGINT.
- The schema is QSYS2.
- The scope of this global variable is session.

Example

Capture the thread scoped record locks over the SALES table which are held by the current thread.

```
SELECT * FROM QSYS2.RECORD_LOCK_INFO L
WHERE L.TABLE_NAME = 'SALES' AND
      L.JOB_NAME = QSYS2.JOB_NAME AND
      L.THREAD_ID = QSYS2.THREAD_ID
```

Chapter 4. Built-in functions

This chapter contains syntax diagrams, semantic descriptions, rules, and examples of the use of the *built-in functions* listed in the following tables.

For more information about functions, see “Functions” on page 148.

Table 36. Aggregate Functions

Function	Description	Reference
ARRAY_AGG	Aggregates a set of elements into an array.	“ARRAY_AGG” on page 260
AVG	Returns the average of a set of numbers	“AVG” on page 262
CORR or CORRELATION	Returns the coefficient of correlation of a set of number pairs	“CORR or CORRELATION” on page 263
COUNT	Returns the number of rows or values in a set of rows or values	“COUNT” on page 264
COUNT_BIG	Returns the number of rows or values in a set of rows or values (COUNT_BIG is similar to COUNT except that the result can be greater than the maximum value of integer)	“COUNT_BIG” on page 265
COVARIANCE or COVAR	Returns the (population) covariance of a set of number pairs	“COVARIANCE or COVAR” on page 266
COVAR_SAMP or COVARIANCE_SAMP	Returns the unbiased sample covariance (n-1) of a set of number pairs	“COVAR_SAMP or COVARIANCE_SAMP” on page 267
GROUPING	Returns a value that indicates whether a row was generated as a summary row for a grouping set.	“GROUPING” on page 268
JSON_ARRAYAGG	Returns a JSON array containing an array element for each value in a set of JSON or SQL values.	“JSON_ARRAYAGG” on page 269
JSON_OBJECTAGG	Returns a JSON object containing a <i>key:value</i> pair for each specific key and value in a set of SQL values.	“JSON_OBJECTAGG” on page 274
LISTAGG	Aggregates a set of string elements into one string by concatenating the strings.	“LISTAGG” on page 278
MAX	Returns the maximum value in a set of values in a group	“MAX” on page 281
MEDIAN	Returns the median of a set of numbers	“MEDIAN” on page 282
MIN	Returns the minimum value in a set of values in a group	“MIN” on page 283
PERCENTILE_CONT	Returns the value that corresponds to the specified percentile given a sort specification by using a continuous distribution model.	“PERCENTILE_CONT” on page 284
PERCENTILE_DISC	Returns the value that corresponds to the specified percentile given a sort specification by using a discrete distribution model.	“PERCENTILE_DISC” on page 286

Table 36. Aggregate Functions (continued)

Function	Description	Reference
Regression functions	The regression functions support the fitting of an ordinary-least-squares regression line of the form $y = a * x + b$ to a set of number pairs.	“Regression functions” on page 288
STDDEV	Returns the biased standard deviation of a set of numbers	“STDDEV_POP or STDDEV” on page 291
STDDEV_SAMP	Returns the sample standard deviation of a set of numbers	“STDDEV_SAMP” on page 292
SUM	Returns the sum of a set of numbers	“SUM” on page 293
VARIANCE or VAR	Returns the biased variance of a set of numbers	“VAR_POP or VARIANCE or VAR” on page 294
VAR_SAMP or VARIANCE_SAMP	Returns the sample variance of a set of numbers	“VAR_SAMP or VARIANCE_SAMP” on page 295
XMLAGG	Returns an XML sequence containing an item for each non-null value in a set of XML values.	“XMLAGG” on page 296
XMLGROUP	Returns an XML value that is a well-formed XML document.	“XMLGROUP” on page 298

Table 37. Cast Scalar Functions

Function	Description	Reference
BIGINT	Returns a big integer representation of a number	“BIGINT” on page 314
BINARY	Returns a BINARY representation of a string of any type	“BINARY” on page 316
BLOB	Returns a BLOB representation of a string of any type	“BLOB” on page 320
CHAR	Returns a CHARACTER representation of a value	“CHAR” on page 324
CLOB	Returns a CLOB representation of a value	“CLOB” on page 332
DATE	Returns a DATE from a value	“DATE” on page 351
DBCLOB	Returns a DBCLOB representation of a string	“DBCLOB” on page 360
DECFLOAT	Returns a DECFLOAT representation of a number	“DECFLOAT” on page 368
DECIMAL	Returns a DECIMAL representation of a number	“DECIMAL or DEC” on page 373
DOUBLE_PRECISION or DOUBLE	Returns a DOUBLE PRECISION representation of a number	“DOUBLE_PRECISION or DOUBLE” on page 391
FLOAT	Returns a FLOAT representation of a number	“FLOAT” on page 407
GRAPHIC	Returns a GRAPHIC representation of a string	“GRAPHIC” on page 415
INTEGER or INT	Returns an INTEGER representation of a number	“INTEGER or INT” on page 438
REAL	Returns a REAL representation of a number	“REAL” on page 531

Table 37. Cast Scalar Functions (continued)

Function	Description	Reference
ROWID	Returns a Row ID from a value	“ROWID” on page 553
SMALLINT	Returns a SMALLINT representation of a number	“SMALLINT” on page 568
TIME	Returns a TIME from a value	“TIME” on page 584
TIMESTAMP	Returns a TIMESTAMP from a value or a pair of values	“TIMESTAMP” on page 585
TIMESTAMP_ISO	Returns a timestamp value from a datetime value	“TIMESTAMP_ISO” on page 592
TO_CLOB	Returns a CLOB representation of a value	“TO_CLOB” on page 597
VARBINARY	Returns a VARBINARY representation of a string of any type	“VARBINARY” on page 613
VARCHAR	Returns a VARCHAR representative of a value	“VARCHAR” on page 616
VARGRAPHIC	Returns a VARGRAPHIC representation of a value	“VARGRAPHIC” on page 631
ZONED	Returns a zoned decimal representation of a number	“ZONED” on page 676

Table 38. Datalink Scalar Functions

Function	Description	Reference
DLCOMMENT	Returns the comment value from a DataLink value	“DLCOMMENT” on page 382
DLLINKTYPE	Returns the link type value from a DataLink value	“DLLINKTYPE” on page 383
DLURLCOMPLETE	Returns the complete URL value from a DataLink value with a link type of URL	“DLURLCOMPLETE” on page 384
DLURLPATH	Returns the path and file name necessary to access a file within a given server from a DataLink value with a linktype of URL	“DLURLPATH” on page 385
DLURLPATHONLY	Returns the path and file name necessary to access a file within a given server from a DataLink value with a linktype of URL without a file access token	“DLURLPATHONLY” on page 386
DLURLSCHEME	Returns the scheme from a DataLink value with a linktype of URL	“DLURLSCHEME” on page 387
DLURLSERVER	Returns the file server from a DataLink value with a linktype of URL	“DLURLSERVER” on page 388
DLVALUE	Returns a DataLink value	“DLVALUE” on page 389

Table 39. Datetime Scalar Functions

Function	Description	Reference
ADD_MONTHS	Returns a date that represents the date argument plus the number of months argument	“ADD_MONTHS” on page 304
CURDATE	Returns a date based on a reading of the time-of-day clock	“CURDATE” on page 346
CURTIME	Returns a time based on a reading of the time-of-day clock	“CURTIME” on page 347
DAY	Returns the day part of a value	“DAY” on page 353
DAYNAME	Returns the name of the day part of a value	“DAYNAME” on page 354
DAYOFMONTH	Returns an integer that represents the day of the month	“DAYOFMONTH” on page 355
DAYOFWEEK	Returns the day of the week from a value, where 1 is Sunday and 7 is Saturday	“DAYOFWEEK” on page 356
DAYOFWEEK_ISO	Returns the day of the week from a value, where 1 is Monday and 7 is Sunday	“DAYOFWEEK_ISO” on page 357
DAYOFYEAR	Returns the day of the year from a value	“DAYOFYEAR” on page 358
DAYS	Returns an integer representation of a date	“DAYS” on page 359
EXTRACT	Returns a specified portion of a datetime value	“EXTRACT” on page 403
HOUR	Returns the hour part of a value	“HOUR” on page 429
JULIAN_DAY	Returns an integer value representing a number of days from January 1, 4712 B.C. to the date specified in the argument	“JULIAN_DAY” on page 462
LAST_DAY	Returns a date or timestamp that represents the last day of the month of the argument	“LAST_DAY” on page 464
MICROSECOND	Returns the microsecond part of a value	“MICROSECOND” on page 487
MIDNIGHT_SECONDS	Returns an integer value representing the number of seconds between midnight and a specified time value	“MIDNIGHT_SECONDS” on page 488
MINUTE	Returns the minute part of a value	“MINUTE” on page 490
MONTH	Returns the month part of a value	“MONTH” on page 493
MONTHNAME	Returns the name of the month part of a value	“MONTHNAME” on page 494
MONTHS_BETWEEN	Returns an estimate of the number of months between two dates	“MONTHS_BETWEEN” on page 495
NEXT_DAY	Returns a date or timestamp value that represents the first weekday after the day named by the second argument	“NEXT_DAY” on page 509
NOW	Returns a timestamp based on a reading of the time-of-day clock	“NOW” on page 512
QUARTER	Returns an integer that represents the quarter of the year in which a date resides	“QUARTER” on page 527

Table 39. Datetime Scalar Functions (continued)

Function	Description	Reference
ROUND_TIMESTAMP	Returns a timestamp rounded to the specified unit.	“ROUND_TIMESTAMP” on page 550
SECOND	Returns the seconds part of a value	“SECOND” on page 563
TIMESTAMP_FORMAT	Returns a timestamp from a character string representation of a timestamp according to the specified format of the string.	“TIMESTAMP_FORMAT” on page 587
TIMESTAMPDIFF	Returns an estimated number of intervals based on the difference between two timestamps	“TIMESTAMPDIFF” on page 593
TO_DATE	Returns a timestamp from a character string representation of a timestamp according to the specified format of the string.	“TO_DATE” on page 598
TO_TIMESTAMP	Returns a timestamp from a character string representation of a timestamp according to the specified format of the string.	“TO_TIMESTAMP” on page 600
TRUNC_TIMESTAMP	Returns a timestamp truncated to the specified unit.	“TRUNC_TIMESTAMP” on page 609
WEEK	Returns the week of the year from a value, where the week starts with Sunday	“WEEK” on page 639
WEEK_ISO	Returns the week of the year from a value, where the week starts with Monday	“WEEK_ISO” on page 640
YEAR	Returns the year part of a value	“YEAR” on page 675

Table 40. JSON Scalar Functions

Function	Description	Reference
BSON_TO_JSON	Converts a string containing formatted BSON data to a character string containing the data formatted as JSON.	“BSON_TO_JSON” on page 321
JSON_ARRAY	Generates a JSON array either by explicitly listing the array elements or by using a query	“JSON_ARRAY” on page 444
JSON_OBJECT	Generates a JSON object using the specified <i>key:value</i> pairs.	“JSON_OBJECT” on page 448
JSON_QUERY	Returns an SQL/JSON value from the specified JSON text by using an SQL/JSON path expression	“JSON_QUERY” on page 452
JSON_TO_BSON	Converts a string containing formatted JSON data to a binary string containing the data formatted as BSON.	“JSON_TO_BSON” on page 457
JSON_VALUE	Returns an SQL scalar value from a JSON text by using an SQL/JSON path expression	“JSON_VALUE” on page 458

Table 41. Miscellaneous Scalar Functions

Function	Description	Reference
ARRAY_MAX_CARDINALITY	Returns a value representing the maximum number of elements an array can contain.	“ARRAY_MAX_CARDINALITY” on page 307
ARRAY_TRIM	Returns a copy of an array from which a number of elements have been removed from the end of the array.	“ARRAY_TRIM” on page 308
CARDINALITY	Returns a value representing the number of elements of an array	“CARDINALITY” on page 322
COALESCE	Returns the first argument that is not null	“COALESCE” on page 337
CONTAINS	Returns an indication of whether a match was found in a text index.	“CONTAINS” on page 340
DATABASE	Returns the current server	“DATABASE” on page 348
GENERATE_UNIQUE	Returns a bit character string that is unique compared to any other execution of the function	“ATAN2” on page 313
GET_BLOB_FROM_FILE	Returns a BLOB locator containing the data from a source stream file or a source physical file member.	“GET_BLOB_FROM_FILE” on page 410
GET_CLOB_FROM_FILE	Returns a CLOB locator containing the data from a source stream file or a source physical file member.	“GET_CLOB_FROM_FILE” on page 411
GET_DBCLOB_FROM_FILE	Returns a DBCLOB locator containing the data from a source stream file or a source physical file member.	“GET_DBCLOB_FROM_FILE” on page 412
GET_XML_FILE	Returns a BLOB locator containing the data from a source stream file or a source physical file member with the data converted to UTF-8.	“GET_XML_FILE” on page 413
GREATEST	Returns the maximum value in a set of values	“GREATEST” on page 421
HASH_MD5, HASH_SHA1, HASH_SHA256, HASH_SHA512	The hashing functions return a 128-bit, 160-bit, 256-bit, or 512-bit hash of the input data.	“HASH_MD5, HASH_SHA1, HASH_SHA256, and HASH_SHA512” on page 422
HASH_ROW	Returns the SHA512 hash value of the data content of a row.	“HASH_ROW” on page 424
HEX	Returns a hexadecimal representation of a value	“HEX” on page 427
IDENTITY_VAL_LOCAL	Returns the most recently assigned value for an identity column	“IDENTITY_VAL_LOCAL” on page 430
IFNULL	Returns the first argument that is not null	“IFNULL” on page 434
INTERPRET	Returns the first operand interpreted as the specified data type.	“INTERPRET” on page 440
LEAST	Returns the minimum value in a set of values	“LEAST” on page 466
LENGTH	Returns the length of a value	“LENGTH” on page 469
MAX	Returns the maximum value in a set of values	“MAX” on page 485

Function	Description	Reference
MAX_CARDINALITY	Returns a value representing the maximum number of elements an array can contain.	“MAX_CARDINALITY” on page 486
MIN	Returns the minimum value in a set of values	“MIN” on page 489
NULLIF	Returns a null value if the arguments are equal, otherwise it returns the value of the first argument	“NULLIF” on page 513
NVL	Returns the first argument that is not null	“NVL” on page 514
RAISE_ERROR	Raises an error with the specified SQLSTATE and message text	“RAISE_ERROR” on page 529
RID	Returns the relative record number of a row as BIGINT.	“RID” on page 545
RRN	Returns the relative record number of a row as DECIMAL(15,0)	“RRN” on page 557
SCORE	Returns an indication of how frequently a match was found in a text index.	“SCORE” on page 560
SYS_CONNECT_BY_PATH	Returns a string representing the path from the root row to the current row for hierarchical queries.	“SYS_CONNECT_BY_PATH” on page 749
TABLE_NAME	Returns the unqualified name of the object found for an alias.	“TABLE_NAME” on page 580
TABLE_SCHEMA	Returns the schema name of the object found for an alias.	“TABLE_SCHEMA” on page 581
TRIM_ARRAY	Returns a copy of an array from which a number of elements have been removed from the end of the array.	“TRIM_ARRAY” on page 606
VALUE	Returns the first argument that is not null	“VALUE” on page 612
VERIFY_GROUP_FOR_USER	Returns an indication of whether a user is in a list of specified profiles.	“VERIFY_GROUP_FOR_USER” on page 637
WRAP	Obfuscates DDL statement text	“WRAP” on page 641

Function	Description	Reference
MQREAD	Returns a message from a specified MQSeries® location (return value of VARCHAR) without removing the message from the queue	“MQREAD” on page 497
MQREADCLOB	Returns a message from a specified MQSeries location (return value of CLOB) without removing the message from the queue	“MQREADCLOB” on page 499
MQRECEIVE	Returns a message from a specified MQSeries location (return value of VARCHAR) with removal of message from the queue	“MQRECEIVE” on page 501

Table 42. MQSeries Scalar Functions (continued)

Function	Description	Reference
MQRECEIVECLOB	Returns a message from a specified MQSeries location (return value of CLOB) with removal of message from the queue	“MQRECEIVECLOB” on page 503
MQSEND	Sends a message to a specified MQSeries location	“MQSEND” on page 505

Table 43. Numeric Scalar Functions

Function	Description	Reference
ABS or ABSVAL	Returns the absolute value of a number	“ABS or ABSVAL” on page 302
ACOS	Returns the arc cosine of a number, in radians	“ACOS” on page 303
ANTILOG	Returns the anti-logarithm (base 10) of a number	“ANTILOG” on page 306
ASIN	Returns the arc sine of a number, in radians	“ASIN” on page 310
ATAN	Returns the arc tangent of a number, in radians	“ATAN” on page 311
ATANH	Returns the hyperbolic arc tangent of a number, in radians	“ATANH” on page 312
ATAN2	Returns the arc tangent of x and y coordinates as an angle expressed in radians	“ATAN2” on page 313
BITAND, BITANDNOT, BITOR, BITXOR, BITNOT	Return a base 10 value based on a bitwise operation using the two's complement representation of the input arguments	“BITAND, BITANDNOT, BITOR, BITXOR, and BITNOT” on page 317
CEILING	Returns the smallest integer value that is greater than or equal to a number	“CEILING or CEIL” on page 323
COMPARE_DECFLOAT	Returns an indication of how two decimal floating-point values compare	“COMPARE_DECFLOAT” on page 338
COS	Returns the cosine of a number	“COS” on page 343
COSH	Returns the hyperbolic cosine of a number	“COSH” on page 344
DECFLOAT_FORMAT	Returns a DECFLOAT(34) value that is based on the interpretation of the input string using the specified format.	“DECFLOAT_FORMAT” on page 370
DECFLOAT_SORTKEY	Returns an integer value that can be used to sort decimal floating-point values.	“DECFLOAT_SORTKEY” on page 372
DEGREES	Returns the number of degrees of an angle	“DEGREES” on page 379
DIGITS	Returns a character-string representation of the absolute value of a number	“DIGITS” on page 381
EXP	Returns a value that is the base of the natural logarithm (e) raised to a power specified by the argument	“EXP” on page 402
FLOOR	Returns the largest integer value that is less than or equal to a number	“FLOOR” on page 408
LN	Returns the natural logarithm of a number	“LN” on page 471

Table 43. Numeric Scalar Functions (continued)

Function	Description	Reference
LOG10	Returns the common logarithm (base 10) of a number	“LOG10” on page 477
MOD	Returns the remainder of the first argument divided by the second argument	“MOD” on page 491
MULTIPLY_ALT	Multiplies the first argument by the second argument and returns the product	“MULTIPLY_ALT” on page 507
NORMALIZE_DECFLOAT	Returns a decimal floating-point value in its simplest form	“NORMALIZE_DECFLOAT” on page 511
PI	Returns the value of π	“PI” on page 519
POWER or POW	Returns the result of raising the first argument to the power of the second argument	“POWER or POW” on page 524
QUANTIZE	Returns a decimal floating-point value formatted according to a provided value	“QUANTIZE” on page 525
RADIANS	Returns the number of radians for an argument that is expressed in degrees	“RADIANS” on page 528
RANDOM or RAND	Returns a random number	“RANDOM or RAND” on page 530
ROUND	Returns a numeric value that has been rounded to the specified number of decimal places	“ROUND” on page 548
SIGN	Returns the sign of a number	“SIGN” on page 565
SIN	Returns the sine of a number	“SIN” on page 566
SINH	Returns the hyperbolic sine of a number	“SINH” on page 567
SQRT	Returns the square root of a number	“SQRT” on page 571
TAN	Returns the tangent of a number	“TAN” on page 582
TANH	Returns the hyperbolic tangent of a number	“TANH” on page 583
TO_NUMBER	Returns a DECFLOAT(34) value that is based on the interpretation of the input string using the specified format.	“TO_NUMBER” on page 599
TOTALORDER	Returns an ordering indication for two decimal floating-point values	“TOTALORDER” on page 601
TRUNCATE or TRUNC	Returns a number value that has been truncated at a specified number of decimal places	“TRUNCATE or TRUNC” on page 607

Table 44. Partitioning Scalar Functions

Function	Description	Reference
DATAPARTITIONNAME	Returns the partition name where a row is located	“DATAPARTITIONNAME” on page 349
DATAPARTITIONNUM	Returns the partition number of a row	“DATAPARTITIONNUM” on page 350

Table 44. Partitioning Scalar Functions (continued)

Function	Description	Reference
DBPARTITIONNAME	Returns the relational database name where a row is located	“DBPARTITIONNAME” on page 366
DBPARTITIONNUM	Returns the node number of a row	“DBPARTITIONNUM” on page 367
HASH_VALUES	Returns the partition number of a set of values	“HASH_VALUES” on page 425
HASHED_VALUE	Returns the partition map index number of a row	“HASHED_VALUE” on page 426

Table 45. String Scalar Functions

Function	Description	Reference
ASCII	Returns the ASCII code value of the leftmost character of the argument as an integer	“ASCII” on page 309
BIT_LENGTH	Returns the length of a string expression in bits	“BIT_LENGTH” on page 319
CHARACTER_LENGTH	Returns the length of a string expression	“CHARACTER_LENGTH or CHAR_LENGTH” on page 330
CHR	Returns the EBCDIC character that has the ASCII code value specified by the argument.	“CHR” on page 331
CONCAT	Returns a string that is the concatenation of two strings	“CONCAT” on page 339
DECRYPT_BIT, DECRYPT_BINARY, DECRYPT_CHAR, and DECRYPT_DB	Decrypts an encrypted string	“DECRYPT_BIT, DECRYPT_BINARY, DECRYPT_CHAR and DECRYPT_DB” on page 376
DIFFERENCE	Returns a value representing the difference between the sounds of two strings	“DIFFERENCE” on page 380
ENCRYPT and ENCRYPT_RC2	Encrypts a string using the RC2 encryption algorithm	“ENCRYPT_RC2” on page 396
ENCRYPT_AES	Encrypts a string using the AES encryption algorithm	“ENCRYPT_AES” on page 393
ENCRYPT_TDES	Encrypts a string using the Triple DES encryption algorithm	“ENCRYPT_TDES” on page 399
GETHINT	Returns a hint from an encrypted string	“GETHINT” on page 414
HEXTORAW	Returns a binary string representation of a character string that has been formatted	“HEXTORAW” on page 428
INSERT	Returns a string where a substring is deleted and a new string inserted in its place	“INSERT” on page 435
INSTR	Returns the starting position of a string within another string.	“INSTR” on page 437
LAND	Returns a string that is the logical AND of the argument strings	“LAND” on page 463

Table 45. String Scalar Functions (continued)

Function	Description	Reference
LCASE	Returns a string in which all the characters have been converted to lowercase characters	“LCASE” on page 465
LEFT	Returns the leftmost characters from the string	“LEFT” on page 467
LNOT	Returns a string that is the logical NOT of the argument string	“LNOT” on page 472
LOCATE	Returns the starting position of one string within another string	“LOCATE” on page 473
LOCATE_IN_STRING	Returns the starting position of a string within another string.	“LOCATE_IN_STRING” on page 475
LOR	Returns a string that is the logical OR of the argument strings	“LOR” on page 478
LOWER	Returns a string in which all the characters have been converted to lowercase characters	“LOWER” on page 479
LPAD	Returns a string that is padded on the left	“LPAD” on page 480
LTRIM	Returns a string in which blanks or hexadecimal zeroes have been removed from the beginning of another string	“LTRIM” on page 483
OCTET_LENGTH	Returns the length of a string expression in octets	“OCTET_LENGTH” on page 515
OVERLAY	Returns a string where a number of characters have been deleted from the original string and a new string inserted into the string.	“OVERLAY” on page 516
POSITION	Returns the starting position of one string within another string	“POSITION” on page 520
POSSTR	Returns the starting position of one string within another string	“POSSTR” on page 522
REGEXP_COUNT	Returns a returns a count of the number of times that a regular expression pattern is matched in a string	“REGEXP_COUNT” on page 533
REGEXP_INSTR	Returns the starting position or the position after the end of the matched substring.	“REGEXP_INSTR” on page 535
REGEXP_REPLACE	Returns a modified version of the source string where a regular expression pattern is replaced with a replacement string	“REGEXP_REPLACE” on page 537
REGEXP_SUBSTR	Returns an occurrence of a substring of a string that matches the regular expression pattern	“REGEXP_SUBSTR” on page 539
REPEAT	Returns a string composed of another string repeated a number of times	“REPEAT” on page 541
REPLACE	Returns a string where all occurrences of one string are replaced by another string	“REPLACE” on page 543

Table 45. String Scalar Functions (continued)

Function	Description	Reference
RIGHT	Returns the rightmost characters from the string	“RIGHT” on page 546
RPAD	Returns a string that is padded on the right	“RPAD” on page 554
RTRIM	Returns a string in which blanks or hexadecimal zeroes have been removed from the end of another string	“RTRIM” on page 558
SOUNDEX	Returns a character code representing the sound of the words in the argument	“SOUNDEX” on page 569
SPACE	Returns a character string that consists of a specified number of blanks	“SPACE” on page 570
STRIP	Removes blanks or another specified character from the end or beginning of a string expression	“STRIP” on page 572
STRLEFT	Returns the leftmost characters from the string	“STRLEFT” on page 573
STRPOS	Returns the starting position of one string within another string	“STRPOS” on page 574
STRRIGHT	Returns the rightmost characters from the string	“STRRIGHT” on page 575
SUBSTR	Returns a substring of a string	“SUBSTR” on page 576
SUBSTRING	Returns a substring of a string	“SUBSTRING” on page 578
TRANSLATE	Returns a string in which one or more characters in a string are converted to other characters	“TRANSLATE” on page 602
TO_CHAR	Returns a character string representation of the first argument using the format indicated by the optional format-string.	“TO_CHAR” on page 596
TRIM	Removes blanks or another specified character from the beginning, the end, or both the beginning and the end of a string expression	“TRIM” on page 604
UCASE	Returns a string in which all the characters have been converted to uppercase characters	“UCASE” on page 610
UPPER	Returns a string in which all the characters have been converted to uppercase characters	“UPPER” on page 611
VARBINARY_FORMAT	Returns a binary string representation of a character string that has been formatted	“VARBINARY_FORMAT” on page 614
VARCHAR_FORMAT	Returns a character string representation of the first argument using the format indicated by the optional format-string.	“VARCHAR_FORMAT” on page 622
VARCHAR_FORMAT_BINARY	Returns a character string representation of a bit string that has been formatted	“VARCHAR_FORMAT_BINARY” on page 630

Table 45. String Scalar Functions (continued)

Function	Description	Reference
XOR	Returns a string that is the logical XOR of the argument strings	“XOR” on page 669

Table 46. XML Scalar Functions

Function	Description	Reference
XMLATTRIBUTES	Constructs XML attributes from the arguments.	“XMLATTRIBUTES” on page 643
XMLCOMMENT	Returns an XML value with the input argument as the content.	“XMLCOMMENT” on page 644
XMLCONCAT	Returns an XML sequence containing the concatenation of a variable number of XML input arguments.	“XMLCONCAT” on page 645
XMLDOCUMENT	Returns an XML value that is a well-formed XML document.	“XMLDOCUMENT” on page 647
XMLELEMENT	Returns an XML value that is an XML element.	“XMLELEMENT” on page 648
XMLFOREST	Returns an XML value that is a sequence of XML elements.	“XMLFOREST” on page 651
XMLNAMESPACES	Constructs namespace declarations from the arguments.	“XMLNAMESPACES” on page 654
XMLPARSE	Returns an XML value by parsing the arguments as an XML document.	“XMLPARSE” on page 656
XMLPI	Returns an XML value with a single processing instruction.	“XMLPI” on page 657
XMLROW	Returns an XML value that is a well-formed XML document.	“XMLROW” on page 658
XMLSERIALIZE	Returns a serialized XML value as the specified data type.	“XMLSERIALIZE” on page 660
XMLTEXT	Returns an XML value that contains the value of the input argument.	“XMLTEXT” on page 664
XMLVALIDATE	Returns an XML value that has been augmented with information obtained from XML schema validation.	“XMLVALIDATE” on page 665
XSLTRANSFORM	Transforms an XML document into a different data format.	“XSLTRANSFORM” on page 670

Table 47. Table Functions

Function	Description	Reference
BASE_TABLE	Returns a table with one row containing the table name and schema name for the specified alias name	“BASE_TABLE” on page 680
JSON_TABLE	Returns a table from the evaluation of SQL/JSON path expressions.	“JSON_TABLE” on page 682

Table 47. Table Functions (continued)

Function	Description	Reference
MQREADALL	Returns a table containing the messages and message metadata from a specified MQSeries location with a VARCHAR column and without removing the messages from the queue	“MQREADALL” on page 692
MQREADALLCLOB	Returns a table containing the messages and message metadata from a specified MQSeries location with a CLOB column and without removing the messages from the queue	“MQREADALLCLOB” on page 694
MQRECEIVEALL	Returns a table containing the messages and message metadata from a specified MQSeries location with a VARCHAR column and with removal of messages from the queue	“MQRECEIVEALL” on page 696
MQRECEIVEALLCLOB	Returns a table containing the messages and message metadata from a specified MQSeries location with a CLOB column and with removal of messages from the queue	“MQRECEIVEALLCLOB” on page 699
XMLTABLE	Returns a table from the evaluation of an XPath expression.	“XMLTABLE” on page 702

Aggregate functions

An aggregate function takes a set of values (like a column of data) and returns a single value result from the set of values.

The following information applies to all aggregate functions other than COUNT(*) and COUNT_BIG(*).

- The argument of an aggregate function is a set of values derived from an expression. The expression may include columns but cannot include another aggregate function. The scope of the set is a group or an intermediate result table as explained in Chapter 6, "Queries".
- If a GROUP BY clause is specified in a query and the intermediate result of the FROM, WHERE, GROUP BY, and HAVING clauses is an empty result table, then the aggregate functions are not applied and the result of the query is an empty table.
- If a GROUP BY clause is not specified in a query and the intermediate result of the FROM, WHERE, and HAVING clauses is an empty result table, then the aggregate functions are applied to the empty result table. For example, the result of the following SELECT statement is applied to an empty result table because department D01 has no employees:

```
SELECT COUNT(DISTINCT JOB)
FROM EMPLOYEE
WHERE WORKDEPT = 'D01'
```

- The keyword DISTINCT is not considered an argument of the function, but rather a specification of an operation that is performed before the function is applied. If DISTINCT is specified, redundant duplicate values are eliminated. If ALL is implicitly or explicitly specified, redundant duplicate values are not eliminated.

When interpreting the DISTINCT clause for decimal floating-point values that are numerically equal, the number of significant digits in the value is not considered. For example, the decimal floating-point number 123.00 is not distinct from the decimal floating-point number 123. The representation of the number returned from the query will be any one of the representations encountered (for example, either 123.00 or 123).

- An aggregate function can be used in a WHERE clause only if that clause is part of a subquery of a HAVING clause and the column name specified in the expression is a correlated reference to a group. If the expression includes more than one column name, each column name must be a correlated reference to the same group.

ARRAY_AGG

The ARRAY_AGG function aggregates a set of elements into an array.

►► ARRAY_AGG ►►

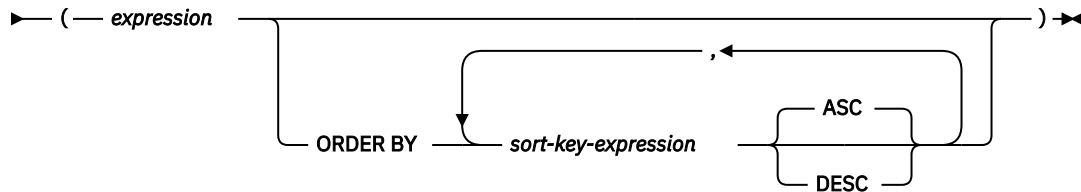

expression

An expression that returns a value that is any data type that can be specified for a CREATE TYPE (Array) statement.

ORDER BY

Specifies the order of the rows from the same grouping set that are processed in the aggregation. If the ORDER BY clause is not specified, or if the ORDER BY clause cannot differentiate the order of the sort key value, the rows in the same grouping set are arbitrarily ordered.

sort-key-expression

Specifies a sort key value that is either a column name or an expression. The data type of the column or expression must not be a DATALINK or XML value.

The ordering of the aggregated elements is based on the values of the sort keys.

The sum of the length attributes of the *sort-key-expressions* must not exceed 3.5 gigabytes.

If a collating sequence other than *HEX is in effect when the statement that contains the ARRAY_AGG function is executed and the *sort-key-expressions* are SBCS data, mixed data, or Unicode data, then the result is obtained by comparing weighted values. The weighted values are derived by applying the collating sequence to the *sort-key-expressions*.

The ARRAY_AGG function can only be specified within an SQL procedure or an SQL function in the following specific contexts:

- The *select-clause* of a SELECT INTO statement
- The *select-clause* of a scalar subquery on the right side of a SET statement

The SELECT that uses ARRAY_AGG cannot contain the DISTINCT clause.

Examples

Assume an array type and a table are created as follows:

```
CREATE TYPE PHONELIST AS DECIMAL(10,0) ARRAY[10]

CREATE TABLE EMPLOYEE (
  ID          INTEGER NOT NULL,
  PRIORITY    INTEGER NOT NULL,
  PHONENUMBER DECIMAL(10,0),
  PRIMARY KEY (ID, PRIORITY) )
```

Create a procedure that uses a SELECT INTO statement to return the prioritized list of contact numbers under which an employee can be reached.

```
CREATE PROCEDURE GETPHONENUMBERS
  (IN EMPID INTEGER,
  OUT NUMBERS PHONELIST)
BEGIN
  SELECT ARRAY_AGG(PHONENUMBER ORDER BY PRIORITY) INTO NUMBERS
  FROM EMPLOYEE
```

```
WHERE ID = EMPID;  
END
```

Create a procedure that uses a SET statement to return the list of an employee's contact numbers in an arbitrary order.

```
CREATE PROCEDURE GETPHONENUMBERS  
  (IN EMPID INTEGER,  
   OUT NUMBERS PHONELIST)  
BEGIN  
  SET NUMBERS =  
    (SELECT ARRAY_AGG(PHONENUMBER)  
     FROM EMPLOYEE  
     WHERE ID = EMPID);  
END
```

AVG

The AVG function returns the average of a set of numbers.

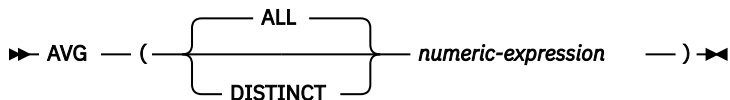

numeric-expression

An expression that returns a value of any built-in numeric, character-string, or graphic-string data type. If the argument is a character-string or graphic-string, it is cast to DECFLOAT(34) before evaluating the function. The sum of the argument values must be within the range of the data type of the result.

The data type of the result is the same as the data type of the argument values, except that:

- The result is DECFLOAT(34) if the argument values are DECFLOAT(16).
- The result is double-precision floating point if the argument values are single-precision floating point.
- The result is large integer if the argument values are small integers.
- The result is decimal if the argument values are decimal or nonzero scale binary with precision p and scale s . The precision of the result is $p-s + \min(ms, mp-p+s)$. The scale of the result is $\min(ms, mp-p+s)$.

For information about the values of p , s , ms , and mp , see [“Decimal arithmetic in SQL” on page 161](#).

The function is applied to the set of values derived from the argument values by the elimination of null values. If DISTINCT is used, duplicate values are eliminated.

The result can be null. If set of values is empty, the result is the null value. Otherwise, the result is the average value of the set.

The order in which the values are aggregated is undefined, but every intermediate result must be within the range of the result data type.

If the type of the result is integer, the fractional part of the average is lost.

Notes

Results involving DECFLOAT special values: If the data type of the argument is decimal floating-point and a special value of sNaN or -sNaN, or both +Infinity and -Infinity are included in the aggregation, an error or warning is returned. Otherwise, if +NaN or -NaN is found, the result is +NaN or -NaN. If +Infinity or -Infinity is found, the result is +Infinity or -Infinity.

Examples

- Using the PROJECT table, set the host variable AVERAGE (DECIMAL(5,2)) to the average staffing level (PRSTAFF) of projects in department (DEPTNO) 'D11'.

```
SELECT AVG(PRSTAFF)
INTO :AVERAGE
FROM PROJECT
WHERE DEPTNO = 'D11'
```

Results in AVERAGE being set to 4.25 (that is, 17/4).

- Using the PROJECT table, set the host variable ANY_CALC to the average of each unique staffing value (PRSTAFF) of projects in department (DEPTNO) 'D11'.

```
SELECT AVG(DISTINCT PRSTAFF)
INTO :ANY_CALC
FROM PROJECT
WHERE DEPTNO = 'D11'
```

Results in ANY_CALC being set to 4.66 (that is, 14/3).

CORR or CORRELATION

The CORRELATION function returns the coefficient of correlation of a set of number pairs.

► CORR (*expression1* , *expression2*) ◄
CORRELATION

expression1

An expression that returns a value of any built-in numeric, character-string, or graphic-string data type. If the argument is a character-string or graphic-string, it is cast to DECFLOAT(34) before evaluating the function.

expression2

An expression that returns a value of any built-in numeric, character-string, or graphic-string data type. If the argument is a character-string or graphic-string, it is cast to DECFLOAT(34) before evaluating the function.

If either argument is decimal floating-point, the result of the function is DECFLOAT(34). Otherwise, the result of the function is a double precision floating-point number. The result can be null. When not null, the result is between -1 and 1.

The function is applied to the set of (*expression1*, *expression2*) pairs derived from the argument values by the elimination of all pairs for which either *expression1* or *expression2* is null.

If the function is applied to an empty set, or if either STDDEV(*expression1*) or STDDEV(*expression2*) is equal to zero, the result is a null value. Otherwise, the result is the correlation coefficient for the value pairs in the set. The result is equivalent to the following:

1. Let *sdexp1* be the result of STDDEV(*expression1*) and let *sdexp2* be the result of STDDEV(*expression2*).
2. The result of CORRELATION(*expression1*, *expression2*) is:

```
COVARIANCE(expression1, expression2) / (sdexp1 * sdexp2)
```

The order in which the values are aggregated is undefined, but every intermediate result must be within the range of the result data type.

Notes

Results involving DECFLOAT special values: If the data type of the argument is decimal floating-point and a special value of sNaN or -sNaN, or both +Infinity and -Infinity are included in the aggregation, an error or warning is returned. Otherwise, if +NaN or -NaN is found, the result is +NaN or -NaN. If +Infinity or -Infinity is found, the result is +Infinity or -Infinity.

Syntax alternatives: CORR should be used for conformance to the SQL standard.

Example

- Using the EMPLOYEE table, set the host variable CORRLN to the correlation between the salary and the bonus for those employees in department 'A00'.

```
SELECT CORRELATION(SALARY, BONUS)
  INTO :CORRLN
  FROM EMPLOYEE
  WHERE WORKDEPT = 'A00';
```

CORRLN is set to 0.9760236077658643 when using the sample table.

COUNT

The COUNT function returns the number of rows or values in a set of rows or values.

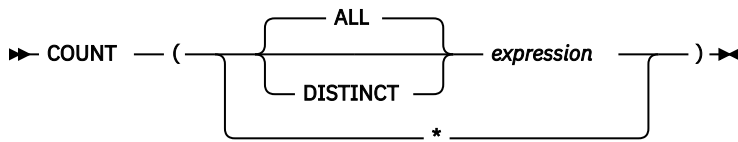

expression

The argument values can be of any built-in data type other than a DataLink. XML is not allowed for COUNT (DISTINCT *expression*).

The result of the function is a large integer and it must be within the range of large integers. The result cannot be null. If the table is a distributed table, then the result is DECIMAL(15,0). For more information about distributed tables, see the [DB2 Multisystem](#) topic collection.

The argument of COUNT(*) is a set of rows. The result is the number of rows in the set. A row that includes only null values is included in the count.

The argument of COUNT(*expression*) or COUNT(ALL *expression*) is a set of values. The function is applied to the set derived from the argument values by the elimination of null values. The result is the number of non-null values in the set including duplicates.

The argument of COUNT(DISTINCT *expression*) is a set of values. The function is applied to the set of values derived from the argument values by the elimination of null values and duplicate values. The result is the number of values in the set.

If a collating sequence other than *HEX is in effect when the statement that contains the COUNT(DISTINCT *expression*) is executed and the arguments are SBCS data, mixed data, or Unicode data, then the result is obtained by comparing weighted values for each value in the set. The weighted values are based on the collating sequence.

Examples

- Using the EMPLOYEE table, set the host variable FEMALE (INTEGER) to the number of rows where the value of the SEX column is 'F'.

```
SELECT COUNT(*)
INTO :FEMALE
FROM EMPLOYEE
WHERE SEX = 'F'
```

Results in FEMALE being set to 19.

- Using the EMPLOYEE table, set the host variable FEMALE_IN_DEPT (INTEGER) to the number of departments (WORKDEPT) that have at least one female as a member.

```
SELECT COUNT(DISTINCT WORKDEPT)
INTO :FEMALE_IN_DEPT
FROM EMPLOYEE
WHERE SEX='F'
```

Results in FEMALE_IN_DEPT being set to 6. (There is at least one female in departments A00, C01, D11, D21, E11, and E21.)

COUNT_BIG

The COUNT_BIG function returns the number of rows or values in a set of rows or values. It is similar to COUNT except that the result can be greater than the maximum value of integer.

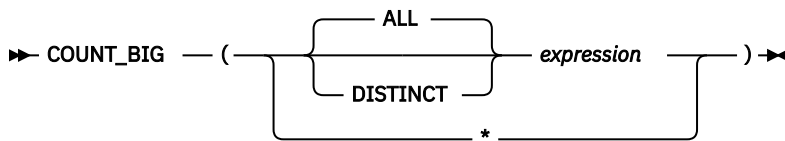

expression

The argument values can be of any built-in data type other than a DataLink. XML is not allowed for COUNT_BIG(DISTINCT *expression*).

The result of the function is a decimal with precision 31 and scale 0. The result cannot be null.

The argument of COUNT_BIG(*) is a set of rows. The result is the number of rows in the set. A row that includes only null values is included in the count.

The argument of COUNT_BIG(*expression*) is a set of values. The function is applied to the set derived from the argument values by the elimination of null values. The result is the number of values in the set.

If a collating sequence other than *HEX is in effect when the statement that contains the COUNT_BIG(DISTINCT *expression*) is executed and the arguments are SBCS data, mixed data, or Unicode data, then the result is obtained by comparing weighted values for each value in the set. The weighted values are based on the collating sequence.

Examples

- Refer to COUNT examples and substitute COUNT_BIG for occurrences of COUNT. The results are the same except for the data type of the result.
- To count on a specific column, a sourced function must specify the type of the column. In this example, the CREATE FUNCTION statement creates a sourced function that takes any column defined as CHAR, uses COUNT_BIG to perform the counting, and returns the result as a double precision floating-point number. The query shown counts the number of unique departments in the sample employee table.

```
CREATE FUNCTION RICK.COUNT(CHAR(19)) RETURNS DOUBLE
SOURCE QSYS2.COUNT_BIG(CHAR());

SET CURRENT PATH RICK, SYSTEM PATH

SELECT COUNT(DISTINCT WORKDEPT) FROM EMPLOYEE;
```

COVARIANCE or COVAR

The COVARIANCE function returns the (population) covariance of a set of number pairs.

► COVARIANCE (*expression1* , *expression2*) ◄
COVAR

expression1

An expression that returns a value of any built-in numeric, character-string, or graphic-string data type. If the argument is a character-string or graphic-string, it is cast to DECFLOAT(34) before evaluating the function.

expression2

An expression that returns a value of any built-in numeric, character-string, or graphic-string data type. If the argument is a character-string or graphic-string, it is cast to DECFLOAT(34) before evaluating the function.

If either argument is decimal floating-point, the result of the function is DECFLOAT(34). Otherwise, the result of the function is a double precision floating-point number. The result can be null.

The function is applied to the set of (*expression1*, *expression2*) pairs derived from the argument values by the elimination of all pairs for which either *expression1* or *expression2* is null.

If the function is applied to an empty set, the result is a null value. Otherwise, the result is the covariance for the value pairs in the set. The result is equivalent to the following:

1. Let avgexp1 be the result of AVG(*expression1*) and let avgexp2 be the result of AVG(*expression2*).
2. The result of COVARIANCE(*expression1*, *expression2*) is:

```
AVG( (expression1 - avgexp1) * (expression2 - avgexp2) )
```

The order in which the values are aggregated is undefined, but every intermediate result must be within the range of the result data type.

Notes

Results involving DECFLOAT special values: If the data type of the argument is decimal floating-point and a special value of sNaN or -sNaN, or both +Infinity and -Infinity are included in the aggregation, an error or warning is returned. Otherwise, if +NaN or -NaN is found, the result is +NaN or -NaN. If +Infinity or -Infinity is found, the result is +Infinity or -Infinity.

Syntax alternatives: COVAR_POP can be specified as a synonym for COVARIANCE.

Example

- Using the EMPLOYEE table, set the host variable COVARNCE to the covariance between the salary and the bonus for those employees in department 'A00'.

```
SELECT COVARIANCE(SALARY, BONUS)  
  INTO :COVARNCE  
  FROM EMPLOYEE  
  WHERE WORKDEPT = 'A00';
```

COVARNCE is set to 1743000.0000 when using the sample table.

COVAR_SAMP or COVARIANCE_SAMP

The COVARIANCE_SAMP function returns the unbiased sample covariance (n-1) of a set of number pairs.

► COVAR_SAMP (— *expression1* — , — *expression2* —) ◄
COVARIANCE_SAMP

expression1

An expression that returns a value of any built-in numeric, character-string, or graphic-string data type. If the argument is a character-string or graphic-string, it is cast to DECFLOAT(34) before evaluating the function.

expression2

An expression that returns a value of any built-in numeric, character-string, or graphic-string data type. If the argument is a character-string or graphic-string, it is cast to DECFLOAT(34) before evaluating the function.

If either argument is decimal floating-point, the result of the function is DECFLOAT(34). Otherwise, the result of the function is a double precision floating-point number. The result can be null.

The function is applied to the set of (*expression1*, *expression2*) pairs derived from the argument values by the elimination of all pairs for which either *expression1* or *expression2* is null.

If the function is applied to an empty set or a set with only one row, the result is a null value. Otherwise, the result is the sample covariance for the value pairs in the set. The result is equivalent to the following:

1. Let avgexp1 be the result of AVG(*expression1*) and let avgexp2 be the result of AVG(*expression2*).
2. The result of COVARIANCE_SAMP(*expression1*, *expression2*) is:

```
SUM( (expression1 - avgexp1) * (expression2 - avgexp2) ) /  
  ( COUNT(expression1) - 1 )
```

The order in which the values are aggregated is undefined, but every intermediate result must be within the range of the result data type.

Notes

Results involving DECFLOAT special values: If the data type of the argument is decimal floating-point and a special value of sNaN or -sNaN, or both +Infinity and -Infinity are included in the aggregation, an error or warning is returned. Otherwise, if +NaN or -NaN is found, the result is +NaN or -NaN. If +Infinity or -Infinity is found, the result is +Infinity or -Infinity.

Syntax alternatives: COVAR_SAMP should be used for conformance to the SQL standard.

Example

- Set the host variable COVAR_S to the sample covariance between the salary and bonus for those employees in department 'A00' of the EMPLOYEE table. The data type of the host variable COVAR_S is double-precision floating point.

```
SELECT COVARIANCE_SAMP(SALARY, BONUS)  
  INTO :COVAR_S  
  FROM EMPLOYEE  
  WHERE WORKDEPT = 'A00'
```

COVAR_S is set to 2178750.0000 when the sample table is used.

GROUPING

Used in conjunction with grouping-sets and super-groups, the GROUPING aggregate function returns a value that indicates whether a row returned in a GROUP BY answer set is a row generated by a grouping set that excludes the column represented by *expression*.

►► GROUPING — (— *expression* —) ◄◄

expression

The argument values can be any built-in data type, but must be an item of a GROUP BY clause.

The data type of the result is a small integer. It is set to one of the following values:

- 1** The value of *expression* in the returned row is a null value, and the row was generated by the super-group. This generated row can be used to provide subtotal values for the GROUP BY expression.
- 0** The value is other than the above.

Example

The following query:

```
SELECT SALES_DATE, SALES_PERSON,
       SUM(SALES) AS UNITS_SOLD,
       GROUPING(SALES_DATE) AS DATE_GROUP,
       GROUPING(SALES_PERSON) AS SALES_GROUP
FROM SALES
GROUP BY CUBE( SALES_DATE, SALES_PERSON)
ORDER BY SALES_DATE, SALES_PERSON
```

Results in:

SALES_DATE	SALES_PERSON	UNITS_SOLD	DATE_GROUP	SALES_GROUP
12/31/1995	GOUNOT	1	0	0
12/31/1995	LEE	6	0	0
12/31/1995	LUCCHESSEI	1	0	0
12/31/1995	-	8	0	1
03/29/1996	GOUNOT	11	0	0
03/29/1996	LEE	12	0	0
03/29/1996	LUCCHESSEI	4	0	0
03/29/1996	-	27	0	1
03/30/1996	GOUNOT	21	0	0
03/30/1996	LEE	21	0	0
03/30/1996	LUCCHESSEI	4	0	0
03/30/1996	-	46	0	1
03/31/1996	GOUNOT	3	0	0
03/31/1996	LEE	27	0	0
03/31/1996	LUCCHESSEI	1	0	0
03/31/1996	-	31	0	1
04/01/1996	GOUNOT	14	0	0
04/01/1996	LEE	25	0	0
04/01/1996	LUCCHESSEI	4	0	0
04/01/1996	-	43	0	1
-	GOUNOT	50	1	0
-	LEE	91	1	0
-	LUCCHESSEI	14	1	0
-	-	155	1	1

An application can recognize a SALES_DATE subtotal row by the fact that the value of DATE_GROUP is 0 and the value of SALES_GROUP is 1. A SALES_PERSON subtotal row can be recognized by the fact that the value of DATE_GROUP is 1 and the value of SALES_GROUP is 0. A grand total row can be recognized by the fact that the value of both DATE_GROUP and SALES_GROUP is 1.

JSON_ARRAYAGG

The JSON_ARRAYAGG function returns a JSON array containing an array element for each value in a set of JSON or SQL values.

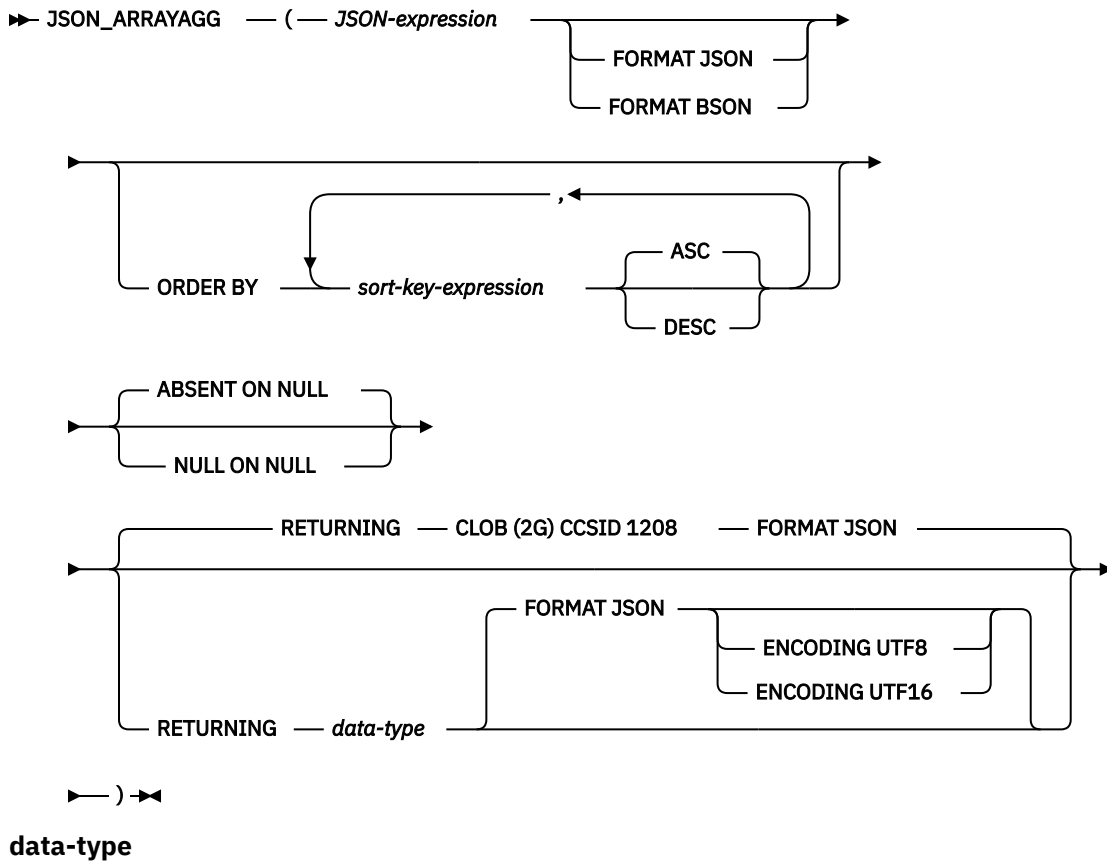

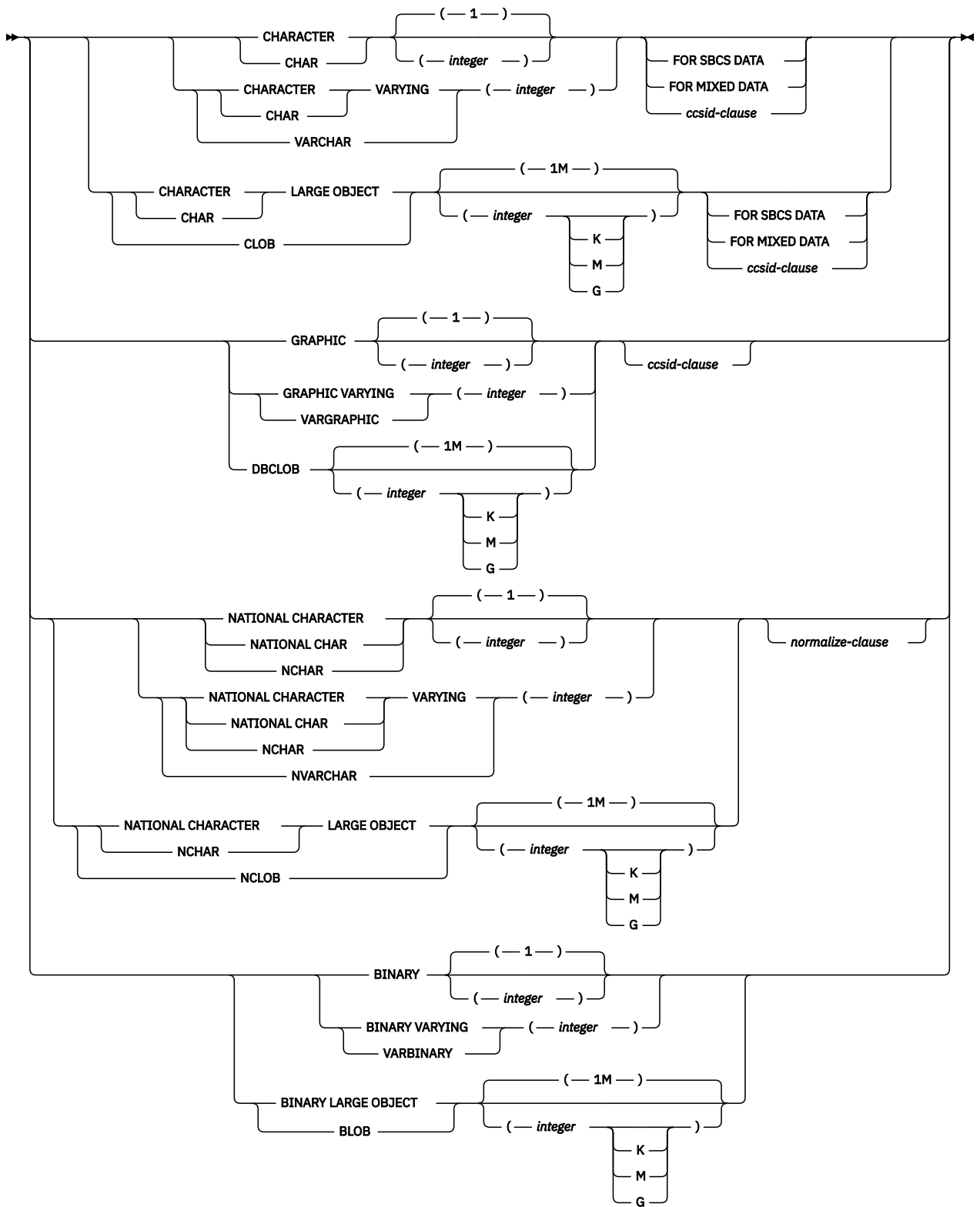

ccsid-clause

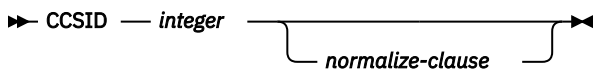

normalize-clause

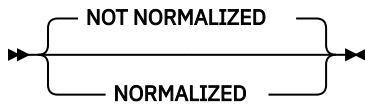

JSON-expression

The expression to use to generate a value in the JSON array. The result type of this expression can be any built-in data type except XML, ROWID, or DATALINK. It cannot be CHAR or VARCHAR bit data. It cannot be a user-defined type that is sourced on any of these data types.

FORMAT JSON or FORMAT BSON

Specifies whether *JSON-expression* is already formatted data.

FORMAT JSON

JSON-expression is formatted as JSON data. If *JSON-expression* is a character or graphic string data type, it is treated as JSON data. If *JSON-expression* is a binary string data type, it is interpreted as UTF-8 or UTF-16 data.

FORMAT BSON

JSON-expression is formatted as the BSON representation of JSON data and must be a binary string data type.

If neither FORMAT JSON nor FORMAT BSON is specified:

- If *JSON-expression* is one of the built-in functions JSON_ARRAY, JSON_OBJECT, JSON_QUERY, JSON_ARRAYAGG, or JSON_OBJECTAGG, the explicit or implicit FORMAT value of the function's RETURNING clause determines the format of *JSON-expression*.
- If *JSON-expression* is a binary string type, it is interpreted as FORMAT BSON.
- Otherwise, *JSON-expression* is considered unformatted data. If the generated value is not numeric, the result string will be constructed with strings enclosed in quotes and any special characters will be escaped. A numeric value that is not a valid JSON number, such as INFINITY or NAN, will result in an error.

ORDER BY

Specifies the order of the rows from the same grouping set that are processed in the aggregation. If the ORDER BY clause is not specified, or if the ORDER BY clause cannot differentiate the order of the sort key value, the rows in the same grouping set are arbitrarily ordered.

sort-key-expression

Specifies a sort key value that is either a column name or an expression. The data type of the column or expression must not be a DATALINK or XML value..

ASC

Processes the *sort-key-expression* in ascending order. This is the default.

DESC

Processes the *sort-key-expression* in descending order.

The ordering is based on the values of the sort keys, which might or might not be used in *JSON-expression*.

The sum of the length attributes of the *sort-key-expressions* must not exceed 3.5 gigabytes.

If a collating sequence other than *HEX is in effect when the statement that contains the JSON_ARRAYAGG function is executed and the *sort-key-expressions* are SBCS data, mixed data, or Unicode data, then the result is obtained by comparing weighted values. The weighted values are derived by applying the collating sequence to the *sort-key-expressions*.

ABSENT ON NULL or NULL ON NULL

Specifies what to return when an array element produced by *JSON-expression* is the null value.

ABSENT ON NULL

A null array element is not included in the JSON array. This is the default.

NULL ON NULL

A null array element is included in the JSON array.

RETURNING *data-type*

Specifies the format of the result.

data-type

The data type of the result. For CHAR and VARCHAR results, the CCSID cannot be 65535. The default is CLOB(2G) CCSID 1208.

If a CCSID is specified and the *data-type* is GRAPHIC, VARGRAPHIC, or DBCLOB, the CCSID must be a Unicode CCSID.

If the CCSID attribute is not specified, the CCSID is determined as described in [“CAST specification” on page 177](#).

FORMAT JSON

JSON data is returned as a JSON string.

ENCODING UTF8 or ENCODING UTF16

The encoding to use when *data-type* is a binary string type. This clause is only allowed for binary string types. The default for binary strings is UTF8.

The result can be null. If the set of values is empty, the result is the null value.

Example

- Return a JSON array containing all the department numbers.

```
SELECT JSON_ARRAYAGG(deptno) AS deptlist FROM dept;
```

The result is the following JSON array.

```
["A00", "B01", "C01", "D01", "D11", "D21", "E01", "E11", "E21", "F22", "G22", "H22", "I22", "J22"]
```

- Return a JSON array for each department containing a list of employees assigned to that department.

```
SELECT workdept, JSON_ARRAYAGG(lastname ORDER BY lastname) AS dept_employees
FROM emp
WHERE workdept LIKE 'D%'
GROUP BY workdept;
```

The result is the following 2 rows.

DEPTNO	PROJLIST
D11	["ADAMSON", "BROWN", "JOHN", "JONES", "LUTZ", "PIANKA", "SCOUTTEN", "STERN", "WALKER", "YAMAMOTO", "YOSHIMURA"]
D21	["JEFFERSON", "JOHNSON", "MARINO", "MONTEVERDE", "PEREZ", "PULASKI", "SMITH"]

- Return a JSON object that contains a list of departments and employees in each department.

```
SELECT JSON_OBJECT('department number' VALUE deptno,
                  'department name' VALUE deptname,
                  'employee list' VALUE
                    JSON_ARRAYAGG(
                      JSON_OBJECT('last name' VALUE lastname,
                                  'employee id' VALUE empno)
                      ORDER BY lastname)
                  FROM dept LEFT OUTER JOIN emp ON deptno = workdept
                  WHERE deptno LIKE 'D%'
                  GROUP BY deptno, deptname;
```

The result is the following 3 rows.

```
{
  "department number": "D11",
  "department name": "MANUFACTURING SYSTEMS",
  "employee list": [
    {"last name": "ADAMSON", "employee id": "000150"},
    {"last name": "BROWN", "employee id": "000200"},
    {"last name": "JOHN", "employee id": "200220"},
    {"last name": "JONES", "employee id": "000210"},
    {"last name": "LUTZ", "employee id": "000220"}
  ]
}
```

```

{"last name":"PIANKA","employee id":"000160"},
{"last name":"SCOUTTEN","employee id":"000180"},
{"last name":"STERN","employee id":"000060"},
{"last name":"WALKER","employee id":"000190"},
{"last name":"YAMAMOTO","employee id":"200170"},
{"last name":"YOSHIMURA","employee id":"000170"}]}

{"department number":"D21","department name":"ADMINISTRATION SYSTEMS",
  "employee list":[{"last name":"JEFFERSON","employee id":"000150"},
    {"last name":"JOHNSON","employee id":"000150"},
    {"last name":"MARINO","employee id":"000150"},
    {"last name":"MONTEVERDE","employee id":"000150"},
    {"last name":"PEREZ","employee id":"000150"},
    {"last name":"PULASKI","employee id":"000150"},
    {"last name":"SMITH","employee id":"000150"}]}

{"department number":"D01","department name":"DEVELOPMENT CENTER"}

```

JSON_OBJECTAGG

The JSON_OBJECTAGG function returns a JSON object containing a *key:value* pair for each specific key and value in a set of SQL values.

►► JSON_OBJECTAGG — (—►

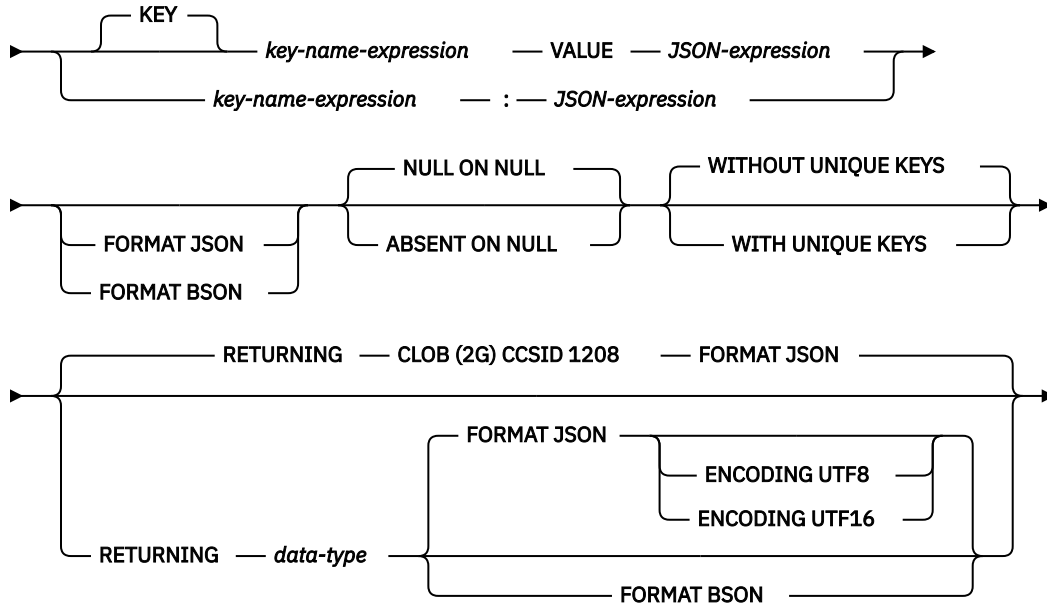

►) ►►

data-type

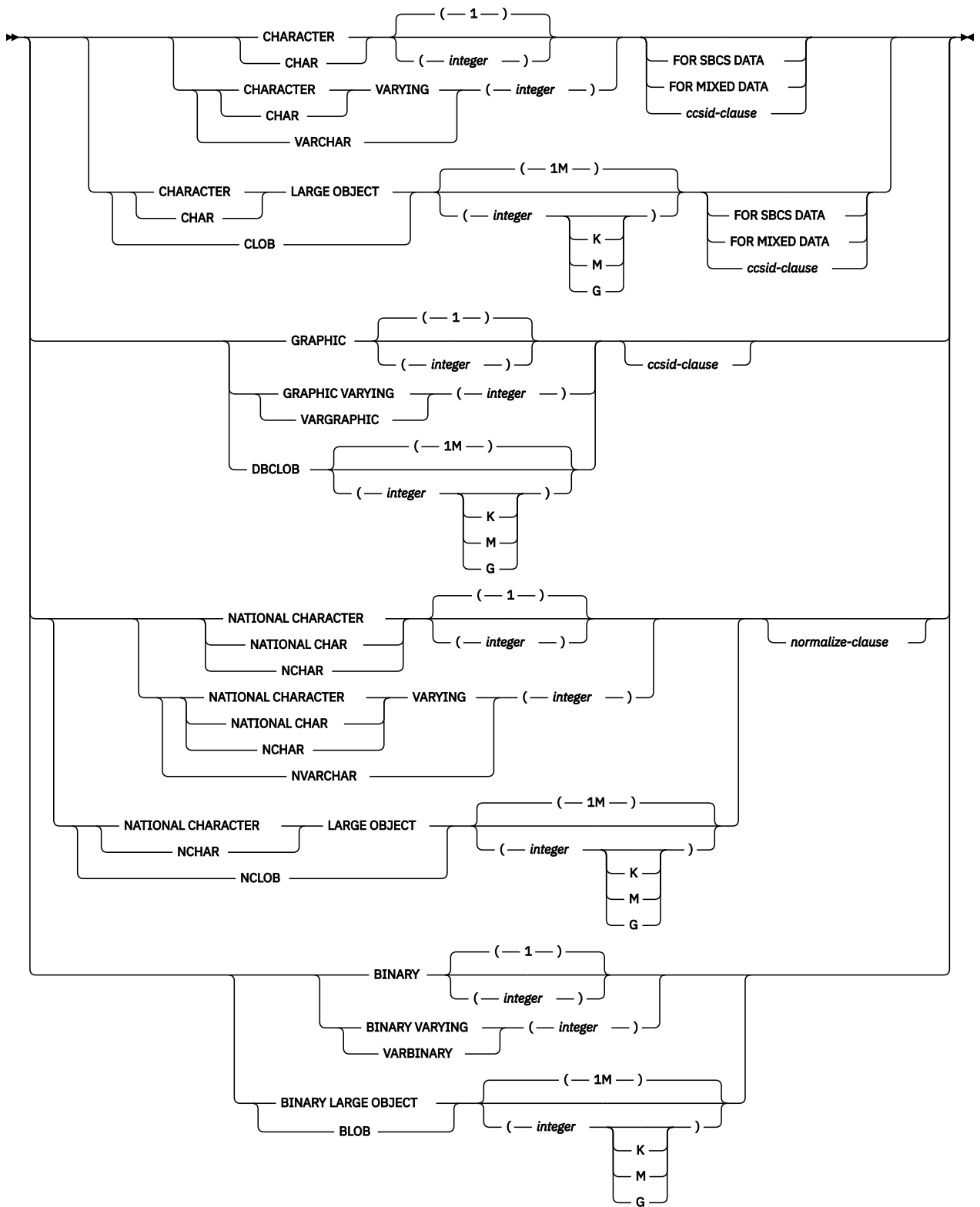

ccsid-clause

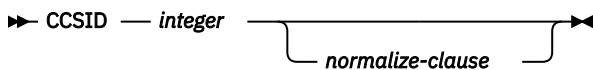

normalize-clause

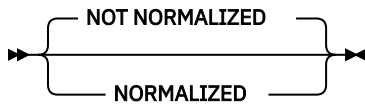

key-name-expression

The name of the JSON key. The name must not be null. When using the colon form for defining a *key:value* pair, *key-name-expression* must be a character string literal. Otherwise, the result of *key-name-expression* must be a built-in character or graphic string data type. It cannot be CHAR or VARCHAR bit data.

JSON-expression

The expression to use to generate the JSON value associated with *key-name-expression*. The result type of this expression can be any built-in data type except XML, ROWID, or DATALINK. It cannot be CHAR or VARCHAR bit data. It cannot be a user-defined type that is sourced on any of these data types.

FORMAT JSON or FORMAT BSON

Specifies whether *JSON-expression* is already formatted data.

FORMAT JSON

JSON-expression is formatted as JSON data. If *JSON-expression* is a character or graphic string data type, it is treated as JSON data. If *JSON-expression* is a binary string data type, it is interpreted as UTF-8 or UTF-16 data.

FORMAT BSON

JSON-expression is formatted as the BSON representation of JSON data and must be a binary string data type.

If neither FORMAT JSON nor FORMAT BSON is specified:

- If *JSON-expression* is one of the built-in functions JSON_ARRAY, JSON_OBJECT, JSON_QUERY, JSON_ARRAYAGG, or JSON_OBJECTAGG, the explicit or implicit FORMAT value of the function's RETURNING clause determines the format of *JSON-expression*.
- If *JSON-expression* is a binary string type, it is interpreted as FORMAT BSON.
- Otherwise, *JSON-expression* is considered unformatted data. If the generated value is not numeric, the result string will be constructed with strings enclosed in quotes and any special characters will be escaped. A numeric value that is not a valid JSON number, such as INFINITY or NAN, will result in an error.

NULL ON NULL or ABSENT ON NULL

Specifies what to return when *JSON-expression* is the null value.

NULL ON NULL

A null value is returned. This is the default.

ABSENT ON NULL

The *key:value* pair is omitted from the JSON object.

WITHOUT UNIQUE KEYS or WITH UNIQUE KEYS

Specifies whether the key values for the resulting JSON object must be unique.

WITHOUT UNIQUE KEYS

The resulting JSON object will not be checked for duplicate keys. This is the default.

WITH UNIQUE KEYS

The resulting JSON object is required to have unique key values. An error will be issued if duplicate keys are generated.

Generating a JSON object with unique keys is considered the best practice. If *key-name-expression* generates unique key names, omit WITH UNIQUE KEYS to improve performance.

RETURNING data-type

Specifies the format of the result.

data-type

The data type of the result. For CHAR and VARCHAR results, the CCSID cannot be 65535. The default is CLOB(2G) CCSID 1208.

If a CCSID is specified and the *data-type* is GRAPHIC, VARGRAPHIC, or DBCLOB, the CCSID must be a Unicode CCSID.

If the CCSID attribute is not specified, the CCSID is determined as described in [“CAST specification” on page 177](#).

FORMAT JSON

JSON data is returned as a JSON string.

ENCODING UTF8 or ENCODING UTF16

The encoding to use when *data-type* is a binary string type. This clause is only allowed for binary string types. The default for binary strings is UTF8.

FORMAT BSON

JSON data is returned in BSON format. When FORMAT BSON is specified, *data-type* must be a VARBINARY or BLOB string type.

The result can be null. If the set of values is empty, the result is the null value.

Example

- Return a JSON object containing the manager numbers for each department. If no manager is assigned, omit the department from the result.

```
SELECT JSON_OBJECTAGG(deptno VALUE mgrno ABSENT ON NULL) FROM dept;
```

The result is the following JSON string. Note that the order of entries in the JSON object is not defined.

```
{ "A00": "000010", "B01": "000020", "C01": "000030", "D11": "000060", "D21": "000070",  
  "E01": "000050", "E11": "000090", "E21": "000100" }
```

- Return a JSON object for each department containing a list of projects assigned to that department.

```
SELECT deptno, JSON_OBJECTAGG(projno VALUE projname) AS projlist FROM proj  
WHERE deptno LIKE 'D%'  
GROUP BY deptno;
```

The result is the following 3 rows. Note that the order of entries in the JSON object is not defined.

DEPTNO	PROJLIST
D01	{ "AD3100": "ADMIN SERVICES", "MA2100": "WELD LINE AUTOMATION" }
D11	{ "MA2110": "W L PROGRAMMING", "MA2111": "W L PROGRAM DESIGN", "MA2112": "W L ROBOT DESIGN", "MA2113": "W L PROD CONT PROGS" }
D21	{ "AD3110": "GENERAL ADMIN SYSTEMS", "AD3111": "PAYROLL PROGRAMMING", "AD3112": "PERSONNEL PROGRAMMING", "AD3113": "ACCOUNT PROGRAMMING" }

LISTAGG

The LISTAGG function aggregates a set of string elements into one string by concatenating the strings. Optionally, a separator string can be provided which is inserted between contiguous input strings.

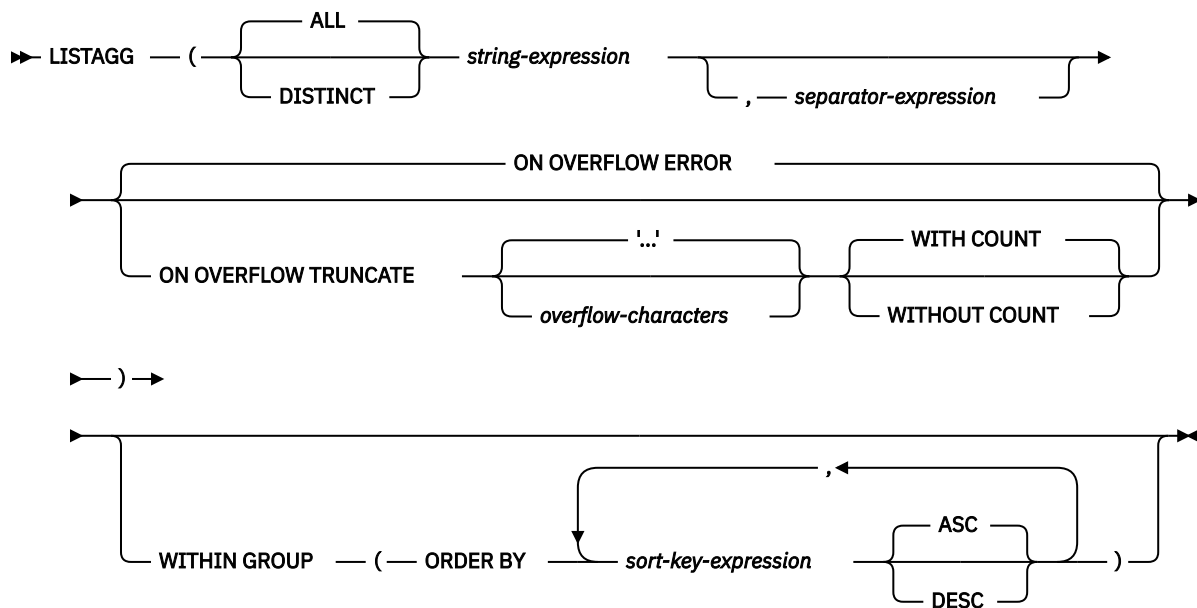

The LISTAGG function aggregates a set of string values for the group into one string by appending the *string-expression* values based on the order specified in the WITHIN GROUP clause.

The function is applied to the set of values that are derived from the first argument by the elimination of null values. If DISTINCT is specified, duplicate *string-expression* values are eliminated. If a separator argument is specified that is not the null value, the separator value is inserted between each pair of non-null *string-expression* values.

string-expression

An expression that specifies the string values to be aggregated. The expression must return a value that is a built-in string, numeric, or datetime data type. If the value is a numeric or datetime data type, it is implicitly cast to VARCHAR before the function is evaluated.

separator-expression

An expression that defines the string that is to be used between non-null *string-expression* values. The expression must return a value that is a built-in string, numeric, or datetime data type. If the value is a numeric or datetime data type, it is implicitly cast to VARCHAR before the function is evaluated. *separator-expression* must not contain a scalar-fullselect, a column reference, or a reference to a function that is not deterministic or external action.

If no *separator-expression* is specified or if *separator-expression* is the null value, there is no separation between *string-expression* values.

ON OVERFLOW ERROR or ON OVERFLOW TRUNCATE

Specifies the behavior if the actual length of the aggregated result string exceeds the result length. The default is ON OVERFLOW ERROR.

ON OVERFLOW ERROR

Indicates an error is returned if the actual length of the result string exceeds the result length.

ON OVERFLOW TRUNCATE

Indicates the aggregated result string will be truncated if the actual length of the result string exceeds the result length. The truncation will occur at the end of a string value. The result string will contain complete entries including a final *separator-expression*, if one is defined.

If *string-expression* is a binary string or a non-Unicode graphic string, this option is not allowed.

'...' or overflow-characters

Indicates a character string constant to be appended to the end of the result string to indicate truncation occurred.

'...'

Indicates that three period characters are appended directly after the last complete entry. This is the default.

overflow-characters

Indicates the character string constant to be appended directly after the last complete entry.

WITH COUNT or WITHOUT COUNT

Indicates whether the number of truncated values is included at the end of the result string. The default is WITH COUNT.

WITH COUNT

The number of values truncated from the string is appended to the end of the result string. It is formatted as a number within parentheses. For example, if 10 entries were truncated, (10) is included at the end of the string.

WITHOUT COUNT

No indication of the number of entries that were truncated is returned.

WITHIN GROUP

Indicates that the aggregation will follow the specified ordering within the grouping set.

If WITHIN GROUP is not specified, the ordering of strings within the result is not deterministic.

ORDER BY

Specifies the order of the rows from the same grouping set that are processed in the aggregation. If the ORDER BY clause is not specified, or if the ORDER BY clause cannot differentiate the order of the sort key value, the rows in the same grouping set are arbitrarily ordered.

sort-key-expression

Specifies a sort key value that is either a column name or an expression. The data type of the column or expression must not be a DATALINK or XML value.

The ordering of the aggregated elements is based on the values of the sort keys.

The sum of the length attributes of the *sort-key-expression* must not exceed 3.5 gigabytes.

ASC

Processes the *sort-key-expression* in ascending order. This is the default.

DESC

Processes the *sort-key-expression* in descending order.

If a collating sequence other than *HEX is in effect when the statement that contains the LISTAGG function is executed and the *sort-key-expressions* are SBCS data, mixed data, or Unicode data, then the result is obtained by comparing weighted values. The weighted values are derived by applying the collating sequence to the *sort-key-expressions*.

The result data type of LISTAGG is based on the data type of *string-expression*

<i>Table 48. Determining the result data type and length</i>	
Data type of <i>string-expression</i>	Result data type and length
CHAR(<i>n</i>) or VARCHAR(<i>n</i>)	VARCHAR(MAX(4000, <i>n</i>))
CLOB(<i>n</i>)	CLOB(1M)
GRAPHIC(<i>n</i>) or VARGRAPHIC(<i>n</i>)	VARGRAPHIC(MAX(2000, <i>n</i>))
DBCLOB(<i>n</i>)	DBCLOB(1M)
BINARY(<i>n</i>) or VARBINARY(<i>n</i>)	VARBINARY(MAX(4000, <i>n</i>))

Table 48. Determining the result data type and length (continued)

Data type of <i>string-expression</i>	Result data type and length
BLOB(<i>n</i>)	BLOB(1M)

The result data type can exceed VARCHAR(4000), VARBINARY(4000), or VARGRAPHIC(2000) if a derived size is used to determine the size of the result. The maximum possible value is the maximum for the result data type. The following example yields a return data type of VARCHAR(10000):

```
LISTAGG(CAST(NAME AS VARCHAR(10000)), ',')
```

If the actual length of the aggregated result string exceeds the result length, the behavior is determined by the ON OVERFLOW clause.

The CCSID of the result is the CCSID of *string-expression*.

If a collating sequence other than *HEX is in effect when the statement that contains the LISTAGG function is executed, and the *sort-key-expressions* are SBCS data, mixed data, or Unicode data, then the result is obtained by comparing the weighted values. The weighted values are derived by applying the collating sequence to the *sort-key-expressions*.

The result can be null. If the function is applied to an empty set or all of the *string-expression* values in the set are null values, the result is the null value.

Rules

- LISTAGG cannot be used as part of an OLAP specification.

Example

- Produce an alphabetical list of comma-separated names, grouped by department.

```
SELECT workdept,
       LISTAGG(lastname, ', ') WITHIN GROUP(ORDER BY lastname)
       AS employees
FROM emp
GROUP BY workdept
```

Generates the following result:

```
WORKDEPT  EMPLOYEES
A00       HAAS, HEMMINGER, LUCCHESSI, O'CONNELL, ORLANDO
B01       THOMPSON
C01       KWAN, NATZ, NICHOLLS, QUINTANA
D11       ADAMSON, BROWN, JOHN, JONES, LUTZ, PIANKA, SCOUTTEN, STERN, WALKER
          YAMAMOTO, YOSHIMURA
D21       JEFFERSON, JOHNSON, MARINO, MONTEVERDE, PEREZ, PULASKI, SMITH
E01       GEYER
E11       HENDERSON, PARKER, SCHNEIDER, SCHWARTZ, SETRIGHT, SMITH, SPRINGER
E21       ALONZO, GOUNOT, LEE, MEHTA, SPENSER, WONG
```

MAX

The MAX aggregate function returns the maximum value in a set of values in a group.

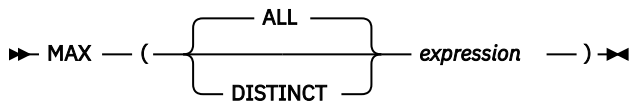

expression

The argument values can be any built-in data type other than a DataLink or XML.

The data type and length attribute of the result are the same as the data type and length attribute of the argument values. When the argument is a string, the result has the same CCSID as the argument.

If a collating sequence other than *HEX is in effect when the statement that contains the MAX function is executed and the arguments are SBCS data, mixed data, or Unicode data, then the result is obtained by comparing weighted values for each value in the set. The weighted values are based on the collating sequence.

The function is applied to the set of values derived from the argument values by the elimination of null values.

The result can be null. If the set of values is empty, the result is a null value. Otherwise, the result is the maximum value in the set.

The specification of DISTINCT has no effect on the result and is not advised.

Notes

Results involving DECFLOAT special values: If the data type of the argument is decimal floating-point and positive or negative Infinity, sNaN, or NaN is found, the maximum value is determined using decimal floating-point ordering rules. See “Numeric comparisons” on page 101. If multiple representations of the same decimal floating-point value are found (for example, 2.00 and 2.0), it is unpredictable which representation will be returned.

Examples

- Using the EMPLOYEE table, set the host variable MAX_SALARY (DECIMAL(7,2)) to the maximum monthly salary (SALARY / 12) value.

```
SELECT MAX(SALARY) /12
INTO :MAX_SALARY
FROM EMPLOYEE
```

Results in MAX_SALARY being set to 4395.83.

- Using the PROJECT table, set the host variable LAST_PROJ (CHAR(24)) to the project name (PROJNAME) that comes last in the sort sequence.

```
SELECT MAX(PROJNAME)
INTO :LAST_PROJ
FROM PROJECT
```

Results in LAST_PROJ being set to 'WELD LINE PLANNING '.

MEDIAN

The MEDIAN function returns the median of a set of numbers.

►► MEDIAN — (— *numeric-expression* —) ►►

numeric-expression

An expression that returns a built-in numeric, character-string, or graphic-string data type. If the argument is a character-string or graphic-string, it is cast to DECFLOAT(34) before evaluating the function.

If the argument is DECFLOAT(*n*), the result of the function is DECFLOAT(34). Otherwise, the result of the function is a double precision floating-point number.

The function is applied to the set of values derived from the argument values by the elimination of null values.

The result can be null. If *numeric-expression* is null or the function is applied to the empty set, the result is the null value.

Notes

When used in an OLAP specification, only the *window-partition-clause* can be specified.

Examples

- Calculate the median salary of the employees in department D11 from the EMPLOYEE table.

```
SELECT MEDIAN(SALARY)
FROM EMPLOYEE
WHERE WORKDEPT = 'D11';
```

The result is 24680.00. Department D11 has 11 employees. The middle row of a group of 11 values is the sixth row. The result of MEDIAN over that group is the value of the sixth row, which is 24680.00.

- Calculate the median salary of the employees in department E21 from the EMPLOYEE table.

```
SELECT MEDIAN(SALARY)
FROM EMPLOYEE
WHERE WORKDEPT = 'E21';
```

The result is 24605.00. Department E21 has six employees. Because there are an even number of rows, the MEDIAN is computed by interpolating a value between the middle two rows. The middle two rows are the third row with the value 23840.00 and the fourth row with the value 25370.00. MEDIAN is computed by averaging those two values, which is 24605.00.

MIN

The MIN aggregate function returns the minimum value in a set of values in a group.

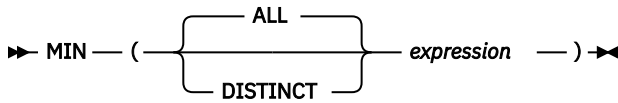

expression

The argument values can be any built-in data type other than a DataLink or XML.

The data type and length attribute of the result are the same as the data type and length attribute of the argument values. When the argument is a string, the result has the same CCSID as the argument. The result can be null.

If a collating sequence other than *HEX is in effect when the statement that contains the MIN function is executed and the arguments are SBCS data, mixed data, or Unicode data, then the result is obtained by comparing weighted values for each value in the set.

The function is applied to the set of values derived from the argument values by the elimination of null values.

If the set of values is empty, the result is a null value. Otherwise, the result is the minimum value in the set.

The specification of DISTINCT has no effect on the result and is not advised.

Notes

Results involving DECFLOAT special values: If the data type of the argument is decimal floating-point and positive or negative Infinity, sNaN, or NaN is found, the minimum value is determined using decimal floating-point ordering rules. See “Numeric comparisons” on page 101. If multiple representations of the same decimal floating-point value are found (for example, 2.00 and 2.0), it is unpredictable which representation will be returned.

Examples

- Using the EMPLOYEE table, set the host variable COMM_SPREAD (DECIMAL(7,2)) to the difference between the maximum and minimum commission (COMM) for the members of department (WORKDEPT) 'D11'.

```
SELECT MAX(COMM) - MIN(COMM)
  INTO :COMM_SPREAD
  FROM EMPLOYEE
  WHERE WORKDEPT = 'D11'
```

Results in COMM_SPREAD being set to 1118 (that is, 2580 - 1462).

- Using the PROJECT table, set the host variable FIRST_FINISHED (CHAR(10)) to the estimated ending date (PRENDATE) of the first project scheduled to be completed.

```
SELECT MIN(PRENDATE)
  INTO :FIRST_FINISHED
  FROM PROJECT
```

Results in FIRST_FINISHED being set to '1982-09-15'.

PERCENTILE_CONT

The PERCENTILE_CONT function returns the value that corresponds to the specified percentile given a sort specification by using a continuous distribution model.

►► PERCENTILE_CONT (— *percentile-expression* —) — WITHIN GROUP (— ORDER BY — ►►

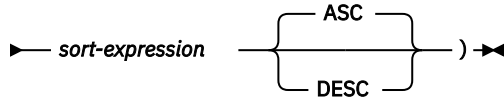

percentile-expression

Specifies the percentile to be calculated by the function. *percentile-expression* must return any built-in numeric, character-string, or graphic-string data type. If the argument is a character-string or graphic-string, it is cast to DECFLOAT(34) before evaluating the function. The value must be between 0 and 1. *percentile-expression* must not contain a *scalar-fullselect*, a column reference, or a user-defined function reference.

WITHIN GROUP

Specifies that the percentile is to be calculated over the rows identified in the group.

sort-expression

Specifies the set of values over which to calculate the percentile as well as the order of the set. *sort-expression* must return a built-in numeric, character string, or graphic string data type. If the *sort-expression* is a character-string or graphic-string, it is cast to DECFLOAT(34) before evaluating the function.

ASC

Specifies that the percentile is to be calculated using values from *sort-expression* in ascending order.

DESC

Specifies that the percentile is to be calculated using values from *sort-expression* in descending order.

The result is the value at the percentile specified by *percentile-expression* over the set of values identified by *sort-expression*. The set of values is treated as a continuous distribution. The calculated percentile is an interpolated value which might not have appeared in the input set. If the data type of *sort-expression* is DECFLOAT(*n*), the result of the function is DECFLOAT(34). Otherwise the data type of the result is double-precision floating point.

The function is applied to the set of values derived from the argument values by the elimination of null values.

The result can be null. If *percentile-expression* is null or if the function is applied to the empty set, the result is the null value.

Notes

When used in an OLAP specification, only the *window-partition-clause* can be specified.

Results involving DECFLOAT special values: If the data type of the argument is decimal floating-point and a special value of sNaN or -sNaN, or both +Infinity and -Infinity are included in the aggregation, an error or warning is returned. Otherwise, if +NaN or -NaN is found, the result is +NaN or -NaN. If +Infinity or -Infinity is found, the result is +Infinity or -Infinity.

Column masks: If a column that is referenced in the *sort-expression* of the PERCENTILE_CONT function is defined to have a column mask, the column mask is not applied.

The result of using PERCENTILE_CONT(0.5) WITHIN GROUP (ORDER BY *sort-expression*) is equivalent to specifying MEDIAN(*sort-expression*).

Examples

- **Example 1:** Calculate the median salary of the employees in department D11.

```
SELECT PERCENTILE_CONT(0.5) WITHIN GROUP (ORDER BY SALARY) FROM EMPLOYEE
WHERE WORKDEPT = 'D11'
```

The result is 24680.00. There are 11 employees in department D11. The middle row of a group of 11 values is the sixth row. Since there are an odd number of rows, PERCENTILE_CONT for the percentile 0.5 returns the value of the sixth row, which is 24680.00.

- **Example 2:** Calculate the median commission of the employees in department E21.

```
SELECT PERCENTILE_CONT(0.5) WITHIN GROUP (ORDER BY COMM) FROM EMPLOYEE
WHERE WORKDEPT = 'E21'
```

The result is 1968.5. Since there are an even number of rows, the PERCENTILE_CONT is computed by interpolating a value between the middle two rows. The middle two rows are row three with value 1907.00 and row four with value 2030.00. PERCENTILE_CONT is computed by averaging those two values, which results in 1968.5.

PERCENTILE_DISC

The PERCENTILE_DISC function returns the value that corresponds to the specified percentile given a sort specification by using a discrete distribution model.

►► PERCENTILE_DISC (— *percentile-expression* —) — WITHIN GROUP (— ORDER BY — ►►

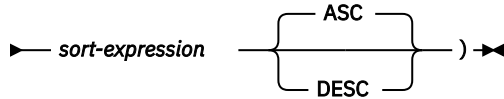

percentile-expression

Specifies the percentile to be calculated by the function. *percentile-expression* must return any built-in numeric, character-string, or graphic-string data type. If the argument is a character-string or graphic-string, it is cast to DECFLOAT(34) before evaluating the function. The value must be between 0 and 1. *percentile-expression* must not contain a *scalar-fullselect*, a column reference, or a user-defined function reference.

WITHIN GROUP

Specifies that the percentile is to be calculated over the rows identified in the group.

sort-expression

Specifies the set of values over which to calculate the percentile as well as the order of the set. *sort-expression* must return a built-in numeric, character string, or graphic string data type.

ASC

Specifies that the percentile is to be calculated using values from *sort-expression* in ascending order.

DESC

Specifies that the percentile is to be calculated using values from *sort-expression* in descending order.

The result is the value at the percentile specified by *percentile-expression* over the set of values identified by *sort-expression*. Each value in the input set is treated as a discrete value. The calculated percentile is always a value that appeared in the input set. The data type of the result is the same as the data type of the result of *sort-expression*.

If a collating sequence other than *HEX is in effect when the statement that contains the PERCENTILE_DISC function is executed, and the *sort-expression* is SBCS data, mixed data, or Unicode data, then the result is determined by comparing the weighted values. The weighted values are derived by applying the collating sequence to the *sort-expression*.

The function is applied to the set of values derived from the argument values by the elimination of null values.

The result can be null. If *percentile-expression* is null or if the function is applied to the empty set, the result is the null value.

Notes

When used in an OLAP specification, only the *window-partition-clause* can be specified.

Results involving DECFLOAT special values: If the data type of the argument is decimal floating-point and a special value of sNaN or -sNaN, or both +Infinity and -Infinity are included in the aggregation, an error or warning is returned. Otherwise, if +NaN or -NaN is found, the result is +NaN or -NaN. If +Infinity or -Infinity is found, the result is +Infinity or -Infinity.

Column masks: If a column that is referenced in the *sort-expression* of the PERCENTILE_DISC function is defined to have a column mask, the column mask is not applied.

Examples

- **Example 1:** Calculate the median salary as a discrete value of the employees in department D11.

```
SELECT PERCENTILE_DISC(0.5) WITHIN GROUP (ORDER BY SALARY)
FROM EMPLOYEE
WHERE WORKDEPT = 'D11'
```

The result is 24680.00. There are 11 employees in department D11. The middle row of a group of 11 values is the sixth row. Since there are an odd number of rows, PERCENTILE_DISC for the percentile 0.5 returns the value of the sixth row, which is 24680.00.

- **Example 2:** Calculate the median commission as a discrete value of the employees in department E21.

```
SELECT PERCENTILE_DISC(0.5) WITHIN GROUP (ORDER BY COMM)
FROM EMPLOYEE
WHERE WORKDEPT = 'E21'
```

The result is 1907.00. Since there are an even number of rows, PERCENTILE_DISC is computed by returning the first of the two middle rows, which is row three with value 1907.00.

Regression functions

The regression functions support the fitting of an ordinary-least-squares regression line of the form $y = a * x + b$ to a set of number pairs. The first element of each pair (*expression1*) is interpreted as a value of the dependent variable (that is, a "y value"). The second element of each pair (*expression2*) is interpreted as a value of the independent variable (that is, an "x value").

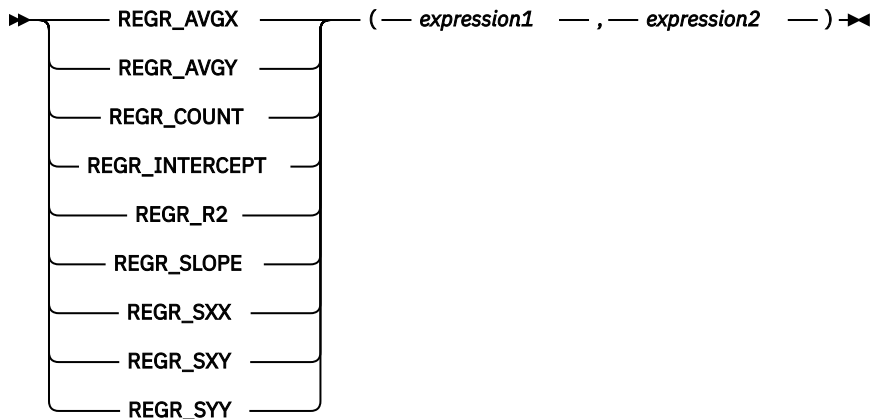

expression1

An expression that returns a value of any built-in numeric, character-string, or graphic-string data type. If the argument is a character-string or graphic-string, it is cast to DECFLOAT(34) before evaluating the function.

expression2

An expression that returns a value of any built-in numeric, character-string, or graphic-string data type. If the argument is a character-string or graphic-string, it is cast to DECFLOAT(34) before evaluating the function.

The REGR_COUNT function returns the number of non-null number pairs used to fit the regression line.

The REGR_INTERCEPT function returns the y-intercept of the regression line ("b" in the equation $y = a * x + b$).

The REGR_R2 function returns the coefficient of determination ("R-squared" or "goodness-of-fit") for the regression.

The REGR_SLOPE function returns the slope of the line ("a" in the equation $y = a * x + b$).

The REGR_AVGX, REGR_AVGY, REGR_SXX, REGR_SXY, and REGR_SYY functions return quantities that can be used to compute various diagnostic statistics needed for the evaluation of the quality and statistical validity of the regression model.

The data type of the result of REGR_COUNT is bigint. For the remaining functions, if either argument is DECFLOAT(n), the data type of the result is DECFLOAT(34); otherwise, the data type of the result is double-precision floating-point. If either argument is a special decimal floating-point value, the rules for general arithmetic operations for decimal floating-point apply. See ["General arithmetic operation rules for DECFLOAT" on page 163](#) for more information.

The result can be null. When not null, the result of REGR_R2 is between 0 and 1, and the result of both REGR_SXX and REGR_SYY is non-negative.

Each function is applied to the set of (*expression1*, *expression2*) pairs derived from the argument values by the elimination of all pairs for which either *expression1* or *expression2* is null.

If the set is empty, REGR_COUNT returns zero and the remaining functions return a null value.

If the set is not empty, the functions return results defined as follows:

REGR_COUNT

The number of non-null pairs in the set

REGR_SLOPE

If $VARIANCE(expression2)$ is positive:

$$REGR_SLOPE(expression1, expression2) = \frac{COVARIANCE(expression1, expression2)}{VARIANCE(expression2)}$$

If $VARIANCE(expression2)$ is equal to zero, returns the null value.

REGR_INTERCEPT

If $VARIANCE(expression2)$ is positive:

$$REGR_INTERCEPT(expression1, expression2) = AVG(expression1) - REGR_SLOPE(expression1, expression2) * AVG(expression2)$$

If $VARIANCE(expression2)$ is equal to zero, returns the null value.

REGR_R2

If $VARIANCE(expression2)$ is positive:

- If $VARIANCE(expression1)$ is positive:

$$REGR_R2(expression1, expression2) = \frac{POWER(CORRELATION(expression1, expression2), 2)}$$

- if $VARIANCE(expression1)$ is equal to zero:

$$REGR_R2(expression1, expression2) = 1$$

If $VARIANCE(expression2)$ is equal to zero, returns the null value.

REGR_AVGX

$$REGR_AVGX(expression1, expression2) = AVG(expression2)$$

REGR_AVGY

$$REGR_AVGY(expression1, expression2) = AVG(expression1)$$

REGR_SXX

$$REGR_SXX(expression1, expression2) = REGR_COUNT(expression1, expression2) * VARIANCE(expression2)$$

REGR_SYY

$$REGR_SYY(expression1, expression2) = REGR_COUNT(expression1, expression2) * VARIANCE(expression1)$$

REGR_SXY

$$REGR_SXY(expression1, expression2) = REGR_COUNT(expression1, expression2) * COVARIANCE(expression1, expression2)$$

The order in which the values are aggregated is undefined, but every intermediate result must be within the range of the result data type.

The usual diagnostic statistics that accompany a linear-regression analysis can be computed in terms of the above functions. For example:

$$\begin{aligned} \text{Adjusted R2} & 1 - \left(\frac{1 - REGR_R2}{REGR_COUNT - 1} \right) * \left(\frac{REGR_COUNT - 1}{REGR_COUNT - 2} \right) \\ \text{Standard error} & \sqrt{\frac{REGR_SYY - (POWER(REGR_SXY, 2) / REGR_SXX)}{REGR_COUNT - 2}} \\ \text{Total sum of squares} & REGR_SYY \\ \text{Regression sum of squares} & \frac{POWER(REGR_SXY, 2)}{REGR_SXX} \end{aligned}$$

Residual sum of squares
 (Total sum of squares)-(Regression sum of squares)

t statistic for slope
 $\text{REGR_SLOPE} * \text{SQRT}(\text{REGR_SXX}) / (\text{Standard error})$

t statistic for y-intercept
 $\text{REGR_INTERCEPT} / ((\text{Standard error}) * \text{SQRT}((1/\text{REGR_COUNT})+(\text{POWER}(\text{REGR_AVGX},2)/\text{REGR_SXX})))$

Note

Syntax alternatives: REGR_ICPT can be specified as a synonym for REGR_INTERCEPT.

Example

- Using the EMPLOYEE table, compute an ordinary-least-squares regression line that expresses the bonus of an employee in department (WORKDEPT) 'A00' as a linear function of the employee's salary. Set the host variables SLOPE, ICPT, RSQR to the slope, intercept, and coefficient of determination of the regression line, respectively. Also set the host variables AVGSAL and AVGBONUS to the average salary and average bonus, respectively, of the employees in department 'A00', and set the host variable CNT (integer) to the number of employees in department 'A00' for whom both salary and bonus data are available. Store the remaining regression statistics in host variables SXX, SYY, and SXY.

```
SELECT REGR_SLOPE(BONUS,SALARY), REGR_INTERCEPT(BONUS,SALARY),
       REGR_R2(BONUS,SALARY), REGR_COUNT(BONUS,SALARY),
       REGR_AVGX(BONUS,SALARY), REGR_AVGY(BONUS,SALARY),
       REGR_SXX(BONUS,SALARY), REGR_SYY(BONUS,SALARY),
       REGR_SXY(BONUS,SALARY)
INTO :SLOPE, :ICPT,
      :RSQR, :CNT,
      :AVGSAL, :AVGBONUS,
      :SXX, :SYY,
      :SXY
FROM EMPLOYEE
WHERE WORKDEPT = 'A00'
```

When using the sample table, the host variables are set to the following approximate values:

```
SLOPE:      0.018363799188747826
ICPT:       69.8388031396513
RSQR:       0.9526220829162935
CNT:        5
AVGSAL:     40850.0
AVGBONUS:   820.0
SXX:        4.74575E8
SYY:        168000.0
SXY:        8715000.0
```

STDDEV_POP or STDDEV

The STDDEV_POP function returns the biased standard deviation ($/n$) of a set of numbers.

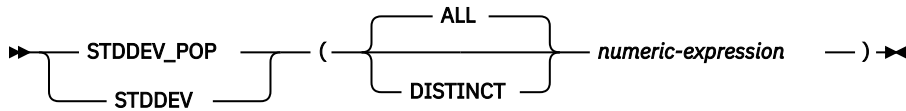

The formula used to calculate the biased standard deviation is:

```
STDDEV_POP = SQRT (VAR_POP)
```

where SQRT(VAR_POP) is the square root of the variance.

numeric-expression

An expression that returns a value of any built-in numeric, character-string, or graphic-string data type. If the argument is a character-string or graphic-string, it is cast to DECFLOAT(34) before evaluating the function.

If the argument is DECFLOAT(n), the result of the function is DECFLOAT(34). Otherwise, the data type of the result is double-precision floating point.

The function is applied to the set of values derived from the argument values by the elimination of null values. If DISTINCT is specified, duplicate values are eliminated.

The result can be null. If the set of values is empty, the result is a null value. Otherwise, the result is the standard deviation of the values in the set.

The order in which the values are added is undefined, but every intermediate result must be within the range of the result data type.

Notes

Results involving DECFLOAT special values: If the data type of the argument is decimal floating-point and a special value of sNaN or -sNaN, or both +Infinity and -Infinity are included in the aggregation, an error or warning is returned. Otherwise, if +NaN or -NaN is found, the result is +NaN or -NaN. If +Infinity or -Infinity is found, the result is +Infinity or -Infinity.

Syntax alternatives: STDEV_POP should be used for conformance to the SQL 2003 standard.

Example

- Using the EMPLOYEE table, set the host variable DEV (double-precision floating point) to the standard deviation of the salaries for those employees in department A00.

```
SELECT STDDEV_POP (SALARY)
INTO :DEV
FROM EMPLOYEE
WHERE WORKDEPT = 'A00';
```

Results in DEV being set to approximately 9742.43.

STDDEV_SAMP

The STDDEV_SAMP function returns the sample standard deviation ($\sqrt{n-1}$) of a set of numbers.

►► STDDEV_SAMP ({ ALL | DISTINCT } numeric-expression) ►►

The formula used to calculate the sample standard deviation is:

```
STDDEV_SAMP = SQRT(VAR_SAMP)
```

where SQRT(VAR_SAMP) is the square root of the sample variance.

numeric-expression

An expression that returns a value of any built-in numeric, character-string, or graphic-string data type. If the argument is a character-string or graphic-string, it is cast to DECFLOAT(34) before evaluating the function.

If the argument is DECFLOAT(n), the result of the function is DECFLOAT(34). Otherwise, the data type of the result is double-precision floating point.

The function is applied to the set of values derived from the argument values by the elimination of null values. If DISTINCT is specified, duplicate values are eliminated.

The result can be null. If the set of values is empty or contains only one row, the result is a null value. Otherwise, the result is the standard deviation of the values in the set.

The order in which the values are added is undefined, but every intermediate result must be within the range of the result data type.

Notes

Results involving DECFLOAT special values: If the data type of the argument is decimal floating-point and a special value of sNaN or -sNaN, or both +Infinity and -Infinity are included in the aggregation, an error or warning is returned. Otherwise, if +NaN or -NaN is found, the result is +NaN or -NaN. If +Infinity or -Infinity is found, the result is +Infinity or -Infinity.

Example

- Using the EMPLOYEE table, set the host variable DEV (double-precision floating point) to the sample standard deviation of the salaries for those employees in department A00.

```
SELECT STDDEV_SAMP(SALARY)
  INTO :DEV
  FROM EMPLOYEE
  WHERE WORKDEPT = 'A00';
```

Results in DEV being set to approximately 10892.37.

SUM

The SUM function returns the sum of a set of numbers.

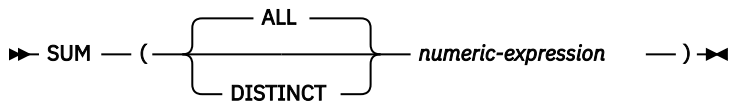

numeric-expression

An expression that returns a value of any built-in numeric, character-string, or graphic-string data type. If the argument is a character-string or graphic-string, it is cast to DECFLOAT(34) before evaluating the function.

The data type of the result is the same as the data type of the argument values except that the result is:

- DECFLOAT(34) if the argument values are DECFLOAT(16).
- A double-precision floating point if the argument values are single-precision floating point
- A large integer if the argument values are small integers
- A decimal with precision *mp* and scale *s* if the argument values are decimal or nonzero scale binary numbers with precision *p* and scale *s*.

For information about the values of *p*, *s*, and *mp*, see [“Decimal arithmetic in SQL” on page 161](#).

The function is applied to the set of values derived from the argument values by the elimination of null values. If DISTINCT is specified, duplicate values are eliminated.

The order in which the values are added is undefined, but every intermediate result must be within the range of the result data type.

Notes

Results involving DECFLOAT special values: If the data type of the argument is decimal floating-point and a special value of sNaN or -sNaN, or both +Infinity and -Infinity are included in the aggregation, an error is signaled. Otherwise, if +NaN or -NaN is found, the result is +NaN or -NaN. If +Infinity or -Infinity is found, the result is +Infinity or -Infinity.

Example

- Using the EMPLOYEE table, set the host variable JOB_BONUS (DECIMAL(9,2)) to the total bonus (BONUS) paid to clerks (JOB='CLERK').

```
SELECT SUM(BONUS)
INTO :JOB_BONUS
FROM EMPLOYEE
WHERE JOB = 'CLERK'
```

Results in JOB_BONUS being set to 4000.

VAR_POP or VARIANCE or VAR

The VAR_POP function returns the biased variance (/n) of a set of numbers.

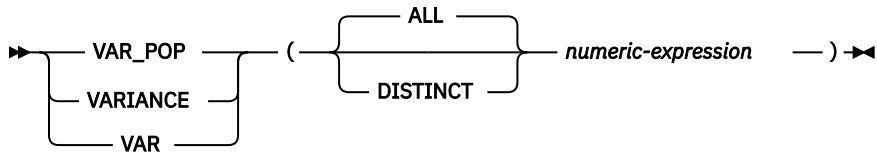

The formula used to calculate the biased variance is:

$$\text{VAR_POP} = \text{SUM}(X**2) / \text{COUNT}(X) - (\text{SUM}(X) / \text{COUNT}(X))**2$$

numeric-expression

An expression that returns a value of any built-in numeric, character-string, or graphic-string data type. If the argument is a character-string or graphic-string, it is cast to DECFLOAT(34) before evaluating the function.

If the argument is DECFLOAT(n), the result of the function is DECFLOAT(34). Otherwise, the data type of the result is double-precision floating point.

The function is applied to the set of values derived from the argument values by the elimination of null values. If DISTINCT is specified, duplicate values are eliminated.

The result can be null. If the set of values is empty, the result is a null value. Otherwise, the result is the variance of the values in the set.

The order in which the values are added is undefined, but every intermediate result must be within the range of the result data type.

Notes

Results involving DECFLOAT special values: If the data type of the argument is decimal floating-point and a special value of sNaN or -sNaN, or both +Infinity and -Infinity are included in the aggregation, an error or warning is returned. Otherwise, if +NaN or -NaN is found, the result is +NaN or -NaN. If +Infinity or -Infinity is found, the result is +Infinity or -Infinity.

Syntax alternatives: VAR_POP should be used for conformance to the SQL 2003 standard.

Example

- Using the EMPLOYEE table, set the host variable VARNCE (double-precision floating point) to the variance of the salaries for those employees in department A00.

```
SELECT VAR_POP(SALARY)
  INTO :VARNCE
  FROM EMPLOYEE
  WHERE WORKDEPT = 'A00';
```

Results in VARNCE being set to approximately 94 915 000.

VAR_SAMP or VARIANCE_SAMP

The VAR_SAMP function returns the sample variance ($/n-1$) of a set of numbers.

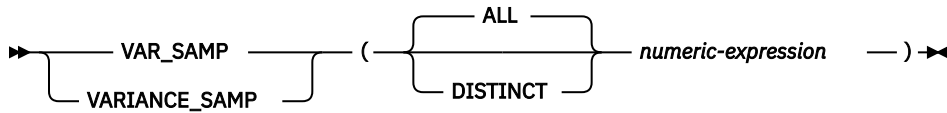

The formula used to calculate the sample variance is:

$$\text{VAR_SAMP} = (\text{SUM}(X**2) - ((\text{SUM}(X)**2) / (\text{COUNT}(X)))) / (\text{COUNT}(X) - 1)$$

numeric-expression

An expression that returns a value of any built-in numeric, character-string, or graphic-string data type. If the argument is a character-string or graphic-string, it is cast to DECFLOAT(34) before evaluating the function.

If the argument is DECFLOAT(n), the result of the function is DECFLOAT(34). Otherwise, the data type of the result is double-precision floating point.

The function is applied to the set of values derived from the argument values by the elimination of null values. If DISTINCT is specified, duplicate values are eliminated.

The result can be null. If the set of values is empty or contains only one row, the result is a null value. Otherwise, the result is the variance of the values in the set.

The order in which the values are added is undefined, but every intermediate result must be within the range of the result data type.

Notes

Results involving DECFLOAT special values: If the data type of the argument is decimal floating-point and a special value of sNaN or -sNaN, or both +Infinity and -Infinity are included in the aggregation, an error or warning is returned. Otherwise, if +NaN or -NaN is found, the result is +NaN or -NaN. If +Infinity or -Infinity is found, the result is +Infinity or -Infinity.

Syntax alternatives: VAR_SAMP should be used for conformance to the SQL 2003 standard.

Example

- Using the EMPLOYEE table, set the host variable VARNCE (double-precision floating point) to the sample variance of the salaries for those employees in department A00.

```
SELECT VAR_SAMP(SALARY)
  INTO :VARNCE
  FROM EMPLOYEE
  WHERE WORKDEPT = 'A00';
```

Results in VARNCE being set to approximately 1 186 437 500.

XMLAGG

The XMLAGG function returns an XML sequence containing an item for each non-null value in a set of XML values.

►► XMLAGG ►►

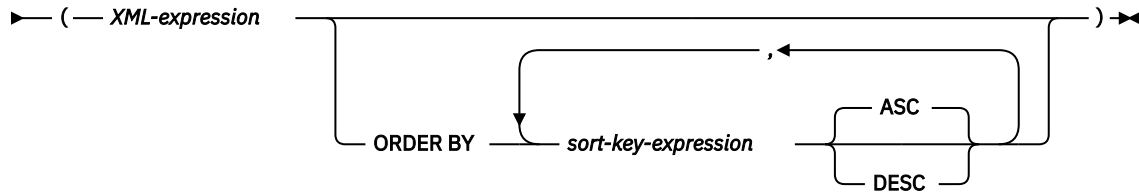

XML-expression

An expression that returns an XML value.

ORDER BY

Specifies the order of the rows from the same grouping set that are processed in the aggregation. If the ORDER BY clause is not specified, or if the ORDER BY clause cannot differentiate the order of the sort key value, the rows in the same grouping set are arbitrarily ordered.

sort-key-expression

Specifies a sort key value that is either a column name or an expression. The data type of the column or expression must not be a DATALINK or XML value.

The ordering is based on the values of the sort keys, which might or might not be used in *XML-expression*.

The sum of the length attributes of the *sort-key-expressions* must not exceed 3.5 gigabytes.

If a collating sequence other than *HEX is in effect when the statement that contains the XMLAGG function is executed and the *sort-key-expressions* are SBCS data, mixed data, or Unicode data, then the result is obtained by comparing weighted values. The weighted values are derived by applying the collating sequence to the *sort-key-expressions*.

The function is applied to the set of values derived from the argument values by elimination of null values.

The data type of the result is XML. The result can be null. If the set of values is empty, the result is the null value. Otherwise, the result is an XML sequence containing an item for each value in the set.

Example

Note: XMLAGG does not insert blank spaces or new line characters in the output. All example output has been formatted to enhance readability.

- Group employees by their department, generate a "Department" element for each department with its name as the attribute, nest all the "emp" elements for employees in each department, and order the "emp" elements by LASTNAME.

```
SELECT XMLSERIALIZE(XMLDOCUMENT (
    XMLELEMENT(NAME "Department",
        XMLATTRIBUTES(E.WORKDEPT AS "name"),
        XMLAGG(XMLELEMENT ( NAME "emp", E.LASTNAME)
            ORDER BY E.LASTNAME)
        ))
    AS CLOB(200)) AS "dept_list"
FROM EMPLOYEE E
WHERE E.WORKDEPT IN ('C01', 'E21')
GROUP BY WORKDEPT
```

The result of the query would look similar to the following result:

```
dept_list
-----
<Department name="C01">
```

```
<emp>KWAN</emp>
<emp>NICHOLLS</emp>
<emp>QUINTANA</emp>
</Department>
<Department name="E21">
  <emp>GOUNOT</emp>
  <emp>LEE</emp>
  <emp>MEHTA</emp>
  <emp>SPENSER</emp>
</Department>
```

XMLGROUP

The XMLGROUP function returns an XML value that is a well-formed XML document.

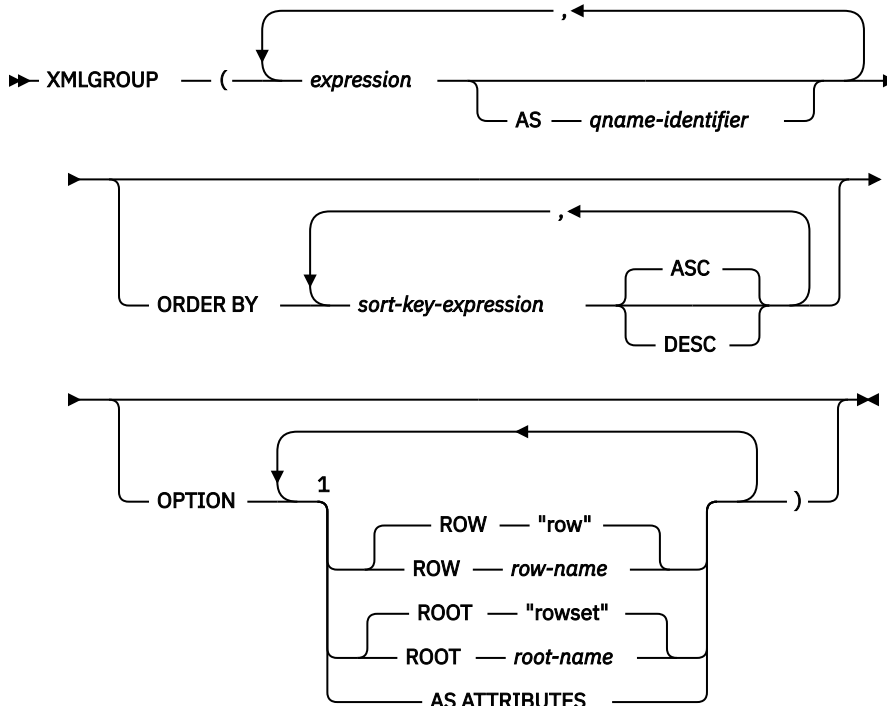

Notes:

¹ The same clause must not be specified more than once.

expression

The content of each XML element is specified by an expression. The data type of *expression* must not be ROWID or DATALINK or a distinct type that is based on ROWID or DATALINK. The expression can be any SQL expression. If the expression is not a simple column reference, an element name must be specified. When AS ATTRIBUTES is specified, the data type of *expression* must not be XML or a distinct type that is based on XML.

AS qname-identifier

Specifies the XML element name or attribute name as an SQL identifier. The *qname-identifier* must be of the form of an XML qualified name, or QName. See the W3C XML namespace specifications for more details on valid names. If the name is qualified, the namespace prefix must be declared within the scope. If *qname-identifier* is not specified, *expression* must be a column name. The element name or attribute name is created from the column name using the fully escaped mapping from a column name to a QName.

ORDER BY

Specifies the order of the rows from the same grouping set that are processed in the aggregation. If the ORDER BY clause is not specified, or if the ORDER BY clause cannot differentiate the order of the sort key value, the rows in the same grouping set are arbitrarily ordered.

sort-key-expression

Specifies a sort key value that is either a column name or an expression. The data type of the column or expression must not be a DATALINK or XML value.

The ordering is based on the values of the sort keys, which might or might not be used in *XML-expression*.

OPTION

Specifies additional options for constructing the XML value. If no OPTION clause is specified, the default behavior applies.

ROW row-name

Specifies the name of the element to which each row is mapped. If this option is not specified, the default element name is "row".

ROOT root-name

Specifies the name of the root element. If this option is not specified, the default root element name is "rowset".

AS ATTRIBUTES

Specifies that each expression is mapped to an attribute value with column name or *qname-identifier* serving as the attribute name.

If a collating sequence other than *HEX is in effect when the statement that contains the XMLGROUP function is executed and the *sort-key-expressions* are SBCS data, mixed data, or Unicode data, then the result is obtained by comparing weighted values. The weighted values are derived by applying the collating sequence to the *sort-key-expressions*.

The result of the function is XML. The result can be null. If the set of values is empty, the result is the null value. Otherwise, the result is an XML sequence containing an item for each value in the set.

Notes

The default behavior defines a simple mapping between a result set and an XML value. Some additional notes about function behavior apply:

- By default, each row is transformed into an XML element named "row" and each *expression* is transformed into a nested element with the column name or *qname-identifier* as the element name.
- The null handling behavior is NULL ON NULL. A null value for an expression maps to the absence of the subelement. If all expression values are null, no row element is generated. If no row elements are generated, the function returns the null value.
- The binary encoding scheme for binary and FOR BIT DATA data types is base64Binary encoding.
- The order of the row subelements in the root element will be the same as the order in which the rows are returned in the query result set.

Examples

Note: XMLGROUP does not insert blank spaces or new line characters in the output. All example output has been formatted to enhance readability.

Assume the following table T1 with columns C1 and C2:

C1	C2
1	2
-	2
1	-
-	-

- The following example shows an XMLGROUP query and output fragment with default behavior, using a single top-level element to represent the table:

```
SELECT XMLGROUP(C1, C2) FROM T1
```

Returns the following value for the single result row:

```
<rowset>
<row><C1>1</C1><C2>2</C2></row>
<row><C2>2</C2></row>
<row><C1>1</C1></row>
</rowset>
```

- The following example shows an XMLGROUP query and output fragment with attribute centric mapping. Instead of appearing as nested elements as in the previous example, the data is mapped to element attributes:

```
SELECT XMLGROUP(C1, C2 OPTION AS ATTRIBUTES) FROM T1
```

Returns the following value for the single result row:

```
<rowset>
<row C1="1" C2="2"/>
<row C2="2"/>
<row C1="1"/>
</rowset>
```

- The following example shows an XMLGROUP query and output fragment with the default <rowset> root element replaced by <document> and the default <row> element replaced by <entry>. Columns C1 and C2 are returned as <column1> and <column2> elements, and the return set is ordered by column C1:

```
SELECT XMLGROUP(C1 AS "column1", C2 AS "column2"
ORDER BY C1 OPTION ROW "entry" ROOT "document")
FROM T1
```

Returns the following value for the single result row:

```
<document>
<entry> <column1>1</column1><column2>2</column2></entry>
<entry> <column1>1</column1></entry>
<entry> <column2>2</column2></entry>
</document>
```

Scalar functions

A *scalar function* takes input argument(s) and returns a single value result. A scalar function can be used wherever an expression can be used.

The restrictions on the use of aggregate functions do not apply to scalar functions, because a scalar function is applied to single parameter values rather than to sets of values. The argument of a scalar function can be a function. However, the restrictions that apply to the use of expressions and aggregate functions also apply when an expression or aggregate function is used within a scalar function. For example, the argument of a scalar function can be an aggregate function only if an aggregate function is allowed in the context in which the scalar function is used.

Example

The result of the following SELECT statement has as many rows as there are employees in department D01:

```
SELECT EMPNO, LASTNAME, YEAR(CURRENT DATE - BIRTHDATE)
FROM EMPLOYEE
WHERE WORKDEPT = 'D01'
```

ABS or ABSVAL

The ABS function returns the absolute value of a number.

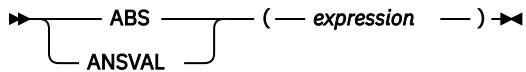

expression

An expression that returns a value of any built-in numeric, character-string, or graphic-string data type. A string argument is cast to double-precision floating point before evaluating the function. For more information about converting strings to double-precision floating point, see [“DOUBLE_PRECISION or DOUBLE” on page 391](#).

The data type of the result is the same as the data type of the argument values except that the result is:

- A double-precision floating point if the argument values are single-precision floating point
- A large integer if the argument values are small integers
- A decimal with precision *mp* and scale *s* if the argument values are decimal or nonzero scale binary numbers with precision *p* and scale *s*.

Note

Results involving DECFloat special values: For decimal floating-point values, the special values are treated as follows:

- `ABS(NaN)` and `ABS(-NaN)` return `NaN`.
- `ABS(Infinity)` and `ABS(-Infinity)` return `Infinity`.
- `ABS(sNaN)` and `ABS(-sNaN)` return `sNaN`.

Example

- Assume the host variable `PROFIT` is a large integer with a value of `-50000`.

```
SELECT ABS (: PROFIT)
FROM SYSIBM.SYSDUMMY1
```

Returns the value 50000.

ACOS

The ACOS function returns the arc cosine of the argument as an angle expressed in radians. The ACOS and COS functions are inverse operations.

►► ACOS (— *expression* —) ◄◄

expression

An expression that returns a value of any built-in numeric data type (except for DECFLOAT), character-string, or graphic-string data type. A string argument is cast to double-precision floating point before evaluating the function. For more information about converting strings to double-precision floating point, see [“DOUBLE_PRECISION or DOUBLE” on page 391](#). The value must be greater than or equal to -1 and less than or equal to 1.

The data type of the result is double-precision floating point. If the argument can be null, the result can be null; if the argument is null, the result is the null value.

The result is greater than or equal to 0 and less than or equal to π .

Example

- Assume the host variable ACOSINE is a DECIMAL(10,9) host variable with a value of 0.070737202.

```
SELECT ACOS (:ACOSINE)
FROM SYSIBM.SYSDUMMY1
```

Returns the approximate value 1.49.

ADD_MONTHS

The ADD_MONTHS function returns a date or timestamp that represents *expression* plus *numeric-expression* months.

►► ADD_MONTHS (— *expression* — , — *numeric-expression* —) ►►

expression

An expression that returns a value of one of the following built-in data types: a date, a timestamp, a character string, or a graphic string.

If *expression* is a character or graphic string, its value must be a valid string representation of a date or timestamp. For the valid formats of string representations of dates and timestamps, see [“String representations of datetime values”](#) on page 75.

numeric-expression

An expression that returns a value of a built-in numeric data type with zero scale. A negative numeric value is allowed.

If *expression* is a timestamp, the result of the function is a timestamp with the same precision as *expression*. Otherwise, the result of the function is a date. If either argument can be null, the result can be null; if either argument is null, the result is the null value.

If *expression* is the last day of the month or if the resulting month has fewer days than the day component of *expression*, then the result is the last day of the resulting month. Otherwise, the result has the same day component as *expression*.

Example

- Assume today is January 31, 2000. Set the host variable ADD_MONTH with the last day of January plus 1 month.

```
SET :ADD_MONTH = ADD_MONTHS(LAST_DAY(CURRENT_DATE), 1 )
```

The host variable ADD_MONTH is set with the value representing the end of February, 2000-02-29.

- Assume DATE is a host variable with the value July 27, 1965. Set the host variable ADD_MONTH with the value of that day plus 3 months.

```
SET :ADD_MONTH = ADD_MONTHS(:DATE, 3)
```

The host variable ADD_MONTH is set with the value representing the day plus 3 months, 1965-10-27.

- It is possible to achieve similar results with the ADD_MONTHS function and date arithmetic. The following examples demonstrate the similarities and contrasts.

```
SET :DATEHV = DATE('2000-2-28') + 4 MONTHS  
SET :DATEHV ADD_MONTHS('2000-2-28', 4)
```

In both cases, the host variable DATEHV is set with the value '2000-06-28'.

Now consider the same examples but with the date '2000-2-29' as the argument.

```
SET :DATEHV = DATE('2000-2-29') + 4 MONTHS
```

The host variable DATEHV is set with the value '2000-06-29'.

```
SET :DATEHV ADD_MONTHS('2000-2-29', 4)
```

The host variable DATEHV is set with the value '2000-06-30'.

In this case, the `ADD_MONTHS` function returns the last day of the month, which is June 30, 2000, instead of June 29, 2000. The reason is that February 29 is the last day of the month. So, the `ADD_MONTHS` function returns the last day of June.

ANTILOG

The ANTILOG function returns the anti-logarithm (base 10) of a number. The ANTILOG and LOG functions are inverse operations.

► ANTILOG (— *expression* —) ◄

expression

An expression that returns a value of any built-in numeric, character-string, or graphic-string data type. A string argument is cast to double-precision floating point before evaluating the function. For more information about converting strings to double-precision floating point, see [“DOUBLE_PRECISION or DOUBLE”](#) on page 391.

If the data type of the argument is DECFLOAT(*n*), the result is DECFLOAT(*n*). Otherwise, the data type of the result is double-precision floating point. If the argument can be null, the result can be null; if the argument is null, the result is the null value.

Note

Results involving DECFLOAT special values: For decimal floating-point values the special values are treated as follows:

- ANTILOG(NaN) returns NaN.
- ANTILOG(-NaN) returns -NaN.
- ANTILOG(Infinity) returns Infinity.
- ANTILOG(-Infinity) returns 0.
- ANTILOG(sNaN) and ANTILOG(-sNaN) return a warning or error.⁵⁰

Example

- Assume the host variable ALOG is a DECIMAL(10,9) host variable with a value of 1.499961866.

```
SELECT ANTILOG(:ALOG)
FROM SYSIBM.SYSDUMMY1
```

Returns the approximate value 31.62.

⁵⁰ If *YES is specified for the SQL_DECFLOAT_WARNINGS query option, NaN and -NaN are returned respectively with a warning.

ARRAY_MAX_CARDINALITY

The ARRAY_MAX_CARDINALITY function returns a value representing the maximum number of elements an array can contain. This is the cardinality specified on the CREATE TYPE (Array) statement for the user-defined array type.

►► ARRAY_MAX_CARDINALITY (*array-expression*) ◄◄

array-expression

The expression can be either an SQL variable or parameter of an array data type, or a cast specification of a parameter marker to an array data type.

The ARRAY_MAX_CARDINALITY function is identical to the MAX_CARDINALITY function. For more information, see [“MAX_CARDINALITY”](#) on page 486.

ARRAY_TRIM

The ARRAY_TRIM function returns a copy of the array argument from which the specified number of elements have been removed from the end of the array.

►► ARRAY_TRIM (*array-variable-name* , *numeric-constant* | *numeric-variable*) ◄◄

The ARRAY_TRIM function is identical to the TRIM_ARRAY function. For more information, see [“TRIM_ARRAY” on page 606](#) .

ASCII

The ASCII function returns the ASCII code value of the leftmost character of the argument as an integer.

►► ASCII — (— *expression* —) ►►

expression

An expression that specifies the string containing the character to evaluate. *expression* must be any built-in numeric or string data type. The first character of the string will be converted to ASCII CCSID 367 for processing by the function.

The result of the function is a large integer. If the argument can be null, the result can be null; if the argument is null, the result is the null value.

Examples

- Return the integer value for the ASCII representation of 'A'.

```
SELECT ASCII('A')
FROM SYSIBM.SYSDUMMY1
```

Returns the value 65.

ASIN

The ASIN function returns the arc sine of the argument as an angle expressed in radians. The ASIN and SIN functions are inverse operations.

►► ASIN — (— *expression* —) ◄◄

expression

An expression that returns a value of any built-in numeric data type (except for DECFLOAT), character-string, or graphic-string data type. A string argument is cast to double-precision floating point before evaluating the function. For more information about converting strings to double-precision floating point, see [“DOUBLE_PRECISION or DOUBLE” on page 391](#). The value must be greater than or equal to -1 and less than or equal to 1.

The data type of the result is double-precision floating point. If the argument can be null, the result can be null; if the argument is null, the result is the null value.

The result is greater than or equal to $-\pi/2$ and less than or equal to $\pi/2$.

Example

- Assume the host variable ASINE is a DECIMAL(10,9) host variable with a value of 0.997494987.

```
SELECT ASIN(:ASINE)
FROM SYSIBM.SYSDUMMY1
```

Returns the approximate value 1.50.

ATAN

The ATAN function returns the arc tangent of the argument as an angle expressed in radians. The ATAN and TAN functions are inverse operations.

►► ATAN (— *expression* —) ◄◄

expression

An expression that returns a value of any built-in numeric data type (except for DECFLOAT), character-string, or graphic-string data type. A string argument is cast to double-precision floating point before evaluating the function. For more information about converting strings to double-precision floating point, see [“DOUBLE_PRECISION or DOUBLE”](#) on page 391.

The data type of the result is double-precision floating point. If the argument can be null, the result can be null; if the argument is null, the result is the null value.

The result is greater than or equal to $-\pi/2$ and less than or equal to $\pi/2$.

Example

- Assume the host variable ATANGENT is a DECIMAL(10,8) host variable with a value of 14.10141995.

```
SELECT ATAN (: ATANGENT)
FROM SYSIBM.SYSDUMMY1
```

Returns the approximate value 1.50.

ATANH

The ATANH function returns the hyperbolic arc tangent of a number, in radians. The ATANH and TANH functions are inverse operations.

►► ATANH (— *expression* —) ◄◄

expression

An expression that returns a value of any built-in numeric data type (except for DECFLOAT), character-string, or graphic-string data type. A string argument is cast to double-precision floating point before evaluating the function. For more information about converting strings to double-precision floating point, see [“DOUBLE_PRECISION or DOUBLE” on page 391](#). The value must be greater than -1 and less than 1.

The data type of the result is double-precision floating point. If the argument can be null, the result can be null; if the argument is null, the result is the null value.

Example

- Assume the host variable HATAN is a DECIMAL(10,9) host variable with a value of 0.905148254.

```
SELECT ATANH(:HATAN)
FROM SYSIBM.SYSDUMMY1
```

Returns the approximate value 1.50.

ATAN2

The ATAN2 function returns the arc tangent of x and y coordinates as an angle expressed in radians. The first and second arguments specify the x and y coordinates, respectively.

►► ATAN2 (— *expression-1* — , — *expression-2* —) ►◄

expression-1

An expression that returns a value of any built-in numeric data type (except for DECFLOAT), character-string, or graphic-string data type. A string argument is cast to double-precision floating point before evaluating the function. For more information on converting strings to double-precision floating point, see [“DOUBLE_PRECISION or DOUBLE” on page 391](#). If one argument is 0, the other argument must not be 0.

expression-2

An expression that returns a value of any built-in numeric data type (except for DECFLOAT), character-string, or graphic-string data type. A string argument is cast to double-precision floating point before evaluating the function. For more information on converting strings to double-precision floating point, see [“DOUBLE_PRECISION or DOUBLE” on page 391](#). If one argument is 0, the other argument must not be 0.

The data type of the result is double-precision floating point. If any argument can be null, the result can be null; if any argument is null, the result is the null value.

Example

- Assume that host variables HATAN2A and HATAN2B are DOUBLE host variables with values of 1 and 2, respectively.

```
SELECT ATAN2 (:HATAN2A, :HATAN2B)
FROM SYSIBM.SYSDUMMY1
```

Returns a double precision floating-point number with an approximate value of 1.1071487.

BIGINT

The BIGINT function returns a big integer representation.

Numeric to Big Integer

►► BIGINT — (— *numeric-expression* —) ►►

String to Big Integer

►► BIGINT — (— *string-expression* —) ►►

Datetime to Big Integer

►► BIGINT — (— *datetime-expression* —) ►►

The BIGINT function returns a big integer representation of:

- A number
- A character or graphic string representation of a decimal number
- A character or graphic string representation of an integer
- A character or graphic string representation of a floating-point number
- A character or graphic string representation of a decimal floating-point number
- A date
- A time
- A timestamp

Numeric to Big Integer

numeric-expression

An expression that returns a numeric value of any built-in numeric data type.

The result is the same number that would occur if the argument were assigned to a big integer column or variable. If the whole part of the argument is not within the range of big integers, an error is returned. The fractional part of the argument is truncated.

String to Big Integer

string-expression

An expression that returns a value that is a character-string or graphic-string representation of a number.

The result is the same number that would result from CAST(*string-expression* AS BIGINT). Leading and trailing blanks are eliminated and the resulting string must conform to the rules for forming a floating-point, decimal floating-point, integer, or decimal constant. If the whole part of the argument is not within the range of big integers, an error is returned. Any fractional part of the argument is truncated.

Datetime to Big Integer

datetime-expression

An expression that is one of the following data types:

- DATE. The result is a BIGINT value representing the date as *yyyymmdd*.
- TIME. The result is a BIGINT value representing the time as *hhmmss*.

- **TIMESTAMP.** The result is a **BIGINT** value representing the timestamp as *yyyymmddhhmmss*. The fractional seconds portion of the timestamp value is not included in the result.

The result of the function is a big integer. If the argument can be null, the result can be null; if the argument is null, the result is the null value.

Note

Syntax alternatives: The **CAST** specification should be used to increase the portability of applications. For more information, see [“CAST specification”](#) on page 177.

Example

- Using the **EMPLOYEE** table, select the **SALARY** column in big integer form for further processing in the application.

```
SELECT BIGINT(SALARY)
FROM EMPLOYEE
```

BINARY

The BINARY function returns a BINARY representation of a string of any type.

►► BINARY — (— *string-expression* — , — *integer* —) ◄◄

The result of the function is a fixed-length binary string. If the first argument can be null, the result can be null; if the first argument is null, the result is the null value.

string-expression

A *string-expression* whose value must be a built-in character string, graphic string, binary string, or row ID data type.

integer

An integer constant that specifies the length attribute for the resulting binary string. The value must be between 1 and 32766.

If *integer* is not specified:

- If the *string-expression* is the empty string constant, the length attribute of the result is 1.
- Otherwise, the length attribute of the result is the same as the length attribute of the first argument, unless the argument is a graphic string. In this case, the length attribute of the result is twice the length attribute of the argument.

The actual length is the same as the length attribute of the result. If the length of the *string-expression* is less than the length of the result, the result is padded with hexadecimal zeroes up to the length of the result. If the length of the *string-expression* is greater than the length attribute of the result, truncation is performed. A warning (SQLSTATE 01004) is returned unless the first input argument is a character string and all the truncated characters are blanks, or the first input argument is a graphic string and all the truncated characters are double-byte blanks, or the first input argument is a binary string and all the truncated bytes are hexadecimal zeroes.

Note

Syntax alternatives: The CAST specification should be used to increase the portability of applications when the length is specified. For more information, see [“CAST specification” on page 177](#).

Example

- The following function returns a BINARY for the string 'This is a BINARY'.

```
SELECT BINARY('This is a BINARY')
FROM SYSIBM.SYSDUMMY1
```

BITAND, BITANDNOT, BITOR, BITXOR, and BITNOT

These bitwise functions operate on the "two's complement" representation of the integer value of the input arguments and return the result as a corresponding base 10 integer value in a data type based on the data type of the input arguments.

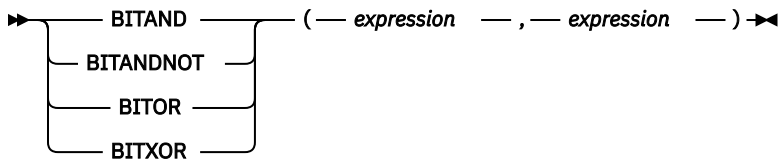

>>> BITNOT (— expression —) <<<

Function	Description	A bit in the two's complement representation of the result is:
BITAND	Performs a bitwise AND operation.	1 only if the corresponding bits in both arguments are 1.
BITANDNOT	Clears any bit in the first argument that is in the second argument.	Zero if the corresponding bit in the second argument is 1; otherwise, the result is copied from the corresponding bit in the first argument.
BITOR	Performs a bitwise OR operation.	1 unless the corresponding bits in both arguments are zero.
BITXOR	Performs a bitwise exclusive OR operation.	1 unless the corresponding bits in both arguments are the same.
BITNOT	Performs a bitwise NOT operation.	Opposite of the corresponding bit in the argument.

expression

An expression that returns a value of any built-in numeric data type. Arguments of type DECIMAL, REAL, or DOUBLE are cast to DECFLOAT. The value is truncated to a whole number.

The bit manipulation functions can operate on up to 16 bits for SMALLINT, 32 bits for INTEGER, 64 bits for BIGINT, and 113 bits for DECFLOAT. The range of supported DECFLOAT values includes integers from -2^{112} to $2^{112} - 1$, and special values such as NaN or INFINITY are not supported. If the two arguments have different data types, the argument supporting fewer bits is cast to a value with the data type of the argument supporting more bits. This cast impacts the bits that are set for negative values. For example, -1 as a SMALLINT value has 16 bits set to 1, which when cast to an INTEGER value has 32 bits set to 1.

The result of the functions with two arguments has the data type of the argument that is highest in the data type precedence list for promotion. If either argument is DECFLOAT, the data type of the result is DECFLOAT(34). If either argument can be null, the result can be null; if either argument is null, the result is the null value.

The result of the BITNOT function has the same data type as the input argument, except that DECIMAL, REAL, DOUBLE, or DECFLOAT(16) returns DECFLOAT(34). If the argument can be null, the result can be null; if the argument is null, the result is the null value.

Use of the BITXOR function is recommended to toggle bits in a value. Use the BITANDNOT function to clear bits. BITANDNOT(val, pattern) operates more efficiently than BITAND(val, BITNOT(pattern)).

Example

The following examples are based on an ITEM table with a PROPERTIES column of type INTEGER.

- Return all items for which the third property bit is set.

```
SELECT ITEMID FROM ITEM
WHERE BITAND(PROPERTIES, 4) = 4
```

- Return all items for which the fourth or the sixth property bit is set.

```
SELECT ITEMID FROM ITEM
WHERE BITAND(PROPERTIES, 40) <> 0
```

- Clear the twelfth property of the item whose ID is 3412.

```
UPDATE ITEM
SET PROPERTIES = BITANDNOT(PROPERTIES, 2048)
WHERE ITEMID = 3412
```

- Set the fifth property of the item whose ID is 3412.

```
UPDATE ITEM
SET PROPERTIES = BITOR(PROPERTIES, 16)
WHERE ITEMID = 3412
```

- Toggle the eleventh property of the item whose ID is 3412.

```
UPDATE ITEM
SET PROPERTIES = BITXOR(PROPERTIES, 1024)
WHERE ITEMID = 3412
```

- Switch all the bits in a 16-bit value that has only the second bit on.

```
VALUES BITNOT(CAST(2 AS SMALLINT))
```

returns -3 (with a data type of SMALLINT).

BIT_LENGTH

The BIT_LENGTH function returns the length of a string expression in bits.

►► BIT_LENGTH (— *expression* —) ►◄

See “LENGTH” on page 469 , “CHARACTER_LENGTH or CHAR_LENGTH” on page 330 , and “OCTET_LENGTH” on page 515 for similar functions.

expression

An expression that returns a value of any built-in numeric or string data type. A numeric argument is cast to a character string before evaluating the function. For more information about converting numeric to a character string, see “VARCHAR” on page 616.

The result of the function is DECIMAL(31). If the argument can be null, the result can be null; if the argument is null, the result is the null value.

The result is the number of bits (bytes * 8) in the argument. The length of a string includes trailing blanks. The length of a varying-length string is the actual length in bits (bytes * 8), not the maximum length.

Example

- Assume table T1 has a GRAPHIC(10) column called C1.

```
SELECT BIT_LENGTH( C1 )  
FROM T1
```

Returns the value 160.

BLOB

The BLOB function returns a BLOB representation of a string of any type.

►► BLOB ((*string-expression* , *integer*) ►►

string-expression

A *string-expression* whose value can be a character string, graphic string, binary string, or row ID.

integer

An integer constant that specifies the length attribute for the resulting binary string. The value must be between 1 and 2 147 483 647.

If *integer* is not specified:

- If the *string-expression* is the empty string constant, the length attribute of the result is 1.
- Otherwise, the length attribute of the result is the same as the length attribute of the first argument, unless the argument is a graphic string. In this case, the length attribute of the result is twice the length attribute of the argument.

The actual length of the result is the minimum of the length attribute of the result and the actual length of the expression (or twice the length of the expression when the input is graphic data). If the length of the *string-expression* is greater than the length attribute of the result, truncation is performed. A warning (SQLSTATE 01004) is returned unless the first input argument is a character string and all the truncated characters are blanks, or the first input argument is a graphic string and all the truncated characters are double-byte blanks, or the first input argument is a binary string and all the truncated bytes are hexadecimal zeroes.

The result of the function is a BLOB. If the first argument can be null, the result can be null; if the first argument is null, the result is the null value.

Note

Syntax alternatives: The CAST specification should be used to increase the portability of applications when the length is specified. For more information, see [“CAST specification” on page 177](#).

Example

- The following function returns a BLOB for the string 'This is a BLOB'.

```
SELECT BLOB('This is a BLOB')
FROM SYSIBM.SYSDUMMY1
```

- The following function returns a BLOB for the large object that is identified by locator myclob_locator.

```
SELECT BLOB(:myclob_locator)
FROM SYSIBM.SYSDUMMY1
```

- Assume that a table has a BLOB column named TOPOGRAPHIC_MAP and a VARCHAR column named MAP_NAME. Locate any maps that contain the string 'Pellow Island' and return a single binary string with the map name concatenated in front of the actual map. The following function returns a BLOB for the large object that is identified by locator myclob_locator.

```
SELECT BLOB( MAP_NAME CONCAT ': ' CONCAT TOPOGRAPHIC_MAP )
FROM ONTARIO_SERIES_4
WHERE TOPOGRAPHIC_MAP LIKE '%Pellow Island%'
```

BSON_TO_JSON

The `BSON_TO_JSON` function converts a string containing formatted BSON data to a character string containing the data formatted as JSON.

►► `BSON_TO_JSON` — (— *JSON-expression* —) ◄◄

JSON-expression

Specifies an expression that returns a binary string value. It must contain formatted BSON data.

If *JSON-expression* is a JSON object with a key name of `SYSIBM_ROOT_ARRAY`, the key will be removed and the result will be the key's value.

If *JSON-expression* contains duplicate keys, the duplicate keys are retained in the result JSON string.

The data type of the result is `CLOB(2G)` with a `CCSID` of 1208.

If the argument can be null, the result can be null; if the argument is null, the result is the null value.

Note

If the outer JSON object's key is `SYSIBM_ROOT_ARRAY`, the key will be removed and the result will be the value of the key.

Example

- Insert a value that contains data formatted as BSON into a column that holds JSON values.

```
INSERT INTO TABLE1 (JSON_COLUMN) VALUES (BSON_TO_JSON(:BSON_DATA));
```

CARDINALITY

The `CARDINALITY` function returns a value representing the number of elements of an array.

►► `CARDINALITY` — (— *array-expression* —) ►►

array-expression

The expression can be either an SQL variable or parameter of an array data type, or a cast specification of a parameter marker to an array data type.

The value returned by the `CARDINALITY` function is the highest array index for which the array has an assigned element. This includes elements that have been assigned the null value.

The result of the function is `BIGINT`. The function returns 0 if the array is empty. The result can be null; if the argument is null, the result is the null value.

Example

Assume that array type `PHONENUMBERS` and array variable `RECENT_CALLS` are defined as follows:

```
CREATE TYPE PHONENUMBERS AS INTEGER ARRAY[50];  
DECLARE RECENT_CALLS PHONENUMBERS;
```

`RECENT_CALLS` contains three elements. The following `SET` statement assigns the number of calls that have been stored in the array so far to SQL variable `HOWMANYCALLS`:

```
SET HOWMANYCALLS = CARDINALITY(RECENT_CALLS)
```

After the statement executes, `HOWMANYCALLS` contains 3.

CEILING or CEIL

The CEILING or CEIL function returns the smallest integer value that is greater than or equal to *expression*.

► **CEILING** (*expression*) ►
 CEIL

expression

An expression that returns a value of any built-in numeric, character-string, or graphic-string data type. A string argument is cast to double-precision floating point before evaluating the function. For more information about converting strings to double-precision floating point, see [“DOUBLE_PRECISION or DOUBLE” on page 391](#).

The result of the function has the same data type and length attribute as the argument except that the scale is 0 if the argument is a decimal number. For example, an argument with a data type of DECIMAL(5,5) will result in DECIMAL(5,0).

If the argument can be null, the result can be null; if the argument is null, the result is the null value.

Note

Results involving DECFLOAT special values: For decimal floating-point values, the special values are treated as follows:

- CEILING(NaN) returns NaN.
- CEILING(-NaN) returns -NaN.
- CEILING(Infinity) returns Infinity.
- CEILING(-Infinity) returns -Infinity.
- CEILING(sNaN) and CEILING(-sNaN) return a warning or error.⁵¹

Examples

- Find the highest monthly salary for all the employees. Round the result up to the next integer. The SALARY column has a decimal data type

```
SELECT CEIL(MAX(SALARY)/12)
FROM EMPLOYEE
```

This example returns 4396.00 because the highest paid employee is Christine Haas who earns \$52750.00 per year. Her average monthly salary before applying the CEIL function is 4395.83.

- Use CEILING on both positive and negative numbers.

```
SELECT CEILING( 3.5),
       CEILING( 3.1),
       CEILING(-3.1),
       CEILING(-3.5)
FROM SYSIBM.SYSDUMMY1
```

This example returns:

```
04.    04.   -03.   -03.
```

⁵¹ If *YES is specified for the SQL_DECFLOAT_WARNINGS query option, NaN and -NaN are returned respectively with a warning.

CHAR

The CHAR function returns a fixed-length character-string representation.

Integer to Character

►► CHAR (— *integer-expression* —) ►►

Decimal to Character

►► CHAR (— *decimal-expression* — , — *decimal-character* —) ►►

Floating-point to Character

►► CHAR (— *floating-point-expression* — , — *decimal-character* —) ►►

Decimal floating-point to Character

►► CHAR (— *decimal-floating-point-expression* — , — *decimal-character* —) ►►

Character to Character

►► CHAR (— *character-expression* — , — *length* — , — *integer* —) ►►

►►) ►►

Graphic to Character

►► CHAR (— *graphic-expression* — , — *length* — , — *integer* —) ►►

Datetime to Character

►► CHAR (— *datetime-expression* — , — *ISO* — , — *USA* — , — *EUR* — , — *JIS* — , — *LOCAL* —) ►►

The CHAR function returns a fixed-length character-string representation of:

- An integer number if the first argument is a SMALLINT, INTEGER, or BIGINT.
- A decimal number if the first argument is a decimal number.
- A double-precision floating-point number if the first argument is a DOUBLE or REAL.
- A decimal floating-point number if the first argument is a DECFLOAT.

- A character string if the first argument is any type of character string.
- A graphic string if the first argument is any type of graphic string.
- A date value if the first argument is a DATE.
- A time value if the first argument is a TIME.
- A timestamp value if the first argument is a TIMESTAMP.
- A row ID value if the first argument is a ROWID.

The result of the function is a fixed-length character string. If the first argument can be null, the result can be null; if the first argument is null, the result is the null value.

Integer to Character

integer-expression

An expression that returns a value that is a built-in integer data type (either SMALLINT, INTEGER, or BIGINT).

The result is the fixed-length character-string representation of the argument in the form of an SQL integer constant. The result consists of n characters that are the significant digits that represent the value of the argument with a preceding minus sign if the argument is negative. The result is left justified.

- If the argument is a small integer:

The length of the result is 6. If the number of characters in the result is less than 6, then the result is padded on the right with blanks.

- If the argument is a large integer:

The length of the result is 11. If the number of characters in the result is less than 11, then the result is padded on the right with blanks.

- If the argument is a big integer:

The length of the result is 20. If the number of characters in the result is less than 20, then the result is padded on the right with blanks.

The CCSID of the result is the default SBCS CCSID at the current server.

Decimal to Character

decimal-expression

An expression that returns a value that is a built-in decimal data type (either DECIMAL or NUMERIC). If a different precision and scale is wanted, the DECIMAL scalar function can be used to make the change.

decimal-character

Specifies the single-byte character constant that is used to delimit the decimal digits in the result character string. The character must be a period or comma. If the second argument is not specified, the decimal point is the default decimal point. For more information, see [“Decimal point” on page 118](#).

The result is a fixed-length character string representation of the argument. The result includes a decimal character and up to p digits, where p is the precision of the *decimal-expression* with a preceding minus sign if the argument is negative. Leading zeros are not returned. Trailing zeros are returned. If the scale of *decimal-expression* is zero, the decimal character is not returned.

The length of the result is $2+p$ where p is the precision of the *decimal-expression*. This means that a positive value will always include one trailing blank.

The CCSID of the result is the default SBCS CCSID at the current server.

Floating-point to Character

floating-point expression

An expression that returns a value that is a built-in floating-point data type (DOUBLE or REAL).

decimal-character

Specifies the single-byte character constant that is used to delimit the decimal digits in the result character string. The character must be a period or comma. If the second argument is not specified, the decimal point is the default decimal point. For more information, see [“Decimal point” on page 118](#).

The result is a fixed-length character-string representation of the argument in the form of a floating-point constant. The length of the result is 24. If the argument is negative, the first character of the result is a minus sign. Otherwise, the first character is a digit or the *decimal-character*. If the argument is zero, the result is 0E0. Otherwise, the result includes the smallest number of characters that can be used to represent the value of the argument such that the mantissa consists of a single digit other than zero followed by a *decimal-character* and a sequence of digits.

If the number of characters in the result is less than 24, then the result is padded on the right with blanks.

The CCSID of the result is the default SBCS CCSID at the current server.

Decimal floating-point to Character

decimal-floating-point expression

An expression that returns a value that is a built-in decimal floating-point data type (DECFLOAT).

decimal-character

Specifies the single-byte character constant that is used to delimit the decimal digits in the result character string. The character must be a period or comma. If the second argument is not specified, the decimal point is the default decimal point. For more information, see [“Decimal point” on page 118](#).

The result is a fixed-length character-string representation of the argument in the form of a decimal floating-point constant.

The length attribute of the result is 42. The actual length of the result is the smallest number of characters that represents the value of the argument, including the sign, digits, and *decimal-character*. Trailing zeros are significant. If the argument is negative, the first character of the result is a minus sign; otherwise, the first character is a digit or the *decimal-character*. If the argument is zero, the result is 0.

If the DECFLOAT value is Infinity, sNaN, or NaN, the strings 'INFINITY', 'SNAN', and 'NAN', respectively, are returned. If the special value is negative, a minus sign will be the first character in the string. The DECFLOAT special value sNaN does not result in an exception when converted to a string.

If the number of characters in the result is less than 42, then the result is padded on the right with blanks.

The CCSID of the result is the default SBCS CCSID at the current server.

Character to Character

character-expression

An expression that returns a value that is a built-in character-string data type.⁵²

length

An integer constant that specifies the length attribute for the resulting fixed length character string. The value must be between 1 and 32766 (32765 if nullable). If the first argument is DBCS-only mixed data, the second argument cannot be less than 4.

If the second argument is not specified or DEFAULT is specified:

- If the *character-expression* is the empty string constant, the length attribute of the result is 1.
- Otherwise, the length attribute of the result is the same as the length attribute of the first argument.

⁵² A binary string is also allowed if a CCSID is not specified or if a CCSID of 65535 is explicitly specified.

The actual length is the same as the length attribute of the result. If the length of the *character-expression* is less than the length attribute of the result, the result is padded with blanks up to the length of the result. If the length of the *character-expression* is greater than the length attribute of the result, truncation is performed. A warning (SQLSTATE 01004) is returned unless the truncated characters were all blanks.

integer

An integer constant that specifies the CCSID of the result. It must be a valid SBCS CCSID, mixed data CCSID, or 65535 (bit data). If the third argument is an SBCS CCSID, then the result is SBCS data. If the third argument is a mixed CCSID, then the result is mixed data and the length attribute of the result cannot be less than 4. If the third argument is 65535, then the result is bit data. If the third argument is a SBCS CCSID, then the first argument cannot be a DBCS-either or DBCS-only string.

If the third argument is not specified then:

- If the first argument is SBCS data, then the result is SBCS data. The CCSID of the result is the same as the CCSID of the first argument.
- If the first argument is mixed data and the length attribute of the result is greater than or equal to 4, then the result is mixed data. The CCSID of the result is the same as the CCSID of the first argument.
- If the first argument is mixed data that is DBCS-open or DBCS-either and the length attribute of the result is less than 4, the CCSID of the result is the associated SBCS CCSID for the mixed data CCSID.

Graphic to Character

graphic-expression

An expression that returns a value that is a built-in graphic-string data type. It must not be DBCS-graphic data.

length

An integer constant that specifies the length attribute for the resulting fixed length character string. The value must be between 1 and 32766 (32765 if nullable).

If the second argument is not specified or DEFAULT is specified:

- If the *graphic-expression* is the empty string constant, the length attribute of the result is 1.
- If the result is SBCS data, the result length is n .
- If the result is mixed data, the result length is $(2.5*(n-1)) + 4$.

The actual length is the same as the length attribute of the result. If the length of the *graphic-expression* is less than the length of the result, the result is padded with blanks up to the length of the result. If the length of the *graphic-expression* is greater than the length attribute of the result, truncation is performed. A warning (SQLSTATE 01004) is returned unless the truncated characters were all blanks.

integer

An integer constant that specifies the CCSID of the result. It must be a valid SBCS CCSID or mixed data CCSID. If the third argument is an SBCS CCSID, then the result is SBCS data. If the third argument is a mixed CCSID, then the result is mixed data and the length attribute of the result cannot be less than 4. The third argument cannot be 65535.

If the third argument is not specified, the CCSID of the result is the default CCSID at the current server. If the default CCSID is mixed data and the length attribute of the result is greater than or equal to 4, then the result is mixed data. Otherwise, the result is SBCS data.

Datetime to Character

datetime-expression

An expression that is one of the following three built-in data types

date

The result is the character-string representation of the date in the format specified by the second argument. If the second argument is not specified, the format used is the default date format. If

the format is ISO, USA, EUR, or JIS, the length of the result is 10. Otherwise the length of the result is the length of the default date format. For more information see [“String representations of datetime values”](#) on page 75.

time

The result is the character-string representation of the time in the format specified by the second argument. If the second argument is not specified, the format used is the default time format. The length of the result is 8. For more information see [“String representations of datetime values”](#) on page 75.

timestamp

The second argument is not applicable and must not be specified.

The result is the character-string representation of the timestamp. If *datetime-expression* is a `TIMESTAMP(0)`, the length of the result is 19. If the data type of *datetime-expression* is a `TIMESTAMP(n)`, the length of the result is 20+n. Otherwise the length of the result is 26.

The CCSID of the result is the default SBCS CCSID at the current server.

ISO, EUR, USA, or JIS

Specifies the date or time format of the resulting character string. For more information, see [“String representations of datetime values”](#) on page 75.

LOCAL

Specifies that the date or time format of the resulting character string should come from the `DATFMT`, `DATSEP`, `TIMFMT`, and `TIMSEP` attributes of the job at the current server.

Note

Syntax alternatives: The `CAST` specification should be used to increase the portability of applications when the first argument is a string and the length argument is specified. For more information, see [“CAST specification”](#) on page 177.

Examples

- Assume the column `PRSTDATE` has an internal value equivalent to 1988-12-25. The date format is `*MDY` and the date separator is a slash (/).

```
SELECT CHAR(PRSTDATE, USA)
FROM PROJECT
```

Results in the value '12/25/1988'.

```
SELECT CHAR(PRSTDATE)
FROM PROJECT
```

Results in the value '12/25/88'.

- Assume the column `STARTING` has an internal value equivalent to 17.12.30, the host variable `HOUR_DUR` (`DECIMAL(6,0)`) is a time duration with a value of 050000 (that is, 5 hours).

```
SELECT CHAR(STARTING, USA)
FROM CL_SCHED
```

Results in the value '5:12 PM'.

```
SELECT CHAR(STARTING + :HOUR_DUR, JIS)
FROM CL_SCHED
```

Results in the value '10:12:00'.

- Assume the column `RECEIVED` (timestamp) has an internal value equivalent to the combination of the `PRSTDATE` and `STARTING` columns.

```
SELECT CHAR(RECEIVED)
FROM IN_TRAY
```

Results in the value '1988-12-25-17.12.30.000000'.

- Use the CHAR function to make the type fixed-length character and reduce the length of the displayed results to 10 characters for the LASTNAME column (defined as VARCHAR(15)) of the EMPLOYEE table.

```
SELECT CHAR(LASTNAME, 10)  
FROM EMPLOYEE
```

For rows having a LASTNAME with a length greater than 10 characters (excluding trailing blanks), a warning (SQLSTATE 01004) that the value is truncated is returned.

- Use the CHAR function to return the values for EDLEVEL (defined as SMALLINT) as a fixed length string.

```
SELECT CHAR(EDLEVEL)  
FROM EMPLOYEE
```

An EDLEVEL of 18 would be returned as the CHAR(6) value '18 ' (18 followed by 4 blanks).

- Assume that the same SALARY subtracted from 20000.25 is to be returned with a comma as the decimal character.

```
SELECT CHAR(20000.25 - SALARY, ',')  
FROM EMPLOYEE
```

A SALARY of 21150 returns the value '-1149,75 ' (-1149,75 followed by 3 blanks).

- Assume a host variable, DOUBLE_NUM, has a double precision floating-point data type and a value of -987.654321E-35.

```
SELECT CHAR(:DOUBLE_NUM)  
FROM SYSIBM.SYSDUMMY1
```

Results in the character value '-9.8765432100000002E-33 '.

CHARACTER_LENGTH or CHAR_LENGTH

The CHARACTER_LENGTH or CHAR_LENGTH function returns the length of a string expression.

► CHARACTER_LENGTH (— *expression* —) ◄
CHAR_LENGTH

See “LENGTH” on page 469 for a similar function.

expression

An expression that returns a value of any built-in numeric or string data type. A numeric argument is cast to a character string before evaluating the function. For more information about converting numeric to a character string, see “VARCHAR” on page 616.

The result of the function is a large integer. If the argument can be null, the result can be null; if the argument is null, the result is the null value.

If *expression* is a character string or graphic string, the result is the number of characters in the argument (not the number of bytes). A single character is either an SBCS, DBCS, or multiple-byte character. If *expression* is a binary string, the result is the number of bytes in the argument. The length of strings includes trailing blanks or hexadecimal zeroes. The length of a varying-length string is the actual length, not the maximum length.

Example

- Assume that NAME is a VARCHAR(128) column, encoded in Unicode UTF-8, that contains the value 'Jürgen'.

```
SELECT CHARACTER_LENGTH(NAME), LENGTH(NAME)
FROM T1
WHERE NAME = 'Jürgen'
```

Returns the value 6 for CHARACTER_LENGTH and 7 for LENGTH.

CHR

The CHR function returns the EBCDIC character that has the ASCII code value specified by the argument. If expression is 0, the result is the blank character.

►► CHR — (— *expression* —) ◄◄

expression

An expression that returns a value of a BIGINT, INTEGER, or SMALLINT data type. The value of the argument should be between 0 and 255; otherwise, the return value is null. The value is interpreted as the code point for a character in ASCII CCSID 367.

The result of the function is CHAR(1). The result can be null; if the argument is null, the result is the null value.

The CCSID of the result is the default SBCS CCSID of the current server.

Examples

- Return the EBCDIC character corresponding to the ASCII CCSID 367 code point 65.

```
SELECT CHR(65)
FROM SYSIBM.SYSDUMMY1
```

Returns the value 'A'.

CLOB

The CLOB function returns a character-string representation.

Integer to CLOB

►► CLOB (— *integer-expression* —) ►►

Decimal to CLOB

►► CLOB (— *decimal-expression* — , — *decimal-character* —) ►►

Floating-point to CLOB

►► CLOB (— *floating-point-expression* — , — *decimal-character* —) ►►

Decimal floating-point to CLOB

►► CLOB (— *decimal-floating-point-expression* — , — *decimal-character* —) ►►

Character to CLOB

►► CLOB (— *character-expression* — , — *length* — , — *integer* —) ►►

►►) ►►

Graphic to CLOB

►► CLOB (— *graphic-expression* — , — *length* — , — *integer* —) ►►

Datetime to CLOB

►► CLOB (— *datetime-expression* — , — *ISO* — , — *USA* — , — *EUR* — , — *JIS* — , — *LOCAL* —) ►►

The CLOB function returns a character-string representation of:

- An integer number if the first argument is a SMALLINT, INTEGER, or BIGINT
- A decimal number if the first argument is a packed or zoned decimal number
- A double-precision floating-point number if the first argument is a DOUBLE or REAL
- A decimal floating-point number if the first argument is DECFLOAT

- A character string if the first argument is any type of character string
- A graphic string if the first argument is a Unicode graphic string
- A date value if the first argument is a DATE.
- A time value if the first argument is a TIME.
- A timestamp value if the first argument is a TIMESTAMP.

The result of the function is a CLOB. If the first argument can be null, the result can be null; if the first argument is null, the result is the null value.

Integer to CLOB

integer-expression

An expression that returns a value that is a built-in integer data type (either SMALLINT, INTEGER, or BIGINT).

The result is a varying-length character string of the argument in the form of an SQL integer constant. The result consists of n characters that are the significant digits that represent the value of the argument with a preceding minus sign if the argument is negative. The result is left justified.

- If the argument is a small integer, the length attribute of the result is 6.
- If the argument is a large integer, the length attribute of the result is 11.
- If the argument is a big integer, the length attribute of the result is 20.

The actual length of the result is the smallest number of characters that can be used to represent the value of the argument. Leading zeroes are not included. If the argument is negative, the first character of the result is a minus sign. Otherwise, the first character is a digit or the *decimal-character*.

The CCSID of the result is the default SBCS CCSID at the current server.

Decimal to CLOB

decimal-expression

An expression that returns a value that is a built-in decimal data type (either DECIMAL or NUMERIC). If a different precision and scale is wanted, the DECIMAL scalar function can be used to make the change.

decimal-character

Specifies the single-byte character constant that is used to delimit the decimal digits in the result character string. The character must be a period or comma. If the second argument is not specified, the decimal point is the default decimal point. For more information, see [“Decimal point” on page 118](#).

The result is a varying-length character string representation of the argument. The result includes a decimal character and up to p digits, where p is the precision of the *decimal-expression* with a preceding minus sign if the argument is negative. Leading zeros are not returned. Trailing zeros are returned. If the scale of *decimal-expression* is zero, the decimal character is not returned.

The length attribute of the result is $2+p$ where p is the precision of the *decimal-expression*. The actual length of the result is the smallest number of characters that can be used to represent the result, except that trailing characters are included. Leading zeros are not included. If the argument is negative, the result begins with a minus sign. Otherwise, the result begins with a digit or the *decimal-character*.

The CCSID of the result is the default SBCS CCSID at the current server.

Floating-point to CLOB

floating-point expression

An expression that returns a value that is a built-in floating-point data type (DOUBLE or REAL).

decimal-character

Specifies the single-byte character constant that is used to delimit the decimal digits in the result character string. The character must be a period or comma. If the second argument is not specified, the decimal point is the default decimal point. For more information, see [“Decimal point” on page 118](#).

The result is a varying-length character string representation of the argument in the form of a floating-point constant.

The length attribute of the result is 24. The actual length of the result is the smallest number of characters that can represent the value of the argument such that the mantissa consists of a single digit other than zero followed by the *decimal-character* and a sequence of digits. If the argument is negative, the first character of the result is a minus sign; otherwise, the first character is a digit or the *decimal-character*. If the argument is zero, the result is 0E0.

The CCSID of the result is the default SBCS CCSID at the current server.

Decimal floating-point to CLOB

decimal floating-point expression

An expression that returns a value that is a built-in decimal floating-point data type.

decimal-character

Specifies the single-byte character constant that is used to delimit the decimal digits in the result character string. The character must be a period or comma. If the second argument is not specified, the decimal point is the default decimal point. For more information, see [“Decimal point” on page 118](#).

The result is a varying-length character string representation of the argument in the form of a decimal floating-point constant.

The length attribute of the result is 42. The actual length of the result is the smallest number of characters that represents the value of the argument, including the sign, digits, and *decimal-character*. Trailing zeros are significant. If the argument is negative, the first character of the result is a minus sign; otherwise, the first character is a digit or the *decimal-character*. If the argument is zero, the result is 0.

If the DECFLOAT value is Infinity, sNaN, or NaN, the strings 'INFINITY', 'SNAN', and 'NAN', respectively, are returned. If the special value is negative, a minus sign will be the first character in the string. The DECFLOAT special value sNaN does not result in an exception when converted to a string.

The CCSID of the result is the default SBCS CCSID at the current server.

Character to CLOB

character-expression

An expression that returns a value that is a built-in character-string data type.

length

An integer constant that specifies the length attribute for the resulting varying length character string. The value must be between 1 and 2 147 483 647. If the first argument is DBCS-only mixed data, the second argument cannot be less than 4.

If the second argument is not specified or DEFAULT is specified:

- If the *character-expression* is the empty string constant, the length attribute of the result is 1.
- Otherwise, the length attribute of the result is the same as the length attribute of the first argument.

The actual length of the result is the minimum of the length attribute of the result and the actual length of *character-expression*. If the length of the *character-expression* is greater than the length attribute of the result, truncation is performed. A warning (SQLSTATE 01004) is returned unless the truncated characters were all blanks.

integer

An integer constant that specifies the CCSID of the result. It must be a valid SBCS CCSID or mixed data CCSID. If the third argument is an SBCS CCSID, then the result is SBCS data. If the third argument is a mixed CCSID, then the result is mixed data and the length attribute of the result cannot be less than 4. If the third argument is a SBCS CCSID, then the first argument cannot be a DBCS-either or DBCS-only string. The third argument cannot be 65535.

If the third argument is not specified, the first argument must not have a CCSID of 65535:

- If the first argument is bit data, an error is returned.
- If the first argument is SBCS data, then the result is SBCS data. The CCSID of the result is the same as the CCSID of the first argument.
- If the first argument is mixed data and the result length is greater than or equal to 4, then the result is mixed data. The CCSID of the result is the same as the CCSID of the first argument.
- If the first argument is mixed data that is DBCS-open or DBCS-either and the length attribute of the result is less than 4, the CCSID of the result is the associated SBCS CCSID for the mixed data CCSID.

Graphic to CLOB

graphic-expression

An expression that returns a value that is a built-in graphic-string data type. It must not be DBCS-graphic data.

length

An integer constant that specifies the length attribute for the resulting varying length character string. The value must be between 1 and 2 147 483 647. If the result is mixed data, the second argument cannot be less than 4.

If the second argument is not specified or DEFAULT is specified, the length attribute of the result is determined as follows (where n is the length attribute of the first argument):

- If the *graphic-expression* is the empty graphic string constant, the length attribute of the result is 1.
- If the result is SBCS data, the result length is n .
- If the result is mixed data, the result length is $(2.5*(n-1)) + 4$.

The actual length of the result is the minimum of the length attribute of the result and the actual length of *graphic-expression*. If the length of the *graphic-expression* is greater than the length attribute of the result, truncation is performed. A warning (SQLSTATE 01004) is returned unless the truncated characters were all blanks.

integer

An integer constant that specifies the CCSID of the result. It must be a valid SBCS CCSID or mixed data CCSID. If the third argument is an SBCS CCSID, then the result is SBCS data. If the third argument is a mixed CCSID, then the result is mixed data and the length attribute of the result cannot be less than 4. The third argument cannot be 65535.

If the third argument is not specified, the CCSID of the result is the default CCSID at the current server. If the default CCSID is mixed data and the length attribute of the result is greater than or equal to 4, then the result is mixed data. Otherwise, the result is SBCS data.

Datetime to CLOB

datetime-expression

An expression that is one of the following three built-in data types

date

The result is a varying-length character string representation of the date in the format specified by the second argument. If the second argument is not specified, the format used is the default date format. If the format is ISO, USA, EUR, or JIS, the length of the result is 10. Otherwise the length of the result is the length of the default date format. For more information see [“String representations of datetime values” on page 75](#).

time

The result is a varying-length character string representation of the time in the format specified by the second argument. If the second argument is not specified, the format used is the default time format. The length of the result is 8. For more information see [“String representations of datetime values”](#) on page 75.

timestamp

The second argument is not applicable and must not be specified.

The result is a varying-length character string representation of the timestamp. If *datetime-expression* is a `TIMESTAMP(0)`, the length of the result is 19. If the data type of *datetime-expression* is a `TIMESTAMP(n)`, the length of the result is 20+n. Otherwise, the length of the result is 26.

The CCSID of the result is the default SBCS CCSID at the current server.

ISO, EUR, USA, or JIS

Specifies the date or time format of the resulting character string. For more information, see [“String representations of datetime values”](#) on page 75.

LOCAL

Specifies that the date or time format of the resulting character string should come from the `DATFMT`, `DATSEP`, `TIMFMT`, and `TIMSEP` attributes of the job at the current server.

Note

Syntax alternatives: `TO_CLOB` is a synonym for `CLOB`.

The `CAST` specification should be used to increase the portability of applications when the first argument is a string and the length attribute is specified. For more information, see [“CAST specification”](#) on page 177.

Example

- The following function returns a CLOB for the string 'This is a CLOB'.

```
SELECT CLOB('This is a CLOB')
FROM SYSIBM.SYSDUMMY1
```

COALESCE

The COALESCE function returns the value of the first non-null expression.

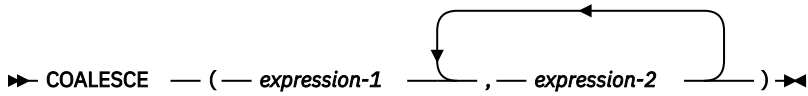

The arguments must be compatible. Character-string arguments are compatible with datetime values. For more information about data type compatibility, see [“Assignments and comparisons” on page 91](#).

expression-1

An expression that returns a value of any built-in or user-defined data type. ⁵³

expression-2

An expression that returns a value of any built-in or user-defined data type. ⁵³

The arguments are evaluated in the order in which they are specified, and the result of the function is the first argument that is not null. The result can be null only if all arguments can be null, and the result is null only if all arguments are null.

The selected argument is converted, if necessary, to the attributes of the result. The attributes of the result are determined by all the operands as explained in [“Rules for result data types” on page 107](#).

Note

Syntax alternatives: NVL and VALUE are synonyms for COALESCE.

Examples

- When selecting all the values from all the rows in the DEPARTMENT table, if the department manager (MGRNO) is missing (that is, null), then return a value of 'ABSENT'.

```
SELECT DEPTNO, DEPTNAME, COALESCE(MGRNO, 'ABSENT'), ADMRDEPT
FROM DEPARTMENT
```

- When selecting the employee number (EMPNO) and salary (SALARY) from all the rows in the EMPLOYEE table, if the salary is missing (that is null), then return a value of zero.

```
SELECT EMPNO, COALESCE(SALARY, 0)
FROM EMPLOYEE
```

⁵³ This function cannot be used as a source function when creating a user-defined function. Because it accepts any compatible data types as arguments, it is not necessary to create additional signatures to support strongly typed distinct types.

COMPARE_DECFLOAT

The COMPARE_DECFLOAT function returns an ordering for DECFLOAT values.

►► COMPARE_DECFLOAT (— *expression-1* — , — *expression-2* —) ►►

The COMPARE_DECFLOAT function returns a small integer value that indicates how *expression-1* compares with *expression-2*.

expression-1

An expression that returns a value of any built-in numeric, character-string, or graphic-string data type. If the argument is not DECFLOAT(34), it is logically converted to DECFLOAT(34) for processing.

expression-2

An expression that returns a value of any built-in numeric, character-string, or graphic-string data type. If the argument is not DECFLOAT(34), it is logically converted to DECFLOAT(34) for processing.

The first argument is compared with the second argument and the result is returned according to the following rules.

- If both operands are finite, the comparison is algebraic and follows the rules for DECFLOAT subtraction. If the difference is exactly zero with either sign and with the same number of zeroes to the right of the decimal point, the arguments are equal. If a nonzero difference is positive, the first argument is greater than the second argument. If a nonzero difference is negative, the first argument is less than the second.
- Positive zero and negative zero compare equal.
- Positive Infinity compares equal to positive infinity.
- Positive Infinity compares greater than any finite number.
- Negative Infinity compares equal to negative infinity.
- Negative Infinity compares less than any finite number.
- Numeric comparison is exact. The result is determined for finite operands as if range and precision were unlimited. Overflow or underflow cannot occur.
- If either argument is a NaN or sNaN (positive or negative), the result is unordered.

The result value is set as follows:

0	if the arguments are exactly equal.
1	if <i>expression-1</i> is less than <i>expression-2</i> .
2	if <i>expression-1</i> is greater than <i>expression-2</i> .
3	if the arguments are unordered.

The result of the function is SMALLINT. If either argument can be null, the result can be null; if either argument is null, the result is the null value.

Examples

The following examples demonstrate the values that will be returned when the function is used:

```
COMPARE_DECFLOAT (DECFLOAT(2.17), DECFLOAT(2.17)) = 0
COMPARE_DECFLOAT (DECFLOAT(2.17), DECFLOAT(2.170)) = 2
COMPARE_DECFLOAT (DECFLOAT(2.170), DECFLOAT(2.17)) = 1
COMPARE_DECFLOAT (DECFLOAT(2.17), DECFLOAT(0.0)) = 2
COMPARE_DECFLOAT (INFINITY, INFINITY) = 0
COMPARE_DECFLOAT (INFINITY, -INFINITY) = 2
COMPARE_DECFLOAT (DECFLOAT(-2), INFINITY) = 1
COMPARE_DECFLOAT (NAN, NAN) = 3
COMPARE_DECFLOAT (DECFLOAT(-0.1), SNAN) = 3
```

CONCAT

The CONCAT function combines two arguments.

►► CONCAT (— *expression-1* — , — *expression-2* —) ◄◄

The arguments must be compatible. For more information about data type compatibility, see [“Assignments and comparisons” on page 91](#).

expression-1

An expression that returns a value of any built-in numeric, datetime, or string data type. A numeric or datetime argument is cast to a character string before evaluating the function. For more information about converting numeric or datetime to a character string, see [“VARCHAR” on page 616](#).

expression-2

An expression that returns a value of any built-in numeric, datetime, or string data type. A numeric or datetime argument is cast to a character string before evaluating the function. For more information about converting numeric or datetime to a character string, see [“VARCHAR” on page 616](#).

The result of the function is a string that consists of the first argument string followed by the second. The data type of the result is determined by the data types of the arguments. For more information, see [“With the concatenation operator” on page 164](#). If either argument can be null, the result can be null; if either argument is null, the result is the null value.

Note

Syntax alternatives: The CONCAT function is identical to the CONCAT operator. For more information, see [“With the concatenation operator” on page 164](#).

Example

- Concatenate the column FIRSTNAME with the column LASTNAME.

```
SELECT CONCAT (FIRSTNAME, LASTNAME)
FROM EMPLOYEE
WHERE EMPNO = '000010'
```

Returns the value 'CHRISTINEHAAS'.

CONTAINS

The CONTAINS function searches a text search index using criteria that are specified in a search argument and returns a result about whether or not a match was found.

►► CONTAINS ►►

► (— *column-name* — , — *search-argument* — , — *search-argument-options* —) ►►

search-argument-options

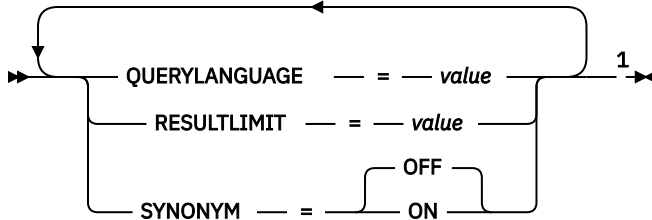

Notes:

¹ The same clause must not be specified more than once.

column-name

Specifies a qualified or unqualified name of a column that has a text search index that is to be searched. The column must exist in the table or view that is identified in the FROM clause in the statement and the column of the table, or the column of the underlying base table of the view must have an associated text search index. The underlying expression of the column of a view must be a simple column reference to the column of an underlying table, directly or through another nested view.

search-argument

An expression that returns a character-string data type or graphic-string data type that contains the terms to be searched for. It must not be the empty string or contain all blanks. The actual length of the string must not exceed 32 740 bytes after conversion to Unicode and must not exceed the text search limitations or number of terms as specified in the search argument syntax. For information on *search-argument* syntax, see [Appendix G, “Text search argument syntax,” on page 1979](#).

search-argument-options

A character string or graphic string value that contains the search argument options to use for the search. It must be a constant or a variable.

The options that can be specified as part of the *search-argument-options* are:

QUERYLANGUAGE = value

Specifies the language value. The value can be any of the supported language codes. If QUERYLANGUAGE is not specified, the default is the language value of the text search index that is used when the function is invoked. If the language value of the text search index is AUTO, the default value for QUERYLANGUAGE is en_US. For more information on the query language option, see [“Text search language options” on page 1989](#).

RESULTLIMIT = value

Specifies the maximum number of results that are to be returned from the underlying search engine. The *value* must be an integer from 1 to 2 147 483 647. If RESULTLIMIT is not specified, no result limit is in effect for the query.

CONTAINS may or may not be called for each row of the result table, depending on the plan that the optimizer chooses. If CONTAINS is called once for the query to the underlying search engine, a result set of all of the ROWIDs or primary keys that match are returned from the search engine. This result set is then joined to the table containing the column to identify the result rows. In this case, the RESULTLIMIT value acts like a FETCH FIRST *n* ROWS ONLY from the underlying text

search engine and can be used as an optimization. If CONTAINS is called for each row of the result because the optimizer determines that is the best plan, then the RESULTLIMIT option has no effect.

SYNONYM = OFF or SYNONYMN = ON

Specifies whether to use a synonym dictionary associated with the text search index. The default is OFF.

OFF

Do not use a synonym dictionary.

ON

Use the synonym dictionary associated with the text search index.

If *search-argument-options* is the empty string or the null value, the function is evaluated as if *search-argument-options* were not specified.

The result of the function is a large integer. If *search-argument* can be null, the result can be null; if *search-argument* is null, the result is the null value.

The result is 1 if the column contains a match for the search criteria specified by the *search-argument*. Otherwise, the result is 0. If the column contains the null value, the result is 0.

CONTAINS is a non-deterministic function.

Notes

Prerequisites: In order to use the CONTAINS and SCORE functions, OmniFind Text Search Server for DB2 for i must be installed and started.

Rules: If a view, nested table expression, or common table expression provides a text search column for a CONTAINS or SCORE scalar function and the applicable view, nested table expression, or common table expression has a DISTINCT clause on the outermost SELECT, the SELECT list must contain all the corresponding key fields of the text search index.

If a view, nested table expression, or common table expression provides a text search column for a CONTAINS or SCORE scalar function, the applicable view, nested table expression, or common table expression cannot have a UNION, EXCEPT, or INTERSECT at the outermost SELECT.

If a common table expression provides a text search column for a CONTAINS or SCORE scalar function, the common table expression cannot be subsequently referenced again in the entire query unless that reference does not provide a text search column for a CONTAINS or SCORE scalar function.

CONTAINS and SCORE scalar functions are not allowed if the query specifies:

- a distributed table,
- a table with a read trigger, or
- a logical file built over multiple physical file members.

Examples

- The following statement finds all of the employees who have "COBOL" in their resume. The text search argument is not case-sensitive.

```
SELECT EMPNO
FROM EMP_RESUME
WHERE RESUME_FORMAT = 'ascii'
AND CONTAINS(RESUME, 'cobol') = 1
```

- Find 10 students at random whose online essay contains the phrase "fossil fuel" in Spanish, that is "combustible fósil", to be invited for a radio interview. Since any 10 students can be selected, optimize the query to using RESULTLIMIT to limit the number of results from the search.

```
SELECT FIRSTNAME, LASTNAME
FROM STUDENT_ESSAYS
```

```
WHERE CONTAINS(TERM_PAPER, 'combustible fósil',  
               'QUERYLANGUAGE = es_ES RESULTLIMIT = 10 SYNONYM = ON') = 1
```

- Find the string 'ate' in the COMMENT column. Use a host variable to supply the search argument.

```
char search_arg[100];  
...  
EXEC SQL DECLARE C1 CURSOR FOR  
SELECT CUSTKEY  
FROM CUSTOMERS  
WHERE CONTAINS(COMMENT, :search_arg) = 1  
ORDER BY CUSTKEY;  
strcpy(search_arg, "ate");  
EXEC SQL OPEN C1;
```

COS

The COS function returns the cosine of the argument, where the argument is an angle expressed in radians. The COS and ACOS functions are inverse operations.

►► COS — (— *expression* —) ◄◄

expression

An expression that returns a value of any built-in numeric data type (except for DECFLOAT), character-string, or graphic-string data type. A string argument is cast to double-precision floating point before evaluating the function. For more information about converting strings to double-precision floating point, see [“DOUBLE_PRECISION or DOUBLE”](#) on page 391.

The data type of the result is double-precision floating point. If the argument can be null, the result can be null; if the argument is null, the result is the null value.

Example

- Assume the host variable COSINE is a DECIMAL(2,1) host variable with a value of 1.5.

```
SELECT COS (:COSINE)
FROM SYSIBM.SYSDUMMY1
```

Returns the approximate value 0.07.

COSH

The COSH function returns the hyperbolic cosine of the argument, where the argument is an angle expressed in radians.

►► COSH (— *expression* —) ◄◄

expression

An expression that returns a value of any built-in numeric data type (except for DECFLOAT), character-string, or graphic-string data type. A string argument is cast to double-precision floating point before evaluating the function. For more information about converting strings to double-precision floating point, see [“DOUBLE_PRECISION or DOUBLE”](#) on page 391.

The data type of the result is double-precision floating point. If the argument can be null, the result can be null; if the argument is null, the result is the null value.

Example

- Assume the host variable HCOS is a DECIMAL(2,1) host variable with a value of 1.5.

```
SELECT COSH (:HCOS)
FROM SYSIBM.SYSDUMMY1
```

Returns the approximate value 2.35.

COT

The COT function returns the cotangent of the argument, where the argument is an angle expressed in radians.

►► COT — (— *expression* —) ◄◄

expression

An expression that returns a value of any built-in numeric data type (except for DECFLOAT), character-string, or graphic-string data type. A string argument is cast to double-precision floating point before evaluating the function. For more information about converting strings to double-precision floating point, see [“DOUBLE_PRECISION or DOUBLE”](#) on page 391.

The data type of the result is double-precision floating point. If the argument can be null, the result can be null; if the argument is null, the result is the null value.

Example

- Assume the host variable COTAN is a DECIMAL(2,1) host variable with a value of 1.5.

```
SELECT COT(:COTAN)
FROM SYSIBM.SYSDUMMY1
```

Returns the approximate value 0.07.

CURDATE

The CURDATE function returns a date based on a reading of the time-of-day clock when the SQL statement is executed at the current server. The value returned by the CURDATE function is the same as the value returned by the CURRENT DATE special register.

►► CURDATE — (—) ►►

The data type of the result is a date. The result cannot be null.

If this function is used more than once within a single SQL statement, or used with the CURTIME or NOW scalar functions or the CURRENT_DATE, CURRENT_TIME, or CURRENT_TIMESTAMP special registers within a single statement, all values are based on a single clock reading.

Note

Syntax alternatives: The CURRENT_DATE special register should be used for maximal portability. For more information, see [“Special registers”](#) on page 121.

Example

- Return the current date based on the time-of-day clock.

```
SELECT CURDATE()  
FROM SYSIBM.SYSDUMMY1
```

CURTIME

The CURTIME function returns a time based on a reading of the time-of-day clock when the SQL statement is executed at the current server. The value returned by the CURTIME function is the same as the value returned by the CURRENT TIME special register.

► CURTIME — (—) ◄

The data type of the result is a time. The result cannot be null.

If this function is used more than once within a single SQL statement, or used with the CURDATE or NOW scalar functions or the CURRENT_DATE, CURRENT_TIME, or CURRENT_TIMESTAMP special registers within a single statement, all values are based on a single clock reading.

Note

Syntax alternatives: The CURRENT_TIME special register should be used for maximal portability. For more information, see [“Special registers”](#) on page 121.

Example

- Return the current time based on the time-of-day clock.

```
SELECT CURTIME()  
FROM SYSIBM.SYSDUMMY1
```

DATABASE

The DATABASE function returns the current server.

►► DATABASE — (—) ◄◄

The result of the function is a VARCHAR(18). The result cannot be null.

The CCSID of the string is the default SBCS CCSID at the current server.

Note

Syntax alternatives: The DATABASE function returns the same result as the CURRENT SERVER special register.

Examples

- Assume that the current server is 'RCHASGMA'.

```
SELECT DATABASE( )  
FROM SYSIBM.SYSDUMMY1
```

Results in a value of 'RCHASGMA'.

DATAPARTITIONNAME

The DATAPARTITIONNAME function returns the partition name of where a row is located. If the argument identifies a non-partitioned table, an empty string is returned.

►► DATAPARTITIONNAME — (— *table-designator* —) ►►

For more information about partitions, see the [DB2 Multisystem](#) topic collection.

table-designator

A table designator of the subselect. For more information about table designators, see [“Table designators”](#) on page 135.

In SQL naming, the table name may be qualified. In system naming, the table name cannot be qualified.

The *table-designator* must not identify a *collection-derived-table*, a VALUES clause, a *table-function*, or a *data-change-table-reference*.

If the argument identifies a view, common table expression, or nested table expression, the function returns the partition name of its base table. If the argument identifies a view, common table expression, or nested table expression derived from more than one base table, the function returns the partition name of the first table in the outer subselect of the view, common table expression, or nested table expression.

The argument must not identify a view, common table expression, or nested table expression whose outer fullselect includes an aggregate function, a GROUP BY clause, a HAVING clause, a UNION, INTERSECT, or EXCEPT clause, DISTINCT clause, VALUES clause, or a *table-function*. The DATAPARTITIONNAME function cannot be specified in a SELECT clause if the fullselect contains an aggregate function, a GROUP BY clause, or a HAVING clause.

The data type of the result is VARCHAR(18). The result can be null.

The CCSID of the result is the default CCSID of the current server.

Example

- Join the EMPLOYEE and DEPARTMENT tables, select the employee number (EMPNO) and determine the partition from which each row involved in the join originated.

```
SELECT EMPNO, DATAPARTITIONNAME(X), DATAPARTITIONNAME(Y)
FROM EMPLOYEE X, DEPARTMENT Y
WHERE X.DEPTNO=Y.DEPTNO
```

DATAPARTITIONNUM

The DATAPARTITIONNUM function returns the data partition number of a row. If the argument identifies a non-partitioned table, the value 0 is returned.

►► DATAPARTITIONNUM — (— *table-designator* —) ►►

For more information about data partitions, see the [DB2 Multisystem](#) topic collection.

table-designator

A table designator of the subselect. For more information about table designators, see [“Table designators”](#) on page 135.

In SQL naming, the table name may be qualified. In system naming, the table name cannot be qualified.

The *table-designator* must not identify a *collection-derived-table*, a VALUES clause, a *table-function*, or a *data-change-table-reference*.

If the argument identifies a view, common table expression, or nested table expression, the function returns the data partition number of its base table. If the argument identifies a view, common table expression, or nested table expression derived from more than one base table, the function returns the data partition number of the first table in the outer subselect of the view, common table expression, or nested table expression.

The argument must not identify a view, common table expression, or nested table expression whose outer fullselect subselect includes an aggregate function, a GROUP BY clause, a HAVING clause, a UNION, INTERSECT, or EXCEPT clause, DISTINCT clause, VALUES clause, or a *table-function*. The DATAPARTITIONNUM function cannot be specified in a SELECT clause if the fullselect contains an aggregate function, a GROUP BY clause, or a HAVING clause.

The data type of the result is a large integer. The result can be null.

Example

- Determine the partition number and employee name for each row in the EMPLOYEE table. If this is a partitioned table, the number of the partition where the row exists is returned.

```
SELECT DATAPARTITIONNUM(EMPLOYEE), LASTNAME
FROM EMPLOYEE
```

DATE

The DATE function returns a date from a value.

►► DATE — (— *expression* —) ◄◄

expression

An expression that returns a value of one of the following built-in data types: a date, a timestamp, a character string, a graphic string, or any numeric data type.

- If *expression* is a character or graphic string, its value must be one of the following:
 - A valid string representation of a date or timestamp. For the valid formats of string representations of dates and timestamps, see [“String representations of datetime values”](#) on page 75.
 - A string with an actual length of 7 that represents a valid date in the form *yyyynnn*, where *yyyy* are digits denoting a year, and *nnn* are digits between 001 and 366 denoting a day of that year.
- If *expression* is a number, it must be a positive number less than or equal to 3 652 059.

The result of the function is a date. If the argument can be null, the result can be null; if the argument is null, the result is the null value.

The other rules depend on the data type of the argument:

- If the argument is a timestamp:

The result is the date part of the timestamp.
- If the argument is a date:

The result is that date.
- If the argument is a number:

The result is the date that is *n*-1 days after January 1, 0001, where *n* is the integral part of the number.
- If the argument is a character or graphic string:

The result is the date represented by the string or the date part of the timestamp value represented by the string.

Note

Syntax alternatives: The CAST specification should be used to increase the portability of applications when the argument is a date, timestamp, or character string. For more information, see [“CAST specification”](#) on page 177.

Examples

- Assume that the column RECEIVED (TIMESTAMP) has an internal value equivalent to '1988-12-25-17.12.30.000000'.

```
SELECT DATE(RECEIVED)
FROM IN_TRAY
WHERE SOURCE = 'BADAMSON'
```

Results in a date data type with a value of '1988-12-25'.

- The following DATE scalar function applied to an ISO string representation of a date:

```
SELECT DATE('1988-12-25')
FROM SYSIBM.SYSDUMMY1
```

Results in a date data type with a value of '1988-12-25'.

- The following DATE scalar function applied to an EUR string representation of a date:

```
SELECT DATE('25.12.1988')  
FROM SYSIBM.SYSDUMMY1
```

Results in a date data type with a value of '1988-12-25'.

- The following DATE scalar function applied to a positive number:

```
SELECT DATE(35)  
FROM SYSIBM.SYSDUMMY1
```

Results in a date data type with a value of '0001-02-04'.

DAY

The DAY function returns the day part of a value.

►► DAY — (— *expression* —) ►►

expression

An *expression* that returns a value of one of the following built-in data types: a date, a timestamp, a character string, a graphic string, or a numeric data type.

- If *expression* is a character or graphic string, its value must be a valid string representation of a date or timestamp. For the valid formats of string representations of dates and timestamps, see [“String representations of datetime values”](#) on page 75.
- If *expression* is a number, it must be a date duration or timestamp duration. For the valid formats of datetime durations, see [“Datetime operands and durations”](#) on page 166.

The result of the function is a large integer. If the argument can be null, the result can be null; if the argument is null, the result is the null value.

The other rules depend on the data type of the argument:

- If the argument is a date, timestamp, or valid character-string representation of a date or timestamp:

The result is the day part of the value, which is an integer between 1 and 31.

- If the argument is a date duration or timestamp duration:

The result is the day part of the value, which is an integer between -99 and 99. A nonzero result has the same sign as the argument.

Examples

- Using the PROJECT table, set the host variable END_DAY (SMALLINT) to the day that the WELD LINE PLANNING project (PROJNAME) is scheduled to stop (PRENDATE).

```
SELECT DAY(PRENDATE)
  INTO :END_DAY
  FROM PROJECT
  WHERE PROJNAME = 'WELD LINE PLANNING'
```

Results in END_DAY being set to 15.

- Return the day part of the difference between two dates:

```
SELECT DAY( DATE('2000-03-15') - DATE('1999-12-31') )
  FROM SYSIBM.SYSDUMMY1
```

Results in the value 15.

DAYNAME

Returns a mixed case character string containing the name of the day (for example, Friday) for the day portion of the argument.

►► DAYNAME (— *expression* —) ◄◄

expression

An expression that returns a value of one of the following built-in data types: a date, a timestamp, a character string, or a graphic string.

If *expression* is a character or graphic string, its value must be a valid string representation of a date or timestamp. For the valid formats of string representations of dates and timestamps, see [“String representations of datetime values”](#) on page 75.

The result of the function is VARCHAR(100). If the argument can be null, the result can be null; if the argument is null, the result is the null value.

The CCSID of the result is the default CCSID of the current server.

Note

National language considerations: The name of the day that is returned is based on the language used for messages in the job. This name of the day is retrieved from message CPX9034 in message file QCPFMSG in library *LIBL.

Examples

- Assume that the language used is US English.

```
SELECT DAYNAME( '2003-01-02' )  
FROM SYSIBM.SYSDUMMY1
```

Results in 'Thursday'.

DAYOFMONTH

The DAYOFMONTH function returns an integer between 1 and 31 that represents the day of the month.

►► DAYOFMONTH (— *expression* —) ◄◄

expression

An expression that returns a value of one of the following built-in data types: a date, a timestamp, a character string, or a graphic string.

If *expression* is a character or graphic string, its value must be a valid string representation of a date or timestamp. For the valid formats of string representations of dates and timestamps, see [“String representations of datetime values”](#) on page 75.

The result of the function is a large integer. If the argument can be null, the result can be null; if the argument is null, the result is the null value.

Examples

- Using the PROJECT table, set the host variable END_DAY (SMALLINT) to the day that the WELD LINE PLANNING project (PROJNAME) is scheduled to stop (PRENDATE).

```
SELECT DAYOFMONTH(PRENDATE)
INTO :END_DAY
FROM PROJECT
WHERE PROJNAME = 'WELD LINE PLANNING'
```

Results in END_DAY being set to 15.

DAYOFWEEK

The DAYOFWEEK function returns an integer between 1 and 7 that represents the day of the week, where 1 is Sunday and 7 is Saturday.

►► DAYOFWEEK — (— *expression* —) ◄◄

For another alternative, see [“DAYOFWEEK_ISO”](#) on page 357.

expression

An expression that returns a value of one of the following built-in data types: a date, a timestamp, a character string, or a graphic string.

If *expression* is a character or graphic string, its value must be a valid string representation of a date or timestamp. For the valid formats of string representations of dates and timestamps, see [“String representations of datetime values”](#) on page 75.

The result of the function is a large integer. If the argument can be null, the result can be null; if the argument is null, the result is the null value.

Example

- Using the EMPLOYEE table, set the host variable DAY_OF_WEEK (INTEGER) to the day of the week that Christine Haas (EMPNO='000010') started (HIREDATE).

```
SELECT DAYOFWEEK(HIREDATE)
INTO :DAY_OF_WEEK
FROM EMPLOYEE
WHERE EMPNO = '000010'
```

Results in DAY_OF_WEEK being set to 6, which represents Friday.

- The following query returns four values: 1, 2, 1, and 2.

```
SELECT DAYOFWEEK(CAST('10/11/1998' AS DATE)),
DAYOFWEEK(TIMESTAMP('10/12/1998','01.02')),
DAYOFWEEK(CAST(CAST('10/11/1998' AS DATE) AS CHAR(20))),
DAYOFWEEK(CAST(TIMESTAMP('10/12/1998','01.02') AS CHAR(26)))
FROM SYSIBM.SYSDUMMY1
```

DAYOFWEEK_ISO

The DAYOFWEEK_ISO function returns an integer between 1 and 7 that represents the day of the week, where 1 is Monday and 7 is Sunday.

►► DAYOFWEEK_ISO — (— *expression* —) ◄◄

For another alternative, see [“DAYOFWEEK”](#) on page 356.

expression

An expression that returns a value of one of the following built-in data types: a date, a timestamp, a character string, or a graphic string.

If *expression* is a character or graphic string, its value must be a valid string representation of a date or timestamp. For the valid formats of string representations of dates and timestamps, see [“String representations of datetime values”](#) on page 75.

The result of the function is a large integer. If the argument can be null, the result can be null; if the argument is null, the result is the null value.

Examples

- Using the EMPLOYEE table, set the host variable DAY_OF_WEEK (INTEGER) to the day of the week that Christine Haas (EMPNO='000010') started (HIREDATE).

```
SELECT DAYOFWEEK_ISO(HIREDATE)
INTO :DAY_OF_WEEK
FROM EMPLOYEE
WHERE EMPNO = '000010'
```

Results in DAY_OF_WEEK being set to 5, which represents Friday.

- The following query returns four values: 7, 1, 7, and 1.

```
SELECT DAYOFWEEK_ISO(CAST('10/11/1998' AS DATE)),
DAYOFWEEK_ISO(TIMESTAMP('10/12/1998', '01.02')),
DAYOFWEEK_ISO(CAST(CAST('10/11/1998' AS DATE) AS CHAR(20))),
DAYOFWEEK_ISO(CAST(TIMESTAMP('10/12/1998', '01.02') AS CHAR(26)))
FROM SYSIBM.SYSDUMMY1
```

DAYOFYEAR

The DAYOFYEAR function returns an integer between 1 and 366 that represents the day of the year where 1 is January 1.

►► DAYOFYEAR (— *expression* —) ►►

expression

An expression that returns a value of one of the following built-in data types: a date, a timestamp, a character string, or a graphic string.

If *expression* is a character or graphic string, its value must be a valid string representation of a date or timestamp. For the valid formats of string representations of dates and timestamps, see [“String representations of datetime values”](#) on page 75.

The result of the function is a large integer. If the argument can be null, the result can be null; if the argument is null, the result is the null value.

Example

- Using the EMPLOYEE table, set the host variable AVG_DAY_OF_YEAR (INTEGER) to the average of the day of the year that employees started on (HIREDATE).

```
SELECT AVG(DAYOFYEAR(HIREDATE))
INTO :AVG_DAY_OF_YEAR
FROM EMPLOYEE
```

Results in AVG_DAY_OF_YEAR being set to 197.

DAYS

The DAYS function returns an integer representation of a date.

►► DAYS — (— *expression* —) ◄◄

expression

An expression that returns a value of one of the following built-in data types: a date, a timestamp, a character string, or a graphic string.

If *expression* is a character or graphic string, its value must be a valid string representation of a date or timestamp. For the valid formats of string representations of dates and timestamps, see [“String representations of datetime values”](#) on page 75.

The result of the function is a large integer. If the argument can be null, the result can be null; if the argument is null, the result is the null value.

The result is 1 more than the number of days from January 1, 0001 to *D*, where *D* is the date that would occur if the DATE function were applied to the argument.

Examples

- Using the PROJECT table, set the host variable EDUCATION_DAYS (INTEGER) to the number of elapsed days (PRENDATE - PRSTDATE) estimated for the project (PROJNO) 'IF2000'.

```
SELECT DAYS(PRENDATE) - DAYS(PRSTDATE)
INTO :EDUCATION_DAYS
FROM PROJECT
WHERE PROJNO = 'IF2000'
```

Results in EDUCATION_DAYS being set to 396.

- Using the PROJECT table, set the host variable TOTAL_DAYS (INTEGER) to the sum of elapsed days (PRENDATE - PRSTDATE) estimated for all projects in department (DEPTNO) 'E21'.

```
SELECT SUM(DAYS(PRENDATE) - DAYS(PRSTDATE))
INTO :TOTAL_DAYS
FROM PROJECT
WHERE DEPTNO = 'E21'
```

Results in TOTAL_DAYS being set to 1584.

DBCLOB

The DBCLOB function returns a graphic-string representation.

Integer to DBCLOB

►► DBCLOB (— *integer-expression* —) ►►

Decimal to DBCLOB

►► DBCLOB (— *decimal-expression* — , — *decimal-character* —) ►►

Floating-point to DBCLOB

►► DBCLOB (— *floating-point-expression* — , — *decimal-character* —) ►►

Decimal floating-point to DBCLOB

►► DBCLOB (— *decimal-floating-point-expression* — , — *decimal-character* —) ►►

Character to DBCLOB

►► DBCLOB (— *character-expression* — , — *length* — , — *integer* —) ►►

►►) ►►

Graphic to DBCLOB

►► DBCLOB (— *graphic-expression* — , — *length* — , — *integer* —) ►►

Datetime to DBCLOB

►► DBCLOB (— *datetime-expression* — , — *ISO* — , — *USA* — , — *EUR* — , — *JIS* — , — *LOCAL* —) ►►

The DBCLOB function returns a graphic-string representation of:

- An integer number if the first argument is a SMALLINT, INTEGER, or BIGINT
- A decimal number if the first argument is a packed or zoned decimal number
- A double-precision floating-point number if the first argument is a DOUBLE or REAL
- A decimal floating-point number if the first argument is a DECFLOAT

- A character string if the first argument is any type of character string
- A graphic string if the first argument is any type of graphic string
- A date value if the first argument is a DATE.
- A time value if the first argument is a TIME.
- A timestamp value if the first argument is a TIMESTAMP.

The result of the function is a DBCLOB. If the first argument can be null, the result can be null; if the first argument is null, the result is the null value.

Integer to DBCLOB

integer-expression

An expression that returns a value that is a built-in integer data type (either SMALLINT, INTEGER, or BIGINT).

The result is a varying-length graphic string of the argument in the form of an SQL integer constant. The result consists of n characters that are the significant digits that represent the value of the argument with a preceding minus sign if the argument is negative. The result is left justified.

- If the argument is a small integer, the length attribute of the result is 6.
- If the argument is a large integer, the length attribute of the result is 11.
- If the argument is a big integer, the length attribute of the result is 20.

The actual length of the result is the smallest number of characters that can be used to represent the value of the argument. Leading zeroes are not included. If the argument is negative, the first character of the result is a minus sign. Otherwise, the first character is a digit or the *decimal-character*.

The CCSID of the result is 1200 (UTF-16).

Decimal to DBCLOB

decimal-expression

An expression that returns a value that is a built-in decimal data type (either DECIMAL or NUMERIC). If a different precision and scale is wanted, the DECIMAL scalar function can be used to make the change.

decimal-character

Specifies the single-byte character constant that is used to delimit the decimal digits in the result character string. The character must be a period or comma. If the second argument is not specified, the decimal point is the default decimal point. For more information, see [“Decimal point” on page 118](#).

The result is a varying-length graphic string representation of the argument. The result includes a decimal character and up to p digits, where p is the precision of the *decimal-expression* with a preceding minus sign if the argument is negative. Leading zeros are not returned. Trailing zeros are returned. If the scale of *decimal-expression* is zero, the decimal character is not returned.

The length attribute of the result is $2+p$ where p is the precision of the *decimal-expression*. The actual length of the result is the smallest number of characters that can be used to represent the result, except that trailing characters are included. Leading zeros are not included. If the argument is negative, the result begins with a minus sign. Otherwise, the result begins with a digit or the *decimal-character*.

The CCSID of the result is 1200 (UTF-16).

Floating-point to DBCLOB

floating-point expression

An expression that returns a value that is a built-in floating-point data type (DOUBLE or REAL).

decimal-character

Specifies the single-byte character constant that is used to delimit the decimal digits in the result character string. The character must be a period or comma. If the second argument is not specified, the decimal point is the default decimal point. For more information, see [“Decimal point” on page 118](#).

The result is a varying-length graphic string representation of the argument in the form of a floating-point constant.

The length attribute of the result is 24. The actual length of the result is the smallest number of characters that can represent the value of the argument such that the mantissa consists of a single digit other than zero followed by the *decimal-character* and a sequence of digits. If the argument is negative, the first character of the result is a minus sign; otherwise, the first character is a digit or the *decimal-character*. If the argument is zero, the result is 0E0.

The CCSID of the result is 1200 (UTF-16).

Decimal floating-point to DBCLOB***decimal floating-point expression***

An expression that returns a value that is a built-in decimal floating-point data type.

decimal-character

Specifies the single-byte character constant that is used to delimit the decimal digits in the result character string. The character must be a period or comma. If the second argument is not specified, the decimal point is the default decimal point. For more information, see [“Decimal point” on page 118](#).

The result is a varying-length graphic string representation of the argument in the form of a decimal floating-point constant.

The length attribute of the result is 42. The actual length of the result is the smallest number of characters that represents the value of the argument, including the sign, digits, and *decimal-character*. Trailing zeros are significant. If the argument is negative, the first character of the result is a minus sign; otherwise, the first character is a digit or the *decimal-character*. If the argument is zero, the result is 0.

If the DECFLOAT value is Infinity, sNaN, or NaN, the strings 'INFINITY', 'SNAN', and 'NAN', respectively, are returned. If the special value is negative, a minus sign will be the first character in the string. The DECFLOAT special value sNaN does not result in an exception when converted to a string.

The CCSID of the result is 1200 (UTF-16).

Character to DBCLOB***character-expression***

An expression that returns a value that is a built-in character-string data type. It cannot be CHAR or VARCHAR bit data. If the expression is an empty string or the EBCDIC string X'0E0F', the result is an empty string.

length

An integer constant that specifies the length attribute for the resulting varying length character string. The value must be between 1 and 1 073 741 823.

If the second argument is not specified or DEFAULT is specified:

- If the *character-expression* is the empty string constant, the length attribute of the result is 1.
- Otherwise, the length attribute of the result is the same as the length attribute of the first argument.

The actual length of the result is the minimum of the length attribute of the result and the actual length of *character-expression*. If the length of the *character-expression* is greater than the length attribute of the result, truncation is performed. A warning (SQLSTATE 01004) is returned unless the truncated characters were all blanks.

integer

An integer constant that specifies the CCSID for the resulting varying-length graphic string. It must be a DBCS, UTF-16, or UCS-2 CCSID. The CCSID cannot be 65535.

In the following rules, S denotes one of the following:

- If the string expression is a host variable containing data in a foreign encoding scheme, S is the result of the expression after converting the data to a CCSID in a native encoding scheme. (See “Character conversion” on page 28 for more information.)
- If the string expression is data in a native encoding scheme, S is that string expression.

If the third argument is not specified and the first argument is character, then the CCSID of the result is determined by a mixed CCSID. Let M denote that mixed CCSID. M is determined as follows:

- If the CCSID of S is a mixed CCSID, M is that CCSID.
- If the CCSID of S is an SBCS CCSID:
 - If the CCSID of S has an associated mixed CCSID, M is that CCSID.
 - Otherwise the operation is not allowed.

The following table summarizes the result CCSID based on M.

M	Result CCSID	Description	DBCS Substitution Character
930	300	Japanese EBCDIC	X'FEFE'
933	834	Korean EBCDIC	X'FEFE'
935	837	S-Chinese EBCDIC	X'FEFE'
937	835	T-Chinese EBCDIC	X'FEFE'
939	300	Japanese EBCDIC	X'FEFE'
5026	4396	Japanese EBCDIC	X'FEFE'
5035	4396	Japanese EBCDIC	X'FEFE'

If the result is DBCS-graphic data, the equivalence of SBCS and DBCS characters depends on M. Regardless of the CCSID, every double-byte code point in the argument is considered a DBCS character, and every single-byte code point in the argument is considered an SBCS character with the exception of the EBCDIC mixed data shift codes X'0E' and X'0F'.

- If the nth character of the argument is a DBCS character, the nth character of the result is that DBCS character.
- If the nth character of the argument is an SBCS character that has an equivalent DBCS character, the nth character of the result is that equivalent DBCS character.
- If the nth character of the argument is an SBCS character that does not have an equivalent DBCS character, the nth character of the result is the DBCS substitution character.

If the result is Unicode graphic data, each character of the argument determines a character of the result. The nth character of the result is the UTF-16 or UCS-2 equivalent of the nth character of the argument.

Graphic to DBCLOB

graphic-expression

An expression that returns a value that is a built-in graphic-string data type.

length

An integer constant that specifies the length attribute for the resulting varying length character string. The value must be between 1 and 1 073 741 823.

If the second argument is not specified or DEFAULT is specified:

- If the *graphic-expression* is the empty string constant, the length attribute of the result is 1.

- Otherwise, the length attribute of the result is the same as the length attribute of the first argument.

The actual length of the result is the minimum of the length attribute of the result and the actual length of *graphic-expression*. If the length of the *graphic-expression* is greater than the length attribute of the result, truncation is performed. A warning (SQLSTATE 01004) is returned unless the truncated characters were all blanks.

integer

An integer constant that specifies the CCSID for the resulting varying-length graphic string. It must be a DBCS, UTF-16, or UCS-2 CCSID. The CCSID cannot be 65535.

In the following rules, S denotes one of the following:

- If the string expression is a host variable containing data in a foreign encoding scheme, S is the result of the expression after converting the data to a CCSID in a native encoding scheme. (See [“Character conversion”](#) on page 28 for more information.)
- If the string expression is data in a native encoding scheme, S is that string expression.

If the third argument is not specified, then the CCSID of the result is the same as the CCSID of the first argument.

Datetime to DBCLOB

datetime-expression

An expression that is one of the following three built-in data types

date

The result is the varying-length graphic string representation of the date in the format specified by the second argument. If the second argument is not specified, the format used is the default date format. If the format is ISO, USA, EUR, or JIS, the length attribute and actual length of the result is 10. Otherwise the length attribute and actual length of the result is the length of the default date format. For more information see [“String representations of datetime values”](#) on page 75.

time

The result is the varying-length graphic string representation of the time in the format specified by the second argument. If the second argument is not specified, the format used is the default time format. The length attribute and actual length of the result is 8. For more information see [“String representations of datetime values”](#) on page 75.

timestamp

The second argument is not applicable and must not be specified.

The result is the varying-length graphic string representation of the timestamp. If *datetime-expression* is a `TIMESTAMP(0)`, the length attribute and actual length of the result is 19. If the data type of *datetime-expression* is a `TIMESTAMP(n)`, the length attribute and actual length of the result is $20+n$. Otherwise, the length attribute and actual length of the result is 26.

The CCSID of the result is 1200 (UTF-16).

ISO, EUR, USA, or JIS

Specifies the date or time format of the resulting graphic string. For more information, see [“String representations of datetime values”](#) on page 75.

LOCAL

Specifies that the date or time format of the resulting graphic string should come from the `DATFMT`, `DATSEP`, `TIMFMT`, and `TIMSEP` attributes of the job at the current server.

Note

Syntax alternatives: The `CAST` specification should be used to increase the portability of applications when the first argument is a string and the length attribute is specified. For more information, see [“CAST specification”](#) on page 177.

Example

- Using the EMPLOYEE table, set the host variable VAR_DESC (VARGRAPHIC(24)) to the DBCLOB equivalent of the first name (FIRSTNME) for employee number (EMPNO) '000050'.

```
SELECT DBCLOB(VARGRAPHIC(FIRSTNME))  
INTO :VAR_DESC  
FROM EMPLOYEE  
WHERE EMPNO = '000050'
```

DBPARTITIONNAME

The DBPARTITIONNAME function returns the relational database name (database partition name) of where a row is located. If the argument identifies a non-distributed table, the current server is returned.

►► DBPARTITIONNAME — (— *table-designator* —) ►►

For more information about partitions, see the [DB2 Multisystem](#) topic collection.

table-designator

A table designator of the subselect. For more information about table designators, see [“Table designators”](#) on page 135.

In SQL naming, the table name may be qualified. In system naming, the table name cannot be qualified.

The *table-designator* must not identify a *collection-derived-table*, a VALUES clause, a *table-function*, or a *data-change-table-reference*.

If the argument identifies a view, common table expression, or nested table expression, the function returns the relational database name of its base table. If the argument identifies a view, common table expression, or nested table expression derived from more than one base table, the function returns the partition name of the first table in the outer subselect of the view, common table expression, or nested table expression.

The argument must not identify a view, common table expression, or nested table expression whose outer fullselect includes an aggregate function, a GROUP BY clause, a HAVING clause, a UNION, INTERSECT, or EXCEPT clause, DISTINCT clause, VALUES clause, or a *table-function*. The DBPARTITIONNAME function cannot be specified in a SELECT clause if the fullselect contains an aggregate function, a GROUP BY clause, or a HAVING clause.

The data type of the result is VARCHAR(18). The result can be null.

The CCSID of the result is the default CCSID of the current server.

Note

Syntax alternatives: NODENAME is a synonym for DBPARTITIONNAME.

Example

- Join the EMPLOYEE and DEPARTMENT tables, select the employee number (EMPNO) and determine the node from which each row involved in the join originated.

```
SELECT EMPNO, DBPARTITIONNAME(X), DBPARTITIONNAME(Y)
FROM EMPLOYEE X, DEPARTMENT Y
WHERE X.DEPTNO=Y.DEPTNO
```

DBPARTITIONNUM

The DBPARTITIONNUM function returns the node number (database partition number) of a row.

►► DBPARTITIONNUM — (— *table-designator* —) ►►

If the argument identifies a non-distributed table, the value 0 is returned.⁵⁴ For more information about nodes and node numbers, see the [DB2 Multisystem](#) book.

table-designator

A table designator of the subselect. For more information about table designators, see [“Table designators”](#) on page 135.

In SQL naming, the table name may be qualified. In system naming, the table name cannot be qualified.

The *table-designator* must not identify a *collection-derived-table*, a VALUES clause, a *table-function*, or a *data-change-table-reference*.

If the argument identifies a view, common table expression, or nested table expression, the function returns the node number of its base table. If the argument identifies a view, common table expression, or nested table expression derived from more than one base table, the function returns the node number of the first table in the outer subselect of the view, common table expression, or nested table expression.

The argument must not identify a view, common table expression, or nested table expression whose outer fullselect subselect includes an aggregate function, a GROUP BY clause, a HAVING clause, a UNION, INTERSECT, or EXCEPT clause, DISTINCT clause, VALUES clause, or a *table-function*. The DBPARTITIONNUM function cannot be specified in a SELECT clause if the fullselect contains an aggregate function, a GROUP BY clause, or a HAVING clause.

The data type of the result is a large integer. The result can be null.

Note

Syntax alternatives: NODENUMBER is a synonym for DBPARTITIONNUM.

Example

- Determine the node number and employee name for each row in the EMPLOYEE table. If this is a distributed table, the number of the node where the row exists is returned.

```
SELECT DBPARTITIONNUM(EMPLOYEE), LASTNAME
FROM EMPLOYEE
```

⁵⁴ If the argument identifies a DDS created logical file that is based on more than one physical file member, DBPARTITIONNUM will not return 0, but instead will return the underlying physical file member number.

DECFLOAT

The DECFLOAT function returns a decimal floating-point representation of a number or a string representation of a number.

Numeric to DECFLOAT



String to DECFLOAT



The DECFLOAT function returns a decimal floating-point representation of:

- A number
- A character or graphic string representation of a decimal number
- A character or graphic string representation of an integer
- A character or graphic string representation of a floating-point number
- A character or graphic string representation of a decimal floating-point number

Numeric to DECFLOAT

numeric-expression

An expression that returns a value of any built-in numeric data type.

34 or 16

Specifies the number of digits of precision for the result. The default is 34.

The result is the same number that would occur if the first argument were assigned to a decimal floating-point column or variable.

String to DECFLOAT

string-expression

An expression that returns a value that is a character-string or graphic-string representation of a number. Leading and trailing blanks are eliminated and the resulting string folded to uppercase must conform to the rules for forming a floating-point, decimal floating-point, integer, or decimal constant.

34 or 16

Specifies the number of digits of precision for the result. The default is 34.

decimal-character

Specifies the single-byte character constant that is used to delimit the decimal digits in *string-expression* from the whole part of the number. The character must be a period or comma. If *decimal-character* is not specified, the decimal point is the default decimal separator character. For more information, see [“Decimal point” on page 118](#).

The result of the function is a DECFLOAT number with the specified (either implicitly or explicitly) number of digits of precision. If the first argument can be null, the result can be null; if the first argument is null, the result is the null value.

If necessary, the source is rounded to the precision of the target. See [“CURRENT DECFLOAT ROUNDING MODE”](#) on page 126 for more information.

Note

Syntax alternatives: The CAST specification should be used to increase the portability of applications. For more information, see [“CAST specification”](#) on page 177.

Example

- Use the DECFLOAT function in order to force a DECFLOAT data type to be returned in a select-list for the EDLEVEL column (data type = SMALLINT) in the EMPLOYEE table. The EMPNO column should also appear in the *select-clause*.

```
SELECT EMPNO, DECFLOAT(EDLEVEL,16)
FROM EMPLOYEE
```

DECFLOAT_FORMAT

The DECFLOAT_FORMAT function returns a DECFLOAT(34) value that is based on the interpretation of the input string using the specified format.

►► DECFLOAT_FORMAT (— *string-expression* , — *format-string*) ►►

string-expression

An expression that returns a built-in character string or graphic string data type. If the value is a graphic data type, it is implicitly cast to VARCHAR before evaluating the function. Leading and trailing blanks are removed from the string. If *format-string* is not specified, the resulting substring must conform to the rules for forming an SQL integer, decimal, floating-point, or decimal floating-point constant and not be greater than 63 characters after stripping leading and trailing blanks. Otherwise, the resulting substring must contain the components of a number that correspond to the format specified by *format-string*.

format-string

An expression that returns a built-in character string or graphic string data type. If the value is a graphic data type, it is implicitly cast to VARCHAR before evaluating the function. *format-string* contains a template of how *string-expression* is to be interpreted for conversion to a DECFLOAT value. *format-string* must contain a valid combination of the listed format elements according to the following rules:

- At least one '0' or '9' format element must be specified.
- A sign format element ('S', 'MI', 'PR') can be specified only one time.
- A decimal point format element can be specified only one time.
- Alphabetic format elements must be specified in upper case.
- A prefix format element can only be specified at the beginning of the format string, before any format elements that are not prefix format elements. When multiple prefix format elements are specified they can be specified in any order.
- A suffix format element can only be specified at the end of the format string, after any format elements that are not suffix format elements. When multiple suffix format elements are specified they can be specified in any order.
- A comma or G format element can be the first format element that is not a prefix format element. There can be any number of comma or G format elements.
- Blanks must not be specified between format elements. Leading and trailing blanks can be specified but are ignored.

Format element	Description
0 or 9	Represents a digit that can be included at the specified location. Both format elements have the same meaning.
S	Prefix: If <i>string-expression</i> represents a negative number, a leading minus sign (–) is expected at the specified location. If <i>string-expression</i> represents a positive number, a leading plus sign (+) or leading blank can be included at the specified location.
\$	Prefix: A leading dollar sign (\$) is expected at the specified location.
MI	Suffix: If <i>string-expression</i> represents a negative number, a trailing minus sign (–) is expected at the specified location. If <i>string-expression</i> represents a positive number, a trailing blank can be included at the specified location.

<i>Table 50. Format elements for the DECFLOAT_FORMAT function (continued)</i>	
Format element	Description
PR	Suffix: If <i>string-expression</i> represents a negative number, a leading less than character (<) and a trailing greater than character (>) are expected. If <i>string-expression</i> represents a positive number, a leading blank and a trailing blank can be included.
,	Specifies the expected location of a comma. This comma is used as a group separator.
.	Specifies the expected location of the period. This period is used as a decimal point.
L	Prefix or Suffix: Specifies that the local currency symbol is expected at the specified location. The currency symbol is retrieved from message CPX8416 in message file QCPFMSG in library *LIBL.
D	Specifies that the local decimal point character is expected at the specified location. The decimal character is retrieved from message CPX8416 in message file QCPFMSG in library *LIBL.
G	Specifies that the local group separator character is expected at the specified location. If the local decimal character as retrieved from message CPX8416 in message file QCPFMSG in library *LIBL is a period, the group separator will be a comma. If the local decimal character is a comma, the group separator will be a period.

The result is a DECFLOAT(34). If any argument of the DECFLOAT_FORMAT function can be null, the result can be null; if any argument is null, the result is the null value.

Note

Syntax alternatives: TO_NUMBER is a synonym for DECFLOAT_FORMAT.

Examples

Example	Result
DECFLOAT_FORMAT('123.45')	123.45
DECFLOAT_FORMAT('-123456.78')	-123456.78
DECFLOAT_FORMAT('+123456.78')	123456.78
DECFLOAT_FORMAT('1.23E4')	12300
DECFLOAT_FORMAT('123.4', '9999.99')	123.40
DECFLOAT_FORMAT('001,234', '000,000')	1234
DECFLOAT_FORMAT('1234', '9999MI')	1234
DECFLOAT_FORMAT('1234-', '9999MI')	-1234
DECFLOAT_FORMAT('+1234', 'S9999')	1234
DECFLOAT_FORMAT('-1234', 'S9999')	-1234
DECFLOAT_FORMAT(' 1234', '9999PR')	1234
DECFLOAT_FORMAT('<1234>', '9999PR')	-1234
DECFLOAT_FORMAT('\$123,456.78', '\$999,999.99')	123456.78

DECFLOAT_SORTKEY

The DECFLOAT_SORTKEY function returns a binary value that may be used to sort DECFLOAT values.

►► DECFLOAT_SORTKEY — (— *expression* —) ►►

The DECFLOAT_SORTKEY function returns a binary value that may be used to sort decimal floating-point values in a manner that is consistent with the IEEE 754R specification on total ordering.

expression

An expression that returns a value of any built-in numeric, character-string, or graphic-string data type.

If the data type of the argument is SMALLINT, INTEGER, REAL, DOUBLE, DECIMAL(p,s) where $p \leq 16$, or NUMERIC(p,s) where $p \leq 16$, then the argument is converted to DECFLOAT(16) for processing. Otherwise, the argument is converted to DECFLOAT(34) for processing.

The result of the function is BINARY(9) if the argument is DECFLOAT(16) or BINARY(17) if the argument is DECFLOAT(34).

If the argument can be null, the result can be null. If the argument is null, the result is the null value.

Example

```
CREATE TABLE T1 (D1 DECFLOAT(16));
INSERT INTO T1 VALUES(2.100);
INSERT INTO T1 VALUES(2.10);
INSERT INTO T1 VALUES(2.1000);
INSERT INTO T1 VALUES(2.1);
```

```
SELECT D1 FROM T1 ORDER BY D1;
```

```
  D1
-----
    2.100
    2.10
    2.1000
    2.1
```

Note that this result set is arbitrary. The ORDER BY has no effect on ordering these values.

```
SELECT D1 FROM T1 ORDER BY DECFLOAT_SORTKEY(D1);
```

```
  D1
-----
    2.1000
    2.100
    2.10
    2.1
```

Note that this result set is ordered according to the IEEE 754R ordering specification.

DECIMAL or DEC

The DECIMAL function returns a decimal representation.

Numeric to Decimal

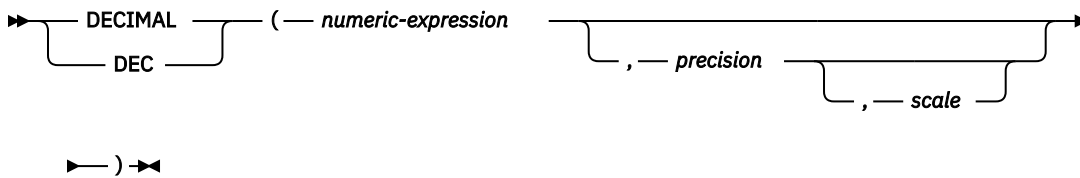

String to Decimal

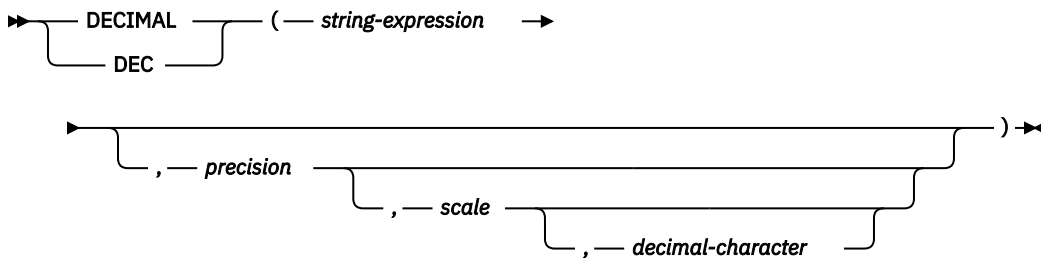

Datetime to Decimal

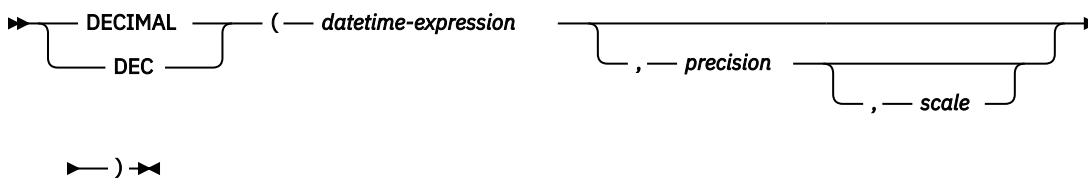

The DECIMAL function returns a decimal representation of:

- A number
- A character or graphic string representation of a decimal number
- A character or graphic string representation of an integer
- A character or graphic string representation of a floating-point number
- A character or graphic string representation of a decimal floating-point number
- A date
- A time
- A timestamp

Numeric to Decimal

numeric-expression

An expression that returns a value of any built-in numeric data type.

precision

An integer constant with a value greater than or equal to 1 and less than or equal to 63.

The default for *precision* depends on the data type of the *numeric-expression*:

- 5 for small integer
- 11 for large integer
- 19 for big integer

- 15 for floating point, decimal, numeric, or nonzero scale binary
- 31 for decimal floating point

scale

An integer constant that is greater than or equal to 0 and less than or equal to *precision*. If not specified, the default is 0.

The result is the same number that would occur if the first argument were assigned to a decimal column or variable with a precision of *precision* and a scale of *scale*. An error is returned if the number of significant decimal digits required to represent the whole part of the number is greater than *precision-scale*. If the first argument can be null, the result can be null; if the first argument is null, the result is the null value.

String to Decimal

string-expression

An expression that returns a character-string or graphic-string representation of a number. Leading and trailing blanks are eliminated and the resulting string must conform to the rules for forming a floating-point, decimal floating-point, integer, or decimal constant.

precision

An integer constant that is greater than or equal to 1 and less than or equal to 63. If not specified, the default is 15.

scale

An integer constant that is greater than or equal to 0 and less than or equal to *precision*. If not specified, the default is 0.

decimal-character

Specifies the single-byte character constant that is used to delimit the decimal digits in *string-expression* from the whole part of the number. The character must be a period or comma. If *decimal-character* is not specified, the decimal point is the default decimal separator character. For more information, see [“Decimal point” on page 118](#).

Digits are truncated from the end if the number of digits to the right of the *decimal-character* is greater than the scale *s*. An error is returned if the number of significant digits to the left of the *decimal-character* (the whole part of the number) in *string-expression* is greater than *precision-scale*. The default decimal separator character is not valid in the substring if the *decimal-character* argument is specified.

Datetime to Decimal

datetime-expression

An expression that returns a value of type DATE, TIME, or TIMESTAMP

precision

An integer constant that is greater than or equal to 1 and less than or equal to 63 that specifies the precision of the result. If not specified, the default for the precision and scale depends on the data type of *datetime-expression* as follows:

- Precision is 8 and scale is 0 for DATE. The result is a DECIMAL(8,0) value representing the date as *yyyymmdd*.
- Precision is 6 and scale is 0 for a TIME. The result is a DECIMAL(6,0) value representing the time as *hhmmss*.
- Precision is 14+*tp* and scale is *tp* for a TIMESTAMP(*tp*). The result is a DECIMAL(14+*tp*,*tp*) value representing the timestamp as *yyyymmddhhmmss.nnnnnnnnnnnn*.

scale

An integer constant that is greater than or equal to 0 and less than or equal to *precision*. If not specified, the default is 0.

The result is the same number that would result from CAST(*datetime-expression* AS DECIMAL(*precision*,*scale*)). Digits are truncated from the end if the number of digits to the right of the

decimal separator character is greater than *scale*. An error is returned if the number of significant digits to the left of the decimal separator character (the whole part of the number) in *datetime-expression* is greater than *precision - scale*.

The result of the function is a decimal number with precision of *precision* and scale of *scale*. If the first argument can be null, the result can be null; if the first argument is null, the result is the null value.

Note

Syntax alternatives: The CAST specification should be used to increase the portability of applications when precision is specified. For more information, see [“CAST specification” on page 177](#).

Examples

- Use the DECIMAL function in order to force a DECIMAL data type (with a precision of 5 and a scale of 2) to be returned in a select-list for the EDLEVEL column (data type = SMALLINT) in the EMPLOYEE table. The EMPNO column should also appear in the select list.

```
SELECT EMPNO, DECIMAL(EDLEVEL,5,2)
FROM EMPLOYEE
```

- Using the PROJECT table, select all of the starting dates (PRSTDATE) that have been incremented by a duration that is specified in a host variable. Assume the host variable PERIOD is of type INTEGER. Then, in order to use its value as a date duration it must be “cast” as DECIMAL(8,0).

```
SELECT PRSTDATE + DECIMAL(:PERIOD,8)
FROM PROJECT
```

- Assume that updates to the SALARY column are input through a window as a character string using comma as a decimal character (for example, the user inputs 21400,50). Once validated by the application, it is assigned to the host variable newsalary which is defined as CHAR(10).

```
UPDATE STAFF
SET SALARY = DECIMAL(:newsalary, 9, 2, ',')
WHERE ID = :empid
```

The value of SALARY becomes 21400.50.

DECRYPT_BIT, DECRYPT_BINARY, DECRYPT_CHAR and DECRYPT_DB

The DECRYPT_BIT, DECRYPT_BINARY, DECRYPT_CHAR, and DECRYPT_DB functions return a value that is the result of decrypting encrypted data. The password used for decryption is either the *password-string* value or the ENCRYPTION PASSWORD value assigned by the SET ENCRYPTION PASSWORD statement.

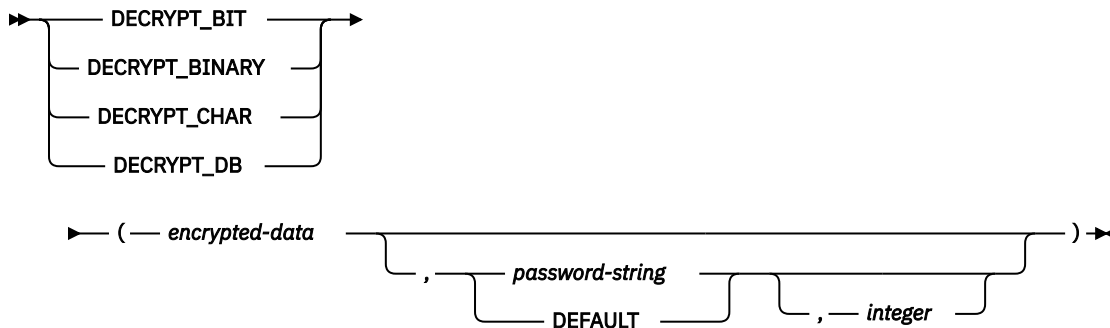

The decryption functions can only decrypt values that are encrypted using the ENCRYPT_AES, ENCRYPT_RC2, or ENCRYPT_TDES function.

encrypted-data

An expression that must be a string expression that returns a complete, encrypted data value of a CHAR FOR BIT DATA, VARCHAR FOR BIT DATA, BINARY, VARBINARY, or BLOB built-in data type. The data string must have been encrypted using the ENCRYPT_AES, ENCRYPT_RC2, or ENCRYPT_TDES function.

password-string

An expression that returns a character string value with at least 6 bytes and no more than 127 bytes. The expression must not be a CLOB. This expression must be the same password used to encrypt the data or decryption will result in a different value than was originally encrypted. If the value of the password argument is null or not provided, the data will be decrypted using the ENCRYPTION PASSWORD value, which must have been set using the SET ENCRYPTION PASSWORD statement.

DEFAULT

The data will be decrypted using the ENCRYPTION PASSWORD value, which must have been set using the SET ENCRYPTION PASSWORD statement.

integer

An integer constant that specifies the CCSID of the result. If DECRYPT_BIT or DECRYPT_BINARY is specified, the third argument must not be specified.

If DECRYPT_CHAR is specified, *integer* must be a valid SBCS CCSID or mixed data CCSID. It cannot be 65535 (bit data). If the third argument is an SBCS CCSID, then the result is SBCS data. If the third argument is a mixed CCSID, then the result is mixed data. If the third argument is not specified then the CCSID of the result is the default CCSID of the current server.

If DECRYPT_DB is specified, *integer* must be a valid DBCS CCSID. If the third argument is not specified then the CCSID of the result is the DBCS CCSID associated with the default CCSID of the current server.

The data type of the result is determined by the function specified and the data type of the first argument as shown in the following table. If a cast from the actual type of the encrypted data to the function's result is not supported a warning or error is returned.

Function	Data Type of First Argument	Actual Data Type of Encrypted Data	Result
DECRYPT_BIT	CHAR FOR BIT DATA, VARCHAR FOR BIT DATA, BINARY, or VARBINARY	Character string	VARCHAR FOR BIT DATA

Function	Data Type of First Argument	Actual Data Type of Encrypted Data	Result
DECRYPT_BIT	CHAR FOR BIT DATA, VARCHAR FOR BIT DATA, BINARY, or VARBINARY	Graphic string	Error or Warning **
DECRYPT_BIT	CHAR FOR BIT DATA, VARCHAR FOR BIT DATA, BINARY, or VARBINARY	Binary string	Error or Warning **
DECRYPT_BIT	BLOB	Any string	Error
DECRYPT_BINARY	CHAR FOR BIT DATA, VARCHAR FOR BIT DATA, BINARY, or VARBINARY	Any string	VARBINARY
DECRYPT_BINARY	BLOB	Any string	BLOB
DECRYPT_CHAR	CHAR FOR BIT DATA, VARCHAR FOR BIT DATA, BINARY, or VARBINARY	Character string	VARCHAR
DECRYPT_CHAR	CHAR FOR BIT DATA, VARCHAR FOR BIT DATA, BINARY, or VARBINARY	Unicode graphic string	VARCHAR
DECRYPT_CHAR	CHAR FOR BIT DATA, VARCHAR FOR BIT DATA, BINARY, or VARBINARY	Non-Unicode graphic string	Error or Warning **
DECRYPT_CHAR	CHAR FOR BIT DATA, VARCHAR FOR BIT DATA, BINARY, or VARBINARY	Binary string	Error or Warning **
DECRYPT_CHAR	BLOB	Character string	CLOB
DECRYPT_CHAR	BLOB	Unicode graphic string	CLOB
DECRYPT_CHAR	BLOB	Non-Unicode graphic string	Error or Warning **
DECRYPT_CHAR	BLOB	Binary string	Error or Warning **
DECRYPT_DB	CHAR FOR BIT DATA, VARCHAR FOR BIT DATA, BINARY, or VARBINARY	UTF-8 character string or graphic string	VARGRAPHIC
DECRYPT_DB	CHAR FOR BIT DATA, VARCHAR FOR BIT DATA, BINARY, or VARBINARY	Non-UTF-8 character string	Error or Warning **
DECRYPT_DB	CHAR FOR BIT DATA, VARCHAR FOR BIT DATA, BINARY, or VARBINARY	Binary string	Error or Warning **
DECRYPT_DB	BLOB	UTF-8 character string or graphic string	DBCLOB
DECRYPT_DB	BLOB	Non-UTF-8 character string	Error or Warning **
DECRYPT_DB	BLOB	Binary string	Error or Warning **

Function	Data Type of First Argument	Actual Data Type of Encrypted Data	Result
<p>Note:</p> <p>** If the decryption function is in the select list of an outer subselect, a data mapping warning is returned. Otherwise an error is returned. For more information about data mapping warnings, see “Assignments and comparisons” on page 91.</p>			

If the *encrypted-data* included a hint, the hint is not returned by the function. The length attribute of the result is the length attribute of the data type of *encrypted-data* minus 8 bytes. The actual length of the result is the length of the original string that was encrypted. If the *encrypted-data* includes bytes beyond the encrypted string, these bytes are not returned by the function.

If the argument can be null, the result can be null; if the argument is null, the result is the null value.

If the data is decrypted using a different CCSID than the originally encrypted value, expansion may occur when converting the decrypted value to this CCSID. In such situations, the *encrypted-data* should be cast to a varying-length string with a larger number of bytes.

Note

Password protection: To prevent inadvertent access to the encryption password, do not specify *password-string* as a string constant in the source for a program, procedure, or function. Instead, use the ENCRYPTION PASSWORD special register or a host variable.

When connected to a remote relational database, the specified password itself is sent "in the clear". That is, the password itself is not encrypted. To protect the password in these cases, consider using a communications encryption mechanism such as IPSEC (or SSL if connecting between IBM i products).

Syntax alternatives: For compatibility with previous versions of Db2, DECRYPT_BIN can be specified in place of DECRYPT_BIT.

Examples

- Assume that table EMP1 has a social security column called SSN. This example uses the ENCRYPTION PASSWORD value to hold the encryption password.

```
SET ENCRYPTION PASSWORD = :pw
INSERT INTO EMP1 (SSN) VALUES ENCRYPT_RC2( '289-46-8832' )
SELECT DECRYPT_CHAR( SSN)
FROM EMP1
```

The DECRYPT_CHAR function returns the original value '289-46-8832'.

- This example explicitly passes the encryption password which has been set in variable pw.

```
INSERT INTO EMP1 (SSN) VALUES ENCRYPT_TDES( '289-46-8832', :pw)
SELECT DECRYPT_CHAR( SSN, :pw)
FROM EMP1
```

The DECRYPT_CHAR function returns the original value '289-46-8832'.

DEGREES

The DEGREES function returns the number of degrees of the argument which is an angle expressed in radians.

►► DEGREES — (— *expression* —) ►◄

expression

An expression that returns a value of any built-in numeric, character-string, or graphic-string data type. A string argument is cast to double-precision floating point before evaluating the function. For more information about converting strings to double-precision floating point, see [“DOUBLE_PRECISION or DOUBLE”](#) on page 391.

If the data type of the argument is DECFLOAT(*n*), the result is DECFLOAT(*n*). Otherwise, the data type of the result is double-precision floating point. If the argument can be null, the result can be null; if the argument is null, the result is the null value.

Example

- Assume the host variable RAD is a DECIMAL(4,3) host variable with a value of 3.142.

```
SELECT DEGREES (:RAD)
FROM SYSIBM.SYSDUMMY1
```

Returns the approximate value 180.0.

DIFFERENCE

The DIFFERENCE function returns a value from 0 to 4 representing the difference between the sounds of two strings based on applying the SOUNDEX function to the strings. A value of 4 is the best possible sound match.

► DIFFERENCE (— *expression-1* — , — *expression-2* —) ►

expression-1

An expression that returns a built-in numeric, character-string, or graphic-string data types, but not CLOBs or DBCLOBs. The arguments cannot be binary strings. A numeric argument is cast to a character string before evaluating the function. For more information about converting numeric to a character string, see [“VARCHAR” on page 616](#).

expression-2

An expression that returns a built-in numeric, character-string, or graphic-string data types, but not CLOBs or DBCLOBs. The arguments cannot be binary strings. A numeric argument is cast to a character string before evaluating the function. For more information about converting numeric to a character string, see [“VARCHAR” on page 616](#).

The data type of the result is INTEGER. If either argument can be null, the result can be null; if either argument is null, the result is the null value.

Examples

- Assume the following statement:

```
SELECT DIFFERENCE ('CONSTRAINT', 'CONSTANT'),
       SOUNDEX ('CONSTRAINT'),
       SOUNDEX ('CONSTANT')
FROM SYSIBM.SYSDUMMY1
```

Returns 4, C523, and C523. Since the two strings return the same SOUNDEX value, the difference is 4 (the highest value possible).

- Assume the following statement:

```
SELECT DIFFERENCE ('CONSTRAINT', 'CONTRITE'),
       SOUNDEX ('CONSTRAINT'),
       SOUNDEX ('CONTRITE')
FROM SYSIBM.SYSDUMMY1
```

Returns 2, C523, and C536. In this case, the two strings return different SOUNDEX values, and hence, a lower difference value.

DIGITS

The DIGITS function returns a character-string representation of the absolute value of a number.

►► DIGITS — (— *expression* —) ►►

expression

An expression that returns a value of a built-in SMALLINT, INTEGER, BIGINT, DECIMAL, NUMERIC, character-string, or graphic-string data type. A string argument is cast to DECIMAL(63,31) before evaluating the function. For more information about converting strings to decimal, see [“DECIMAL or DEC”](#) on page 373.

If the argument can be null, the result can be null; if the argument is null, the result is the null value.

The result of the function is a fixed-length character string representing the absolute value of the argument without regard to its scale. The result does not include a sign or a decimal point. Instead, it consists exclusively of digits, including, if necessary, leading zeros to fill out the string. The length of the string is:

- 5 if the argument is a small integer with a scale of zero
- 10 if the argument is a large integer with a scale of zero
- 19 if the argument is a big integer
- p if the argument is a decimal (or an integer with a scale greater than zero) with a precision of p

The CCSID of the character string is the default SBCS CCSID at the current server.

Examples

- Assume that a table called TABLEX contains an INTEGER column called INTCOL containing 10-digit numbers. List all combinations of the first four digits contained in column INTCOL.

```
SELECT DISTINCT SUBSTR(DIGITS(INTCOL),1,4)
FROM TABLEX
```

- Assume that COLUMNX has the DECIMAL(6,2) data type, and that one of its values is -6.28.

```
SELECT DIGITS(COLUMNX)
FROM TABLEX
```

Returns the value '000628'.

The result is a string of length six (the precision of the column) with leading zeros padding the string out to this length. Neither sign nor decimal point appear in the result.

DLCOMMENT

The DLCOMMENT function returns the comment value, if it exists, from a DataLink value.

► DLCOMMENT — (— *DataLink-expression* —) ◄

DataLink-expression

An expression that results in a value with a built-in DataLink data type.

The result of the function is VARCHAR(254). If the argument can be null, the result can be null; if the argument is null, the result is the null value.

The CCSID of the character string is the same as that of *DataLink-expression*.

Examples

- Prepare a statement to select the date, the description and the comment from the link to the ARTICLES column from the HOCKEY_GOALS table. The rows to be selected are those for goals scored by either of the Richard brothers (Maurice or Henri).

```
stmtvar = "SELECT DATE_OF_GOAL, DESCRIPTION, DLCOMMENT(ARTICLES)
           FROM HOCKEY_GOALS
           WHERE BY_PLAYER = 'Maurice Richard'
           OR BY_PLAYER = 'Henri Richard' ";
EXEC SQL PREPARE HOCKEY_STMT FROM :stmtvar;
```

- Given a DataLink value that was inserted into column COLA of a row in table TBLA using the scalar function:

```
INSERT INTO TBLA
VALUES (DLVALUE('http://dlfs.almaden.ibm.com/x/y/a.b','URL','A comment'))
```

then the following function operating on that value:

```
SELECT DLCOMMENT(COLA)
FROM TBLA
```

Returns the value 'A comment'.

DLLINKTYPE

The DLLINKTYPE function returns the link type value from a DataLink value.

►► DLLINKTYPE — (— *DataLink-expression* —) ◄◄

DataLink-expression

An expression that results in a value with a built-in DataLink data type.

The result of the function is VARCHAR(4). If the argument can be null, the result can be null; if the argument is null, the result is the null value.

The CCSID of the character string is the same as that of *DataLink-expression*.

Examples

- Given a DataLink value that was inserted into column COLA of a row in table TBLA using the scalar function:

```
INSERT INTO TABLA
VALUES( DLVALUE('http://dfs.almaden.ibm.com/x/y/a.b','URL','A comment') )
```

then the following function operating on that value:

```
SELECT DLLINKTYPE(COLA)
FROM TBLA
```

Returns the value 'URL'.

DLURLCOMPLETE

The DLURLCOMPLETE function returns the complete URL value from a DataLink value with a link type of URL. The value is the same as what would be returned by the concatenation of DLURLSCHEME with '://', then DLURLSERVER, and then DLURLPATH. If the DataLink has an attribute of FILE LINK CONTROL and READ PERMISSION DB, the value includes a file access token.

►► DLURLCOMPLETE — (— *DataLink-expression* —) ►◄

DataLink-expression

An expression that results in a value with a built-in DataLink data type.

If the argument can be null, the result can be null; if the argument is null, the result is the null value.

The result of the function is a varying-length string. The length attribute depends on the attributes of the DataLink:

- If the DataLink has an attribute of FILE LINK CONTROL and READ PERMISSION DB, the length attribute of the result is the length attribute of the argument plus 19.
- Otherwise, the length attribute of the result is the length attribute of the argument.

If the DataLink value only includes the comment, the result returned is a zero length string.

The CCSID of the character string is the same as that of *DataLink-expression*.

Examples

- Given a DataLink value that was inserted into column COLA (with the attributes of FILE LINK CONTROL and READ PERMISSION DB) of a row in table TBLA using the scalar function:

```
INSERT INTO TABLA
VALUES( DLVALUE('http://dlfs.almaden.ibm.com/x/y/a.b','URL','A comment') )
```

then the following function operating on that value:

```
SELECT DLURLCOMPLETE(COLA)
FROM TBLA
```

Returns the value 'HTTP://DLFS.ALMADEN.IBM.COM/x/y/*****;a.b', where ***** represents the access token.

DLURLPATH

The DLURLPATH function returns the path and file name necessary to access a file within a given server from a DataLink value with a linktype of URL. When appropriate, the value includes a file access token.

►► DLURLPATH — (— *DataLink-expression* —) ◄◄

DataLink-expression

An expression that results in a value with a built-in DataLink data type.

If the argument can be null, the result can be null; if the argument is null, the result is the null value.

The result of the function is a varying-length string. The length attribute depends on the attributes of the DataLink:

- If the DataLink has an attribute of FILE LINK CONTROL and READ PERMISSION DB, the length attribute of the result is the length attribute of the argument plus 19.
- Otherwise, the length attribute of the result is the length attribute of the argument.

If the DataLink value only includes the comment, the result returned is a zero length string.

The CCSID of the character string is the same as that of *DataLink-expression*.

Examples

- Given a DataLink value that was inserted into column COLA (with the attributes of FILE LINK CONTROL and READ PERMISSION DB) of a row in table TBLA using the scalar function:

```
INSERT INTO TABLA
VALUES( DLVALUE('http://dlfs.almaden.ibm.com/x/y/a.b','URL','A comment') )
```

then the following function operating on that value:

```
SELECT DLURLPATH(COLA)
FROM TBLA
```

Returns the value '/x/y/*****;a.b', where ***** represents the access token.

DLURLPATHONLY

The DLURLPATHONLY function returns the path and file name necessary to access a file within a given server from a DataLink value with a linktype of URL. The value returned NEVER includes a file access token.

► DLURLPATHONLY — (— *DataLink-expression* —) ◄

DataLink-expression

An expression that results in a value with a built-in DataLink data type.

If the argument can be null, the result can be null; if the argument is null, the result is the null value.

The result of the function is a varying-length string with a length attribute of that is equal to the length attribute of the argument.

If the DataLink value only includes the comment, the result returned is a zero length string.

The CCSID of the character string is the same as that of *DataLink-expression*.

Examples

- Given a DataLink value that was inserted into column COLA of a row in table TBLA using the scalar function:

```
INSERT INTO TABLA
VALUES( DLVALUE('http://dlfs.almaden.ibm.com/x/y/a.b','URL','A comment') )
```

then the following function operating on that value:

```
SELECT DLURLPATHONLY(COLA)
FROM TBLA
```

Returns the value '/x/y/a.b'.

DLURLSCHEME

The DLURLSCHEME function returns the scheme from a DataLink value with a linktype of URL. The value will always be in upper case.

►► DLURLSCHEME — (— *DataLink-expression* —) ◄◄

DataLink-expression

An expression that results in a value with a built-in DataLink data type.

The result of the function is VARCHAR(20). If the argument can be null, the result can be null; if the argument is null, the result is the null value.

If the DataLink value only includes the comment, the result returned is a zero length string.

The CCSID of the character string is the same as that of *DataLink-expression*.

Examples

- Given a DataLink value that was inserted into column COLA of a row in table TBLA using the scalar function:

```
INSERT INTO TABLA
VALUES( DLVALUE('http://dfs.almaden.ibm.com/x/y/a.b','URL','A comment') )
```

then the following function operating on that value:

```
SELECT DLURLSCHEME(COLA)
FROM TBLA
```

Returns the value 'HTTP'.

DLURLSERVER

The DLURLSERVER function returns the file server from a DataLink value with a linktype of URL. The value will always be in upper case.

► DLURLSERVER (— *DataLink-expression* —) ◄

DataLink-expression

An expression that results in a value with a built-in DataLink data type.

If the argument can be null, the result can be null; if the argument is null, the result is the null value.

The result of the function is a varying-length string with a length attribute of that is equal to the length attribute of the argument.

If the DataLink value only includes the comment, the result returned is a zero length string.

The CCSID of the character string is the same as that of *DataLink-expression*.

Examples

- Given a DataLink value that was inserted into column COLA of a row in table TBLA using the scalar function:

```
INSERT INTO TABLA
VALUES( DLVALUE('http://dlfs.almaden.ibm.com/x/y/a.b','URL','A comment') )
```

then the following function operating on that value:

```
SELECT DLURLSERVER(COLA)
FROM TBLA
```

Returns the value 'DLFS.ALMA DEN.IBM.COM'.

DLVALUE

The DLVALUE function returns a DataLink value. When the function is on the right hand side of a SET clause in an UPDATE statement or is in a VALUES clause in an INSERT statement, it usually also creates a link to a file. However, if only a comment is specified (in which case the *data-location* is a zero-length string), the DataLink value is created with empty linkage attributes so there is no file link.

►► DLVALUE ►►

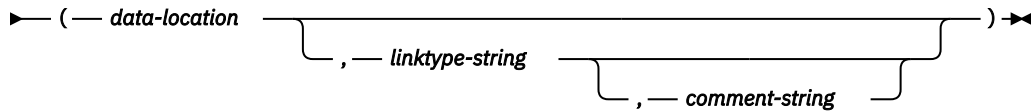

data-location

If the link type is URL, then this is a character string expression that contains a complete URL value. If the expression is not an empty string, it must include the URL scheme and URL server. The actual length of the character string expression must be less than or equal to 32718 characters.

linktype-string

An optional character string expression that specifies the link type of the DataLink value. The only valid value is 'URL'.

comment-string

An optional character string expression that provides a comment or additional location information. The actual length of the character string expression must be less than or equal to 254 characters.

The *comment-string* cannot be the null value. If a *comment-string* is not specified, the *comment-string* is the empty string.

If the first argument can be null, the result can be null; if the first argument is null, the result is the null value.

The result of the function is a DataLink value.

The CCSID of the DataLink is the same as that of *data-location* except in the following cases:

- If the *comment string* is mixed data and *data-location* is not mixed data, the CCSID of the result will be the CCSID of the *comment string*.⁵⁵
- If the *data-location* has a CCSID of bit data (65535), UTF-16 graphic data (1200), UCS-2 graphic data (13488), Turkish data (905 or 1026), or Japanese data (290, 930, or 5026); the CCSID of the result is described in the following table:

CCSID of <i>data-location</i>	CCSID of <i>comment-string</i>	Result CCSID
65535	65535	Job Default CCSID
65535	non-65535	<i>comment-string</i> CCSID (unless the CCSID is 290, 930, 5026, 905, 1026, or 13488 where the CCSID will then be further modified as described in the following rows.)
290	any	4396
930 or 5026	any	939
905 or 1026	any	500
1200	any	500
13488	any	500

⁵⁵ If the CCSID of *comment string* is 5026 or 930, the CCSID of the results will be 939.

When defining a DataLink value using this function, consider the maximum length of the target of the value. For example, if a column is defined as DataLink(200), then the maximum length of the *data-location* plus the comment is 200 bytes.

Examples

- Insert a row into the table. The URL values for the first two links are contained in the variables named url_article and url_snapshot. The variable named url_snapshot_comment contains a comment to accompany the snapshot link. There is, as yet, no link for the movie, only a comment in the variable named url_movie_comment.

```
INSERT INTO HOCKEY_GOALS
VALUES('Maurice Richard',
      'Montreal canadian',
      '?',
      'Boston Bruins',
      '1952-04-24',
      'Winning goal in game 7 of Stanley Cup final',
      DLVALUE(:url_article),
      DLVALUE(:url_snapshot, 'URL', :url_snapshot_comment),
      DLVALUE('', 'URL', :url_movie_comment) )
```

DOUBLE_PRECISION or DOUBLE

The DOUBLE_PRECISION and DOUBLE functions return a floating-point representation.

Numeric to Double

► DOUBLE_PRECISION (*numeric-expression*) ◄
DOUBLE

String to Double

► DOUBLE_PRECISION (*string-expression*) ◄
DOUBLE

The DOUBLE_PRECISION and DOUBLE functions return a floating-point representation of:

- A number
- A character or graphic string representation of a decimal number
- A character or graphic string representation of an integer
- A character or graphic string representation of a floating-point number
- A character or graphic string representation of a decimal floating-point number

Numeric to Double

numeric-expression

An expression that returns a value of any built-in numeric data type.

The result is the same number that would occur if the expression were assigned to a double-precision floating-point column or variable.

String to Double

string-expression

An expression that returns a value that is a character-string or graphic-string representation of a number.

If the argument is a *string-expression*, the result is the same number that would result from CAST(*string-expression* AS DOUBLE PRECISION). Leading and trailing blanks are eliminated and the resulting string must conform to the rules for forming a floating-point, decimal floating-point, integer, or decimal constant.

The single-byte character constant that must be used to delimit the decimal digits in *string-expression* from the whole part of the number is the default decimal point. For more information, see [“Decimal point”](#) on page 118.

The result of the function is a double-precision floating-point number. If the argument can be null, the result can be null; if the argument is null, the result is the null value.

Note

Syntax alternatives: FLOAT is a synonym for DOUBLE_PRECISION and DOUBLE.

The CAST specification should be used to increase the portability of applications. For more information, see [“CAST specification”](#) on page 177.

Example

- Using the EMPLOYEE table, find the ratio of salary to commission for employees whose commission is not zero. The columns involved (SALARY and COMM) have DECIMAL data types. To eliminate the possibility of out-of-range results, DOUBLE_PRECISION is applied to SALARY so that the division is carried out in floating point:

```
SELECT EMPNO, DOUBLE_PRECISION(SALARY)/COMM  
FROM EMPLOYEE  
WHERE COMM > 0
```

ENCRYPT_AES

The ENCRYPT_AES function returns a value that is the result of encrypting *data-string* using the AES encryption algorithm. The password used for decryption is either the *password-string* value or the encryption password value (assigned by the SET ENCRYPTION PASSWORD statement).

►► ENCRYPT_AES ►►

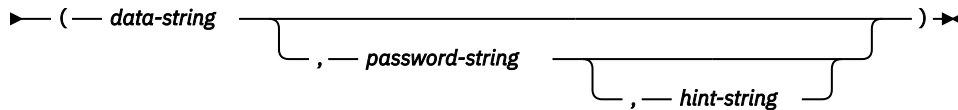

data-string

An expression that returns the string value to be encrypted. The string expression must be a built-in string data type.

The length attribute for the data type of *data-string* is limited to 24 bytes (or 32 bytes) less than the maximum length of the result data type without a *hint-string* argument and 56 bytes (or 64 bytes) less than the maximum length of the result data type when the *hint-string* argument is specified.

password-string

An expression that returns a character string value with at least 6 bytes and no more than 127 bytes. The expression must not be a CLOB and the CCSID of the expression must not be 65535. The value represents the password used to encrypt the *data-string*. If the value of the password argument is null or not provided, the data will be encrypted using the ENCRYPTION PASSWORD value, which must have been set using the SET ENCRYPTION PASSWORD statement.

hint-string

An expression that returns a character string value with up to 32 bytes that will help data owners remember passwords (For example, 'Ocean' is a hint to remember 'Pacific'). The expression must not be a CLOB and the CCSID of the expression must not be 65535. If a hint value is specified, the hint is embedded into the result and can be retrieved using the GETHINT function. If the *password-string* is specified and this argument is the null value or not provided, no hint will be embedded in the result. If the *password-string* is not specified, the hint may be specified using the SET ENCRYPTION PASSWORD statement.

The data type of the result is determined by the first argument as shown in the following table:

Data Type of the First Argument	Data Type of the Result
BINARY or VARBINARY	VARBINARY
CHAR, VARCHAR, GRAPHIC, or VARGRAPHIC	VARCHAR FOR BIT DATA
BLOB, CLOB, or DBCLOB	BLOB

The length attribute of the result depends on the arguments that are specified:

- When a *password-string* is specified but a *hint-string* is not specified, the length attribute of *data-string* plus 24 plus the number of bytes to a 16 byte boundary.
- Otherwise, the length attribute of *data-string* plus 64 plus the number of bytes to a 16 byte boundary.

The actual length of the result is the sum of :

- The actual length of *data-string* plus a number of bytes to get to a 16 byte boundary.
- The actual length of the hint.

The actual length of the hint is zero if *hint-string* is not specified as a function argument or on the SET ENCRYPTION PASSWORD statement.

- n , where n (the amount of overhead necessary to encrypt the value) is 24 bytes (or 32 bytes if *data-string* is a LOB or different CCSID values are used for the *data-string*, the password, or the hint).

If the first argument can be null, the result can be null; if the first argument is null, the result is the null value.

Note that the encrypted result is longer than the *data-string* value. Therefore, when assigning encrypted values, ensure that the target is declared with sufficient size to contain the entire encrypted value.

Notes

Password protection: To prevent inadvertent access to the encryption password, do not specify *password-string* as a string constant in the source for a program, procedure, or function. Instead, use the SET ENCRYPTION PASSWORD statement or a host variable.

When connected to a remote relational database, the specified password itself is sent "in the clear". That is, the password itself is not encrypted. To protect the password in these cases, consider using a communications encryption mechanism such as IPSEC (or SSL if connecting between IBM i products).

Encryption algorithm: The internal encryption algorithm used is from the CLiC Toolkit from IBM Research. The 128-bit encryption key is derived from the password using a SHA1 message digest.

Encryption passwords and data: It is the user's responsibility to perform password management. Once the data is encrypted only the password used to encrypt it can be used to decrypt it. Be careful when using CHAR variables to set password values as they may be padded with blanks. The encrypted result may contain a null terminator and other non-printable characters.

Table column definition: When defining columns and distinct types to contain encrypted data:

- The column must be defined with a data type of CHAR FOR BIT DATA, VARCHAR FOR BIT DATA, BINARY, VARBINARY, or BLOB.
- The length attribute of the column must include an additional n bytes, where n is the overhead necessary to encrypt the data as described above.

Any assignment or cast to a column without one of these data types or with a length shorter than the suggested data length may result in an assignment error or, if the assignment is successful, a failure and lost data when the data is subsequently decrypted. Blanks are valid encrypted data values that may be truncated when stored in a column that is too short.

Some sample column length calculations:

Maximum length of non-encrypted data	6 bytes
Number of bytes to the next 16 byte boundary	10 bytes
Overhead	24 bytes (or 32 bytes)

Encrypted data column length	40 bytes (or 48 bytes)
Maximum length of non-encrypted data	32 bytes
Number of bytes to a 16 byte boundary	0 bytes
Overhead	24 bytes (or 32 bytes)

Encrypted data column length	56 bytes

Administration of encrypted data: Encrypted data can only be decrypted on servers that support the decryption functions that correspond to the ENCRYPT_AES function. Hence, replication of columns with encrypted data should only be done to servers that support the decryption functions.

Example

- Assume that table EMP1 has a social security column called SSN. This example uses the ENCRYPTION PASSWORD value to hold the encryption password.

```
SET ENCRYPTION PASSWORD = 'Ben123'
INSERT INTO EMP1 (SSN) VALUES ENCRYPT_AES( '289-46-8832' )
```

- This example explicitly passes the encryption password.

```
INSERT INTO EMP1 (SSN) VALUES ENCRYPT_AES( '289-46-8832', 'Ben123' )
```

- The hint 'Ocean' is stored to help the user remember the encryption password 'Pacific'.

```
INSERT INTO EMP1 (SSN) VALUES ENCRYPT_AES( '289-46-8832', 'Pacific', 'Ocean' )
```

ENCRYPT_RC2

The ENCRYPT_RC2 function returns a value that is the result of encrypting *data-string* using the RC2 encryption algorithm. The password used for decryption is either the *password-string* value or the encryption password value (assigned by the SET ENCRYPTION PASSWORD statement).

►► ENCRYPT_RC2 ►►

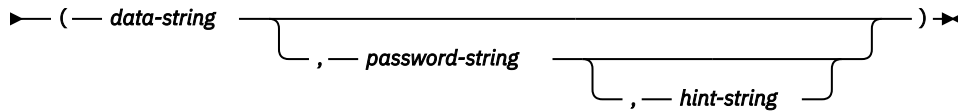

data-string

An expression that returns the string value to be encrypted. The string expression must be a built-in string data type.

The length attribute for the data type of *data-string* must be less than $m - \text{MOD}(m,8) - n - 1$, where m is the maximum length of the result data type and n is the amount of overhead necessary to encrypt the value.

- If a *hint-string* is not specified, n is 8 bytes.
- If a *hint-string* is specified, n is 40 bytes.

password-string

An expression that returns a character string value with at least 6 bytes and no more than 127 bytes. The expression must not be a CLOB. The value represents the password used to encrypt the *data-string*. If the value of the password argument is null or not provided, the data will be encrypted using the ENCRYPTION PASSWORD value, which must have been set using the SET ENCRYPTION PASSWORD statement.

hint-string

An expression that returns a character string value with up to 32 bytes that will help data owners remember passwords (For example, 'Ocean' is a hint to remember 'Pacific'). The expression must not be a CLOB. If a hint value is specified, the hint is embedded into the result and can be retrieved using the GETHINT function. If the *password-string* is specified and this argument is the null value or not provided, no hint will be embedded in the result. If the *password-string* is not specified, the hint may be specified using the SET ENCRYPTION PASSWORD statement.

The data type of the result is determined by the first argument as shown in the following table:

Data Type of the First Argument	Data Type of the Result
BINARY or VARBINARY	VARBINARY
CHAR, VARCHAR, GRAPHIC, or VARGRAPHIC	VARCHAR FOR BIT DATA
BLOB, CLOB, or DBCLOB	BLOB

The length attribute of the result depends on the arguments that are specified:

- When a *password-string* is specified but a *hint-string* is not specified, the length attribute of *data-string* plus 16 plus the number of bytes to the next 8 byte boundary.⁵⁶
- Otherwise, the length attribute of *data-string* plus 48 plus the number of bytes to the next 8 byte boundary.⁵⁶

The actual length of the result is the sum of :

- The actual length of *data-string* plus a number of bytes to get to the next 8 byte boundary.⁵⁶

⁵⁶ Unlike ENCRYPT_TDES and ENCRYPT_AES, 8 bytes are added even if the length of *data-string* is already on an 8 byte boundary.

- The actual length of the hint.

The actual length of the hint is zero if *hint-string* is not specified as a function argument or on the SET ENCRYPTION PASSWORD statement.

- *n*, where *n* (the amount of overhead necessary to encrypt the value) is 8 bytes (or 16 bytes if *data-string* is a LOB or different CCSID values are used for the *data-string*, the password, or the hint).

If the argument can be null, the result can be null; if the argument is null, the result is the null value.

Note that the encrypted result is longer than the *data-string* value. Therefore, when assigning encrypted values, ensure that the target is declared with sufficient size to contain the entire encrypted value.

Notes

Password protection: To prevent inadvertent access to the encryption password, do not specify *password-string* as a string constant in the source for a program, procedure, or function. Instead, use the SET ENCRYPTION PASSWORD statement or a host variable.

When connected to a remote relational database, the specified password itself is sent "in the clear". That is, the password itself is not encrypted. To protect the password in these cases, consider using a communications encryption mechanism such as IPSEC (or SSL if connecting between IBM i products).

Encryption algorithm: The internal encryption algorithm used is RC2 block cipher with padding, the 128 bit secret key is derived from the password using a MD5 message digest.

Encryption passwords and data: It is the user's responsibility to perform password management. Once the data is encrypted only the password used to encrypt it can be used to decrypt it. Be careful when using CHAR variables to set password values as they may be padded with blanks. The encrypted result may contain a null terminator and other non-printable characters.

Table column definition: When defining columns and distinct types to contain encrypted data:

- The column must be defined with a data type of CHAR FOR BIT DATA, VARCHAR FOR BIT DATA, BINARY, VARBINARY, or BLOB.
- The length attribute of the column must include an additional *n* bytes, where *n* is the overhead necessary to encrypt the data as described above.

Any assignment or cast to a column without one of these data types or with a length shorter than the suggested data length may result in an assignment error or, if the assignment is successful, a failure and lost data when the data is subsequently decrypted. Blanks are valid encrypted data values that may be truncated when stored in a column that is too short.

Some sample column length calculations:

Maximum length of non-encrypted data	6 bytes
Number of bytes to the next 8 byte boundary	2 bytes
Overhead	8 bytes (or 16 bytes)

Encrypted data column length	16 bytes (or 32 bytes)
Maximum length of non-encrypted data	32 bytes
Number of bytes to the next 8 byte boundary	8 bytes
Overhead	8 bytes (or 16 bytes)

Encrypted data column length	48 bytes (or 56 bytes)

Administration of encrypted data: Encrypted data can only be decrypted on servers that support the decryption functions that correspond to the ENCRYPT_RC2 function. Hence, replication of columns with encrypted data should only be done to servers that support the decryption functions.

Syntax alternatives: For compatibility with previous versions of Db2, ENCRYPT can be specified in place of ENCRYPT_RC2.

Example

- Assume that table EMP1 has a social security column called SSN. This example uses the ENCRYPTION PASSWORD value to hold the encryption password.

```
SET ENCRYPTION PASSWORD = 'Ben123'
```

```
INSERT INTO EMP1 (SSN) VALUES ENCRYPT_RC2( '289-46-8832' )
```

- This example explicitly passes the encryption password.

```
INSERT INTO EMP1 (SSN) VALUES ENCRYPT_RC2( '289-46-8832', 'Ben123' )
```

- The hint 'Ocean' is stored to help the user remember the encryption password 'Pacific'.

```
INSERT INTO EMP1 (SSN) VALUES ENCRYPT_RC2( '289-46-8832', 'Pacific', 'Ocean' )
```

ENCRYPT_TDES

The ENCRYPT_TDES function returns a value that is the result of encrypting *data-string* using the Triple DES encryption algorithm. The password used for decryption is either the *password-string* value or the encryption password value (assigned by the SET ENCRYPTION PASSWORD statement).

►► ENCRYPT_TDES ►►

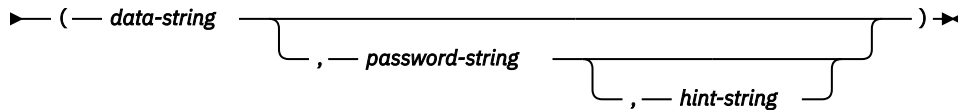

data-string

An expression that returns the string value to be encrypted. The string expression must be a built-in string data type.

The length attribute for the data type of *data-string* must be less than $m - \text{MOD}(m,8) - n - 1$, where m is the maximum length of the result data type and n is the amount of overhead necessary to encrypt the value.

password-string

An expression that returns a character string value with at least 6 bytes and no more than 127 bytes. The expression must not be a CLOB and the CCSID of the expression must not be 65535. The value represents the password used to encrypt the *data-string*. If the value of the password argument is null or not provided, the data will be encrypted using the ENCRYPTION PASSWORD value, which must have been set using the SET ENCRYPTION PASSWORD statement.

hint-string

An expression that returns a character string value with up to 32 bytes that will help data owners remember passwords (For example, 'Ocean' is a hint to remember 'Pacific'). The expression must not be a CLOB and the CCSID of the expression must not be 65535. If a hint value is specified, the hint is embedded into the result and can be retrieved using the GETHINT function. If the *password-string* is specified and this argument is the null value or not provided, no hint will be embedded in the result. If the *password-string* is not specified, the hint may be specified using the SET ENCRYPTION PASSWORD statement.

The data type of the result is determined by the first argument as shown in the following table:

Data Type of the First Argument	Data Type of the Result
BINARY or VARBINARY	VARBINARY
CHAR, VARCHAR, GRAPHIC, or VARGRAPHIC	VARCHAR FOR BIT DATA
BLOB, CLOB, or DBCLOB	BLOB

The length attribute of the result depends on the arguments that are specified:

- When a *password-string* is specified but a *hint-string* is not specified, the length attribute of *data-string* plus 24 plus the number of bytes to an 8 byte boundary.
- Otherwise, the length attribute of *data-string* plus 56 plus the number of bytes to an 8 byte boundary.

The actual length of the result is the sum of :

- The actual length of *data-string* plus a number of bytes to get to the an 8 byte boundary.
- The actual length of the hint.

The actual length of the hint is zero if *hint-string* is not specified as a function argument or on the SET ENCRYPTION PASSWORD statement.

- n , where n (the amount of overhead necessary to encrypt the value) is 16 bytes (or 24 bytes if *data-string* is a LOB or different CCSID values are used for the *data-string*, the password, or the hint).

If the argument can be null, the result can be null; if the argument is null, the result is the null value.

Note that the encrypted result is longer than the *data-string* value. Therefore, when assigning encrypted values, ensure that the target is declared with sufficient size to contain the entire encrypted value.

Notes

Password protection: To prevent inadvertent access to the encryption password, do not specify *password-string* as a string constant in the source for a program, procedure, or function. Instead, use the SET ENCRYPTION PASSWORD statement or a host variable.

When connected to a remote relational database, the specified password itself is sent "in the clear". That is, the password itself is not encrypted. To protect the password in these cases, consider using a communications encryption mechanism such as IPSEC (or SSL if connecting between IBM i products).

Encryption algorithm: The internal encryption algorithm used is Triple DES block cipher with padding, the 128 bit secret key is derived from the password using a SHA1 message digest.

Encryption passwords and data: It is the user's responsibility to perform password management. Once the data is encrypted only the password used to encrypt it can be used to decrypt it. Be careful when using CHAR variables to set password values as they may be padded with blanks. The encrypted result may contain a null terminator and other non-printable characters.

Table column definition: When defining columns and distinct types to contain encrypted data:

- The column must be defined with a data type of CHAR FOR BIT DATA, VARCHAR FOR BIT DATA, BINARY, VARBINARY, or BLOB.
- The length attribute of the column must include an additional n bytes, where n is the overhead necessary to encrypt the data as described above.

Any assignment or cast to a column without one of these data types or with a length shorter than the suggested data length may result in an assignment error or, if the assignment is successful, a failure and lost data when the data is subsequently decrypted. Blanks are valid encrypted data values that may be truncated when stored in a column that is too short.

Some sample column length calculations:

Maximum length of non-encrypted data	6 bytes
Number of bytes to the next 8 byte boundary	2 bytes
Overhead	16 bytes (or 24 bytes)

Encrypted data column length	24 bytes (or 32 bytes)
Maximum length of non-encrypted data	32 bytes
Number of bytes to an 8 byte boundary	0 bytes
Overhead	16 bytes (or 24 bytes)

Encrypted data column length	48 bytes (or 56 bytes)

Administration of encrypted data: Encrypted data can only be decrypted on servers that support the decryption functions that correspond to the ENCRYPT_TDES function. Hence, replication of columns with encrypted data should only be done to servers that support the decryption functions.

Example

- Assume that table EMP1 has a social security column called SSN. This example uses the ENCRYPTION PASSWORD value to hold the encryption password.

```
SET ENCRYPTION PASSWORD = 'Ben123'
INSERT INTO EMP1 (SSN) VALUES ENCRYPT_TDES( '289-46-8832' )
```

- This example explicitly passes the encryption password.

```
INSERT INTO EMP1 (SSN) VALUES ENCRYPT_TDES( '289-46-8832', 'Ben123' )
```

- The hint 'Ocean' is stored to help the user remember the encryption password 'Pacific'.

```
INSERT INTO EMP1 (SSN) VALUES ENCRYPT_TDES( '289-46-8832', 'Pacific', 'Ocean' )
```

EXP

The EXP function returns a value that is the base of the natural logarithm (e) raised to a power specified by the argument. The EXP and LN functions are inverse operations.

► EXP — (— *expression* —) ►

expression

An expression that returns a value of any built-in numeric, character-string, or graphic-string data type. A string argument is cast to double-precision floating point before evaluating the function. For more information about converting strings to double-precision floating point, see [“DOUBLE_PRECISION or DOUBLE”](#) on page 391.

If the data type of the argument is DECFLOAT(*n*), the result is DECFLOAT(*n*). Otherwise, the data type of the result is double-precision floating point. If the argument can be null, the result can be null; if the argument is null, the result is the null value.

Note

Results involving DECFLOAT special values: For decimal floating-point values the special values are treated as follows:

- EXP(NaN) returns NaN.
- EXP(-NaN) returns -NaN.
- EXP(Infinity) returns Infinity.
- EXP(-Infinity) returns 0.
- EXP(sNaN) and EXP(-sNaN) return a warning or error.⁵⁷

Example

- Assume the host variable E is a DECIMAL(10,9) host variable with a value of 3.453789832.

```
SELECT EXP(:E)
FROM SYSIBM.SYSDUMMY1
```

Returns the approximate value 31.62.

⁵⁷ If *YES is specified for the SQL_DECFLOAT_WARNINGS query option, NaN and -NaN are returned respectively with a warning.

EXTRACT

The EXTRACT function returns a specified portion of a datetime value.

Extract Date Values

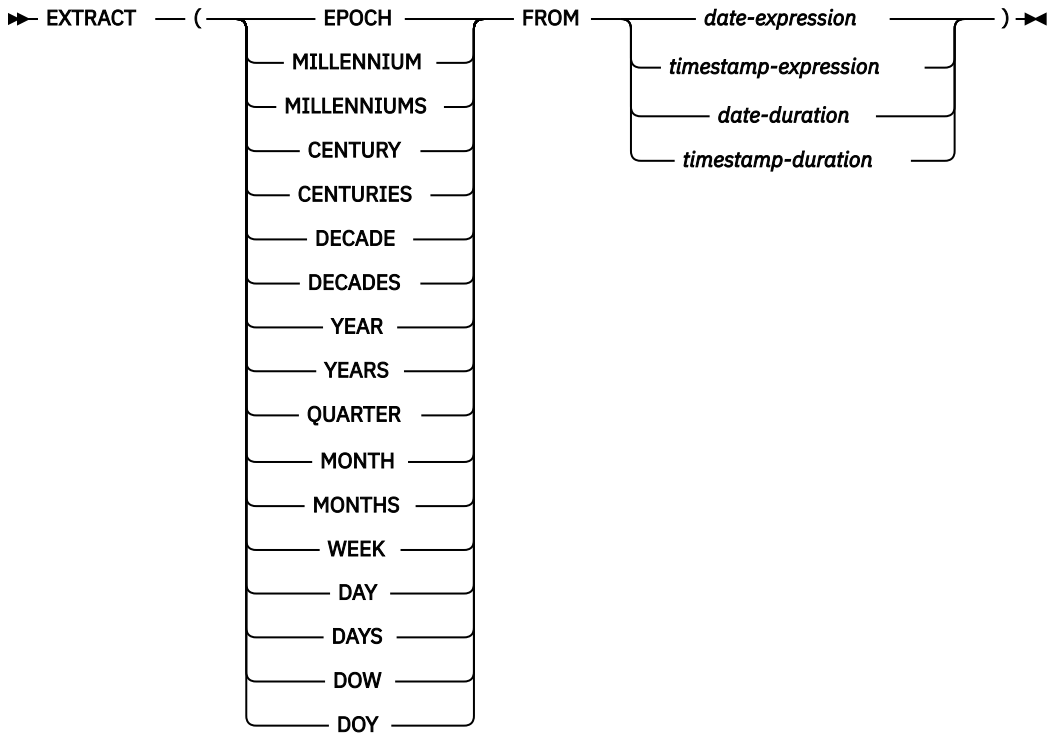

Extract Time Values

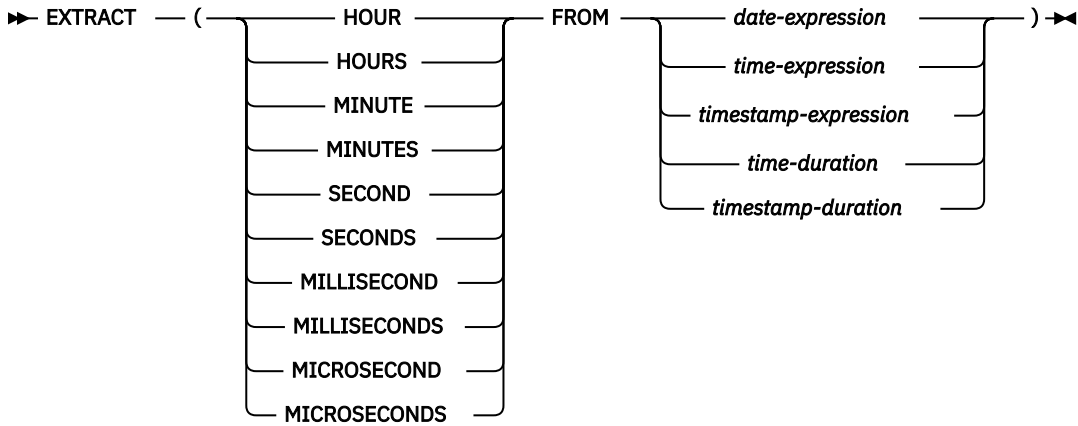

Extract Date Values

EPOCH

Specifies that the number of seconds since 1970-01-01 00:00:00.00 is returned for the *date-expression* or *timestamp-expression*. The value can be positive or negative. This cannot be specified for a *date-duration* or *timestamp-duration*.

MILLENNIUM or MILLENNIUMS

Specifies that the number of full 1000-year periods represented by the year is returned for the *date-expression*, *timestamp-expression*, *date-duration*, or *timestamp-duration*. For example, 2 is returned for a date between 2000-01-01 and 2999-12-31.

CENTURY or CENTURIES

Specifies that the number of full 100-year periods represented by the year is returned for the *date-expression*, *timestamp-expression*, *date-duration*, or *timestamp-duration*. For example, 20 is returned for a date between 2000-01-01 and 2099-12-31.

DECADE or DECADES

Specifies that the number of full 10-year periods represented by the year is returned for the *date-expression*, *timestamp-expression*, *date-duration*, or *timestamp-duration*. For example, 201 is returned for a date between 2010-01-01 and 2019-12-31.

YEAR or YEARS

Specifies that the year portion of the *date-expression*, *timestamp-expression*, *date-duration*, or *timestamp-duration* is returned. The result is identical to the YEAR scalar function. For more information, see [“YEAR” on page 675](#).

QUARTER

Specifies that the quarter of the year (1 - 4) is returned for the *date-expression* or *timestamp-expression*. The result is identical to the QUARTER scalar function. For more information, see [“QUARTER” on page 527](#). This cannot be specified for a *date-duration* or *timestamp-duration*.

MONTH or MONTHS

Specifies that the month portion of the *date-expression*, *timestamp-expression*, *date-duration*, or *timestamp-duration* is returned. The result is identical to the MONTH scalar function. For more information, see [“MONTH” on page 493](#).

WEEK

Specifies that the number of the week of the year (1 - 53) is returned for the *date-expression* or *timestamp-expression*. The week starts with Monday. The result is identical to the WEEK_ISO scalar function. For more information, see [“WEEK_ISO” on page 640](#). This cannot be specified for a *date-duration* or *timestamp-duration*.

DAY or DAYS

Specifies that the day portion of the *date-expression*, *timestamp-expression*, *date-duration* or *timestamp-duration* is returned. The result is identical to the DAY scalar function. For more information, see [“DAY” on page 353](#).

DOW

Specifies that the day of the week, where 1 represents Sunday and 7 represents Saturday, is returned for the *date-expression* or *timestamp-expression*. The result is identical to the DAYOFWEEK scalar function. For more information, see [“DAYOFWEEK” on page 356](#). This cannot be specified for a *date-duration* or *timestamp-duration*.

DOY

Specifies that the day of the year (1 - 366) is returned for the *date-expression* or *timestamp-expression*. The result is identical to the DAYOFYEAR scalar function. For more information, see [“DAYOFYEAR” on page 358](#). This cannot be specified for a *date-duration* or *timestamp-duration*.

date-expression

An expression that returns the value of either a built-in date, built-in character string, or built-in graphic string data type.

If *date-expression* is a character or graphic string, its value must be a valid character-string or graphic-string representation of a date. For the valid formats of string representations of dates, see [“String representations of datetime values” on page 75](#).

timestamp-expression

An expression that returns the value of either a built-in timestamp, built-in character string, or built-in graphic string data type.

If *timestamp-expression* is a character or graphic string, its value must be a valid character-string or graphic-string representation of a timestamp. For the valid formats of string representations of timestamps, see [“String representations of datetime values” on page 75](#).

date-duration

A date duration expressed as a DECIMAL(8,0) number. For the valid formats of datetime durations, see [“Datetime operands and durations” on page 166](#).

timestamp-duration

A timestamp duration expressed as a DECIMAL(14+s,s) number, where s is the number of digits of fractional seconds ranging from 0 to 12. For the valid formats of datetime durations, see [“Datetime operands and durations”](#) on page 166.

Extract Time Values

HOURL or HOURS

Specifies that the hour portion of the *time-expression*, *timestamp-expression*, *time-duration*, or *timestamp-duration* is returned. Returns 0 for a *date-expression*. The result is identical to the HOUR scalar function. For more information, see [“HOURL”](#) on page 429.

MINUTE or MINUTES

Specifies that the minute portion of the *time-expression*, *timestamp-expression*, *time-duration*, or *timestamp-duration* is returned. Returns 0 for a *date-expression*. The result is identical to the MINUTE scalar function. For more information, see [“MINUTE”](#) on page 490.

SECOND or SECONDS

Specifies that the second portion of the *time-expression*, *timestamp-expression*, *time-duration*, or *timestamp-duration* is returned. Returns 0 for a *date-expression*. The result is identical to:

- SECOND(expression, 6) when the data type of expression is a TIME value, a string representation of a TIME or TIMESTAMP, or a time duration.
- SECOND(expression, s) when the data type of expression is a TIMESTAMP(s) value or a timestamp duration.

For more information, see [“SECOND”](#) on page 563.

MILLISECOND or MILLISECONDS

Specifies the second of the minute, including fractional parts to one thousandth of a second, multiplied by 1000 is returned (0 - 59999) for the *timestamp-expression* or *timestamp-duration*. Returns 0 for a *date-expression*, *time-expression*, or *time-duration*.

MICROSECOND or MICROSECONDS

Specifies the second of the minute, including fractional parts to one millionth of a second, multiplied by 1000000 is returned (0 - 59999999) for the *timestamp-expression* or *timestamp-duration*. Returns 0 for a *date-expression*, *time-expression*, or *time-duration*.

date-expression

An expression that returns the value of either a built-in date, built-in character string, or built-in graphic string data type.

If *date-expression* is a character or graphic string, its value must be a valid character-string or graphic-string representation of a date. If *expression* is a valid string representation of a date, it must be one of the IBM SQL standard formats. For the valid formats of string representations of dates, see [“String representations of datetime values”](#) on page 75.

time-expression

An expression that returns the value of either a built-in time, built-in character string, or built-in graphic string data type.

If *time-expression* is a character or graphic string, its value must be a valid character-string or graphic-string representation of a time. For the valid formats of string representations of times, see [“String representations of datetime values”](#) on page 75.

timestamp-expression

An expression that returns the value of either a built-in timestamp, built-in character string, or built-in graphic string data type.

If *timestamp-expression* is a character or graphic string, its value must be a valid character-string or graphic-string representation of a timestamp. For the valid formats of string representations of timestamps, see [“String representations of datetime values”](#) on page 75.

time-duration

A time duration expressed as a DECIMAL(6,0) number. For the valid formats of datetime durations, see [“Datetime operands and durations”](#) on page 166.

timestamp-duration

A timestamp duration expressed as a DECIMAL(14+s,s) number, where s is the number of digits of fractional seconds ranging from 0 to 12. For the valid formats of datetime durations, see [“Datetime operands and durations”](#) on page 166.

The data type of the result of the function depends on the part of the datetime value that is specified:

- If EPOCH is specified, the data type of result is BIGINT.
- If MILLENNIUM, CENTURY, DECADE, YEAR, QUARTER, MONTH, WEEK, DAY, DOW, DOY, HOUR, MINUTE, MILLISECOND, or MICROSECOND is specified, the data type of the result is INTEGER.
- If SECOND is specified with a `TIMESTAMP(p)` value, the data type of the result is DECIMAL(2+p,p) where p is the fractional seconds precision.
- If SECOND is specified with a TIME value or a string representation of a TIME or TIMESTAMP, the data type of the result is DECIMAL(8,6).

If the argument can be null, the result can be null; if the argument is null, the result is the null value.

Examples

- Assume the column PRSDATE has an internal value equivalent to 1988-12-25.

```
SELECT EXTRACT( MONTH FROM PRSDATE )
FROM PROJECT
```

This statement returns the integer value 12.

- Assume the timestamp global variable GV1 has the value '2007-02-14 12:15:06.123456'.

```
VALUES EXTRACT(MILLISECONDS FROM GV1);
```

This statement returns the integer value 6123.

- Assume the timestamp global variable GV1 has the value '2007-02-14 12:15:06.123456'.

```
VALUES EXTRACT(MICROSECONDS FROM GV1);
```

This statement returns the integer value 6123456.

- Assume the date global variable GV2 has the value '2013-02-14'.

```
VALUES EXTRACT(DECADE FROM GV2);
```

This statement returns the integer value 201.

- Assume the decimal(6,0) global variable GV3 has the value 123020.

```
VALUES EXTRACT(SECONDS FROM GV3);
```

This statement returns the integer value 20.

FLOAT

The FLOAT function returns a floating point representation of a number or string.

Numeric to Float

►► FLOAT (— *numeric-expression* —) ◄◄

String to Float

►► FLOAT (— *string-expression* —) ◄◄

FLOAT is a synonym for the DOUBLE_PRECISION and DOUBLE functions. For more information, see [“DOUBLE_PRECISION or DOUBLE” on page 391.](#)

FLOOR

The FLOOR function returns the largest integer value less than or equal to *expression*.

► FLOOR — (— *expression* —) ►

expression

An expression that returns a value of any built-in numeric, character-string, or graphic-string data type. A string argument is cast to double-precision floating point before evaluating the function. For more information about converting strings to double-precision floating point, see [“DOUBLE_PRECISION or DOUBLE”](#) on page 391.

The result of the function has the same data type and length attribute as the argument except that the scale is 0 if the argument is a decimal number. For example, an argument with a data type of DECIMAL(5,5) will result in DECIMAL(5,0).

If the argument can be null, the result can be null; if the argument is null, the result is the null value.

Note

Results involving DECFLOAT special values: For decimal floating-point values, the special values are treated as follows:

- FLOOR(NaN) returns NaN.
- FLOOR(-NaN) returns -NaN.
- FLOOR(Infinity) returns Infinity.
- FLOOR(-Infinity) returns -Infinity.
- FLOOR(sNaN) and FLOOR(-sNaN) returns a warning or error.⁵⁸

Example

- Use the FLOOR function to truncate any digits to the right of the decimal point.

```
SELECT FLOOR(SALARY)
FROM EMPLOYEE
```

- Use FLOOR on both positive and negative numbers.

```
SELECT FLOOR( 3.5),
       FLOOR( 3.1),
       FLOOR(-3.1),
       FLOOR(-3.5)
FROM SYSIBM.SYSDUMMY1
```

This example returns:

```
3.    3.   -4.   -4.
```

respectively.

⁵⁸ If *YES is specified for the SQL_DECFLOAT_WARNINGS query option, NaN and -NaN are returned respectively with a warning.

GENERATE_UNIQUE

The GENERATE_UNIQUE function returns a bit data character string 13 bytes long (CHAR(13) FOR BIT DATA) that is unique compared to any other execution of the same function. The function is defined as non-deterministic

►► GENERATE_UNIQUE — (—) ►►

The result of the function is a unique value that includes the internal form of the Universal Time, Coordinated (UTC) and the system serial number. The result cannot be null.

The result of this function can be used to provide unique values in a table. Each successive value will be greater than the previous value, providing a sequence that can be used within a table. The sequence is based on the time when the function was executed.

This function differs from using the special register CURRENT_TIMESTAMP in that a unique value is generated for each instance of the function in an SQL statement and each row of a multiple row insert statement, an insert statement with a fullselect, or an insert statement in a MERGE statement.

The timestamp value that is part of the result of this function can be determined using the TIMESTAMP function with the result of GENERATE_UNIQUE as an argument.

Examples

- Create a table that includes a column that is unique for each row. Populate this column using the GENERATE_UNIQUE function. Notice that the UNIQUE_ID column is defined as FOR BIT DATA to identify the column as a bit data character string.

```
CREATE TABLE EMP_UPDATE
(UNIQUE_ID CHAR(13) FOR BIT DATA,
 EMPNO CHAR(6),
 TEXT VARCHAR(1000))
INSERT INTO EMP_UPDATE VALUES (GENERATE_UNIQUE(),
                                '000020',
                                'Update entry 1...')
INSERT INTO EMP_UPDATE VALUES (GENERATE_UNIQUE(),
                                '000050',
                                'Update entry 2...')
```

This table will have a unique identifier for each row provided that the UNIQUE_ID column is always set using GENERATE_UNIQUE. This can be done by introducing a trigger on the table.

```
CREATE TRIGGER EMP_UPDATE_UNIQUE
NO CASCADE BEFORE INSERT ON EMP_UPDATE
REFERENCING NEW AS NEW_UPD
FOR EACH ROW MODE DB2SQL
SET NEW_UPD.UNIQUE_ID = GENERATE_UNIQUE()
```

With this trigger, the previous INSERT statements that were used to populate the table can be issued without specifying a value for the UNIQUE_ID column:

```
INSERT INTO EMP_UPDATE(EMPNO, TEXT) VALUES ('000020', 'Update entry 1...')
INSERT INTO EMP_UPDATE(EMPNO, TEXT) VALUES ('000050', 'Update entry 2...')
```

The timestamp (in UTC) for when a row was added to EMP_UPDATE can be returned using:

```
SELECT TIMESTAMP(UNIQUE_ID), EMPNO, TEXT FROM EMP_UPDATE
```

Therefore, the table does not need a timestamp column to record when a row is inserted.

GET_BLOB_FROM_FILE

The GET_BLOB_FROM_FILE function returns the data from a source stream file or a source physical file.

► GET_BLOB_FROM_FILE (— *string-expression* — , — *integer*) ►

string-expression

The argument must be a string expression that specifies a path and file name. The file name may be a name of a source stream file or a source physical file. For a source physical file, the string must be in the form 'library/file(member)'.

integer

An integer constant that specifies how to handle trailing whitespace when the specified file is a source physical file. Valid values are:

- 0 whitespace is returned as it exists in the file
- 1 trailing whitespace (blanks) is removed except for the first trailing blank

If this argument is not specified for a source physical file, the default is 0. If it is specified for a source stream file, it is ignored.

The result of the function is a BLOB locator.

The function will read the file specified by the argument with no CCSID conversion and return it as a BLOB locator. The function must be run under commitment control. The locator will be freed when a COMMIT or ROLLBACK is performed.

Examples

Register an XML schema document in the XSR registry where the XML schema is in a source stream file.

```
CALL XSR_REGISTER ('myschemalib', 'myschema', NULL,  
GET_BLOB_FROM_FILE('/home/XML/MySchema.XSD',0), NULL)
```

GET_CLOB_FROM_FILE

The GET_CLOB_FROM_FILE function returns the data from a source stream file or a source physical file.

► GET_CLOB_FROM_FILE (— *string-expression* — , — *integer* —) ►

string-expression

The argument must be a string expression that specifies a path and file name. The file name may be a name of a source stream file or a source physical file. For a source physical file, the string must be in the form 'library/file(member)'.

integer

An integer constant that specifies how to handle trailing whitespace when the specified file is a source physical file. Valid values are:

- | | |
|---|---|
| 0 | whitespace is returned as it exists in the file |
| 1 | trailing whitespace (blanks) is removed except for the first trailing blank |

If this argument is not specified for a source physical file, the default is 0. If it is specified for a source stream file, it is ignored.

The result of the function is a CLOB locator.

The function will read the file specified by the argument, convert the data to the default job CCSID, and return it as a CLOB locator. The function must be run under commitment control. The locator will be freed when a COMMIT or ROLLBACK is performed.

Examples

Assign the data contained in the source file to host variable HV1. The data will be converted to the default job CCSID and trailing blanks from each line of the source file will be removed.

```
SET :HV1 = GET_CLOB_FROM_FILE('MYLIB/MYFILE(MYMBR)',1)
```

GET_DBCLOB_FROM_FILE

The GET_DBCLOB_FROM_FILE function returns the data from a source stream file or a source physical file.

► GET_DBCLOB_FROM_FILE (— *string-expression* — , — *integer*) ►

string-expression

The argument must be a string expression that specifies a path and file name. The file name may be a name of a source stream file or a source physical file. For a source physical file, the string must be in the form 'library/file(member)!'.

integer

An integer constant that specifies how to handle trailing whitespace when the specified file is a source physical file. Valid values are:

- | | |
|---|---|
| 0 | whitespace is returned as it exists in the file |
| 1 | trailing whitespace (blanks) is removed except for the first trailing blank |

If this argument is not specified for a source physical file, the default is 0. If it is specified for a source stream file, it is ignored.

The result of the function is a DBCLOB locator.

The function will read the file specified by the argument, convert the data to the double-byte CCSID associated with the default CCSID, and return it as a DBCLOB locator. The function must be run under commitment control. The locator will be freed when a COMMIT or ROLLBACK is performed.

Examples

Assign the data contained in the source stream file to host variable HV1. The data will be converted to the double-byte CCSID associated with the default CCSID.

```
SET :HV1 = GET_DBCLOB_FROM_FILE('/home/XML/MySchema.XSD')
```

GET_XML_FILE

The GET_XML_FILE function returns the data from a source stream file or a source physical file.

►► GET_XML_FILE (— *string-expression* —) ►►

string-expression

The argument must be a string expression that specifies a path and file name. The file name may be a name of a source stream file or a source physical file. For a source physical file, the string must be in the form 'library/file(member)'.

The result of the function is a BLOB locator.

The function will read the file specified by the argument and convert the data to UTF-8. If the file does not contain an XML declaration, one will be added. It will return it as a BLOB locator. The function must be run under commitment control. The locator will be freed when a COMMIT or ROLLBACK is performed.

Examples

Register an XML schema document in the XSR registry where the XML schema is in a source stream file.

```
CALL XSR_REGISTER ('myschemalib', 'myschema', NULL,  
GET_XML_FILE('/home/XML/MySchema.XSD'), NULL)
```

GETHINT

The GETHINT function will return the password hint if one is found in the *encrypted-data*. A password hint is a phrase that will help data owners remember passwords (For example, 'Ocean' as a hint to remember 'Pacific').

► GETHINT (— *encrypted-data* —) ►

encrypted-data

An expression that must be a string expression that returns a complete, encrypted data value of a CHAR FOR BIT DATA, VARCHAR FOR BIT DATA, BINARY, VARBINARY, or BLOB built-in data type. The data string must have been encrypted using the ENCRYPT_RC2 or ENCRYPT_TDES function.

The data type of the result is VARCHAR(32). The actual length of the result is the actual length of the hint that was provided when the data was encrypted.

The result can be null. If the argument is null or if a hint was not added to the *encrypted-data* by the ENCRYPT_RC2 or ENCRYPT_TDES function, the result is the null value.

The CCSID of the result is the default CCSID of the current server.

Example

- The hint 'Ocean' is stored to help the user remember the encryption password 'Pacific'.

```
INSERT INTO EMP1 (SSN) VALUES ENCRYPT_RC2( '289-46-8832', 'Pacific', 'Ocean' )
SELECT GETHINT( SSN )
FROM EMP1
```

The GETHINT function returns the original hint value 'Ocean'.

GRAPHIC

The GRAPHIC function returns a fixed-length graphic-string representation of a string expression.

Integer to Graphic

►► GRAPHIC — (— *integer-expression* —) ►►

Decimal to GRAPHIC

►► GRAPHIC — (— *decimal-expression* — , — *decimal-character* —) ►►

Floating-point to GRAPHIC

►► GRAPHIC — (— *floating-point-expression* — , — *decimal-character* —) ►►

Decimal floating-point to GRAPHIC

►► GRAPHIC — (— *decimal-floating-point-expression* — , — *decimal-character* —) ►►

Character to Graphic

►► GRAPHIC — (— *character-expression* — ►
 — , — *length* — , — *integer* —) ►►
 DEFAULT

Graphic to Graphic

►► GRAPHIC — (— *graphic-expression* — , — *length* — , — *integer* —) ►►
 DEFAULT

Datetime to Graphic

►► GRAPHIC — (— *datetime-expression* — , — *ISO* — , — *USA* — , — *EUR* — , — *JIS* — , — *LOCAL* —) ►►

The GRAPHIC function returns a graphic-string representation of:

- An integer number if the first argument is a SMALLINT, INTEGER, or BIGINT
- A decimal number if the first argument is a packed or zoned decimal number

- A double-precision floating-point number if the first argument is a DOUBLE or REAL
- A decimal floating-point number if the first argument is a DECFLOAT
- A character string if the first argument is any type of character string
- A graphic string if the first argument is any type of graphic string
- A date value if the first argument is a DATE.
- A time value if the first argument is a TIME.
- A timestamp value if the first argument is a TIMESTAMP.

The result of the function is a fixed-length graphic string (GRAPHIC).

If the first argument can be null, the result can be null. If the first argument is null, the result is the null value.

Integer to Graphic

integer-expression

An expression that returns a value that is an integer data type (either SMALLINT, INTEGER, or BIGINT).

The result is a fixed-length graphic string of the argument in the form of an SQL integer constant. The result consists of n characters that are the significant digits that represent the value of the argument with a preceding minus sign if the argument is negative. It is left justified.

- If the argument is a small integer, the length attribute of the result is 6.
- If the argument is a large integer, the length attribute of the result is 11.
- If the argument is a big integer, the length attribute of the result is 20.

The result is the smallest number of characters that can be used to represent the value of the argument. Leading zeroes are not included. If the argument is negative, the first character of the result is a minus sign. Otherwise, the first character is a digit or the *decimal-character*.

The CCSID of the result is 1200 (UTF-16).

Decimal to Graphic

decimal-expression

An expression that returns a value that is a packed or zoned decimal data type (either DECIMAL or NUMERIC). If a different precision and scale is wanted, the DECIMAL scalar function can be used to make the change.

decimal-character

Specifies the single-byte character constant that is used to delimit the decimal digits in the result character string. The character must be a period or comma. If the second argument is not specified, the decimal point is the default decimal point. For more information, see [“Decimal point” on page 118](#).

The result is a fixed-length graphic string representation of the argument. The result includes a decimal character and up to p digits, where p is the precision of the *decimal-expression* with a preceding minus sign if the argument is negative. Leading zeros are not returned. Trailing zeros are returned. If the scale of *decimal-expression* is zero, the decimal character is not returned.

The length attribute of the result is $2+p$ where p is the precision of the *decimal-expression*. The result is the smallest number of characters that can be used to represent the result. Leading zeros are not included. If the argument is negative, the result begins with a minus sign. Otherwise, the result begins with a digit or the *decimal-character*.

The CCSID of the result is 1200 (UTF-16).

Floating-point to Graphic

floating-point expression

An expression that returns a value that is a floating-point data type (DOUBLE or REAL).

decimal-character

Specifies the single-byte character constant that is used to delimit the decimal digits in the result character string. The character must be a period or comma. If the second argument is not specified, the decimal point is the default decimal point. For more information, see [“Decimal point” on page 118](#).

The result is a fixed-length graphic string representation of the argument in the form of a floating-point constant.

The length attribute of the result is 24. The result is the smallest number of characters that can represent the value of the argument such that the mantissa consists of a single digit other than zero followed by the *decimal-character* and a sequence of digits. If the argument is negative, the first character of the result is a minus sign; otherwise, the first character is a digit or the *decimal-character*. If the argument is zero, the result is 0E0.

The CCSID of the result is 1200 (UTF-16).

Decimal floating-point to Graphic

decimal-floating-point expression

An expression that returns a value that is a built-in decimal floating-point data type.

decimal-character

Specifies the single-byte character constant that is used to delimit the decimal digits in the result character string. The character must be a period or comma. If the second argument is not specified, the decimal point is the default decimal point. For more information, see [“Decimal point” on page 118](#).

The result is a fixed-length graphic string representation of the argument in the form of a floating-point constant.

The length attribute of the result is 42. The actual length of the result is the smallest number of characters that represents the value of the argument, including the sign, digits, and *decimal-character*. Trailing zeros are significant. If the argument is negative, the first character of the result is a minus sign; otherwise, the first character is a digit or the *decimal-character*. If the argument is zero, the result is 0.

If the DECFLOAT value is Infinity, sNaN, or NaN, the strings 'INFINITY', 'SNAN', and 'NAN', respectively, are returned. If the special value is negative, a minus sign will be the first character in the string. The DECFLOAT special value sNaN does not result in an exception when converted to a string.

The CCSID of the result is 1200 (UTF-16).

Character to Graphic

character-expression

An expression that returns a value that is a built-in character-string data type. It cannot be a CHAR or VARCHAR bit data. If the expression is an empty string or the EBCDIC string X'0E0F', the result is a single double-byte blank.

length

An integer constant that specifies the length attribute of the result and must be an integer constant between 1 and 16383 if the first argument is not nullable or between 1 and 16382 if the first argument is nullable. If the length of *character-expression* is less than the length specified, the result is padded with double-byte blanks to the length of the result.

If *length* is not specified, or if DEFAULT is specified, the length attribute of the result is the same as the length attribute of the first argument.

Each character of the argument determines a character of the result. If the length attribute of the resulting fixed-length string is less than the actual length of the first argument, truncation is performed and no warning is returned.

integer

An integer constant that specifies the CCSID of the result. It must be a DBCS, UTF-16, or UCS-2 CCSID. The CCSID cannot be 65535. If the CCSID represents Unicode graphic data, each character of the argument determines a character of the result. The *n*th character of the result is the UTF-16 or UCS-2 equivalent of the *n*th character of the argument.

If *integer* is not specified then the CCSID of the result is determined by a mixed CCSID. Let *M* denote that mixed CCSID.

In the following rules, *S* denotes one of the following:

- If the string expression is a host variable containing data in a foreign encoding scheme, *S* is the result of the expression after converting the data to a CCSID in a native encoding scheme. (See “Character conversion” on page 28 for more information.)
- If the string expression is data in a native encoding scheme, *S* is that string expression.

M is determined as follows:

- If the CCSID of *S* is a mixed CCSID, *M* is that CCSID.
- If the CCSID of *S* is an SBCS CCSID:
 - If the CCSID of *S* has an associated mixed CCSID, *M* is that CCSID.
 - Otherwise the operation is not allowed.

The following table summarizes the result CCSID based on *M*.

M	Result CCSID	Description	DBCS Substitution Character
930	300	Japanese EBCDIC	X'FEFE'
933	834	Korean EBCDIC	X'FEFE'
935	837	S-Chinese EBCDIC	X'FEFE'
937	835	T-Chinese EBCDIC	X'FEFE'
939	300	Japanese EBCDIC	X'FEFE'
5026	4396	Japanese EBCDIC	X'FEFE'
5035	4396	Japanese EBCDIC	X'FEFE'

The equivalence of SBCS and DBCS characters depends on *M*. Regardless of the CCSID, every double-byte code point in the argument is considered a DBCS character, and every single-byte code point in the argument is considered an SBCS character with the exception of the EBCDIC mixed data shift codes X'0E' and X'0F'.

- If the *n*th character of the argument is a DBCS character, the *n*th character of the result is that DBCS character.
- If the *n*th character of the argument is an SBCS character that has an equivalent DBCS character, the *n*th character of the result is that equivalent DBCS character.
- If the *n*th character of the argument is an SBCS character that does not have an equivalent DBCS character, the *n*th character of the result is the DBCS substitution character.

Graphic to Graphic

graphic-expression

An expression that returns a value of a built-in graphic-string data type.

length

An integer constant that specifies the length attribute of the result and must be an integer constant between 1 and 16383 if the first argument is not nullable or between 1 and 16382 if the first argument is nullable. If the length of *graphic-expression* is less than the length specified, the result is padded with double-byte blanks to the length of the result.

If the second argument is not specified, or if DEFAULT is specified, the length attribute of the result is the same as the length attribute of the first argument.

If the length of the *graphic-expression* is greater than the length attribute of the result, truncation is performed. A warning (SQLSTATE 01004) is returned unless the truncated characters were all blanks.

integer

An integer constant that specifies the CCSID of the result. It must be a DBCS, UTF-16, or UCS-2 CCSID. The CCSID cannot be 65535.

If *integer* is not specified then the CCSID of the result is the CCSID of the first argument.

Datetime to Graphic

datetime-expression

An expression that is one of the following three built-in data types

date

The result is the graphic-string representation of the date in the format specified by the second argument. If the second argument is not specified, the format used is the default date format. If the format is ISO, USA, EUR, or JIS, the length of the result is 10. Otherwise the length of the result is the length of the default date format. For more information see [“String representations of datetime values” on page 75](#).

time

The result is the graphic-string representation of the time in the format specified by the second argument. If the second argument is not specified, the format used is the default time format. The length of the result is 8. For more information see [“String representations of datetime values” on page 75](#).

timestamp

The second argument is not applicable and must not be specified.

The result is the graphic-string representation of the timestamp. If *datetime-expression* is a TIMESTAMP(0), the length of the result is 19. If the data type of *datetime-expression* is a TIMESTAMP(*n*), the length of the result is 20+*n*. Otherwise, the length of the result is 26.

The CCSID of the result is 1200 (UTF-16).

ISO, EUR, USA, or JIS

Specifies the date or time format of the resulting graphic string. For more information, see [“String representations of datetime values” on page 75](#).

LOCAL

Specifies that the date or time format of the resulting graphic string should come from the DATFMT, DATSEP, TIMFMT, and TIMSEP attributes of the job at the current server.

Note

Syntax alternatives: The CAST specification should be used to increase the portability of applications when the first argument is a string and the length attribute is specified. For more information, see [“CAST specification” on page 177](#).

Example

- Using the EMPLOYEE table, set the host variable DESC (GRAPHIC(24)) to the GRAPHIC equivalent of the first name (FIRSTNME) for employee number (EMPNO) '000050'.

```
SELECT GRAPHIC( VARGRAPHIC(FIRSTNME))  
INTO :DESC  
FROM EMPLOYEE  
WHERE EMPNO = '000050'
```

GREATEST

The GREATEST scalar function returns the maximum value in a set of values.

► GREATEST (*expression* , *expression*) ◄

The GREATEST function is identical to the MAX function. For more information, see [“MAX” on page 485](#).

HASH_MD5, HASH_SHA1, HASH_SHA256, and HASH_SHA512

The hashing functions return a 128-bit, 160-bit, 256-bit, or 512-bit hash of the input data, depending on the algorithm selected.

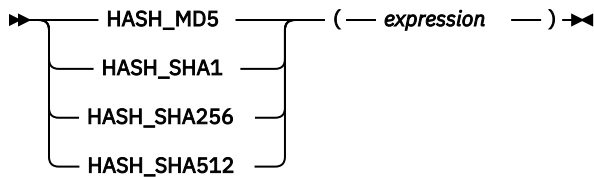

expression

An expression that represents the string value to be hashed. This expression can return any built-in or distinct data type. A distinct type is treated as its source data type. If the value is numeric or datetime, it is implicitly cast to VARCHAR before the function is evaluated. If the value is XML, an implicit XMLSERIALIZE to CLOB(2G) CCSID 1208 is performed before the function is evaluated.

Table 51 on page 422 shows information about each supported algorithm.

Table 51. Hash algorithms

Function name	Algorithm	Result size	Number of return values	Result length	Corresponding algorithm value for use in the HASH function
HASH_MD5	MD5	128 bit	2^{128}	16	0
HASH_SHA1	SHA1	160 bit	2^{160}	20	1
HASH_SHA256	SHA-256	256 bit	2^{256}	32	2
HASH_SHA512	SHA-512	512 bit	2^{512}	64	3

The data type of the result is BINARY with the result length determined by the function name as shown in Table 51 on page 422.

If the argument can be null, the result can be null. If the argument is null, the result is the null value.

Notes

Whitespace affects the hash; a fixed length character string with trailing blanks will generate a different result than a varying length character string that has no trailing blanks. The CCSID of *expression* can cause strings that compare as equal to generate different result values.

Security flaws have been identified in both the SHA1 and MD5 algorithms. You can find acceptable hash algorithms in applicable compliance documentation, such as National Institute of Standards and Technology (NIST) Special Publication 800-131A.

Syntax alternative: The HASH function with a single argument is similar to HASH_MD5. A second argument can be specified for HASH to indicate the algorithm to use. The algorithm values are shown in Table 51 on page 422. The second argument can be an expression that must return a value of any built-in numeric, character-string, or graphic-string data type. A string argument is converted to integer before evaluating the function. The result data type for HASH is VARBINARY. If there is only one argument, the length attribute of the result is 16. If the second argument is specified by an integer constant, the length attribute of the result is the result length shown in Table 51 on page 422. Otherwise, the length attribute of the result is 64. If either argument can be null, the result can be null. If either argument is null, the result is the null value.

Examples

- Use the MD5 algorithm to generate hashed data.

```
VALUES HEX(HASH_MD5(' ABCDEFGHIJKLMNOPQRSTUVWXYZ '))
```

The following value is returned:

```
5156BECBC019E3F0F9520B143435427E
```

- Use the SHA1 algorithm to generate hashed data.

```
VALUES HEX(HASH_SHA1(' ABCDEFGHIJKLMNOPQRSTUVWXYZ '))
```

The following value is returned:

```
55324E3DD1FA95040F65709D193E82575237EF86
```

- Use the SHA-256 algorithm to generate hashed data.

```
VALUES HEX(HASH_SHA256(' ABCDEFGHIJKLMNOPQRSTUVWXYZ '))
```

The following value is returned:

```
011F7AD1ECD8E5A4CC8533D1ECD497DC5D95E848B14F8BCFD56A73D7F41843E2
```

- Use the SHA-512 algorithm to generate hashed data.

```
VALUES HEX(HASH_SHA512(' ABCDEFGHIJKLMNOPQRSTUVWXYZ '))
```

The following value is returned:

```
D8AC4B838921A83C4207B62B8B63628F8FBE836EB012167310331FFC070FC977D224F39148  
8806CB1FE2AA9C8C739E5104CAD1C4C6E97967DA6223D657CD9295
```

HASH_ROW

The HASH_ROW function returns the SHA512 hash value of the data content of a row.

►► HASH_ROW (— *table-designator* —) ►►

table-designator

A table designator that can be used to qualify a column in the same relative location in the SQL statement as the HASH_ROW function. For more information about table designators, see [“Table designators”](#) on page 135.

In SQL naming, the table name may be qualified. In system naming, the table name cannot be qualified.

The *table-designator* must not identify a *table-function*, a *collection-derived-table*, a VALUES clause, a common table expression, or a nested table expression. If the argument identifies a view, its outer subselect must directly or indirectly reference a table.

If the argument identifies a view, the function returns the row hash value for its base table. If the argument identifies a view derived from more than one base table, the function returns the row hash value of the first table in the outer subselect of the view.

If the argument identifies a distributed table, the function returns the row hash value of the row on the node where the row is located.

The argument must not identify a view whose outer fullselect includes an aggregate function, a GROUP BY clause, a HAVING clause, a UNION, INTERSECT, or EXCEPT clause, a DISTINCT clause, a VALUES clause, or a *table-function*. The HASH_ROW function cannot be specified in a SELECT clause if the fullselect contains an aggregate function, a GROUP BY clause, or a HAVING clause

The data type of the result is a BINARY(64) value. The result can be null.

Example

- Determine whether all the rows for the EMPLOYEE table in LIB1 exist and contain the same data values as the EMPLOYEE table in LIB2.

```
WITH LIB1_HASH AS (  
  SELECT EMPNO, HASH_ROW(E1) ROW_VALUE, RID(E1) ROW_RID  
  FROM LIB1.EMPLOYEE E1),  
LIB2_HASH AS (  
  SELECT EMPNO, HASH_ROW(E2) ROW_VALUE, RID(E2) ROW_RID  
  FROM LIB2.EMPLOYEE E2)  
SELECT H1.EMPNO, H1.ROW_RID, H2.ROW_RID  
  FROM LIB1_HASH H1 FULL OUTER JOIN LIB2_HASH H2  
    ON H1.EMPNO = H2.EMPNO  
  WHERE H1.ROW_VALUE <> H2.ROW_VALUE;
```

| HASH_VALUES

- | The HASH_VALUES function returns the partition number of a set of values.

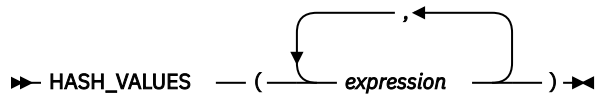

Also see “HASHED_VALUE” on page 426. For more information about partition numbers, see the [DB2 Multisystem](#) topic collection.

expression

An expression that returns a value of any built-in data type except date, time, timestamp, floating-point, XML, or DataLink values.

The result of the function is a large integer with a value between 0 and 1023.

If any of the arguments are null, the result is zero. The result cannot be null.

Example

- | • Use the HASH_VALUES function to determine what the partitions would be if the partitioning key was composed of EMPNO and LASTNAME. This query returns the partition number for every row in EMPLOYEE.

```
SELECT HASH_VALUES(EMPNO, LASTNAME)
FROM EMPLOYEE
```

HASHED_VALUE

The HASHED_VALUE function returns the partition map index number of a row obtained by applying the hashing function on the partitioning key value of the row.

►► HASHED_VALUE — (— *table-designator* —) ◄◄

Also see the “HASH_VALUES” on page 425 function. If the argument identifies a non-distributed table, the value 0 is returned. For more information about partition maps and partitioning keys, see the [DB2 Multisystem](#) topic collection.

table-designator

A table designator of the subselect. For more information about table designators, see “[Table designators](#)” on page 135.

In SQL naming, the table name may be qualified. In system naming, the table name cannot be qualified.

The *table-designator* must not identify a *collection-derived-table*, a VALUES clause, a *table-function*, or a *data-change-table-reference*.

If the argument identifies a view, common table expression, or nested table expression, the function returns the partition map index number of its base table. If the argument identifies a view, common table expression, or nested table expression derived from more than one base table, the function returns the partition map index number of the first table in the outer subselect of the view, common table expression, or nested table expression.

The argument must not identify a view, common table expression, or nested table expression whose outer fullselect includes an aggregate function, a GROUP BY clause, a HAVING clause, a UNION, INTERSECT, or EXCEPT clause, DISTINCT clause, VALUES clause, or a *table-function*. The HASHED_VALUE function cannot be specified in a SELECT clause if the fullselect contains an aggregate function, a GROUP BY clause, or a HAVING clause

The data type of the result is a large integer with a value between 0 and 1023. The result can be null.

Note

Syntax alternatives: PARTITION is a synonym for HASHED_VALUE.

Example

- Select the employee number (EMPNO) from the EMPLOYEE table for all rows where the partition map index number is equal to 100.

```
SELECT EMPNO
FROM EMPLOYEE
WHERE HASHED_VALUE(EMPLOYEE) = 100
```

HEX

The HEX function returns a hexadecimal representation of a value.

►► HEX — (— *expression* —) ◄◄

expression

An expression that returns a value of any built-in data type other than a character or binary string with a length attribute greater than 16 336 or a graphic string with a length attribute greater than 8168.

The result of the function is a character string. If the argument can be null, the result can be null; if the argument is null, the result is the null value.

The result is a string of hexadecimal digits, the first two digits represent the first byte of the argument, the next two digits represent the second byte of the argument, and so forth. If the argument is a datetime value, the result is the hexadecimal representation of the internal form of the argument.⁵⁹

If the argument is not a graphic string, the actual length of the result is twice the length of the argument. If the argument is a graphic string, the actual length of the result is four times the length of the argument. If the data type of the result is varying length, the length is limited to the maximum length of the data type. The length of the argument is the value that would be returned if the argument were passed to the LENGTH scalar function. For more information, see “LENGTH” on page 469.

The data type and length attribute of the result depends on the attributes of the argument:

- If the argument is not a string, the result is CHAR with a length attribute that is twice the length of the argument.
- If the argument is a fixed-length character string with a length attribute that is less than one half the maximum length attribute of CHAR, the result is CHAR with a length attribute that is twice the length attribute of the argument. If the argument is a fixed-length graphic string with a length attribute that is less than one fourth the maximum length attribute of CHAR, the result is CHAR with a length attribute that is four times the length attribute of the argument. For more information about the product-specific maximum length, see [Table 123 on page 1637](#).
- Otherwise, the result is VARCHAR whose length attribute depends on the following:
 - If the argument is a character or binary string, the length attribute of the result is the minimum of twice the length attribute of the argument and the maximum length of the data type.
 - If the argument is a graphic string, the length attribute of the result is the minimum of four times the length attribute of the argument and the maximum length of the data type.

The length attribute of the result cannot be greater than the product-specific length attribute of CHAR or VARCHAR. See [Table 123 on page 1637](#) for more information.

The CCSID of the string is the default SBCS CCSID at the current server.

Example

- Use the HEX function to return a hexadecimal representation of the education level for each employee.

```
SELECT FIRSTNAME, MIDINIT, LASTNAME, HEX(EDLEVEL)
FROM EMPLOYEE
```

⁵⁹ This hexadecimal representation for DATE, TIMESTAMP, and NUMERIC data types is different from other database products because the internal form for these data types is different.

HEXTORAW

The HEXTORAW function returns a binary string representation of a character string that has been formatted using a *format-string*.

► HEXTORAW (*expression* , *format-string*) ◄

The HEXTORAW function is identical to VARBINARY_FORMAT except that if the length of *expression* is an odd number of characters, the string is padded on the left with one '0' character. For more information, see [“VARBINARY_FORMAT”](#) on page 614.

HOUR

The HOUR function returns the hour part of a value.

►► HOUR — (— *expression* —) ◄◄

expression

An expression that returns a value of one of the following built-in data types: a date, a time, a timestamp, a character string, a graphic string, or a numeric data type.

- If *expression* is a character or graphic string, its value must be a valid string representation of a datetime value. If *expression* is a valid string representation of a date, it must be in one of the IBM SQL standard formats. For the valid formats of string representations of datetime values, see [“String representations of datetime values”](#) on page 75.
- If the argument is a DATE, it is first converted to a TIMESTAMP(0) value, assuming a time of exactly midnight (00.00.00).
- If *expression* is a number, it must be a time duration or timestamp duration. For the valid formats of datetime durations, see [“Datetime operands and durations”](#) on page 166.

The result of the function is a large integer. If the argument can be null, the result can be null; if the argument is null, the result is the null value.

The other rules depend on the data type of the argument:

- If the argument is a date, time, timestamp, or valid character-string representation of a date, time, or timestamp:

The result is the hour part of the value, which is an integer between 0 and 24.

- If the argument is a time duration or timestamp duration:

The result is the hour part of the value, which is an integer between -99 and 99. A nonzero result has the same sign as the argument.

Example

- Using the CL_SCHED sample table, select all the classes that start in the afternoon.

```
SELECT *  
FROM CL_SCHED  
WHERE HOUR(STARTING) BETWEEN 12 AND 17
```

IDENTITY_VAL_LOCAL

IDENTITY_VAL_LOCAL is a non-deterministic function that returns the most recently assigned value for an identity column.

►► IDENTITY_VAL_LOCAL — (—) ◄◄

The function has no input parameters. The result is a DECIMAL(31,0) regardless of the actual data type of the identity column that the result value corresponds to.

The value returned is the value that was assigned to the identity column of the table identified in the most recent insert operation (specified in either an INSERT statement or a MERGE statement). The insert operation has to be issued at the same level; that is, the value has to be available locally within the level at which it was assigned until replaced by the next assigned value. A new level is initiated when a trigger, function, or stored procedure is invoked. A trigger condition is at the same level as the associated triggered action.

The assigned value can be a value supplied by the user (if the identity column is defined as GENERATED BY DEFAULT) or an identity value that was generated by the database manager.

The result can be null. The result is null if an insert operation has not been issued for a table containing an identity column at the current processing level. This includes invoking the function in a before or after insert trigger.

The result of the IDENTITY_VAL_LOCAL function is not affected by the following statements:

- An insert operation for a table which does not contain an identity column
- An UPDATE statement
- A COMMIT statement
- A ROLLBACK statement

Notes

The following notes explain the behavior of the function when it is invoked in various situations:

Invoking the function within the VALUES clause of an insert operation

Expressions in an insert operation are evaluated before values are assigned to the target columns of the insert operation. Thus, when you invoke IDENTITY_VAL_LOCAL in an insert operation, the value that is used is the most recently assigned value for an identity column from a previous insert operation. The function returns the null value if no such insert operation had been executed within the same level as the invocation of the IDENTITY_VAL_LOCAL function.

Invoking the function following a failed insert operation

The function returns an unpredictable result when it is invoked after the unsuccessful execution of an insert operation for a table with an identity column. The value might be the value that would have been returned from the function had it been invoked before the failed insert operation or the value that would have been assigned had the insert operation succeeded. The actual value returned depends on the point of failure and is therefore unpredictable.

Invoking the function within the SELECT statement of a cursor

Because the results of the IDENTITY_VAL_LOCAL function are not deterministic, the result of an invocation of the IDENTITY_VAL_LOCAL function from within the SELECT statement of a cursor can vary for each FETCH statement.

Invoking the function within a procedure or function default expression

The result of invoking the IDENTITY_VAL_LOCAL function from within the default expression of a procedure or function is undefined; this function should not be used in a default expression.

Invoking the function within the trigger condition of an insert trigger

The result of invoking the IDENTITY_VAL_LOCAL function from within the condition of an insert trigger is the null value.

Invoking the function within a triggered action of an insert trigger

Multiple before or after insert triggers can exist for a table. In such cases, each trigger is processed separately, and identity values generated by SQL statements issued within a triggered action are not available to other triggered actions using the `IDENTITY_VAL_LOCAL` function. This is the case even though the multiple triggered actions are conceptually defined at the same level.

Do not use the `IDENTITY_VAL_LOCAL` function in the triggered action of a before insert trigger. The result of invoking the `IDENTITY_VAL_LOCAL` function from within the triggered action of a before insert trigger is the null value. The value for the identity column of the table for which the trigger is defined cannot be obtained by invoking the `IDENTITY_VAL_LOCAL` function within the triggered action of a before insert trigger. However, the value for the identity column can be obtained in the triggered action by referencing the trigger transition variable for the identity column.

The result of invoking the `IDENTITY_VAL_LOCAL` function in the triggered action of an after insert trigger is the value assigned to an identity column of the table identified in the most recent insert operation invoked in the same triggered action for a table containing an identity column. If an insert operation for a table containing an identity column was not executed within the same triggered action before invoking the `IDENTITY_VAL_LOCAL` function, then the function returns a null value.

Invoking the function following an insert operation with triggered actions

The result of invoking the function after an insert operation that activates triggers is the value actually assigned to the identity column (that is, the value that would be returned on a subsequent `SELECT` statement). This value is not necessarily the value provided in the insert operation or a value generated by the database manager. The assigned value could be a value that was specified in a `SET` transition variable statement within the triggered action of a before insert trigger for a trigger transition variable associated with the identity column.

Scope of `IDENTITY_VAL_LOCAL`

The `IDENTITY_VAL_LOCAL` value persists until the next insert operation in the current session into a table that has an identity column defined on it, or the application session ends. The value is unaffected by `COMMIT` or `ROLLBACK` statements. The `IDENTITY_VAL_LOCAL` value cannot be directly set and is a result of inserting a row into a table.

A technique commonly used, especially for performance, is for an application or product to manage a set of connections and route transactions to an arbitrary connection. In these situations, the availability of the `IDENTITY_VAL_LOCAL` value should only be relied on until the end of the transaction.

Alternative to `IDENTITY_VAL_LOCAL`:

It is recommended that a `SELECT FROM INSERT` be used to obtain the assigned value for an identity column. See [“table-reference” on page 730](#) for more information.

Examples

- Set the variable `IVAR` to the value assigned to the identity column in the `EMPLOYEE` table. The value returned from the function in the `VALUES INTO` statement should be 1.

```
CREATE TABLE EMPLOYEE
(EMPNO INTEGER GENERATED ALWAYS AS IDENTITY,
 NAME CHAR(30),
 SALARY DECIMAL(5,2),
 DEPTNO SMALLINT)

INSERT INTO EMPLOYEE
(NAME, SALARY, DEPTNO)
VALUES('Rupert', 989.99, 50)

VALUES IDENTITY_VAL_LOCAL() INTO :IVAR
```

- Assume two tables, `T1` and `T2`, have an identity column named `C1`. The database manager generates values 1, 2, 3,...for the `C1` column in table `T1`, and values 10, 11, 12,...for the `C1` column in table `T2`.

```
CREATE TABLE T1
(C1 SMALLINT GENERATED ALWAYS AS IDENTITY,
 C2 SMALLINT)
```

```

CREATE TABLE T2
(C1 DECIMAL(15,0) GENERATED BY DEFAULT AS IDENTITY ( START WITH 10 ) ,
C2 SMALLINT)

INSERT INTO T1 ( C2 ) VALUES(5)

INSERT INTO T1 ( C2 ) VALUES(5)

SELECT * FROM T1

```

C1	C2
1	5
2	5

```
VALUES IDENTITY_VAL_LOCAL() INTO :IVAR
```

At this point, the IDENTITY_VAL_LOCAL function would return a value of 2 in IVAR. The following INSERT statement inserts a single row into T2 where column C2 gets a value of 2 from the IDENTITY_VAL_LOCAL function.

```

INSERT INTO T2 ( C2 ) VALUES( IDENTITY_VAL_LOCAL() )

SELECT * FROM T2
WHERE C1 = DECIMAL( IDENTITY_VAL_LOCAL(), 15, 0)

```

C1	C2
10	2

Invoking the IDENTITY_VAL_LOCAL function after this INSERT would result in a value of 10, which is the value generated by the database manager for column C1 of T2. Assume another single row is inserted into T2. For the following INSERT statement, the database manager assigns a value of 13 to identity column C1 and gives C2 a value of 10 from IDENTITY_VAL_LOCAL. Thus, C2 is given the last identity value that was inserted into T2.

```

INSERT INTO T2 ( C2, C1 ) VALUES( IDENTITY_VAL_LOCAL(), 13 )

SELECT * FROM T2
WHERE C1 = DECIMAL( IDENTITY_VAL_LOCAL(), 15, 0)

```

C1	C2
13	10

- The IDENTITY_VAL_LOCAL function can also be invoked in an INSERT statement that both invokes the IDENTITY_VAL_LOCAL function and causes a new value for an identity column to be assigned. The next value to be returned is thus established when the IDENTITY_VAL_LOCAL function is invoked after the INSERT statement completes. For example, consider the following table definition:

```

CREATE TABLE T3
(C1 SMALLINT GENERATED BY DEFAULT AS IDENTITY,
C2 SMALLINT)

```

For the following INSERT statement, specify a value of 25 for the C2 column, and the database manager generates a value of 1 for C1, the identity column. This establishes 1 as the value that will be returned on the next invocation of the IDENTITY_VAL_LOCAL function.

```
INSERT INTO T3 ( C2 ) VALUES( 25 )
```

In the following INSERT statement, the IDENTITY_VAL_LOCAL function is invoked to provide a value for the C2 column. A value of 1 (the identity value assigned to the C1 column of the first row) is assigned to the C2 column, and the database manager generates a value of 2 for C1, the identity column. This

establishes 2 as the value that will be returned on the next invocation of the IDENTITY_VAL_LOCAL function.

```
INSERT INTO T3 ( C2 ) VALUES( IDENTITY_VAL_LOCAL() )
```

In the following INSERT statement, the IDENTITY_VAL_LOCAL function is again invoked to provide a value for the C2 column, and the user provides a value of 11 for C1, the identity column. A value of 2 (the identity value assigned to the C1 column of the second row) is assigned to the C2 column. The assignment of 11 to C1 establishes 11 as the value that will be returned on the next invocation of the IDENTITY_VAL_LOCAL function.

```
INSERT INTO T3 ( C2, C1 ) VALUES( IDENTITY_VAL_LOCAL(), 11 )
```

After the 3 INSERT statements have been processed, table T3 contains the following:

C1	C2
1	25
2	1
11	2

The contents of T3 illustrate that the expressions in the VALUES clause are evaluated before the assignments for the columns of the INSERT statement. Thus, an invocation of an IDENTITY_VAL_LOCAL function invoked from a VALUES clause of an INSERT statement uses the most recently assigned value for an identity column in a previous INSERT statement.

IFNULL

The IFNULL function returns the value of the first non-null expression.

►► IFNULL (— *expression* — , — *expression* —) ◄◄

The IFNULL function is identical to the COALESCE scalar function with two arguments. For more information, see [“COALESCE” on page 337](#).

Example

- When selecting the employee number (EMPNO) and salary (SALARY) from all the rows in the EMPLOYEE table, if the salary is missing (that is, null), then return a value of zero.

```
SELECT EMPNO, IFNULL(SALARY, 0)
FROM EMPLOYEE
```

INSERT

Returns a string where *length* characters have been deleted from *source-string* beginning at *start* and where *insert-string* has been inserted into *source-string* beginning at *start*.

► INSERT (— *source-string* — , — *start* — , — *length* — , — *insert-string* —) ►

source-string

An expression that specifies the source string. The *source-string* may be any built-in numeric or string expression. It must be compatible with the *insert-string*. For more information about data type compatibility, see [“Assignments and comparisons” on page 91](#). A numeric argument is cast to a character string before evaluating the function. For more information about converting numeric to a character string, see [“VARCHAR” on page 616](#). The actual length of the string must be greater than zero.

start

An expression that returns a built-in BIGINT, INTEGER, or SMALLINT data type. The integer specifies the starting character within *source-string* where the deletion of characters and the insertion of another string is to begin. The value of the integer must be in the range of 1 to the length of *source-string* plus one.

length

An expression that returns a built-in BIGINT, INTEGER, or SMALLINT data type. The integer specifies the number of characters that are to be deleted from *source-string*, starting at the character position identified by *start*. The value of the integer must be in the range of 0 to the length of *source-string*.

insert-string

An expression that specifies the string to be inserted into *source-string*, starting at the position identified by *start*. The *insert-string* may be any built-in numeric or string expression. It must be compatible with the *source-string*. For more information about data type compatibility, see [“Assignments and comparisons” on page 91](#). A numeric argument is cast to a character string before evaluating the function. For more information about converting numeric to a character string, see [“VARCHAR” on page 616](#). The actual length of the string must be 0 or greater.

The data type of the result of the function depends on the data type of the first and fourth arguments. The result data type is the same as if the two arguments were concatenated except that the result is always a varying-length string. For more information see [“Conversion rules for operations that combine strings” on page 112](#).

The length attribute of the result depends on the arguments:

- If *start* and *length* are constants, the length attribute of the result is:

```
L1 - MIN((L1-V2 + 1), V3) + L4
```

where:

```
L1 is the length attribute of source-string
V2 depends on the encoding schema of source-string:
- If the source-string is UTF-8, the value MIN(L1+1,start*3)
- If the source-string is mixed data, the value MIN(L1+1,(start-1)*2.5+4)
- Otherwise, the value of start
V3 is the value of length
L4 is the length attribute of insert-string
```

- Otherwise, the length attribute of the result is the length attribute of *source-string* plus the length attribute of *insert-string*.

If the length attribute of the result exceeds the maximum for the result data type, an error is returned.

The actual length of the result is:

```
A1 - MIN((A1 - V2 + 1), V3) + A4
```

where:

```
A1 is the actual length of source-string  
V2 is the value of start  
V3 is the value of length  
A4 is the actual length of insert-string
```

If the actual length of the result string exceeds the maximum for the result data type, an error is returned.

If any argument can be null, the result can be null; if any argument is null, the result is the null value.

The CCSID of the result is determined by the CCSID of *source-string* and *insert-string*. The resulting CCSID is the same as if the two arguments were concatenated. For more information, see [“Conversion rules for operations that combine strings” on page 112](#).

Examples

- The following example shows how the string 'INSERTING' can be changed into other strings. The use of the CHAR function limits the length of the resulting string to 10 characters.

```
SELECT INSERT('INSERTING', 4, 2, 'IS'),  
       INSERT('INSERTING', 4, 0, 'IS'),  
       INSERT('INSERTING', 4, 2, '')  
FROM SYSIBM.SYSDUMMY1
```

This example returns 'INSISTING ', 'INSISERTIN', and 'INSTING '.

- The previous example demonstrated how to insert text into the middle of some text. This example shows how to insert text before some text by using 1 as the starting point (*start*).

```
SELECT INSERT('INSERTING', 1, 0, 'XX'),  
       INSERT('INSERTING', 1, 1, 'XX'),  
       INSERT('INSERTING', 1, 2, 'XX'),  
       INSERT('INSERTING', 1, 3, 'XX')  
FROM SYSIBM.SYSDUMMY1
```

This example returns 'XXINSERTIN', 'XXNSERTING', 'XXSERTING ', and 'XXERTING '.

- The following example shows how to insert text after some text. Add 'XX' at the end of string 'ABCABC'. Because the source string is 6 characters long, set the starting position to 7 (one plus the length of the source string).

```
SELECT INSERT('ABCABC', 7, 0, 'XX')  
FROM SYSIBM.SYSDUMMY1
```

This example returns 'ABCABCXX '.

INSTR

The INSTR function returns the starting position of a string (called the *search-string*) within another string (called the *source-string*). If the *search-string* is not found and neither argument is null, the result is zero. If the *search-string* is found, the result is a number from 1 to the actual length of the *source-string*. If the optional *start* is specified, it indicates the character position in the *source-string* at which the search is to begin.

►► INSTR (— *source-string* — , — *search-string* —) ►►

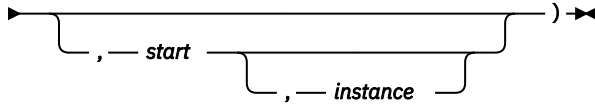

The INSTR function is identical to the LOCATE_IN_STRING function. For more information, see [“LOCATE_IN_STRING”](#) on page 475.

INTEGER or INT

The INTEGER function returns an integer representation.

Numeric to Integer

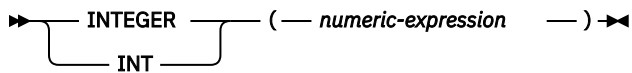

String to Integer

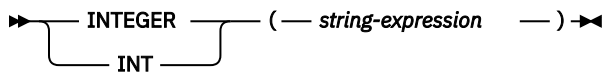

Date to Integer

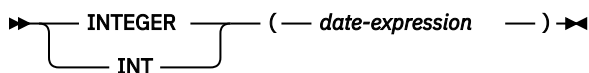

Time to Integer

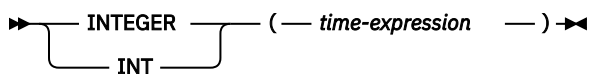

The INTEGER function returns an integer representation of:

- A number
- A character or graphic string representation of a decimal number
- A character or graphic string representation of an integer
- A character or graphic string representation of a floating-point number
- A character or graphic string representation of a decimal floating-point number
- A date
- A time

Numeric to Integer

numeric-expression

An expression that returns a numeric value of any built-in numeric data type.

If the argument is a *numeric-expression*, the result is the same number that would occur if the argument were assigned to a large integer column or variable. If the whole part of the argument is not within the range of integers, an error is returned. The fractional part of the argument is truncated.

String to Integer

string-expression

An expression that returns a value that is a character-string or graphic-string representation of a number.

If the argument is a *string-expression*, the result is the same number that would result from `CAST(string-expression AS INTEGER)`. Leading and trailing blanks are eliminated and the resulting string must conform to the rules for forming a floating-point, decimal floating-point, integer, or decimal constant. If the whole part of the argument is not within the range of integers, an error is returned. Any fractional part of the argument is truncated.

Date to Integer

date-expression

An expression that returns a value of the DATE data type. The result is an INTEGER value representing the date as *yyyymmdd*.

Time to Integer

time-expression

An expression that returns a value of the TIME data type. The result is an INTEGER value representing the time as *hhmmss*.

The result of the function is a large integer. If the argument can be null, the result can be null; if the argument is null, the result is the null value.

Note

Syntax alternatives: The CAST specification should be used to increase the portability of applications. For more information, see [“CAST specification”](#) on page 177.

Example

- Using the EMPLOYEE table, select a list containing salary (SALARY) divided by education level (EDLEVEL). Truncate any decimal in the calculation. The list should also contain the values used in the calculation and the employee number (EMPNO).

```
SELECT INTEGER(SALARY / EDLEVEL), SALARY, EDLEVEL, EMPNO
FROM EMPLOYEE
```

INTERPRET

The INTERPRET function returns the first operand interpreted as the specified *data-type*.

►► INTERPRET — (— *expression* — AS — *data-type* —) ◄◄

data-type

►► *built-in-type* ◄◄
 |
 | *distinct-type* ◄◄

built-in-type

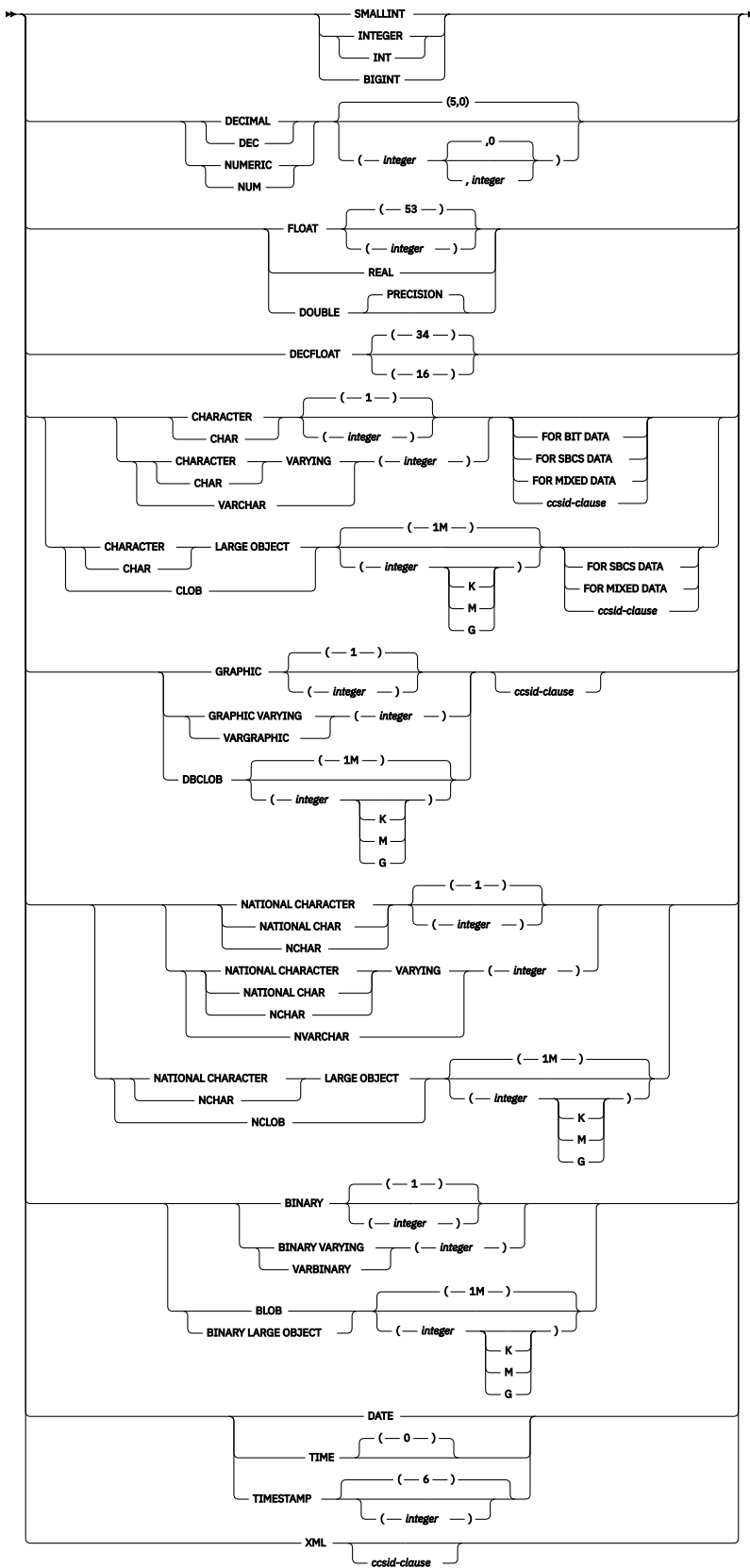

ccsid-clause

➤ **CCSID** — *integer* ➤

string-expression

An expression that returns a built-in binary string or character FOR BIT DATA string that contains the internal IBM i representation of *data-type*. The length of *string-expression* must follow the rules in Table 52 on page 442.

data-type

Specifies the data type of the result. For a description of *data-type*, see “CREATE TABLE” on page 1105.

If the CCSID attribute is not specified for a character or graphic string data type:

- If *data-type* is CHAR, VARCHAR, or CLOB:
 - If FOR BIT DATA is specified, a CCSID of 65535 is used.
 - If FOR MIXED DATA is specified, the mixed-byte CCSID associated with the default CCSID of the job is used.
 - Otherwise, the single-byte CCSID associated with the default CCSID of the job is used.
- If *data-type* is GRAPHIC, VARGRAPHIC, or DBCLOB, CCSID 1200 is used.

Table 52. Data type interpretation rules

Result data type	Required <i>string-expression</i> length in bytes	Other considerations
SMALLINT	2	
INTEGER	4	
BIGINT	8	
DECIMAL(<i>p,s</i>)	$(p/2) + 1$	
NUMERIC(<i>p,s</i>)	<i>p</i>	
FLOAT (single precision)	4	
FLOAT (double precision)	8	
DECFLOAT(16)	8	
DECFLOAT(34)	16	
CHAR(<i>n</i>)	0 to <i>n</i>	If the length of <i>string-expression</i> is less than <i>n</i> , the result is padded on the right with blanks.
VARCHAR(<i>n</i>)	2 to a maximum of $n + 2$	The length represented by the first 2 bytes of <i>string-expression</i> cannot exceed <i>n</i> and must not be greater than the length of <i>string-expression</i> - 2.
CLOB(<i>n</i>)	4 to a maximum of $n + 4$	The length represented by the first 4 bytes of <i>string-expression</i> cannot exceed <i>n</i> and must not be greater than the length of <i>string-expression</i> - 4.
GRAPHIC(<i>n</i>)	0 to $2n$	The length of <i>string-expression</i> must be divisible by 2. If the length of <i>string-expression</i> is less than $2n$, the result is padded on the right with blanks.
VARGRAPHIC(<i>n</i>)	2 to a maximum of $2n + 2$	The length of <i>string-expression</i> must be divisible by 2. The length represented by the first 2 bytes of <i>string-expression</i> cannot exceed <i>n</i> and must not be greater than the length of $(string-expression - 2) / 2$.
DBCLOB(<i>n</i>)	4 to a maximum of $2n + 4$	The length of <i>string-expression</i> must be divisible by 2. The length represented by the first 4 bytes of <i>string-expression</i> cannot exceed <i>n</i> and must not be greater than the length of $(string-expression - 4) / 2$.
BINARY(<i>n</i>)	0 to <i>n</i>	If the length of <i>string-expression</i> is less than <i>n</i> , the result is padded on the right with hexadecimal zeros.
VARBINARY(<i>n</i>)	2 to a maximum of $n + 2$	The length represented by the first 2 bytes of <i>string-expression</i> cannot exceed <i>n</i> and must not be greater than the length of <i>string-expression</i> - 2.
BLOB(<i>n</i>)	4 to a maximum of $n + 4$	The length represented by the first 4 bytes of <i>string-expression</i> cannot exceed <i>n</i> and must not be greater than the length of <i>string-expression</i> - 4.
DATE	4	
TIME	3	

Table 52. Data type interpretation rules (continued)

Result data type	Required <i>string-expression</i> length in bytes	Other considerations
TIMESTAMP(<i>p</i>)	when <i>p</i> is 0, 19; otherwise 20+ <i>p</i>	
XML	4 to 2G	The length represented by the first 4 bytes of <i>string-expression</i> must not be greater than the length of <i>string-expression</i> - 4.

Example

Table 53.	
Function invocation	Result value
INTERPRET(BX'00000011' AS INTEGER)	17
INTERPRET(BX'12345F' AS DECIMAL(5,2))	123.45
INTERPRET(BX'00258541' AS DATE)	2020-04-05
INTERPRET(BX'616263' AS CHAR(3) CCSID 37)	/ÄÄ
INTERPRET(BX'616263' AS CHAR(3) CCSID 1208)	abc
INTERPRET(BX'0005C1C2C3C4C5' AS VARCHAR(5))	ABCDE
INTERPRET(BX'0003C1C2C3C4C5' AS VARCHAR(5))	ABC
INTERPRET(BX'0007C1C2C3C4C5' AS VARCHAR(7))	Error
INTERPRET(BX'0000003003100320033' AS DBCLOB(3) CCSID 1200)	123

JSON_ARRAY

The JSON_ARRAY function generates a JSON array either by explicitly listing the array elements or by using a query. If no *JSON-expression* is provided, the *fullselect* returns no values, or all values are null and ABSENT ON NULL is specified, an empty array is returned.

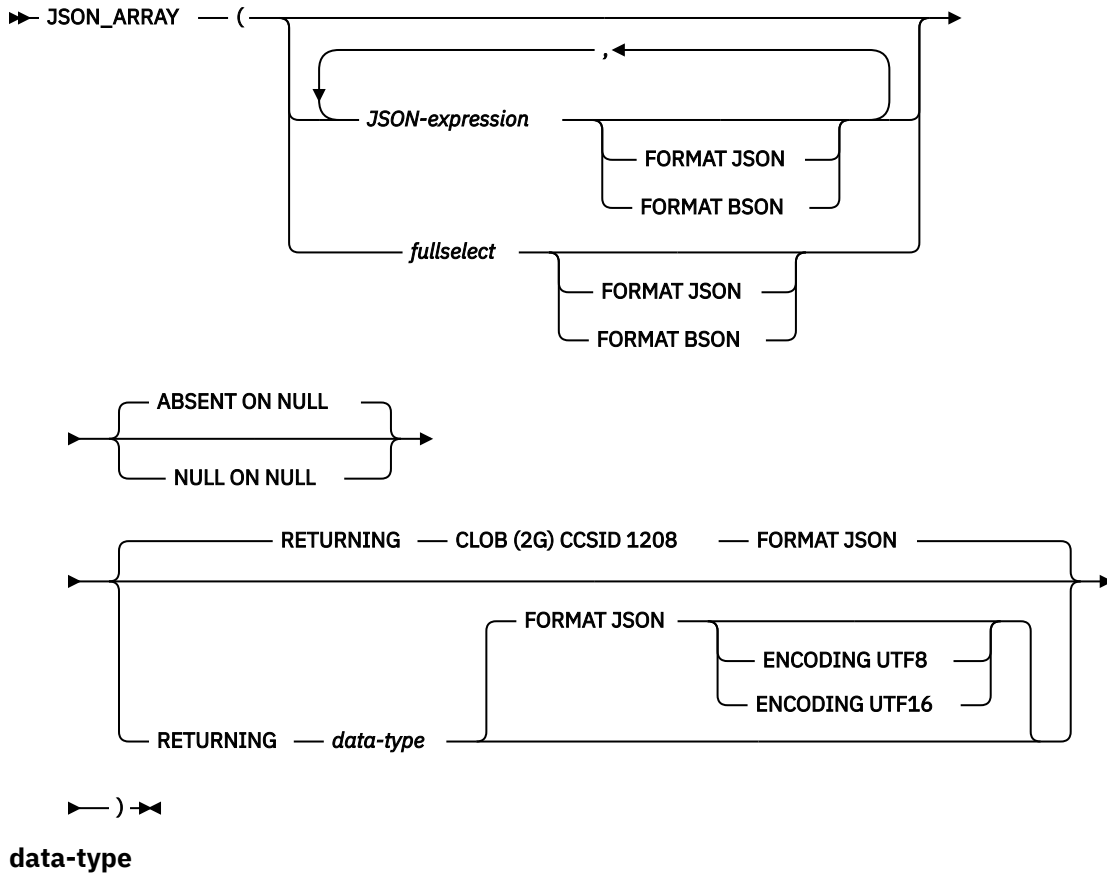

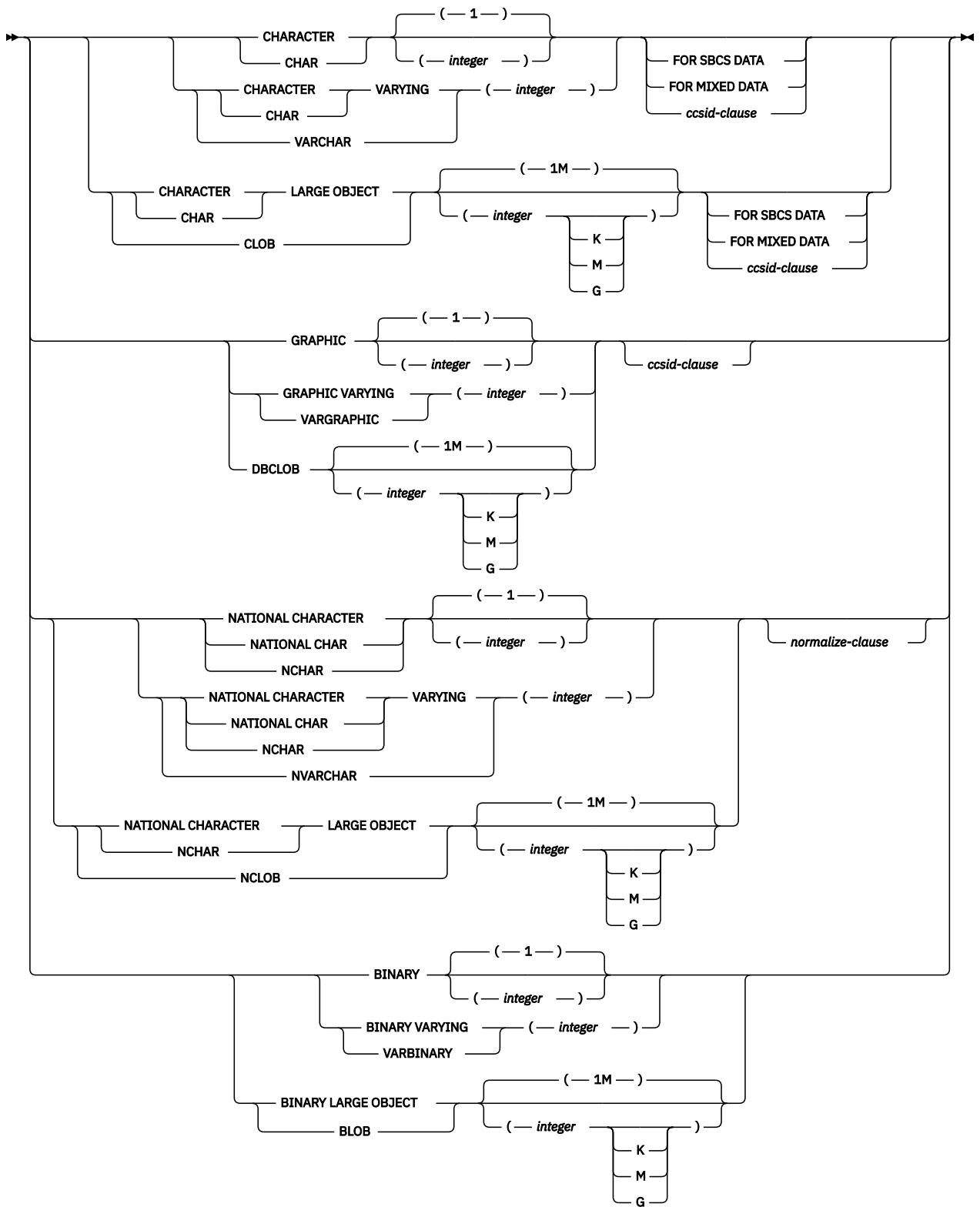

ccsid-clause

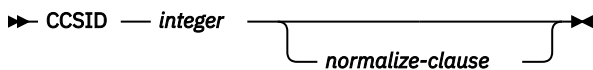

normalize-clause

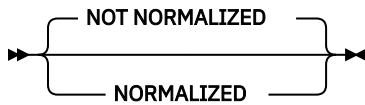

JSON-expression

The expression to use to generate a value in the JSON array. The result type of this expression can be any built-in data type except XML, ROWID, or DATALINK. It cannot be CHAR or VARCHAR bit data. It cannot be a user-defined type that is sourced on any of these data types.

fullselect

Specifies a *fullselect* that returns a single column to be used to generate the values in the array. The value of each row is used to generate a value in the JSON array. The result type of this column can be any built-in data type except XML, ROWID, DATALINK, or a user-defined type that is sourced on any of these data types. It cannot be CHAR or VARCHAR bit data.

FORMAT JSON or FORMAT BSON

Specifies whether *JSON-expression* or *fullselect* is already formatted data.

FORMAT JSON

JSON-expression or *fullselect* is formatted as JSON data. If *JSON-expression* or *fullselect* is a character or graphic string data type, it is treated as JSON data. If *JSON-expression* or *fullselect* is a binary string data type, it is interpreted as UTF-8 or UTF-16 data.

FORMAT BSON

JSON-expression or *fullselect* is formatted as the BSON representation of JSON data and must be a binary string data type.

If neither FORMAT JSON nor FORMAT BSON is specified:

- If *JSON-expression* is one of the built-in functions JSON_ARRAY, JSON_OBJECT, JSON_QUERY, JSON_ARRAYAGG, or JSON_OBJECTAGG, the explicit or implicit FORMAT value of the function's RETURNING clause determines the format of *JSON-expression*.
- If *JSON-expression* is a binary string type, it is interpreted as FORMAT BSON.
- Otherwise, *JSON-expression* or *fullselect* is considered unformatted data. If the generated value is not numeric, the result string will be constructed with strings enclosed in quotes and any special characters will be escaped. A numeric value that is not a valid JSON number, such as INFINITY or NAN, will result in an error.

ABSENT ON NULL or NULL ON NULL

Specifies what to return when an array element produced by *JSON-expression* or *fullselect* is the null value.

ABSENT ON NULL

A null array element is not included in the JSON array. This is the default.

NULL ON NULL

A null array element is included in the JSON array.

RETURNING data-type

Specifies the format of the result.

data-type

The data type of the result. For CHAR and VARCHAR results, the CCSID cannot be 65535. The default is CLOB(2G) CCSID 1208.

If a CCSID is specified and the *data-type* is GRAPHIC, VARGRAPHIC, or DBCLOB, the CCSID must be a Unicode CCSID.

If the CCSID attribute is not specified, the CCSID is determined as described in [“CAST specification”](#) on page 177.

FORMAT JSON

JSON data is returned as a JSON string.

ENCODING UTF8 or ENCODING UTF16

The encoding to use when *data-type* is a binary string type. This clause is only allowed for binary string types. The default for binary strings is UTF8.

Examples

- Generate a JSON array containing the values Washington, Jefferson, and Hamilton.

```
VALUES (JSON_ARRAY('Washington', 'Jefferson', 'Hamilton'));
```

The result is the following JSON array:

```
["Washington", "Jefferson", "Hamilton"]
```

- Generate a JSON array that includes all the department numbers.

```
VALUES (JSON_ARRAY((SELECT DEPTNO FROM DEPT  
WHERE DEPTNAME LIKE 'BRANCH OFFICE%' )));
```

The result is the following JSON array:

```
["F22", "G22", "H22", "I22", "J22"]
```

JSON_OBJECT

The JSON_OBJECT function generates a JSON object using the specified *key:value* pairs. If no *key:value* pairs are provided, an empty object is returned.

►► JSON_OBJECT (— (—►

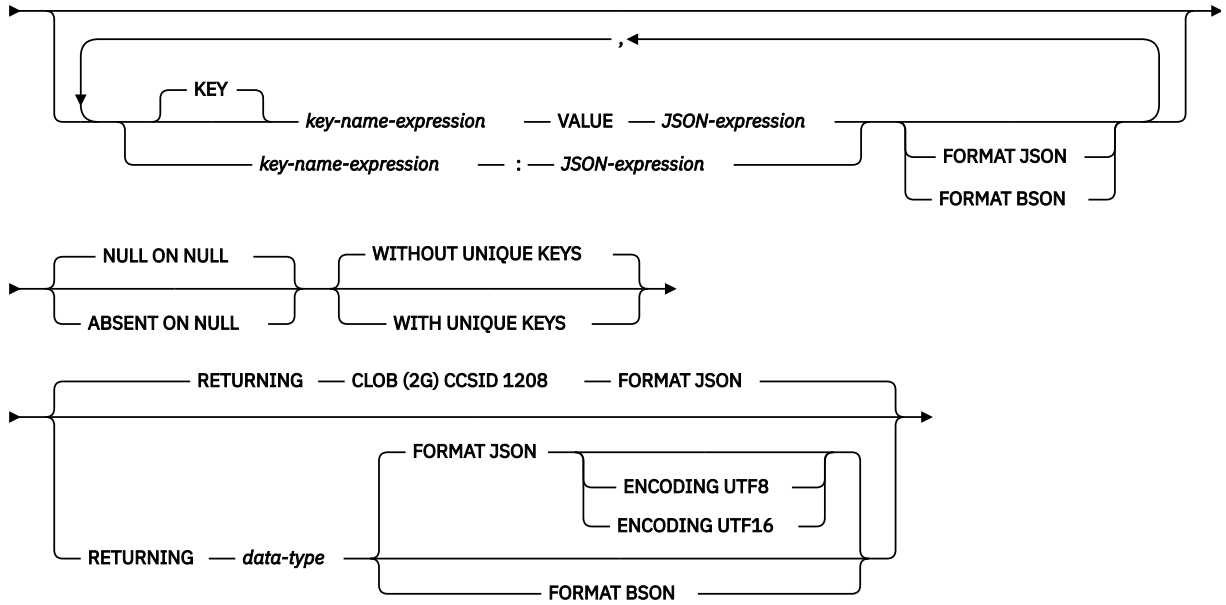

►) ►►

data-type

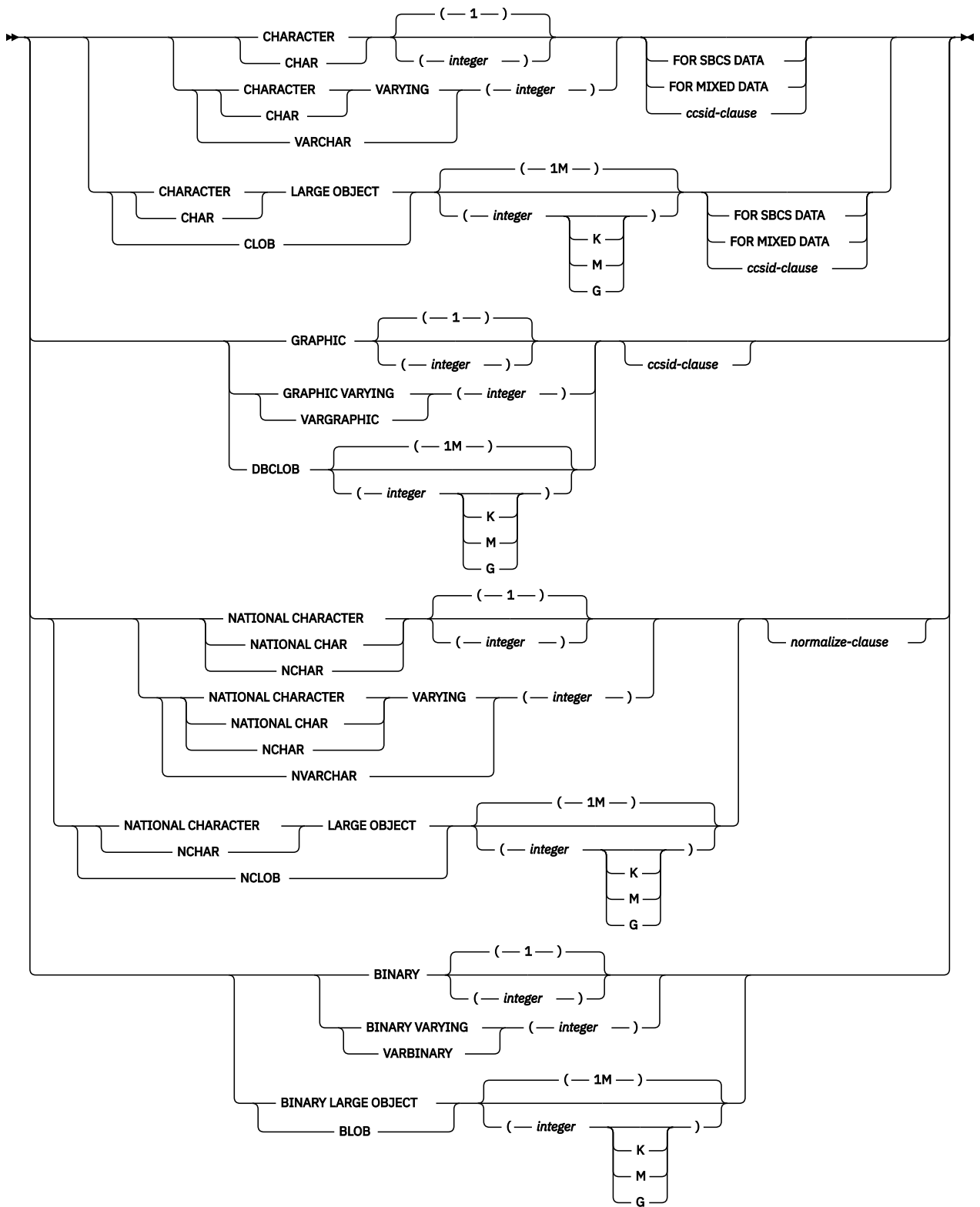

ccsid-clause

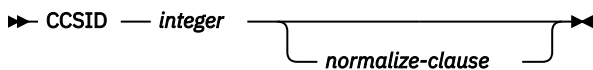

normalize-clause

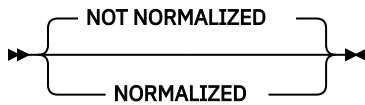

key-name-expression

The name of the JSON key. The name must not be null. When using the colon form for defining a *key:value* pair, *key-name-expression* must be a character string literal. Otherwise, the result of *key-name-expression* must be a built-in character or graphic string data type. It cannot be CHAR or VARCHAR bit data.

JSON-expression

The expression to use to generate the JSON value associated with *key-name-expression*. The result type of this expression can be any built-in data type except XML, ROWID, or DATALINK. It cannot be CHAR or VARCHAR bit data. It cannot be a user-defined type that is sourced on any of these data types.

FORMAT JSON or FORMAT BSON

Specifies whether *JSON-expression* is already formatted data.

FORMAT JSON

JSON-expression is formatted as JSON data. If *JSON-expression* is a character or graphic string data type, it is treated as JSON data. If *JSON-expression* is a binary string data type, it is interpreted as UTF-8 or UTF-16 data.

FORMAT BSON

JSON-expression is formatted as the BSON representation of JSON data and must be a binary string data type.

If neither FORMAT JSON nor FORMAT BSON is specified:

- If *JSON-expression* is one of the built-in functions JSON_ARRAY, JSON_OBJECT, JSON_QUERY, JSON_ARRAYAGG, or JSON_OBJECTAGG, the explicit or implicit FORMAT value of the function's RETURNING clause determines the format of *JSON-expression*.
- If *JSON-expression* is a binary string type, it is interpreted as FORMAT BSON.
- Otherwise, *JSON-expression* is considered unformatted data. If the generated value is not numeric, the result string will be constructed with strings enclosed in quotes and any special characters will be escaped. A numeric value that is not a valid JSON number, such as INFINITY or NAN, will result in an error.

NULL ON NULL or ABSENT ON NULL

Specifies what to return when *JSON-expression* is the null value.

NULL ON NULL

A null value is returned. This is the default.

ABSENT ON NULL

The *key:value* pair is omitted from the JSON object.

WITHOUT UNIQUE KEYS or WITH UNIQUE KEYS

Specifies whether the key values for the resulting JSON object must be unique.

WITHOUT UNIQUE KEYS

The resulting JSON object will not be checked for duplicate keys. This is the default.

WITH UNIQUE KEYS

The resulting JSON object is required to have unique key values. An error will be issued if duplicate keys are generated.

Generating a JSON object with unique keys is considered the best practice. If *key-name-expression* generates unique key names, omit WITH UNIQUE KEYS to improve performance.

RETURNING data-type

Specifies the format of the result.

data-type

The data type of the result. For CHAR and VARCHAR results, the CCSID cannot be 65535. The default is CLOB(2G) CCSID 1208.

If a CCSID is specified and the *data-type* is GRAPHIC, VARGRAPHIC, or DBCLOB, the CCSID must be a Unicode CCSID.

If the CCSID attribute is not specified, the CCSID is determined as described in [“CAST specification” on page 177](#).

FORMAT JSON

JSON data is returned as a JSON string.

ENCODING UTF8 or ENCODING UTF16

The encoding to use when *data-type* is a binary string type. This clause is only allowed for binary string types. The default for binary strings is UTF8.

FORMAT BSON

JSON data is returned in BSON format. When FORMAT BSON is specified, *data-type* must be a VARBINARY or BLOB string type.

Examples

- Generate a JSON object for a name.

```
VALUES (JSON_OBJECT(KEY 'first' VALUE 'John', KEY 'last' VALUE 'Doe'));
VALUES (JSON_OBJECT('first' : 'John', 'last' : 'Doe'));
```

The result of either of these statements is the following JSON string:

```
{"first": "John", "last": "Doe"}
```

- Generate a JSON object containing the last name, date hired, and salary for the employee with an employee number of '000020'.

```
SELECT JSON_OBJECT(
    'Last name' : LASTNAME,
    'Hire date' : HIREDATE,
    'Salary'    : SALARY)
FROM EMPLOYEE
WHERE EMPNO = '000020';
```

The result of this statement is the following JSON string:

```
{"Last name": "THOMPSON", "Hire date": "1973-10-10", "Salary": 41250.00}
```

JSON_QUERY

The JSON_QUERY function returns an SQL/JSON value from the specified JSON text by using an SQL/JSON path expression.

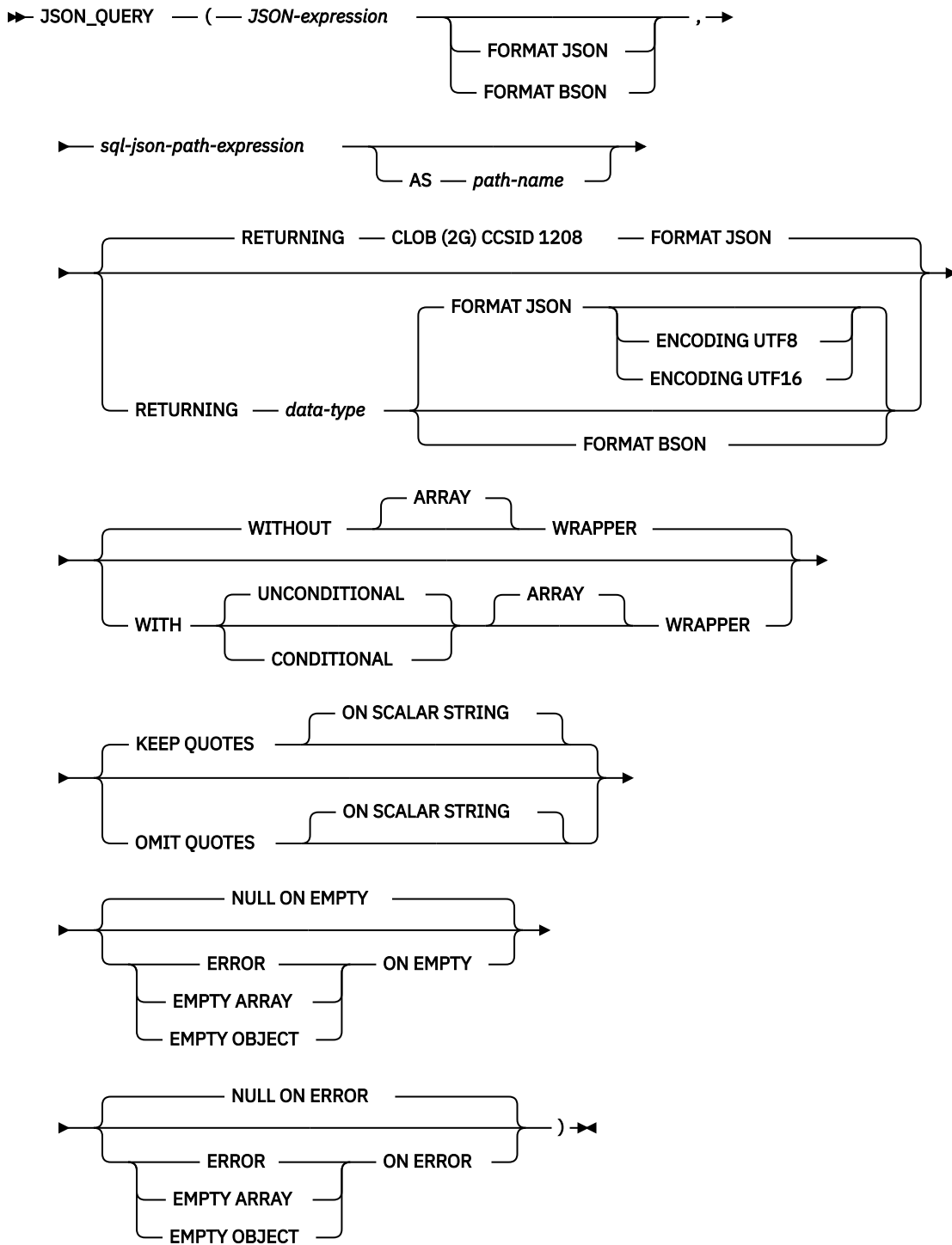

data-type

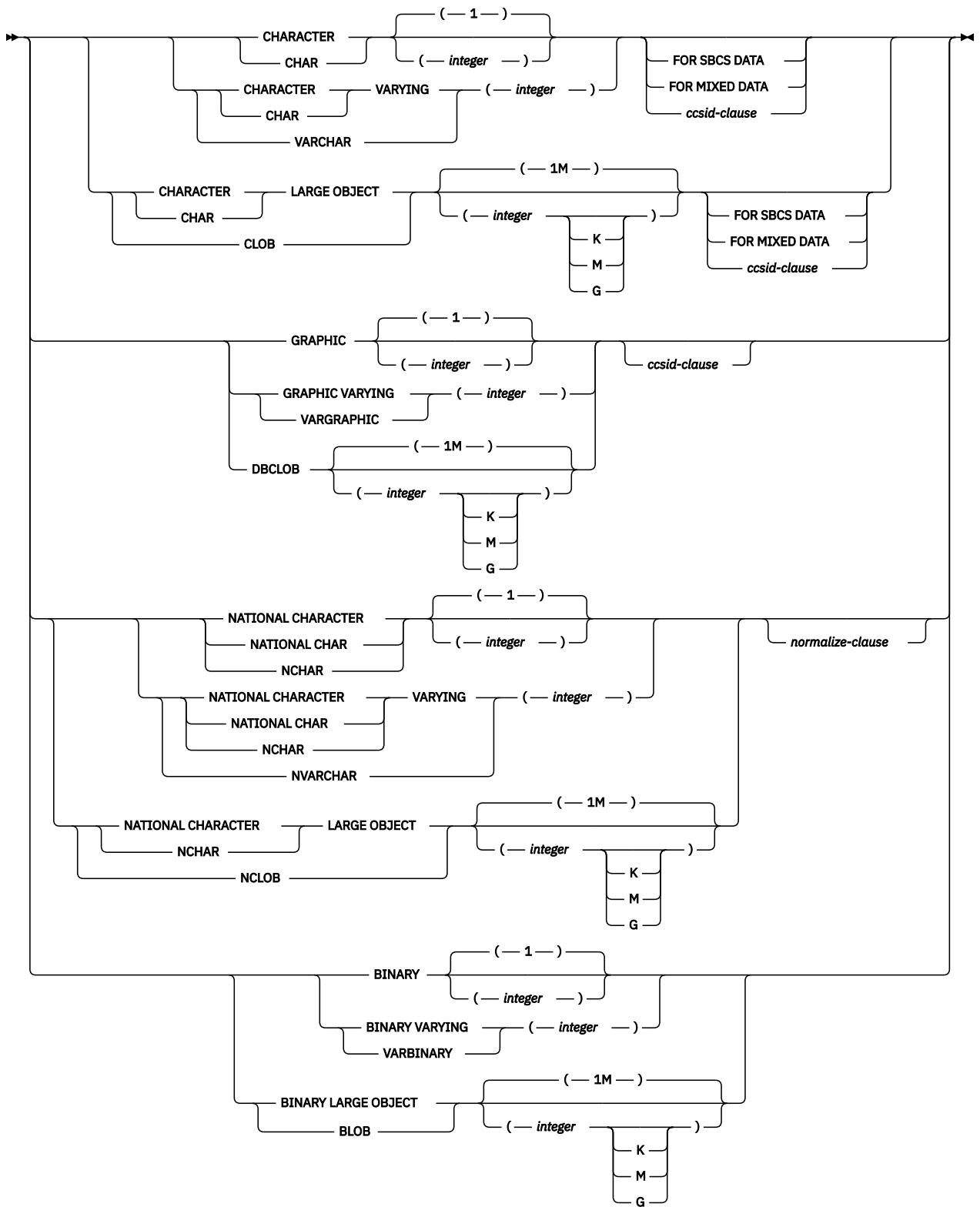

ccsid-clause

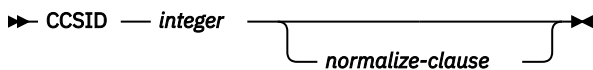

normalize-clause

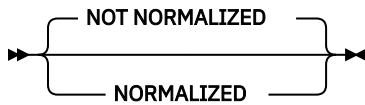

JSON-expression

An expression that returns a value that is a built-in string data type. If a character or graphic value is returned, it must contain correctly formatted JSON data. If it is a binary data type, it is interpreted according to the explicit or implicit **FORMAT** clause.

If *JSON-expression* is a JSON array, it will be implicitly wrapped using a key name of `SYSIBM_ROOT_ARRAY` modifying the *JSON-expression* to be a JSON object. *sql-json-path-expression* is implicitly modified to account for this additional key.

FORMAT JSON or FORMAT BSON

Specifies how *JSON-expression* is to be interpreted.

FORMAT JSON

JSON-expression contains JSON data. If *JSON-expression* is binary data, the data is interpreted as UTF-8 or UTF-16. Binary data cannot be encoded using an EBCDIC CCSID.

FORMAT BSON

JSON-expression contains the BSON representation of JSON data. When **FORMAT BSON** is specified, *JSON-expression* must be a binary string data type.

If the **FORMAT** clause is not specified and *JSON-expression* is a character or graphic string, *JSON-expression* is treated as JSON. If *JSON-expression* is a binary string, *JSON-expression* is treated as BSON.

sql-json-path-expression

An expression that returns a value that is a built-in character or graphic string data type. The string is interpreted as an SQL/JSON path expression and is used to locate a JSON value within the JSON data specified by *JSON-expression*. If more than one value has the same key, one of the JSON values will be selected.

For information on the content of an SQL/JSON path expression, see [“sql-json-path-expression” on page 214](#).

AS path-name

Specifies a name to be used to identify the *sql-json-path-expression*.

RETURNING data-type

Specifies the format of the result.

data-type

The data type of the result. For CHAR and VARCHAR results, the CCSID cannot be 65535. The default is CLOB(2G) CCSID 1208.

If a CCSID is specified and the *data-type* is GRAPHIC, VARGRAPHIC, or DBCLOB, the CCSID must be a Unicode CCSID.

If the CCSID attribute is not specified, the CCSID is determined as described in [“CAST specification” on page 177](#).

FORMAT JSON

JSON data is returned as a JSON string.

ENCODING UTF8 or ENCODING UTF16

The encoding to use when *data-type* is a binary string type. This clause is only allowed for binary string types. The default for binary strings is UTF8.

FORMAT BSON

JSON data is returned in BSON format. When **FORMAT BSON** is specified, *data-type* must be a VARBINARY or BLOB string type. **FORMAT BSON** can only be used when an SQL/JSON object is returned.

WITHOUT ARRAY WRAPPER or WITH ARRAY WRAPPER

Specifies whether the output value should be wrapped in a JSON array.

WITHOUT ARRAY WRAPPER

The result is not wrapped. This is the default. Using an SQL/JSON path that results in a sequence of two or more SQL/JSON elements results in an error.

WITH UNCONDITIONAL ARRAY WRAPPER

The result is enclosed in square brackets to create a JSON array.

WITH CONDITIONAL ARRAY WRAPPER

The result is enclosed in square brackets to create a JSON array when more than one SQL/JSON element is returned or when a single SQL/JSON element that is not a JSON array or JSON object is returned.

The following table shows how each of these options is applied to the JSON text {a: "10", b: [1, 2]}.

<i>Table 54. Results using each WRAPPER clause</i>		
WRAPPER clause	path value of \$.a	path value of \$.b
WITHOUT ARRAY WRAPPER	"10"	[1,2]
WITH UNCONDITIONAL ARRAY WRAPPER	["10"]	[[1,2]]
WITH CONDITIONAL ARRAY WRAPPER	["10"]	[1,2]

KEEP QUOTES or OMIT QUOTES

Specifies whether the surrounding quotes should be removed when a scalar string is returned.

KEEP QUOTES

Indicates quotes are not removed from scalar strings. This is the default.

OMIT QUOTES

Indicates quotes are removed from scalar strings. When OMIT QUOTES is specified, the WITH ARRAY WRAPPER clause cannot be specified

ON EMPTY

Specifies the behavior when an empty sequence is returned using *sql-json-path-expression*.

NULL ON EMPTY

A null value is returned. This is the default.

ERROR ON EMPTY

An error is returned.

EMPTY ARRAY ON EMPTY

An empty array is returned.

EMPTY OBJECT ON EMPTY

An empty object is returned.

ON ERROR

Specifies the behavior when an error is encountered by JSON_QUERY.

NULL ON ERROR

A null value is returned. This is the default.

ERROR ON ERROR

An error is returned.

EMPTY ARRAY ON ERROR

An empty array is returned.

EMPTY OBJECT ON ERROR

An empty object is returned.

The result can be null. If *JSON-expression* is null, the result is the null value.

Example

- Return the JSON object associated with the name key from a JSON text.

```
VALUES JSON_QUERY('{ "id": "701", "name": { "first": "John", "last": "Doe" } }', '$.name');
```

The result is the following string that represents a JSON object.

```
{ "first": "John", "last": "Doe" }
```

JSON_TO_BSON

The JSON_TO_BSON function converts a string containing formatted JSON data to a binary string containing the data formatted as BSON.

►► JSON_TO_BSON (— *JSON-expression* —) ◄◄

JSON-expression

Specifies an expression that returns a character or graphic string value. It must contain formatted JSON data.

If *JSON-expression* is a JSON array, it will be wrapped using a key name of SYSIBM_ROOT_ARRAY modifying the *JSON-expression* to be a JSON object.

If a JSON object in *JSON-expression* contains duplicate keys, only one of the *key:value* pairs will be included in the result BSON string.

The data type of the result is BLOB(2G).

If the argument can be null, the result can be null; if the argument is null, the result is the null value.

Example

- Read a JSON value from a table and convert it to BSON format.

```
CREATE VARIABLE BSONVAR VARBINARY(2000);  
SELECT JSON_TO_BSON(JSON_COL) INTO BSONVAR FROM TABLE2 WHERE KEY_COLUMN = 27;
```

JSON_VALUE

The JSON_VALUE function returns an SQL scalar value from a JSON text by using an SQL/JSON path expression.

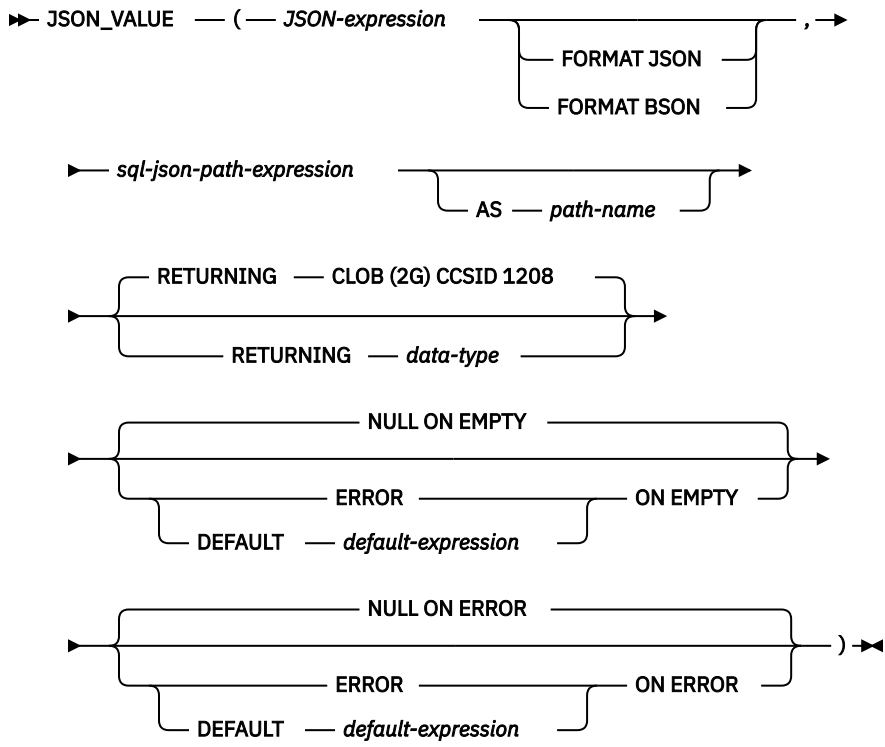

data-type

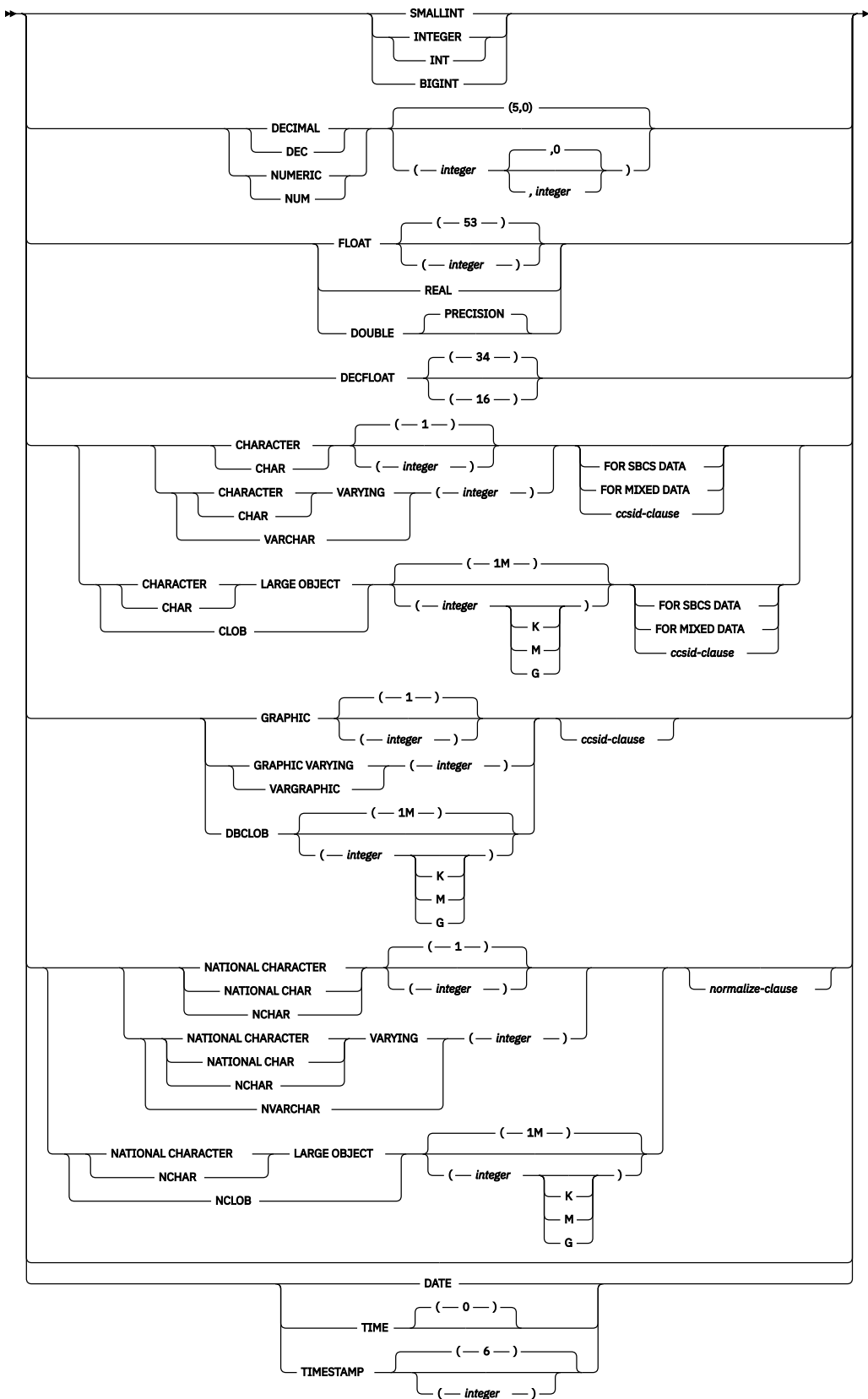

ccsid-clause

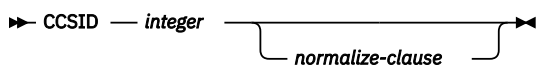

normalize-clause



JSON-expression

An expression that returns a value that is a built-in string data type. If a character or graphic value is returned, it must contain correctly formatted JSON data. If it is a binary data type, it is interpreted according to the explicit or implicit `FORMAT` clause.

If *JSON-expression* is a JSON array, it will be implicitly wrapped using a key name of `SYSIBM_ROOT_ARRAY` modifying the *JSON-expression* to be a JSON object. *sql-json-path-expression* is implicitly modified to account for this additional key.

FORMAT JSON or FORMAT BSON

Specifies how *JSON-expression* is to be interpreted.

FORMAT JSON

JSON-expression contains JSON data. If *JSON-expression* is binary data, the data is interpreted as UTF-8 or UTF-16. Binary data cannot be encoded using an EBCDIC CCSID.

FORMAT BSON

JSON-expression contains the BSON representation of JSON data. When `FORMAT BSON` is specified, *JSON-expression* must be a binary string data type.

If the `FORMAT` clause is not specified and *JSON-expression* is a character or graphic string, *JSON-expression* is treated as JSON. If *JSON-expression* is a binary string, *JSON-expression* is treated as BSON.

sql-json-path-expression

An expression that returns a value that is a built-in character or graphic string data type. The string is interpreted as an SQL/JSON path expression and is used to locate a JSON value within the JSON data specified by *JSON-expression*. If more than one value has the same key, one of the JSON values will be selected.

For information on the content of an SQL/JSON path expression, see [“sql-json-path-expression” on page 214](#).

AS path-name

Specifies a name to be used to identify the *sql-json-path-expression*.

RETURNING data-type

Specifies the data type of the result. For `CHAR` and `VARCHAR` results, the CCSID cannot be 65535. The default is `CLOB(2G) CCSID 1208`.

ON EMPTY

Specifies the behavior when an empty sequence is found using *sql-json-path-expression*.

NULL ON EMPTY

A null value is returned. This is the default.

ERROR ON EMPTY

An error is returned.

DEFAULT default-expression ON EMPTY

The value specified by *default-expression* is returned. The expression must be assignment compatible to the result data type.

ON ERROR

Specifies the behavior when an error is encountered by `JSON_VALUE`.

NULL ON ERROR

A null value is returned. This is the default.

ERROR ON ERROR

An error is returned.

DEFAULT default-expression ON ERROR

The value specified by *default-expression* is returned. The expression must be assignment compatible to the result data type.

The result can be null. If *JSON-expression* is null, the result is the null value.

Example

- Return a value from a JSON text as an integer.

```
VALUES (JSON_VALUE('{\"id\":987}', '$.id' RETURNING INTEGER));
```

The result is 987.

- Try to return a value from a JSON text that is an array value. Handle any error by returning a default string.

```
VALUES (JSON_VALUE('{\"friends\":[\"John\",\"Lisa\"]}',  
    'strict $.friends' DEFAULT 'Not found' ON ERROR));
```

The result is Not found since the value corresponding to the `friends` key is an array, not a scalar value.

JULIAN_DAY

The JULIAN_DAY function returns an integer value representing a number of days from January 1, 4713 B.C. (the start of the Julian date calendar) to the date specified in the argument.

►► JULIAN_DAY — (— *expression* —) ►►

expression

An expression that returns a value of one of the following built-in data types: a date, a timestamp, a character string, or a graphic string. If *expression* is a character or graphic string, its value must be a valid string representation of a date or timestamp. For the valid formats of string representations of dates and timestamps, see [“String representations of datetime values”](#) on page 75.

The result of the function is a large integer. If the argument can be null, the result can be null; if the argument is null, the result is the null value.

Note

Julian and Gregorian calendar: The transition from the Julian calendar to the Gregorian calendar on 15 October 1582 is not taken into account by this function.

Examples

- Using sample table EMPLOYEE, set the integer host variable JDAY to the Julian day of the day that Christine Haas (EMPNO = '000010') was employed (HIREDATE = '1965-01-01').

```
SELECT JULIAN_DAY(HIREDATE)
INTO :JDAY
FROM EMPLOYEE
WHERE EMPNO = '000010'
```

The result is that JDAY is set to 2438762.

- Set integer host variable JDAY to the Julian day for January 1, 1998.

```
SELECT JULIAN_DAY('1998-01-01')
INTO :JDAY
FROM SYSIBM.SYSDUMMY1
```

The result is that JDAY is set to 2450815.

LAND

The LAND function returns a string that is the logical 'AND' of the argument strings. This function takes the first argument string, does an AND operation with the next string, and then continues to do AND operations with each successive argument using the previous result. If a character-string argument is shorter than the previous result, it is padded with blanks. If a binary-string argument is shorter than the previous result, it is padded with hexadecimal zeros.

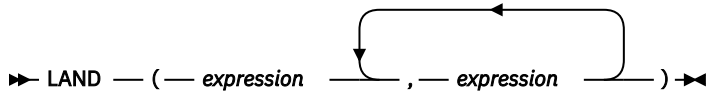

The arguments must be compatible.

expression

An expression that returns a value of any built-in numeric or string data type, but cannot be LOBs. The arguments cannot be mixed data character strings, UTF-8 character strings, or graphic strings. A numeric argument is cast to a character string before evaluating the function. For more information about converting numeric to a character string, see [“VARCHAR” on page 616](#).

The arguments are converted, if necessary, to the attributes of the result. The attributes of the result are determined as follows:

- If all the arguments are fixed-length strings, the result is a fixed-length string of length n , where n is the length of the longest argument.
- If any argument is a varying-length string, the result is a varying-length string with length attribute n , where n is the length attribute of the argument with greatest length attribute. The actual length of the result is m , where m is the actual length of the longest argument.

If an argument can be null, the result can be null; if an argument is null, the result is the null value.

The CCSID of the result is 65535.

Example

- Assume the host variable L1 is a CHARACTER(2) host variable with a value of X'A1B1', host variable L2 is a CHARACTER(3) host variable with a value of X'F0F040', and host variable L3 is a CHARACTER(4) host variable with a value of X'A1B10040'.

```
SELECT LAND(:L1, :L2, :L3)
FROM SYSIBM.SYSDUMMY1
```

Returns the value X'A0B00040'.

LAST_DAY

The LAST_DAY function returns a date or timestamp that represents the last day of the month indicated by *expression*.

►► LAST_DAY — (— *expression* —) ◄◄

expression

An expression that returns a value of one of the following built-in data types: a date, a timestamp, a character string, or a graphic string.

If *expression* is a character or graphic string, its value must be a valid string representation of a date or timestamp. For the valid formats of string representations of dates and timestamps, see [“String representations of datetime values”](#) on page 75.

The result of the function has the same data type as *expression*, unless *expression* is a string in which case the result is DATE. If the argument can be null, the result can be null; if the argument is null, the result is the null value.

Any hours, minutes, seconds, or fractional seconds information included in *expression* is not changed by the function.

Example

- Set the host variable END_OF_MONTH with the last day of the current month.

```
SET :END_OF_MONTH = LAST_DAY(CURRENT_DATE)
```

The host variable END_OF_MONTH is set with the value representing the end of the current month. If the current day is 2000-02-10, then END_OF_MONTH is set to 2000-02-29.

- Set the host variable END_OF_MONTH with the last day of the month in EUR format for the given date.

```
SET :END_OF_MONTH = CHAR(LAST_DAY('1965-07-07'), EUR)
```

The host variable END_OF_MONTH is set with the value '31.07.1965'.

- Assuming that the default date format is ISO,

```
SELECT LAST_DAY('2000-04-24')  
FROM SYSIBM.SYSDUMMY1
```

Returns '2000-04-30' which is the last day of April in 2000.

LCASE

The LCASE function returns a string in which all the characters have been converted to lowercase characters, based on the CCSID of the argument.

►► LCASE — (— *expression* —) ►►

The LCASE function is identical to the LOWER function. For more information, see [“LOWER” on page 479](#).

LEAST

The LEAST scalar function returns the minimum value in a set of values.

► LEAST (*expression* , *expression*) ◄

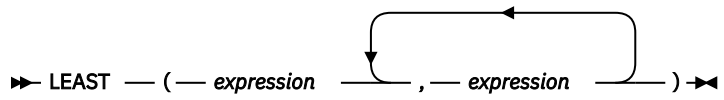

The LEAST function is identical to the MIN function. For more information, see [“MIN” on page 489](#).

LEFT

The LEFT function returns the leftmost *integer* characters of *expression*.

►► LEFT (— *expression* — , — *integer* —) ◄◄

If *expression* is a character string, the result is a character string. If *expression* is a graphic string, the result is a graphic string. If *expression* is a binary string, the result is a binary string.

expression

An expression that specifies the string from which the result is derived. The arguments must be expressions that return a value of any built-in numeric, character string, graphic string, or a binary string data type. A numeric argument is cast to a character string before evaluating the function. For more information about converting numeric to a character string, see “VARCHAR” on page 616.

A substring of *expression* is zero or more contiguous characters of *expression*. If *expression* is a character string or graphic string, a single character is either an SBCS, DBCS, or multiple-byte character. If *expression* is a binary string, the result is the number of bytes in the argument.

integer

An expression that returns a built-in integer data type. The integer specifies the length of the result. The value of *integer* must be greater than or equal to 0 and less than or equal to *n*, where *n* is the length attribute of *expression*.

The result of the function is a varying-length string with a length attribute that is the same as the length attribute of *expression* and a data type that depends on the data type of *expression*:

Data type of <i>expression</i>	Data type of the Result
CHAR or VARCHAR	VARCHAR
CLOB	CLOB
GRAPHIC or VARGRAPHIC	VARGRAPHIC
DBCLOB	DBCLOB
BINARY or VARBINARY	VARBINARY
BLOB	BLOB

The actual length of the result is *integer*.

If any argument can be null, the result can be null; if any argument is null, the result is the null value.

The CCSID of the result is the same as that of *expression*.

Note

Syntax alternatives: STRLEFT is a synonym for LEFT.

Example

- Assume the host variable NAME (VARCHAR(50)) has a value of 'KATIE AUSTIN' and the host variable FIRSTNAME_LEN (int) has a value of 5.

```
SELECT LEFT(:NAME, :FIRSTNAME_LEN)
FROM SYSIBM.SYSDUMMY1
```

Returns the value 'KATIE'

- Assume that NAME is a VARCHAR(128) column, encoded in Unicode UTF-8, that contains the value 'Jürgen'.

```
SELECT LEFT(NAME, 2), SUBSTR(NAME, 1, 2)
FROM T1
WHERE NAME = 'Jürgen'
```

Returns the value 'Jü' for LEFT and 'JÊ' for SUBSTR(NAME, 1, 2).

LENGTH

The LENGTH function returns the length of a value.

►► LENGTH — (— *expression* —) ►►

See “[CHARACTER_LENGTH or CHAR_LENGTH](#)” on page 330, “[OCTET_LENGTH](#)” on page 515, and “[BIT_LENGTH](#)” on page 319 for similar functions.

expression

An expression that returns a value of any built-in data type.

The result of the function is a large integer. If the argument can be null, the result can be null; if the argument is null, the result is the null value.

The result is the length of the argument. The length of strings includes blanks. The length of a varying-length string is the actual length, not the length attribute.

The length of a graphic string is the number of double-byte characters (the number of bytes divided by 2). The length of all other values is the number of bytes used to represent the value:

- 2 for small integer
- 4 for large integer
- 8 for big integer
- The integral part of $(p/2)+1$ for packed decimal numbers with precision p
- p for zoned decimal numbers with precision p
- 4 for single-precision float
- 8 for double-precision float
- 8 for DECFLOAT(16)
- 16 for DECFLOAT(34)
- The length of the string for strings
- 3 for time
- 4 for date
- $7+((p+1)/2)$ for timestamp(p)
- The actual number of bytes used to store the DataLink value (plus 19 if the DataLink is FILE LINK CONTROL and READ PERMISSION DB) for datalinks
- 26 for row ID

Examples

- Assume the host variable ADDRESS is a varying-length character string with a value of '895 Don Mills Road'.

```
SELECT LENGTH(:ADDRESS)
FROM SYSIBM.SYSDUMMY1
```

Returns the value 18.

- Assume that PRSTDATE is a column of type DATE.

```
SELECT LENGTH(PRSTDATE)
FROM PROJECT
```

Returns the value 4.

- Assume that PRSTDATE is a column of type DATE.

```
SELECT LENGTH(CHAR(PRSTDATE, EUR))  
FROM PROJECT
```

Returns the value 10.

LN

The LN function returns the natural logarithm of a number. The LN and EXP functions are inverse operations.

►► LN — (— *expression* —) ►►

expression

An expression that returns a value of any built-in numeric, character-string, or graphic-string data type. A string argument is cast to double-precision floating point before evaluating the function. For more information about converting strings to double-precision floating point, see [“DOUBLE_PRECISION or DOUBLE” on page 391](#). The value of the argument must be greater than zero.

If the data type of the argument is DECFLOAT(*n*), the result is DECFLOAT(*n*). Otherwise, the data type of the result is double-precision floating point. If the argument can be null, the result can be null; if the argument is null, the result is the null value.

Note

Results involving DECFLOAT special values: For decimal floating-point values the special values are treated as follows:

- LN(NaN) returns NaN. ⁶⁰
- LN(-NaN) returns NaN. ⁶⁰
- LN(Infinity) returns Infinity.
- LN(-Infinity) returns NaN. ⁶⁰
- LN(sNaN) and LN(-sNaN) return a warning or error. ⁶⁰
- LN(0) returns -Infinity.
- LN with a negative argument, including -Infinity, returns NaN. ⁶⁰

Example

- Assume the host variable NATLOG is a DECIMAL(4,2) host variable with a value of 31.62.

```
SELECT LN(:NATLOG)
FROM SYSIBM.SYSDUMMY1
```

Returns the approximate value 3.45.

⁶⁰ If *YES is specified for the SQL_DECFLOAT_WARNINGS query option, NaN is returned with a warning.

LNOT

The LNOT function returns a string that is the logical NOT of the argument string.

►► LNOT — (— *expression* —) ◄◄

expression

An expression that returns a value of any built-in numeric or string data type, but cannot be LOBs. The arguments cannot be mixed data character strings, UTF-8 character strings, or graphic strings. A numeric argument is cast to a character string before evaluating the function. For more information about converting numeric to a character string, see [“VARCHAR” on page 616](#).

The data type and length attribute of the result is the same as the data type and length attribute of the argument value. If the argument is a varying-length string, the actual length of the result is the same as the actual length of the argument value. If the argument can be null, the result can be null; if the argument is null, the result is the null value.

The CCSID of the result is 65535.

Example

- Assume the host variable L1 is a CHARACTER(2) host variable with a value of X'F0F0'.

```
SELECT LNOT (:L1)
FROM SYSIBM.SYSDUMMY1
```

Returns the value X'0F0F'.

LOCATE

The LOCATE function returns the starting position of the first occurrence of one string (called the *search-string*) within another string (called the *source-string*). If the *search-string* is not found and neither argument is null, the result is zero. If the *search-string* is found, the result is a number from 1 to the actual length of the *source-string*. If the optional *start* is specified, it indicates the character position in the *source-string* at which the search is to begin.

► LOCATE ((— *search-string* — , — *source-string* —) — *start* —) ►

search-string

An expression that specifies the string that is to be searched for. *search-string* may be any built-in numeric, datetime, or string expression. It must be compatible with the *source-string*. A numeric or datetime argument is cast to a character string before evaluating the function. For more information about converting numeric and datetime to a character string, see “[VARCHAR](#)” on page 616.

source-string

An expression that specifies the source string in which the search is to take place. *source-string* may be any built-in numeric, datetime, or string expression. A numeric or datetime argument is cast to a character string before evaluating the function. For more information about converting numeric and datetime to a character string, see “[VARCHAR](#)” on page 616.

start

An expression that specifies the position within *source-string* at which the search is to start. *start* may be any built-in numeric, character string, or graphic string expression. If the value is not of type INTEGER, it is implicitly cast to INTEGER before evaluating the function. The value must be greater than zero.

If *start* is specified, the function is similar to:

```
POSITION( search-string , SUBSTRING(source-string,start) ) + start - 1
```

If *start* is not specified, the function is equivalent to:

```
POSITION( search-string , source-string ) )
```

For more information, see “[POSITION](#)” on page 520.

The result of the function is a large integer. If any of the arguments can be null, the result can be null; if any of the arguments is null, the result is the null value.

The LOCATE function operates on a character basis. Because LOCATE operates on a character-string basis, any shift-in and shift-out characters are not required to be in exactly the same position and their only significance is to indicate which characters are SBCS and which characters are DBCS.

If the CCSID of the *search-string* is different than the CCSID of the *source-string*, it is converted to the CCSID of the *source-string*.

If a collating sequence other than *HEX is in effect when the statement that contains the LOCATE function is executed and the arguments are SBCS data, mixed data, or Unicode data, then the result is obtained by comparing weighted values for each value in the set. The weighted values are based on the collating sequence. An ICU collating sequence table may not be specified with the LOCATE function.

Example

- Select RECEIVED and SUBJECT columns as well as the starting position of the words 'GOOD' within the NOTE_TEXT column for all entries in the IN_TRAY table that contain these words.

```
SELECT RECEIVED, SUBJECT, LOCATE('GOOD', NOTE_TEXT)
FROM IN_TRAY
WHERE LOCATE('GOOD', NOTE_TEXT) <> 0
```

- Assume that NOTE is a VARCHAR(128) column, encoded in Unicode UTF-8, that contains the value 'Jürgen lives on Hegelstraße'. Find the character position of the character 'ß' in the string.

```
SELECT LOCATE( 'ß', NOTE ), POSSTR( NOTE_TEXT, 'ß')  
FROM T1
```

Returns the value 26 for LOCATE and 27 for POSSTR.

LOCATE_IN_STRING

The `LOCATE_IN_STRING` function returns the starting position of a string (called the *search-string*) within another string (called the *source-string*). If the *search-string* is not found and neither argument is null, the result is zero. If the *search-string* is found, the result is a number from 1 to the actual length of the *source-string*. If the optional *start* is specified, it indicates the character position in the *source-string* at which the search is to begin.

►► `LOCATE_IN_STRING` (`source-string` , `search-string` ►►

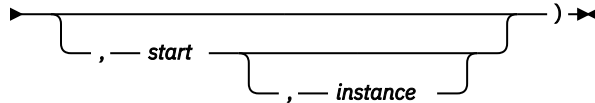

If the optional *start* is specified, it indicates the character position in the *source-string* at which the search is to begin. If *start* is specified, an optional *instance* number can also be specified. The *instance* argument is used to determine the specific occurrence of *search-string* within *source-string*. Each unique instance can include any of the characters in a previous instance, but not all characters in a previous instance.

If the *search-string* has a length of zero, the result returned by the function is 1. If the *source-string* has a length of zero, the result returned by the function is 0. If neither condition exists, and if the value of *search-string* is equal to an identical length of a substring of contiguous positions within the value of *source-string*, the result returned by the function is the starting position of that substring within the *source-string* value; otherwise, the result returned by the function is 0.

source-string

An expression that specifies the source string in which the search is to take place. *source-string* may be any built-in numeric, datetime, or string expression. A numeric or datetime argument is cast to a character string before evaluating the function. For more information about converting numeric and datetime to a character string, see [“VARCHAR” on page 616](#).

search-string

An expression that specifies the string that is to be searched for. *search-string* may be any built-in numeric, datetime, or string expression. It must be compatible with the *source-string*. A numeric or datetime argument is cast to a character string before evaluating the function. For more information about converting numeric and datetime to a character string, see [“VARCHAR” on page 616](#).

start

An expression that specifies the position within *source-string* at which the search is to start. *start* may be any built-in numeric, character string, or graphic string expression. If the value is not of type `INTEGER`, it is implicitly cast to `INTEGER` before evaluating the function.

If the value of the integer is greater than zero, the search begins at *start* and continues for each position to the end of the string. If the value of the integer is less than zero, the search begins at `CHARACTER_LENGTH(source-string) + start + 1` and continues for each position to the beginning of the string.

If *start* is not specified, the function is equivalent to:

```
POSITION( search-string , source-string )
```

If *start* is zero, an error is returned.

instance

An expression that specifies which instance of *search-string* to search for within *source-string*. The expression must return a value that is a built-in numeric, character string, or graphic string data type. If the value is not of type `INTEGER`, it is implicitly cast to `INTEGER` before evaluating the function. If *instance* is not specified, the default is 1. The value of the integer must be greater than or equal to 1.

At each search position, a match is found when the substring at that position and `CHARACTER_LENGTH(search-string) - 1` values to the right of the search position in *source-string*, is equal to *search-string*.

The result of the function is a large integer. The result is the starting position of the instance of *search-string* within *source-string*. The value is relative to the beginning of the string (regardless of the specification of *start*).

If any argument can be null, the result can be null; if any argument is null, the result is the null value.

The `LOCATE_IN_STRING` function operates on a character basis. Because `LOCATE_IN_STRING` operates on a character-string basis, any shift-in and shift-out characters are not required to be in exactly the same position and their only significance is to indicate which characters are SBCS and which characters are DBCS.

If the `CCSID` of the *search-string* is different than the `CCSID` of the *source-string*, it is converted to the `CCSID` of the *source-string*.

If a collating sequence other than `*HEX` is in effect when the statement that contains the `LOCATE_IN_STRING` function is executed and the arguments are SBCS data, mixed data, or Unicode data, then the result is obtained by comparing weighted values for each value in the set. The weighted values are based on the collating sequence. An ICU collating sequence table may not be specified with the `LOCATE` function.

Syntax alternatives: `INSTR` can be used as a synonym for `LOCATE_IN_STRING`.

Example

- Locate the character 'ß' in the string 'Jürgen lives on Hegelstraße' by searching from the end of the string, and set the host variable `POSITION` with the position within the string.

```
SET :POSITION = LOCATE_IN_STRING('Jürgen lives on Hegelstraße','ß',-1);
```

The value of host variable `POSITION` is set to 26.

- Find the position of an occurrence of the character 'N' in the string 'WINNING' by searching from the start of the string.

```
SELECT LOCATE_IN_STRING('WINNING','N',1,3),
       LOCATE_IN_STRING('WINNING','N',3,2),
       LOCATE_IN_STRING('WINNING','N',3,3)
FROM SYSIBM.SYSDUMMY1;
```

Returns the values:

```
6    4    6
```

- Find the position of an occurrence of the character 'N' in the string 'WINNING' by searching from the end of the string.

```
SELECT LOCATE_IN_STRING('WINNING','N',-1,3),
       LOCATE_IN_STRING('WINNING','N',-3,2),
       LOCATE_IN_STRING('WINNING','N',-3,3)
FROM SYSIBM.SYSDUMMY1;
```

Returns the values:

```
3    3    0
```

LOG10

The LOG10 function returns the common logarithm (base 10) of a number. The LOG10 and ANTILOG functions are inverse operations.

►► LOG10 — (— *expression* —) ►►

expression

An expression that returns a value of any built-in numeric, character-string, or graphic-string data type. A string argument is cast to double-precision floating point before evaluating the function. For more information about converting strings to double-precision floating point, see “DOUBLE_PRECISION or DOUBLE” on page 391.

If the data type of the argument is DECFLOAT(*n*), the result is DECFLOAT(*n*). Otherwise, the data type of the result is double-precision floating point. If the argument can be null, the result can be null; if the argument is null, the result is the null value.

Note

Results involving DECFLOAT special values: For decimal floating-point values the special values are treated as follows:

- LOG10(NaN) returns NaN. ⁶¹
- LOG10(-NaN) returns NaN. ⁶¹
- LOG10(Infinity) returns Infinity.
- LOG10(-Infinity) returns NaN. ⁶¹
- LOG10(sNaN) and LOG10(-sNaN) return a warning or error. ⁶¹
- LOG10(0) returns -Infinity.
- LOG10 with a negative argument, including -Infinity, returns NaN. ⁶¹

Syntax alternatives: LOG is a synonym for LOG10. It is supported only for compatibility with previous Db2 releases. LOG10 should be used instead of LOG because some database managers and applications implement LOG as the natural logarithm of a number instead of the common logarithm of a number.

Example

- Assume the host variable L is a DECIMAL(4,2) host variable with a value of 31.62.

```
SELECT LOG10(:L)
FROM SYSIBM.SYSDUMMY1
```

Returns the approximate value 1.49.

⁶¹ If *YES is specified for the SQL_DECFLOAT_WARNINGS query option, NaN is returned with a warning.

LOR

The LOR function returns a string that is the logical OR of the argument strings. This function takes the first argument string, does an OR operation with the next string, and then continues to do OR operations for each successive argument using the previous result. If a character-string argument is shorter than the previous result, it is padded with blanks. If a binary-string argument is shorter than the previous result, it is padded with hexadecimal zeros.

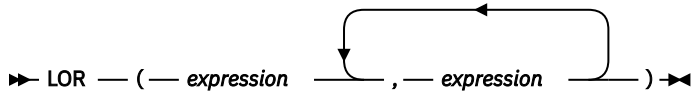

The arguments must be compatible.

expression

An expression that returns a value of any built-in numeric or string data type, but cannot be LOBs. The arguments cannot be mixed data character strings, UTF-8 character strings, or graphic strings. A numeric argument is cast to a character string before evaluating the function. For more information about converting numeric to a character string, see [“VARCHAR” on page 616](#).

The arguments are converted, if necessary, to the attributes of the result. The attributes of the result are determined as follows:

- If all the arguments are fixed-length strings, the result is a fixed-length string of length n , where n is the length of the longest argument.
- If any argument is a varying-length string, the result is a varying-length string with length attribute n , where n is the length attribute of the argument with greatest length attribute. The actual length of the result is m , where m is the actual length of the longest argument.

If an argument can be null, the result can be null; if an argument is null, the result is the null value.

The CCSID of the result is 65535.

Example

- Assume the host variable L1 is a CHARACTER(2) host variable with a value of X'0101', host variable L2 is a CHARACTER(3) host variable with a value of X'F0F000', and host variable L3 is a CHARACTER(4) host variable with a value of X'0000000F'.

```
SELECT LOR(:L1, :L2, :L3)
FROM SYSIBM.SYSDUMMY1
```

Returns the value X'F1F1404F'.

LOWER

The LOWER function returns a string in which all the characters have been converted to lowercase characters, based on the CCSID of the argument. Only SBCS, Unicode graphic characters are converted. The characters A-Z are converted to a-z, and characters with diacritical marks are converted to their lowercase equivalent, if any.

►► LOWER — (— *expression* —) ◄◄

Refer to the [UCS-2 level 1 mapping tables](#) topic in the [Globalization](#) topic collection for a description of the monocasing tables that are used for this translation.

expression

An expression that specifies the string to be converted. *expression* must be any built-in numeric, character, Unicode graphic string. A numeric argument is cast to a character string before evaluating the function. For more information about converting numeric to a character string, see [“VARCHAR” on page 616](#).

The result of the function has the same data type, length attribute, actual length, and CCSID as the argument. If the argument can be null, the result can be null. If the argument is null, the result is the null value.

Note

Syntax alternatives: LCASE is a synonym for LOWER.

Examples

- Ensure that the characters in the value of host variable NAME are lowercase. NAME has a data type of VARCHAR(30) and a value of 'Christine Smith'.

```
SELECT LOWER(:NAME)
FROM SYSIBM.SYSDUMMY1
```

The result is the value 'christine smith'.

LPAD

The LPAD function returns a string composed of *expression* that is padded on the left.

►► LPAD (*expression* , *length* , *pad*) ◄◄

The LPAD function treats leading or trailing blanks in *expression* as significant. Padding will only occur if the actual length of *expression* is less than *length*, and *pad* is not an empty string.

expression

An expression that specifies the string from which the result is derived.

Expression must be a built-in string, numeric, or datetime data type. A numeric or datetime argument is cast to VARCHAR with a CCSID that is the default SBCS CCSID at the current server before evaluating the function. For more information about converting numeric or datetime to a varying character string, see [“VARCHAR” on page 616](#).

length

An expression that specifies the length of the result. The expression must return a value that is a built-in numeric, character-string, or graphic-string data type. If the data type of the expression is not INTEGER, it is implicitly cast to INTEGER before evaluating the function. The value must be zero or a positive integer that is less than or equal to *n*, where *n* is the maximum length of the result data type. See [Appendix A, “SQL limits,” on page 1635](#) for more information.

If *expression* is a graphic string, *length* indicates the number of DBCS or Unicode graphic characters. If *expression* is a character string, *length* indicates the number of characters where a character may consist of one or more bytes. If *expression* is a binary string, *length* indicates the number of bytes.

pad

An expression that specifies the string with which to pad. The expression must return a value that is a built-in string, numeric, or datetime data type. If the value is a numeric or datetime data type, it is implicitly cast to VARCHAR with a CCSID that is the default SBCS CCSID at the current server before evaluating the function.

If *pad* is not specified, the pad character is set as follows:

- For character and graphic strings, a single-byte, double-byte, UTF-16, or UTF-8 blank character based on the data type and CCSID of *expression*.⁶²
- For binary strings, hexadecimal zeros.

The value for *expression* and the value for *pad* must have compatible data types. If the CCSID of *pad* is different than the CCSID of *expression*, the *pad* value is converted to the CCSID of *expression*. For more information about data type compatibility, see [“Assignments and comparisons” on page 91](#).

The data type of the result depends on the data type of *expression*:

Data type of <i>expression</i>	Data Type of the Result for LPAD
CHAR or VARCHAR or numeric or datetime	VARCHAR
CLOB	CLOB
GRAPHIC or VARGRAPHIC	VARGRAPHIC
DBCLOB	DBCLOB
BINARY or VARBINARY	VARBINARY

⁶² UTF-16 or UCS-2 defines a blank character at code point X'0020' and X'3000'. The database manager pads with the blank at code point X'0020'. The database manager pads UTF-8 with a blank at code point X'20'

Data type of <i>expression</i>	Data Type of the Result for LPAD
BLOB	BLOB

The length attribute of the result depends on *length*. If *length* is explicitly specified by an integer constant that is greater than zero, the length attribute of the result is *length*. If *length* is explicitly specified by an integer constant that is zero, the length attribute of the result is 1. If *length* is specified as an expression, the length attribute of the result is the minimum of $m+100$ and the maximum length of the result data type, where m is the length attribute of *expression*. See [Appendix A, “SQL limits,”](#) on page 1635 for more information.

The actual length of the result is determined from *length*.

- If *length* is 0, the actual length is 0 and the result is the empty result string.
- If *length* is equal to the actual length of *expression*, the actual length is the length of *expression*.
- If *length* is less than the actual length of *expression*, the result is truncated. The actual length is *length* unless the result data type is varying-length mixed data or varying-length Unicode. In this case, only complete characters will be truncated.
 - For Unicode data, the actual length may be $length-1$ to prevent a double-byte character from being split.
 - For mixed data the actual length may be as little as $length-3$ to account for truncation of a double byte character and possibly a “shift-in” character (X'0F') and a “shift-out” character (X'0E').
- If *length* is greater than the actual length of *expression*, the actual length is *length* unless the result data type is varying-length mixed data or varying-length Unicode and *pad* contains double-byte characters. In this case, only complete characters will be padded.
 - For Unicode data, the actual length may be $length-1$ to prevent a double-byte character from being split.
 - For mixed data, the actual length may be may be as little as $length-3$ to account for truncation of a double byte character and possibly a “shift-in” character (X'0F') and a “shift-out” character (X'0E'). Also, this result will not have redundant shift codes “at the seam”. Thus, if the pad is a string ending with a “shift-in” character (X'0F'), and expression begins with a “shift-out” character (X'0E'), these two bytes are eliminated from the result.

If any argument can be null, the result can be null; if any argument is null, the result is the null value.

The CCSID of the result is the same as that of *expression*.

Examples

- *Example 1:* Assume that NAME is a VARCHAR(15) column that contains the values "Chris", "Meg", and "Jeff". The following query will completely pad out a value on the left with periods:

```
SELECT LPAD(NAME,15,'.' ) AS NAME FROM T1;
```

returns:

```
NAME
-----
.....Chris
.....Meg
.....Jeff
```

- *Example 2:* Assume that NAME is a VARCHAR(15) column that contains the values "Chris", "Meg", and "Jeff". The following query will only pad each value to a length of 5:

```
SELECT LPAD(NAME,5,'.' ) AS NAME FROM T1;
```

returns:

```
NAME
-----
Chris
.Meg
.Jeff
```

- *Example 3:* Assume that NAME is a CHAR(15) column containing the values "Chris", "Meg", and "Jeff". The LPAD function does not pad because NAME is a fixed length character field and is blank padded already. However, since the length of the result is 5, the columns are truncated:

```
SELECT LPAD(NAME,5,'.' ) AS NAME FROM T1;
```

returns:

```
NAME
-----
Chris
Meg
Jeff
```

- *Example 4:* Assume that NAME is a VARCHAR(15) column containing the values "Chris", "Meg", and "Jeff". In some cases, a partial instance of the pad specification is returned:

```
SELECT LPAD(NAME,15,'123' ) AS NAME FROM T1;
```

returns:

```
NAME
-----
1231231231Chris
123123123123Meg
12312312312Jeff
```

- *Example 5:* Assume that NAME is a VARCHAR(15) column containing the values "Chris", "Meg", and "Jeff". Note that "Chris" is truncated, "Meg" is padded, and "Jeff" is unchanged:

```
SELECT LPAD(NAME,4,'.' ) AS NAME FROM T1;
```

returns:

```
NAME
-----
Chri
.Meg
Jeff
```

LTRIM

The LTRIM function removes any of the specified characters from the beginning of an expression.

►► LTRIM — (— *string-expression* — , — *trim-expression*) —►►

The LTRIM function removes all of the characters that are contained in *trim-expression* from the beginning of *string-expression*. The collating sequence does not affect the search. If the *string-expression* is defined as FOR BIT DATA or is a binary data type, the search is done by comparing each byte in *trim-expression* to the byte at the beginning of *string-expression*.

string-expression

An expression that returns a value of any built-in numeric, datetime, or string data type. A numeric or datetime argument is cast to a character string before evaluating the function.⁶³ For more information about converting numeric or datetime to a character string, see “VARCHAR” on page 616.

trim-expression

An expression that specifies the characters to remove from the beginning of *string-expression*. The expression must return a value of any built-in numeric, datetime, or string data type. A numeric or datetime argument is cast to a character string before evaluating the function.

When *trim-expression* is not specified, the data type of the *string-expression* determines the default value used:

- Hexadecimal zero (X'00') if the argument is a binary string.
- DBCS blank if the argument is a DBCS graphic string.
- UTF-16 or UCS-2 blank if the first argument is a Unicode graphic string.
- UTF-8 blank if the first argument is a UTF-8 character string.
- Otherwise, a SBCS blank.

The value for *string-expression* and the value for *trim-expression* must have compatible data types. For more information about data type compatibility, see “Assignments and comparisons” on page 91. If *string-expression* and *trim-expression* have different CCSIDs, *trim-expression* is converted to the CCSID of *string-expression*.

The data type of the result depends on the data type of *string-expression*:

Data type of <i>string-expression</i>	Data type of the Result
CHAR or VARCHAR	VARCHAR
CLOB	CLOB
GRAPHIC or VARGRAPHIC	VARGRAPHIC
DBCLOB	DBCLOB
BINARY or VARBINARY	VARBINARY
BLOB	BLOB

The length attribute of the result is the same as the length attribute of *string-expression*. The actual length of the result for character or binary strings is the length of *string-expression* minus the number of bytes removed. The actual length of the result for graphic strings is the length of *string-expression* minus the number of graphic characters removed. If all characters are removed, the result is an empty string.

If either argument can be null, the result can be null; if any argument is null, the result is the null value.

The CCSID of the result is the same as that of *string-expression*.

⁶³ The LTRIM function with one argument returns the same results as: STRIP(*string-expression*,LEADING)

Examples

- *Example 1:* Use the LTRIM function when the host variable HELLO is defined as CHAR(9) and has a value of

```
' Hello'
```

```
VALUES LTRIM(:HELLO)
```

The result is 'Hello'. When a *trim-expression* is not specified only blanks are removed.

- *Example 2:* Use the LTRIM function to remove individual numbers in the *trim-expression* from the beginning (left side) of the *string-expression*.

```
SELECT LTRIM ('123DEFG123', '321'),
       LTRIM ('12DEFG123', '321'),
       LTRIM ('123123222XYZ22', '123'),
       LTRIM ('12321', '213'),
       LTRIM ('XYX123', '321')
FROM SYSIBM.SYSDUMMY1
```

The result is:

```
'DEFG123'
'DEFG123'
'XYZ22'
'' (an empty string - all characters removed)
'XYX123' (no characters removed)
```

The LTRIM function does not remove instances of '1', '2', and '3' on the right side of the string, following characters that are not '1', '2', or '3'.

- *Example 3:* Use the LTRIM function to remove the characters specified in the *trim-expression* from the beginning of the *string-expression*.

```
VALUES LTRIM('...$V..$AR', '$.')
```

The result is 'V..\$AR'. The function stops when it encounters a character not in the *trim-expression*.

- *Example 4:* Use the LTRIM function to remove the characters specified in the *trim-expression* from the beginning of the *string-expression*.

```
VALUES LTRIM('[[ -78]]', '- []')
```

The result is '78]]'. When removing characters and blanks, you must include a blank in the *trim-expression*.

MAX

The MAX scalar function returns the maximum value in a set of values.

►► MAX (— *expression* — , — *expression* —) ◄◄

The arguments must be compatible. Character-string arguments are compatible with datetime values. The arguments cannot be DataLink or XML values.

expression

An expression that returns the value of any built-in numeric or string data type. If one of the arguments is numeric, then character and graphic string arguments are cast to numeric before evaluating the function.

The result of the function is the largest argument value. The result can be null if at least one argument can be null; the result is the null value if one of the arguments is null.

The selected argument is converted, if necessary, to the attributes of the result. The attributes of the result are determined by all the operands as explained in [“Rules for result data types” on page 107](#).

If a collating sequence other than *HEX is in effect when the statement is executed and the arguments are SBCS data, mixed data, or Unicode data, the weighted values of the strings are compared instead of the actual values. The weighted values are based on the collating sequence.

Note

Syntax alternatives: GREATEST can be specified as a synonym for MAX.

Examples

- Assume the host variable M1 is a DECIMAL(2,1) host variable with a value of 5.5, host variable M2 is a DECIMAL(3,1) host variable with a value of 4.5, and host variable M3 is a DECIMAL(3,2) host variable with a value of 6.25.

```
SELECT MAX(:M1, :M2, :M3)
FROM SYSIBM.SYSDUMMY1
```

Returns the value 6.25.

- Assume the host variable M1 is a CHARACTER(2) host variable with a value of 'AA', host variable M2 is a CHARACTER(3) host variable with a value of 'AA ', and host variable M3 is a CHARACTER(4) host variable with a value of 'AA A'.

```
SELECT MAX(:M1, :M2, :M3)
FROM SYSIBM.SYSDUMMY1
```

Returns the value 'AA A'.

MAX_CARDINALITY

The MAX_CARDINALITY function returns a value representing the maximum number of elements an array can contain. This is the cardinality specified on the CREATE TYPE (Array) statement for the user-defined array type.

►► MAX_CARDINALITY (— *array-expression* —)►◄

array-expression

The expression can be either an SQL variable or parameter of an array data type, or a cast specification of a parameter marker to an array data type.

The result of the function is BIGINT. The result cannot be null.

Note

Syntax alternatives: ARRAY_MAX_CARDINALITY can be specified as a synonym for MAX_CARDINALITY.

Example

Assume that array type PHONENUMBERS and array variable RECENT_CALLS are defined as follows:

```
CREATE TYPE PHONENUMBERS AS INTEGER ARRAY[50];  
DECLARE RECENT_CALLS PHONENUMBERS;
```

The following statement sets LIST_SIZE to the maximum cardinality with which RECENT_CALLS was defined.

```
SET LIST_SIZE = MAX_CARDINALITY(RECENT_CALLS)
```

After the statement executes, LIST_SIZE contains 50.

MICROSECOND

The MICROSECOND function returns the microsecond part of a value.

►► MICROSECOND — (— *expression* —) ►►

expression

An *expression* that returns a value of one of the following built-in data types: a date, a time, a timestamp, a character string, a graphic string, or a numeric data type.

- If *expression* is a character or graphic string, its value must be a valid string representation of a datetime value. If *expression* is a valid string representation of a date, it must be in one of the IBM SQL standard formats. For the valid formats of string representations of dates and timestamps, see [“String representations of datetime values”](#) on page 75.
- If the argument is a DATE, it is first converted to a TIMESTAMP(0) value, assuming a time of exactly midnight (00.00.00).
- If *expression* is a number, it must be a timestamp duration. For the valid formats of datetime durations, see [“Datetime operands and durations”](#) on page 166.

The result of the function is a large integer. If the argument can be null, the result can be null; if the argument is null, the result is the null value.

The other rules depend on the data type of the argument:

- If the argument is date, time, or timestamp or a valid character-string representation of a date, time, or timestamp:

The result is an integer that ranges from 0 to 999999.

If the precision of the timestamp exceeds 6, the value is truncated.

- If the argument is a duration:

The result is the microsecond part of the value, which is an integer between -999999 and 999999. A nonzero result has the same sign as the argument.

Example

- Assume a table TABLEA contains two columns, TS1 and TS2, of type TIMESTAMP. Select all rows in which the microseconds portion of TS1 is not zero and the seconds portion of TS1 and TS2 are identical.

```
SELECT *  
FROM TABLEA  
WHERE MICROSECOND(TS1) <> 0 AND SECOND(TS1) = SECOND(TS2)
```

MIDNIGHT_SECONDS

The MIDNIGHT_SECONDS function returns an integer value that is greater than or equal to 0 and less than or equal to 86 400 representing the number of seconds between midnight and the time value specified in the argument.

►► MIDNIGHT_SECONDS — (— *expression* —) ►►

expression

An expression that returns a value of one of the following built-in data types: a date, a time, a timestamp, a character string, or a graphic string. Its value must be a valid string representation of a time or timestamp. For the valid formats of string representations of times and timestamps, see [“String representations of datetime values”](#) on page 75.

If the argument is a DATE, it is first converted to a TIMESTAMP(0) value, assuming a time of exactly midnight (00.00.00).

The result of the function is large integer. If the argument can be null, the result can be null; if the argument is null, the result is the null value.

Examples

- Find the number of seconds between midnight and 00:01:00, and midnight and 13:10:10. Assume that host variable XTIME1 has a value of '00:01:00', and that XTIME2 has a value of '13:10:10'.

```
SELECT MIDNIGHT_SECONDS(:XTIME1), MIDNIGHT_SECONDS(:XTIME2)
FROM SYSIBM.SYSDUMMY1
```

This example returns 60 and 47410. Because there are 60 seconds in a minute and 3600 seconds in an hour, 00:01:00 is 60 seconds after midnight ((60 * 1) + 0), and 13:10:10 is 47410 seconds ((3600 * 13) + (60 * 10) + 10).

- Find the number of seconds between midnight and 24:00:00, and midnight and 00:00:00.

```
SELECT MIDNIGHT_SECONDS('24:00:00'), MIDNIGHT_SECONDS('00:00:00')
FROM SYSIBM.SYSDUMMY1
```

This example returns 86400 and 0. Although these two values represent the same point in time, different values are returned.

MIN

The MIN scalar function returns the minimum value in a set of values.

►► MIN (— *expression* — , — *expression* —) ◄◄

The arguments must be compatible. Character-string arguments are compatible with datetime values. The arguments cannot be DataLink or XML values.

expression

An expression that returns a value of any built-in numeric or string data type. If one of the arguments is numeric, then character and graphic string arguments are cast to numeric before evaluating the function.

The result of the function is the minimum argument value. The result can be null if at least one argument can be null; the result is the null value if one of the arguments is null.

The selected argument is converted, if necessary, to the attributes of the result. The attributes of the result are determined by all the operands as explained in [“Rules for result data types” on page 107](#).

If a collating sequence other than *HEX is in effect when the statement is executed and the arguments are SBCS data, mixed data, or Unicode data, the weighted values of the strings are compared instead of the actual values. The weighted values are based on the collating sequence.

Note

Syntax alternatives: LEAST can be specified as a synonym for MIN.

Examples

- Assume the host variable M1 is a DECIMAL(2,1) host variable with a value of 5.5, host variable M2 is a DECIMAL(3,1) host variable with a value of 4.5, and host variable M3 is a DECIMAL(3,2) host variable with a value of 6.25.

```
SELECT MIN (:M1, :M2, :M3)
FROM SYSIBM.SYSDUMMY1
```

Returns the value 4.50.

- Assume the host variable M1 is a CHARACTER(2) host variable with a value of 'AA', host variable M2 is a CHARACTER(3) host variable with a value of 'AAA', and host variable M3 is a CHARACTER(4) host variable with a value of 'AAAA'.

```
SELECT MIN (:M1, :M2, :M3)
FROM SYSIBM.SYSDUMMY1
```

Returns the value 'AA'.

MINUTE

The MINUTE function returns the minute part of a value.

►► MINUTE — (— *expression* —) ◄◄

expression

An expression that returns a value of one of the following built-in data types: a date, a time, a timestamp, a character string, a graphic string, or a numeric data type.

- If *expression* is a character or graphic string, its value must be a valid string representation of a datetime value. If *expression* is a valid string representation of a date, it must be in one of the IBM SQL standard formats. For the valid formats of string representations of datetime values, see [“String representations of datetime values”](#) on page 75.
- If the argument is a DATE, it is first converted to a TIMESTAMP(0) value, assuming a time of exactly midnight (00.00.00).
- If *expression* is a number, it must be a time duration or timestamp duration. For the valid formats of datetime durations, see [“Datetime operands and durations”](#) on page 166.

The result of the function is a large integer. If the argument can be null, the result can be null; if the argument is null, the result is the null value.

The other rules depend on the data type of the argument:

- If the argument is a date, time, or timestamp, or a valid character-string representation of a date, time, or timestamp:

The result is the minute part of the value, which is an integer between 0 and 59.

- If the argument is a time duration or timestamp duration:

The result is the minute part of the value, which is an integer between -99 and 99. A nonzero result has the same sign as the argument.

Example

- Using the CL_SCHED sample table, select all classes with a duration less than 50 minutes.

```
SELECT *
FROM CL_SCHED
WHERE HOUR(ENDING - STARTING) = 0 AND
      MINUTE(ENDING - STARTING) < 50
```

MOD

The MOD function divides the first argument by the second argument and returns the remainder.

►► MOD (— *expression-1* — , — *expression-2* —) ►►

The formula used to calculate the remainder is:

$$\text{MOD}(x,y) = x - (x/y) * y$$

where x/y is the truncated integer result of the division. The result is negative only if first argument is negative.

expression-1

An expression that returns a value of any built-in numeric, character-string, or graphic-string data type. A string argument is cast to double-precision floating point before evaluating the function. For more information about converting strings to double-precision floating point, see [“DOUBLE_PRECISION or DOUBLE” on page 391](#).

expression-2

An expression that returns a value of any built-in numeric, character-string, or graphic-string data type. A string argument is cast to double-precision floating point before evaluating the function. For more information about converting strings to double-precision floating point, see [“DOUBLE_PRECISION or DOUBLE” on page 391](#). *expression-2* cannot be zero unless either argument is decimal floating-point.

If an argument can be null, the result can be null; if an argument is null, the result is the null value.

The attributes of the result are determined as follows:

- If both arguments are large or small integers with zero scale, the data type of the result is large integer.
- If both arguments are integers with zero scale and at least one of the arguments is a big integer, the data type of the result is big integer.
- If one argument is an integer with zero scale and the other is decimal, the result is decimal with the same precision and scale as the decimal argument.
- If both arguments are decimal or integer with scale numbers, the result is decimal. The precision of the result is $\min(p-s, p'-s') + \max(s, s')$, and the scale of the result is $\max(s, s')$, where the symbols p and s denote the precision and scale of the first operand, and the symbols p' and s' denote the precision and scale of the second operand.
- If either argument is floating point and the other operand is not decimal floating-point, the data type of the result is double-precision floating point.

The operation is performed in floating point. If necessary, the operands are first converted to double precision floating-point numbers. For example, an operation that involves a floating-point number and either an integer or a decimal number is performed with a temporary copy of the integer or decimal number that has been converted to double precision floating-point. The result of a floating-point operation must be within the range of floating-point numbers.

- If either argument is decimal floating-point, the data type of the result is DECFLOAT(34). If the argument is a special decimal floating-point value, the general rules for arithmetic operations apply. See [“General arithmetic operation rules for DECFLOAT” on page 163](#) for more information.

If either argument is decimal floating-point and the second operand evaluates to 0, the result is NaN and the invalid operation warning (SQLSTATE 0168D) is issued.⁶⁴ MOD(1, -Infinity) returns the value 1.

⁶⁴ If *YES is specified for the SQL_DECFLOAT_WARNINGS query option, NaN is returned with a warning. Otherwise, a division by zero warning or error is returned.

Examples

- Assume the host variable M1 is an integer host variable with a value of 5, and host variable M2 is an integer host variable with a value of 2.

```
SELECT MOD(:M1, :M2)
FROM SYSIBM.SYSDUMMY1
```

Returns the value 1.

- Assume the host variable M1 is an integer host variable with a value of 5, and host variable M2 is a DECIMAL(3,2) host variable with a value of 2.20.

```
SELECT MOD(:M1, :M2)
FROM SYSIBM.SYSDUMMY1
```

Returns the value 0.60.

- Assume the host variable M1 is a DECIMAL(4,2) host variable with a value of 5.50, and host variable M2 is a DECIMAL(4,1) host variable with a value of 2.0.

```
SELECT MOD(:M1, :M2)
FROM SYSIBM.SYSDUMMY1
```

Returns the value 1.50.

MONTH

The MONTH function returns the month part of a value.

►► MONTH — (— *expression* —) ◄◄

expression

An *expression* that returns a value of one of the following built-in data types: a date, a timestamp, a character string, a graphic string, or a numeric data type.

- If *expression* is a character or graphic string, its value must be a valid string representation of a date or timestamp. For the valid formats of string representations of dates and timestamps, see [“String representations of datetime values”](#) on page 75.
- If *expression* is a number, it must be a date duration or timestamp duration. For the valid formats of datetime durations, see [“Datetime operands and durations”](#) on page 166.

The result of the function is a large integer. If the argument can be null, the result can be null; if the argument is null, the result is the null value.

The other rules depend on the data type of the argument:

- If the argument is a date, a timestamp, or a valid character-string representation of a date or timestamp:
The result is the month part of the value, which is an integer between 1 and 12.
- If the argument is a date duration or timestamp duration:
The result is the month part of the value, which is an integer between -99 and 99. A nonzero result has the same sign as the argument.

Example

- Select all rows from the EMPLOYEE table for people who were born (BIRTHDATE) in DECEMBER.

```
SELECT *  
FROM EMPLOYEE  
WHERE MONTH(BIRTHDATE) = 12
```

MONTHNAME

Returns a mixed case character string containing the name of the month (for example, January) for the month portion of the argument.

►► MONTHNAME — (— *expression* —) ◄◄

expression

An expression that returns a value of one of the following built-in data types: a date, a timestamp, a character string, or a graphic string.

If *expression* is a character or graphic string, its value must be a valid string representation of a date or timestamp. For the valid formats of string representations of dates and timestamps, see [“String representations of datetime values”](#) on page 75.

The result of the function is VARCHAR(100). If the argument can be null, the result can be null; if the argument is null, the result is the null value.

The CCSID of the result is the default CCSID of the current server.

Note

National language considerations: The name of the month that is returned is based on the language used for messages in the job. This name of the month is retrieved from message CPX3BC0 in message file QCPFMSG in library *LIBL.

Examples

- Assume that the language used is US English.

```
SELECT MONTHNAME( '2003-01-02' )  
FROM SYSIBM.SYSDUMMY1
```

Results in 'January'.

MONTHS_BETWEEN

The MONTHS_BETWEEN function returns an estimate of the number of months between *expression1* and *expression2*.

► MONTHS_BETWEEN (— *expression1* — , — *expression2* —) ►

expression1

An expression that returns a value of one of the following built-in data types: a date, a timestamp, a character-string, or a graphic-string.

If *expression1* is a character or graphic string, its value must be a valid string representation of a date or timestamp. For the valid formats of string representations of dates and timestamps, see [“String representations of datetime values”](#) on page 75

expression2

An expression that returns a value of one of the following built-in data types: a date, a timestamp, a character-string, or a graphic-string.

If *expression2* is a character or graphic string, its value must be a valid string representation of a date or timestamp. For the valid formats of string representations of dates and timestamps, see [“String representations of datetime values”](#) on page 75

If *expression1* represents a date that is later than *expression2*, then the result is positive. If *expression2* represents a date that is equal to or later than *expression1*, then the result is negative.

- If *expression1* and *expression2* represent dates or timestamps with the same day of the month or the last day of the month, or both arguments represent the last day of their respective months, the result is a the whole number difference based on the year and month values ignoring any time portions of timestamp arguments.
- Otherwise, the whole number part of the result is the difference based on the year and month values. The fractional part of the result is calculated from the remainder based on an assumption that every month has 31 days. If either argument represents a timestamp, the arguments are effectively processed as timestamps with precision 12, and the time portions of these values are also considered when determining the result.

The result of the function is a DECIMAL(31,15). If either argument can be null, the result can be null; if either argument is null, the result is the null value.

Examples

- Calculate the months between two dates:

```
SELECT MONTHS_BETWEEN('2005-01-17', '2005-02-17')
FROM SYSIBM.SYSDUMMY1
```

Returns the value -1.0000000000000000

```
SELECT MONTHS_BETWEEN('2005-02-20', '2005-01-17')
FROM SYSIBM.SYSDUMMY1
```

Returns the value 1.096774193548387

- The following table contains additional examples:

Table 55. Additional examples using MONTHS_BETWEEN

Value for argument e1	Value for argument e2	Value returned by MONTHS_BETWEEN (e1,e2)	Value returned by ROUND(MONTHS_BETWEEN(e1,e2)*31,2)	Comment
2005-02-02	2005-01-01	1.032258064516129	32.00	
2007-11-01-09.00.00 .00000	2007-12-07-14.30.12 .12345	-1.20094538659274 1	-37.23	
2007-12-13-09.40.30 .00000	2007-11-13-08.40.30 .00000	1.0000000000000000	31.00	See Note 1
2007-03-15	2007-02-20	0.838709677419354	26.00	See Note 2
2008-02-29	2008-02-28-12.00.00	0.016129032258064	0.50	
2008-03-29	2008-02-29	1.0000000000000000	31.00	
2008-03-30	2008-02-29	1.032258064516129	32.00	
2008-03-31	2008-02-29	1.0000000000000000	31.00	See Note 3

Note:

1. The time difference is ignored because the day of the month is the same for both values.
2. The result is not 23 because, even though February has 28 days, the assumption is that all months have 31 days.
3. The result is not 33 because both dates are the last day of their respective month, and so the result is only based on the year and month portions.

MQREAD

The MQREAD function returns a message from a specified MQSeries location (return value of VARCHAR) without removing the message from the queue.

►► MQREAD — (→

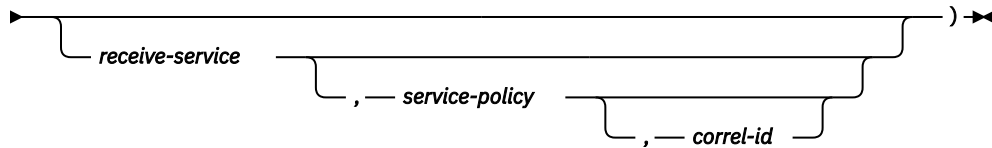

The MQREAD function returns a message from the MQSeries location that is specified by *receive-service*, using the quality-of-service policy that is defined in *service-policy*. Performing this operation does not remove the message from the queue that is associated with *receive-service*, but instead returns the message at the beginning of the queue.

receive-service

An expression that returns a value that is a built-in character string or graphic string data type that is not a LOB. The value of the expression must not be an empty string or a string with trailing blanks. The expression must have an actual length that is no greater than 48 bytes. The value of the expression must refer to a service point that is defined in the SYSIBM.MQSERVICE table. A service point is a logical end-point from where a message is sent or received. Service point definitions include the name of the MQSeries queue manager and queue. For more information about MQSeries Application Messaging, see [SQL Programming](#).

If *receive-service* is not specified or the null value, DB2.DEFAULT.SERVICE is used.

service-policy

An expression that returns a value that is a built-in character string or graphic string data type that is not a LOB. The value of the expression must not be an empty string or a string with trailing blanks. The expression must have an actual length that is no greater than 48 bytes. The value of the expression must refer to a service policy that is defined in the SYSIBM.MQPOLICY table. A service policy specifies a set of quality-of-service options that are to be applied to this messaging operation. These options include message priority and message persistence. For more information about MQSeries Application Messaging, see [SQL Programming](#).

If *service-policy* is not specified or the null value, DB2.DEFAULT.POLICY is used.

correl-id

An expression that returns a value that is a built-in character string or graphic string data type that is not a LOB. The expression must have an actual length that is no greater than 24 bytes. The value of the expression specifies the correlation identifier that is associated with this message. A correlation identifier is often specified in request-and-reply scenarios to associate requests with replies. The first message with a matching correlation identifier is returned. For more information about MQSeries Application Messaging, see [SQL Programming](#).

A fixed length string with trailing blanks is considered a valid value. However, when the *correl-id* is specified on another request such as MQSEND, the identical *correl-id* must be specified to be recognized as a match. For example, specifying a value of 'test' for *correl-id* on MQRECEIVE does not match a *correl-id* value of 'test ' (with trailing blanks) specified earlier on an MQSEND request.

If *correl-id* is not specified or is an empty string or the null value, a correlation identifier is not used, and the message at the beginning of the queue is returned.

The result of the function is a varying-length string with a length attribute of 32000. The result can be null. If no messages are available to be returned, the result is the null value.

The CCSID of the result is the default CCSID at the current server.

Notes

Prerequisites: In order to use the MQSeries functions, IBM MQSeries for IBM i must be installed, configured, and operational.

Example

- This example reads the message at the head of the queue specified by the default service (DB2.DEFAULT.SERVICE), using the default policy (DB2.DEFAULT.POLICY).

```
SELECT MQREAD ()  
FROM SYSIBM.SYSDUMMY1
```

- This example reads the message at the head of the queue specified by the service "MYSERVICE" using the default policy (DB2.DEFAULT.POLICY).

```
SELECT MQREAD ('MYSERVICE')  
FROM SYSIBM.SYSDUMMY1
```

- This example reads the message at the head of the queue specified by the service "MYSERVICE", and using the policy "MYPOLICY".

```
SELECT MQREAD ('MYSERVICE', 'MYPOLICY')  
FROM SYSIBM.SYSDUMMY1
```

- This example reads the first message with a correlation id that matches '1234' from the head of the queue specified by the service "MYSERVICE" using the policy "MYPOLICY".

```
SELECT MQREAD ('MYSERVICE', 'MYPOLICY', '1234')  
FROM SYSIBM.SYSDUMMY1
```

MQREADCLOB

The MQREADCLOB function returns a message from a specified MQSeries location (return value of CLOB) without removing the message from the queue.

►► MQREADCLOB — (→

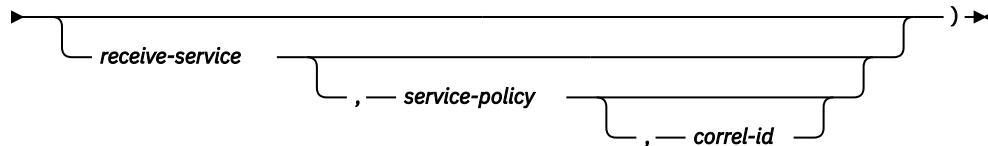

The MQREADCLOB function returns a message from the MQSeries location that is specified by *receive-service*, using the quality-of-service policy that is defined in *service-policy*. Performing this operation does not remove the message from the queue that is associated with *receive-service*, but instead returns the message at the beginning of the queue.

receive-service

An expression that returns a value that is a built-in character string or graphic string data type that is not a LOB. The value of the expression must not be an empty string or a string with trailing blanks. The expression must have an actual length that is no greater than 48 bytes. The value of the expression must refer to a service point that is defined in the SYSIBM.MQSERVICE table. A service point is a logical end-point from where a message is sent or received. Service point definitions include the name of the MQSeries queue manager and queue. For more information about MQSeries Application Messaging, see [SQL Programming](#).

If *receive-service* is not specified or the null value, DB2.DEFAULT.SERVICE is used.

service-policy

An expression that returns a value that is a built-in character string or graphic string data type that is not a LOB. The value of the expression must not be an empty string or a string with trailing blanks. The expression must have an actual length that is no greater than 48 bytes. The value of the expression must refer to a service policy that is defined in the SYSIBM.MQPOLICY table. A service policy specifies a set of quality-of-service options that are to be applied to this messaging operation. These options include message priority and message persistence. For more information about MQSeries Application Messaging, see [SQL Programming](#).

If *service-policy* is not specified or the null value, DB2.DEFAULT.POLICY is used.

correl-id

An expression that returns a value that is a built-in character string or graphic string data type that is not a LOB. The expression must have an actual length that is no greater than 24 bytes. The value of the expression specifies the correlation identifier that is associated with this message. A correlation identifier is often specified in request-and-reply scenarios to associate requests with replies. The first message with a matching correlation identifier is returned. For more information about MQSeries Application Messaging, see [SQL Programming](#).

A fixed length string with trailing blanks is considered a valid value. However, when the *correl-id* is specified on another request such as MQSEND, the identical *correl-id* must be specified to be recognized as a match. For example, specifying a value of 'test' for *correl-id* on MQRECEIVE does not match a *correl-id* value of 'test ' (with trailing blanks) specified earlier on an MQSEND request.

If *correl-id* is not specified or is an empty string or the null value, a correlation identifier is not used, and the message at the beginning of the queue is returned.

The result of the function is a CLOB with a length attribute of 2 MB. The result can be null. If no messages are available to be returned, the result is the null value.

The CCSID of the result is the default CCSID at the current server.

Notes

Prerequisites: In order to use the MQSeries functions, IBM MQSeries for IBM i must be installed, configured, and operational.

Example

- This example reads the message at the head of the queue specified by the default service (DB2.DEFAULT.SERVICE), using the default policy (DB2.DEFAULT.POLICY).

```
SELECT MQREADCLOB ()  
FROM SYSIBM.SYSDUMMY1
```

- This example reads the message at the head of the queue specified by the service "MYSERVICE" using the default policy (DB2.DEFAULT.POLICY).

```
SELECT MQREADCLOB ('MYSERVICE')  
FROM SYSIBM.SYSDUMMY1
```

- This example reads the message at the head of the queue specified by the service "MYSERVICE", and using the policy "MYPOLICY".

```
SELECT MQREADCLOB ('MYSERVICE', 'MYPOLICY')  
FROM SYSIBM.SYSDUMMY1
```

- This example reads the first message with a correlation id that matches '1234' from the head of the queue specified by the service "MYSERVICE" using the policy "MYPOLICY".

```
SELECT MQREADCLOB ('MYSERVICE', 'MYPOLICY', '1234')  
FROM SYSIBM.SYSDUMMY1
```

MQRECEIVE

The MQRECEIVE function returns a message from a specified MQSeries location (return value of VARCHAR) with removal of the message from the queue.

►► MQRECEIVE — (→

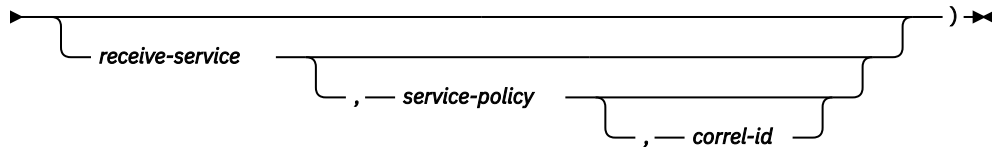

The MQRECEIVE function returns a message from the MQSeries location that is specified by *receive-service*, using the quality-of-service policy that is defined in *service-policy*. Performing this operation removes the message from the beginning of the queue that is associated with *receive-service*.

receive-service

An expression that returns a value that is a built-in character string or graphic string data type that is not a LOB. The value of the expression must not be an empty string or a string with trailing blanks. The expression must have an actual length that is no greater than 48 bytes. The value of the expression must refer to a service point that is defined in the SYSIBM.MQSERVICE table. A service point is a logical end-point from where a message is sent or received. Service point definitions include the name of the MQSeries queue manager and queue. For more information about MQSeries Application Messaging, see [SQL Programming](#).

If *receive-service* is not specified or the null value, DB2.DEFAULT.SERVICE is used.

service-policy

An expression that returns a value that is a built-in character string or graphic string data type that is not a LOB. The value of the expression must not be an empty string or a string with trailing blanks. The expression must have an actual length that is no greater than 48 bytes. The value of the expression must refer to a service policy that is defined in the SYSIBM.MQPOLICY table. A service policy specifies a set of quality-of-service options that are to be applied to this messaging operation. These options include message priority and message persistence. For more information about MQSeries Application Messaging, see [SQL Programming](#).

If *service-policy* is not specified or the null value, DB2.DEFAULT.POLICY is used.

correl-id

An expression that returns a value that is a built-in character string or graphic string data type that is not a LOB. The expression must have an actual length that is no greater than 24 bytes. The value of the expression specifies the correlation identifier that is associated with this message. A correlation identifier is often specified in request-and-reply scenarios to associate requests with replies. The first message with a matching correlation identifier is returned. For more information about MQSeries Application Messaging, see [SQL Programming](#).

A fixed length string with trailing blanks is considered a valid value. However, when the *correl-id* is specified on another request such as MQSEND, the identical *correl-id* must be specified to be recognized as a match. For example, specifying a value of 'test' for *correl-id* on MQRECEIVE does not match a *correl-id* value of 'test ' (with trailing blanks) specified earlier on an MQSEND request.

If *correl-id* is not specified or is an empty string or the null value, a correlation identifier is not used, and the message at the beginning of the queue is returned.

The result of the function is a varying-length string with a length attribute of 32000. The result can be null. If no messages are available to be returned, the result is the null value.

The CCSID of the result is the default CCSID at the current server.

Notes

Prerequisites: In order to use the MQSeries functions, IBM MQSeries for IBM i must be installed, configured, and operational.

Example

- This example receives the message at the head of the queue specified by the default service (DB2.DEFAULT.SERVICE), using the default policy (DB2.DEFAULT.POLICY).

```
SELECT MQRECEIVE ()  
FROM SYSIBM.SYSDUMMY1
```

- This example receives the message at the head of the queue specified by the service "MYSERVICE" using the default policy (DB2.DEFAULT.POLICY).

```
SELECT MQRECEIVE ('MYSERVICE')  
FROM SYSIBM.SYSDUMMY1
```

- This example receives the message at the head of the queue specified by the service "MYSERVICE" using the policy "MYPOLICY".

```
SELECT MQRECEIVE ('MYSERVICE', 'MYPOLICY')  
FROM SYSIBM.SYSDUMMY1
```

- This example receives the first message with a correlation id that matches '1234' from the head of the queue specified by the service "MYSERVICE" using the policy "MYPOLICY".

```
SELECT MQRECEIVE ('MYSERVICE', 'MYPOLICY', '1234')  
FROM SYSIBM.SYSDUMMY1
```

MQRECEIVECLOB

The MQRECEIVECLOB function returns a message from a specified MQSeries location (return value of CLOB) with removal of the message from the queue.

►► MQRECEIVECLOB — (→

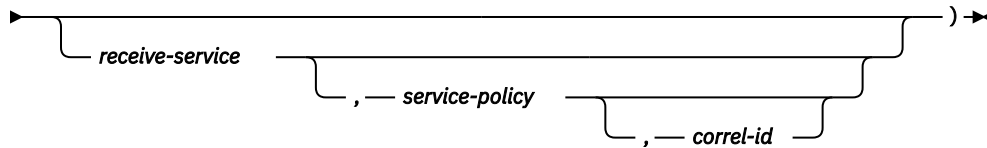

The MQRECEIVE function returns a message from the MQSeries location that is specified by *receive-service*, using the quality-of-service policy that is defined in *service-policy*. Performing this operation removes the message from the beginning of the queue that is associated with *receive-service*.

receive-service

An expression that returns a value that is a built-in character string or graphic string data type that is not a LOB. The value of the expression must not be an empty string or a string with trailing blanks. The expression must have an actual length that is no greater than 48 bytes. The value of the expression must refer to a service point that is defined in the SYSIBM.MQSERVICE table. A service point is a logical end-point from where a message is sent or received. Service point definitions include the name of the MQSeries queue manager and queue. For more information about MQSeries Application Messaging, see [SQL Programming](#).

If *receive-service* is not specified or the null value, DB2.DEFAULT.SERVICE is used.

service-policy

An expression that returns a value that is a built-in character string or graphic string data type that is not a LOB. The value of the expression must not be an empty string or a string with trailing blanks. The expression must have an actual length that is no greater than 48 bytes. The value of the expression must refer to a service policy that is defined in the SYSIBM.MQPOLICY table. A service policy specifies a set of quality-of-service options that are to be applied to this messaging operation. These options include message priority and message persistence. For more information about MQSeries Application Messaging, see [SQL Programming](#).

If *service-policy* is not specified or the null value, DB2.DEFAULT.POLICY is used.

correl-id

An expression that returns a value that is a built-in character string or graphic string data type that is not a LOB. The expression must have an actual length that is no greater than 24 bytes. The value of the expression specifies the correlation identifier that is associated with this message. A correlation identifier is often specified in request-and-reply scenarios to associate requests with replies. The first message with a matching correlation identifier is returned. For more information about MQSeries Application Messaging, see [SQL Programming](#).

A fixed length string with trailing blanks is considered a valid value. However, when the *correl-id* is specified on another request such as MQSEND, the identical *correl-id* must be specified to be recognized as a match. For example, specifying a value of 'test' for *correl-id* on MQRECEIVE does not match a *correl-id* value of 'test ' (with trailing blanks) specified earlier on an MQSEND request.

If *correl-id* is not specified or is an empty string or the null value, a correlation identifier is not used, and the message at the beginning of the queue is returned.

The result of the function is a CLOB with a length attribute of 2 MB. The result can be null. If no messages are available to be returned, the result is the null value.

The CCSID of the result is the default CCSID at the current server.

Notes

Prerequisites: In order to use the MQSeries functions, IBM MQSeries for IBM i must be installed, configured, and operational.

Example

- This example receives the message at the head of the queue specified by the default service (DB2.DEFAULT.SERVICE), using the default policy (DB2.DEFAULT.POLICY).

```
SELECT MQRECEIVECLOB ()  
FROM SYSIBM.SYSDUMMY1
```

- This example receives the message at the head of the queue specified by the service "MYSERVICE" using the default policy (DB2.DEFAULT.POLICY).

```
SELECT MQRECEIVECLOB ('MYSERVICE')  
FROM SYSIBM.SYSDUMMY1
```

- This example receives the message at the head of the queue specified by the service "MYSERVICE" using the policy "MYPOLICY".

```
SELECT MQRECEIVECLOB ('MYSERVICE', 'MYPOLICY')  
FROM SYSIBM.SYSDUMMY1
```

- This example receives the first message with a correlation id that matches '1234' from the head of the queue specified by the service "MYSERVICE" using the policy "MYPOLICY".

```
SELECT MQRECEIVECLOB ('MYSERVICE', 'MYPOLICY', '1234')  
FROM SYSIBM.SYSDUMMY1
```

MQSEND

The MQSEND function sends a message to a specified MQSeries location.

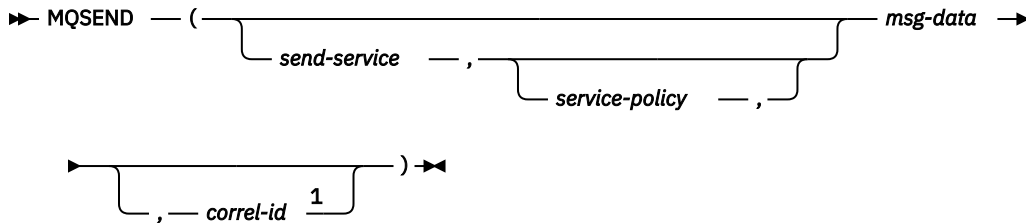

Notes:

¹ The *correl-id* cannot be specified unless a *send-service* and a *service-policy* are also specified.

The MQSEND function sends the message data that is contained in *msg-data* to the MQSeries location that is specified by *send-service*, using the quality-of-service policy that is defined in *service-policy*. The message is sent using the MQSeries built-in format MQFMT_STRING.

send-service

An expression that returns a value that is a built-in character string or graphic string data type that is not a LOB. The value of the expression must not be an empty string or a string with trailing blanks. The expression must have an actual length that is no greater than 48 bytes. The value of the expression must refer to a service point that is defined in the SYSIBM.MQSERVICE table. A service point is a logical end-point from where a message is sent or received. Service point definitions include the name of the MQSeries queue manager and queue. For more information about MQSeries Application Messaging, see [SQL Programming](#).

If *send-service* is not specified or the null value, DB2.DEFAULT.SERVICE is used.

service-policy

An expression that returns a value that is a built-in character string or graphic string data type that is not a LOB. The value of the expression must not be an empty string or a string with trailing blanks. The expression must have an actual length that is no greater than 48 bytes. The value of the expression must refer to a service policy that is defined in the SYSIBM.MQPOLICY table. A service policy specifies a set of quality-of-service options that are to be applied to this messaging operation. These options include message priority and message persistence. For more information about MQSeries Application Messaging, see [SQL Programming](#).

If *service-policy* is not specified or the null value, DB2.DEFAULT.POLICY is used.

msg-data

An expression that returns a value that is a built-in character string data type. If the expression is a CLOB, the value must not be longer than 2 MB. Otherwise, the value must not be longer than 32000 bytes. The value of the expression is the message data that is to be sent via MQSeries. A null value, an empty string, and a fixed length string with trailing blanks are all considered valid values.

correl-id

An expression that returns a value that is a built-in character string or graphic string data type that is not a LOB. The expression must have an actual length that is no greater than 24 bytes. The value of the expression specifies the correlation identifier that is associated with this message. A correlation identifier is often specified in request-and-reply scenarios to associate requests with replies. For more information about MQSeries Application Messaging, see [SQL Programming](#).

A fixed length string with trailing blanks is considered a valid value. However, when the *correl-id* is specified on another request such as MQRECEIVE, the identical *correl-id* must be specified to be recognized as a match. For example, specifying a value of 'test' for *correl-id* on MQSEND does not match a *correl-id* value of 'test ' (with trailing blanks) specified subsequently on an MQRECEIVE request.

If *correl-id* is not specified or is an empty string or the null value, a correlation identifier is not sent.

The result of the function is a varying-length string with a length attribute of 1. The result is nullable, even though a null value is never returned. The result is '1' if the function was successful or '0' if unsuccessful.

The CCSID of the result is the default SBCS CCSID at the current server.

Notes

Prerequisites: In order to use the MQSeries functions, IBM MQSeries for IBM i must be installed, configured, and operational.

Example

- This example sends the string "Testing 123" to the default service (DB2.DEFAULT.SERVICE), using the default policy (DB2.DEFAULT.POLICY), with no correlation identifier.

```
SELECT MQSEND ('Testing 123')
FROM SYSIBM.SYSDUMMY1
```

- This example sends the string "Testing 345" to the service "MYSERVICE", using the policy "MYPOLICY", with no correlation identifier.

```
SELECT MQSEND ('MYSERVICE', 'MYPOLICY', 'Testing 345')
FROM SYSIBM.SYSDUMMY1
```

- This example sends the string "Testing 678" to the service "MYSERVICE", using the policy "MYPOLICY", with correlation identifier "TEST3".

```
SELECT MQSEND ('MYSERVICE', 'MYPOLICY', 'Testing 678', 'TEST3')
FROM SYSIBM.SYSDUMMY1
```

- This example sends the string "Testing 901" to the service "MYSERVICE", using the default policy (DB2.DEFAULT.POLICY), and no correlation identifier.

```
SELECT MQSEND ('MYSERVICE', 'Testing 901')
FROM SYSIBM.SYSDUMMY1
```

MULTIPLY_ALT

The MULTIPLY_ALT scalar function returns the product of the two arguments as a decimal value. It is provided as an alternative to the multiplication operator, especially when the sum of the precisions of the arguments exceeds 63.

► MULTIPLY_ALT ((— *expression-1* — , — *expression-2* —)) ◄

expression-1

An expression that returns a value of any built-in numeric data type (other than floating-point or decimal floating-point), character-string, or graphic-string data type. A string argument is cast to double-precision floating point before evaluating the function. For more information about converting strings to double-precision floating point, see [“DOUBLE_PRECISION or DOUBLE” on page 391](#).

expression-2

An expression that returns a value of any built-in numeric data type (other than floating-point or decimal floating-point), character-string, or graphic-string data type. A string argument is cast to double-precision floating point before evaluating the function. For more information about converting strings to double-precision floating point, see [“DOUBLE_PRECISION or DOUBLE” on page 391](#). *expression-2* cannot be zero.

The result of the function is a DECIMAL. The precision and scale of the result are determined as follows, using the symbols *p* and *s* to denote the precision and scale of the first argument, and the symbols *p'* and *s'* to denote the precision and scale of the second argument.

- The precision is $\text{MIN}(mp, p+p')$
- The scale is:
 - 0 if the scale of both arguments is 0
 - $\text{MIN}(ms, s+s')$ if $p+p'$ is less than or equal to mp
 - $\text{MIN}(ms, \text{MAX}(\text{MIN}(3, s+s'), mp-(p-s+p'-s')))$ if $p+p'$ is greater than mp .

For information about the values of *p*, *s*, *ms*, and *mp*, see [“Decimal arithmetic in SQL” on page 161](#).

If either argument can be null, the result can be null; if either argument is null, the result is the null value.

The MULTIPLY_ALT function is a better choice than the multiplication operator when performing decimal arithmetic where a scale of at least 3 is wanted and the sum of the precisions exceeds 63. In these cases, the internal computation is performed so that overflows are avoided and then assigned to the result type value using truncation for any loss of scale in the final result. Note that the possibility of overflow of the final result is still possible when the scale is 3.

The following table compares the result types using MULTIPLY_ALT and the multiplication operator when the maximum precision is 31 and the maximum scale is 31:

Type of Argument 1	Type of Argument 2	Result using MULTIPLY_ALT	Result using multiplication operator
DECIMAL(31,3)	DECIMAL(15,8)	DECIMAL(31,3)	DECIMAL(31,11)
DECIMAL(26,23)	DECIMAL(10,1)	DECIMAL(31,19)	DECIMAL(31,24)
DECIMAL(18,17)	DECIMAL(20,19)	DECIMAL(31,29)	DECIMAL(31,31)
DECIMAL(16,3)	DECIMAL(17,8)	DECIMAL(31,9)	DECIMAL(31,11)
DECIMAL(26,5)	DECIMAL(11,0)	DECIMAL(31,3)	DECIMAL(31,5)
DECIMAL(21,1)	DECIMAL(15,1)	DECIMAL(31,2)	DECIMAL(31,2)

Examples

- Multiply two values where the data type of the first argument is DECIMAL(26,3) and the data type of the second argument is DECIMAL(9,8). The data type of the result is DECIMAL(31,7).

```
SELECT MULTIPLY_ALT(98765432109876543210987.654, 5.43210987)
FROM SYSIBM.SYSDUMMY1
```

Returns the value 536504678578875294857887.5277415.

Note that the complete product of these two numbers is 536504678578875294857887.52774154498, but the last 4 digits are truncated to match the scale of the result data type. Using the multiplication operator with the same values will cause an arithmetic overflow, since the result data type is DECIMAL(31,11) and the result value has 24 digits left of the decimal, but the result data type only supports 20 digits.

NEXT_DAY

The NEXT_DAY function returns a date or timestamp value that represents the first weekday, named by *string-expression*, that is later than the date *expression*.

►► NEXT_DAY (— *expression* — , — *string-expression* —) ◄◄

expression

An expression that returns a value of one of the following built-in data types: a date, a timestamp, a character string, or a graphic string.

If *expression* is a character or graphic string, its value must be a valid string representation of a date or timestamp. For the valid formats of string representations of dates and timestamps, see [“String representations of datetime values”](#) on page 75.

string-expression

An expression that returns a built-in character string data type or graphic string data type. The value must compare equal to the full name of a day of the week or compare equal to the abbreviation of a day of the week. For example, in the English language:

Day of Week	Abbreviation
MONDAY	MON
TUESDAY	TUE
WEDNESDAY	WED
THURSDAY	THU
FRIDAY	FRI
SATURDAY	SAT
SUNDAY	SUN

The minimum length of the input value is the length of the abbreviation. Leading and trailing blanks are trimmed from *string-expression*. The resulting value is then folded to uppercase, so the characters in the value may be in any case.

The result of the function has the same data type as *expression*, unless *expression* is a string in which case the result data type is TIMESTAMP(6). If either argument can be null, the result can be null; if either argument is null, the result is the null value.

Any hours, minutes, seconds, or fractional seconds information included in *expression* is not changed by the function. If *expression* is a string representing a date, the time information in the resulting TIMESTAMP value is all set to zero.

Note

National language considerations: The values of the days of the week (or abbreviations) in *string-expression* may either be the US English values listed in the table above or the values based on the language used for messages in the job. The non-abbreviated name of the day is retrieved from message CPX9034 in message file QCPFMMSG in library *LIBL. The abbreviated name of the day is retrieved from message CPX9039 in message file QCPFMMSG in library *LIBL.

Applications that need to run in many different language environments may want to consider using US English values since they will always be accepted in the NEXT_DAY function.

Example

- Assuming that the default language for the job is US English, set the host variable NEXTDAY with the date of the Tuesday following April 24, 2000.

```
SET :NEXTDAY = NEXT_DAY(CURRENT_DATE, 'TUESDAY')
```

The host variable NEXTDAY is set with the value of '2000-04-25-00.00.00.000000', assuming that the value of the CURRENT_DATE special register is '2000-04-24'.

- Assuming that the default language for the job is US English, set the host variable NEXTDAY with the date of the first Monday in May, 2000. Assume the host variable DAYHV = 'MON'.

```
SET :NEXTDAY = NEXT_DAY(LAST_DAY(CURRENT_TIMESTAMP), :DAYHV)
```

The host variable NEXTDAY is set with the value of '2000-05-01-12.01.01.123456', assuming that the value of the CURRENT_TIMESTAMP special register is '2000-04-24-12.01.01.123456'.

- Assuming that the default language for the job is US English,

```
SELECT NEXT_DAY('2000-04-24', 'TUESDAY')  
FROM SYSIBM.SYSDUMMY1
```

Returns '2000-04-25-00.00.00.000000', which is the Tuesday following '2000-04-24'.

NORMALIZE_DECFLOAT

The NORMALIZE_DECFLOAT function returns a DECFLOAT value equal to the input argument set to its simplest form.

►► NORMALIZE_DECFLOAT — (— *expression* —) ►►

The NORMALIZE_DECFLOAT function returns a decimal floating-point value equal to the input argument set to its simplest form; that is, a non-zero number with trailing zeros in the coefficient has those zeros removed. This may require representing the number in normalized form by dividing the coefficient by the appropriate power of ten and adjusting the exponent accordingly. A zero value has its exponent set to 0.

expression

An expression that returns a value of any built-in numeric, character-string, or graphic-string data type. If the data type of the argument is SMALLINT, INTEGER, REAL, DOUBLE, DECIMAL(p,s) where $p \leq 16$, or NUMERIC(p,s) where $p \leq 16$, then the argument is converted to DECFLOAT(16) for processing. Otherwise, the argument is converted to DECFLOAT(34) for processing.

If the argument is a special value then the general rules for arithmetic operations apply. See “[General arithmetic operation rules for DECFLOAT](#)” on [page 163](#) for more information.

The result of the function is a DECFLOAT(16) value if the data type of *expression* after conversion to decimal floating-point is DECFLOAT(16). Otherwise, the result of the function is a DECFLOAT(34) value. If the argument can be null, the result can be null; if the argument is null, the result is the null value.

Examples

The following examples show the result of using the NORMALIZE_DECFLOAT function on various DECFLOAT values:

```
NORMALIZE_DECFLOAT(DECFLOAT(2.1))      = 2.1
NORMALIZE_DECFLOAT(DECFLOAT(-2.0))     = -2
NORMALIZE_DECFLOAT(DECFLOAT(1.200))    = 1.2
NORMALIZE_DECFLOAT(DECFLOAT(-120))     = -1.2E+2
NORMALIZE_DECFLOAT(DECFLOAT(120.00))   = 1.2E+2
NORMALIZE_DECFLOAT(DECFLOAT(0.00))     = 0
NORMALIZE_DECFLOAT(-NAN)                = -NAN
NORMALIZE_DECFLOAT(-INFINITY)          = -INFINITY
```

NOW

The NOW function returns a timestamp based on a reading of the time-of-day clock when the SQL statement is executed at the current server.

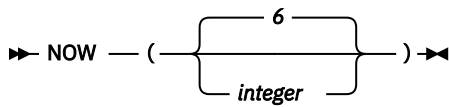

integer

Specifies the precision of the timestamp. Valid values are 0 to 12, inclusive. If a value is not specified, the default precision of 6 is used.

The value returned by the NOW function is the same as the value returned by the CURRENT_TIMESTAMP special register. If this function is used more than once within a single SQL statement, or used with the CURDATE or CURTIME scalar functions or the CURRENT_DATE, CURRENT_TIME, or CURRENT_TIMESTAMP special registers within a single statement, all values are based on a single clock reading.

The data type of the result is a timestamp with a precision specified by *integer*. The result cannot be null.

Note

Syntax alternatives: The CURRENT_TIMESTAMP special register should be used for maximal portability. For more information, see [“Special registers” on page 121](#).

Example

- Return the current timestamp based on the time-of-day clock.

```
SELECT NOW()  
FROM SYSIBM.SYSDUMMY1
```

NULLIF

The NULLIF function returns a null value if the arguments compare equal, otherwise it returns the value of the first argument.

►► NULLIF (— *expression-1* — , — *expression-2* —) ◄◄

The arguments must be compatible data types.

expression-1

An expression that returns a value of any built-in data type other than a DATALINK or XML or any distinct data type other than a distinct type that is based on a DATALINK or XML.

expression-2

An expression that returns a value of any built-in data type other than a DATALINK or XML or any distinct data type other than a distinct type that is based on a DATALINK or XML .

The attributes of the result are the attributes of the first argument. The result can be null. The result is null if the first argument is null or if both arguments are equal.

The result of using NULLIF(e1,e2) is the same as using the expression

```
CASE WHEN e1=e2 THEN NULL ELSE e1 END
```

Note that when e1=e2 evaluates to unknown (because one or both arguments is NULL), CASE expressions consider this not true. Therefore, in this situation, NULLIF returns the value of the first operand, e1.

Example

- Assume host variables PROFIT, CASH, and LOSSES have DECIMAL data types with the values 4500.00, 500.00, and 5000.00 respectively:

```
SELECT NULLIF (:PROFIT + :CASH, :LOSSES )  
FROM SYSIBM.SYSDUMMY1
```

Returns the null value.

NVL

The NVL function returns the value of the first non-null expression.

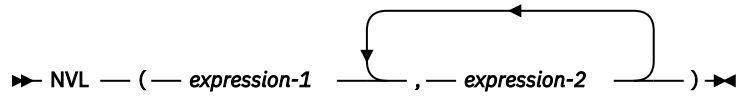

The NVL function is identical to the COALESCE function. For more information, see [“COALESCE” on page 337](#).

OCTET_LENGTH

The OCTET_LENGTH function returns the length of a string expression in octets (bytes).

► OCTET_LENGTH — (— *expression* —) ◄

See “LENGTH” on page 469 and “CHARACTER_LENGTH or CHAR_LENGTH” on page 330 for similar functions.

expression

An expression that returns a value of any built-in numeric or string data type. A numeric argument is cast to a character string before evaluating the function. For more information about converting numeric to a character string, see “VARCHAR” on page 616.

The result of the function is DECIMAL(31). If the argument can be null, the result can be null; if the argument is null, the result is the null value.

The result is the number of octets (bytes) in the argument. The length of a string includes trailing blanks. The length of a varying-length string is the actual length in octets (bytes), not the maximum length.

Example

- Assume table T1 has a GRAPHIC(10) column called C1.

```
SELECT OCTET_LENGTH( C1 )  
FROM T1
```

Returns the value 20.

OVERLAY

Returns a string where *length* characters have been deleted from *source-string* beginning at *start* and where *insert-string* has been inserted into *source-string* beginning at *start*.

►► OVERLAY ►►

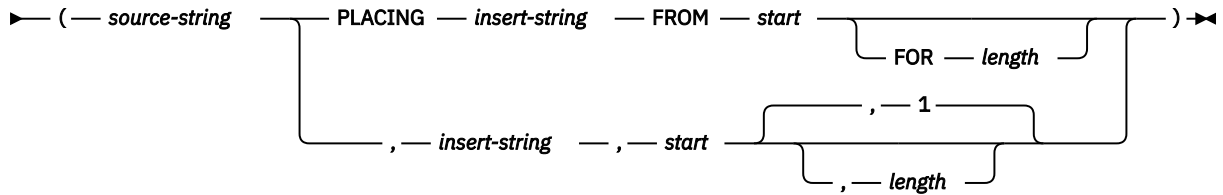

source-string

An expression that specifies the source string. The *source-string* may be any built-in numeric, string, or datetime expression. It must be compatible with the *insert-string*. For more information about data type compatibility, see [“Assignments and comparisons” on page 91](#). A numeric or datetime argument is cast to VARCHAR with a CCSID that is the default SBCS CCSID at the current server before evaluating the function. For more information about converting numeric or datetime to a varying character string, see [“VARCHAR” on page 616](#). The actual length of the string must be greater than zero.

The OVERLAY function is identical to the INSERT function except that the arguments are in a different order and *length* is optional.

insert-string

An expression that specifies the string to be inserted into *source-string*, starting at the position identified by *start*. The *insert-string* may be any built-in numeric, string, or datetime expression. It must be compatible with the *source-string*. For more information about data type compatibility, see [“Assignments and comparisons” on page 91](#). A numeric or datetime argument is cast to VARCHAR with a CCSID that is the default SBCS CCSID at the current server before evaluating the function. For more information about converting numeric or datetime to a varying character string, see [“VARCHAR” on page 616](#).

start

An expression that returns a value of any built-in numeric, character-string, or graphic-string data type. If value is not of type INTEGER, it is implicitly cast to INTEGER before evaluating the function. The integer specifies the starting character within *source-string* where the deletion of characters and the insertion of another string is to begin. The value of the integer must be in the range of 1 to the length of *source-string* plus one.

length

An expression that returns a value of any built-in numeric, character-string, or graphic-string data type. If value is not of type INTEGER, it is implicitly cast to INTEGER before evaluating the function. The integer specifies the number of characters that are to be deleted from *source-string*, starting at the character position identified by *start*. The value of the integer must be in the range of 0 to the length of *source-string*.

The data type of the result of the function depends on the data type of the first and second arguments. The result data type is the same as if the two arguments were concatenated except that the result is always a varying-length string. For more information see [“Conversion rules for operations that combine strings” on page 112](#).

The length attribute of the result depends on the arguments:

- If *start* and *length* are constants, the length attribute of the result is:

$$L1 - \text{MIN}((L1 - V2 + 1), V3) + L4$$

where:

```

L1 is the length attribute of source-string
V2 depends on the encoding schema of source-string:
- If the source-string is UTF-8, the value MIN(L1+1,start*3)
- If the source-string is mixed data, the value MIN(L1+1,(start-1)*2.5+4)
- Otherwise, the value of start
V3 is the value of length
L4 is the length attribute of insert-string

```

- Otherwise, the length attribute of the result is the length attribute of *source-string* plus the length attribute of *insert-string*.

If the length attribute of the result exceeds the maximum for the result data type, an error is returned.

The actual length of the result is:

```
A1 - MIN((A1 - V2 + 1), V3) + A4
```

where:

```

A1 is the actual length of source-string
V2 is the value of start
V3 is the value of length
A4 is the actual length of insert-string

```

If the actual length of the result string exceeds the maximum for the result data type, an error is returned.

If any argument can be null, the result can be null; if any argument is null, the result is the null value.

The CCSID of the result is determined by the CCSID of *source-string* and *insert-string*. The resulting CCSID is the same as if the two arguments were concatenated. For more information, see [“Conversion rules for operations that combine strings”](#) on page 112.

Examples

- The following example shows how the string 'INSERTING' can be changed into other strings. The use of the CHAR function limits the length of the resulting string to 10 characters.

```

SELECT OVERLAY('INSERTING', 'IS', 4, 2),
       OVERLAY('INSERTING', 'IS', 4, 0),
       OVERLAY('INSERTING', '', 4, 2)
FROM SYSIBM.SYSDUMMY1

```

This example returns 'INSISTING ', 'INSISERTING', and 'INSTING '.

- The previous example demonstrated how to insert text into the middle of some text. This example shows how to insert text before some text by using 1 as the starting point (*start*).

```

SELECT OVERLAY('INSERTING', 'XX', 1, 0),
       OVERLAY('INSERTING', 'XX', 1, 1),
       OVERLAY('INSERTING', 'XX', 1, 2),
       OVERLAY('INSERTING', 'XX', 1, 3)
FROM SYSIBM.SYSDUMMY1

```

This example returns 'XXINSERTING', 'XXNSERTING', 'XXSERTING ', and 'XXERTING '.

- The following example shows how to insert text after some text. Add 'XX' at the end of string 'ABCABC'. Because the source string is 6 characters long, set the starting position to 7 (one plus the length of the source string).

```

SELECT OVERLAY('ABCABC', 'XX', 7, 0)
FROM SYSIBM.SYSDUMMY1

```

This example returns 'ABCABCXX '.

- The following example changes the string 'Hegelstraße' to 'Hegelstrasse'.

```

SELECT OVERLAY('Hegelstraße', 'ss', 10, 1)
FROM SYSIBM.SYSDUMMY1

```

This example returns 'Hegelstrasse'.

- Assume the variable UTF8_VAR is defined as UTF8 and UTF16_VAR is defined as UTF16. Assume both contain Unicode string '&N~AB', where '&' is the musical symbol G clef character, and '~' is the combining tilde character.

```
SELECT OVERLAY(UTF8_VAR, 'C', 1),  
         OVERLAY(UTF8_VAR, 'C', 5),  
         OVERLAY(UTF16_VAR, 'C', 1),  
         OVERLAY(UTF16_VAR, 'C', 5)  
FROM SYSIBM.SYSDUMMY1
```

This example returns 'CN~AB', '&N~AC', 'CN~AB', and '&N~AC'.

PI

Returns the value of π 3.141592653589793. There are no arguments.

►► PI (—) ◄◄

The result of the function is double-precision floating-point. The result cannot be null.

Example

- The following returns the circumference of a circle with diameter 10:

```
SELECT PI()*10  
FROM SYSIBM.SYSDUMMY1
```

POSITION

The POSITION function returns the starting position of the first occurrence of one string (called the *search-string*) within another string (called the *source-string*). If the *search-string* is not found and neither argument is null, the result is zero. If the *search-string* is found, the result is a number from 1 to the actual length of the *source-string*.

► POSITION (— *search-string* — IN — *source-string* —) ►
POSITION (— *search-string* — , — *source-string* —)

See the related functions [“LOCATE” on page 473](#) and [“POSSTR” on page 522](#).

search-string

An expression that specifies the string that is to be searched for. *search-string* can be any built-in numeric, datetime, or string expression. It must be compatible with the *source-string*. A numeric or datetime argument is cast to a character string before evaluating the function. For more information about converting numeric and datetime to a character string, see [“VARCHAR” on page 616](#).

source-string

An expression that specifies the source string in which the search is to take place. *source-string* can be any built-in numeric, datetime, or string expression. A numeric or datetime argument is cast to a character string before evaluating the function. For more information about converting numeric and datetime to a character string, see [“VARCHAR” on page 616](#).

The result of the function is a large integer. If either of the arguments can be null, the result can be null. If either of the arguments is null, the result is the null value.

The POSITION function operates on a character basis. Because POSITION operates on a character-string basis, any shift-in and shift-out characters are not required to be in exactly the same position, and their only significance is to indicate which characters are SBCS and which characters are DBCS.

If the CCSID of the *search-string* is different from the CCSID of the *source-string*, it is converted to the CCSID of the *source-string*. If the CCSID of the *source-string* is mixed data or UTF-8, CCSID conversion to UTF-16 will occur.

If a collating sequence other than *HEX is in effect when the statement that contains the POSITION function is executed and the arguments are SBCS data, mixed data, or Unicode data, then the result is obtained by comparing weighted values for each value in the set. The weighted values are based on the collating sequence. An ICU collating sequence table cannot be specified with the POSITION function.

If the *search-string* has a length of zero, the result returned by the function is 1. Otherwise:

- If the *source-string* has a length of zero, the result returned by the function is 0.
- Otherwise,
 - If the value of *search-string* is equal to an identical length of substring of contiguous positions within the value of *source-string*, then the result returned by the function is the starting position of the first such substring within the *source-string* value.
 - Otherwise, the result returned by the function is 0.⁶⁵

Example

- Select RECEIVED and SUBJECT columns as well as the starting position of the words 'GOOD' within the NOTE_TEXT column for all entries in the IN_TRAY table that contain these words.

```
SELECT RECEIVED, SUBJECT, POSITION('GOOD', NOTE_TEXT)
FROM IN_TRAY
WHERE POSITION('GOOD', NOTE_TEXT) <> 0
```

⁶⁵ This includes the case where the *search-string* is longer than the *source-string*.

- Assume that NOTE is a VARCHAR(128) column, encoded in Unicode UTF-8, that contains the value 'Jürgen lives on Hegelstraße'. Find the character position of the character 'ß' in the string.

```
SELECT POSITION('ß', NOTE), POSSTR( NOTE, 'ß')  
FROM T1
```

Returns the value 26 for POSITION and 27 for POSSTR.

POSSTR

The POSSTR function returns the starting position of the first occurrence of one string (called the *search-string*) within another string (called the *source-string*). If the *search-string* is not found and neither argument is null, the result is zero. If the *search-string* is found, the result is a number from 1 to the actual length of the *source-string*.

►► POSSTR (— *source-string* — , — *search-string* —) ◄◄

See the related functions, [“LOCATE” on page 473](#) and [“POSITION” on page 520](#).

source-string

An expression that specifies the source string in which the search is to take place. *source-string* may be any built-in numeric, datetime, or string expression. A numeric or datetime argument is cast to a character string before evaluating the function. For more information about converting numeric and datetime to a character string, see [“VARCHAR” on page 616](#).

search-string

An expression that specifies the string that is to be searched for. *search-string* may be any built-in numeric, datetime, or string expression. It must be compatible with the *source-string*. A numeric or datetime argument is cast to a character string before evaluating the function. For more information about converting numeric and datetime to a character string, see [“VARCHAR” on page 616](#).

The result of the function is a large integer. If either of the arguments can be null, the result can be null. If either of the arguments is null, the result is the null value.

The POSSTR function accepts mixed data strings. However, POSSTR operates on a strict byte-count basis without regard to single-byte or double-byte characters.⁶⁶ It is recommended that if either the *search-string* or *source-string* contains mixed data, POSITION should be used instead of POSSTR. The POSITION function operates on a character basis. In an EBCDIC encoding scheme, any shift-in and shift-out characters are not required to be in exactly the same position, and their only significance is to indicate which characters are SBCS and which characters are DBCS.

If the CCSID of the *search-string* is different than the CCSID of the *source-string*, it is converted to the CCSID of the *source-string*. If the CCSID of the *source-string* is mixed data or UTF-8, CCSID conversion to UTF-16 will occur.

If a collating sequence other than *HEX is in effect when the statement that contains the POSSTR function is executed and the arguments are SBCS data, mixed data, or Unicode data, then the result is obtained by comparing weighted values for each value in the set. The weighted values are based on the collating sequence. An ICU collating sequence table cannot be specified with the POSSTR function.

If the *search-string* has a length of zero, the result returned by the function is 1. Otherwise:

- if the *source-string* has a length of zero, the result returned by the function is 0.
- Otherwise,
 - If the value of *search-string* is equal to an identical length of substring of contiguous positions within the value of *source-string*, then the result returned by the function is the starting position of the first such substring within the *source-string* value.
 - Otherwise, the result returned by the function is 0.⁶⁷

Note

Syntax alternatives: STRPOS is a synonym for POSSTR.

⁶⁶ For example, in an EBCDIC encoding scheme, if the *source-string* contains mixed data, the *search-string* will only be found if any shift-in and shift-out characters are also found in the *source-string* in exactly the same positions.

⁶⁷ This includes the case where the *search-string* is longer than the *source-string*.

Example

- Select RECEIVED and SUBJECT columns as well as the starting position of the words 'GOOD' within the NOTE_TEXT column for all entries in the IN_TRAY table that contain these words.

```
SELECT RECEIVED, SUBJECT, POSSTR(NOTE_TEXT, 'GOOD')  
FROM IN_TRAY  
WHERE POSSTR(NOTE_TEXT, 'GOOD') <> 0
```

POWER or POW

The POWER or POW function returns the result of raising the first argument to the power of the second argument.

POWER (*expression-1* , *expression-2*)
POW

expression-1

An expression that returns a value of any built-in numeric, character-string, or graphic-string data type.⁶⁸ A string argument is cast to double-precision floating point before evaluating the function. For more information about converting strings to double-precision floating point, see “DOUBLE_PRECISION or DOUBLE” on page 391.

expression-2

An expression that returns a value of any built-in numeric data type. If the value of *expression-1* is equal to zero, then *expression-2* must be greater than or equal to zero. If the value of *expression-1* is less than zero, then *expression-2* must be an integer value.

If the data type of the argument is decimal floating-point, the data type of the result is DECFLOAT(34). Otherwise, the result of the function is a double-precision floating-point number. If both arguments are 0, the result is 1. If an argument can be null, the result can be null; if an argument is null, the result is the null value.

Note

Results involving DECFLOAT special values: If either argument is decimal floating-point, both arguments are converted to DECFLOAT(34). For decimal floating-point values the special values are treated as follows:

- If either argument is NaN or -NaN, NaN is returned.⁶⁹
- POWER®(Infinity, any valid second argument) returns Infinity.
- POWER(-Infinity, any valid odd integer value) returns -Infinity.
- POWER(-Infinity, any valid even integer value) returns Infinity.
- POWER(0,Infinity) returns 0.
- POWER(1,Infinity) returns 1.
- POWER(any number greater than 1,Infinity) returns Infinity.
- POWER(any number greater than 0 and less than 1,Infinity) returns 0.
- POWER(any number less than 0,Infinity) returns NaN.⁶⁹
- If either argument is sNaN or -sNaN, a warning or error is returned.⁶⁹

Example

- Assume the host variable HPOWER is an integer with value 3.

```
SELECT POWER(2, :HPOWER)
FROM SYSIBM.SYSDUMMY1
```

Returns the value 8.

⁶⁸ The result of the POWER function is exactly the same as the result of exponentiation: *expression-1* ** *expression-2*.

⁶⁹ If *YES is specified for the SQL_DECFLOAT_WARNINGS query option, NaN is returned with a warning

QUANTIZE

The QUANTIZE function returns a decimal floating-point value that is equal in value (except for any rounding) and sign to *expression-1* and which has an exponent set equal to the exponent in *expression-2*.

►► QUANTIZE ((— *expression-1* — , — *expression-2* —)) ◄◄

expression-1

An expression that returns a value of any built-in numeric, character-string, or graphic-string data type. If the data type of the argument is not a DECFLOAT value, it is converted to DECFLOAT(34) for processing.

expression-2

An expression that returns a value of any built-in numeric, character-string, or graphic-string data type. If the data type of the argument is not a DECFLOAT value, it is converted to DECFLOAT(34) for processing.

If one argument (after conversion) is DECFLOAT(16) and the other is DECFLOAT(34), the DECFLOAT(16) argument is converted to DECFLOAT(34) before the function is processed.

The coefficient of the result is derived from that of *expression-1*. It is rounded if necessary (if the exponent is being increased), multiplied by a power of ten (if the exponent is being decreased), or remains unchanged (if the exponent is already equal to that of *expression-2*).

If necessary, the rounding mode is used by the QUANTIZE function. See [“CURRENT DECFLOAT ROUNDING MODE”](#) on page 126 for more information.

Unlike other arithmetic operations on the DECFLOAT data type, if the length of the coefficient after the quantize operation would be greater than the precision of the resulting DECFLOAT number, an error occurs. This guarantees that unless there is an error, the exponent of the result of a QUANTIZE function is always equal to that of *expression-2*.

The result of the function is a DECFLOAT(16) value if both arguments are DECFLOAT(16). Otherwise, the result of the function is a DECFLOAT(34) value. If either argument can be null, the result can be null; if either argument is null, the result is the null value

Note

Results involving DECFLOAT special values: Decimal floating-point special values are treated as follows:

- If either argument is NaN and the first argument is not -NaN, then NaN is returned.
- If either argument is sNaN, then a warning or error occurs.⁷⁰
- If either argument is -NaN and the first argument is not NaN, then -NaN is returned.
- If either argument is -sNaN, then a warning or error occurs.⁷⁰
- If both arguments are Infinity (positive or negative), then Infinity (positive or negative) is returned.
- If one argument is Infinity (positive or negative) and the other argument is not Infinity (positive or negative), then NaN is returned.⁷⁰

Examples

The following examples illustrate the value that is returned for the QUANTIZE function given the input DECFLOAT values:

```
QUANTIZE(2.17, 0.001)      ==> 2.170
QUANTIZE(2.17, 0.01)     ==> 2.17
QUANTIZE(2.17, 0.1)      ==> 2.2
QUANTIZE(2.17, 1e+0)     ==> 2
QUANTIZE(2.17, 1e+1)     ==> 0E+1
QUANTIZE(2, Infinity)    ==> NaN (exception)
```

⁷⁰ If *YES is specified for the SQL_DECFLOAT_WARNINGS query option, NaN is returned with a warning.

```
QUANTIZE(0, 1e+5)      ==> 0E+5
QUANTIZE(217, 1e-1)   ==> 217.0
QUANTIZE(217, 1e+0)   ==> 217
QUANTIZE(217, 1e+1)   ==> 2.2E+2
QUANTIZE(217, 1e+2)   ==> 2E+2
```

In the following example, the value -0 is returned for the QUANTIZE function. The CHAR function is used to avoid the potential removal of the minus sign by a client program.

```
CHAR(QUANTIZE(-0.1, 1)) ==> -0
```

QUARTER

The QUARTER function returns an integer between 1 and 4 that represents the quarter of the year in which the date resides. For example, any dates in January, February, or March will return the integer 1.

►► QUARTER — (— *expression* —) ►◄

expression

An expression that returns a value of one of the following built-in data types: a date, a timestamp, a character string, or a graphic string.

If *expression* is a character or graphic string, its value must be a valid string representation of a date or timestamp. For the valid formats of string representations of dates and timestamps, see [“String representations of datetime values”](#) on page 75.

The result of the function is a large integer. If the argument can be null, the result can be null; if the argument is null, the result is the null value.

Example

- Using the PROJECT table, set the host variable QUART (INTEGER) to the quarter in which project 'PL2100' ended (PRENDATE).

```
SELECT QUARTER(PRENDATE)
INTO :QUART
FROM PROJECT
WHERE PROJNO = 'PL2100'
```

Results in QUART being set to 3.

RADIANS

The RADIANS function returns the number of radians for an argument that is expressed in degrees.

►► RADIANS — (— *expression* —) ◄◄

expression

An expression that returns a value of any built-in numeric, character-string, or graphic-string data type. A string argument is cast to double-precision floating point before evaluating the function. For more information about converting strings to double-precision floating point, see [“DOUBLE_PRECISION or DOUBLE”](#) on page 391.

If the data type of the argument is DECFLOAT(*n*), the result is DECFLOAT(*n*). Otherwise, the data type of the result is double-precision floating point. If the argument can be null, the result can be null; if the argument is null, the result is the null value.

Example

- Assume that host variable HDEG is an INTEGER with a value of 180. The following statement:

```
SELECT RADIANS (:HDEG)
FROM SYSIBM.SYSDUMMY1
```

Returns a double precision floating-point number with an approximate value of 3.1415926536.

RAISE_ERROR

The RAISE_ERROR function causes the statement that invokes the function to return an error with the specified SQLSTATE (along with SQLCODE -438) and diagnostic string.

►► RAISE_ERROR (— *sqlstate* — , — *diagnostic-string* —) ►►

sqlstate

An expression that returns a value of a built-in CHAR or VARCHAR data type with exactly 5 characters. The *sqlstate* value must follow the rules for application-defined SQLSTATES:

- Each character must be from the set of digits ('0' through '9') or nonaccented uppercase letters ('A' through 'Z').
- The SQLSTATE class (first two characters) cannot be '00', '01', or '02' because these are not error classes.

If the SQLSTATE does not conform to these rules, an error is returned.

diagnostic-string

An expression that returns a value of a built-in CHAR or VARCHAR data type and a length up to 1000 bytes that describes the error condition. If the string is longer than 1000 bytes, it is truncated.

If an SQLCA is used, the following actions occur:

- The string is returned in the SQLERRMC field of the SQLCA.
- If the actual length of the string is longer than 70 bytes, it is truncated without a warning.

Since the data type of the result of RAISE_ERROR is undefined, it may only be used where parameter markers are allowed. To use this function in a context where parameter markers are not allowed (such as alone in a select list), you must use a cast specification to give a data type to the null value that is returned.

The RAISE_ERROR function always returns NULL with an undefined data type.

Example

- List employee numbers and education levels as Post Graduate, Graduate and Diploma. If an education level is greater than 20, raise an error.

```
SELECT EMPNO,  
       CASE WHEN EDLEVEL < 16 THEN 'Diploma'  
            WHEN EDLEVEL < 18 THEN 'Graduate'  
            WHEN EDLEVEL < 21 THEN 'Post Graduate'  
            ELSE RAISE_ERROR( '07001',  
                             'EDLEVEL has a value greater than 20' )  
       END  
FROM EMPLOYEE
```

RANDOM or RAND

The RANDOM or RAND function returns a floating point value greater than or equal to 0 and less than or equal to 1.

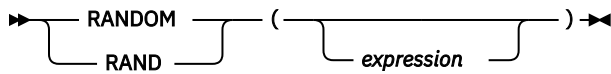

expression

If an expression is specified, it is used as the seed value. The argument must be an expression that returns a value of a built-in small integer, large integer, character-string, or graphic-string data type. A string argument is cast to integer before evaluating the function. For more information on converting strings to integer, see [“INTEGER or INT” on page 438](#).

The data type of the result is double-precision floating point. If the argument can be null, the result can be null; if the argument is null, the result is the null value.

A specific seed value will produce the same sequence of random numbers for a specific instance of a RAND function in a query each time the query is executed. If a seed value is not specified, a different sequence of random numbers is produced each time the query is executed.

The seed value is used only for the first invocation of an instance of the RAND function within a statement.

RAND is a non-deterministic function.

Example

- Assume that host variable HRAND is an INTEGER with a value of 100. The following statement:

```
SELECT RAND(:HRAND)
FROM SYSIBM.SYSDUMMY1
```

Returns a random floating-point number between 0 and 1, such as the approximate value .0121398.

- To generate values in a numeric interval other than 0 to 1, multiply the RAND function by the size of the wanted interval. For example, to get a random number between 0 and 10, such as the approximate value 5.8731398, multiply the function by 10:

```
SELECT RAND(:HRAND) * 10
FROM SYSIBM.SYSDUMMY1
```

REAL

The REAL function returns a single-precision floating-point representation.

Numeric to Real

►► REAL — (— *numeric-expression* —) ►◄

String to Real

►► REAL — (— *string-expression* —) ►◄

The REAL function returns a single-precision floating-point representation of:

- A number
- A character or graphic string representation of a decimal number
- A character or graphic string representation of an integer
- A character or graphic string representation of a floating-point number
- A character or graphic string representation of a decimal floating-point number

Numeric to Real

numeric-expression

The argument is an expression that returns a value of any built-in numeric data type.

The result is the same number that would occur if the argument were assigned to a single-precision floating-point column or variable. If the numeric value of the argument is not within the range of single-precision floating-point, an error is returned.

String to Real

string-expression

An expression that returns a value that is a character-string or graphic-string representation of a number.

If the argument is a *string-expression*, the result is the same number that would result from CAST(*string-expression* AS REAL). Leading and trailing blanks are eliminated and the resulting string must conform to the rules for forming a floating-point, decimal floating-point, integer, or decimal constant. If the numeric value of the argument is not within the range of single-precision floating-point, an error is returned.

The single-byte character constant that must be used to delimit the decimal digits in *string-expression* from the whole part of the number is the default decimal point. For more information, see [“Decimal point” on page 118](#).

The result of the function is a single-precision floating-point number. If the argument can be null, the result can be null; if the argument is null, the result is the null value.

Note

Syntax alternatives: The CAST specification should be used to increase the portability of applications. For more information, see [“CAST specification” on page 177](#).

Example

- Using the EMPLOYEE table, find the ratio of salary to commission for employees whose commission is not zero. The columns involved (SALARY and COMM) have DECIMAL data types. To eliminate the possibility of out-of-range results, REAL is applied to SALARY so that the division is carried out in floating point:

```
SELECT EMPNO, REAL(SALARY)/COMM  
FROM EMPLOYEE  
WHERE COMM > 0
```

REGEXP_COUNT

The REGEXP_COUNT function returns a count of the number of times that a regular expression pattern is matched in a string.

►► REGEXP_COUNT (— *source-string* — , — *pattern-expression* — , — *start* —) — *flags* —)

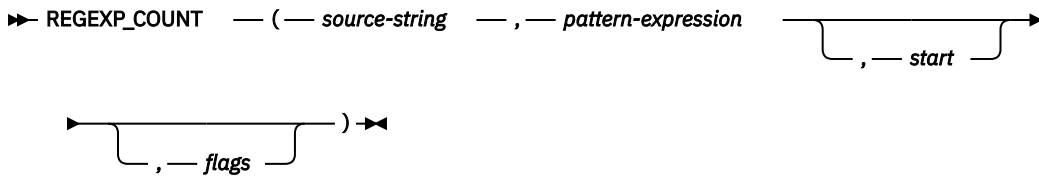

source-string

An expression that specifies the string in which the search is to take place. The expression must return a value that is a built-in character string, graphic string, numeric, or datetime data type. If the value is not a UTF-16 DBCLOB, it is implicitly cast to a UTF-16 DBCLOB before searching for the regular expression pattern. A character string with the FOR BIT DATA attribute or a binary string is not supported. The length of a string must not be greater than 1 gigabyte.

pattern-expression

An expression that specifies the regular expression string that is the pattern for the search. The expression must return a value that is a built-in character string, graphic string, numeric, or datetime data type. If the value is not a UTF-16 DBCLOB, it is implicitly cast to a UTF-16 DBCLOB before searching for the regular expression pattern. A character string with the FOR BIT DATA attribute or a binary string is not supported. The length of the string must not be greater than 32K.

A valid *pattern-expression* consists of a set of characters and control characters that describe the pattern of the search. For a description of the valid control characters, see [“Regular expression control characters”](#) on page 222.

start

An expression that specifies the position within *source-string* at which the search is to start. The expression must return a value of any built-in numeric, character-string, or graphic-string data type. The argument is cast to INTEGER before evaluating the function. For more information about converting to INTEGER, see [“INTEGER or INT”](#) on page 438. The value of the integer must be greater than or equal to 1. If the value of the integer is greater than the actual length of the *source-string*, the result is 0.

flags

An expression that specifies flags that control aspects of the pattern matching. The expression must return a value that is a built-in character string or graphic string data type. A character string with the FOR BIT DATA attribute or a binary string is not supported. The string can include one or more valid flag values and the combination of flag values must be valid. An empty string is the same as the value 'c'.

For a description of the valid flag characters, see [“Regular expression flag values”](#) on page 221.

The result of the function is an INTEGER representing the number of occurrences of the *pattern-expression* within the *source-string*. If the *pattern-expression* is not found and no argument is null, the result is 0.

If any argument of the REGEXP_COUNT function can be null, the result can be null. If any argument is null, the result is the null value.

Notes

Prerequisites: In order to use the REGEXP_COUNT function, the International Components for Unicode (ICU) option must be installed

Processing: The regular expression processing is done using the International Components for Unicode (ICU) regular expression interface. For more information see, <http://userguide.icu-project.org/strings/regexp>.

If only three arguments are specified, the third argument may be a *start* or *flags* argument. If the third argument is a string, it is interpreted as a *flags* argument. Otherwise, it is interpreted as a *start* argument.

Syntax Alternatives: REGEXP_MATCH_COUNT is a synonym for REGEXP_COUNT.

Example

- Count the number of times "Steven" or "Stephen" occurs in the string "Steven Jones and Stephen Smith are the best players".

```
SELECT REGEXP_COUNT(  
    'Steven Jones and Stephen Smith are the best players',  
    'Ste(v|ph)en')  
FROM sysibm.sysdummy1
```

The result is 2.

REGEXP_INSTR

The REGEXP_INSTR returns the starting position or the position after the end of the matched substring, depending on the value of the *return_option* argument.

► REGEXP_INSTR (— *source-string* — , — *pattern-expression* — ►

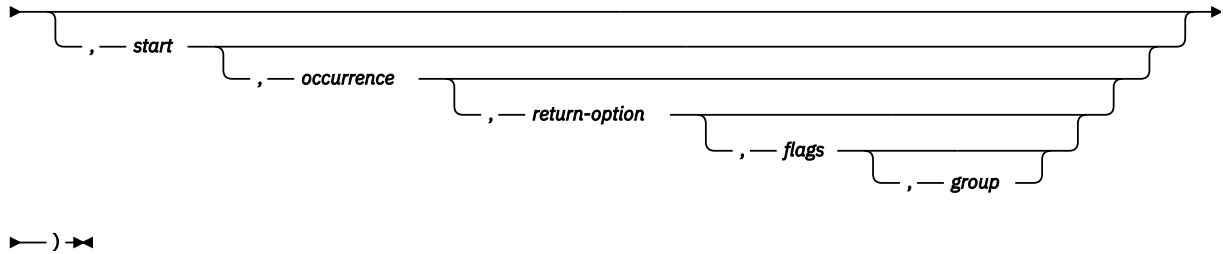

source-string

An expression that specifies the string in which the search is to take place. The expression must return a value that is a built-in character string, graphic string, numeric, or datetime data type. If the value is not a UTF-16 DBCLOB, it is implicitly cast to a UTF-16 DBCLOB before searching for the regular expression pattern. A character string with the FOR BIT DATA attribute or a binary string is not supported. The length of a string must not be greater than 1 gigabyte.

pattern-expression

An expression that specifies the regular expression string that is the pattern for the search. The expression must return a value that is a built-in character string, graphic string, numeric, or datetime data type. If the value is not a UTF-16 DBCLOB, it is implicitly cast to a UTF-16 DBCLOB before searching for the regular expression pattern. A character string with the FOR BIT DATA attribute or a binary string is not supported. The length of the string must not be greater than 32K.

A valid *pattern-expression* consists of a set of characters and control characters that describe the pattern of the search. For a description of the valid control characters, see [“Regular expression control characters”](#) on page 222.

start

An expression that specifies the position within *source-string* at which the search is to start. The expression must return a value of any built-in numeric, character-string, or graphic-string data type. The argument is cast to INTEGER before evaluating the function. For more information about converting to INTEGER, see [“INTEGER or INT”](#) on page 438. The value of the integer must be greater than or equal to 1. If the value of the integer is greater than the actual length of the *source-string*, the result is 0.

occurrence

An expression that specifies which occurrence of the *pattern-expression* within *source-string* to search for. The expression must return a value of any built-in numeric, character-string, or graphic-string data type. The argument is cast to INTEGER before evaluating the function. For more information about converting to INTEGER, see [“INTEGER or INT”](#) on page 438. The value of the integer must be greater than or equal to 1. If *occurrence* is not specified, the default value is 1 which indicates that only the first occurrence of *pattern-expression* is considered.

return-option

An expression that specifies whether to return the starting position or the position after the end of the string that matches the pattern. The expression must return a value of any built-in numeric, character-string, or graphic-string data type. The argument is cast to INTEGER before evaluating the function. For more information about converting to INTEGER, see [“INTEGER or INT”](#) on page 438. The value of the integer must be equal to 0 or 1. A value of 0 returns the starting position of the occurrence. A value of 1 returns the ending position of the occurrence. If *return-option* is not specified, the default value is 0.

flags

An expression that specifies flags that control aspects of the pattern matching. The expression must return a value that is a built-in character string or graphic string data type. A character string with the FOR BIT DATA attribute or a binary string is not supported. The string can include one or more valid flag values and the combination of flag values must be valid. An empty string is the same as the value 'c'.

For a description of the valid flag characters, see [“Regular expression flag values”](#) on page 221.

group

An expression that specifies which capture group of the *pattern-expression* is used to determine the position within *source-string* to return. The expression must return a value of any built-in numeric, character-string, or graphic-string data type. The argument is cast to INTEGER before evaluating the function. For more information about converting to INTEGER, see [“INTEGER or INT”](#) on page 438. The value of the integer must be greater than or equal to 0 and must not be greater than the number of capture groups in the *pattern-expression*. If *group* is not specified, the default is 0 which indicates the entire string that matches the entire pattern is returned.

The result of the function is a large integer. If the *pattern-expression* is found, the result is a number from 1 to *n*, where *n* is the actual length of the *source-string* plus 1. The result value represents the position used to process the function. If the *pattern-expression* is not found and no argument is null, the result is 0.

If any argument of the REGEXP_INSTR function can be null, the result can be null. If any argument is null, the result is the null value.

Notes

Prerequisites: In order to use the REGEXP_INSTR function, the International Components for Unicode (ICU) option must be installed

Processing: The regular expression processing is done using the International Components for Unicode (ICU) regular expression interface. For more information see, <http://userguide.icu-project.org/strings/regexp>.

Examples

- *Example 1:* Find the first occurrence of a 'o' which has a character preceding it.

```
SELECT REGEXP_INSTR('hello to you', '.o',1,1)
FROM sysibm.sysdummy1
```

The result is 4, which is the position of the second 'l' character.

- *Example 2:* Find the second occurrence of a 'o' which has a character preceding it.

```
SELECT REGEXP_INSTR('hello to you', '.o',1,2)
FROM sysibm.sysdummy1
```

The result is 7, which is the position of the character 't'.

- *Example 3:* Find the position after the third occurrence of the first capture group of the regular expression '(o)!' using case insensitive matching.

```
SELECT REGEXP_INSTR('hello to you', '(.o).', 1,3,1,'i',1)
FROM sysibm.sysdummy1
```

The result is 12, which is the position of the character 'u' at the end of the string.

REGEXP_REPLACE

The REGEXP_REPLACE function returns a modified version of the source string where occurrences of the regular expression pattern found in the source string are replaced with the specified replacement string.

►► REGEXP_REPLACE (— *source-string* — , — *pattern-expression* — ►

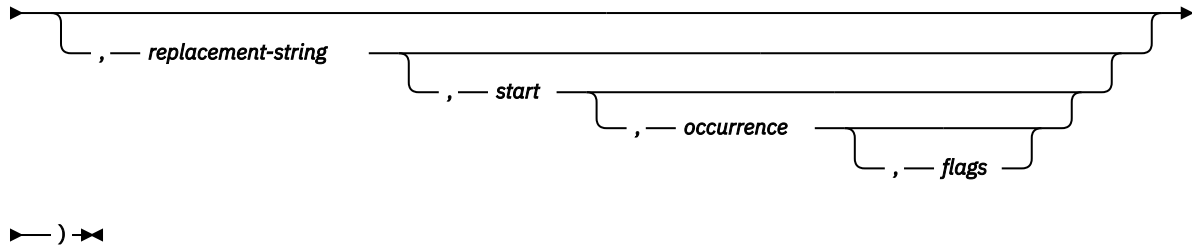

source-string

An expression that specifies the string in which the search is to take place. The expression must return a value that is a built-in character string, graphic string, numeric, or datetime data type. If the value is not a UTF-16 DBCLOB, it is implicitly cast to a UTF-16 DBCLOB before searching for the regular expression pattern. A character string with the FOR BIT DATA attribute or a binary string is not supported. The length of a string must not be greater than 1 gigabyte.

pattern-expression

An expression that specifies the regular expression string that is the pattern for the search. The expression must return a value that is a built-in character string, graphic string, numeric, or datetime data type. If the value is not a UTF-16 DBCLOB, it is implicitly cast to a UTF-16 DBCLOB before searching for the regular expression pattern. A character string with the FOR BIT DATA attribute or a binary string is not supported. The length of the string must not be greater than 32K.

A valid *pattern-expression* consists of a set of characters and control characters that describe the pattern of the search. For a description of the valid control characters, see [“Regular expression control characters”](#) on page 222.

replacement-string

An expression that specifies the replacement string for matching substrings. The expression must return a value that is a built-in character string, graphic string, numeric, or datetime data type. If the value is not a UTF-16 DBCLOB, it is implicitly cast to a UTF-16 DBCLOB before searching for the regular expression pattern. A character string with the FOR BIT DATA attribute or a binary string is not supported. The length of the string must not be greater than 32K. If *replacement-string* is not specified, the default is the empty string.

The content of the *replacement-string* can include references to capture group text from the search to use in the replacement text. These references are of the form '\$n' or '\n'33, where n is the number of the capture group and 0 represents the entire string that matches the pattern. The value for n must be in the range 0 to 9 and not greater than the number of capture groups in the pattern. For example, either '\$2' or '\2' can be used to refer to the content found in *source-string* for the second capture group specified in *pattern-expression*. If the *replacement-string* must include a literal reference to a '\$' or '\' character, then the '\' character must precede the literal reference so that it appears in the *replacement-string* as '\\$' or '\\'.

start

An expression that specifies the position within *source-string* at which the search is to start. The expression must return a value of any built-in numeric, character-string, or graphic-string data type. The argument is cast to INTEGER before evaluating the function. For more information about converting to INTEGER, see [“INTEGER or INT”](#) on page 438. The value of the integer must be greater than or equal to 1. If the value of the integer is greater than the actual length of the *source-string*, the original string is returned.

occurrence

An expression that specifies which occurrence of the *pattern-expression* within *source-string* to search for and replace. The expression must return a value of any built-in numeric, character-string, or graphic-string data type. The argument is cast to INTEGER before evaluating the function. For more information about converting to INTEGER, see [“INTEGER or INT” on page 438](#). The value of the integer must be greater than or equal to 0. If *occurrence* is not specified, the default value is 0 which indicates that all occurrences of *pattern-expression* in *source-string* are replaced.

flags

An expression that specifies flags that control aspects of the pattern matching. The expression must return a value that is a built-in character string or graphic string data type. A character string with the FOR BIT DATA attribute or a binary string is not supported. The string can include one or more valid flag values and the combination of flag values must be valid. An empty string is the same as the value 'c'.

For a description of the valid flag characters, see [“Regular expression flag values” on page 221](#).

The result of the function is a string. If there are no occurrences of the pattern to be replaced and no argument is null, the original string is returned. The data type of the string is the same as if the first and third arguments were concatenated except that the result is always a varying-length string. For more information, see [“With the concatenation operator” on page 164](#).

The length attribute of the result data type is determined based on the length attributes of the *source-string* and the *replacement-string* using the following calculation: $\text{MIN}(\text{MaxTypeLen}, \text{LAS} + (\text{LAS} + 1) * \text{LAR})$ where MaxTypeLen is the maximum length attribute for the data type of the result, LAS is the length attribute for the data type of *source-string*, and LAR is the length attribute for the data type of *replacement-string*. If *replacement-string* is not specified, the value for LAR is 0. If the actual length of the result string exceeds the maximum for the return data type, an error is returned.

The CCSID of the result is determined by the CCSID of the *source-string* and the *replacement-string*. The resulting CCSID is the same as if the first and third arguments were concatenated. For more information, see [“Rules for result data types” on page 107](#).

If any argument of the REGEXP_REPLACE function can be null, the result can be null. If any argument is null, the result is the null value.

Notes

Prerequisites: In order to use the REGEXP_REPLACE function, the International Components for Unicode (ICU) option must be installed

Processing: The regular expression processing is done using the International Components for Unicode (ICU) regular expression interface. For more information see, <http://userguide.icu-project.org/strings/regexp>.

Example

- Replace the second occurrence of the pattern 'R.d' with 'Orange' using a case sensitive search.

```
SELECT REGEXP_REPLACE(
  'Red Yellow RED Blue Red Green Blue',
  'R.d', 'Orange', 1, 2, 'c')
FROM sysibm.sysdummy1
```

The result is 'Red Yellow RED Blue Orange Green Blue'.

REGEXP_SUBSTR

The REGEXP_SUBSTR function returns one occurrence of a substring of a string that matches the regular expression pattern.

►► REGEXP_SUBSTR (— *source-string* — , — *pattern-expression* — ►►

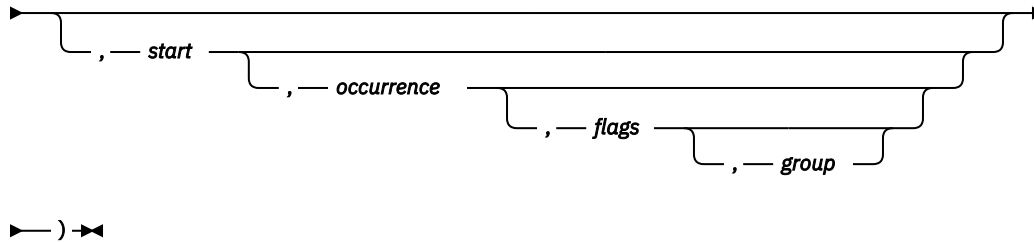

source-string

An expression that specifies the string in which the search is to take place. The expression must return a value that is a built-in character string, graphic string, numeric, or datetime data type. If the value is not a UTF-16 DBCLOB, it is implicitly cast to a UTF-16 DBCLOB before searching for the regular expression pattern. A character string with the FOR BIT DATA attribute or a binary string is not supported. The length of a string must not be greater than 1 gigabyte.

pattern-expression

An expression that specifies the regular expression string that is the pattern for the search. The expression must return a value that is a built-in character string, graphic string, numeric, or datetime data type. If the value is not a UTF-16 DBCLOB, it is implicitly cast to a UTF-16 DBCLOB before searching for the regular expression pattern. A character string with the FOR BIT DATA attribute or a binary string is not supported. The length of the string must not be greater than 32K.

A valid *pattern-expression* consists of a set of characters and control characters that describe the pattern of the search. For a description of the valid control characters, see [“Regular expression control characters”](#) on page 222.

start

An expression that specifies the position within *source-string* at which the search is to start. The expression must return a value of any built-in numeric, character-string, or graphic-string data type. The argument is cast to INTEGER before evaluating the function. For more information about converting to INTEGER, see [“INTEGER or INT”](#) on page 438. The value of the integer must be greater than or equal to 1. If the value of the integer is greater than the actual length of the *source-string*, the result is the null value.

occurrence

An expression that specifies which occurrence of the *pattern-expression* within *source-string* to search for. The expression must return a value of any built-in numeric, character-string, or graphic-string data type. The argument is cast to INTEGER before evaluating the function. For more information about converting to INTEGER, see [“INTEGER or INT”](#) on page 438. The value of the integer must be greater than or equal to 1. If *occurrence* is not specified, the default value is 1 which indicates that only the first occurrence of *pattern-expression* is considered.

flags

An expression that specifies flags that control aspects of the pattern matching. The expression must return a value that is a built-in character string or graphic string data type. A character string with the FOR BIT DATA attribute or a binary string is not supported. The string can include one or more valid flag values and the combination of flag values must be valid. An empty string is the same as the value 'c'.

For a description of the valid flag characters, see [“Regular expression flag values”](#) on page 221.

group

An expression that specifies which capture group of the *pattern-expression* within *source-string* to return. The expression must return a value of any built-in numeric, character-string, or graphic-string data type. The argument is cast to INTEGER before evaluating the function. For more information about converting to INTEGER, see “INTEGER or INT” on page 438. The value of the integer must be greater than or equal to 0 and must not be greater than the number of capture groups in the *pattern-expression*. If *group* is not specified, the default is 0 which indicates the entire string that matches the entire pattern is returned.

The result of the function is a string. The data type of the result depends on the data type of *source-string*:

Data type of <i>source-string</i>	Data Type of the Result for REGEXP_SUBSTR
CHAR or VARCHAR or numeric or datetime	VARCHAR
CLOB	CLOB
GRAPHIC or VARGRAPHIC	VARGRAPHIC
DBCLOB	DBCLOB

The length attribute of the result data type is same as the length attribute of the *source-string*. The actual length of the result is the length of the occurrence in the string that matches the *pattern-expression*. If the *pattern-expression* is not found, the result is the null value.

The CCSID of the result is the same as the *source-string*.

If any argument of the REGEXP_SUBSTR function can be null, the result can be null. If any argument is null, the result is the null value.

Notes

Prerequisites: In order to use the REGEXP_SUBSTR function, the International Components for Unicode (ICU) option must be installed

Processing: The regular expression processing is done using the International Components for Unicode (ICU) regular expression interface. For more information see, <http://userguide.icu-project.org/strings/regexp>.

Syntax Alternatives: REGEXP_EXTRACT is a synonym for REGEXP_SUBSTR.

Examples

- *Example 1:* Return the string which matches any character preceding a 'o'.

```
SELECT REGEXP_SUBSTR('hello to you', '.o',1,1)
FROM sysibm.sysdummy1
```

The result is 'lo'.

- *Example 2:* Return the second string occurrence which matches any character preceding a 'o'.

```
SELECT REGEXP_SUBSTR('hello to you', '.o',1,2)
FROM sysibm.sysdummy1
```

The result is 'to'.

- *Example 3:* Return the third string occurrence which matches any character preceding a 'o'.

```
SELECT REGEXP_SUBSTR('hello to you', '.o',1,3)
FROM sysibm.sysdummy1
```

The result is 'yo'.

REPEAT

The REPEAT function returns a string composed of *expression* repeated *integer* times.

►► REPEAT (— *expression* — , — *integer* —) ◄◄

expression

An expression that specifies the string to be repeated. The string must be a built-in numeric or string expression. A numeric argument is cast to a character string before evaluating the function. For more information on converting numeric to a character string, see [“VARCHAR” on page 616](#).

integer

An expression that returns a built-in BIGINT, INTEGER, or SMALLINT data type whose value is a positive integer or zero. The integer specifies the number of times to repeat the string.

The data type of the result of the function depends on the data type of the first argument:

Data type of <i>expression</i>	Data type of the Result
CHAR or VARCHAR or any numeric type	VARCHAR
CLOB	CLOB
GRAPHIC or VARGRAPHIC	VARGRAPHIC
DBCLOB	DBCLOB
BINARY or VARBINARY	VARBINARY
BLOB	BLOB

If *integer* is a constant, the length attribute of the result is the minimum of the length attribute of *expression* times *integer* and the maximum length of the result data type. Otherwise, the length attribute depends on the data type of the result:

- 1,048,576 for BLOB, CLOB, or DBCLOB
- 4000 for VARCHAR or VARBINARY
- 2000 for VARGRAPHIC

The actual length of the result is the actual length of *expression* times *integer*. If the actual length of the result string exceeds the maximum for the return type, an error is returned.

If either argument can be null, the result can be null; if either argument is null, the result is the null value.

The CCSID of the result is the CCSID of *expression*.⁷¹

Examples

- Repeat 'abc' two times to create 'abcabc'.

```
SELECT REPEAT('abc', 2)
FROM SYSIBM.SYSDUMMY1
```

- List the phrase 'REPEAT THIS' five times. Use the CHAR function to limit the output to 60 bytes.

```
SELECT CHAR( REPEAT('REPEAT THIS', 5), 60)
FROM SYSIBM.SYSDUMMY1
```

This example results in 'REPEAT THISREPEAT THISREPEAT THISREPEAT THISREPEAT THIS '.

⁷¹ If the value of *expression* is mixed data that is not a properly formed mixed data string, the result will not be a properly formed mixed data string.

- For the following query, the LENGTH function returns a value of 0 because the result of repeating a string zero times is an empty string, which is a zero-length string.

```
SELECT LENGTH( REPEAT('REPEAT THIS', 0) )  
FROM SYSIBM.SYSDUMMY1
```

- For the following query, the LENGTH function returns a value of 0 because the result of repeating an empty string any number of times is an empty string, which is a zero-length string.

```
SELECT LENGTH( REPEAT('', 5) )  
FROM SYSIBM.SYSDUMMY1
```

REPLACE

The REPLACE function replaces all occurrences of *search-string* in *source-string* with *replace-string*. If *search-string* is not found in *source-string*, *source-string* is returned unchanged.

➔ REPLACE (*source-string* , *search-string* , *replace-string*) ➔

source-string

An expression that specifies the source string. The *source-string* must be a built-in numeric or string expression. A numeric argument is cast to a character string before evaluating the function. For more information about converting numeric to a character string, see [“VARCHAR” on page 616](#).

search-string

An expression that specifies the string to be removed from the source string. The *search-string* must be a built-in numeric or string expression. A numeric argument is cast to a character string before evaluating the function. For more information about converting numeric to a character string, see [“VARCHAR” on page 616](#).

replace-string

An expression that specifies the replacement string. The *replace-string* must be a built-in numeric or string expression. A numeric argument is cast to a character string before evaluating the function. For more information about converting numeric to a character string, see [“VARCHAR” on page 616](#).

If *replace-string* is an empty string or is not specified, nothing replaces the string that is removed from the source string.

source-string, *search-string*, and *replace-string* must be compatible. For more information about data type compatibility, see [“Assignments and comparisons” on page 91](#).

The data type of the result of the function depends on the data type of the arguments. The result data type is the same as if the three arguments were concatenated except that the result is always a varying-length string. For more information see [“Conversion rules for operations that combine strings” on page 112](#).

The length attribute of the result depends on the arguments:

- If *search-string* is variable length, the length attribute of the result is:

$$(L3 * L1)$$

- If the length attribute of *replace-string* is less than or equal to the length attribute of *search-string*, the length attribute of the result is the length attribute of *source-string*
- Otherwise, the length attribute of the result is:

$$(L3 * (L1/L2)) + \text{MOD}(L1, L2)$$

where:

L1 is the length attribute of *source-string*
L2 is the length attribute of *search-string*
L3 is the length attribute of *replace-string*

If the length attribute of the result exceeds the maximum for the result data type, an error is returned.

The actual length of the result is the actual length of *source-string* plus the number of occurrences of *search-string* that exist in *source-string* multiplied by the actual length of *replace-string* minus the actual length of *search-string*. If the actual length of the result string exceeds the maximum for the result data type, an error is returned.

If any argument can be null, the result can be null; if any argument is null, the result is the null value.

The CCSID of the result is determined by the CCSID of *source-string*, *search-string*, and *replace-string*. The resulting CCSID is the same as if the three arguments were concatenated. For more information, see [“Conversion rules for operations that combine strings” on page 112.](#)

Examples

- Replace all occurrences of the character 'N' in the string 'DINING' with 'VID'. Use the CHAR function to limit the output to 10 bytes.

```
SELECT CHAR(REPLACE( 'DINING', 'N', 'VID' ), 10)
FROM SYSIBM.SYSDUMMY1
```

The result is the string 'DIVIDIVIDG'.

- Replace string 'ABC' in the string 'ABCXYZ' with nothing, which is the same as removing 'ABC' from the string.

```
SELECT REPLACE( 'ABCXYZ', 'ABC', '' )
FROM SYSIBM.SYSDUMMY1
```

The result is the string 'XYZ'.

Omitting the third argument returns the same result.

```
SELECT REPLACE( 'ABCXYZ', 'ABC' )
FROM SYSIBM.SYSDUMMY1
```

- Replace string 'ABC' in the string 'ABCCABCC' with 'AB'. This example illustrates that the result can still contain the string that is to be replaced (in this case, 'ABC') because all occurrences of the string to be replaced are identified prior to any replacement.

```
SELECT REPLACE( 'ABCCABCC', 'ABC', 'AB' )
FROM SYSIBM.SYSDUMMY1
```

The result is the string 'ABCABC'.

RID

The RID function returns the relative record number of a row as a BIGINT.

►► RID — (— *table-designator* —) ►►

table-designator

A table designator that can be used to qualify a column in the same relative location in the SQL statement as the RID function. For more information about table designators, see [“Table designators” on page 135](#).

In SQL naming, the table name may be qualified. In system naming, the table name cannot be qualified.

The *table-designator* must not identify a *table-function*, a *collection-derived-table*, a VALUES clause, or a *data-change-table-reference*. If the argument identifies a view, common table expression, or nested table expression, its outer subselect must directly or indirectly reference a table.

If the argument identifies a view, common table expression, or nested table expression, the function returns the relative record number of its base table. If the argument identifies a view, common table expression, or nested table expression derived from more than one base table, the function returns the relative record number of the first table in the outer subselect of the view, common table expression, or nested table expression.

If the argument identifies a distributed table, the function returns the relative record number of the row on the node where the row is located. If the argument identifies a partitioned table, the function returns the relative record number of the row in the partition where the row is located. This means that RID will not be unique for each row of a partitioned or distributed table.

The argument must not identify a view, common table expression, or nested table expression whose outer fullselect includes an aggregate function, a GROUP BY clause, a HAVING clause, a UNION, INTERSECT, or EXCEPT clause, a DISTINCT clause, a VALUES clause, or a *table-function*. The RID function cannot be specified in a SELECT clause if the fullselect contains an aggregate function, a GROUP BY clause, or a HAVING clause

The data type of the result is a big integer. The result can be null.

Example

- Return the relative record number and employee name from table EMPLOYEE for those employees in department 20.

```
SELECT RID(EMPLOYEE), LASTNAME
FROM EMPLOYEE
WHERE DEPTNO = 20
```

RIGHT

The RIGHT function returns the rightmost *integer* characters of *expression*.

►► RIGHT — (— *expression* — , — *integer* —) —►

If *expression* is a character string, the result is a character string. If *expression* is a graphic string, the result is a graphic string. If *expression* is a binary string, the result is a binary string.

expression

An expression that specifies the string from which the result is derived. The string must be a built-in numeric or string expression. A numeric argument is cast to a character string before evaluating the function. For more information on converting numeric to a character string, see [“VARCHAR” on page 616](#).

A substring of *expression* is zero or more contiguous characters of *expression*. If *expression* is a character string or graphic string, a single character is either an SBCS, DBCS, or multiple-byte character. If *expression* is a binary string, the result is the number of bytes in the argument.

integer

An expression that returns a built-in integer data type. The integer specifies the length of the result. *integer* must be greater than or equal to 0 and less than or equal to *n*, where *n* is the length attribute of *expression*.

The result of the function is a varying-length string with a length attribute that is the same as the length attribute of *expression* and a data type that depends on the data type of *expression*:

Data type of <i>expression</i>	Data type of the Result
CHAR or VARCHAR	VARCHAR
CLOB	CLOB
GRAPHIC or VARGRAPHIC	VARGRAPHIC
DBCLOB	DBCLOB
BINARY or VARBINARY	VARBINARY
BLOB	BLOB

The actual length of the result is *integer*.

If any argument can be null, the result can be null; if any argument is null, the result is the null value.

The CCSID of the result is the same as that of *expression*.

Note

Syntax alternatives: STRRIGHT is a synonym for RIGHT.

Example

- Assume that host variable ALPHA has a value of 'ABCDEF'. The following statement:

```
SELECT RIGHT( :ALPHA, 3)
FROM SYSIBM.SYSDUMMY1
```

Returns the value 'DEF', which are the three rightmost characters in ALPHA.

- The following statement returns a zero length string.

```
SELECT RIGHT( 'ABCABC', 0)  
FROM SYSIBM.SYSDUMMY1
```

- Assume that NAME is a VARCHAR(128) column, encoded in Unicode UTF-8, that contains the value 'Jürgen'.

```
SELECT RIGHT(NAME, 5), SUBSTR(NAME, 3, 5)  
FROM T1  
WHERE NAME = 'Jürgen'
```

Returns the value 'ürgen' for RIGHT and an unprintable string (X'BC7267656E') for SUBSTR(NAME, 3, 5).

ROUND

The ROUND function returns *expression-1* rounded to some number of places to the right or left of the decimal point.

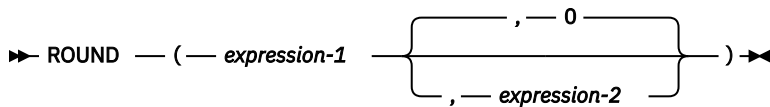

expression-1

An expression that returns a value of any built-in numeric, character-string, or graphic-string data type. A string argument is converted to double-precision floating point before evaluating the function. For more information about converting strings to double-precision floating point, see [“DOUBLE_PRECISION or DOUBLE”](#) on page 391.

If *expression-1* is a decimal floating-point data type, the DECFLOAT ROUNDING MODE will not be used. The rounding behavior of ROUND corresponds to a value of ROUND_HALF_UP. If a different rounding behavior is wanted, use the QUANTIZE function.

expression-2

An expression that returns a value of a built-in BIGINT, INTEGER, or SMALLINT data type.

If *expression-2* is positive, *expression-1* is rounded to the *expression-2* number of places to the right of the decimal point.

If *expression-2* is negative, *expression-1* is rounded to 1 + (the absolute value of *expression-2*) number of places to the left of the decimal point. If the absolute value of *expression-2* is greater than the number of digits to the left of the decimal point, the result is 0. (For example, ROUND(748.58,-4) returns 0.)

If *expression-2* is not specified, *expression-1* is rounded to zero places to the left of the decimal point.

If *expression-1* is positive, a digit value of 5 is rounded to the next higher positive number. If *expression-1* is negative, a digit value of 5 is rounded to the next lower negative number.

The data type and length attribute of the result are the same as the data type and length attribute of the first argument, except that precision is increased by one if *expression-1* is DECIMAL or NUMERIC and the precision is less than the maximum precision (*mp*). For example, an argument with a data type of DECIMAL(5,2) will result in DECIMAL(6,2). An argument with a data type of DECIMAL(63,2) will result in DECIMAL(63,2).

If either argument can be null, the result can be null. If either argument is null, the result is the null value.

Examples

- Calculate the number 873.726 rounded to 2, 1, 0, -1, -2, -3, and -4 decimal places respectively.

```
SELECT ROUND(873.726, 2),
       ROUND(873.726, 1),
       ROUND(873.726, 0),
       ROUND(873.726, -1),
       ROUND(873.726, -2),
       ROUND(873.726, -3),
       ROUND(873.726, -4)
FROM SYSIBM.SYSDUMMY1
```

Returns the following values, respectively:

```
0873.730  0873.700  0874.000  0870.000  0900.000  1000.000  0000.000
```

- Calculate both positive and negative numbers.

```
SELECT ROUND( 3.5, 0),  
       ROUND( 3.1, 0),  
       ROUND(-3.1, 0),  
       ROUND(-3.5, 0)  
FROM SYSIBM.SYSDUMMY1
```

Returns the following examples, respectively:

```
04.0  03.0  -03.0  -04.0
```

ROUND_TIMESTAMP

The ROUND_TIMESTAMP function returns a timestamp that is the *expression* rounded to the unit specified by the *format-string*. If *format-string* is not specified, *expression* is rounded to the nearest day, as if 'DD' was specified for *format-string*.

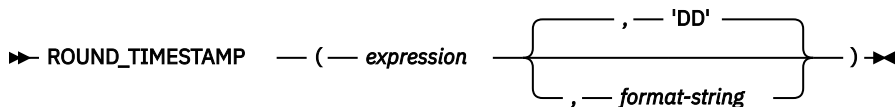

expression

An expression that returns a value of one of the following built-in data types: a date, a timestamp, a character-string, or a graphic-string.

If *expression* is a character or graphic string, its value must be a valid string representation of a date or timestamp. It is first converted to a `TIMESTAMP(12)` value. For the valid formats of string representations of dates and timestamps, see [“String representations of datetime values”](#) on page 75.

format-string

An expression that returns a built-in character string data type or graphic string data type. *format-string* contains a template of how *expression* should be rounded. For example, if *format-string* is 'DD', a timestamp that is represented by *expression* is rounded to the nearest day. Leading and trailing blanks are removed from the string, and the resulting substring must be a valid template for a timestamp. The resulting value is then folded to uppercase, so the characters in the value may be in any case. Allowable values for *format-string* are listed in [Table 56 on page 550](#).

The result of the function is a timestamp with a timestamp precision of:

- *p* when the data type of *expression* is `TIMESTAMP(p)`
- 0 when the data type of *expression* is `DATE`
- 6 otherwise.

If either argument can be null, the result can be null; if either argument is null, the result is the null value.

Format model	Rounding or truncating unit	ROUND_TIMESTAMP example	TRUNC_TIMESTAMP example
CC SCC	One greater than the first two digits of a four digit year. (Rounds up on the 50th year of the century)	Input value: 1897-12-04-12.22.22.00 0000 Result: 1901-01-01-00.00.00.00 0000	Input value: 1897-12-04-12.22.22.00 0000 Result: 1801-01-01-00.00.00.00 0000
YYYY SYYYY YEAR SYEAR YYY YY Y	Year (Rounds up on July 1 to January 1st of the next year)	Input value: 1897-12-04-12.22.22.00 0000 Result: 1898-01-01-00.00.00.00 0000	Input value: 1897-12-04-12.22.22.00 0000 Result: 1897-01-01-00.00.00.00 0000

Table 56. ROUND_TIMESTAMP and TRUNC_TIMESTAMP format models (continued)

Format model	Rounding or truncating unit	ROUND_TIMESTAMP example	TRUNC_TIMESTAMP example
IYYY IYY IY I	ISO year (Rounds up on July 1 to the first day of the next ISO year. The first day of the ISO year is defined as the Monday of the first ISO week.)	Input value: 1897-12-04-12.22.22.00 0000 Result: 1898-01-03-00.00.00.00 0000	Input value: 1897-12-04-12.22.22.00 0000 Result: 1897-01-04-00.00.00.00 0000
Q	Quarter (Rounds up on the 16th day of the second month of the quarter)	Input value: 1999-06-04-12.12.30.00 0000 Result: 1999-07-01-00.00.00.00 0000	Input value: 1999-06-04-12.12.30.00 0000 Result: 1999-04-01-00.00.00.00 0000
MONTH MON MM RM	Month (Rounds up on the 16th day of the month)	Input value: 1999-06-18-12.12.30.00 0000 Result: 1999-07-01-00.00.00.00 0000	Input value: 1999-06-18-12.12.30.00 0000 Result: 1999-06-01-00.00.00.00 0000
WW	Same day of the week as the first day of the year (Rounds up on the 12th hour of the 4th day of the week, with respect to the first day of the year)	Input value: 2000-05-05-12.12.30.00 0000 Result: 2000-05-06-00.00.00.00 0000	Input value: 2000-05-05-12.12.30.00 0000 Result: 2000-04-29-00.00.00.00 0000
IW	Same day of the week as the first day of the ISO year (Rounds up on the 12th hour of the 4th day of the week, with respect to the first day of the ISO year)	Input value: 2000-05-05-12.12.30.00 0000 Result: 2000-05-08-00.00.00.00 0000	Input value: 2000-05-05-12.12.30.00 0000 Result: 2000-05-01-00.00.00.00 0000
W	Same day of the week as the first day of the month (Rounds up on the 12th hour of the 4th day of the week, with respect to the first day of the month)	Input value: 2000-06-21-12.12.30.00 0000 Result: 2000-06-22-00.00.00.00 0000	Input value: 2000-06-22-12.12.30.00 0000 Result: 2000-06-15-00.00.00.00 0000
DDD DD J	Day (Rounds up on the 12th hour of the day)	Input value: 2000-05-17-12.59.59.00 0000 Result: 2000-05-18-00.00.00.00 0000	Input value: 2000-05-17-12.59.59.00 0000 Result: 2000-05-17-00.00.00.00 0000

Table 56. ROUND_TIMESTAMP and TRUNC_TIMESTAMP format models (continued)

Format model	Rounding or truncating unit	ROUND_TIMESTAMP example	TRUNC_TIMESTAMP example
DAY DY D	Starting day of the week (Rounds up with respect to the 12th hour of the 4th day of the week. The first day of the week is always Sunday)	Input value: 2000-05-17-12.59.59.00 0000 Result: 2000-05-21-00.00.00.00 0000	Input value: 2000-05-17-12.59.59.00 0000 Result: 2000-05-14-00.00.00.00 0000
HH HH12 HH24	Hour (Rounds up at 30 minutes)	Input value: 2000-05-17-23.59.59.00 0000 Result: 2000-05-18-00.00.00.00 0000	Input value: 2000-05-17-23.59.59.00 0000 Result: 2000-05-17-23.00.00.00 0000
MI	Minute (Rounds up at 30 seconds)	Input value: 2000-05-17-23.58.45.00 0000 Result: 2000-05-17-23.59.00.00 0000	Input value: 2000-05-17-23.58.45.00 0000 Result: 2000-05-17-23.58.00.00 0000
SS	Second (Rounds up at 500000 microseconds)	Input value: 2000-05-17-23.58.45.50 0000 Result: 2000-05-17-23.58.46.00 0000	Input value: 2000-05-17-23.58.45.50 0000 Result: 2000-05-17-23.58.45.00 0000

Note:

The ISO year starts on the first day of the first ISO week of the year. This can be up to three days before January 1st or three days after January 1st. See [“WEEK_ISO” on page 640](#) for details.

Example

- Set the host variable RND_TMSTMP with the current year rounded to the nearest month value.

```
SET :RND_TMSTMP = ROUND_TIMESTAMP('2000-03-18-17.30.00', 'MONTH');
```

Host variable RND_TMSTMP is set with the value 2000-04-01-00.00.00.000000.

ROWID

The ROWID function casts a character string to a row ID.

►► ROWID — (— *string-expression* —) ►►

string-expression

An expression that returns a character string value. Although the string can contain any value, it is recommended that it contain a ROWID value that was previously generated by Db2 for z/OS or Db2 for i to ensure a valid ROWID value is returned. For example, the function can be used to convert a ROWID value that was cast to a CHAR value back to a ROWID value.

If the actual length of *string-expression* is less than 40, the result is not padded. If the actual length of *string-expression* is greater than 40, the result is truncated. If non-blank characters are truncated, a warning is returned.

The length attribute of the result is 40. The actual length of the result is the length of *string-expression*.

The result of the function is a row ID. If the argument can be null, the result can be null; if the argument is null, the result is the null value.

Note

Syntax alternatives: The CAST specification should be used to increase the portability of applications. For more information, see [“CAST specification”](#) on page 177.

Example

- Assume that table EMPLOYEE contains a ROWID column EMP_ROWID. Also assume that the table contains a row that is identified by a row ID value that is equivalent to X'F0DFD230E3C0D80D81C201AA0A28010000000000203'. Using direct row access, select the employee number for that row.

```
SELECT EMPNO
FROM EMPLOYEE
WHERE EMP_ROWID = ROWID(X'F0DFD230E3C0D80D81C201AA0A28010000000000203')
```

RPAD

The RPAD function returns a string composed of *expression* that is padded on the right.

➤ RPAD (*expression* , *length* , *pad*) ➤

The RPAD function treats leading or trailing blanks in *expression* as significant. Padding will only occur if the actual length of *expression* is less than *length*, and *pad* is not an empty string.

expression

An expression that specifies the string from which the result is derived.

Expression must be a built-in string, numeric, or datetime data type. A numeric or datetime argument is cast to VARCHAR with a CCSID that is the default SBCS CCSID at the current server before evaluating the function. For more information about converting numeric or datetime to a character string, see “VARCHAR” on page 616.

length

An expression that specifies the length of the result. The expression must return a value that is a built-in numeric, character-string, or graphic-string data type. If the data type of the expression is not INTEGER, it is implicitly cast to INTEGER before evaluating the function. The value must be zero or a positive integer that is less than or equal to *n*, where *n* is the maximum length of the result data type. See Appendix A, “SQL limits,” on page 1635 for more information.

If *expression* is a graphic string, *length* indicates the number of DBCS or Unicode graphic characters. If *expression* is a character string, *length* indicates the number of characters where a character may consist of one or more bytes. If *expression* is a binary string, *length* indicates the number of bytes.

pad

An expression that specifies the string with which to pad. The expression must return a value that is a built-in string, numeric, or datetime data type. If the value is a numeric or datetime data type, it is implicitly cast to VARCHAR with a CCSID that is the default SBCS CCSID at the current server before evaluating the function.

If *pad* is not specified, the pad character is set as follows:

- For character and graphic strings, a single-byte, double-byte, UTF-16, or UTF-8 blank character based on the data type and CCSID of *expression*.⁷²
- For binary strings, hexadecimal zeros.

The value for *expression* and the value for *pad* must have compatible data types. If the CCSID of *pad* is different than the CCSID of *expression*, the *pad* value is converted to the CCSID of *expression*. For more information about data type compatibility, see “Assignments and comparisons” on page 91.

The data type of the result depends on the data type of *expression*:

Data type of <i>expression</i>	Data Type of the Result for RPAD
CHAR or VARCHAR or numeric or datetime	VARCHAR
CLOB	CLOB
GRAPHIC or VARGRAPHIC	VARGRAPHIC
DBCLOB	DBCLOB
BINARY or VARBINARY	VARBINARY

⁷² UTF-16 or UCS-2 defines a blank character at code point X'0020' and X'3000'. The database manager pads with the blank at code point X'0020'. The database manager pads UTF-8 with a blank at code point X'20'

Data type of <i>expression</i>	Data Type of the Result for RPAD
BLOB	BLOB

The length attribute of the result depends on *length*. If *length* is explicitly specified by an integer constant that is greater than zero, the length attribute of the result is *length*. If *length* is explicitly specified by an integer constant that is zero, the length attribute of the result is 1. If *length* is specified as an expression, the length attribute of the result is the minimum of $m+100$ and the maximum length of the result data type, where m is the length attribute of *expression*. See [Appendix A, “SQL limits,”](#) on page 1635 for more information.

The actual length of the result is determined from *length*.

- If *length* is 0, the actual length is 0 and the result is the empty result string.
- If *length* is equal to the actual length of *expression*, the actual length is the length of *expression*.
- If *length* is less than the actual length of *expression*, the result is truncated. The actual length is *length* unless the result data type is varying-length mixed data or varying-length Unicode. In this case, only complete characters will be truncated.
 - For Unicode data, the actual length may be $length-1$ to prevent a double-byte character from being split.
 - For mixed data the actual length may be as little as $length-3$ to account for truncation of a double byte character and possibly a “shift-in” character (X'0F') and a “shift-out” character (X'0E').
- If *length* is greater than the actual length of *expression*, the actual length is *length* unless the result data type is varying-length mixed data or varying-length Unicode and *pad* contains double-byte characters. In this case, only complete characters will be padded.
 - For Unicode data, the actual length may be $length-1$ to prevent a double-byte character from being split.
 - For mixed data, the actual length may be may be as little as $length-3$ to account for truncation of a double byte character and possibly a “shift-in” character (X'0F') and a “shift-out” character (X'0E'). Also, this result will not have redundant shift codes “at the seam”. Thus, if the pad is a string ending with a “shift-in” character (X'0F'), and expression begins with a “shift-out” character (X'0E'), these two bytes are eliminated from the result.

If any argument can be null, the result can be null; if any argument is null, the result is the null value.

The CCSID of the result is the same as that of *expression*.

Examples

- *Example 1:* Assume that NAME is a VARCHAR(15) column that contains the values "Chris", "Meg", and "Jeff". The following query will completely pad out a value on the right with periods:

```
SELECT RPAD(NAME,15,'.' ) AS NAME FROM T1;
```

returns:

```
NAME
-----
Chris.....
Meg.....
Jeff.....
```

- *Example 2:* Assume that NAME is a VARCHAR(15) column that contains the values "Chris", "Meg", and "Jeff". The following query will only pad each value to a length of 5:

```
SELECT RPAD(NAME,5,'.' ) AS NAME FROM T1;
```

returns:

```
NAME
-----
Chris
Meg..
Jeff.
```

- *Example 3:* Assume that NAME is a CHAR(15) column containing the values "Chris", "Meg", and "Jeff". Note that the result of RTRIM is a varying length string with the blanks removed

```
SELECT RPAD(RTRIM(NAME),15,'.' ) AS NAME FROM T1;
```

returns:

```
NAME
-----
Chris.....
Meg.....
Jeff.....
```

- *Example 4:* Assume that NAME is a VARCHAR(15) column containing the values "Chris", "Meg", and "Jeff". The following query will completely pad out a value on the right with *pad* (note that in some cases, a partial instance of the pad specification is returned):

```
SELECT RPAD(NAME,15,'123' ) AS NAME FROM T1;
```

returns:

```
NAME
-----
Chris1231231231
Meg123123123123
Jeff12312312312
```

- *Example 5:* Assume that NAME is a VARCHAR(15) column containing the values "Chris", "Meg", and "Jeff". Note that "Chris" is truncated, "Meg" is padded, and "Jeff" is unchanged:

```
SELECT RPAD(NAME,4,'.' ) AS NAME FROM T1;
```

returns:

```
NAME
----
Chri
Meg.
Jeff
```

RRN

The RRN function returns the relative record number of a row.

►► RRN — (— *table-designator* —) ◄◄

table-designator

A table designator that could be used to qualify a column in the same relative location in the SQL statement as the RRN function. For more information about table designators, see [“Table designators”](#) on page 135.

In SQL naming, the table name may be qualified. In system naming, the table name cannot be qualified.

The *table-designator* must not identify a *collection-derived-table*, a VALUES clause, a *table-function*, or a *data-change-table-reference*. If the argument identifies a view, common table expression, or nested table expression, its outer subselect must directly or indirectly reference a table.

If the argument identifies a view, common table expression, or nested table expression, the function returns the relative record number of its base table. If the argument identifies a view, common table expression, or nested table expression derived from more than one base table, the function returns the relative record number of the first table in the outer subselect of the view, common table expression, or nested table expression.

If the argument identifies a distributed table, the function returns the relative record number of the row on the node where the row is located. If the argument identifies a partitioned table, the function returns the relative record number of the row in the partition where the row is located. This means that RRN will not be unique for each row of a partitioned or distributed table.

The argument must not identify a view, common table expression, or nested table expression whose outer fullselect includes an aggregate function, a GROUP BY clause, a HAVING clause, a UNION, INTERSECT, or EXCEPT clause, a DISTINCT clause, a VALUES clause, or a *table-function*. The RRN function cannot be specified in a SELECT clause if the fullselect contains an aggregate function, a GROUP BY clause, or a HAVING clause.

The data type of the result is a decimal with precision 15 and scale 0. The result can be null.

Example

- Return the relative record number and employee name from table EMPLOYEE for those employees in department 20.

```
SELECT RRN(EMPLOYEE), LASTNAME
FROM EMPLOYEE
WHERE DEPTNO = 20
```

RTRIM

The RTRIM function removes any of the specified characters from the end of an expression.

►► RTRIM — (— *string-expression* — *trim-expression*) ►►

The RTRIM function removes all of the characters that are contained in *trim-expression* from the end of *string-expression*. The collating sequence does not affect the search. If the *string-expression* is defined as FOR BIT DATA or is a binary data type, the search is done by comparing each byte in *trim-expression* to the byte at the end of *string-expression*.

string-expression

An expression that returns a value of any built-in numeric, datetime, or string data type.⁷³ A numeric or datetime argument is cast to a character string before evaluating the function. For more information about converting numeric or datetime to a character string, see “VARCHAR” on page 616.

trim-expression

An expression that specifies the characters to remove from the end of *string-expression*. The expression must return a value of any built-in numeric, datetime, or string data type. A numeric or datetime argument is cast to a character string before evaluating the function.

When *trim-expression* is not specified, the data type of the *string-expression* determines the default value used:

- Hexadecimal zero (X'00') if the argument is a binary string.
- DBCS blank if the argument is a DBCS graphic string.
- UTF-16 or UCS-2 blank if the first argument is a Unicode graphic string.
- UTF-8 blank if the first argument is a UTF-8 character string.
- Otherwise, a SBCS blank.

The value for *string-expression* and the value for *trim-expression* must have compatible data types. For more information about data type compatibility, see “Assignments and comparisons” on page 91. If *string-expression* and *trim-expression* have different CCSIDs, *trim-expression* is converted to the CCSID of *string-expression*.

The data type of the result depends on the data type of *string-expression*:

Data type of <i>string-expression</i>	Data type of the Result
CHAR or VARCHAR	VARCHAR
CLOB	CLOB
GRAPHIC or VARGRAPHIC	VARGRAPHIC
DBCLOB	DBCLOB
BINARY or VARBINARY	VARBINARY
BLOB	BLOB

The length attribute of the result is the same as the length attribute of *string-expression*. The actual length of the result for character or binary strings is the length of *string-expression* minus the number of bytes removed. The actual length of the result for graphic strings is the length of *string-expression* minus the number of graphic characters removed. If all characters are removed, the result is an empty string.

If either argument can be null, the result can be null; if any argument is null, the result is the null value.

The CCSID of the result is the same as that of *string-expression*.

⁷³ The RTRIM function returns the same results as: STRIP(*expression*,TRAILING)

Examples

- *Example 1:* Use the RTRIM function when the host variable HELLO is defined as CHAR(9) and has a value of

```
'Hello '
```

```
VALUES RTRIM(:HELLO)
```

The result is 'Hello '. When a *trim-expression* is not specified only blanks are removed.

- *Example 2:* Use the RTRIM function to remove individual numbers in the *trim-expression* from the end (right side) of the *string-expression*.

```
SELECT RTRIM ('123DEFG123', '321'),  
       RTRIM ('12322XYZ12322222', '123'),  
       RTRIM ('12321', '213'),  
       RTRIM ('123XYX', '321')  
FROM SYSIBM.SYSDUMMY1
```

The result is:

```
'123DEFG'  
'12322XYZ'  
' ' (empty string - all characters removed)  
'123XYX' (no characters removed)
```

The RTRIM function does not remove instances of '1', '2', and '3' on the left side of the string, before characters that are not '1', '2', or '3'.

- *Example 3:* Use the RTRIM function to remove the characters specified in the *trim-expression* from the end of the *string-expression*.

```
VALUES RTRIM('...$VAR$...', '$.')
```

The result is '...\$VAR'.

- *Example 4:* Use the RTRIM function to remove the characters specified in the *trim-expression* from the end of the *string-expression*.

```
VALUES RTRIM('((-78.0) )', '-0. ()')
```

The result is '((-78) '. When removing characters and blanks, you must include a blank in the *trim-expression*.

SCORE

The SCORE function searches a text search index using criteria that are specified in a search argument and returns a relevance score that measures how well a document matches the query.

►► SCORE ►►

► (*column-name* , *search-argument* , *search-argument-options*) ►►

search-argument-options

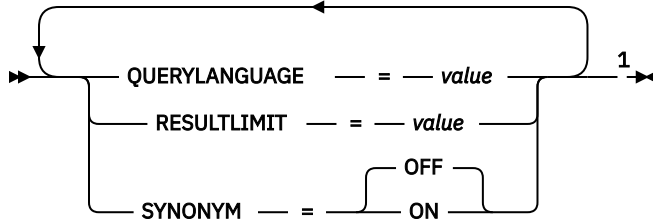

Notes:

¹ The same clause must not be specified more than once.

column-name

Specifies a qualified or unqualified name of a column that has a text search index that is to be searched. The column must exist in the table or view that is identified in the FROM clause in the statement and the column of the table, or the column of the underlying base table of the view must have an associated text search index. The underlying expression of the column of a view must be a simple column reference to the column of an underlying table, either directly or through another nested view.

search-argument

An expression that returns a character-string data type or graphic-string data type that contains the terms to be searched for. It must not be the empty string or contain all blanks. The actual length of the string must not exceed 32 740 bytes after conversion to Unicode and must not exceed the text search limitations or number of terms as specified in the search argument syntax. For information on *search-argument* syntax, see [Appendix G, “Text search argument syntax,” on page 1979](#).

search-argument-options

A character string or graphic string value that specifies the search argument options to use for the search. It must be a constant or a variable.

The options that can be specified as part of the *search-argument-options* are:

QUERYLANGUAGE = value

Specifies the language value. The value can be any of the supported language codes. If QUERYLANGUAGE is not specified, the default is the language value of the text search index that is used when the function is invoked. If the language value of the text search index is AUTO, the default value for QUERYLANGUAGE is en_US. For more information on the query language option, see [“Text search language options” on page 1989](#).

RESULTLIMIT = value

Specifies the maximum number of results that are to be returned from the underlying search engine. The *value* must be an integer from 1 to 2 147 483 647. If RESULTLIMIT is not specified, no result limit is in effect for the query.

SCORE may or may not be called for each row of the result table, depending on the plan that the optimizer chooses. If SCORE is called once for the query to the underlying search engine, a result set of all of the ROWIDs or primary keys that match are returned from the search engine. This result set is then joined to the table containing the column to identify the result rows. In this case, the RESULTLIMIT value acts like a FETCH FIRST *n* ROWS ONLY from the underlying text search

engine and can be used as an optimization. If SCORE is called for each row of the result because the optimizer determines that is the best plan, then the RESULTLIMIT option has no effect.

SYNONYM = OFF or SYNONYM = ON

Specifies whether to use a synonym dictionary associated with the text search index. The default is OFF.

OFF

Do not use a synonym dictionary.

ON

Use the synonym dictionary associated with the text search index.

If *search-argument-options* is the empty string or the null value, the function is evaluated as if *search-argument-options* were not specified.

The result of the function is a double-precision floating-point number. If *search-argument* can be null, the result can be null; if *search-argument* is null, the result is the null value.

The result of SCORE is a value between 0 and 1. The more frequent the column contains a match for the search criteria specified by *search-argument*, the larger the result value. If a match is not found, the result is 0. If the column value is null or *search-argument* contains only blanks or is the empty string, the result is 0.

SCORE is a non-deterministic function.

Notes

Prerequisites: In order to use the CONTAINS and SCORE functions, OmniFind Text Search Server for DB2 for i must be installed and started.

Rules: If a view, nested table expression, or common table expression provides a text search column for a CONTAINS or SCORE scalar function and the applicable view, nested table expression, or common table expression has a DISTINCT clause on the outermost SELECT, the SELECT list must contain all the corresponding key fields of the text search index.

If a view, nested table expression, or common table expression provides a text search column for a CONTAINS or SCORE scalar function, the applicable view, nested table expression, or common table expression cannot have a UNION, EXCEPT, or INTERSECT at the outermost SELECT.

If a common table expression provides a text search column for a CONTAINS or SCORE scalar function, the common table expression cannot be subsequently referenced again in the entire query unless that reference does not provide a text search column for a CONTAINS or SCORE scalar function.

CONTAINS and SCORE scalar functions are not allowed if the query specifies:

- a distributed table,
- a table with a read trigger, or
- a logical file built over multiple physical file members.

Example

- The following statement generates a list of employees in the order of how well their resumes match the query "programmer AND (java OR cobol)", along with a relevance value that is normalized between 0 (zero) and 100.

```
SELECT EMPNO, INTEGER(SCORE(RESUME, 'programmer AND
(java OR cobol)') * 100) AS RELEVANCE
FROM EMP_RESUME
WHERE RESUME_FORMAT = 'ascii'
AND CONTAINS(RESUME, 'programmer AND (java OR cobol)') = 1
ORDER BY RELEVANCE DESC
```

The database manager first evaluates the CONTAINS predicate in the WHERE clause, and therefore, does not evaluate the SCORE function in the SELECT list for every row of the table. In this case, the arguments for SCORE and CONTAINS must be identical.

SECOND

The SECOND function returns the seconds part of a value with optional fractional seconds.

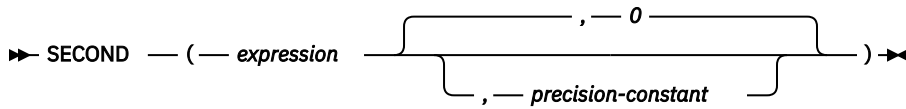

expression

An expression that returns a value of one of the following built-in data types: a date, a time, a timestamp, a character string, a graphic string, or a numeric data type.

- If *expression* is a character or graphic string, its value must be a valid string representation of a datetime value. If *expression* is a valid string representation of a timestamp, it is first converted to a `TIMESTAMP(12)` value. If *expression* is a valid string representation of a date, it must be in one of the IBM SQL standard formats. For the valid formats of string representations of datetime values, see [“String representations of datetime values”](#) on page 75.
- If the argument is a `DATE`, it is first converted to a `TIMESTAMP(0)` value, assuming a time of exactly midnight (00.00.00).
- If *expression* is a number, it must be a time duration or timestamp duration. For the valid formats of datetime durations, see [“Datetime operands and durations”](#) on page 166.

precision-constant

An integer constant representing the number of fractional seconds. The value must be in the range 0 through 12.

The result of the function with a single argument is a large integer. The result of the function with two arguments is `DECIMAL(2+s,s)` where *s* is the value of the *precision-constant*. If the argument can be null, the result can be null; if the argument is null, the result is the null value.

The other rules depend on the data type of the argument:

- If the argument is a date, a time, a timestamp, or a valid character-string representation of a date, time, or timestamp:

If only one argument is specified, the result is the seconds part of the value (0 to 59).

If both arguments are specified, the result is the seconds part of the value (0 to 59) and *precision-constant* digits of the fractional seconds part of the value. If there are no fractional seconds in the value, then zeroes are returned.

- If the argument is a time duration or timestamp duration:

If only one argument is specified, the result is the seconds part of the value (-99 to 99). A nonzero result has the same sign as the argument.

If both arguments are specified, the result is the seconds part of the value (-99 to 99) and *precision-constant* digits of the fractional seconds part of the value. If there are no fractional seconds in the value, then zeroes are returned. A nonzero result has the same sign as the argument.

Examples

- Assume that the host variable `TIME_DUR` (`DECIMAL(6,0)`) has the value 153045.

```
SELECT SECOND(:TIME_DUR)
FROM SYSIBM.SYSDUMMY1
```

Returns the value 45.

- Assume that the column `RECEIVED` (`TIMESTAMP`) has an internal value equivalent to 1988-12-25-17.12.30.000000.

```
SELECT SECOND(RECEIVED)  
FROM IN_TRAY
```

Returns the value 30.

- Get the seconds with fractional seconds from a current timestamp in milliseconds.

```
SELECT SECOND(CURRENT_TIMESTAMP(3),3)  
FROM SYSIBM.SYSDUMMY1
```

Returns a DECIMAL(5,3) value based on the current timestamp that could be something like 54.321.

SIGN

The SIGN function returns an indicator of the sign of expression.

►► SIGN (— *expression* —) ◄◄

The returned value is:

- 1**
if the argument is less than zero
- 0**
if the argument is DECFLOAT negative zero
- 0**
if the argument is zero
- 1**
if the argument is greater than zero

expression

An expression that returns a value of any built-in numeric, character-string, or graphic-string data type. A string argument is converted to double-precision floating point before evaluating the function. For more information about converting strings to double-precision floating point, see [“DOUBLE_PRECISION or DOUBLE”](#) on page 391.

The result has the same data type and length attribute as the argument, except that precision is increased by one if the argument is DECIMAL or NUMERIC and the scale of the argument is equal to its precision. For example, an argument with a data type of DECIMAL(5,5) will result in DECIMAL(6,5). If the precision is already the maximum precision (*mp*), the scale will be decreased by one. For example, DECIMAL(63,63) will result in DECIMAL(63,62).

If the argument can be null, the result can be null; if the argument is null, the result is the null value.

Example

- Assume that host variable PROFIT is a large integer with a value of 50000.

```
SELECT SIGN(:PROFIT)
FROM EMPLOYEE
```

Returns the value 1.

SIN

The SIN function returns the sine of the argument, where the argument is an angle expressed in radians. The SIN and ASIN functions are inverse operations.

►► SIN — (— *expression* —) ◄◄

expression

An expression that returns a value of any built-in numeric data type (except for DECFLOAT), character-string, or graphic-string data type. A string argument is converted to double-precision floating point before evaluating the function. For more information about converting strings to double-precision floating point, see [“DOUBLE_PRECISION or DOUBLE”](#) on page 391.

The data type of the result is double-precision floating point. If the argument can be null, the result can be null; if the argument is null, the result is the null value.

Example

- Assume the host variable SINE is a decimal (2,1) host variable with a value of 1.5.

```
SELECT SIN(:SINE)
FROM SYSIBM.SYSDUMMY1
```

Returns the approximate value 0.99.

SINH

The SINH function returns the hyperbolic sine of the argument, where the argument is an angle expressed in radians.

►► SINH — (— *expression* —) ◄◄

expression

An expression that returns a value of any built-in numeric data type (except for DECFLOAT), character-string, or graphic-string data type. A string argument is converted to double-precision floating point before evaluating the function. For more information about converting strings to double-precision floating point, see [“DOUBLE_PRECISION or DOUBLE”](#) on page 391.

The data type of the result is double-precision floating point. If the argument can be null, the result can be null; if the argument is null, the result is the null value.

Example

- Assume the host variable HSINE is a decimal (2,1) host variable with a value of 1.5.

```
SELECT SINH (:HSINE)
FROM SYSIBM.SYSDUMMY1
```

Returns the approximate value 2.12.

SMALLINT

The SMALLINT function returns a small integer representation.

Numeric to Smallint

➤ SMALLINT — (— *numeric-expression* —) ➤

String to Smallint

➤ SMALLINT — (— *string-expression* —) ➤

The SMALLINT function returns a small integer representation of

- A number
- A character or graphic string representation of a decimal number
- A character or graphic string representation of an integer
- A character or graphic string representation of a floating-point number
- A character or graphic string representation of a decimal floating-point number

Numeric to Smallint

numeric-expression

An expression that returns a numeric value of any built-in numeric data type.

The result is the same number that would occur if the argument were assigned to a small integer column or variable. If the whole part of the argument is not within the range of small integers, an error is returned. The fractional part of the argument is truncated.

String to Smallint

string-expression

An expression that returns a value that is a character-string or graphic-string representation of a number.

If the argument is a *string-expression*, the result is the same number that would result from CAST(*string-expression* AS SMALLINT). Leading and trailing blanks are eliminated and the resulting string must conform to the rules for forming a floating-point, decimal floating-point, integer, or decimal constant. If the whole part of the argument is not within the range of small integers, an error is returned. Any fractional part of the argument is truncated.

The result of the function is a small integer. If the argument can be null, the result can be null. If the argument is null, the result is the null value.

Note

Syntax alternatives: The CAST specification should be used to increase the portability of applications. For more information, see [“CAST specification” on page 177](#).

Example

- Using the EMPLOYEE table, select a list containing salary (SALARY) divided by education level (EDLEVEL). Truncate any decimal in the calculation. The list should also contain the values used in the calculation and the employee number (EMPNO).

```
SELECT SMALLINT(SALARY / EDLEVEL), SALARY, EDLEVEL, EMPNO
FROM EMPLOYEE
```

SOUNDEX

The SOUNDEX function returns a 4 character code representing the sound of the words in the argument. The result can be used to compare with the sound of other strings.

► SOUNDEX — (— *expression* —) ◄

expression

An expression that returns a value of any built-in numeric or string data type, that is not a CLOB or DBCLOB. The argument cannot be a binary string. A numeric argument is cast to a character string before evaluating the function. For more information about converting numeric to a character string, see [“VARCHAR”](#) on page 616.

The data type of the result is CHAR(4). If the argument can be null, the result can be null; if the argument is null, the result is the null value.

The CCSID of the result is the default CCSID of the current server.

The SOUNDEX function is useful for finding strings for which the sound is known but the precise spelling is not. It makes assumptions about the way that letters and combinations of letters sound that can help to search out words with similar sounds. The comparison can be done directly or by passing the strings as arguments to the DIFFERENCE function. For more information, see [“DIFFERENCE”](#) on page 380.

Example

- Using the EMPLOYEE table, find the EMPNO and LASTNAME of the employee with a surname that sounds like 'Loucesy'.

```
SELECT EMPNO, LASTNAME
FROM EMPLOYEE
WHERE SOUNDEX(LASTNAME) = SOUNDEX('Loucesy')
```

Returns the row:

```
000110 LUCCHESI
```

SPACE

The SPACE function returns a character string that consists of the number of SBCS blanks that the argument specifies.

►► SPACE — (— *expression* —) ◄◄

expression

An expression that returns a value of any built-in SMALLINT, INTEGER, BIGINT, character-string, or graphic-string data type. A string argument is converted to integer before evaluating the function. For more information about converting strings to integer, see [“INTEGER or INT” on page 438](#).

The *expression* specifies the number of SBCS blanks for the result, and it must be between 0 and 32740. If *expression* is a constant, it must not be the constant 0.

The result of the function is a varying-length character string (VARCHAR) that contains SBCS data.

If *expression* is a constant, the length attribute of the result is the constant. Otherwise, the length attribute of the result is 4000. The actual length of the result is the value of *expression*. The actual length of the result must not be greater than the length attribute of the result.

If the argument can be null, the result can be null; if the argument is null, the result is the null value.

The CCSID is the default CCSID for SBCS data of the job.

Example

- The following statement returns a character string that consists of 5 blanks.

```
SELECT SPACE(5)
FROM SYSIBM.SYSDUMMY1
```

SQRT

The SQRT function returns the square root of a number.

►► SQRT (— *expression* —) ◄◄

expression

An expression that returns a value of any built-in numeric, character-string, or graphic-string data type. A string argument is converted to double-precision floating point before evaluating the function. For more information about converting strings to double-precision floating point, see [“DOUBLE_PRECISION or DOUBLE” on page 391](#). The value of *expression* must be greater than or equal to zero.

If the data type of the argument is DECFLOAT(*n*), the result is DECFLOAT(*n*). Otherwise, the data type of the result is double-precision floating point. If the argument can be null, the result can be null; if the argument is null, the result is the null value.

Note

Results involving DECFLOAT special values: For decimal floating-point values the special values are treated as follows:

- SQRT(NaN) returns NaN. ⁷⁴
- SQRT(-NaN) returns NaN. ⁷⁴
- SQRT(Infinity) returns Infinity.
- SQRT(-Infinity) returns NaN. ⁷⁴
- SQRT(sNaN) and SQRT(-sNaN) return a warning or error. ⁶¹

Example

- Assume the host variable SQUARE is a DECIMAL(2,1) host variable with a value of 9.0.

```
SELECT SQRT(:SQUARE)
FROM SYSIBM.SYSDUMMY1
```

Returns the approximate value 3.00.

⁷⁴ If *YES is specified for the SQL_DECFLOAT_WARNINGS query option, NaN is returned with a warning.

STRIP

The STRIP function removes blanks or another specified character from the end, the beginning, or both ends of a string expression.

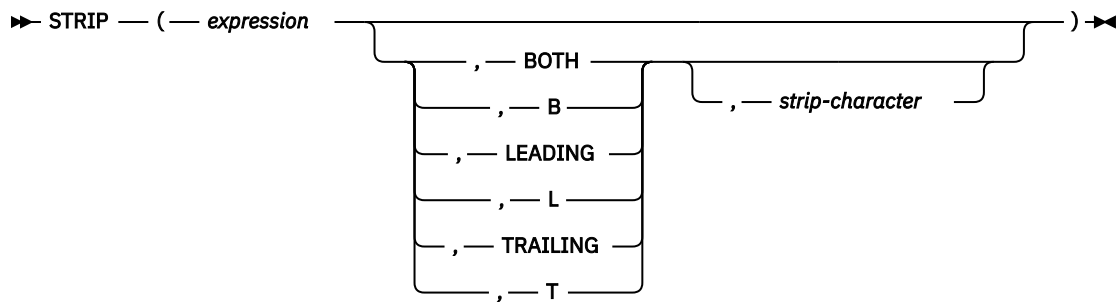

The STRIP function is identical to the TRIM scalar function. For more information, see [“TRIM” on page 604](#).

STRLEFT

The STRLEFT function returns the leftmost *integer* characters of *expression*.

► STRLEFT (*expression* , *integer*) ◄

The STRLEFT function is identical to the LEFT function. For more information, see [“LEFT” on page 467](#).

STRPOS

The STRPOS function returns the starting position of the first occurrence of one string (called the *search-string*) within another string (called the *source-string*). If the *search-string* is not found and neither argument is null, the result is zero. If the *search-string* is found, the result is a number from 1 to the actual length of the *source-string*.

►► STRPOS (— *source-string* — , — *search-string* —) ◄◄

The STRPOS function is identical to the POSSTR function. For more information, see [“POSSTR” on page 522](#).

STRRIGHT

The STRRIGHT function returns the rightmost *integer* characters of *expression*.

►► STRRIGHT (— *expression* — , — *integer* —) ◄◄

The STRRIGHT function is identical to the RIGHT function. For more information, see [“RIGHT” on page 546](#).

SUBSTR

The SUBSTR function returns a substring of a string.

► SUBSTR (*expression* , *start* , *length*) ◄

expression

An expression that specifies the string from which the result is derived.

Expression must be any built-in numeric or string data type. A numeric argument is cast to a character string before evaluating the function. For more information about converting numeric to a character string, see “VARCHAR” on page 616. If *expression* is a character string, the result of the function is a character string. If it is a graphic string, the result of the function is a graphic string. If it is a binary string, the result of the function is a binary string.

A substring of *expression* is zero or more contiguous characters of *expression*. If *expression* is a graphic string, a character is a DBCS or Unicode graphic character. If *expression* is a character string, a character is a byte.⁷⁵ If *expression* is a binary string, a character is a byte.

start

An expression that specifies the position within *expression* of the first character (or byte) of the result. The expression must return a value that is a built-in BIGINT, INTEGER, or SMALLINT data type. A value of 1 indicates that the first character of the result is the first character of *expression*. A negative or zero value indicates a position before the beginning of the string. It may also be greater than the length attribute of *expression*. (The length attribute of a varying-length string is its maximum length.)

length

An expression that specifies the length of the result. If specified, *length* must be an expression that returns a value that is a built-in BIGINT, INTEGER, or SMALLINT data type. The value must be greater than or equal to 0.

If *length* is explicitly specified, *expression* is effectively padded on the right with the necessary number of blank characters so that the specified substring of *expression* always exists. Hexadecimal zeroes are used as the padding character when *expression* is a binary string.

If *expression* is a fixed-length string, omission of *length* is an implicit specification of $\text{LENGTH}(\textit{expression}) - \textit{start} + 1$, which is the number of characters (or bytes) from the *start* character (or byte) to the last character (or byte) of *expression*. If *expression* is a varying-length string, omission of *length* is an implicit specification of zero or $\text{LENGTH}(\textit{expression}) - \textit{start} + 1$, whichever is greater. If the resulting length is zero, the result is the empty string.

The data type of the result depends on the data type of *expression*:

Data type of <i>expression</i>	Data Type of the Result for SUBSTR
CHAR or VARCHAR	CHAR, if: <ul style="list-style-type: none"> <i>length</i> is explicitly specified by an integer constant that is greater than zero. <i>length</i> is not explicitly specified, but <i>expression</i> is a fixed-length string and <i>start</i> is an integer constant. VARCHAR, in all other cases
CLOB	CLOB

⁷⁵ The SUBSTR function accepts mixed data strings. However, because SUBSTR operates on a strict byte-count basis, the result will not necessarily be a properly formed mixed data string.

Data type of <i>expression</i>	Data Type of the Result for SUBSTR
GRAPHIC or VARGRAPHIC	GRAPHIC, if: <ul style="list-style-type: none"> • <i>length</i> is explicitly specified by an integer constant that is greater than zero. • <i>length</i> is not explicitly specified, but <i>expression</i> is a fixed-length string and <i>start</i> is an integer constant. VARGRAPHIC, in all other cases.
DBCLOB	DBCLOB
BINARY or VARBINARY	BINARY, if: <ul style="list-style-type: none"> • <i>length</i> is explicitly specified by an integer constant that is greater than zero. • <i>length</i> is not explicitly specified, but <i>expression</i> is a fixed-length string and <i>start</i> is an integer constant. VARBINARY, in all other cases.
BLOB	BLOB

If *expression* is not a LOB, the length attribute of the result depends on *length*, *start*, and the attributes of *expression*.

- If *length* is explicitly specified by an integer constant that is greater than zero, the length attribute of the result is *length*.
- If *length* is not explicitly specified, but *expression* is a fixed-length string and *start* is an integer constant, the length attribute of the result is $\text{LENGTH}(\text{expression}) - \text{start} + 1$.

In all other cases, the length attribute of the result is the same as the length attribute of *expression*. (Remember that if the actual length of *expression* is less than the value for *start*, the actual length of the substring is zero.)

If any argument can be null, the result can be null; if any argument is null, the result is the null value.

The CCSID of the result is the same as that of *expression*.

Examples

- Assume the host variable NAME (VARCHAR(50)) has a value of 'KATIE AUSTIN' and the host variable SURNAME_POS (INTEGER) has a value of 7.

```
SELECT SUBSTR(:NAME, :SURNAME_POS)
FROM SYSIBM.SYSDUMMY1
```

Returns the value 'AUSTIN'.

- Likewise,

```
SELECT SUBSTR(:NAME, :SURNAME_POS, 1)
FROM SYSIBM.SYSDUMMY1
```

Returns the value 'A'.

- Select all rows from the PROJECT table for which the project name (PROJNAME) starts with the word 'OPERATION '.

```
SELECT *
FROM PROJECT
WHERE SUBSTR(PROJNAME,1,10) = 'OPERATION '
```

The space at the end of the constant is necessary to preclude initial words such as 'OPERATIONS'.

SUBSTRING

The SUBSTRING function returns a substring of a string.

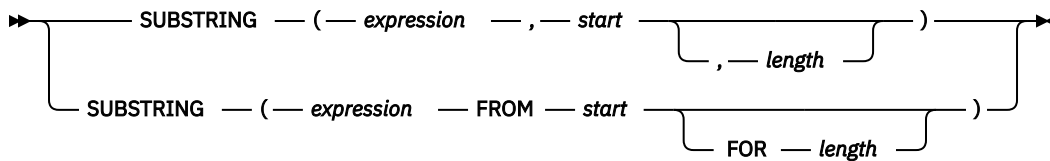

expression

An expression that specifies the string from which the result is derived.

Expression must be any built-in numeric or string data type. A numeric argument is cast to a character string before evaluating the function. For more information about converting numeric to a character string, see “VARCHAR” on page 616. If *expression* is a character string, the result of the function is a character string. If it is a graphic string, the result of the function is a graphic string. If it is a binary string, the result of the function is a binary string.

A substring of *expression* is zero or more contiguous characters of *expression*. If *expression* is a graphic string, a character is a DBCS or Unicode graphic character. If *expression* is a character string, a character is a character that may consist of one or more bytes. If *expression* is a binary string, a character is a byte.

start

An expression that specifies the position within *expression* of the first character (or byte) of the result. The expression must return a value that is a built-in BIGINT, INTEGER, or SMALLINT data type. A value of 1 indicates that the first character of the result is the first character of *expression*. A negative or zero value indicates a position before the beginning of the string. It may also be greater than the length attribute of *expression*. (The length attribute of a varying-length string is its maximum length.)

length

An expression that specifies the maximum actual length of the resulting substring. If specified, *length* must be an expression that returns a value that is a built-in BIGINT, INTEGER, or SMALLINT data type. The value must be greater than or equal to 0.

If *length* is explicitly specified, padding is not performed.

If *expression* is a fixed-length string, omission of *length* is an implicit specification of $\text{LENGTH}(\text{expression}) - \text{start} + 1$, which is the number of characters (or bytes) from the *start* character (or byte) to the last character (or byte) of *expression*. If *expression* is a varying-length string, omission of *length* is an implicit specification of zero or $\text{LENGTH}(\text{expression}) - \text{start} + 1$, whichever is greater. If the resulting length is zero, the result is the empty string.

The data type of the result depends on the data type of *expression*:

Data type of <i>expression</i>	Data Type of the Result for SUBSTRING
CHAR or VARCHAR	VARCHAR
CLOB	CLOB
GRAPHIC or VARGRAPHIC	VARGRAPHIC
DBCLOB	DBCLOB
BINARY or VARBINARY	VARBINARY
BLOB	BLOB

The length attribute of the result is the same as the length attribute of *expression*. (Remember that if the actual length of *expression* is less than the value for *start*, the actual length of the substring is zero.)

If any argument can be null, the result can be null; if any argument is null, the result is the null value.
The CCSID of the result is the same as that of *expression*.

Examples

- Select all rows from the PROJECT table for which the project name (PROJNAME) starts with the word 'OPERATION '.

```
SELECT *  
FROM PROJECT  
WHERE SUBSTRING(PROJNAME,1,10) = 'OPERATION '
```

The space at the end of the constant is necessary to preclude initial words such as 'OPERATIONS'.

- Assume that FIRSTNAME is a VARCHAR(12) column, encoded in Unicode UTF-8, in T1. One of its values is the 6-character string 'Jürgen'. When FIRSTNAME has this value:

```
SELECT SUBSTRING(FIRSTNAME, 1,2), SUBSTR(FIRSTNAME, 1,2)  
FROM T1
```

Returns the values 'Jü' (x'4AC3BC') and 'Jô' (x'4AC3').

TABLE_NAME

The TABLE_NAME function returns an unqualified name of the object found for an alias.

►► TABLE_NAME (— *object-name* — , — *object-schema* —) ►►

The specified *object-name* (and *object-schema*) are used to find an alias by that name.

object-name

A character or graphic string expression that identifies the SQL or system name of the object to be resolved. *object-name* must have an actual length less than 129 characters and may not identify a blank name. This name is case sensitive and must not be delimited.

object-schema

A character or graphic string expression that identifies the SQL or system name of the schema used to qualify *object-name*. *object-schema* must have an actual length less than 129 characters and may not identify a blank name. This name is case sensitive and must not be delimited.

If *object-schema* is not supplied, the default schema is used for the qualifier.

The result of the function is VARCHAR(128). If *object-name* can be null, the result can be null; if *object-name* is null, the result is the null value. If *object-schema* is the null value, the default schema name is used. The result is the character string representing an unqualified name.

The result name is the table name or view name referenced by the alias. If *object-name* is not an alias name, *object-name* is returned.

Example

Get the name of the table referenced by an alias that was created like this:

```
CREATE ALIAS MYLIB2.ALIAS1 FOR MYLIB.EMPLOYEE  
  
VALUES TABLE_NAME('ALIAS1', 'MYLIB2')
```

The result is:

```
EMPLOYEE
```

TABLE_SCHEMA

The TABLE_SCHEMA function returns the schema name of the object found for an alias.

►► TABLE_SCHEMA (— *object-name* — , — *object-schema* —) ►►

The specified *object-name* (and *object-schema*) are used to find an alias by that name.

object-name

A character or graphic string expression that identifies the SQL or system name of the object to be resolved. *object-name* must have an actual length less than 129 characters and may not identify a blank name. This name is case sensitive and must not be delimited.

object-schema

A character or graphic string expression that identifies the SQL or system name of the schema used to qualify *object-name*. *object-schema* must have an actual length less than 129 characters and may not identify a blank name. This name is case sensitive and must not be delimited.

If *object-schema* is not supplied, the default schema is used for the qualifier.

The result of the function is VARCHAR(128). If *object-name* can be null, the result can be null; if *object-name* is null, the result is the null value. If *object-schema* is the null value, the default schema name is used. The result is the character string representing a schema name.

The result name is the schema name of the table or view referenced by the alias. If *object-name* is not an alias name, *object-schema* is returned.

Example

Get the name of the schema referenced by an alias that was created like this:

```
CREATE ALIAS MYLIB2.ALIAS1 FOR MYLIB.EMPLOYEE  
  
VALUES TABLE_SCHEMA('ALIAS1', 'MYLIB2')
```

The result is:

```
MYLIB
```

TAN

The TAN function returns the tangent of the argument, where the argument is an angle expressed in radians. The TAN and ATAN functions are inverse operations.

►► TAN (— *expression* —) ◄◄

expression

An expression that returns a value of any built-in numeric data type (except for DECFLOAT), character-string, or graphic-string data type. A string argument is converted to double-precision floating point before evaluating the function. For more information about converting strings to double-precision floating point, see [“DOUBLE_PRECISION or DOUBLE”](#) on page 391.

The data type of the result is double-precision floating point. If the argument can be null, the result can be null; if the argument is null, the result is the null value.

Example

- Assume the host variable TANGENT is a DECIMAL(2,1) host variable with a value of 1.5.

```
SELECT TAN (:TANGENT)
FROM SYSIBM.SYSDUMMY1
```

Returns the approximate value 14.10.

TANH

The TANH function returns the hyperbolic tangent of the argument, where the argument is an angle expressed in radians. The TANH and ATANH functions are inverse operations.

►► TANH (— *expression* —) ◄◄

expression

An expression that returns a value of any built-in numeric data type (except for DECFLOAT), character-string, or graphic-string data type. A string argument is converted to double-precision floating point before evaluating the function. For more information about converting strings to double-precision floating point, see [“DOUBLE_PRECISION or DOUBLE”](#) on page 391.

The data type of the result is double-precision floating point. If the argument can be null, the result can be null; if the argument is null, the result is the null value.

Example

- Assume the host variable HTANGENT is a DECIMAL(2,1) host variable with a value of 1.5.

```
SELECT TANH (:HTANGENT)
FROM SYSIBM.SYSDUMMY1
```

Returns the approximate value 0.90.

TIME

The TIME function returns a time from a value.

►► TIME — (— *expression* —) ►◄

expression

An expression that returns a value of one of the following built-in data types: a date, a time, a timestamp, a character string, or a graphic string.

If *expression* is a character or graphic string, its value must be a valid string representation of a date, time, or timestamp. If *expression* is a valid string representation of a date, it must be one of the IBM SQL standard formats. For the valid formats of string representations of dates, times, and timestamps, see [“String representations of datetime values” on page 75](#).

The result of the function is a time. If the argument can be null, the result can be null; if the argument is null, the result is the null value.

The other rules depend on the data type of the argument:

- If the argument is a date:

The result is midnight.

- If the argument is a time:

The result is that time.

- If the argument is a timestamp:

The result is the time part of the timestamp.

- If the argument is a character or graphic string:

The result is the time represented by the string or the time part of the timestamp value represented by the string.

Note

Syntax alternatives: The CAST specification should be used to increase the portability of applications. For more information, see [“CAST specification” on page 177](#).

Example

- Select all notes from the IN_TRAY sample table that were received at least one hour later in the day (any day) than the current time.

```
SELECT *
FROM IN_TRAY
WHERE TIME(RECEIVED) >= CURRENT TIME + 1 HOUR
```

TIMESTAMP

The `TIMESTAMP` function returns a timestamp from its argument or arguments.

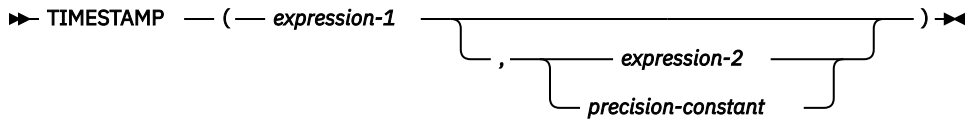

expression-1 and *expression-2*

The rules for the arguments depend on whether a second argument is specified and the data type of the second argument.

- If only *expression-1* is specified:

The argument must be an expression that returns a value of one of the following built-in data types: a date, a timestamp, a character string, or a graphic string. If *expression-1* is a character or graphic string, its value must be one of the following:

- A valid string representation of a date or a timestamp. For the valid formats of string representations of dates and timestamps, see [“String representations of datetime values” on page 75](#).
- A character string with an actual length of 13 that is assumed to be a result from a `GENERATE_UNIQUE` function. For information on `GENERATE_UNIQUE`, see [“GENERATE_UNIQUE” on page 409](#).

- If both arguments are specified:

- If the second argument is *expression-2*:

The first argument must be an expression that returns a value of one of the following built-in data types: a date, a character string, or a graphic string. If *expression-1* is a character or graphic string, its value must be a valid string representation of a date.

expression-2 must be an expression that returns a value of one of the following built-in data types: a time, a character string, or a graphic string. If *expression-2* is a character or graphic string, its value must be a valid string representation of a time. For the valid formats of string representations of dates and times, see [“String representations of datetime values” on page 75](#).

- If the second argument is *precision-constant*:

The first argument must be an expression that returns a value of one of the following built-in data types: a date, a timestamp, a character string, or a graphic string. If *expression-1* is a character or graphic string, its value must be one of the following:

- A valid string representation of a date or timestamp. For the valid formats of string representations of dates and timestamps, see [“String representations of datetime values” on page 75](#).
- A character string with an actual length of 13 that is assumed to be a result from a `GENERATE_UNIQUE` function. For information on `GENERATE_UNIQUE`, see [“GENERATE_UNIQUE” on page 409](#).

precision-constant

An integer constant representing the number of fractional seconds. The value must be in the range 0 through 12.

The result of the function is a timestamp. If either argument can be null, the result can be null; if either argument is null, the result is the null value.

The other rules depend on whether the second argument is specified:

- If both arguments are specified and the second argument is *expression-2*:

The result is a `TIMESTAMP(6)` with the date specified by the first argument and the time specified by the second argument. The fractional seconds part of the timestamp is zero.

- If both arguments are specified and the second argument is *precision-constant*:

The result is a timestamp with the precision specified by the second argument.

- If only one argument is specified and it is a `TIMESTAMP(p)`:

The result is a `TIMESTAMP(p)`.

- If only one argument is specified and it is a `DATE`:

The result is that date with an assumed time of midnight cast to `TIMESTAMP(0)`.

- If only one argument is specified and it is a string:

The result is the `TIMESTAMP(6)` represented by that string. If the argument is a string of length 14, the timestamp has a fractional seconds part of zero.

Note

Syntax alternatives: The `CAST` specification should be used to increase the portability of applications when only one argument is specified. For more information, see [“CAST specification” on page 177](#).

Examples

- Assume the following date and time values:

```
SELECT TIMESTAMP( DATE('1988-12-25'), TIME('17.12.30') )
FROM SYSIBM.SYSDUMMY1
```

Returns the value '1988-12-25-17.12.30.000000'.

- Convert a timestamp string with 7 digits of fractional seconds to a `TIMESTAMP(9)` value.

```
TIMESTAMP('2007-09-24-15.53.37.2162474', 9)
```

Returns the value '2007-09-24-15.53.37.216247400'.

TIMESTAMP_FORMAT

The `TIMESTAMP_FORMAT` function returns a timestamp that is based on the interpretation of the input string using the specified format.

►► `TIMESTAMP_FORMAT` (— *string-expression* — , — *format-string* — ►►

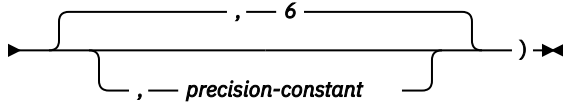

string-expression

An expression that returns a value of any built-in character string data type or graphic string data type.

The string is interpreted as a date or timestamp using the format specified by *format-string*. The *string-expression* must contain only the components of a date or timestamp that correspond to the format elements specified by *format-string*.

format-string

An expression that returns a built-in character string data type or graphic string data type. *format-string* contains a template of how *string-expression* is to be interpreted as a date or a timestamp value.

A valid *format-string* must contain at least one format element, must not contain multiple specifications for any component of a date or a timestamp, and can contain any combination of the format elements, unless otherwise noted in Table 57 on page 587. For example, *format-string* cannot contain both `YY` and `YYYY`, because they are both used to interpret the year component of *string-expression*. Refer to the table to determine which format elements cannot be specified together.

Two format elements can optionally be separated by one or more of the following separator characters:

- minus sign (-)
- period (.)
- slash (/)
- comma (,)
- apostrophe (')
- semicolon (;)
- colon (:)
- blank ()

Separator characters can also be specified at the start or end of *format-string*. These separator characters can be used in any combination in the format string, for example 'YYYY/MM-DD HH24:MM.SS'. Separator characters specified in a *string-expression* are used to separate components and are not required to match the separator characters specified in the *format-string*.

Format element	Related components of a timestamp	Description
AM or PM ^{1, 2}	hour	Meridian indicator (morning or evening) without periods. The meridian indicator is retrieved from message CPX9035 in message file QCPFMSG in library *LIBL.
A.M. or P.M. ^{1, 2}	hour	Meridian indicator (morning or evening) with periods. This format element uses the exact strings 'A.M.' or 'P.M.' and is independent of the language used for messages in the job.

Table 57. Format elements for the `TIMESTAMP_FORMAT` function (continued)

Format element	Related components of a timestamp	Description
DAY, Day, or day ^{1,3}	none	Name of the day in uppercase, titlecase, or lowercase format. The name of the day is retrieved from message CPX9034 in message file QCPFMSG in library *LIBL.
DY, Dy, or dy ^{1,3}	none	Abbreviated name of the day in uppercase, titlecase, or lowercase format. The abbreviated name of the day is retrieved from message CPX9039 in message file QCPFMSG in library *LIBL.
D ^{1,3}	none	Day of week (1-7), where 1 is Sunday.
DD	day	Day of month (01-31).
DDD	month, day	Day of year (001-366).
FF or FF n	fractional seconds	Fractional seconds (0-999999999999). The number n is used to specify the number of digits expected in the <i>string-expression</i> . Valid values for n are 1-12. Specifying FF is equivalent to specifying FF6. When the component in <i>string-expression</i> that corresponds to the FF format element is followed by a separator character or is the last component, the number of digits for the fractional seconds can be less than what is specified by the format element. In this case, zero digits are padded onto the right of the specified digits.
HH	hour	HH behaves the same as HH12.
HH12	hour	Hour of the day (01-12) in 12-hour format. AM is the default meridian indicator.
HH24	hour	Hour of the day (00-24) in 24-hour format.
J	year, month, and day	Julian date (number of days since January 1, 4713 BC).
MI	minute	Minute (00-59).
MM	month	Month (01-12).
MONTH, Month, or month ¹	month	Name of the month in uppercase, titlecase, or lowercase format. The name of the month is retrieved from message CPX3BC0 in message file QCPFMSG in library *LIBL.
MON, Mon, or mon ¹	month	Abbreviated name of the month in uppercase, titlecase, or lowercase format. The name of the month is retrieved from message CPX8601 in message file QCPFMSG in library *LIBL.
NNNNNN	microseconds	Microsecond (same as FF6).
RR ⁴	year	Last 2 digits of the adjusted year (00-99).
RRRR ⁴	year	Four digit adjusted year (0000-9999).
SS	seconds	Seconds (00-59).
SSSSS	hours, minutes, and seconds	Seconds since previous midnight (00000-86400).
Y	year	Last digit of the year (0-9). First three digits of the current year are used to determine the full 4-digit year.

Format element	Related components of a timestamp	Description
YY	year	Last 2 digits of the year (00-99). First two digits of the current year are used to determine the full 4-digit year.
YYY	year	Last three digits of the year (000-999). First digit of the current year is used to determine the full 4-digit year.
YYYY	year	4-digit year (0000-9999).

Notes:

1. Only these exact spellings and case combinations can be used. If this format element is specified in an invalid case combination an error is returned.
2. The AM and PM set of meridian indicators can be used interchangeably in the *format-string*, as can A.M. and P.M. If HH24 is used in the *format-string* along with a meridian indicator, the value of the meridian indicator in the *string-expression* is not used for determining the hour portion of the resulting timestamp.
3. The DAY, Day, day DY, Dy, dy, and D format elements do not contribute to any components of the resulting timestamp. However, a specified value for any of these format elements must be correct for the combination of the year, month, and day components of the resulting timestamp. For example, a value of 'Monday 2008-10-06' for *string-expression* is valid for a value of 'Day YYYY-MM-DD'. However, a value of 'Tuesday 2008-10-06' for *string-expression* would result in an error for the same *format-string*.
4. The RR and RRRR format elements can be used to alter how a specification for a year is to be interpreted by adjusting the value to produce a 2-digit or a 4-digit value depending on the leftmost two digits of the current year according to the following table:

Last two digits of current year	Two digits of year in <i>string-expression</i>	First 2 digits of the year component of date or timestamp
0-50	0-49	First 2 digits of current year
51-99	0-49	First 2 digits of current year + 1
0-50	50-99	First 2 digits of current year - 1
51-99	50-99	First 2 digits of current year

For example, if the current year is 2007, '86' with format 'RR' means 1986, but if the current year is 2052, it means 2086.

The following defaults will be used when a *format-string* does not include a format element for one of the components of a timestamp:

Timestamp component	Default
year	current year, as 4 digits
month	current month, as 2 digits
day	01 (first day of the month)
hour	00
minute	00
second	00

Timestamp component	Default
fractional seconds	a number of zeros matching the timestamp precision of the result

If *string-expression* does not include a value that corresponds to an hour, minute, second, or fractional seconds format element that is specified in the *format-string*, these same defaults are used.

Leading zeros can be specified for any component of the date or timestamp value (for example, month, day, hour, minutes, seconds) that does not have the maximum number of significant digits for the corresponding format element in the *format-string*.

A substring of the *string-expression* representing a component of a date or timestamp (such as year, month, day, hour, minutes, seconds) can include less than the maximum number of digits for that component of the date or timestamp. Any missing digits default to zero. For example, with a format-string of 'YYYY-MM-DD HH24:MI:SS', an input value of '999-3-9 5:7:2' would produce the same result as '0999-03-09 05:07:02'.

precision-constant

An integer constant that specifies the timestamp precision of the result. The value must be in the range 0 to 12. If *precision-constant* is not specified, the timestamp precision defaults to 6.

The result is a timestamp with a precision that is based on *precision-constant*. If either of the first two arguments can be null, the result can be null; if either of the first two arguments is null, the result is the null value.

Notes

Julian and Gregorian calendar: The transition from the Julian calendar to the Gregorian calendar on 15 October 1582 is taken into account by this function.

Syntax alternatives: TO_DATE is a synonym for TIMESTAMP_FORMAT. TO_TIMESTAMP is identical to TIMESTAMP_FORMAT except that if *precision-constant* is not specified, the timestamp precision of the result defaults to 12.

Examples

- Insert a row into the IN_TRAY table with a receiving timestamp that is equal to one second before the beginning of the year 2000 (December 31, 1999 at 23:59:59).

```
INSERT INTO IN_TRAY (RECEIVED)
VALUES (TIMESTAMP_FORMAT('1999-12-31 23:59:59',
'YYYY-MM-DD HH24:MI:SS'))
```

- An application receives strings of date information into a variable called INDATEVAR. This value is not strictly formatted and might include two or four digits for years, and one or two digits for months and days. Date components might be separated with minus sign (-) or slash (/) characters and are expected to be in day, month, and year order. Time information consists of hours (in 24-hour format) and minutes, and is usually separated by a colon. Sample values include '15/12/98 13:48' and '9-3-2004 8:02'. Insert such values into the IN_TRAY table.

```
INSERT INTO IN_TRAY (RECEIVED)
VALUES (TIMESTAMP_FORMAT(:INDATEVAR,
'DD/MM/RRRR HH24:MI'))
```

The use of RRRR in the format allows for 2- and 4-digit year values and assigns missing first two digits based on the current year. If YYYY were used, input values with a 2-digit year would have leading zeros. The slash separator also allows the minus sign character. Assuming a current year of 2007, resulting timestamps from the sample values are:

```
'15/12/98 13:48' --> 1998-12-15-13.48.00.000000
'9-3-2004 8:02' --> 2004-03-09-08.02.00.000000
```

- Set the character variable TVAR to the value of ROUTINE_CREATED from QSYS2.SYSPROCS if it is equal to one second before the beginning of the year 2000 ('1999-12-31 23:59:59'). The character string should be interpreted according to the format string provided.

```

SELECT VARCHAR_FORMAT(ROUTINE_CREATED, 'YYYY-MM-DD HH24:MI:SS')
  INTO :TVAR
  FROM QSYS2.SYSPROCS
  WHERE ROUTINE_CREATED =
        TIMESTAMP_FORMAT('1999-12-31 23:59:59', 'YYYY-MM-DD HH24:MI:SS')

```

- Return timestamp values for strings containing meridian indicators:

<i>string-expression</i>	<i>format-expression</i>	Result timestamp value
'2015-10-28 10:29AM'	'YYYY-MM-DD HH12:MIAM'	2015-10-28-10.29.00.000000
'2015-10-28 10:29PM'	'YYYY-MM-DD HH12:MIAM'	2015-10-28-22.29.00.000000
'2015-10-28 10:29AM'	'YYYY-MM-DD HH24:MIAM'	2015-10-28-10.29.00.000000
'2015-10-28 10:29PM'	'YYYY-MM-DD HH24:MIAM'	2015-10-28-10.29.00.000000
'2015-10-28 22:29AM'	'YYYY-MM-DD HH24:MIAM'	2015-10-28-22.29.00.000000
'2015-10-28 22:29PM'	'YYYY-MM-DD HH24:MIAM'	2015-10-28-22.29.00.000000

TIMESTAMP_ISO

Returns a timestamp value based on a date, time, or timestamp argument. If the argument is a date, it inserts zero for the time and fractional seconds part of the timestamp. If the argument is a time, it inserts the value of CURRENT DATE for the date part of the timestamp and zero for the fractional seconds part of the timestamp.

►► **TIMESTAMP_ISO** — (— *expression* —) ►►

expression

An *expression* that returns a value of one of the following built-in data types: a timestamp, a date, a time, a character string, or a graphic string.

If *expression* is a character or graphic string, its value must be a valid string representation of a date or timestamp. For the valid formats of string representations of dates and timestamps, see [“String representations of datetime values”](#) on page 75.

If *expression* is a timestamp, the result of the function is a timestamp with the same precision as *expression*. Otherwise, the result of the function is `TIMESTAMP(6)`. If the argument can be null, the result can be null; if the argument is null, the result is the null value.

If *expression* is a time, the function is not deterministic.

Note

Syntax alternatives: The CAST specification should be used to increase the portability of applications. For more information, see [“CAST specification”](#) on page 177.

Example

- Assume the following date value:

```
SELECT TIMESTAMP_ISO( DATE( '1988-12-25' ) )  
FROM SYSIBM.SYSDUMMY1
```

Returns the value '1988-12-25-00.00.00.000000'.

TIMESTAMPDIFF

The TIMESTAMPDIFF function returns an estimated number of intervals of the type defined by the first argument, based on the difference between two timestamps.

►► TIMESTAMPDIFF — (— *numeric-expression* — , — *string-expression* —) ►►

numeric-expression

The first argument must be a built-in data type of either INTEGER or SMALLINT. The value specifies the interval that is used to determine the difference between two timestamps. Valid values of the interval follow.

Table 58. Valid values for *numeric-expression* and equivalent intervals that are used to determine the difference between two timestamps

Valid values for <i>numeric-expression</i>	Equivalent intervals
1	Microseconds
2	Seconds
4	Minutes
8	Hours
16	Days
32	Weeks
64	Months
128	Quarters
256	Years

string-expression

string-expression is the result of subtracting two timestamps and converting the result to a string of length 22. If the *string-expression* has more than 6 digits to the right of the decimal point, the string will be truncated to 6 digits. The argument must be an expression that returns a value of a built-in character string or a graphic string.

If a positive or negative sign is present, it is the first character of the string. The following table describes the elements of the character string duration:

Table 59. TIMESTAMPDIFF String Elements

String elements	Valid values	Character position from the decimal point (negative is left)
Years	1-9998 or blank	-14 to -11
Months	0-11 or blank	-10 to -9
Days	0-30 or blank	-8 to -7
Hours	0-24 or blank	-6 to -5
Minutes	0-59 or blank	-4 to -3
Seconds	0-59	-2 to -1
Decimal separator	period	0
Microseconds	000000-999999	1 to 6

The result of the function is an integer with the same sign as *string-expression*. If either argument can be null, the result can be null; if either argument is null, the result is the null value.

The returned value is determined for each interval as indicated by the following table:

<i>Table 60. TIMESTAMPDIFF Computations</i>	
Result interval	Computation using duration elements
Years	years
Quarters	integer value of (months+(years*12))/3
Months	months + (years*12)
Weeks	integer value of ((days+(months*30))/7)+(years*52)
Days	days + (months*30)+(years*365)
Hours	hours + ((days+(months*30)+(years*365))*24)
Minutes (the absolute value of the duration must not exceed 40850913020759.999999)	minutes + (hours+((days+(months*30)+(years*365))*24))*60
Seconds (the absolute value of the duration must be less than 680105031408.000000)	seconds + (minutes+(hours+((days+(months*30)+(years*365))*24))*60
Microseconds (the absolute value of the duration must be less than 3547.483648)	microseconds + (seconds+(minutes*60))*1000000

The following assumptions are used when converting the element values to the requested interval type:

- One year has 365 days.
- One year has 52 weeks.
- One year has 12 months.
- One quarter has 3 months.
- One month has 30 days.
- One week has 7 days.
- One day has 24 hours.
- One hour has 60 minutes.
- One minute has 60 seconds.
- One second has 1000000 microseconds.

The use of these assumptions imply that some result values are an estimate of the interval. Consider the following examples:

- Difference of 1 month where the month has less than 30 days.

```
TIMESTAMPDIFF(16, CHAR(TIMESTAMP('1997-03-01-00.00.00')) - TIMESTAMP('1997-02-01-00.00.00'))
```

The result of the timestamp arithmetic is a duration of 00000100000000.000000, or 1 month. When the TIMESTAMPDIFF function is invoked with 16 for the interval argument (days), the assumption of 30 days in a month is applied and the result is 30.

- Difference of 1 day less than 1 month where the month has less than 30 days.

```
TIMESTAMPDIFF(16, CHAR(TIMESTAMP('1997-03-01-00.00.00')) - TIMESTAMP('1997-02-02-00.00.00')) )
```

The result of the timestamp arithmetic is a duration of 00000027000000.000000, or 27 days. When the `TIMESTAMPDIFF` function is invoked with 16 for the interval argument (days), the result is 27.

- Difference of 1 day less than 1 month where the month has 31 days.

```
TIMESTAMPDIFF(64, CHAR(TIMESTAMP('1997-09-01-00.00.00')) - TIMESTAMP('1997-08-02-00.00.00')) )
```

The result of the timestamp arithmetic is a duration of 00000030000000.000000, or 30 days. When the `TIMESTAMPDIFF` function is invoked with 64 for the interval argument (months), the result is 0. The days portion of the duration is 30, but it is ignored because the interval specified months.

Example

- The following statement estimates the age of employees in months and returns that value as `AGE_IN_MONTHS`:

```
SELECT  
  TIMESTAMPDIFF(64,  
    CAST(CURRENT_TIMESTAMP-CAST(BIRTHDATE AS TIMESTAMP) AS CHAR(22))  
  AS AGE_IN_MONTHS  
FROM EMPLOYEE
```

TO_CHAR

The TO_CHAR function returns a character string representation of the first argument in the format indicated by the optional *format-string*.

Character to Varchar

►► TO_CHAR (— *string-expression* —) ►◄

Timestamp to Varchar

►► TO_CHAR (— *timestamp-expression* — , — *format-string* —) ►◄

Numeric to Varchar

►► TO_CHAR (— *numeric-expression* — , — *format-string* —) ►◄

The TO_CHAR function is identical to the VARCHAR_FORMAT function. For more information, see [“VARCHAR_FORMAT”](#) on page 622.

TO_CLOB

The TO_CLOB function returns a character-string representation.

Integer to CLOB

►► TO_CLOB (— *integer-expression* —) ►►

Decimal to CLOB

►► TO_CLOB (— *decimal-expression* — , — *decimal-character* —) ►►

Floating-point to CLOB

►► TO_CLOB (— *floating-point-expression* — , — *decimal-character* —) ►►

Decimal floating-point to CLOB

►► TO_CLOB (— *decimal-floating-point-expression* — , — *decimal-character* —) ►►

Character to CLOB

►► TO_CLOB (— *character-expression* — ►►
, — *length* —) ►►
DEFAULT , — *integer*

Graphic to CLOB

►► TO_CLOB (— *graphic-expression* — , — *length* —) ►►
DEFAULT , — *integer*

Datetime to CLOB

►► TO_CLOB (— *datetime-expression* — , — *ISO* —) ►►
USA
EUR
JIS
LOCAL

The TO_CLOB function is identical to the CLOB function. For more information, see [“CLOB” on page 332](#).

TO_DATE

The TO_DATE function returns a timestamp that is based on the interpretation of the input string using the specified format.

►► TO_DATE (— *string-expression* — , — *format-string* —) ►►

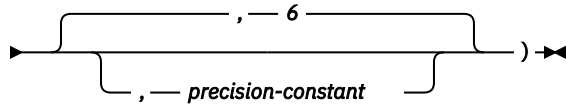

The TO_DATE function is identical to the [TIMESTAMP_FORMAT](#) function. For more information, see [“TIMESTAMP_FORMAT”](#) on page 587.

TO_NUMBER

The TO_NUMBER function returns a DECFLOAT(34) value that is based on the interpretation of the input string using the specified format.

►► TO_NUMBER (— *string-expression* — , — *format-string*) ◄◄

The TO_NUMBER function is identical to the DECFLOAT_FORMAT function. For more information, see [“DECFLOAT_FORMAT” on page 370](#).

TO_TIMESTAMP

The TO_TIMESTAMP function returns a timestamp that is based on the interpretation of the input string using the specified format.

► TO_TIMESTAMP (*string-expression* , *format-string*) ►

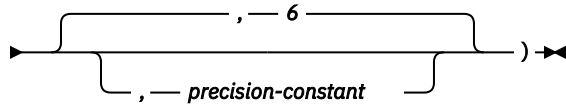

The TO_TIMESTAMP function is identical to TIMESTAMP_FORMAT except that if *precision-constant* is not specified, the timestamp precision of the result defaults to 12. For more information, see [“TIMESTAMP_FORMAT”](#) on page 587.

TOTALORDER

The TOTALORDER function returns an ordering for DECFLOAT values.

►► TOTALORDER (— *expression-1* — , — *expression-2* —) ►►

The TOTALORDER function returns a small integer value that indicates how *expression-1* compares with *expression-2*.

expression-1

An expression that returns a value of any built-in numeric, character-string, or graphic-string data type. If the argument is not DECFLOAT(34), it is logically converted to DECFLOAT(34) for processing.

expression-2

An expression that returns a value of any built-in numeric, character-string, or graphic-string data type. If the argument is not DECFLOAT(34), it is logically converted to DECFLOAT(34) for processing.

Numeric comparison is exact, and the result is determined for finite operands as if range and precision were unlimited. Overflow or underflow cannot occur.

TOTALORDER determines ordering based on the total order predicate rules of IEEE 754R, with the following result:

- 1 if the first operand is lower in order compared to the second.
- 0 if both operands have the same order.
- 1 if the first operand is higher in order compared to the second.

The ordering of the special values and finite numbers is as follows:

-NAN<-SNAN<-INFINITY<-0.10<-0.100<-0<0<0.100<0.10<INFINITY<SNAN<NAN

The result of the function is SMALLINT. If either argument can be null, the result can be null; if either argument is null, the result is the null value.

Examples

The following examples show the use of the TOTALORDER function to compare decimal floating-point values:

```
TOTALORDER(-INFINITY, -INFINITY) = 0
TOTALORDER(DECFLOAT(-1.0), DECFLOAT(-1.0)) = 0
TOTALORDER(DECFLOAT(-1.0), DECFLOAT(-1.00)) = -1
TOTALORDER(DECFLOAT(-1.0), DECFLOAT(-0.5)) = -1
TOTALORDER(DECFLOAT(-1.0), DECFLOAT(0.5)) = -1
TOTALORDER(DECFLOAT(-1.0), INFINITY) = -1
TOTALORDER(DECFLOAT(-1.0), SNAN) = -1
TOTALORDER(DECFLOAT(-1.0), NAN) = -1
TOTALORDER(NAN, DECFLOAT(-1.0)) = 1
TOTALORDER(-NAN, -NAN) = 0
TOTALORDER(-SNAN, -SNAN) = 0
TOTALORDER(NAN, NAN) = 0
TOTALORDER(SNAN, SNAN) = 0
```

TRANSLATE

The TRANSLATE function returns a value in which one or more characters in *expression* may have been converted into other characters.

►► TRANSLATE (— *expression* →

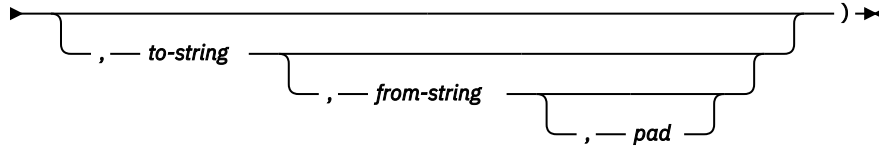

expression

An expression that specifies the string to be converted *expression* must be any built-in numeric or string data type. A numeric argument is cast to a character string before evaluating the function. For more information about converting numeric to a character string, see [“VARCHAR” on page 616](#).

to-string

A string that specifies the characters to which certain characters in *expression* are to be converted. This string is sometimes called the *output translation table*. The string must be any built-in numeric or string constant. A numeric argument is cast to a character string before evaluating the function. For more information about converting numeric to a character string, see [“VARCHAR” on page 616](#). A character string argument must have an actual length that is not greater than 256.

If the actual length of the *to-string* is less than the actual length of the *from-string*, then the *to-string* is padded to the longer length using either the *pad* character if it is specified or a blank if a *pad* character is not specified. If the actual length of the *to-string* is greater than the actual length of the *from-string*, the extra characters in *to-string* are ignored without warning.

from-string

A string that specifies the characters that if found in *expression* are to be converted. This string is sometimes called the *input translation table*. When a character in *from-string* is found, the character in *expression* is converted to the character in *to-string* that is in the corresponding position of the character in *from-string*.

The string must be any built-in numeric or string constant. A numeric argument is cast to a character string before evaluating the function. For more information about converting numeric to a character string, see [“VARCHAR” on page 616](#). A character string argument must have an actual length that is not greater than 256.

If there are duplicate characters in *from-string*, the first one scanning from the left is used and no warning is issued. The default value for *from-string* is a string starting with the character X'00' and ending with the character X'FF' (decimal 255).

pad

A string that specifies the character with which to pad *to-string* if its length is less than *from-string*. The string must be a character string constant with a length of 1. The default is an SBCS blank.

If the first argument is a Unicode graphic or UTF-8 string, no other arguments may be specified.

If only the first argument is specified, the SBCS characters of the argument are converted to uppercase, based on the CCSID of the argument. Only SBCS characters are converted. The characters a-z are converted to A-Z, and characters with diacritical marks are converted to their uppercase equivalent, if any. If the first argument is UTF-16, UCS-2, or UTF-8, the alphabetic UTF-16, UCS-2, or UTF-8 characters are converted to uppercase. Refer to the [UCS-2 level 1 mapping tables](#) topic of the [Globalization](#) topic collection for a description of the monocasing tables that are used for this conversion.

If more than one argument is specified, the result string is built character by character from *expression*, converting characters in *from-string* to the corresponding character in *to-string*. For each character in *expression*, the same character is searched for in *from-string*. If the character is found to be the *n*th

character in *from-string*, the resulting string will contain the *n*th character from *to-string*. If *to-string* is less than *n* characters long, the resulting string will contain the pad character. If the character is not found in *from-string*, it is moved to the result string unconverted.

Conversion is done on a byte basis and, if used improperly, may result in an invalid mixed string. The SRTSEQ attribute does not apply to the TRANSLATE function.

The result of the function has the same data type, length attribute, actual length, and CCSID as the argument. If the first argument can be null, the result can be null. If the argument is null, the result is the null value.

Examples

- Monocase the string 'abcdef'.

```
SELECT TRANSLATE('abcdef')
FROM SYSIBM.SYSDUMMY1
```

Returns the value 'ABCDEF'.

- Monocase the mixed character string.

```
SELECT TRANSLATE('abs0Cs1def')
FROM SYSIBM.SYSDUMMY1
```

Returns the value 'AB^s0C^s1DEF'

- Given that the host variable SITE is a varying-length character string with a value of 'Pivabiska Lake Place'.

```
SELECT TRANSLATE(:SITE, '$', 'L')
FROM SYSIBM.SYSDUMMY1
```

Returns the value 'Pivabiska \$ake Place'.

```
SELECT TRANSLATE(:SITE, '$$', 'L1')
FROM SYSIBM.SYSDUMMY1
```

Returns the value 'Pivabiska \$ake P\$ace'.

```
SELECT TRANSLATE(:SITE, 'pLA', 'Place', '.')
FROM SYSIBM.SYSDUMMY1
```

Returns the value 'pivAbiskA LAk. pLA..'

TRIM

The TRIM function removes blanks or another specified character from the end, from the beginning, or from both of a string expression.

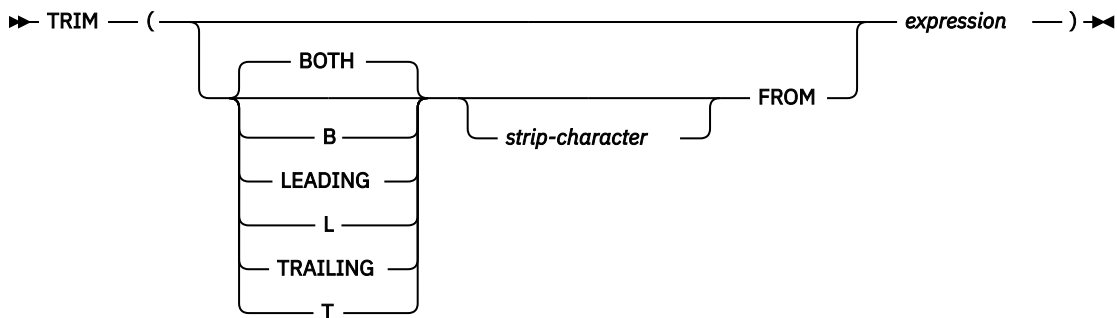

The first argument, if specified, indicates whether characters are removed from the end or beginning of the string. If the first argument is not specified, then the characters are removed from both the end and the beginning of the string.

strip-character

The second argument, if specified, is a single-character constant that indicates the binary, SBCS, or DBCS character that is to be removed. If *expression* is a binary string, the second argument must be a binary string constant. If *expression* is a DBCS graphic or DBCS-only string, the second argument must be a graphic constant consisting of a single DBCS character. If the second argument is not specified then:

- If *expression* is a binary string, then the default strip character is a hexadecimal zero (X'00').
- If *expression* is a DBCS graphic string, then the default strip character is a DBCS blank.
- If *expression* is a Unicode graphic string, then the default strip character is a UTF-16 or UCS-2 blank.
- If *expression* is a UTF-8 character string, then the default strip character is a UTF-8 blank.
- Otherwise, the default strip character is an SBCS blank.

expression

An expression that returns a value of any built-in numeric or string data type. A numeric argument is cast to a character string before evaluating the function. For more information about converting numeric to a character string, see [“VARCHAR” on page 616](#).

The data type of the result depends on the data type of *expression*:

Data type of <i>expression</i>	Data type of the Result
CHAR or VARCHAR	VARCHAR
CLOB	CLOB
GRAPHIC or VARGRAPHIC	VARGRAPHIC
DBCLOB	DBCLOB
BINARY or VARBINARY	VARBINARY
BLOB	BLOB

The length attribute of the result is the same as the length attribute of *expression*. The actual length of the result is the length of the expression minus the number of bytes removed. If all characters are removed, the result is an empty string.

If the first argument can be null, the result can be null; if the first argument is null, the result is the null value.

The CCSID of the result is the same as that of the string.

The SRTSEQ attribute does not apply to the TRIM function.

Examples

- Assume the host variable HELLO of type CHAR(9) has a value of ' Hello '.

```
SELECT TRIM(:HELLO), TRIM( TRAILING FROM :HELLO)
FROM SYSIBM.SYSDUMMY1
```

Results in 'Hello' and ' Hello' respectively.

- Assume the host variable BALANCE of type CHAR(9) has a value of '000345.50'.

```
SELECT TRIM( L '0' FROM :BALANCE )
FROM SYSIBM.SYSDUMMY1
```

Results in: '345.50'

- Assume the string to be stripped contains mixed data.

```
SELECT TRIM( BOTH 'S' 'I' FROM 'S' 'AB C' 'I' )
FROM SYSIBM.SYSDUMMY1
```

Results in: 'S'AB C'I'

TRIM_ARRAY

The TRIM_ARRAY function returns a copy of the array argument from which the specified number of elements have been removed from the end of the array.

►► TRIM_ARRAY (— *array-variable-name* — , — *numeric-constant* —) ◄◄
numeric-variable

array-variable-name

Identifies an SQL variable or parameter. The variable or parameter must be an array type.

numeric-constant or numeric-variable

Specifies the number of elements that will be trimmed from the copy of *array-variable-name*. This must be a constant or SQL variable or parameter that can be cast to the integer data type. The value must be between 0 and the cardinality of *array-variable-name*.

The result array type is identical to the array type of the first argument but with the cardinality decreased by the number of elements trimmed.

The result can be null; if either argument is null, the result is the null value.

TRIM_ARRAY can only be used in an SQL procedure or SQL function as the only expression on the right side of an *assignment-statement*.

Note

Syntax alternatives: ARRAY_TRIM can be specified as a synonym for TRIM_ARRAY.

Example

Assume that array type PHONENUMBERS and array variable RECENT_CALLS are defined as follows:

```
CREATE TYPE PHONENUMBERS AS INTEGER ARRAY[50];  
DECLARE RECENT_CALLS PHONENUMBERS;
```

The following statement removes the last element from the array variable RECENT_CALLS.

```
SET RECENT_CALLS = TRIM_ARRAY(RECENT_CALLS, 1)
```

TRUNCATE or TRUNC

The TRUNCATE function returns *expression-1* truncated to some number of places to the right or left of the decimal point.

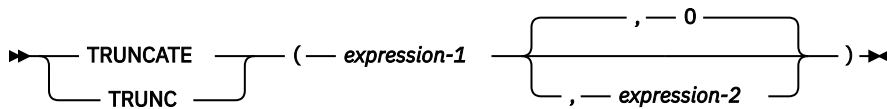

expression-1

An expression that returns a value of any built-in numeric, character-string, or graphic-string data type. A string argument is converted to double-precision floating point before evaluating the function. For more information about converting strings to double-precision floating point, see [“DOUBLE_PRECISION or DOUBLE”](#) on page 391.

If *expression-1* is a decimal floating-point data type, the DECFLOAT ROUNDING MODE will not be used. The rounding behavior of TRUNCATE corresponds to a value of ROUND_DOWN. If a different rounding behavior is wanted, use the QUANTIZE function.

expression-2

An expression that returns a value of a built-in small integer, large integer, or big integer data type. The absolute value of integer specifies the number of places to the right of the decimal point for the result if *expression-2* is not negative, or to the left of the decimal point if *expression-2* is negative.

If *expression-2* is not negative, *expression-1* is truncated to the *expression-2* number of places to the right of the decimal point.

If *expression-2* is negative, *expression-1* is truncated to the absolute value of *expression-2*+1 number of places to the left of the decimal point.

If *expression-2* is not specified, *expression-1* is truncated to zero places to the left of the decimal point.

If the absolute value of *expression-2* is larger than the number of digits to the left of the decimal point, the result is 0. For example, TRUNCATE(748.58,-4) = 0.

The data type and length attribute of the result are the same as the data type and length attribute of the first argument.

If either argument can be null, the result can be null. If either argument is null, the result is the null value.

Examples

- Calculate the average monthly salary for the highest paid employee. Truncate the result to two places to the right of the decimal point.

```
SELECT TRUNCATE(MAX(SALARY/12) , 2)
FROM EMPLOYEE
```

Because the highest paid employee in the sample employee table earns \$52750.00 per year, the example returns the value 4395.83.

- Calculate the number 873.726 truncated to 2, 1, 0, -1, -2, and -3 decimal places respectively.

```
SELECT TRUNCATE(873.726, 2),
       TRUNCATE(873.726, 1),
       TRUNCATE(873.726, 0),
       TRUNCATE(873.726, -1),
       TRUNCATE(873.726, -2),
       TRUNCATE(873.726, -3)
FROM SYSIBM.SYSDUMMY1
```

Returns the following values respectively:

```
0873.720  0873.700  0873.000  0870.000  0800.000  0000.000
```

- Calculate both positive and negative numbers.

```
SELECT TRUNCATE( 3.5, 0),  
       TRUNCATE( 3.1, 0),  
       TRUNCATE(-3.1, 0),  
       TRUNCATE(-3.5, 0)  
FROM SYSIBM.SYSDUMMY1
```

This example returns:

```
3.0  3.0  -3.0  -3.0
```

respectively.

TRUNC_TIMESTAMP

The TRUNC_TIMESTAMP function returns a timestamp that is the *expression* truncated to the unit specified by the *format-string*. If *format-string* is not specified, *expression* is truncated to the nearest day, as if 'DD' was specified for *format-string*.

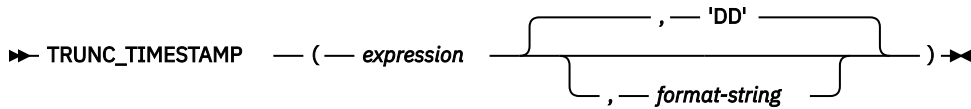

expression

An expression that returns a value of one of the following built-in data types: a date, a timestamp, a character-string, or a graphic-string.

If *expression* is a character or graphic string, its value must be a valid string representation of a date or timestamp. It is first converted to a TIMESTAMP(12) value. For the valid formats of string representations of dates and timestamps, see [“String representations of datetime values”](#) on page 75.

format-string

An expression that returns a built-in character string data type or graphic string data type. *format-string* contains a template of how *expression* should be truncated. For example, if *format-string* is 'DD', a timestamp that is represented by *expression* is truncated to the nearest day. Leading and trailing blanks are removed from the string, and the resulting substring must be a valid template for a timestamp. The resulting value is then folded to uppercase, so the characters in the value may be in any case. Allowable values for *format-string* are listed in [Table 56](#) on page 550.

The result of the function is a timestamp with a timestamp precision of:

- *p* when the data type of *expression* is TIMESTAMP(*p*)
- 0 when the data type of *expression* is DATE
- 6 otherwise.

If either argument can be null, the result can be null; if either argument is null, the result is the null value.

Example

- Set the host variable TRN_TMSTMP with the current year truncated to the nearest year value.

```
SET :TRN_TMSTMP = TRUNC_TIMESTAMP('2000-03-14-17.30.00', 'YEAR');
```

Host variable TRN_TMSTMP is set with the value 2000-01-01-00.00.00.000000.

UCASE

The UCASE function returns a string in which all the characters have been converted to uppercase characters, based on the CCSID of the argument.

►► UCASE (— *expression* —) ►◄

The UCASE function is identical to the UPPER function. For more information, see [“UPPER” on page 611](#).

UPPER

The UPPER function returns a string in which all the characters have been converted to uppercase characters, based on the CCSID of the argument. Only SBCS and Unicode graphic characters are converted. The characters a-z are converted to A-Z, and characters with diacritical marks are converted to their uppercase equivalent, if any.

►► UPPER — (— *expression* —) ►►

Refer to the [UCS-2 level 1 mapping tables](#) topic of the [Globalization](#) topic collection for a description of the monocasing tables that are used for this translation.

expression

An expression that specifies the string to be converted. *expression* must be any built-in numeric, character, Unicode graphic string. A numeric argument is cast to a character string before evaluating the function. For more information about converting numeric to a character string, see [“VARCHAR” on page 616](#).

The result of the function has the same data type, length attribute, actual length, and CCSID as the argument. If the argument can be null, the result can be null; if the argument is null, the result is the null value.

Note

Syntax alternatives: UCASE is a synonym for UPPER.

Examples

- Uppercase the string 'abcdef' using the UPPER scalar function.

```
SELECT UPPER('abcdef')
FROM SYSIBM.SYSDUMMY1
```

Returns the value 'ABCDEF'.

- Uppercase the mixed character string using the UPPER scalar function.

```
SELECT UPPER('abs0Cs1def')
FROM SYSIBM.SYSDUMMY1
```

Returns the value: 'AB^s0C^s1DEF'

VALUE

The VALUE function returns the value of the first non-null expression.

► VALUE (*expression* , *expression*) ◄

The VALUE function is identical to the COALESCE scalar function. For more information, see [“COALESCE” on page 337](#).

Note

Syntax alternatives: COALESCE should be used for conformance to the SQL 2003 standard.

VARBINARY

The VARBINARY function returns a VARBINARY representation of a string of any type.

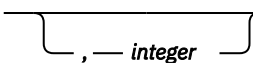
►► VARBINARY ((— *string-expression* ) ►►

The result of the function is VARBINARY. If the first argument can be null, the result can be null; if the first argument is null, the result is the null value.

string-expression

A *string-expression* whose value can be a character string, graphic string, binary string, or row ID.

integer

An integer constant that specifies the length attribute for the resulting binary string. The value must be between 1 and 32740 (32739 if nullable).

If *integer* is not specified:

- If the *string-expression* is the empty string constant, the length attribute of the result is 1.
- Otherwise, the length attribute of the result is the same as the length attribute of the first argument, unless the argument is a graphic string. In this case, the length attribute of the result is twice the length attribute of the argument.

The actual length of the result is the minimum of the length attribute of the result and the actual length of the expression (or twice the length of the expression when the input is graphic data). If the length of the *string-expression* is greater than the length attribute of the result, truncation is performed. A warning (SQLSTATE 01004) is returned unless the first input argument is a character string and all the truncated characters are blanks, or the first input argument is a graphic string and all the truncated characters are double-byte blanks, or the first input argument is a binary string and all the truncated bytes are hexadecimal zeroes.

Note

Syntax alternatives: The CAST specification should be used to increase the portability of applications when the length is specified. For more information, see [“CAST specification”](#) on page 177.

Example

- The following function returns a VARBINARY for the string 'This is a VARBINARY'.

```
SELECT VARBINARY('This is a VARBINARY')
FROM SYSIBM.SYSDUMMY1
```

VARBINARY_FORMAT

The VARBINARY_FORMAT function returns a binary string representation of a character string that has been formatted using a *format-string*.

➔ VARBINARY_FORMAT (*expression* , *format-string*) ➔

expression

An expression that returns a value of any built-in numeric, character-string, or graphic-string data type. A numeric or graphic argument is cast to a character string before evaluating the function. For more information about converting numeric or graphic to a character string, see “VARCHAR” on page 616.

All leading and trailing blanks are removed from *expression* before evaluating the function.

If a *format-string* is specified, the length of *expression* must be equal to the length of the *format-string* and the value of *expression* must conform to the template specified by the *format-string*. If a *format-string* is not specified, the value of *expression* (after removing leading and trailing blanks) should be an even number of characters from the ranges '0' to '9', 'a' to 'f', and 'A' to 'F'. If the length is an odd number of characters, the string is padded on the right with one '0' character.

format-string

An expression that returns a built-in character string or graphic string data type. *format-string* contains a template for how the value for *expression* is to be interpreted.

The valid format strings are: 'xxxxxxxx-xxxx-xxxx-xxxx-xxxxxxxxxxxx' and 'XXXXXXXX-XXXX-XXXX-XXXX-XXXXXXXXXXXX' where each 'x' or 'X' corresponds to one hexadecimal digit in the result. If 'X' is specified, the corresponding hexadecimal digit must not be a lower case character. If 'x' is specified, the corresponding hexadecimal digit must not be an upper case character.

The result of the function is a varying-length binary string. The length attribute of the result is half the length attribute of *expression*. If a *format-string* is not specified, the actual length is half the actual length of *expression* (after leading and trailing blanks have been removed and padding to an even number of characters). If a *format-string* is specified, the actual length is half the actual length of the *format-string* (after removing the non-digit separator characters). If either argument can be null, the result can be null; if either argument is null, the result is the null value.

Note

Syntax alternatives: HEXTORAW is a synonym for VARBINARY_FORMAT except that if the length of *expression* is an odd number of characters, the string is padded on the left with one '0' character. VARCHAR_BIT_FORMAT is a synonym for VARBINARY_FORMAT except that the result of the function is a varying-length character string FOR BIT DATA.

Example

- Represent a Universal Unique Identifier in its binary form:

```
VALUES VARBINARY_FORMAT('d83d6360-1818-11db-9804-b622a1ef5492',
                          'xxxxxxxx-xxxx-xxxx-xxxx-xxxxxxxxxxxx')
```

Result returned:

```
BX'D83D6360181811DB9804B622A1EF5492'
```

- Represent a Universal Unique Identifier in its binary form:

```
VALUES VARBINARY_FORMAT('D83D6360-1818-11DB-9804-B622A1EF5492',
                          'XXXXXXXX-XXXX-XXXX-XXXX-XXXXXXXXXXXX')
```

Result returned:

```
BX'D83D6360181811DB9804B622A1EF5492'
```

- Represent a string of hexadecimal characters in binary form:

```
VALUES VARBINARY_FORMAT('ef01abC9')
```

Result returned:

```
BX'EF01ABC9'
```

VARCHAR

The VARCHAR function returns a character-string representation.

Integer to Varchar

►► VARCHAR (— *integer-expression* —) ►►

Decimal to Varchar

►► VARCHAR (— *decimal-expression* — , — *decimal-character* —) ►►

Floating-point to Varchar

►► VARCHAR (— *floating-point-expression* — , — *decimal-character* —) ►►

Decimal floating-point to Varchar

►► VARCHAR (— *decimal-floating-point-expression* — , — *decimal-character* —) ►►

Character to Varchar

►► VARCHAR (— *character-expression* — , — *length* — , — *integer* —) ►►
►►) ►►

Graphic to Varchar

►► VARCHAR (— *graphic-expression* — , — *length* — , — *integer* —) ►►

Datetime to Varchar

►► VARCHAR (— *datetime-expression* — , — *ISO* —) ►►
 — *USA* —
 — *EUR* —
 — *JIS* —
 — *LOCAL* —

The VARCHAR function returns a character-string representation of:

- An integer number if the first argument is a SMALLINT, INTEGER, or BIGINT.
- A decimal number if the first argument is a packed or zoned decimal number.
- A double-precision floating-point number if the first argument is a DOUBLE or REAL.
- A decimal floating-point number if the first argument is DECFLOAT.

- A character string if the first argument is any type of character string.
- A graphic string if the first argument is any graphic string.
- A date value if the first argument is a DATE.
- A time value if the first argument is a TIME.
- A timestamp value if the first argument is a TIMESTAMP.

The result of the function is a varying-length string. If the first argument can be null, the result can be null; if the first argument is null, the result is the null value.

Integer to Varchar

integer-expression

An expression that returns a value that is an integer data type (either SMALLINT, INTEGER, or BIGINT).

The result is a varying-length character string of the argument in the form of an SQL integer constant. The result consists of n characters that are the significant digits that represent the value of the argument with a preceding minus sign if the argument is negative. It is left justified.

- If the argument is a small integer, the length attribute of the result is 6.
- If the argument is a large integer, the length attribute of the result is 11.
- If the argument is a big integer, the length attribute of the result is 20.

The actual length of the result is the smallest number of characters that can be used to represent the value of the argument. Leading zeroes are not included. If the argument is negative, the first character of the result is a minus sign. Otherwise, the first character is a digit.

The CCSID of the result is the default SBCS CCSID at the current server.

Decimal to Varchar

decimal-expression

An expression that returns a value that is a packed or zoned decimal data type (either DECIMAL or NUMERIC). If a different precision and scale is wanted, the DECIMAL scalar function can be used to make the change.

decimal-character

Specifies the single-byte character constant that is used to delimit the decimal digits in the result character string. The character must be a period or comma. If the second argument is not specified, the decimal point is the default decimal point. For more information, see [“Decimal point” on page 118](#).

The result is a varying-length character string representation of the argument. The result includes a decimal character and up to p digits, where p is the precision of the *decimal-expression* with a preceding minus sign if the argument is negative. Leading zeros are not returned. Trailing zeros are returned. If the scale of *decimal-expression* is zero, the decimal character is not returned.

The length attribute of the result is $2+p$ where p is the precision of the *decimal-expression*. The actual length of the result is the smallest number of characters that can be used to represent the result, except that trailing characters are included. Leading zeros are not included. If the argument is negative, the result begins with a minus sign. Otherwise, the result begins with a digit or the *decimal-character*.

The CCSID of the result is the default SBCS CCSID at the current server.

Floating-point to Varchar

floating-point expression

An expression that returns a value that is a floating-point data type (DOUBLE or REAL).

decimal-character

Specifies the single-byte character constant that is used to delimit the decimal digits in the result character string. The character must be a period or comma. If the second argument is not specified, the decimal point is the default decimal point. For more information, see [“Decimal point” on page 118](#).

The result is a varying-length character string representation of the argument in the form of a floating-point constant.

The length attribute of the result is 24. The actual length of the result is the smallest number of characters that can represent the value of the argument such that the mantissa consists of a single digit other than zero followed by the *decimal-character* and a sequence of digits. If the argument is negative, the first character of the result is a minus sign; otherwise, the first character is a digit or the *decimal-character*. If the argument is zero, the result is 0E0.

The CCSID of the result is the default SBCS CCSID at the current server.

Decimal floating-point to Varchar***decimal-floating-point expression***

An expression that returns a value that is a decimal floating-point data type.

decimal-character

Specifies the single-byte character constant that is used to delimit the decimal digits in the result character string. The character must be a period or comma. If the second argument is not specified, the decimal point is the default decimal point. For more information, see [“Decimal point” on page 118](#).

The result is a varying-length character string representation of the argument in the form of a decimal floating-point constant.

The length attribute of the result is 42. The actual length of the result is the smallest number of characters that represents the value of the argument, including the sign, digits, and *decimal-character*. Trailing zeros are significant. If the argument is negative, the first character of the result is a minus sign; otherwise, the first character is a digit or the *decimal-character*. If the argument is zero, the result is 0.

If the DECFLOAT value is Infinity, sNaN, or NaN, the strings 'INFINITY', 'SNAN', and 'NAN', respectively, are returned. If the special value is negative, a minus sign will be the first character in the string. The DECFLOAT special value sNaN does not result in an exception when converted to a string.

The CCSID of the result is the default SBCS CCSID at the current server.

Character to Varchar***character-expression***

An expression that returns a value that is a built-in CHAR, VARCHAR, or CLOB data type.⁷⁶

length

An integer constant that specifies the length attribute for the resulting varying length character string. The value must be between 1 and 32740 (32739 if nullable). If the first argument is DBCS-only mixed data, the second argument cannot be less than 4.

If the second argument is not specified or DEFAULT is specified:

- If the *character-expression* is an empty string constant, the length attribute of the result is 1.
- Otherwise, the length attribute of the result is the same as the length attribute of the first argument.

The actual length of the result is the minimum of the length attribute of the result and the actual length of *character-expression*. If the length of the *character-expression* is greater than the length attribute of the result, truncation is performed. A warning (SQLSTATE 01004) is returned unless the truncated characters were all blanks.

⁷⁶ A binary string is also allowed if a CCSID is not specified or if a CCSID of 65535 is explicitly specified.

integer

An integer constant that specifies the CCSID of the result. It must be a valid SBCS CCSID, mixed data CCSID, or 65535 (bit data). If the third argument is an SBCS CCSID, then the result is SBCS data. If the third argument is a mixed CCSID, then the result is mixed data and the length attribute of the result cannot be less than 4. If the third argument is 65535, then the result is bit data. If the third argument is a SBCS CCSID, then the first argument cannot be a DBCS-either or DBCS-only string.

If the third argument is not specified then:

- If the first argument is SBCS data, then the result is SBCS data. The CCSID of the result is the same as the CCSID of the first argument.
- If the first argument is mixed data and the length attribute of the result is greater than or equal to 4, then the result is mixed data. The CCSID of the result is the same as the CCSID of the first argument.
- If the first argument is mixed data that is DBCS-open or DBCS-either and the length attribute of the result is less than 4, the CCSID of the result is the associated SBCS CCSID for the mixed data CCSID.

Graphic to Varchar

graphic-expression

An expression that returns a value that is a GRAPHIC, VARGRAPHIC, and DBCLOB data type. It must not be DBCS-graphic data.

length

An integer constant that specifies the length attribute for the resulting varying length character string. The value must be between 1 and 32740 (32739 if nullable). If the first argument contains DBCS data, the second argument cannot be less than 4.

If the second argument is not specified or DEFAULT is specified, the length attribute of the result is determined as follows (where n is the length attribute of the first argument):

- If the *graphic-expression* is the empty graphic string constant, the length attribute of the result is 1.
- If the result is SBCS data, the result length is n .
- If the result is mixed data, the result length is $(2.5*(n-1)) + 4$.

The actual length of the result is the minimum of the length attribute of the result and the actual length of *graphic-expression*. If the length of the *character-expression* is greater than the length attribute of the result, truncation is performed. A warning (SQLSTATE 01004) is returned unless the truncated characters were all blanks.

integer

An integer constant that specifies the CCSID of the result. It must be a valid SBCS CCSID or mixed data CCSID. If the third argument is an SBCS CCSID, then the result is SBCS data. If the third argument is a mixed CCSID, then the result is mixed data and the length attribute of the result cannot be less than 4. The third argument cannot be 65535.

If the third argument is not specified, the CCSID of the result is the default CCSID at the current server. If the default CCSID is mixed data and the length attribute of the result is greater than or equal to 4, then the result is mixed data. Otherwise, the result is SBCS data.

Datetime to Varchar

datetime-expression

An expression that is one of the following three built-in data types

date

The result is the varying-length character string representation of the date in the format specified by the second argument. If the second argument is not specified, the format used is the default date format. If the format is ISO, USA, EUR, or JIS, the length attribute and actual length of the result is 10. Otherwise the length attribute and actual length of the result is the length of the default date format. For more information see [“String representations of datetime values”](#) on page 75.

time

The result is the varying-length character string representation of the time in the format specified by the second argument. If the second argument is not specified, the format used is the default time format. The length attribute and actual length of the result is 8. For more information see [“String representations of datetime values” on page 75](#).

timestamp

The second argument is not applicable and must not be specified.

The result is the varying-length character string representation of the timestamp. If *datetime-expression* is a `TIMESTAMP(0)`, the length attribute and actual length of the result is 19. If the data type of *datetime-expression* is a `TIMESTAMP(n)`, the length attribute and actual length of the result is $20+n$. Otherwise, the length attribute and actual length of the result is 26.

The CCSID of the string is the default SBCS CCSID at the current server.

ISO, EUR, USA, or JIS

Specifies the date or time format of the resulting character string. For more information, see [“String representations of datetime values” on page 75](#).

LOCAL

Specifies that the date or time format of the resulting character string should come from the `DATFMT`, `DATSEP`, `TIMFMT`, and `TIMSEP` attributes of the job at the current server.

Note

Syntax alternatives: The `CAST` specification should be used to increase the portability of applications when the first argument is a string and the length argument is specified. For more information, see [“CAST specification” on page 177](#).

Example

- Make `EMPNO` varying-length with a length of 10.

```
SELECT VARCHAR(EMPNO,10)
INTO :VARHV
FROM EMPLOYEE
```

VARCHAR_BIT_FORMAT

The VARCHAR_BIT_FORMAT function returns a character string representation of a character string that has been formatted using a *format-string*.

►► VARCHAR_BIT_FORMAT (— *expression* — , — *format-string* —) ►►

The VARCHAR_BIT_FORMAT function is identical to VARBINARY_FORMAT except that the result of the function is a varying-length character string FOR BIT DATA. For more information, see [“VARBINARY_FORMAT” on page 614](#).

VARCHAR_FORMAT

The VARCHAR_FORMAT function returns a character string representation of the first argument in the format indicated by the optional *format-string*.

Character to Varchar

➤ VARCHAR_FORMAT (— *string-expression* —) ➤

Timestamp to Varchar

➤ VARCHAR_FORMAT (— *timestamp-expression* — , — *format-string* —) ➤

Numeric to Varchar

➤ VARCHAR_FORMAT (— *numeric-expression* — , — *format-string* —) ➤

If any argument of the VARCHAR_FORMAT function can be null, the result can be null; if any argument is null, the result is the null value.

Character to Varchar

string-expression

An expression that returns a value that is a built-in character-string or graphic-string data type.

If the argument is a character string:

- The length attribute of the result and the actual length are determined as follows:
 - If *string-expression* is an empty string constant, the length attribute of the result is 1.
 - Otherwise, the length attribute and the actual length of the result is the same as the length attribute of *string-expression*.
 - The actual length of the result is the minimum of the length attribute of the result and the actual length of *string-expression*.
- The CCSID of the result is determined as follows:
 - If *string-expression* is SBCS data, then the result is SBCS data. The CCSID of the result is the same as the CCSID of *string-expression*.
 - If *string-expression* is mixed data (DBCS-open, DBCS-only, or DBCS-either), then the result is mixed data. The CCSID of the result is the same as the CCSID of *string-expression*.

If the argument is a graphic string, it must not be DBCS-graphic data.

- The length attribute and the actual length of the result is determined as follows (where *n* is the length attribute of *string-expression*):
 - If *string-expression* is the empty graphic string constant, the length attribute of the result is 1.
 - If the result is SBCS data, the length attribute of the result is *n*.
 - If the result is mixed data, the length attribute of the result is $(2.5*(n-1)) + 4$.
 - The actual length of the result is the minimum of the length attribute of the result and the actual length of *string-expression*.
- The CCSID of the result is the default CCSID at the current server. If the default CCSID is mixed data, then the result is mixed data. If the default CCSID is SBCS data, then the result is SBCS data.

Timestamp to Varchar

timestamp-expression

An expression that returns a value of one of the following built-in data types: a date, a timestamp, a character string, or a graphic string. If the argument is a DATE, it is first converted to a TIMESTAMP(0) value, assuming a time of exactly midnight (00.00.00).

If *timestamp-expression* is a character or graphic string, the value of *timestamp-expression* must be a valid string representation of a date or timestamp. It is first converted to a TIMESTAMP(12) value. For the valid formats of string representations of timestamps, see [“String representations of datetime values”](#) on page 75.

If the argument is a string, the *format-string* argument must also be specified.

format-string

An expression that returns a built-in character string data type or graphic string data type. If the value is not a CHAR or VARCHAR data type, it is implicitly cast to VARCHAR before evaluating the function. *format-string* contains a template of how *timestamp-expression* is to be formatted. The resulting value may contain characters in any case. A valid format is any combination of the formats listed below optionally separated by valid separators. Valid separators are:

- minus sign (-)
- period (.)
- slash (/)
- comma (,)
- apostrophe (')
- semicolon (;)
- colon (:)
- blank ()

Format	Unit
AM or PM ^{1, 2}	Meridian indicator (morning or evening) without periods. The meridian indicator that is returned is based on the language used for messages in the job. This meridian indicator is retrieved from message CPX9035 in message file QCPFMSG in library *LIBL.
A.M. or P.M. ^{1, 2}	Meridian indicator (morning or evening) with periods. This format element uses the exact strings 'A.M.' or 'P.M.' and is independent of the language used for messages in the job.
CC	Century (00-99). If the last two digits of the four digit year are zero, the result is the first two digits of the year. Otherwise, the result is the first two digits of the year plus one.
DAY, Day, or day ^{1, 2}	Name of the day in uppercase, titlecase, or lowercase format. The name of the day that is returned is based on the language used for messages in the job. This name of the day is retrieved from message CPX9034 in message file QCPFMSG in library *LIBL.
DY, Dy, or dy ^{1, 3}	Abbreviated name of the day in uppercase, titlecase, or lowercase format. The abbreviated name of the day is retrieved from message CPX9039 in message file QCPFMSG in library *LIBL.
D ¹	Day of week (1-7), where 1 is Sunday.
DD	Day of month (01-31).
DDD	Day of year (001-366).

Table 61. Format elements for the VARCHAR_FORMAT (Timestamp to VARCHAR) function (continued)

Format	Unit
FF or FF n	Fractional seconds (0-999999999999). The number n is used to specify the number of digits to include in the value returned. Valid values for n are 1-12. The default is 6.
HH	HH behaves the same as HH12.
HH12	Hour of the day (01-12) in 12-hour format.
HH24	Hour of the day (00-24) in 24-hour format.
ID	ISO day of week (1-7), where 1 is Monday and 7 is Sunday
IW	ISO week of year (01-53). The week starts on Monday and includes 7 days. Week 1 is the first week of the year to contain a Thursday, which is equivalent to the first week of the year to contain January 4
I	ISO year (0-9). The last digit of the year based on the ISO week that is returned.
IY	ISO year (00-99). The last two digits of the year based on the ISO week that is returned.
IYY	ISO year (000-999). The last three digits of the year based on the ISO week that is returned.
IYYY	ISO year (0000-9999). The year based on the ISO week that is returned.
J	Julian date (0000000-9999999).
MI	Minute (00-59).
MM	Month (01-12).
MONTH, Month, or month ^{1,3}	Name of the month in uppercase, titlecase, or lowercase format. The name of the month that is returned is based on the language used for messages in the job. This name of the month is retrieved from message CPX3BC0 in message file QCPFMSG in library *LIBL.
MON, Mon, or mon ^{1,3}	Abbreviated name of the month in uppercase, titlecase, or lowercase format. The name of the month that is returned is based on the language used for messages in the job. This name of the month is retrieved from message CPX8601 in message file QCPFMSG in library *LIBL.
MS	Milliseconds (000-999). Same as FF3.
NNNNNN	Microseconds (000000-999999). Same as FF6.
Q	Quarter (1-4).
RR	RR behaves the same as YY.
RRRR	RRRR behaves the same as YYYY.
SS	Seconds (00-59).
SSSSS	Seconds since previous midnight (00000-86400).
US	Microseconds (000000-999999). Same as FF6.
W	Week of month (1-5). Week 1 starts on the first day of the month and ends on the seventh day.
WW	Week of the year (01-53), where week 1 starts on January 1 and ends on January 7.

Table 61. Format elements for the VARCHAR_FORMAT (Timestamp to VARCHAR) function (continued)

Format	Unit
Y	Last digit of the year (0-9).
YY	Last two digits of the year (00-99).
YYY	Last three digits of the year (000-999).
YYYY	Year (0000-9999).

Notes:

1. This format element is case sensitive. In cases where the format elements are ambiguous, the case insensitive format elements will be considered first.
2. The AM and PM set of meridian indicators can be used interchangeably in the *format-string*, as can A.M. and P.M. The result string will contain the appropriate meridian indicator for the actual time value.
3. Only these exact spellings and case combinations can be used. If this format element is specified in an invalid case combination an error is returned.

Examples of valid format strings are:

```
'HH24-MI-SS'  
'HH24-MI-SS-NNNNNN'  
'YYYY-MM-DD'  
'YYYY-MM-DD-HH24-MI-SS'  
'YYYY-MM-DD-HH24-MI-SS-NNNNNN'  
'FF3.J/Q-YYYY'
```

The result is a representation of *timestamp-expression* in the format specified by *format-string*. *format-string* is interpreted as a series of format elements that can be separated by one or more separator characters. A string of characters in *format-string* is interpreted as the longest format element that matches an element in the previous table. If two format elements are composed of the same character and they are not separated by a separator character, the specification is interpreted, starting from the left, as the longest element that matches an element from the previous table, and continues until matches are found for the remainder of the format string. For example, DDYYYY would be interpreted as DD followed by YYYY, rather than D followed by DY, followed by YYY.

If *format-string* is not specified, *timestamp-expression* is returned as the varying-length character string representation of the timestamp.

The data type of the result is varying-length character or varying-length graphic based on the data type of the *format-string*. The length attribute of the result is the maximum of 255 and the length attribute of the *format-string*. *format-string* also determines the actual length of the result. The actual length must not be greater than the length attribute of the result.

The CCSID of the result is same as the CCSID of the *format-string*. If *format-string* is not specified, the CCSID of the result is the default SBCS CCSID at the current server.

Numeric to Varchar

numeric-expression

An expression that returns a value of any built-in numeric data type. If the argument is not a decimal floating-point value, it is converted to DECFLOAT(34) for processing.

format-string

An expression that returns a built-in character string, graphic string, or numeric data type. If the value is not a CHAR or VARCHAR data type, it is implicitly cast to VARCHAR before evaluating the function. *format-string* contains a template of how *numeric-expression* is to be formatted. A *format-string* must contain a valid combination of the listed format elements according to the following rules:

- A sign format element ('S', 'MI', 'PR') can be specified only one time.
- A decimal point format element can be specified only one time.

- Alphabetic format elements must be specified in upper case.
- A prefix format element can only be specified at the beginning of the format string, before any format elements that are not prefix format elements. When multiple prefix format elements are specified they can be specified in any order.
- A suffix format element can only be specified at the end of the format string, after any format elements that are not suffix format elements. When multiple suffix format elements are specified they can be specified in any order.
- A comma or G format element must not be the first format element that is not a prefix format element. There can be any number of comma or G format elements.
- Blanks must not be specified between format elements. Leading and trailing blanks can be specified but are ignored when formatting the result.

Format element	Description
0	Each 0 represents a significant digit. Leading zeros in a number are displayed as zeros.
9	Each 9 represents a significant digit. Leading zeros in a number are displayed as blanks. Only group separators that have at least one digit to the left of the separator are generated.
S	Prefix: If <i>numeric-expression</i> is a negative number, a leading minus sign (-) is included in the result. If <i>numeric-expression</i> is a positive number, a leading plus sign (+) is included in the result.
\$	Prefix: A leading dollar sign (\$) is included in the result.
MI	Suffix: If <i>numeric-expression</i> is a negative number, a trailing minus sign (-) is included in the result. If <i>numeric-expression</i> is a positive number, a trailing blank is included in the result.
PR	Suffix: If <i>numeric-expression</i> is a negative number, a leading less than character (<) and a trailing greater than character (>) are included in the result. If <i>numeric-expression</i> is a positive number, a leading space and a trailing space are included in the result.
,	Specifies that a comma be included in that location in the result. This comma is used as a group separator.
.	Specifies that a period be included in that location in the result. This period is used as a decimal point.
L	Prefix or Suffix: Specifies that the local currency symbol be included in that location in the result. The currency symbol is retrieved from message CPX8416 in message file QCPFMSG in library *LIBL.
D	Specifies that the local decimal point character be included in that location in the result. The decimal character is retrieved from message CPX8416 in message file QCPFMSG in library *LIBL.
G	Specifies that the local group separator character be included in that location in the result. If the local decimal character as retrieved from message CPX8416 in message file QCPFMSG in library *LIBL is a period, the group separator will be a comma. If the local decimal character is a comma, the group separator will be a period.

If *format-string* is not specified, the function is equivalent to VARCHAR(DECFLOAT(*numeric-expression*)).

The result is a representation of the *numeric-expression* value (which might be rounded) in the format that is specified by *format-string*. Prior to being formatted, the value of *numeric-expression* is rounded by using

the ROUND function if the number of digits to the right of the decimal point is greater than the number of digit format elements ('0' or '9') to the right of the decimal point in *format-string*. *format-string* is applied to this *rounded-input-value* according to the following rules:

- The result does not include any digit characters to the left of the decimal point if all of the following conditions are true:
 - $-1 < \textit{rounded-input-value} < 1$
 - *format-string* does not include a '0' format element to the left of the decimal point
 - *format-string* includes at least one digit format element ('0' or '9') to the right of the decimal point
- The result includes a single 0 character immediately before the implicit or explicit decimal point if all of the following conditions are true:
 - The value of *rounded-input-value* is 0 or -0
 - *format-string* includes only the '9' digit format elements to the left of the implicit or explicit decimal point
 - *format-string* does not include any digit format elements to the right of the decimal point
- If *format-string* includes both '0' and '9' format elements to the left of the decimal point, the position of the first digit format element from the left side of the format string determines the presence of leading blanks or zeroes. All '9' format elements specified after the leftmost '0' format element to the left of the implicit or explicit decimal point are treated the same as if a '0' format element had been specified. For example, the *format-string* value '99099' is the same as the value '99000'.
- If the number of digits to the right of the decimal point in *rounded-input-value* is less than the number of digit format elements to the right of the decimal point in *format-string*, the result includes the number of digit characters to the right of the decimal point that corresponds to the number of digit format elements to the right of the decimal point in *format-string*, padded to the right with zeros.
- If the number of digits to the left of the decimal point in *rounded-input-value* is greater than the number of digit format elements to the left of the decimal point in *format-string*, the result is a string of number sign (#) characters that matches the length that *format-string* produces in the result for valid values.
- If the value of *rounded-input-value* represents any of the positive or negative special values, Infinity, sNaN, or NaN, the string 'INFINITY', 'SNAN', 'NAN', '-INFINITY', '-SNAN', or '-NAN' is returned without using the format that is specified by *format-string*. The decimal floating-point special value sNaN does not result in an exception when converted to a string.
- If *format-string* does not include any of the sign format elements 'S', 'MI', or 'PR', and the value of *rounded-input-value* is negative, a minus sign (–) is included in the result. Otherwise, a blank is included in the resulting string. The minus sign or blank immediately precedes the first digit of the result to the left of the decimal point, or the decimal point if there are no digits to the left of the decimal point.

The result is a string representation of *rounded-input-value*. The data type of the result is varying-length character or varying-length graphic based on the data type of the *format-string*. If a single argument is specified the length attribute is 42. Otherwise the length attribute is 254. The actual length of the result is determined by *format-string*, if specified. Otherwise, the actual length of the result is the smallest number of characters that can represent the value of *rounded-input-value*. If the resulting string exceeds the length attribute of the result, the result will be truncated.

The CCSID of the result is the same as the CCSID of the *format-string*. If *format-string* is not specified, the CCSID of the result is the default SBCS CCSID at the current server.

Note

Syntax alternatives: TO_CHAR is a synonym for VARCHAR_FORMAT.

Examples

Example: Timestamp to VARCHAR

- Set the character variable *TVAR* to a string representation of the timestamp value of RECEIVED from CORPDATA.IN_TRAY, formatted as YYYY-MM-DD HH24:MI:SS.

```
SELECT VARCHAR_FORMAT(RECEIVED, 'YYYY-MM-DD HH24:MI:SS')
INTO :TVAR
FROM CORPDATA.IN_TRAY
WHERE SOURCE = 'CHAAS'
```

Returns the string:

```
1988-12-22 14:07:21
```

Assuming that the value in the RECEIVED column is one second before the beginning of the year 2000 (December 31, 1999 at 23:59:59pm), the following string is returned:

```
1999-12-31 23:59:59
```

The result would be different if HH12 had been specified instead of HH24 in the format string:

```
1999-12-31 11:59:59
```

Example: Timestamp to VARCHAR

- Assume that the variable *TMSTAMP* is defined as a *TIMESTAMP* and has the following value: 2007-03-09-14.07.38.123456. The following examples show several invocations of the function and the resulting string values. The result data type in each case is *VARCHAR(255)*.

Function invocation	Result
<code>VARCHAR_FORMAT(TMSTAMP, 'YYYYMMDDHHMISSFF3')</code>	20070309020738123
<code>VARCHAR_FORMAT(TMSTAMP, 'YYYYMMDDHH24MISS')</code>	20070309140738
<code>VARCHAR_FORMAT(TMSTAMP, 'YYYYMMDDHHMI')</code>	200703090207
<code>VARCHAR_FORMAT(TMSTAMP, 'DD/MM/YY')</code>	09/03/07
<code>VARCHAR_FORMAT(TMSTAMP, 'MM-DD-YYYY')</code>	03-09-2007
<code>VARCHAR_FORMAT(TMSTAMP, 'J')</code>	2454169
<code>VARCHAR_FORMAT(TMSTAMP, 'Q')</code>	1
<code>VARCHAR_FORMAT(TMSTAMP, 'W')</code>	2
<code>VARCHAR_FORMAT(TMSTAMP, 'IW')</code>	10
<code>VARCHAR_FORMAT(TMSTAMP, 'WW')</code>	10
<code>VARCHAR_FORMAT(TMSTAMP, 'Month')</code>	March
<code>VARCHAR_FORMAT(TMSTAMP, 'MONTH')</code>	MARCH
<code>VARCHAR_FORMAT(TMSTAMP, 'MON')</code>	MAR

Example: Timestamp to VARCHAR

- Assume that the variable *DTE* is defined as a *DATE* and has the value of '2007-03-09'. The following examples show several invocations of the function and the resulting string values. The result data type in each case is *VARCHAR(255)*:

Function invocation	Result
<code>VARCHAR_FORMAT(DTE, 'YYYYMMDD')</code>	20070309
<code>VARCHAR_FORMAT(DTE, 'YYYYMMDDHH24MISS')</code>	20070309000000

Example: Timestamp to VARCHAR

- Format the hour of the specified string representation of a timestamp:

```
SELECT
  VARCHAR_FORMAT(TIMESTAMP('1979-04-07-14.00.00.000000'), 'HH'),
  VARCHAR_FORMAT(TIMESTAMP('1979-04-07-14.00.00.000000'), 'HH12'),
  VARCHAR_FORMAT(TIMESTAMP('1979-04-07-14.00.00.000000'), 'HH24'),
  VARCHAR_FORMAT(TIMESTAMP('2000-01-01-00.00.00.000000'), 'HH'),
  VARCHAR_FORMAT(TIMESTAMP('2000-01-01-12.00.00.000000'), 'HH'),
  VARCHAR_FORMAT(TIMESTAMP('2000-01-01-24.00.00.000000'), 'HH'),
  VARCHAR_FORMAT(TIMESTAMP('2000-01-01-00.00.00.000000'), 'HH12'),
  VARCHAR_FORMAT(TIMESTAMP('2000-01-01-12.00.00.000000'), 'HH12'),
  VARCHAR_FORMAT(TIMESTAMP('2000-01-01-24.00.00.000000'), 'HH12'),
  VARCHAR_FORMAT(TIMESTAMP('2000-01-01-00.00.00.000000'), 'HH24'),
  VARCHAR_FORMAT(TIMESTAMP('2000-01-01-12.00.00.000000'), 'HH24')
```

```

VARCHAR_FORMAT(TIMESTAMP('2000-01-01-24.00.00.000000'), 'HH24')
FROM SYSIBM.SYSDUMMY1;

```

The previous SELECT statement returns the following values:

```
'02' '02' '14' '12' '12' '12' '12' '12' '12' '12' '00' '12' '24'
```

Example: Numeric to VARCHAR

- Assume that the variables POSNUM and NEGNUM are defined as DECFLOAT(34) and have the following values: '1234.56' and '-1234.56', respectively. The following examples show several invocations of the function and the resulting string values.

Function invocation	Result
-----	-----
VARCHAR_FORMAT(POSNUM)	'1234.56'
VARCHAR_FORMAT(NEGNUM)	'-1234.56'
VARCHAR_FORMAT(POSNUM, '9999.99')	' 1234.56'
VARCHAR_FORMAT(NEGNUM, '9999.99')	'-1234.56'
VARCHAR_FORMAT(POSNUM, '99999.99')	' 1234.56'
VARCHAR_FORMAT(NEGNUM, '99999.99')	'-1234.56'
VARCHAR_FORMAT(POSNUM, '00000.00')	' 01234.56'
VARCHAR_FORMAT(NEGNUM, '00000.00')	'-01234.56'
VARCHAR_FORMAT(POSNUM, '9999.99MI')	'1234.56 '
VARCHAR_FORMAT(NEGNUM, '9999.99MI')	'1234.56-'
VARCHAR_FORMAT(POSNUM, 'S9999.99')	'+1234.56'
VARCHAR_FORMAT(NEGNUM, 'S9999.99')	'-1234.56'
VARCHAR_FORMAT(POSNUM, '9999.99PR')	' 1234.56 '
VARCHAR_FORMAT(NEGNUM, '9999.99PR')	'<1234.56>'
VARCHAR_FORMAT(POSNUM, 'S\$9,999.99')	'+\$1,234.56'
VARCHAR_FORMAT(NEGNUM, 'S\$9,999.99')	'-\$1,234.56'

VARCHAR_FORMAT_BINARY

The VARCHAR_FORMAT_BINARY function returns a character string representation of a bit string that has been formatted using a *format-string*.

►► VARCHAR_FORMAT_BINARY (— *expression* — , — *format-string* —) ►►

expression

An expression that returns a built-in binary string or character FOR BIT DATA string. The length of *expression* must be equal to the number of 'x' or 'X' characters in the *format-string* divided by 2.

format-string

An expression that returns a built-in character string or graphic string data type. *format-string* contains a template for how the value for *expression* is to be formatted.

Valid format strings are: 'xxxxxxxx-xxxx-xxxx-xxxx-xxxxxxxxxxxx' and 'XXXXXXXX-XXXX-XXXX-XXXX-XXXXXXXXXXXX' where each 'x' or 'X' corresponds to one hexadecimal digit from *expression*. If 'x' is specified, the character returned for the corresponding hexadecimal digit will be lower case. Otherwise, the character returned will be upper case.

The result of the function is a varying-length character string with the length attribute and actual length based on the format string. For the two valid format strings, the length attribute and actual length of the result is 36. If either argument can be null, the result can be null; if either argument is null, the result is the null value.

The CCSID of the result is the CCSID of *format-string*.

Note

Syntax alternatives: VARCHAR_FORMAT_BIT is a synonym for VARCHAR_FORMAT_BINARY.

Example

- Represent a Universal Unique Identifier in its formatted form:

```
VALUES VARCHAR_FORMAT_BINARY(BX'd83d6360181811db9804b622a1ef5492',  
                              'xxxxxxxx-xxxx-xxxx-xxxx-xxxxxxxxxxxx')
```

Result returned:

```
'd83d6360-1818-11db-9804-b622a1ef5492'
```

- Represent a Universal Unique Identifier in its formatted form:

```
VALUES VARCHAR_FORMAT_BINARY(BX'd83d6360181811db9804b622a1ef5492',  
                              'XXXXXXXX-XXXX-XXXX-XXXX-XXXXXXXXXXXX')
```

Result returned:

```
'D83D6360-1818-11DB-9804-B622A1EF5492'
```

VARGRAPHIC

The VARGRAPHIC function returns a graphic-string representation.

Integer to Vargraphic

►► VARGRAPHIC — (— *integer-expression* —) ►►

Decimal to Vargraphic

►► VARGRAPHIC — (— *decimal-expression* — , — *decimal-character* —) ►►

Floating-point to Vargraphic

►► VARGRAPHIC — (— *floating-point-expression* — , — *decimal-character* —) ►►

Decimal floating-point to Vargraphic

►► VARGRAPHIC — (— *decimal-floating-point-expression* — , — *decimal-character* —) ►►

Character to Vargraphic

►► VARGRAPHIC — (— *character-expression* — , — *length* — , — *integer* —) ►►

DEFAULT

Graphic to Vargraphic

►► VARGRAPHIC — (— *graphic-expression* — , — *length* — , — *integer* —) ►►

DEFAULT

Datetime to Vargraphic

►► VARGRAPHIC — (— *datetime-expression* — , — *ISO* — , — *USA* — , — *EUR* — , — *JIS* — , — *LOCAL* —) ►►

The VARGRAPHIC function returns a graphic-string representation of

- An integer number if the first argument is a SMALLINT, INTEGER, or BIGINT.

- A decimal number if the first argument is a packed or zoned decimal number.
- A double-precision floating-point number if the first argument is a DOUBLE or REAL.
- A decimal floating-point number if the first argument is DECFLOAT.
- A character string if the first argument is any type of character string.
- A graphic string if the first argument is a Unicode graphic string.
- A date value if the first argument is a DATE.
- A time value if the first argument is a TIME.
- A timestamp value if the first argument is a TIMESTAMP.

The result of the function is a varying-length graphic string (VARGRAPHIC).

If the first argument can be null, the result can be null. If the first argument is null, the result is the null value. If the first argument is an empty string or the EBCDIC string X'0E0F', the result is an empty string.

Integer to Vargraphic

integer-expression

An expression that returns a value that is an integer data type (either SMALLINT, INTEGER, or BIGINT).

The result is a varying-length graphic string of the argument in the form of an SQL integer constant. The result consists of n characters that are the significant digits that represent the value of the argument with a preceding minus sign if the argument is negative. It is left justified.

- If the argument is a small integer, the length attribute of the result is 6.
- If the argument is a large integer, the length attribute of the result is 11.
- If the argument is a big integer, the length attribute of the result is 20.

The actual length of the result is the smallest number of characters that can be used to represent the value of the argument. Leading zeroes are not included. If the argument is negative, the first character of the result is a minus sign. Otherwise, the first character is a digit or the *decimal-character*.

The CCSID of the result is 1200 (UTF-16).

Decimal to Vargraphic

decimal-expression

An expression that returns a value that is a packed or zoned decimal data type (either DECIMAL or NUMERIC). If a different precision and scale is wanted, the DECIMAL scalar function can be used to make the change.

decimal-character

Specifies the single-byte character constant that is used to delimit the decimal digits in the result character string. The character must be a period or comma. If the second argument is not specified, the decimal point is the default decimal point. For more information, see [“Decimal point” on page 118](#).

The result is a varying-length graphic string representation of the argument. The result includes a decimal character and up to p digits, where p is the precision of the *decimal-expression* with a preceding minus sign if the argument is negative. Leading zeros are not returned. Trailing zeros are returned. If the scale of *decimal-expression* is zero, the decimal character is not returned.

The length attribute of the result is $2+p$ where p is the precision of the *decimal-expression*. The actual length of the result is the smallest number of characters that can be used to represent the result, except that trailing characters are included. Leading zeros are not included. If the argument is negative, the result begins with a minus sign. Otherwise, the result begins with a digit or the *decimal-character*.

The CCSID of the result is 1200 (UTF-16).

Floating-point to Vargraphic

floating-point expression

An expression that returns a value that is a floating-point data type (DOUBLE or REAL).

decimal-character

Specifies the single-byte character constant that is used to delimit the decimal digits in the result character string. The character must be a period or comma. If the second argument is not specified, the decimal point is the default decimal point. For more information, see [“Decimal point” on page 118](#).

The result is a varying-length graphic string representation of the argument in the form of a floating-point constant.

The length attribute of the result is 24. The actual length of the result is the smallest number of characters that can represent the value of the argument such that the mantissa consists of a single digit other than zero followed by the *decimal-character* and a sequence of digits. If the argument is negative, the first character of the result is a minus sign; otherwise, the first character is a digit or the *decimal-character*. If the argument is zero, the result is 0E0.

The CCSID of the result is 1200 (UTF-16).

Decimal floating-point to Vargraphic

decimal-floating-point expression

An expression that returns a value that is a decimal floating-point data type.

decimal-character

Specifies the single-byte character constant that is used to delimit the decimal digits in the result character string. The character must be a period or comma. If the second argument is not specified, the decimal point is the default decimal point. For more information, see [“Decimal point” on page 118](#).

The result is a varying-length graphic string representation of the argument in the form of a decimal floating-point constant.

The length attribute of the result is 42. The actual length of the result is the smallest number of characters that represents the value of the argument, including the sign, digits, and *decimal-character*. Trailing zeros are significant. If the argument is negative, the first character of the result is a minus sign; otherwise, the first character is a digit or the *decimal-character*. If the argument is zero, the result is 0.

If the DECFLOAT value is Infinity, sNaN, or NaN, the strings 'INFINITY', 'SNAN', and 'NAN', respectively, are returned. If the special value is negative, a minus sign will be the first character in the string. The DECFLOAT special value sNaN does not result in an exception when converted to a string.

The CCSID of the result is 1200 (UTF-16).

Character to Vargraphic

character-expression

Specifies a character string expression. It cannot be a CHAR or VARCHAR bit data.

length

An integer constant that specifies the length attribute of the result and must be an integer constant between 1 and 16370 if the first argument is not nullable or between 1 and 16369 if the first argument is nullable.

If the second argument is not specified, or if DEFAULT is specified, the length attribute of the result is the same as the length attribute of the first argument, except if the expression is an empty string or the EBCDIC string X'0E0F', the length attribute of the result is 1.

The actual length of the result is the minimum of the length attribute of the result and the actual length of *character-expression*. Each character of the argument determines a character of the result. If the length (in characters) of the *character-expression* is greater than the length attribute of the result,

truncation is performed. A warning (SQLSTATE 01004) is returned unless the truncated characters were all blanks.

integer

An integer constant that specifies the CCSID of the result. It must be a DBCS, UTF-16, or UCS-2 CCSID. The CCSID cannot be 65535. If the CCSID represents Unicode graphic data, each character of the argument determines a character of the result. The *n*th character of the result is the UTF-16 or UCS-2 equivalent of the *n*th character of the argument.

If *integer* is not specified then the CCSID of the result is determined by a mixed CCSID. Let *M* denote that mixed CCSID.

In the following rules, *S* denotes one of the following:

- If the string expression is a host variable containing data in a foreign encoding scheme, *S* is the result of the expression after converting the data to a CCSID in a native encoding scheme. (See “Character conversion” on page 28 for more information.)
- If the string expression is data in a native encoding scheme, *S* is that string expression.

M is determined as follows:

- If the CCSID of *S* is 1208 (UTF-8), *M* is 1200 (UTF-16).
- If the CCSID of *S* is a mixed CCSID, *M* is that CCSID.
- If the CCSID of *S* is an SBCS CCSID:
 - If the CCSID of *S* has an associated mixed CCSID, *M* is that CCSID.
 - Otherwise the operation is not allowed.

The following table summarizes the result CCSID based on *M*.

M	Result CCSID	Description	DBCS Substitution Character
930	300	Japanese EBCDIC	X'FEFE'
933	834	Korean EBCDIC	X'FEFE'
935	837	S-Chinese EBCDIC	X'FEFE'
937	835	T-Chinese EBCDIC	X'FEFE'
939	300	Japanese EBCDIC	X'FEFE'
5026	4396	Japanese EBCDIC	X'FEFE'
5035	4396	Japanese EBCDIC	X'FEFE'

The equivalence of SBCS and DBCS characters depends on *M*. Regardless of the CCSID, every double-byte code point in the argument is considered a DBCS character, and every single-byte code point in the argument is considered an SBCS character with the exception of the EBCDIC mixed data shift codes X'0E' and X'0F'.

- If the *n*th character of the argument is a DBCS character, the *n*th character of the result is that DBCS character.
- If the *n*th character of the argument is an SBCS character that has an equivalent DBCS character, the *n*th character of the result is that equivalent DBCS character.
- If the *n*th character of the argument is an SBCS character that does not have an equivalent DBCS character, the *n*th character of the result is the DBCS substitution character.

Graphic to Vargraphic

graphic-expression

An expression that returns a value that is a graphic string.

length

An integer constant that specifies the length attribute of the result and must be an integer constant between 1 and 16370 if the first argument is not nullable or between 1 and 16369 if the first argument is nullable.

If the second argument is not specified, or if DEFAULT is specified, the length attribute of the result is the same as the length attribute of the first argument, except if the expression is an empty string, the length attribute of the result is 1.

The actual length of the result is the minimum of the length attribute of the result and the actual length of *graphic-expression*. Each character of the argument determines a character of the result. If the length (in characters) of the *graphic-expression* is greater than the length attribute of the result, truncation is performed. A warning (SQLSTATE 01004) is returned unless the truncated characters were all blanks.

integer

An integer constant that specifies the CCSID of the result. It must be a DBCS, UTF-16, or UCS-2 CCSID. The CCSID cannot be 65535.

If *integer* is not specified then the CCSID of the result is the CCSID of the first argument.

Datetime to Vargraphic***datetime-expression***

An expression that is one of the following three built-in data types

date

The result is the varying-length graphic string representation of the date in the format specified by the second argument. If the second argument is not specified, the format used is the default date format. If the format is ISO, USA, EUR, or JIS, the length attribute and actual length of the result is 10. Otherwise the length attribute and actual length of the result is the length of the default date format. For more information see [“String representations of datetime values” on page 75](#).

time

The result is the varying-length graphic string representation of the time in the format specified by the second argument. If the second argument is not specified, the format used is the default time format. The length attribute and actual length of the result is 8. For more information see [“String representations of datetime values” on page 75](#).

timestamp

The second argument is not applicable and must not be specified.

The result is the varying-length graphic string representation of the timestamp. If *datetime-expression* is a `TIMESTAMP(0)`, the length attribute and actual length of the result is 19. If the data type of *datetime-expression* is a `TIMESTAMP(n)`, the length attribute and actual length of the result is $20+n$. Otherwise, the length attribute and actual length of the result is 26.

The CCSID of the result is 1200 (UTF-16).

ISO, EUR, USA, or JIS

Specifies the date or time format of the resulting graphic string. For more information, see [“String representations of datetime values” on page 75](#).

LOCAL

Specifies that the date or time format of the resulting graphic string should come from the `DATFMT`, `DATSEP`, `TIMFMT`, and `TIMSEP` attributes of the job at the current server.

Note

Syntax alternatives: The `CAST` specification should be used to increase the portability of applications when the first argument is a string and the length attribute is specified. For more information, see [“CAST specification” on page 177](#).

Example

- Using the EMPLOYEE table, set the host variable VAR_DESC (VARGRAPHIC(24)) to the VARGRAPHIC equivalent of the first name (FIRSTNME) for employee number (EMPNO) '000050'.

```
SELECT VARGRAPHIC(FIRSTNME)
INTO :VAR_DESC
FROM EMPLOYEE
WHERE EMPNO = '000050'
```

VERIFY_GROUP_FOR_USER

The VERIFY_GROUP_FOR_USER function returns a value that indicates whether the specified user is in the list of user profiles or is a member of any of the group user profiles specified by the list of *authorization-id-expression* arguments.

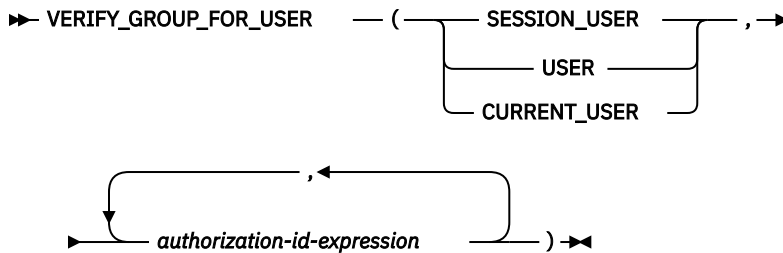

SESSION_USER or USER or CURRENT_USER

Specifies an authorization ID.

authorization-id-expression

An expression that specifies an authorization name. The existence of the authorization name at the current server is not verified. *authorization-id-expression* must return a value of any built-in character-string or graphic-string data type. The value of each *authorization-id-expression* must have a length of at least 1 and be less than or equal to 10.

The result of the function is a large integer. The result cannot be null.

The value of the result is 1 if the authorization ID represented by the first argument is anywhere in the list of *authorization-id-expressions*. Otherwise, the result is 0.

The VERIFY_GROUP_FOR_USER function is deterministic within a connection. It is not deterministic across connections. It can be referenced in a CREATE MASK or CREATE PERMISSION statement to verify access to the data.

Example

Assume that table EMPLOYEE exists and that column level access control is activated for the table. Alex (with QIBM_DB_SECADM authority) created the following column mask to control what information is returned for a social security number depending on who requests the information. The column mask only returns the actual social security number if the session user is a member of the MGR group profile. Otherwise a masked representation of the social security number is returned.

```
CREATE MASK SSN_MASK
ON EMPLOYEE
FOR COLUMN SSN
RETURN
CASE
WHEN VERIFY_GROUP_FOR_USER(SESSION_USER, 'MGR') = 1
THEN SSN
ELSE 'XXX-XX' CONCAT SUBSTR(SSN, 8,4)
END
ENABLE;
```

An ALTER TABLE statement is then issued to activate the column mask on the EMPLOYEE table:

```
ALTER TABLE EMPLOYEE
ACTIVATE COLUMN ACCESS CONTROL;
COMMIT;
```

Assume that Mary is a manager and is a member of the MGR group profile. Mary issues the following statement:

```
SELECT SSN FROM EMPLOYEE WHERE NAME = 'Tom';
```

The SSN_MASK column mask is applied to the SSN column to produce the result table. Since Mary is a member of the MGR group profile, the result table contains Tom's actual social security number.

Later, Mary is no longer a manager and is removed from the MGR group profile. She issues the same query again:

```
SELECT SSN FROM EMPLOYEE WHERE NAME = 'Tom' ;
```

As before, the SSN_MASK column mask is applied to the SSN column to produce the result table. This time the result table contains a masked version of Tom's social security number where only the last 4 digits of the actual number are returned. An 'X' is returned for the other digits.

WEEK

The WEEK function returns an integer between 1 and 54 that represents the week of the year. The week starts with Sunday, and January 1 is always in the first week.

►► WEEK — (— *expression* —) —►

expression

An expression that returns a value of one of the following built-in data types: a date, a timestamp, a character string, or a graphic string.

If *expression* is a character or graphic string, its value must be a valid string representation of a date or timestamp. For the valid formats of string representations of dates and timestamps, see [“String representations of datetime values”](#) on page 75.

The result of the function is a large integer. If the argument can be null, the result can be null; if the argument is null, the result is the null value.

Example

- Using the PROJECT table, set the host variable WEEK (INTEGER) to the week that project ('PL2100') ended.

```
SELECT WEEK(PRENDATE)
INTO :WEEK
FROM PROJECT
WHERE PROJNO = 'PL2100'
```

Results in WEEK being set to 38.

- Assume that table X has a DATE column called DATE_1 with various dates from the list below.

```
SELECT DATE_1, WEEK(DATE_1)
FROM X
```

Results in the following list shows what is returned by the WEEK function for various dates.

```
1997-12-28    53
1997-12-31    53
1998-01-01     1
1999-01-01     1
1999-01-04     2
1999-12-31    53
2000-01-01     1
2000-01-03     2
```

WEEK_ISO

The WEEK_ISO function returns an integer between 1 and 53 that represents the week of the year. The week starts with Monday. Week 1 is the first week of the year to contain a Thursday, which is equivalent to the first week containing January 4. Thus, it is possible to have up to 3 days at the beginning of the year appear as the last week of the previous year or to have up to 3 days at the end of a year appear as the first week of the next year.

►► WEEK_ISO — (— *expression* —) ◄◄

expression

An expression that returns a value of one of the following built-in data types: a date, a timestamp, a character string, or a graphic string.

If *expression* is a character or graphic string, its value must be a valid string representation of a date or timestamp. For the valid formats of string representations of dates and timestamps, see [“String representations of datetime values”](#) on page 75.

The result of the function is a large integer. If the argument can be null, the result can be null; if the argument is null, the result is the null value.

Examples

- Using the PROJECT table, set the host variable WEEK (INTEGER) to the week that project ('AD2100') ended.

```
SELECT WEEK_ISO(PRENDATE)
INTO :WEEK
FROM PROJECT
WHERE PROJNO = 'AD3100'
```

Results in WEEK being set to 5.

- Assume that table X has a DATE column called DATE_1 with various dates from the list below.

```
SELECT DATE_1, WEEK_ISO(DATE_1)
FROM X
```

Results in the following:

```
1997-12-28    52
1997-12-31     1
1998-01-01     1
1999-01-01    53
1999-01-04     1
1999-12-31    52
2000-01-01    52
2000-01-03     1
```

WRAP

The WRAP function transforms a readable DDL statement into an obfuscated DDL statement.

►► WRAP — (— *object-definition-string* —) ►►

In an obfuscated DDL statement, the procedural logic and embedded SQL statements are scrambled in such a way that any intellectual property in the logic cannot be easily extracted.

The schema is SYSIBMADM.

object-definition-string

A string of type CLOB or DBCLOB containing a DDL statement. It can be one of the following SQL statements:

- CREATE FUNCTION (SQL scalar)
- CREATE FUNCTION (SQL table)
- CREATE PROCEDURE (SQL)
- CREATE TRIGGER

The result is a string of type CLOB(2M) which contains an encoded version of the input statement. The result cannot be null. The encoding consists of a prefix of the original statement up to and including the routine signature or trigger name, followed by the keyword WRAPPED. This keyword is followed by information about the application server that invoked the function. The information has the form *pppvrrm* where:

- *ppp* identifies the product using the following 3 characters:
 - DSN for Db2 for z/OS
 - QSQ for Db2 for i
 - SQL for Db2 for LUW
- *vv* is a two-digit version identifier, such as '07'
- *rr* is a two-digit release identifier, such as '02'
- *m* is a one-character modification level identifier, such as '0'

For example Db2 for i version 7.3 is identified as 'QSQ07030'.

This application server information is followed by a string of letters (a-z and A-Z), digits (0-9), underscores, and colons.

The encoded DDL statement may be up to one-third longer than the plain text form of the statement. If the result exceeds the maximum length for SQL statements, an error is issued.

Note

The encoding of the statement is meant to obfuscate the content and should not be considered as a form of strong encryption.

Examples

Example 1: Produce an obfuscated version of a function that computes a yearly salary from an hourly wage given a 40 hour work week.

```
VALUES WRAP('CREATE FUNCTION salary(wage DECFLOAT) RETURNS DECFLOAT
            RETURN wage * 40 * 52')
```

The result of this statement would be something of the form:

```
CREATE FUNCTION salary(wage DECFLOAT) WRAPPED QSQ07020 <encoded-suffix>
```

Example 2: Produce an obfuscated version of a trigger that sets a complex default.

```
VALUES WRAP('CREATE OR REPLACE TRIGGER trig1 BEFORE INSERT ON emp  
REFERENCING NEW AS n FOR EACH ROW  
WHEN (n.bonus IS NULL) SET n.bonus = n.salary * .04')
```

The result of this statement would be something of the form:

```
CREATE TRIGGER trig1 WRAPPED QSQ07020 <encoded-suffix>
```

XMLATTRIBUTES

The XMLATTRIBUTES function constructs XML attributes from the arguments.

►► XMLATTRIBUTES ►►

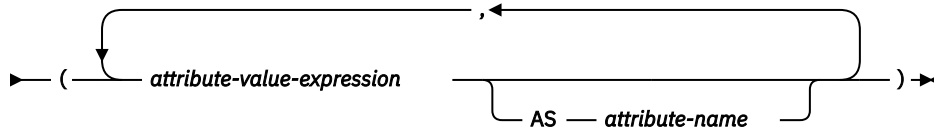

This function can only be used as an argument of the XMLELEMENT function. The result is an XML sequence containing an XML attribute for each non-null *attribute-value-expression* argument.

attribute-value-expression

An expression whose result is the attribute value. The data type of *attribute-value-expression* must not be ROWID, DATALINK, XML or a distinct type that is based on ROWID, DATALINK, or XML. The expression can be any SQL expression. If the expression is not a simple column reference, an attribute name must be specified.

attribute-name

Specifies an attribute name. The name is an SQL identifier that must be in the form of an XML qualified name, or QName. See the W3C XML namespace specifications for more details on valid names. The attribute name cannot be "xmlns" or prefixed with "xmlns:". A namespace is declared using the function XMLNAMESPACES. Duplicate attribute names, whether implicit or explicit, are not allowed.

If *attribute-name* is not specified, *attribute-value-expression* must be a column name. The attribute name is created from the column name using the fully escaped mapping from a column name to an XML attribute name.

The result of the function is XML. If the result of any *attribute-value-expression* can be null, the result can be null; if the result of every *attribute-value-expression* is null, the result is the null value.

Example

Note: XMLATTRIBUTES does not insert blank spaces or new line characters in the output. All example output has been formatted to enhance readability.

- Produce an element with attributes.

```
SELECT E.EMPNO, XMLELEMENT(  
  NAME "Emp",  
  XMLATTRIBUTES(  
    E.EMPNO, E.FIRSTNAME || ' ' || E.LASTNAME AS "name"  
  )  
  )  
AS "Result"  
FROM EMPLOYEE E  
WHERE E.EDLEVEL = 12
```

This query produces the following result:

```
EMPNO  Result  
000290 <Emp EMPNO="000290" name="JOHN PARKER"/>  
000310 <Emp EMPNO="000310" name="MAUDE SETRIGHT"/>  
200310 <Emp EMPNO="200310" name="MICHELLE SPRINGER"/>
```

XMLCOMMENT

The XMLCOMMENT function returns an XML value with the input argument as the content.

►► XMLCOMMENT — (— *string-expression* —) ►◄

string-expression

An expression that returns a value of any built-in character-string or graphic-string data type. It cannot be CHAR or VARCHAR bit data. The result of *string-expression* is parsed to check for conformance to the content of an XML comment, as specified by the following rules:

- Two adjacent hyphens ('--') must not occur in the string expression.
- The string expression must not end with a hyphen ('-').
- Each character of the string can be any Unicode character, excluding the surrogate blocks, X'FFFE', and X'FFFF'.⁷⁷

If *string-expression* does not conform to the previous rules, an error is returned.

The result of the function is XML. If the argument can be null, the result can be null; if the argument is null, the result is the null value.

Example

- Generate an XML comment.

```
SELECT XMLCOMMENT('This is an XML comment')
FROM SYSIBM.SYSDUMMY1
```

This query produces the following result:

```
<!--This is an XML comment-->
```

⁷⁷ Valid Unicode characters consist of the following Unicode code points: #x9, #xA, #xD, #x20-#xD7FF, #xE000-#xFFFF, #x10000-#x10FFFF.

XMLCONCAT

The XMLCONCAT function returns a sequence containing the concatenation of a variable number of XML input arguments.

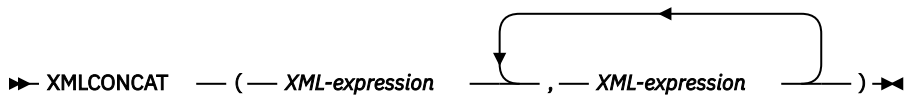

XML-expression

An expression that returns an XML value.

The result of the function is an XML sequence that contains the concatenation of the non-null input XML values. Null values in the input are ignored.

The result of the function is XML. The result can be null; if the result of every input value is null, the result is the null value.

Examples

Note: XMLCONCAT does not insert blank spaces or new line characters in the output. All example output has been formatted to enhance readability.

- Concatenate first name and last name elements by using "first" and "last" element names for each employee

```
SELECT XMLSERIALIZE(  
  XMLCONCAT(  
    XMLELEMENT(NAME "first", e.firstnme),  
    XMLELEMENT(NAME "last", e.lastname)  
  ) AS VARCHAR(100) ) AS "result"  
FROM EMPLOYEE E  
WHERE e.lastname = 'SMITH'
```

The result of the query would look similar to the following result:

```
result  
-----  
<first>DANIEL</first><last>SMITH</last>  
<first>PHILIP</first><last>SMITH</last>
```

- Construct a department element for departments A00 and B01 containing a list of employees sorted by first name. Include an introductory comment immediately preceding the department element.

```
SELECT XMLCONCAT(  
  XMLCOMMENT (  
    'Confirm these employees are on track for their product schedule'),  
  XMLELEMENT(  
    NAME "Department",  
    XMLATTRIBUTES( E.WORKDEPT AS "name"),  
    XMLAGG(  
      XMLELEMENT(NAME "emp", E.FIRSTNME)  
      ORDER BY E.FIRSTNME  
    )  
  )  
FROM EMPLOYEE E  
WHERE E.WORKDEPT IN ('A00', 'B01')  
GROUP BY E.WORKDEPT
```

This query produces the following result:

```
<!--Confirm these employees are on track for their product schedule-->  
<Department name="A00">  
<emp>CHRISTINE</emp>  
<emp>SEAN</emp>  
<emp>VINCENZO</emp>  
</Department>  
<!--Confirm these employees are on track for their product schedule-->  
<Department name="B01">
```

```
<emp>MICHAEL</emp>  
</Department>
```

XMLDOCUMENT

The XMLDOCUMENT function returns an XML value.

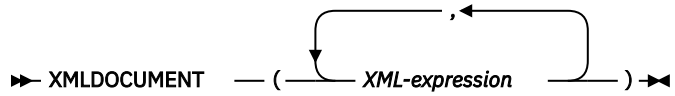

XML-expression

An expression that returns an XML value.

The result of the function is XML. If the result of *XML-expression* can be null, the result can be null; if every *XML-expression* is null, the result is the null value.

Example

- Insert a constructed document into an XML column.

```
INSERT INTO T1 VALUES(123,
  (SELECT XMLDOCUMENT(
    XMLELEMENT(NAME "Emp",
      E.FIRSTNAME || ' ' || E.LASTNAME,
      XMLCOMMENT('This is just a simple example')
    )
  )
  FROM EMPLOYEE E
  WHERE E.EMPNO = '000120'))
```

XMLELEMENT

The XMLELEMENT function returns an XML value that is an XML element.

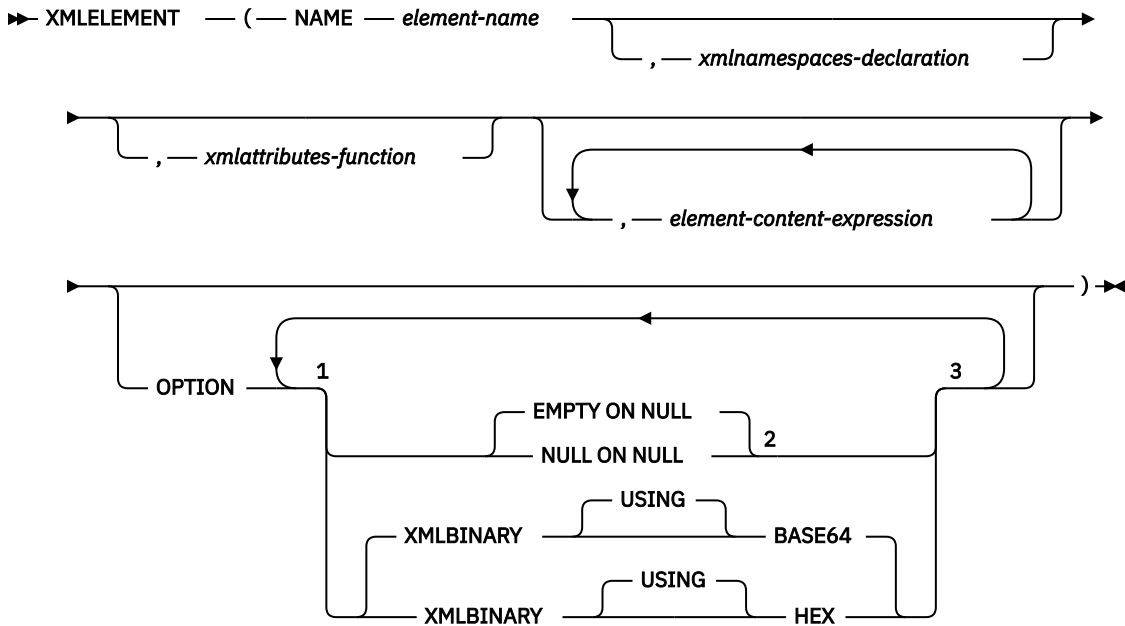

Notes:

- ¹ The OPTION clause can only be specified if at least one *xmlattributes-function* or *element-content-expression* is specified
- ² If *element-content-expression* is not specified, EMPTY ON NULL or NULL ON NULL must not be specified.
- ³ The same clause must not be specified more than once.

NAME *element-name*

Specifies the name of an XML element. The name is an SQL identifier that must be in the form of an XML qualified name, or QName. See the W3C XML namespace specifications for more details on valid names. If the name is qualified, the namespace prefix must be declared within the scope.

xmlnamespaces-declaration

Specifies the XML namespace declarations that are the result of the XMLNAMESPACES declaration. The namespaces that are declared are in the scope of the XMLELEMENT function. The namespaces apply to any nested XML functions within the XMLELEMENT function, regardless of whether or not they appear inside another subselect. See [“XMLNAMESPACES” on page 654](#) for more information on declaring XML namespaces.

If *xmlnamespaces-declaration* is not specified, namespace declarations are not associated with the constructed element.

xmlattributes-function

Specifies the XML attributes for the element. The attributes are the result of the XMLATTRIBUTES function. See [“XMLATTRIBUTES” on page 643](#) for more information on construction attributes.

element-content-expression

The content of the generated XML element node is specified by an expression or a list of expressions. The expression can be any SQL expression of any SQL data type except for ROWID or DATALINK. The expression is used to construct the namespace declarations, attributes, and content of the constructed element.

If *element-content-expression* is not specified, an empty string is used as the content for the element and NULL ON NULL or EMPTY ON NULL must not be specified.

OPTION

Specifies additional options for constructing the XML element. This clause has no impact on nested `XMLEMENT` invocations specified in *element-content-expression*.

EMPTY ON NULL or NULL ON NULL

Specifies whether a null value or an empty element is to be returned if the value of every *element-content-expression* is the null value. This option only affects null handling of element contents, not attribute values. The default is `EMPTY ON NULL`.

EMPTY ON NULL

If the value of each *element-content-expression* is null, an empty element is returned.

NULL ON NULL

If the value of each *element-content-expression* is null, a null value is returned.

XMLBINARY USING BASE64 or XMLBINARY USING HEX

Specifies the assumed encoding of binary input data, character string data with the `FOR BIT DATA` attribute, or a distinct type that is based on one of these types. The encoding applies to element content or attribute values. The default is `XMLBINARY USING BASE64`.

XMLBINARY USING BASE64

Specifies that the assumed encoding is base64 characters, as defined for XML schema type `xs:base64Binary` encoding. The base64 encoding uses a 65-character subset of US-ASCII (10 digits, 26 lowercase characters, 26 uppercase characters, '+', and '/') to represent every six bits of the binary or bit data with one printable character in the subset. These characters are selected so that they are universally representable. Using this method, the size of the encoded data is 33 percent larger than the original binary or bit data.

XMLBINARY USING HEX

Specifies that the assumed encoding is hexadecimal characters, as defined for XML schema type `xs:hexBinary` encoding. The hexadecimal encoding represents each byte (8 bits) with two hexadecimal characters. Using this method, the encoded data is twice the size of the original binary or bit data.

This function takes an element name, an optional collection of namespace declarations, an optional collection of attributes, and zero or more arguments that make up the content of the XML element. The result is an XML sequence containing an XML element node or the null value. If the results of all *element-content-expression* arguments are empty strings, the result is an XML sequence that contains an empty element.

The result of the function is XML. The result can be null; if all the *element-content-expression* argument values are null and the `NULL ON NULL` option is in effect, the result is the null value.

Rules about using namespaces within `XMLEMENT`: The following rules describe scoping of namespaces:

- The namespaces declared in the `XMLNAMESPACES` declaration are the in-scope namespaces of the element constructed by the `XMLEMENT` function. If the element is serialized, then each of its in-scope namespaces will be serialized as a namespace attribute unless it is an in-scope namespace of an XML value that includes this element.
- The scope of these namespaces is the lexical scope of the `XMLEMENT` function, including the element name, the attribute names that are specified in the `XMLATTRIBUTES` function, and all *element-content-expressions*. These are used to resolve the QNames in the scope.
- If an attribute of the constructed element comes from an *element-content-expression*, its namespace might not already be declared as an in-scope namespace of the constructed element. In this case, a new namespace is created for it. If this would result in a conflict, which means that the prefix of the attribute name is already bound to a different URI by an in-scope namespace, Db2 generates a different prefix to be used in the attribute name. A namespace is created for this generated prefix. The name of the generated prefix follows the following pattern: `db2ns-xx`, where `xx` is a pair of characters chosen from the set `[A-Z, a-z, 0-9]`.

Example

Note: XMLEMENT does not insert blank spaces or new line characters in the output. All example output has been formatted to enhance readability.

The following examples use a temporary CANDIDATES employee table:

```
DECLARE GLOBAL TEMPORARY TABLE CANDIDATES
(EMPNO CHAR(6),
 FIRSTNME VARCHAR(12),
 MIDINIT CHAR(1),
 LASTNAME VARCHAR(15),
 WORKDEPT CHAR(4),
 EDLEVEL INT)
INSERT INTO SESSION.CANDIDATES
VALUES('A0001', 'John', 'A', 'Parker', 'X001', 12)
INSERT INTO SESSION.CANDIDATES
VALUES('B0001', NULL, NULL, 'Smith', 'X001', 12)
INSERT INTO SESSION.CANDIDATES
VALUES('B0002', NULL, NULL, NULL, 'X001', NULL)
INSERT INTO SESSION.CANDIDATES
VALUES(NULL, NULL, NULL, NULL, 'X001', NULL)
```

- The following statement used the XMLEMENT function to create an XML element that contains an employee's name. The statement also sets the employee number as an attribute names serial. If there is a null value in the referenced column, the function returns the null value:

```
SELECT E.EMPNO, E.FIRSTNME, E.LASTNAME,
       XMLEMENT(NAME "foo:Emp",
                XMLNAMESPACES('http://www.foo.com' AS "foo"),
                XMLATTRIBUTES(E.EMPNO AS "serial"),
                E.FIRSTNME, E.LASTNAME
                OPTION NULL ON NULL) AS "Result"
FROM SESSION.CANDIDATES E
```

This query produces the following result:

EMPNO	FIRSTNME	LASTNAME	Result
A0001	John	Parker	<foo:Emp xmlns:foo="http://www.foo.com" serial="A0001">JohnParker</foo:Emp>
B0001	(null)	Smith	<foo:Emp xmlns:foo="http://www.foo.com" serial="B0001">Smith</foo:Emp>
B0002	(null)	(null)	(null)
(null)	(null)	(null)	(null)

- The following example is similar to the previous one. However, when there is a null value in the referenced column, an empty element is returned:

```
SELECT E.EMPNO, E.FIRSTNME, E.LASTNAME,
       XMLEMENT(NAME "foo:Emp",
                XMLNAMESPACES('http://www.foo.com' AS "foo"),
                XMLATTRIBUTES(E.EMPNO AS "serial"),
                E.FIRSTNME, E.LASTNAME
                OPTION EMPTY ON NULL) AS "Result"
FROM SESSION.CANDIDATES E
```

This query produces the following result:

EMPNO	FIRSTNME	LASTNAME	Result
A0001	John	Parker	<foo:Emp xmlns:foo="http://www.foo.com" serial="A0001">JohnParker</foo:Emp>
B0001	(null)	Smith	<foo:Emp xmlns:foo="http://www.foo.com" serial="B0001">Smith</foo:Emp>
B0002	(null)	(null)	<foo:Emp xmlns:foo="http://www.foo.com" serial="B0002"></foo:Emp>
(null)	(null)	(null)	<foo:Emp xmlns:foo="http://www.foo.com"></foo:Emp>

XMLFOREST

The XMLFOREST function returns an XML value that is a sequence of XML elements.

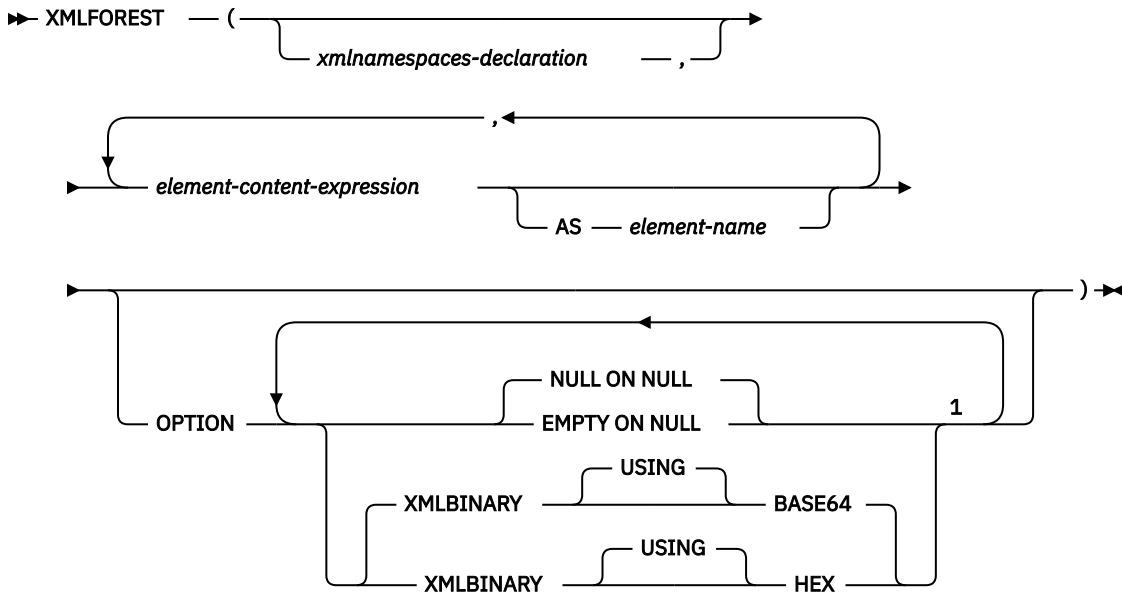

Notes:

¹ The same clause must not be specified more than once.

xmlnamespace-declaration

Specifies the XML namespace declarations that are the result of the XMLNAMESPACES declaration. The namespaces that are declared are in the scope of the XMLFOREST function. The namespaces apply to any nested XML functions within the XMLFOREST function, regardless of whether or not they appear inside another subselect. See “XMLNAMESPACES” on page 654 for more information on declaring XML namespaces.

If *xmlnamespace-declaration* is not specified, namespace declarations are not associated with the constructed XML elements.

element-content-expression

Specifies an expression that returns a value that is used for the content of a generated XML element. The data type of the expression must not be ROWID or DATALINK. If the expression is not a simple column reference, *element-name* must be specified.

AS element-name

Specifies an identifier that is used for the XML element name.

An XML element name must be an XML qualified name, or QName. See the W3C XML namespace specifications for more details on valid names. If the name is qualified, the namespace prefix must be declared within the scope.

If *element-name* is not specified, *element-content-expression* must be a column name. The element name is created from the column name using the fully escaped mapping from a column name to a QName.

OPTION

Specifies options for the result for NULL values, binary data, and bit data. The options will not be inherited by XMLELEMENT or XMLFOREST functions that appear in *element-content-expression*.

NULL ON NULL or EMPTY ON NULL

Specifies whether a null value or an empty element is to be returned if the value of every *element-content-expression* is the null value. This option only affects null handling of the *element-content-expression* arguments. The default is NULL ON NULL.

NULL ON NULL

If the value of each *element-content-expression* is null, a null value is returned.

EMPTY ON NULL

If the value of each *element-content-expression* is null, an empty element is returned.

XMLBINARY USING BASE64 or XMLBINARY USING HEX

Specifies the assumed encoding of binary input data, character string data with the FOR BIT DATA attribute, ROWID, or a distinct type that is based on one of these types. The encoding applies to element content or attribute values. The default is XMLBINARY USING BASE64.

XMLBINARY USING BASE64

Specifies that the assumed encoding is base64 characters, as defined for XML schema type `xs:base64Binary` encoding. The base64 encoding uses a 65-character subset of US-ASCII (10 digits, 26 lowercase characters, 26 uppercase characters, '+', and '/') to represent every six bits of the binary or bit data with one printable character in the subset. These characters are selected so that they are universally representable. Using this method, the size of the encoded data is 33 percent larger than the original binary or bit data.

XMLBINARY USING HEX

Specifies that the assumed encoding is hexadecimal characters, as defined for XML schema type `xs:hexBinary` encoding. The hexadecimal encoding represents each byte (8 bits) with two hexadecimal characters. Using this method, the encoded data is twice the size of the original binary or bit data.

The result of the function is an XML value. If the result of any *element-content-expression* can be null, the result can be null; if the result of every *element-content-expression* is null and the NULL ON NULL option is in effect, the result is the null value.

The XMLFOREST function can be expressed by using XMLCONCAT and XMLELEMENT. For example, the following two expressions are semantically equivalent.

```
XMLFOREST(xmlnamespaces-declaration, arg1 AS name1, arg2 AS name2, ...)
XMLCONCAT(XMLELEMENT(NAME name1, xmlnamespaces-declaration, arg1),
          XMLELEMENT(NAME name2, xmlnamespaces-declaration, arg2),
          ... )
```

When constructing elements that will be copied as content of another element that defines default namespaces, default namespaces should be explicitly undeclared in the copied element to avoid possible errors that could result from inheriting the default namespace from the new parent element. Predefined namespace prefixes ('xs', 'xsi', 'xml', 'sqlxml') must also be declared explicitly when they are used.

Example

Note: XMLFOREST does not insert blank spaces or new line characters in the output. All example output has been formatted to enhance readability.

- Construct a forest of elements with a default namespace.

```
SELECT EMPNO,
       XMLFOREST(XMLNAMESPACES (DEFAULT 'http://hr.org',
                               'http://fed.gov' AS "d"),
                LASTNAME, JOB AS "d:job") AS "Result"
FROM EMPLOYEE WHERE EDLEVEL = 12
```

This query produces the following result:

```
EMPNO Result
000290 <LASTNAME xmlns:"http://hr.org" xmlns:d="http://fed.gov">PARKER
      </LASTNAME>
      <d:job xmlns:"http://hr.org" xmlns:d="http://fed.gov">OPERATOR</d:job>
000310 <LASTNAME xmlns:"http://hr.org" xmlns:d="http://fed.gov">SETRIGHT
      </LASTNAME>
      <d:job xmlns:"http://hr.org" xmlns:d="http://fed.gov">OPERATOR</d:job>
200310 <LASTNAME xmlns:"http://hr.org" xmlns:d="http://fed.gov">SPRINGER
```

```
</LASTNAME>  
<d:job xmlns:"http://hr.org" xmlns:d="http://fed.gov">OPERATOR</d:job>
```

XMLNAMESPACES

The XMLNAMESPACES declaration constructs namespace declarations from the arguments. This declaration can only be used as an argument for the XMLELEMENT and XMLFOREST functions. The result is one or more XML namespace declarations containing in-scope namespaces for each non-null input value.

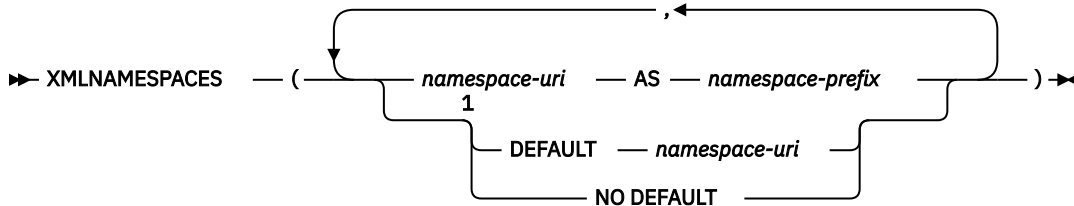

Notes:

¹ The DEFAULT or NO DEFAULT clause can only be specified one time.

namespace-uri

Specifies an SQL character string constant that contains the namespace name or a universal resource identifier (URI). The character string constant must not be an empty string if it is used with *namespace-prefix*.

AS namespace-prefix

Specifies a namespace prefix. The prefix is an SQL identifier that must be in the form of an XML NCName. See the W3C XML namespace specifications for more details on valid names. The prefix must not be "xml" or "xmlns". The prefix must be unique within the list of namespace declarations.

The following namespace prefixes are pre-defined in SQL/XML: "xml", "xs", "xsd", "xsi", and "sqlxml". Their bindings are:

- xmlns:xml = "http://www.w3.org/XML/1998/namespace"
- xmlns:xs = "http://www.w3.org/2001/XMLSchema"
- xmlns:xsd = "http://www.w3.org/2001/XMLSchema"
- xmlns:xsi = "http://www.w3.org/2001/XMLSchema-instance"
- xmlns:sqlxml = "http://standards.iso.org/iso/9075/2003/sqlxml"

DEFAULT namespace-uri or NO DEFAULT

Specifies whether a default namespace is to be used within the scope of this namespace declaration.

The scope of this namespace declaration is the specified XML element and all XML expressions that are contained in the specified XML element.

DEFAULT namespace-uri

Specifies the default namespace to use within the scope of this namespace declaration. The *namespace-uri* applies for unqualified names in the scope unless it is overridden in a nested scope by another DEFAULT declaration or by a NO DEFAULT declaration.

namespace-uri specifies an SQL character string constant that contains a namespace name or universal resource identifier (URI). The character string constant can be an empty string in the context of the DEFAULT clause.

NO DEFAULT

Specifies that no default namespace is to be used within the scope of this namespace declaration. There is no default namespace in the scope unless the NO DEFAULT clause is overridden in a nested scope by a DEFAULT declaration.

The result of the function is an XML value that is an XML sequence that contains an XML namespace declaration for each specified namespace. The result cannot be null.

Examples

Note: XML processing does not insert blank spaces or new line characters in the output. All example output has been formatted to enhance readability.

- Generate an "employee" element for each employee. The employee element is associated with XML namespace "urn:bo", which is bound to prefix "bo". The element contains attributes for names and a hiredate subelement.

```
SELECT E.EMPNO,  
       XMLSERIALIZE(XMLELEMENT(NAME "bo:employee",  
                               XMLNAMESPACES('urn:bo' AS "bo"),  
                               XMLATTRIBUTES(E.LASTNAME, E.FIRSTNAME),  
                               XMLELEMENT(NAME "bo:hiredate", E.HIREDATE))  
       AS CLOB(200))  
FROM EMPLOYEE E WHERE E.EDLEVEL = 12
```

This query produces the following result:

```
00029 <bo:employee xmlns:bo="urn:bo" LASTNAME="PARKER" FIRSTNAME="JOHN">  
      <bo:hiredate>1988-05-30</bo:hiredate>  
      </bo:employee>  
00031 <bo:employee xmlns:bo="urn:bo" LASTNAME="SETRIGHT" FIRSTNAME="MAUDE">  
      <bo:hiredate>1964-09-12</bo:hiredate>  
      </bo:employee>
```

- Generate two elements for each employee using XMLFOREST. The first "lastname" element is associated with the default namespace "http://hr.org", and the second "job" element is associated with XML namespace "http://fed.gov", which is bound to prefix "d".

```
SELECT EMPNO,  
       XMLSERIALIZE(XMLFOREST(XMLNAMESPACES(DEFAULT 'http://hr.org',  
                                             'http://fed.gov' AS "d"),  
                             LASTNAME, JOB AS "d:job")  
       AS CLOB(200))  
FROM EMPLOYEE WHERE EDLEVEL = 12
```

This query produces the following result:

```
00029 <LASTNAME xmlns="http://hr.org" xmlns:d="http://fed.gov">PARKER  
      </LASTNAME>  
      <d:job xmlns="http://hr.org" xmlns:d="http://fed.gov">  
      OPERATOR</d:job>  
00031 <LASTNAME xmlns="http://hr.org" xmlns:d="http://fed.gov">  
      SETRIGHT</LASTNAME>  
      <d:job xmlns="http://hr.org" xmlns:d="http://fed.gov">  
      OPERATOR</d:job>
```

XMLPARSE

The XMLPARSE function parses the arguments as an XML document and returns an XML value.



DOCUMENT

Specifies that the character string expression to be parsed must evaluate to a well-formed XML document that conforms to XML 1.0.

string-expression

An expression that returns a value that is a built-in character, Unicode graphic, or binary string. If a parameter marker is used, it must be explicitly cast to one of the supported data types.

STRIP WHITESPACE or PRESERVE WHITESPACE

Specifies whether or not whitespace in the input argument is to be preserved. If neither is specified, STRIP WHITESPACE is the default.

STRIP WHITESPACE

Specifies that whitespace characters will be stripped unless the nearest containing element has the attribute *xml:space='preserve'*. The whitespace characters in the CDATA section are also affected by this option.

PRESERVE WHITESPACE

Specifies that all whitespace is to be preserved, even when the nearest containing element has the attribute *xml:space='default'*.

The result of the function is XML. If the result of *string-expression* can be null, the result can be null; if the result of *string-expression* is null, the result is the null value. The CCSID of the result is determined from *string-expression*. If *string-expression* has a CCSID of 65535, the value from the SQL_XML_DATA_CCSID QAQQINI option is used.

The input string may contain an XML declaration that identifies the encoding of the characters in the XML document. The encoding in the XML declaration must match the encoding of the *string-expression*.

Examples

Example 1: Insert an XML document into the EMP table and preserve the whitespace in the original XML document.

```
INSERT INTO EMP (ID, XVALUE) VALUES(1001,  
XMLPARSE(DOCUMENT 'PRESERVE WHITESPACE))
```

XMLPARSE will treat the value for the insert statement as equivalent to the following value:

```
<a xml:space='preserve'> <b> <c>c</c>b </b> </a>
```

Example 2: Insert an XML document into the EMP table and strip the whitespace in the original XML document.

```
INSERT INTO EMP (ID, XVALUE) VALUES(1001,  
XMLPARSE(DOCUMENT 'STRIP WHITESPACE))
```

XMLPARSE will treat the value for the insert statement as equivalent to the following value:

```
<a xml:space='preserve'>  
<b xml:space='default'><c>c</c>b </b>  
</a>
```

XMLPI

The XMLPI function returns an XML value with a single processing instruction.

► XMLPI ((NAME *pi-name* , *string-expression*) ◄

NAME *pi-name*

Specifies the name of a processing instruction. The name is an SQL identifier that must be in the form of an XML NCName. See the W3C XML namespace specifications for more details on valid names. The name must not be "xml" in any case combination.

string-expression

An expression that returns a value that is a built-in character or graphic string. It cannot be CHAR or VARCHAR bit data. The resulting string must conform to the content of an XML processing instruction as specified by the following rules:

- The string must not contain the substring '?>' since this substring terminates a processing instruction
- Each character of the string can be any Unicode character, excluding the surrogate blocks, X'FFFE', and X'FFFF'.⁷⁸

If *string-expression* does not conform to the previous rules, an error is returned.

The resulting string becomes the content of the processing instruction.

The result of the function is XML. If the result of *string-expression* can be null, the result can be null; if the result of *string-expression* is null, the result is the null value. If *string-expression* is an empty string or is not specified, the result is an empty processing instruction.

Example

- Generate an XML processing instruction.

```
SELECT XMLPI(  
  NAME "Instruction", 'Push the red button')  
FROM SYSIBM.SYSDUMMY1
```

This query produces the following result:

```
<?Instruction Push the red button?>
```

- Generate an empty XML processing instruction.

```
SELECT XMLPI(NAME "Warning")  
FROM SYSIBM.SYSDUMMY1
```

This query produces the following result:

```
<?Warning ?>
```

⁷⁸ Valid Unicode characters consist of the following Unicode code points: #x9, #xA, #xD, #x20-#xD7FF, #xE000-#xFFFF, #x10000-#x10FFFF.

XMLROW

The XMLROW function returns an XML value that is a well-formed XML document.

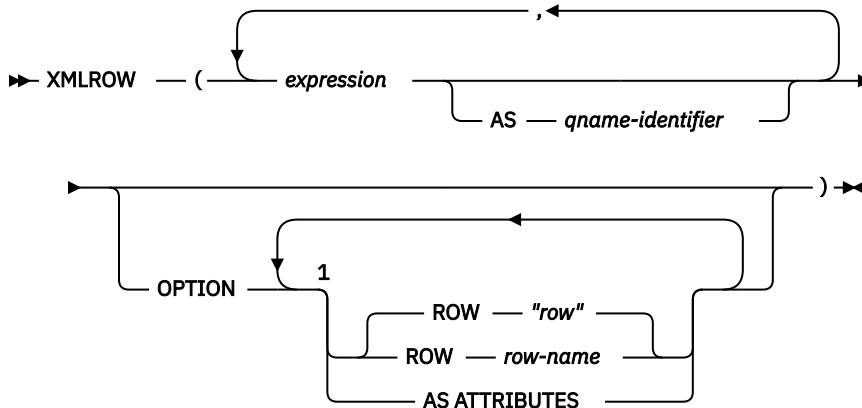

Notes:

¹ The same clause must not be specified more than once.

expression

The content of each XML element is specified by an expression. The data type of *expression* must not be ROWID or DATALINK or a distinct type that is based on ROWID or DATALINK. When AS ATTRIBUTES is specified, the data type of *expression* must not be XML or a distinct type that is based on XML. The expression can be any SQL expression. If the expression is not a simple column reference, an element name must be specified.

AS qname-identifier

Specifies the XML element name or attribute name as an SQL identifier. The *qname-identifier* must be of the form of an XML qualified name, or QName. See the W3C XML namespace specifications for more details on valid names. If the name is qualified, the namespace prefix must be declared within the scope. If *qname-identifier* is not specified, *expression* must be a column name. The element name or attribute name is created from the column name using the fully escaped mapping from a column name to a QName.

OPTION

Specifies additional options for constructing the XML value. If no OPTION clause is specified, the default behavior applies.

ROW row-name

Specifies the name of the element to which each row is mapped. If this option is not specified, the default element name is "row".

AS ATTRIBUTES

Specifies that each expression is mapped to an attribute value with column name or *qname-identifier* serving as the attribute name. AS ATTRIBUTES cannot be specified if any expression has a result data type of XML.

The result is an XML sequence containing the concatenation of the non-null input XML values.

The result of the function is an XML value. Null values in the input are ignored. If the result of any *expression* can be null, the result can be null; if the result of every *expression* is null, the result is the null value.

Notes

By default, each row in the result set is mapped to an XML value as follows:

- Each row is transformed into an XML element named "row" and each *expression* is transformed into a nested element with the column name or *qname-identifier* as the element name.

- The null handling behavior is NULL ON NULL. A null value for an expression maps to the absence of the subelement. If all expression values are null, the function returns a null value.
- The binary encoding scheme for binary and FOR BIT DATA data types is base64Binary encoding.

Examples

Assume the following table T1 with columns C1 and C2:

C1	C2
1	2
-	2
1	-
-	-

- The following example shows an XMLROW query and output fragment with default behavior, using a sequence of row elements to represent the table:

```
SELECT XMLROW(C1, C2) FROM T1
```

```
<row><C1>1</C1><C2>2</C2></row>
<row><C2>2</C2></row>
<row><C1>1</C1></row>
-
```

- The following example shows an XMLROW query and output fragment with attribute centric mapping. Instead of appearing as nested elements, data is mapped to element attributes:

```
SELECT XMLROW(C1, C2 OPTION AS ATTRIBUTES) FROM T1
```

```
<row C1="1" C2="2"/>
<row C2="2"/>
<row C1="1"/>
-
```

- The following example shows an XMLROW query and output fragment with the default <row> element replaced by <entry>. Columns C1 and C2 are returned as <column1> and <column2> elements, and the total of C1 and C2 is returned inside a <total> element:

```
SELECT XMLROW(C1 AS "column1", C2 AS "column2",
              C1+C2 AS "total" OPTION ROW "entry") FROM T1
```

```
<entry><column1>1</column1><column2>2</column2><total>3</total></entry>
<entry><column2>2</column2></entry>
<entry><column1>1</column1></entry>
-
```

XMLSERIALIZE

The XMLSERIALIZE function returns a serialized XML value of the specified data type generated from the *XML-expression* argument.

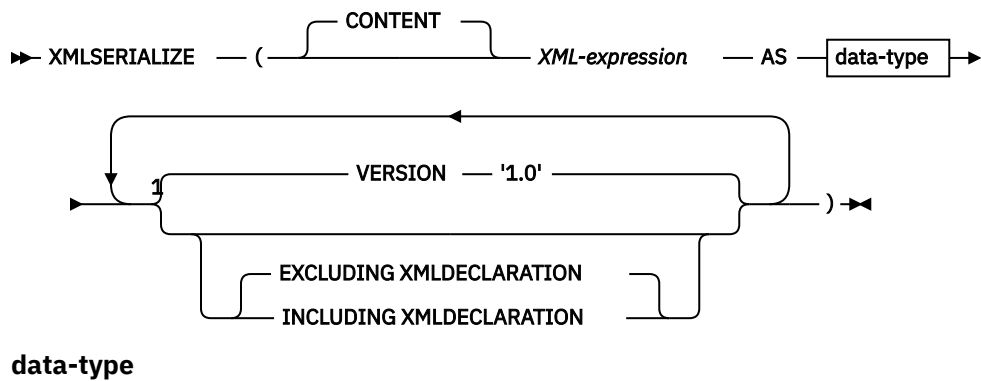

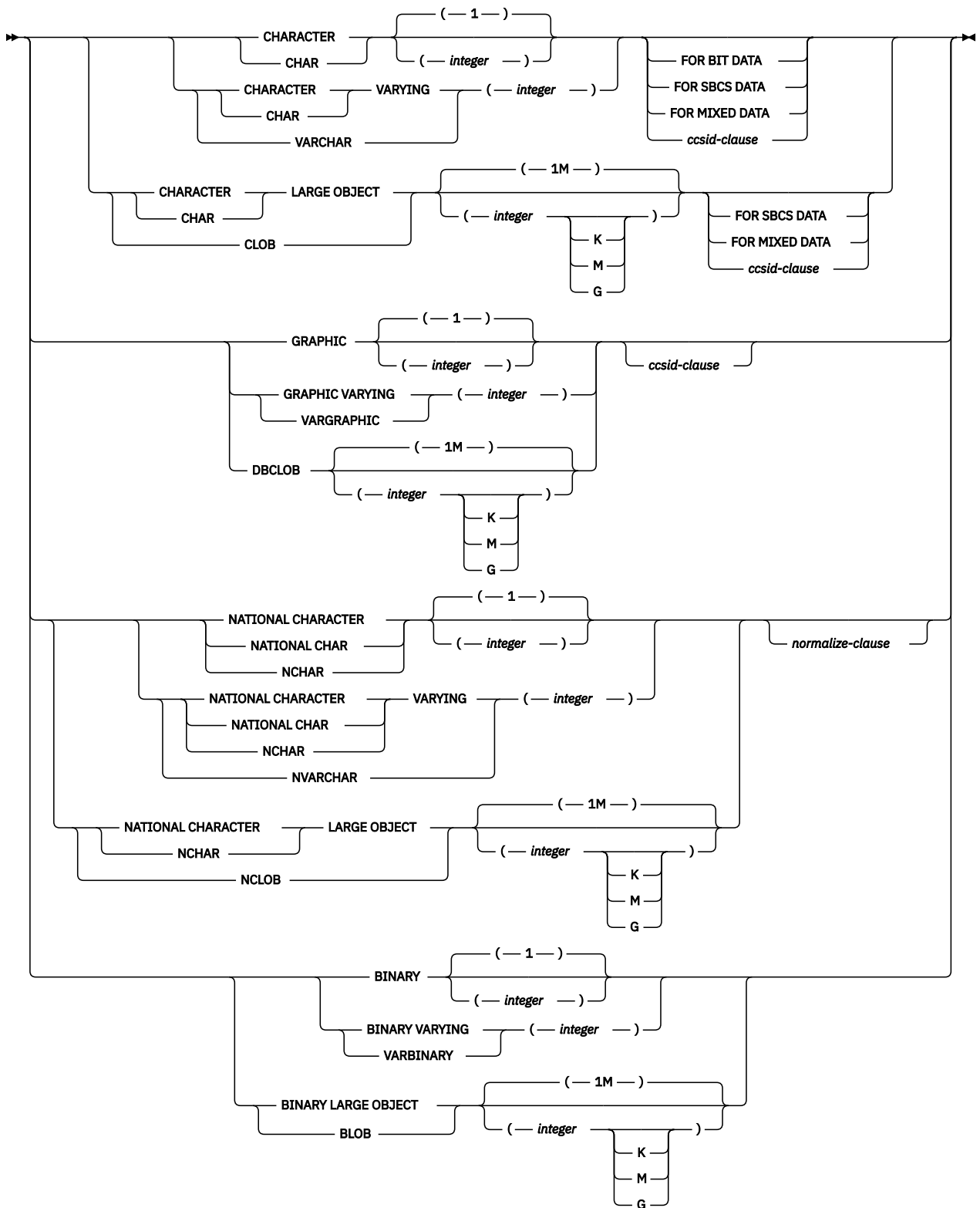

Notes:

¹ The same clause must not be specified more than once.

ccsid-clause

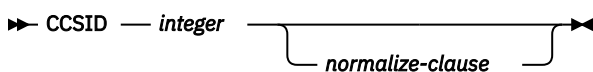

normalize-clause

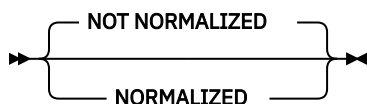

CONTENT

Specifies that any XML value can be specified and the result of the serialization is based on this input value.

XML-expression

An expression that returns a value that is a built-in XML string. This is the input to the serialization process.

AS data-type

Specifies the result type. The implicit or explicit length attribute of the specified result data type must be sufficient to contain the serialized output.

If a CCSID is specified and the *data-type* is GRAPHIC, VARGRAPHIC, or DBCLOB, the CCSID must be a Unicode CCSID.

If the CCSID attribute is not specified, the CCSID is determined as described in [“CAST specification” on page 177](#).

VERSION '1.0'

Specifies the XML version of the serialized value. The only version supported is '1.0' which must be specified as a string constant.

EXCLUDING XMLDECLARATION or INCLUDING XMLDECLARATION

Specifies whether an XML declaration is included in the result. The default is EXCLUDING XMLDECLARATION.

EXCLUDING XMLDECLARATION

Specifies that an XML declaration is not included in the result.

INCLUDING XMLDECLARATION

Specifies that an XML declaration is included in the result. The XML declaration is the string '<?xml version="1.0" encoding="encoding-name"?>', where *encoding-name* matches the CCSID of the result data type.

If the result of *XML-expression* can be null, the result can be null; if the result of *XML-expression* is null, the result is the null value.

Examples

Example 1: Serialize into CLOB of UTF-8, the XML value that is returned by the XMLELEMENT function, which is a simple XML element with "Emp" as the element name and an employee name as the element content:

```
SELECT e.empno, XMLSERIALIZE(XMLELEMENT(NAME "Emp",
                                         e.firstnme || ' ' || e.lastname)
                           AS CLOB(100) CCSID 1208) AS "result"
FROM employee e WHERE e.lastname = 'SMITH'
```

The result looks similar to the following results:

EMPNO	result
000250	<Emp>DANIEL SMITH</Emp>
000300	<Emp>PHILIP SMITH</Emp>

Example 2: Serialize into a string of BLOB type, the XML value that is returned by the XMLELEMENT function:

```
SELECT XMLSERIALIZE(XMLELEMENT(NAME "Emp",
                               e.firstnme || ' ' || e.lastname)
```

```

AS BLOB(1K)
VERSION '1.0') AS "result"
FROM employee e WHERE e.empno = '000300'

```

The result looks similar to the following results:

```

result
-----
<Emp>PHILIP SMITH</Emp>

```

Example 3: Serialize into a string of CLOB type, the XML value that is returned by the XMLELEMENT function. Include the XMLDECLARATION:

```

SELECT e.empno, e.firstnme, e.lastname,
XMLSERIALIZE(XMLELEMENT(NAME "xmp:Emp",
XMLNAMESPACES('http://www.xmp.com' as "xmp"),
XMLATTRIBUTES(e.empno as "serial"),
e.firstnme, e.lastname
OPTION NULL ON NULL)
AS CLOB(1000) CCSID 1208
INCLUDING XMLDECLARATION) AS "Result"
FROM employee e WHERE e.empno = '000300'

```

The result looks similar to the following results:

EMPNO	FIRSTNME	LASTNAME	Result
000300	PHILIP	SMITH	<?xml version="1.0" encoding="UTF-8" ?> <xmp:Emp xmlns:xmp="http://www.xmp.com" serial="000300">PHILIPSMITH</xmp:Emp>

XMLTEXT

The XMLTEXT function returns an XML value that contains the value of *string-expression*.

►► XMLTEXT — (— *string-expression* —) ◄◄

string-expression

An expression that returns a value of a built-in character or graphic string. It cannot be CHAR or VARCHAR bit data.

The result of the function is an XML value. If the result of *string-expression* can be null, the result can be null; if the result of *string-expression* is null, the result is the null value. If the result of *string-expression* is an empty string, the result value is empty text.

Example

- Create a simple XMLTEXT query.

```
VALUES (XMLTEXT ('The stock symbol for Johnson&Johnson is JNJ.'))
```

This query produces the following serialized result:

```
The stock symbol for Johnson&Johnson is JNJ.
```

Note that the '&' sign is mapped to '&,' when the text is serialized.

- Use XMLTEXT with XMLAGG to construct mixed content. Suppose that the content of table T is as follows:

SEQNO	PLAINTEXT	EMPHTEXT
1	This query shows how to construct	mixed content
2	using XMLAGG and XMLTEXT. Without	XMLTEXT
3	, XMLAGG will not have text nodes to group with other nodes, therefore, cannot generate	mixed content

```
SELECT XMLELEMENT(NAME "para",
                  XMLAGG(XMLCONCAT(
                              XMLTEXT(PLAINTEXT),
                              XMLELEMENT(
                                  NAME "emphasis", EMPHTEXT))
                          ORDER BY SEQNO), '.') AS "result"
FROM T
```

This query produces the following result:

```
result
-----
<para>This query shows how to construct <emphasis>mixed content</emphasis>
using XMLAGG and XMLTEXT. Without <emphasis>XMLTEXT</emphasis>, XMLAGG
will not have text nodes to group with other nodes, therefore, cannot generate
<emphasis>mixed content</emphasis>.</para>
```

XMLVALIDATE

The XMLVALIDATE function returns a copy of the input XML value augmented with information obtained from XML schema validation, including default values and type annotations.

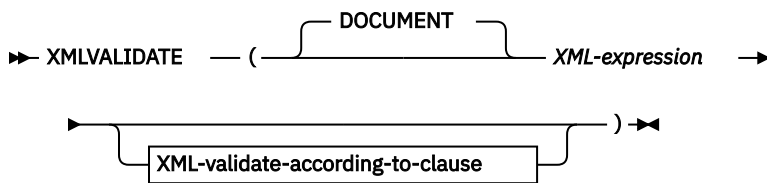

XML-validate-according-to-clause

ACCORDING TO XMLSCHEMA →

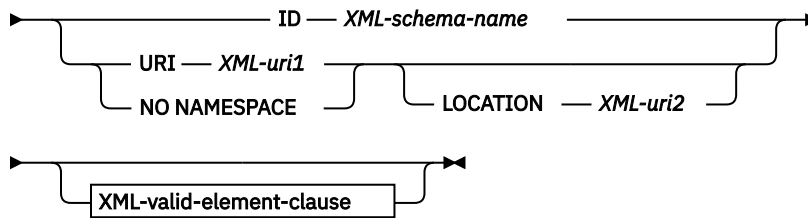

XML-valid-element-clause

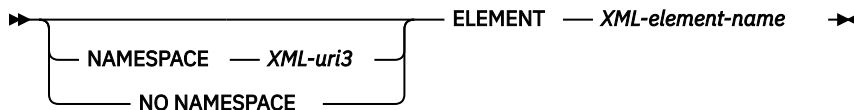

DOCUMENT

Specifies that the XML value resulting from *XML-expression* must be a well-formed XML document that conforms to XML Version 1.0.

XML-expression

An expression that returns a value of data type XML. If *XML-expression* is an XML host variable or an implicitly or explicitly typed parameter marker, the function performs a validating parse that strips ignorable whitespace and the CURRENT IMPLICIT XMLPARSE OPTION setting is not considered.

XML-validate-according-to-clause

Specifies the information that is to be used when validating the input XML value.

ACCORDING TO XMLSCHEMA

Indicates that the XML schema information for validation is explicitly specified. If this clause is not included, the XML schema information must be provided in the content of the *XML-expression* value.

ID XML-schema-name

Specifies an SQL identifier for the XML schema that is to be used for validation. The name, including the implicit or explicit SQL schema qualifier, must uniquely identify an existing XML schema in the XML schema repository at the current server. If no XML schema by this name exists in the implicitly or explicitly specified SQL schema, an error is returned.

URI XML-uri1

Specifies the target namespace URI of the XML schema that is to be used for validation. The value of *XML-uri1* specifies a URI as a character string constant that is not empty. The URI must be the target namespace of a registered XML schema and, if no LOCATION clause is specified, it must uniquely identify the registered XML schema.

NO NAMESPACE

Specifies that the XML schema for validation has no target namespace. The target namespace URI is equivalent to an empty character string that cannot be specified as an explicit target namespace URI.

LOCATION XML-uri2

Specifies the XML schema location URI of the XML schema that is to be used for validation. The value of *XML-uri2* specifies a URI as a character string constant that is not empty. The XML schema location URI, combined with the target namespace URI, must identify a registered XML schema, and there must be only one such XML schema registered.

XML-valid-element-clause

Specifies that the XML value in *XML-expression* must have the specified element name as the root element of the XML document.

NAMESPACE XML-uri3 or NO NAMESPACE

Specifies the target namespace for the element that is to be validated. If neither clause is specified, the specified element is assumed to be in the same namespace as the target namespace of the registered XML schema that is to be used for validation.

NAMESPACE XML-uri3

Specifies the namespace URI for the element that is to be validated. The value of *XML-uri3* specifies a URI as a character string constant that is not empty. This can be used when the registered XML schema that is to be used for validation has more than one namespace.

NO NAMESPACE

Specifies that the element for validation has no target namespace. The target namespace URI is equivalent to an empty character string which cannot be specified as an explicit target namespace URI.

ELEMENT xml-element-name

Specifies the name of a global element in the XML schema that is to be used for validation. The specified element, with implicit or explicit namespace, must match the root element of the value of *XML-expression*.

The result of the function is XML. If the value of *XML-expression* can be null, the result can be null; if the value of *XML-expression* is null, the result is the null value. The CCSID of the result is determined from the *XML-expression*.

The XML validation process is performed on a serialized XML value. Because XMLVALIDATE is invoked with an argument of type XML, this value is automatically serialized prior to validation processing with the following two exceptions:

- If the argument to XMLVALIDATE is an XML host variable or an implicitly or explicitly typed parameter marker, then a validating parse operation is performed on the input value (no implicit non-validating parse is performed and the CURRENT IMPLICIT XMLPARSE OPTION setting is not considered).
- If the argument to XMLVALIDATE is an XMLPARSE invocation using the option PRESERVE WHITESPACE, then the XML parsing and XML validation of the document may be combined into a single validating parse operation.

To validate a document whose root element does not have a namespace, an `xsi:noNamespaceSchemaLocation` attribute must be present on the root element.

Notes

Determining the XML schema: The XML schema can be specified explicitly as part of the XMLVALIDATE invocation or determined from the XML schema information in the input XML value. If the XML schema information is not specified during invocation, the target namespace and the schema location in the input XML value are used to identify the registered schema for validation. If an explicit XML schema is not specified, the input XML value must contain an XML schema information hint. Explicit or implicit XML schema information must identify a registered XML schema, and there must be only one such registered XML schema.

If you do not specify an XML schema document, the database server looks in the input document for an `xsi:schemaLocation` attribute that specifies a namespace and location hint for the XML schema. When there is no target namespace for the XML schema, the `xsi:noNamespaceSchemaLocation` attribute is used to specify a location hint for the XML schema.

xsi:schemaLocation or *xsi:noNamespaceSchemaLocation* attributes are defined by the W3C XML schema specification and are called XML schema hints. An *xsi:schemaLocation* attribute contains one or more pairs of values that help to locate the XML schema document. The first value in each pair is a namespace and the second value is a hint that indicates where to find the XML schema for the namespace. Db2 for i will attempt to match a namespace and location hint to an XML schema, using the primary XML schema document's target namespace and the *schemalocation* parameter that was supplied on the XSR_REGISTER procedure call.

If an XML schema document is specified in the XMLVALIDATE function, it overrides the *xsi:schemaLocation* or *xsi:noNamespaceSchemaLocation* attribute.

If *xsi:schemaLocation* and *xsi:noNamespaceSchemaLocation* attributes are not defined by the XML document, Db2 for i will attempt to locate an XML schema where the target namespace of the primary XSD matches a namespace in the XML document.

Specifying the XML schema explicitly in the XMLVALIDATE function avoids the parsing required to locate the XML schema information hint in the XML value.

XML schema authorization: The XML schema used for validation must be registered in the XML schema repository prior to use. The privileges held by the authorization ID of the statement must include at least one of the following:

- USAGE privilege on the XML schema that is to be used during validation
- Database administrator authority

Examples

- Validate using the XML schema identified by the XML schema hint in the XML instance document.

```
INSERT INTO T1(XMLCOL)
VALUES (XMLVALIDATE(?))
```

Assume that the input parameter marker is bound to an XML value that contains the XML schema information.

```
<po:order
  xmlns:po='http://my.world.com'
  xmlns:xsi="http://www.w3.org/2001/XMLSchema-instance"
  xsi:schemaLocation="http://my.world.com/world.xsd" >
  ...
</po:order>
```

Further, assume that the XML schema that is associated with the target namespace "http://my.world.com" and by schemaLocation hint "http://my.world.com/world.xsd" is found in the XML schema repository

Based on these assumptions, the input XML value will be validated according to that XML schema.

- Validate using the XML schema identified by the SQL name PODOCS.WORLDPO

```
INSERT INTO T1(XMLCOL)
VALUES(
  XMLVALIDATE(? ACCORDING TO XMLSCHEMA ID PODOCS.WORLDPO))
```

Assuming that the XML schema that is associated with SQL name PODOC.WORLDPO is found in the XML schema repository, the input XML value will be validated and the type annotated according to that XML schema.

- Validate a specified element of the XML value.

```
INSERT INTO T1(XMLCOL)
VALUES(
  XMLVALIDATE(?
    ACCORDING TO XMLSCHEMA ID F00.WORLDPO
    NAMESPACE 'http://my.world.com/Mary'
    ELEMENT "po"))
```

Assuming that the XML schema that is associated with SQL name FOO.WORLDPO is found in the XML schema repository, the XML schema will be validated against the element "po", whose namespace is "http://my.world.com/Mary".

- XML schema is identified by target namespace and schema location.

```
INSERT INTO T1(XMLCOL)
VALUES(
XMLVALIDATE(?
ACCORDING TO XMLSCHEMA URI 'http://my.world.com'
LOCATION 'http://my.world.com/world.xsd'))
```

Assuming that an XML schema associated with the target namespace "http://my.world.com" and by schemaLocation hint "http://my.world.com/world.xsd" is found in the XML schema repository, the input XML value will be validated according to that XML schema.

XOR

The XOR function returns a string that is the logical XOR of the argument strings. This function takes the first argument string, does an XOR operation with the next string, and then continues to do XOR operations for each successive argument using the previous result. If a character-string argument is shorter than the previous result, it is padded with blanks. If a binary-string argument is shorter than the previous result, it is padded with hexadecimal zeros.

►► XOR (— *expression* — , — *expression* —) ◄◄

The arguments must be compatible.

expression

An expression that returns a value of any built-in numeric or string data type, but cannot be LOBs. The arguments cannot be mixed data character strings, UTF-8 character strings, or graphic strings. A numeric argument is cast to a character string before evaluating the function. For more information about converting numeric to a character string, see [“VARCHAR” on page 616](#).

The arguments are converted, if necessary, to the attributes of the result. The attributes of the result are determined as follows:

- If all the arguments are fixed-length strings, the result is a fixed-length string of length n , where n is the length of the longest argument.
- If any argument is a varying-length string, the result is a varying-length string with length attribute n , where n is the length attribute of the argument with greatest length attribute. The actual length of the result is m , where m is the actual length of the longest argument.

If an argument can be null, the result can be null; if an argument is null, the result is the null value.

The CCSID of the result is 65535.

Example

- Assume the host variable L1 is a CHARACTER(2) host variable with a value of X'E1E1', host variable L2 is a CHARACTER(3) host variable with a value of X'F0F00', and host variable L3 is a CHARACTER(4) host variable with a value of X'0000000F'.

```
SELECT XOR(:L1, :L2, :L3)
FROM SYSIBM.SYSDUMMY1
```

Returns the value X'1111404F'.

XSLTRANSFORM

The XSLTRANSFORM transforms an XML document into a different data format. The data can be transformed into any form possible for the XSLT processor, including but not limited to XML, HTML, or plain text.

►► XSLTRANSFORM (— *XML-document* — USING — *xsl-stylesheet* — ►

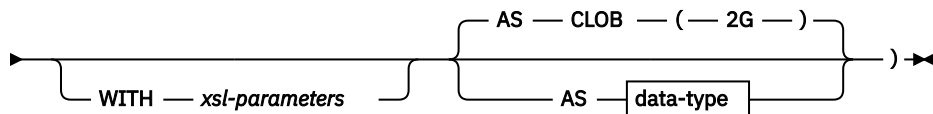

data-type

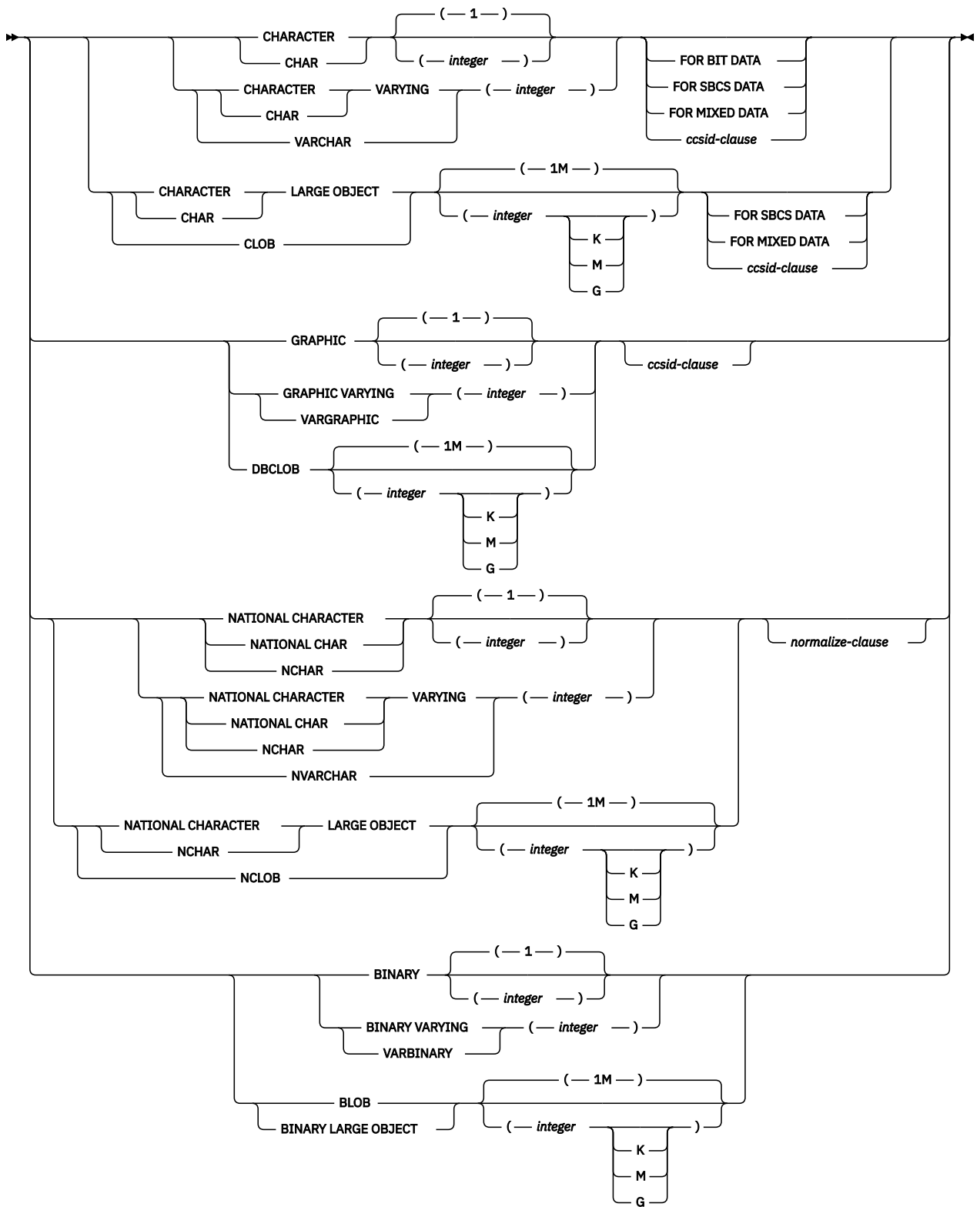

ccsid-clause

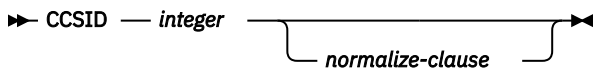

normalize-clause

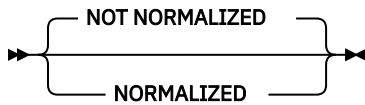

Use XSLTRANSFORM to convert XML data into other formats including the conversion of XML documents that conform to one XML schema into documents that conform to another XML schema.

XML-document

A character string, Unicode graphic string, binary string, or XML expression that returns a well-formed XML document. This is the document that is transformed using the XSL style sheet specified in *xsl-stylesheet*.

xsl-stylesheet

A character string, Unicode graphic string, binary string, or XML expression that returns a well-formed XML document. The document is an XSL style sheet that conforms to the XSLT Version 1.10 Recommendation. Style sheets incorporating the *xsl:include* declaration are not supported. This stylesheet is applied to transform the value specified in *xml-document*.

xsl-parameters

A character string, Unicode graphic string, binary string, or XML expression that returns a well-formed XML document. This is a document that provides parameter values to the XSL stylesheet specified in *xsl-stylesheet*. The value of the parameter can be specified as an attribute or as text.

The syntax of the parameter document is as follows:

```
<params xmlns="http://www.ibm.com/XSLTransformParameters">
<param name="..." value="..."/>
<param name="...">enter value here</param> ... </params>
```

Note: The stylesheet document must have *xsl:param* element(s) in it with name attribute values that match the ones specified in the parameter document.

AS data-type

Specifies the result data type. The implicit or explicit length attribute of the specified result data type must be sufficient to contain the transformed output. The default result data type is CLOB(2G).

If a CCSID is specified and the *data-type* is GRAPHIC, VARGRAPHIC, or DBCLOB, the CCSID must be a Unicode CCSID.

If the CCSID attribute is not specified, the CCSID is determined as if the *XML-document* was cast to *data-type* as described in [“CAST specification” on page 177](#).

The result of the function has the data type specified. CCSID conversion that results in data loss can occur when storing any of the above documents in a character data type.

If either *XML-document* or *xsl-stylesheet* is null, the result is the null value.

Note

Prerequisites: In order to use the XSLTRANSFORM function, the XML Toolkit for IBM i and International Components for Unicode (ICU option) must be installed.

Example

This example illustrates how to use XSLT as a formatting engine. To get set up, first insert the two example documents below into the database.

```
CREATE TABLE XML_TAB (c1 INT, xml_doc CLOB(2M), xsl_doc CLOB(256K));
INSERT INTO XML_TAB VALUES
(1, '<?xml version="1.0"?>
<students xmlns:xsi="http://www.w3.org/2001/XMLSchema-instance"
xsi:noNamespaceSchemaLocation = "/home/steffen/xsd/xslt.xsd">
<student studentID="1" firstName="Steffen" lastName="Siegmund"
age="23" university="Rostock"/>
</students>',
```

```
'<?xml version="1.0" encoding="UTF-8"?>
<xsl:stylesheet version="1.0"
  xmlns:xsl="http://www.w3.org/1999/XSL/Transform">
<xsl:param name="headline"/>
<xsl:param name="showUniversity"/>

  <xsl:template match="students">
    <html>
      <head/>
      <body>
        <h1><xsl:value-of select="$headline"/></h1>
        <table border="1">
          <thead>
            <tr>
              <td width="80">StudentID</td>
              <td width="200">First Name</td>
              <td width="200">Last Name</td>
              <td width="50">Age</td>
              <xsl:choose>
                <xsl:when test="$showUniversity = 'true'">
                  <td width="200">University</td>
                </xsl:when>
              </xsl:choose>
            </tr>
          </thead>
          <xsl:apply-templates/>
        </table>
      </body>
    </html>
  </xsl:template>
  <xsl:template match="student">
    <tr>
      <td><xsl:value-of select="@studentID"/></td>
      <td><xsl:value-of select="@firstName"/></td>
      <td><xsl:value-of select="@lastName"/></td>
      <td><xsl:value-of select="@age"/></td>
      <xsl:choose>
        <xsl:when test="$showUniversity = 'true'">
          <td><xsl:value-of select="@university"/></td>
        </xsl:when>
      </xsl:choose>
    </tr>
  </xsl:template>
</xsl:stylesheet>');
```

Next, call the XSLTRANSFORM function to convert the XML data into HTML and display it.

```
SELECT XSLTRANSFORM (XML_DOC USING XSL_DOC
  WITH '<params xmlns="http://www.ibm.com/XSLTransformParameters"></params>')
FROM XML_TAB;
```

The result is this document:

```
<html>
<head>
<META http-equiv="Content-Type" content="text/html; charset=UTF-8">
</head>
<body>
<h1></h1>
<table border="1">
  <thead>
    <tr>
      <td width="80">StudentID</td>
      <td width="200">First Name</td>
      <td width="200">Last Name</td>
      <td width="50">Age</td>
    </tr>
  </thead>
  <tr>
    <td>1</td>
    <td>Steffen</td>
    <td>Siegmond</td>
    <td>23</td>
  </tr>
</table>
</body>
</html>
```

In this example, the output is HTML and the parameters influence only what HTML is produced and what data is brought over to it. As such it illustrates the use of XSLT as a formatting engine for end-user output.

YEAR

The YEAR function returns the year part of a value.

►► YEAR — (— *expression* —) ◄◄

expression

An *expression* that returns a value of one of the following built-in data types: a date, a timestamp, a character string, a graphic string, or a numeric data type.

- If *expression* is a character or graphic string, its value must be a valid string representation of a date or timestamp. For the valid formats of string representations of dates and timestamps, see [“String representations of datetime values”](#) on page 75.
- If *expression* is a number, it must be a date duration or timestamp duration. For the valid formats of datetime durations, see [“Datetime operands and durations”](#) on page 166.

The result of the function is a large integer. If the argument can be null, the result can be null; if the argument is null, the result is the null value.

The other rules depend on the data type of the argument:

- If the argument is a date or a timestamp or a valid character-string representation of a date or timestamp:

The result is the year part of the value, which is an integer between 1 and 9999.

- If the argument is a date duration or timestamp duration:

The result is the year part of the value, which is an integer between -9999 and 9999. A nonzero result has the same sign as the argument.

Examples

- Select all the projects in the PROJECT table that are scheduled to start (PRSTDATE) and end (PRENDATE) in the same calendar year.

```
SELECT *
FROM PROJECT
WHERE YEAR(PRSTDATE) = YEAR(PRENDATE)
```

- Select all the projects in the PROJECT table that are scheduled to take less than one year to complete.

```
SELECT *
FROM PROJECT
WHERE YEAR(PRENDATE - PRSTDATE) < 1
```

ZONED

The ZONED function returns a zoned decimal representation.

Numeric to Zoned Decimal

►► ZONED — (— *numeric-expression* →

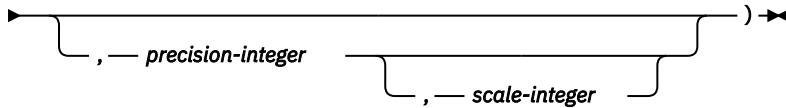

String to Zoned Decimal

►► ZONED — (— *string-expression* →

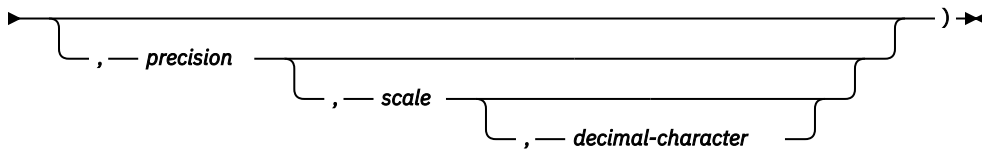

Datetime to Decimal

►► ZONED — (— *datetime-expression* →

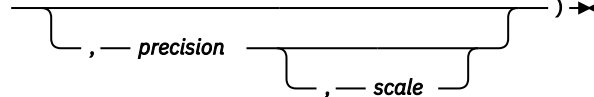

The ZONED function returns a zoned decimal representation of:

- A number
- A character or graphic string representation of a decimal number
- A character or graphic string representation of an integer
- A character or graphic string representation of a floating-point number
- A character or graphic string representation of a decimal floating-point number
- A date
- A time
- A timestamp

Numeric to Zoned Decimal

numeric-expression

An expression that returns a value of any built-in numeric data type.

precision

An integer constant with a value greater than or equal to 1 and less than or equal to 63.

The default for *precision* depends on the data type of the *numeric-expression*:

- 5 for small integer
- 11 for large integer
- 19 for big integer
- 15 for floating point, decimal, numeric, or nonzero scale binary
- 31 for decimal floating point

scale

An integer constant that is greater than or equal to 0 and less than or equal to *precision*. If not specified, the default is 0.

The result is the same number that would occur if the first argument were assigned to a decimal column or variable with a precision of *precision* and a scale of *scale*. An error is returned if the number of significant decimal digits required to represent the whole part of the number is greater than *precision-scale*. If the first argument can be null, the result can be null; if the first argument is null, the result is the null value.

String to Zoned Decimal***string-expression***

An expression that returns a value that is a character-string or graphic-string representation of a number. Leading and trailing blanks are eliminated and the resulting string must conform to the rules for forming a floating-point, decimal floating-point, integer, or decimal constant.

precision

An integer constant that is greater than or equal to 1 and less than or equal to 63. If not specified, the default is 15.

scale

An integer constant that is greater than or equal to 0 and less than or equal to *precision*. If not specified, the default is 0.

decimal-character

Specifies the single-byte character constant that was used to delimit the decimal digits in *string-expression* from the whole part of the number. The character must be a period or comma. If the second argument is not specified, the decimal point is the default decimal separator character. For more information, see [“Decimal point”](#) on page 118.

Digits are truncated from the end if the number of digits to the right of the *decimal-character* is greater than the scale *s*. An error is returned if the number of significant digits to the left of the *decimal-character* (the whole part of the number) in *string-expression* is greater than *precision-scale*. The default decimal separator character is not valid in the substring if the *decimal-character* argument is specified.

Datetime to Zoned Decimal***datetime-expression***

An expression that returns a value of type DATE, TIME, or TIMESTAMP.

precision

An integer constant that is greater than or equal to 1 and less than or equal to 63 that specifies the precision of the result. If not specified, the default for the precision and scale depends on the data type of *datetime-expression* as follows:

- Precision is 8 and scale is 0 for DATE. The result is a NUMERIC(8,0) value representing the date as *yyyymmdd*.
- Precision is 6 and scale is 0 for a TIME. The result is a NUMERIC(6,0) value representing the time as *hhmmss*.
- Precision is 14+*tp* and scale is *tp* for a TIMESTAMP(*tp*). The result is a NUMERIC(14+*tp*,*tp*) value representing the timestamp as *yyyymmddhhmmss.nnnnnnnnnnnn*.

scale

An integer constant that is greater than or equal to 0 and less than or equal to *precision*. If not specified and a *precision* is specified, the default is 0.

The result is the same number that would result from CAST(*datetime-expression* AS NUMERIC(*precision*,*scale*)). Digits are truncated from the end if the number of digits to the right of the decimal separator is greater than the scale *s*. An error is returned if the number of significant digits to the left of the decimal separator (the whole part of the number) in *datetime-expression* is greater than *precision - scale*.

The result of the function is a zoned decimal number with precision of *precision* and scale of *scale*. If the first argument can be null, the result can be null; if the first argument is null, the result is the null value.

Note

Syntax alternatives: The CAST specification should be used to increase the portability of applications when the precision is specified. For more information, see [“CAST specification” on page 177](#).

Examples

- Assume the host variable Z1 is a decimal host variable with a value of 1.123.

```
SELECT ZONED(:Z1,15,14)
FROM SYSIBM.SYSDUMMY1
```

Returns the value 1.123000000000000.

- Assume the host variable Z1 is a decimal host variable with a value of 1123.

```
SELECT ZONED(:Z1,11,2)
FROM SYSIBM.SYSDUMMY1
```

Returns the value 1123.00.

- Likewise,

```
SELECT ZONED(:Z1,4)
FROM SYSIBM.SYSDUMMY1
```

Returns the value 1123.

Table functions

Table functions return columns of a table and resemble a table created through a CREATE TABLE statement.

A table function can be used only in the FROM clause of an SQL statement. Table functions can be qualified with a schema name.

BASE_TABLE

The BASE_TABLE function returns the object names and schema names of the object found for an alias.

►► BASE_TABLE (— *object-schema* — , — *object-name* —) ◄◄

The schema is SYSPROC.

object-schema

A character or graphic string expression that identifies the SQL or system schema name used to qualify the supplied *object-name*. *object-schema* must have an actual length less than 129 characters. A special value of *LIBL may be specified, in which case, the first instance of a file named *object-name* found in the library list will be used. This name is case sensitive and must not be delimited.

object-name

A character or graphic string expression that identifies the SQL or system name of the object to be resolved. *object-name* must have an actual length less than 129 characters. This name is case sensitive and must not be delimited.

If the specified object does not refer to an alias or it is not found, the result of the function is the input object name and schema.

The result of the function is a table containing a single row with the format shown in the following table. All the columns are nullable.

Table 63. Format of the resulting table for BASE_TABLE

Column name	Data type	Contains
BASESCHEMA	VARCHAR(128)	Name of the SQL schema that contains the table or view referenced by the alias. This is <i>object-schema</i> if no alias was found. The name is undelimited and case sensitive.
BASENAME	VARCHAR(128)	Name of the table or view referenced by the alias. This is the <i>object-name</i> if no alias was found. The name is undelimited and case sensitive.
SYSTEM_TABLE_SCHEMA	CHAR(10)	System schema name. This column will contain the NULL value if no alias was found or if the alias references a remote RDB. The name may be delimited and is case sensitive.
SYSTEM_TABLE_NAME	CHAR(10)	System table name. This column will contain the NULL value if no alias was found or if the alias references a remote RDB. The name may be delimited and is case sensitive.
MEMBER_NAME	CHAR(10)	The member name that was identified for a member alias. This column will contain the NULL value if no alias was found or if the alias does not reference a specific member. The name may be delimited and is case sensitive.
RDBNAME	VARCHAR(128)	The RDB if the object is a three-part alias for a remote object. This column will contain the NULL value if no alias was found or there is no RDB is associated with the alias.

The CCSID of the result columns is the default CCSID at the current server.

Example

- The following query will return the base table information for every alias identified in SYSTABLES:

```
SELECT C.BASESCHEMA, C.BASENAME
FROM QSYS2.SYSTABLES A,
LATERAL (
    SELECT * FROM TABLE(SYSPROC.BASE_TABLE(A.TABLE_SCHEMA,A.TABLE_NAME)) AS X)
AS C
WHERE A.TABLE_TYPE='A'
```

JSON_TABLE

The JSON_TABLE table function returns a result table from the evaluation of SQL/JSON path expressions. Each item in the result sequence of the row SQL/JSON path expression represents one or many rows in the result table.

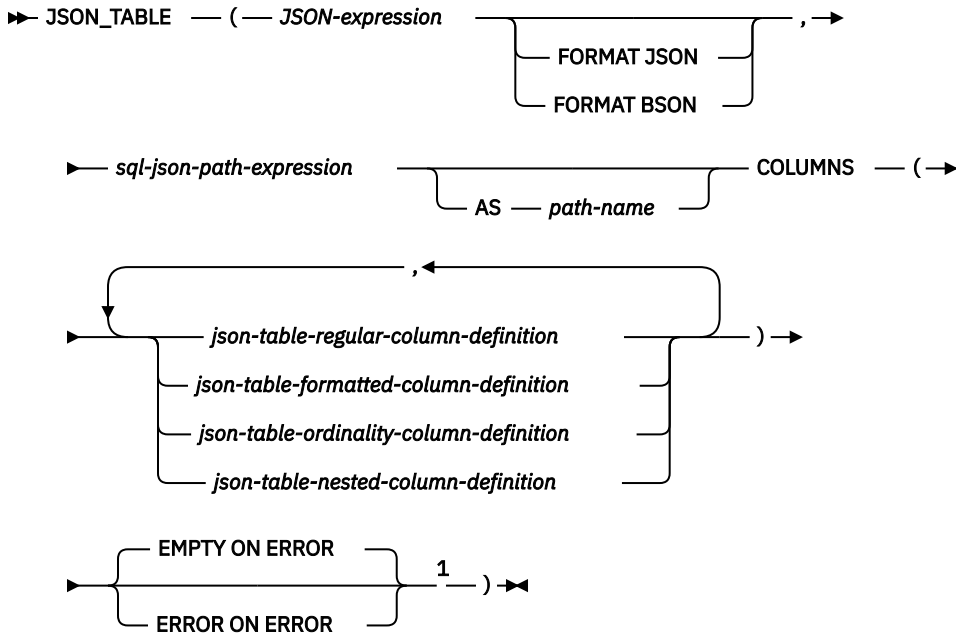

Notes:

¹ The ON ERROR clause can optionally be specified before the COLUMNS clause.

json-table-regular-column-definition

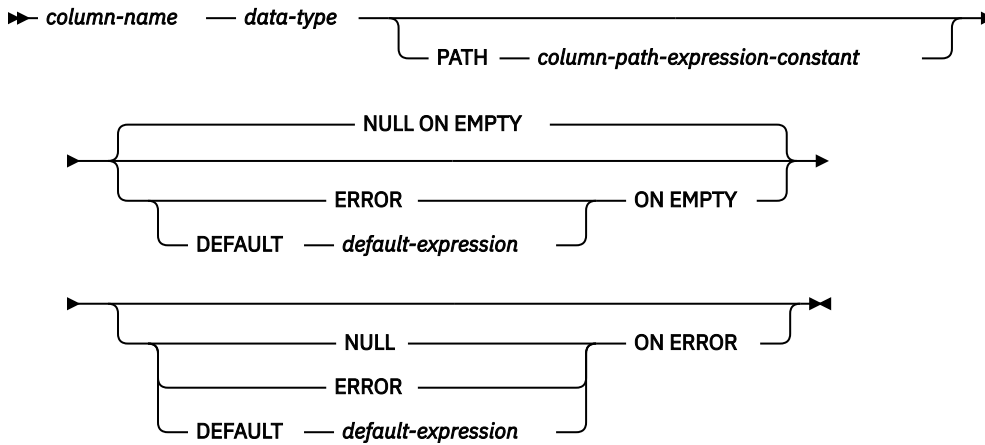

json-table-formatted-column-definition

►► *column-name* — *data-type* — FORMAT JSON →

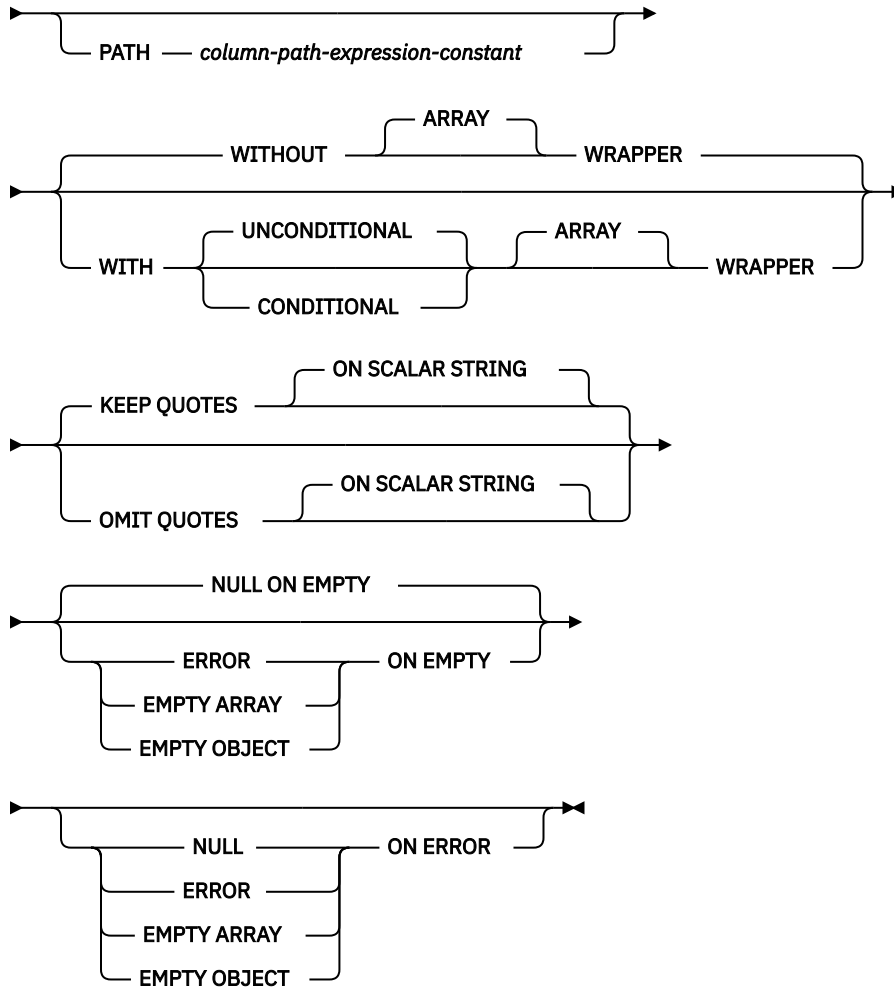

json-table-ordinality-column-definition

►► *column-name* — FOR ORDINALITY →◄

json-table-nested-column-definition

►► NESTED — PATH — *nested-path-expression-constant* →

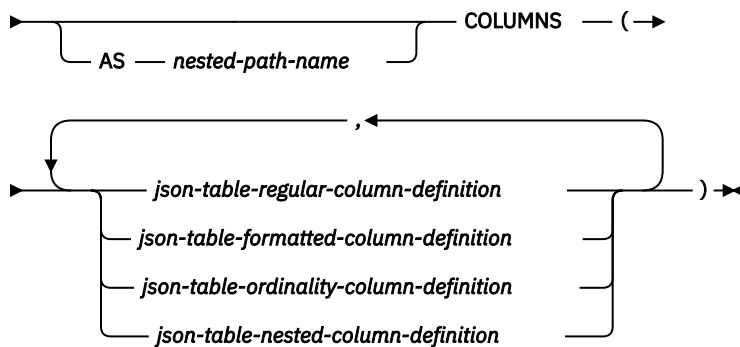

data-type

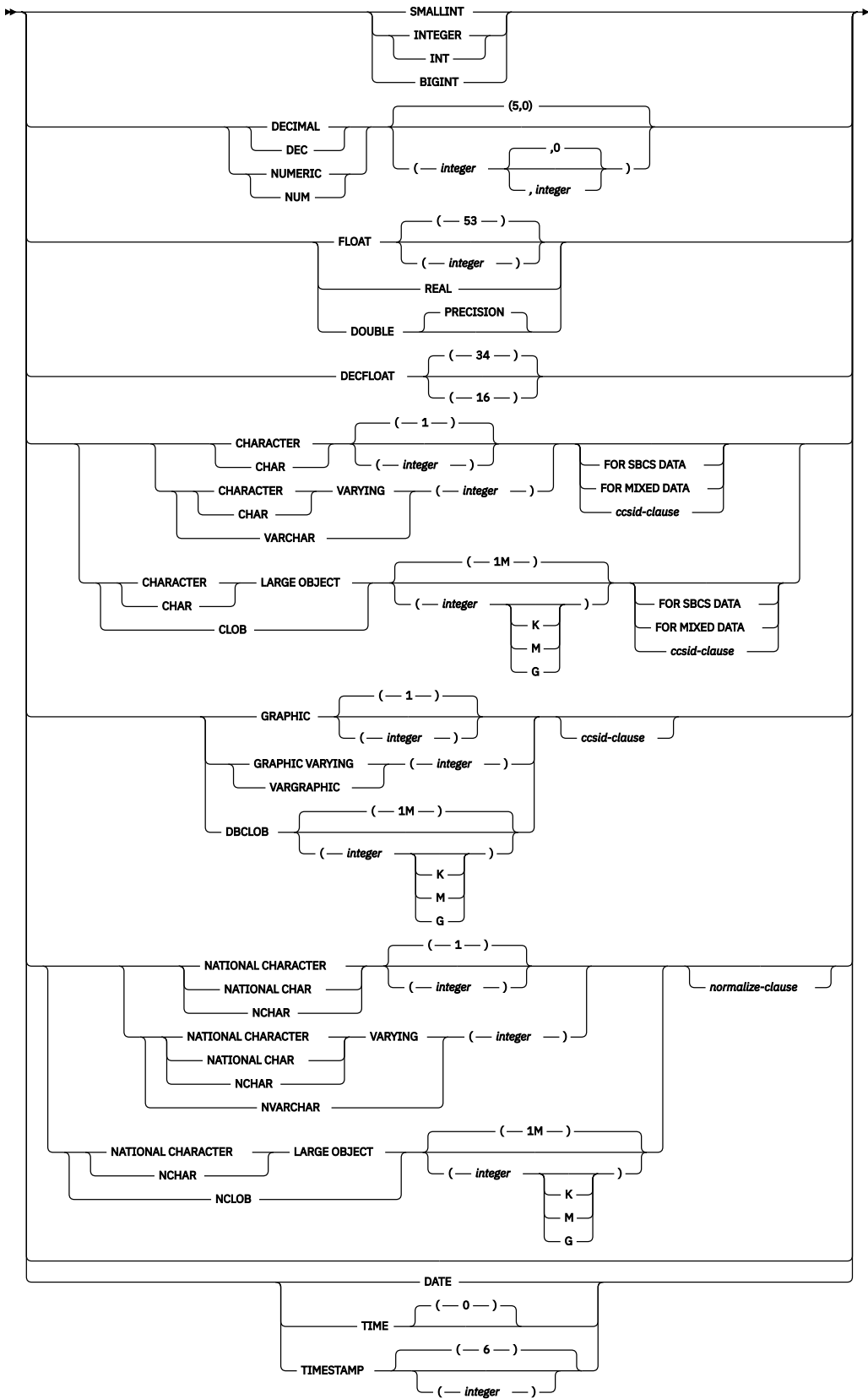

ccsid-clause

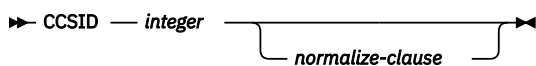

normalize-clause



JSON-expression

Specifies an expression that returns a character, graphic, or binary string value. If a character or graphic value is returned, it must contain a correctly formatted JSON object. If a binary value is returned, it must contain the BSON representation of a JSON object.

The *JSON-expression* specifies the initial context item for the *sql-json-path-expression*, identified within *sql-json-path-expression* as \$.

If *JSON-expression* is a JSON array, it will be implicitly wrapped using a key name of SYSIBM_ROOT_ARRAY modifying the *JSON-expression* to be a JSON object. Any path expressions provided to JSON_TABLE are implicitly modified to account for this additional key.

If *JSON-expression* does not contain correctly formatted data, JSON_TABLE returns an empty table unless a different error behavior is specified with an ON ERROR clause.

FORMAT JSON or FORMAT BSON

Specifies how *JSON-expression* is to be interpreted.

FORMAT JSON

Indicates that *JSON-expression* contains JSON data. If *JSON-expression* is binary data, the data is interpreted as UTF-8 or UTF-16. The binary data cannot be encoded using an EBCDIC CCSID.

FORMAT BSON

Indicates that *JSON-expression* contains the BSON representation of JSON data. When FORMAT BSON is specified, *JSON-expression* must be a binary string data type.

If the FORMAT clause is not specified and *JSON-expression* is a character or graphic string, *JSON-expression* is treated as JSON. If *JSON-expression* is a binary string, *JSON-expression* is treated as BSON.

sql-json-path-expression

Specifies a character or graphic string expression that is interpreted as an SQL/JSON path expression. This expression returns an output sequence where each item in the sequence is used by the column definitions to generate one or more rows in the output table. If the output sequence is empty, the result of JSON_TABLE is an empty table. *sql-json-path-expression* must not be an empty string or a string of all blanks.

For information on the content of an SQL/JSON path expression, see [“sql-json-path-expression” on page 214](#).

AS path-name

Specifies a name to be used to identify the *sql-json-path-expression*.

EMPTY ON ERROR or ERROR ON ERROR

Specifies the desired behavior of JSON_TABLE when a table level error is encountered.

EMPTY ON ERROR

An empty table is returned when a table level error is encountered. This is the default.

ERROR ON ERROR

An error is returned when a table level error is encountered.

COLUMNS

Specifies the output columns of the result table including the column name, data type, and how the column value is computed for each row.

The sum of all the result column lengths cannot exceed 64K bytes. For information on the byte counts of columns according to data type, see [“Maximum row sizes” on page 1154](#). This function can return up to approximately 200 columns, depending on the length of the column name and the length of the column path.

json-table-regular-column-definition

Specifies an output column of the result table including the column name, data type, and an SQL/JSON path expression to extract the value from the sequence item for the row.

column-name

Specifies the name of the column in the result table. The name cannot be qualified and the same name cannot be used for more than one column of the result table.

data-type

Specifies the data type of the column. For CHAR and VARCHAR columns, the CCSID cannot be 65535.

PATH column-path-expression-constant

Specifies a character or graphic string constant that is interpreted as an SQL/JSON path.

The *column-path-expression-constant* specifies an SQL/JSON path expression that determines the column value with respect to an item that is the result of evaluating the SQL/JSON path expression in *sql-json-path-expression*. Given an item from the result of processing the *sql-json-path-expression* as the externally provided context item, the *column-path-expression-constant* is evaluated and returns an output sequence. If a JSON object contains more than one value with the same key, only one of the values for the key will be returned for the output sequence.

The column value is determined based on this output sequence as follows:

- If an empty sequence is returned, the ON EMPTY clause provides the value of the column. If ERROR ON EMPTY is specified, an error is issued.
- If an empty sequence is returned and no ON EMPTY clause is specified, the null value is assigned to the column.
- If a single element sequence is returned and the type of the element is not a JSON array or a JSON object, the value is converted to the *data-type* specified for the column.
- If a single element sequence is returned and the type of the element is a JSON array or a JSON object, an error is returned.
- If a sequence with more than one element is returned, an error is returned.
- If an error occurs, the ON ERROR clause specifies the value of the column.

The value of *column-path-expression-constant* must not be an empty string or a string of all blanks. If the PATH clause is not specified, the *column-path-expression-constant* is defined as '\$.' prepended to the *column-name*.

ON EMPTY

Specifies the behavior when an empty sequence is returned for the column.

NULL ON EMPTY

An SQL null value is returned. This is the default.

ERROR ON EMPTY

An error is returned.

DEFAULT *default-expression* ON EMPTY

The value specified by *default-expression* is returned.

ON ERROR

Specifies the behavior when an error is returned for the column.

NULL ON ERROR

An SQL null value is returned. This is the default.

ERROR ON ERROR

An error is returned.

DEFAULT *default-expression* ON ERROR

The value specified by *default-expression* is returned.

If this clause is not specified:

- If a table level ERROR ON ERROR clause is specified, an error is returned.
- Otherwise, an SQL null value is returned.

json-table-formatted-column-definition

Specifies an output column of the result table including the column name, data type, and an SQL/JSON path expression to extract the value from the sequence item for the row. The extracted value is formatted as a JSON string.

column-name

Specifies the name of the column in the result table. The name cannot be qualified and the same name cannot be used for more than one column of the result table.

data-type

Specifies the data type of the column. The data type must be a character or graphic type. For CHAR and VARCHAR columns, the CCSID cannot be 65535.

FORMAT JSON

Indicates that the retrieved data should be formatted as a JSON string.

PATH *column-path-expression-constant*

Specifies a character or graphic string constant that is interpreted as an SQL/JSON path.

The *column-path-expression-constant* specifies an SQL/JSON path expression that determines the column value with respect to an item that is the result of evaluating the SQL/JSON path expression in *sql-json-path-expression* as well as all the paths specified by prior NESTED PATHs. Given an item from the result of processing the *sql-json-path-expression* as the externally provided context item, the *column-path-expression-constant* is evaluated and returns an output sequence. If a JSON object contains more than one value with the same key, only one of the values for the key will be returned for the output sequence.

The column value is determined based on this output sequence as follows:

- If an empty sequence is returned, the ON EMPTY clause provides the value of the column. If ERROR ON EMPTY is specified, an error is returned.
- If an empty sequence is returned and no ON EMPTY clause is specified, the null value is assigned to the column.
- If an error occurs, the ON ERROR clause specifies the value of the column.

The value for *column-path-expression-constant* must not be an empty string or a string of all blanks. If the PATH clause is not specified, the *column-path-expression-constant* is defined as '\$.' prepended to the *column-name*.

WITHOUT ARRAY WRAPPER or WITH ARRAY WRAPPER

Specifies whether the output value should be wrapped in a JSON array.

WITHOUT ARRAY WRAPPER

Indicates that the result is not wrapped. This is the default. Using an SQL/JSON path that results in a sequence of two or more SQL/JSON elements results in an error.

WITH UNCONDITIONAL ARRAY WRAPPER

Indicates that the result is enclosed in square brackets to create a JSON array.

WITH CONDITIONAL ARRAY WRAPPER

Indicates that the result is enclosed in square brackets to create a JSON array if more than one SQL/JSON element is returned.

KEEP QUOTES or OMIT QUOTES

Specifies whether the surrounding quotes should be removed when a scalar string is returned.

KEEP QUOTES

Indicates quotes are not removed from scalar strings. This is the default.

OMIT QUOTES

Indicates quotes are removed from scalar strings. When OMIT QUOTES is specified, the WITH ARRAY WRAPPER clause cannot be specified

ON EMPTY

Specifies the behavior when an empty sequence is returned for a column.

NULL ON EMPTY

An SQL null value is returned. This is the default.

ERROR ON EMPTY

An error is returned.

EMPTY ARRAY ON EMPTY

An empty JSON array is returned.

EMPTY OBJECT ON EMPTY

An empty JSON object is returned.

ON ERROR

Specifies the behavior when an error is returned for a column.

NULL ON ERROR

An SQL null value is returned.

ERROR ON ERROR

An error is returned.

EMPTY ARRAY ON ERROR

An empty JSON array is returned.

EMPTY OBJECT ON ERROR

An empty JSON object is returned.

If this clause is not specified:

- If a table level ERROR ON ERROR clause is specified, an error is returned.
- Otherwise, an SQL null value is returned.

json-table-ordinality-column-definition

Specifies an ordinality column of the result table.

column-name

Specifies the name of the column in the result table. The name cannot be qualified and the same name cannot be used for more than one column of the result table.

FOR ORDINALITY

Specifies that *column-name* is the ordinality column of the result table for the enclosing nesting level. The data type of this column is BIGINT.

- If the ordinality column is not within a nested column definition, the rows of the result table are numbered sequentially, starting with 1, and the ordinality column contains the sequential number of the current row.
- If the ordinality column is within a nested column definition, the rows produced by the enclosing nested column definition are numbered sequentially, starting with 1, and the ordinality column contains the sequential number of the current row. If the enclosing nested column definition is within an outer nested column definition, the numbering restarts with 1 each time the path expression of the enclosing nested column definition is applied to the result of the outer nested column definition.

json-table-nested-column-definition

Specifies one or more columns that are nested at the current level.

NESTED PATH *nested-path-expression-constant*

Specifies a character or graphic string constant that is interpreted as an SQL/JSON path. The *nested-path-expression-constant* specifies an SQL/JSON path expression that determines the column value with respect to an item that is the result of evaluating the SQL/JSON path expression in *sql-json-path-expression* as well as the *nested-path-expression-constant* from prior NESTED PATHs. Given an item from the result of processing the *sql-json-path-expression* as the externally provided context item and the *nested-path-expression-constant* from prior NESTED PATHs, the *nested-path-expression-constant* is evaluated and is used as the context for the nested columns.

AS nested-path-name

Specifies the name of the current path.

COLUMNS

Specifies the columns to be included in this nesting level.

Table 64. Supported JSON to SQL result column conversions

JSON type	SQL type	Notes
Number	SMALLINT INTEGER BIGINT	If the source value is beyond the range of the target data type, an overflow error is returned.
Number	DECIMAL NUMERIC	The resulting number value is converted, if necessary, to the precision and scale of the target data type. The necessary number of leading zeros are added or removed. In the fractional part of the number, the necessary number of trailing zeros are added or the necessary number of digits are eliminated. This truncation behavior is similar to the behavior of the cast from DECIMAL to DECIMAL.
Number	FLOAT DOUBLE REAL DECFLOAT	If the source value is beyond the range of the target data type, an overflow error is returned. If the source value contains more significant digits than the precision of the target data type, the source value is rounded to the precision of the target data type.
String or Number	CHAR VARCHAR CLOB GRAPHIC VARGRAPHIC DBCLOB	The resulting value is converted, if necessary, to the CCSID of the target data type using the rules described in “Conversion rules for assignments” on page 96 before it is converted to the target type with a limited length. Truncation occurs if the specified length limit is smaller than the length of the resulting string after CCSID conversion. A warning occurs if any non-blank characters are truncated. If the target type is a fixed-length string (CHAR or GRAPHIC) and the specified length of the target type is greater than the length of the resulting string from CCSID conversion, blanks are padded at the end. This truncation and padding behavior is similar to retrieval assignment of character or graphic strings.
String	DATE	The JSON string is converted to a date value. The JSON string must be in one of the following formats: ISO yyyy-mm-dd USA mm/dd/yyyy EUR dd.mm.yyyy JIS yyyy-mm-dd

Table 64. Supported JSON to SQL result column conversions (continued)

JSON type	SQL type	Notes
String	TIME	The JSON string is converted to a time value. The JSON string must be in one of the following formats: ISO hh.mm.ss EUR hh.mm.ss JIS hh:mm:ss HMS hh:mm:ss
String	TIMESTAMP	The JSON string is converted to a timestamp value. The JSON string must be in one of the following formats: ISO yyyy-mm-dd hh:mm:ss.nnnnnn IBMSQL yyyy-mm-dd-hh.mm.ss.nnnnnn ISO-8601 yyyy-mm-ddThh:mm:ss.nnnnnn<+/-Offset>
Array or Object	CHAR VARCHAR CLOB GRAPHIC VARGRAPHIC DBCLOB	Must be returned using a FORMAT JSON column. JSON arrays or objects are returned as JSON formatted character strings. The resultant conversion is that same as for string types.
Null	Any	A JSON null value is converted to an SQL null value
Boolean	CHAR VARCHAR CLOB GRAPHIC VARGRAPHIC DBCLOB	A JSON boolean value is converted to either a true or false string and is returned as a string using the conversion rules for JSON strings.

Examples

These examples operate on the following JSON document:

```
{
  "id" : 901,
  "name" : { "first":"John", "last":"Doe" },
  "phones": [ { "type":"home", "number":"555-3762"},
              { "type":"work", "number":"555-8792"} ]
}
```

- List the employee id, first name, last name, and first phone type and number:

```
SELECT U."id", U."first name",U."last name",U."phone type",U."phone number"
FROM EMPLOYEE TABLE E
JSON_TABLE(E.jsondoc,
'lax $'
COLUMNS( "id" INTEGER,
"first name" VARCHAR(20) PATH 'lax $.name.first',
```



```

"last name"    VARCHAR(20) PATH 'lax $.name.last',
"phone type"   VARCHAR(20) PATH 'lax $.phones[0].type',
"phone number" VARCHAR(20) PATH 'lax $.phones[0].number')
) AS U

```

Returns:

id	first name	last name	phone type	phone number
901	John	Doe	home	555-3762

- List the employee id, first name, last name, and all available telephone types and numbers:

```

SELECT U."id", U."first name",U."last name",U."phone type",U."number" AS "phone number"
FROM EMPLOYEE_TABLE E
  JSON_TABLE(E.jsondoc,
    'lax $'
    COLUMNS( "id" INTEGER,
              "first name" VARCHAR(20) PATH 'lax $.name.first',
              "last name"  VARCHAR(20) PATH 'lax $.name.last',
              NESTED PATH 'lax $.phones[*]'
              COLUMNS (
                "phone type" VARCHAR(20) PATH 'lax $.type',
                "number"     VARCHAR(20) )
            )
    ) AS U

```

Returns:

id	first name	last name	phone type	phone number
901	John	Doe	home	555-3762
901	John	Doe	work	555-8792

MQREADALL

The MQREADALL function returns a table that contains the messages and message metadata from a specified MQSeries location with a VARCHAR column without removing the messages from the queue.

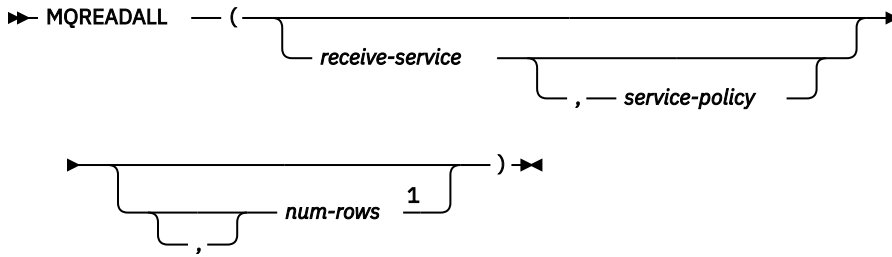

Notes:

¹ The comma is required before *num-rows* when any of the preceding arguments to the function are specified.

The MQREADALL function returns a table containing the messages and message metadata from the MQSeries location that is specified by *receive-service*, using the quality-of-service policy that is defined in *service-policy*. Performing this operation does not remove the messages from the queue that is associated with *receive-service*.

receive-service

An expression that returns a value that is a built-in character string or graphic string data type that is not a LOB. The value of the expression must not be an empty string or a string with trailing blanks. The expression must have an actual length that is no greater than 48 bytes. The value of the expression must refer to a service point that is defined in the SYSIBM.MQSERVICE table. A service point is a logical end-point from where a message is sent or received. Service point definitions include the name of the MQSeries queue manager and queue. For more information about MQSeries Application Messaging, see [SQL Programming](#).

If *receive-service* is not specified or the null value, DB2.DEFAULT.SERVICE is used.

service-policy

An expression that returns a value that is a built-in character string or graphic string data type that is not a LOB. The value of the expression must not be an empty string or a string with trailing blanks. The expression must have an actual length that is no greater than 48 bytes. The value of the expression must refer to a service policy that is defined in the SYSIBM.MQPOLICY table. A service policy specifies a set of quality-of-service options that are to be applied to this messaging operation. These options include message priority and message persistence. For more information about MQSeries Application Messaging, see [SQL Programming](#).

If *service-policy* is not specified or the null value, DB2.DEFAULT.POLICY is used.

num-rows

An expression that returns a value that is a SMALLINT or INTEGER data type whose value is a positive integer or zero. The value of the expression specifies the maximum number of messages to return.

If *num-rows* is not specified or the value of expression is zero, all available messages are returned.

The result of the function is a table with the format shown in the following table. All the columns are nullable.

Table 65. Format of the resulting table for MQREADALL

Column name	Data type	Contains
MSG	VARCHAR(32000)	The contents of the MQSeries message
CORRELID	VARCHAR(24)	The correlation ID that is used to relate messages
TOPIC	VARCHAR(40)	Reserved

Table 65. Format of the resulting table for MQREADALL (continued)

Column name	Data type	Contains
QNAME	VARCHAR(48)	The name of the queue from which the message was received
MSGID	VARCHAR(24)	The unique, MQSeries-assigned identifier for the message
MSGFORMAT	VARCHAR(8)	The format of the message, as defined by MQSeries

The CCSID of the result columns, except for CORRELID and MSGID, is the default CCSID at the current server.

Notes

Prerequisites: In order to use the MQSeries functions, IBM MQSeries for IBM i must be installed, configured, and operational.

Example

- This example receives all the messages from the queue specified by the default service (DB2.DEFAULT.SERVICE), using the default policy (DB2.DEFAULT.POLICY). The messages and all the metadata are returned as a table.

```
SELECT *
FROM TABLE (MQREADALL ()) AS T
```

- This example receives all the messages from the head of the queue specified by the service MYSERVICE, using the default policy (DB2.DEFAULT.POLICY). Only the MSG and CORRELID columns are returned.

```
SELECT T.MSG, T.CORRELID
FROM TABLE (MQREADALL ('MYSERVICE')) AS T
```

- This example reads the head of the queue specified by the default service (DB2.DEFAULT.SERVICE), using the default policy (DB2.DEFAULT.POLICY). Only messages with a CORRELID of '1234' are returned. All columns are returned.

```
SELECT *
FROM TABLE (MQREADALL ()) AS T
WHERE T.CORRELID = '1234'
```

- This example receives the first 10 messages from the head of the queue specified by the default service (DB2.DEFAULT.SERVICE), using the default policy (DB2.DEFAULT.POLICY). All columns are returned.

```
SELECT *
FROM TABLE (MQREADALL (10)) AS T
```

MQREADALLCLOB

The MQREADALLCLOB function returns a table that contains the messages and message metadata from a specified MQSeries location with a CLOB column without removing the messages from the queue.

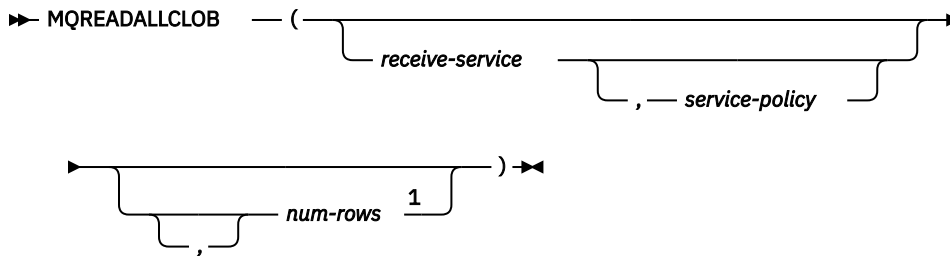

Notes:

¹ The comma is required before *num-rows* when any of the preceding arguments to the function are specified.

The MQREADALLCLOB function returns a table containing the messages and message metadata from the MQSeries location that is specified by *receive-service*, using the quality-of-service policy that is defined in *service-policy*. Performing this operation does not remove the messages from the queue that is associated with *receive-service*.

receive-service

An expression that returns a value that is a built-in character string or graphic string data type that is not a LOB. The value of the expression must not be an empty string or a string with trailing blanks. The expression must have an actual length that is no greater than 48 bytes. The value of the expression must refer to a service point that is defined in the SYSIBM.MQSERVICE table. A service point is a logical end-point from where a message is sent or received. Service point definitions include the name of the MQSeries queue manager and queue. For more information about MQSeries Application Messaging, see [SQL Programming](#).

If *receive-service* is not specified or the null value, DB2.DEFAULT.SERVICE is used.

service-policy

An expression that returns a value that is a built-in character string or graphic string data type that is not a LOB. The value of the expression must not be an empty string or a string with trailing blanks. The expression must have an actual length that is no greater than 48 bytes. The value of the expression must refer to a service policy that is defined in the SYSIBM.MQPOLICY table. A service policy specifies a set of quality-of-service options that are to be applied to this messaging operation. These options include message priority and message persistence. For more information about MQSeries Application Messaging, see [SQL Programming](#).

If *service-policy* is not specified or the null value, DB2.DEFAULT.POLICY is used.

num-rows

An expression that returns a value that is a SMALLINT or INTEGER data type whose value is a positive integer or zero. The value of the expression specifies the maximum number of messages to return.

If *num-rows* is not specified or the value of expression is zero, all available messages are returned.

The result of the function is a table with the format shown in the following table. All the columns are nullable.

Table 66. Format of the resulting table for MQREADALLCLOB

Column name	Data type	Contains
MSG	CLOB(2M)	The contents of the MQSeries message
CORRELID	VARCHAR(24)	The correlation ID that is used to relate messages

Table 66. Format of the resulting table for MQREADALLCLOB (continued)

Column name	Data type	Contains
TOPIC	VARCHAR(40)	Reserved
QNAME	VARCHAR(48)	The name of the queue from which the message was received
MSGID	VARCHAR(24)	The unique, MQSeries-assigned identifier for the message
MSGFORMAT	VARCHAR(8)	The format of the message, as defined by MQSeries

The CCSID of the result columns, except for CORRELID and MSGID, is the default CCSID at the current server.

Notes

Prerequisites: In order to use the MQSeries functions, IBM MQSeries for IBM i must be installed, configured, and operational.

Example

- This example receives all the messages from the queue specified by the default service (DB2.DEFAULT.SERVICE), using the default policy (DB2.DEFAULT.POLICY). The messages and all the metadata are returned as a table.

```
SELECT *
FROM TABLE (MQREADALLCLOB ()) AS T
```

- This example receives all the messages from the head of the queue specified by the service MYSERVICE, using the default policy (DB2.DEFAULT.POLICY). Only the MSG and CORRELID columns are returned.

```
SELECT T.MSG, T.CORRELID
FROM TABLE (MQREADALLCLOB ('MYSERVICE')) AS T
```

- This example reads the head of the queue specified by the default service (DB2.DEFAULT.SERVICE), using the default policy (DB2.DEFAULT.POLICY). Only messages with a CORRELID of '1234' are returned. All columns are returned.

```
SELECT *
FROM TABLE (MQREADALLCLOB ()) AS T
WHERE T.CORRELID = '1234'
```

- This example receives the first 10 messages from the head of the queue specified by the default service (DB2.DEFAULT.SERVICE), using the default policy (DB2.DEFAULT.POLICY). All columns are returned.

```
SELECT *
FROM TABLE (MQREADALLCLOB (10)) AS T
```

MQRECEIVEALL

The MQRECEIVEALL function returns a table that contains the messages and message metadata from a specified MQSeries location with a VARCHAR column with removal of the messages from the queue.

►► MQRECEIVEALL — (→

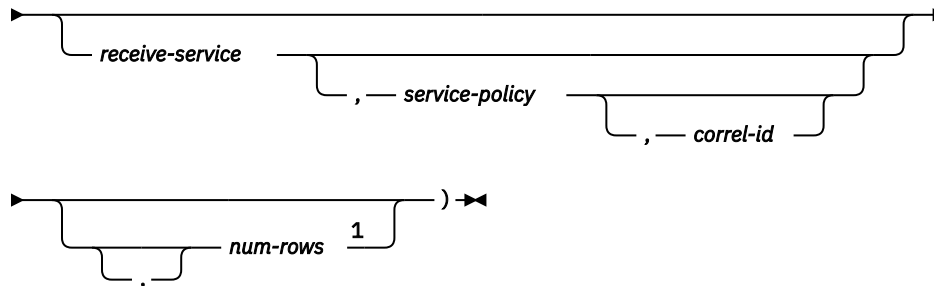

Notes:

¹ The comma is required before *num-rows* when any of the preceding arguments to the function are specified.

The MQRECEIVEALL function returns a table containing the messages and message metadata from the MQSeries location that is specified by *receive-service*, using the quality-of-service policy that is defined in *service-policy*. Performing this operation removes the messages from the queue that is associated with *receive-service*.

receive-service

An expression that returns a value that is a built-in character string or graphic string data type that is not a LOB. The value of the expression must not be an empty string or a string with trailing blanks. The expression must have an actual length that is no greater than 48 bytes. The value of the expression must refer to a service point that is defined in the SYSIBM.MQSERVICE table. A service point is a logical end-point from where a message is sent or received. Service point definitions include the name of the MQSeries queue manager and queue. For more information about MQSeries Application Messaging, see [SQL Programming](#).

If *receive-service* is not specified or the null value, DB2.DEFAULT.SERVICE is used.

service-policy

An expression that returns a value that is a built-in character string or graphic string data type that is not a LOB. The value of the expression must not be an empty string or a string with trailing blanks. The expression must have an actual length that is no greater than 48 bytes. The value of the expression must refer to a service policy that is defined in the SYSIBM.MQPOLICY table. A service policy specifies a set of quality-of-service options that are to be applied to this messaging operation. These options include message priority and message persistence. For more information about MQSeries Application Messaging, see [SQL Programming](#).

If *service-policy* is not specified or the null value, DB2.DEFAULT.POLICY is used.

correl-id

An expression that returns a value that is a built-in character string or graphic string data type that is not a LOB. The expression must have an actual length that is no greater than 24 bytes. The value of the expression specifies the correlation identifier that is associated with this message. A correlation identifier is often specified in request-and-reply scenarios to associate requests with replies. The first message with a matching correlation identifier is returned. For more information about MQSeries Application Messaging, see [SQL Programming](#).

A fixed length string with trailing blanks is considered a valid value. However, when the *correl-id* is specified on another request such as MQSEND, the identical *correl-id* must be specified to be recognized as a match. For example, specifying a value of 'test' for *correl-id* on MQRECEIVEALL does not match a *correl-id* value of 'test ' (with trailing blanks) specified earlier on an MQSEND request.

If *correl-id* is not specified or is an empty string or the null value, a correlation identifier is not used, and the message at the beginning of the queue is returned.

num-rows

An expression that returns a value that is a SMALLINT or INTEGER data type whose value is a positive integer or zero. The value of the expression specifies the maximum number of messages to return.

If *num-rows* is not specified or the value of expression is zero, all available messages are returned.

The result of the function is a table with the format shown in the following table. All the columns are nullable.

Table 67. Format of the resulting table for MQRECEIVEALL

Column name	Data type	Contains
MSG	VARCHAR(32000)	The contents of the MQSeries message
CORRELID	VARCHAR(24)	The correlation ID that is used to relate messages
TOPIC	VARCHAR(40)	Reserved
QNAME	VARCHAR(48)	The name of the queue from which the message was received
MSGID	VARCHAR(24)	The unique, MQSeries-assigned identifier for the message
MSGFORMAT	VARCHAR(8)	The format of the message, as defined by MQSeries

The CCSID of the result columns, except for CORRELID and MSGID, is the default CCSID at the current server.

Notes

Prerequisites: In order to use the MQSeries functions, IBM MQSeries for IBM i must be installed, configured, and operational.

Example

- This example receives all the messages from the queue specified by the default service (DB2.DEFAULT.SERVICE), using the default policy (DB2.DEFAULT.POLICY). The messages and all the metadata are returned as a table.

```
SELECT *  
FROM TABLE (MQRECEIVEALL ()) AS T
```

- This example receives all the messages from the head of the queue specified by the service MYSERVICE, using the default policy (DB2.DEFAULT.POLICY). Only the MSG and CORRELID columns are returned.

```
SELECT T.MSG, T.CORRELID  
FROM TABLE (MQRECEIVEALL ('MYSERVICE')) AS T
```

- This example receives all of the message from the head of the queue specified by the service "MYSERVICE", using the policy "MYPOLICY". Only messages with a CORRELID of '1234' are returned. Only the MSG and CORRELID columns are returned.

```
SELECT *  
FROM TABLE (MQRECEIVEALL ('MYSERVICE', 'MYPOLICY', '1234')) AS T
```

- This example receives the first 10 messages from the head of the queue specified by the default service (DB2.DEFAULT.SERVICE), using the default policy (DB2.DEFAULT.POLICY). All columns are returned.

```
SELECT *  
FROM TABLE (MQRECEIVEALL (10)) AS T
```

MQRECEIVEALLCLOB

The MQRECEIVEALLCLOB function returns a table that contains the messages and message metadata from a specified MQSeries location with a CLOB column with removal of the messages from the queue.

►► MQRECEIVEALLCLOB — (→

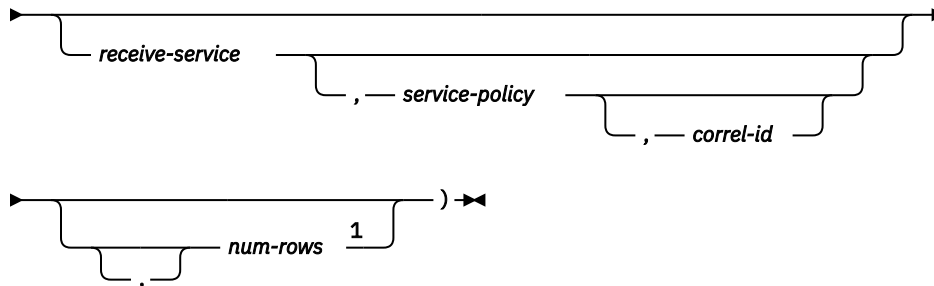

Notes:

¹ The comma is required before *num-rows* when any of the preceding arguments to the function are specified.

The MQRECEIVEALLCLOB function returns a table containing the messages and message metadata from the MQSeries location that is specified by *receive-service*, using the quality-of-service policy that is defined in *service-policy*. Performing this operation removes the messages from the queue that is associated with *receive-service*.

receive-service

An expression that returns a value that is a built-in character string or graphic string data type that is not a LOB. The value of the expression must not be an empty string or a string with trailing blanks. The expression must have an actual length that is no greater than 48 bytes. The value of the expression must refer to a service point that is defined in the SYSIBM.MQSERVICE table. A service point is a logical end-point from where a message is sent or received. Service point definitions include the name of the MQSeries queue manager and queue. For more information about MQSeries Application Messaging, see [SQL Programming](#).

If *receive-service* is not specified or the null value, DB2.DEFAULT.SERVICE is used.

service-policy

An expression that returns a value that is a built-in character string or graphic string data type that is not a LOB. The value of the expression must not be an empty string or a string with trailing blanks. The expression must have an actual length that is no greater than 48 bytes. The value of the expression must refer to a service policy that is defined in the SYSIBM.MQPOLICY table. A service policy specifies a set of quality-of-service options that are to be applied to this messaging operation. These options include message priority and message persistence. For more information about MQSeries Application Messaging, see [SQL Programming](#).

If *service-policy* is not specified or the null value, DB2.DEFAULT.POLICY is used.

correl-id

An expression that returns a value that is a built-in character string or graphic string data type that is not a LOB. The expression must have an actual length that is no greater than 24 bytes. The value of the expression specifies the correlation identifier that is associated with this message. A correlation identifier is often specified in request-and-reply scenarios to associate requests with replies. The first message with a matching correlation identifier is returned. For more information about MQSeries Application Messaging, see [SQL Programming](#).

A fixed length string with trailing blanks is considered a valid value. However, when the *correl-id* is specified on another request such as MQSEND, the identical *correl-id* must be specified to be recognized as a match. For example, specifying a value of 'test' for *correl-id* on MQRECEIVEALLCLOB

does not match a *correl-id* value of 'test ' (with trailing blanks) specified earlier on an MQSEND request.

If *correl-id* is not specified or is an empty string or the null value, a correlation identifier is not used, and the message at the beginning of the queue is returned.

num-rows

An expression that returns a value that is a SMALLINT or INTEGER data type whose value is a positive integer or zero. The value of the expression specifies the maximum number of messages to return.

If *num-rows* is not specified or the value of expression is zero, all available messages are returned.

The result of the function is a table with the format shown in the following table. All the columns are nullable.

Table 68. Format of the resulting table for MQRECEIVEALLCLOB

Column name	Data type	Contains
MSG	CLOB(2M)	The contents of the MQSeries message
CORRELID	VARCHAR(24)	The correlation ID that is used to relate messages
TOPIC	VARCHAR(40)	Reserved
QNAME	VARCHAR(48)	The name of the queue from which the message was received
MSGID	VARCHAR(24)	The unique, MQSeries-assigned identifier for the message
MSGFORMAT	VARCHAR(8)	The format of the message, as defined by MQSeries

The CCSID of the result columns, except for CORRELID and MSGID, is the default CCSID at the current server.

Notes

Prerequisites: In order to use the MQSeries functions, IBM MQSeries for IBM i must be installed, configured, and operational.

Example

- This example receives all the messages from the queue specified by the default service (DB2.DEFAULT.SERVICE), using the default policy (DB2.DEFAULT.POLICY). The messages and all the metadata are returned as a table.

```
SELECT *  
FROM TABLE (MQRECEIVEALLCLOB ()) AS T
```

- This example receives all the messages from the head of the queue specified by the service MYSERVICE, using the default policy (DB2.DEFAULT.POLICY). Only the MSG and CORRELID columns are returned.

```
SELECT T.MSG, T.CORRELID  
FROM TABLE (MQRECEIVEALLCLOB ('MYSERVICE')) AS T
```

- This example receives all of the message from the head of the queue specified by the service "MYSERVICE", using the policy "MYPOLICY". Only messages with a CORRELID of '1234' are returned. Only the MSG and CORRELID columns are returned.

```
SELECT *  
FROM TABLE (MQRECEIVEALLCLOB ('MYSERVICE', 'MYPOLICY', '1234')) AS T
```

- This example receives the first 10 messages from the head of the queue specified by the default service (DB2.DEFAULT.SERVICE), using the default policy (DB2.DEFAULT.POLICY). All columns are returned.

```
SELECT *  
FROM TABLE (MQRECEIVEALLCLOB (10)) AS T
```

XMLTABLE

The XMLTABLE function returns a result table from the evaluation of XPath expressions, possibly using specified input arguments as XPath variables. Each item in the result sequence of the row XPath expression represents a row of the result table.

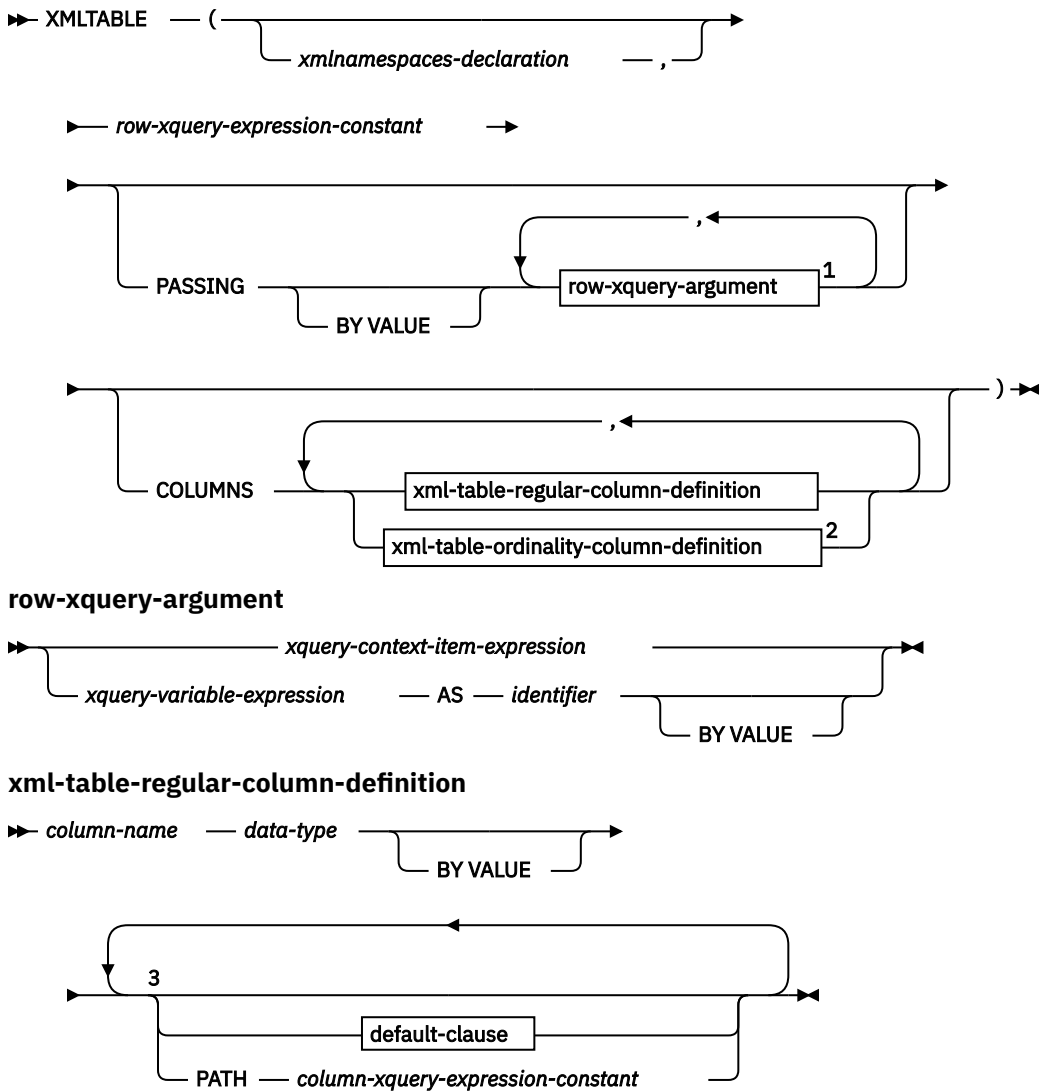

row-xquery-argument

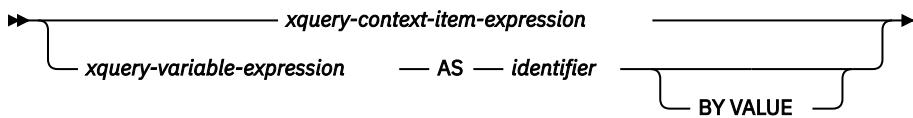

xml-table-regular-column-definition

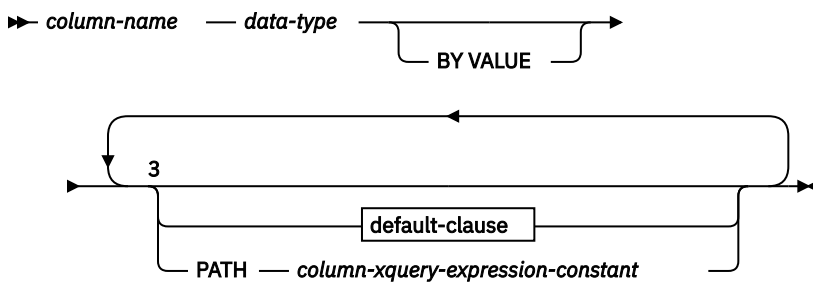

xml-table-ordinality-column-definition



Notes:

- ¹ *xquery-context-item-expression* must not be specified more than one time.
- ² The *xml-table-ordinality-column-definition* clause must not be specified more than one time.
- ³ Neither the *default-clause* nor the **PATH** clause can be specified more than one time.

data-type

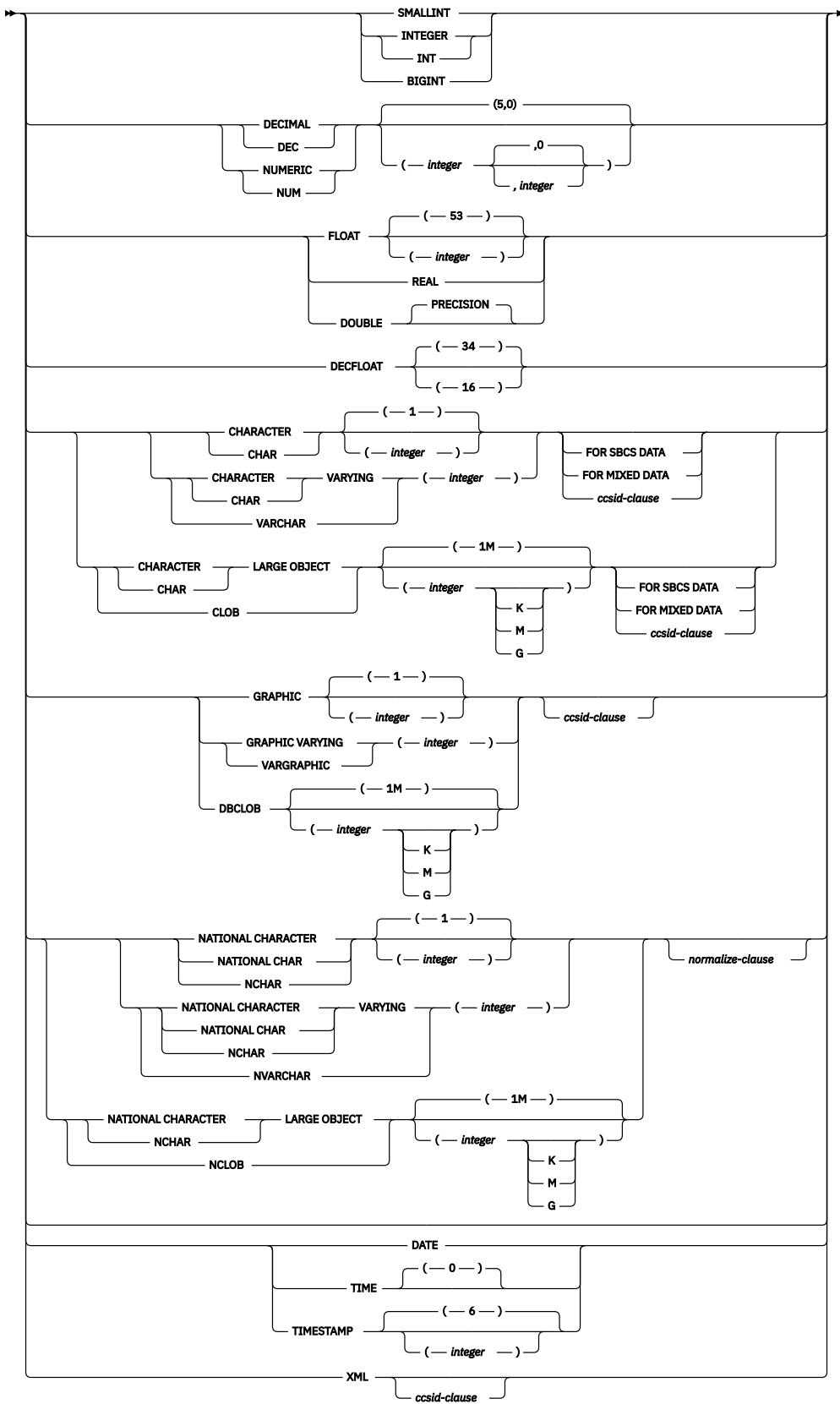

ccsid-clause

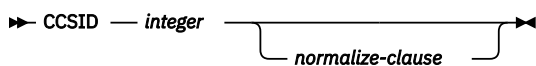

normalize-clause

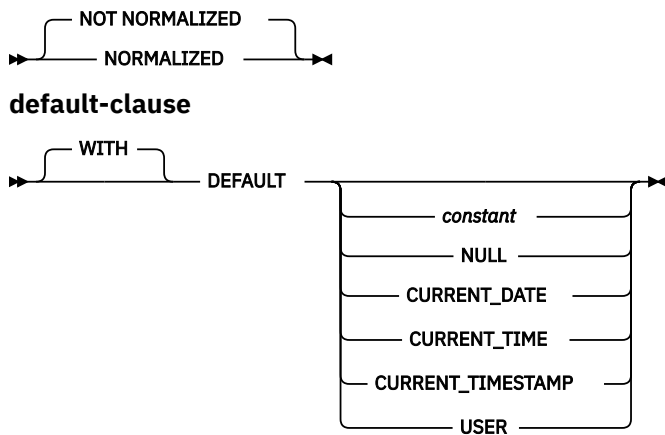

The function name cannot be specified as a qualified name.

xmlnamespaces-declaration

Specifies one or more XML namespace declarations, using the XMLNAMESPACES function, that become part of the static context of the *row-xquery-expression-constant* and the *column-xquery-expression-constant*. The set of statically known namespaces for XPath expressions which are arguments of XMLTABLE is the combination of the pre-established set of statically known namespaces and the namespace declarations specified in this clause. The XPath prolog within an XPath expression can override these namespaces.

If *xmlnamespaces-declaration* is not specified, only the pre-established set of statically known namespaces apply to the XPath expressions.

row-xquery-expression-constant

Specifies an SQL string constant that is interpreted as an XPath expression using supported XPath language syntax. This expression determines the number of rows in the result table. The expression is evaluated using the optional set of input XML values that is specified in *row-xquery-argument*, and returns an output XPath sequence where one row is generated for each item in the sequence. If the sequence is empty, the result of XMLTABLE is an empty table. *row-xquery-expression-constant* must not be an empty string or a string of all blanks.

PASSING

Specifies input values and the manner in which these values are passed to the XPath expression specified by *row-xquery-expression-constant*.

BY VALUE

Specifies that any XML arguments are passed by value. When XML values are passed by value, the XPath evaluation uses a copy of the XML data. This is the default behavior. Db2 for i binds the XPath variable expression to a document node that represents the XML input value.

This clause has no impact on how non-XML values are passed. Non-XML values always create a copy of the value during the cast to XML.

row-xquery-argument

Specifies an argument that is to be passed to the XPath expression specified by *row-xquery-expression-constant*. *row-xquery-argument* specifies an SQL expression that is evaluated before being passed to the XPath expression.

If the data type of *row-xquery-argument* is not XML, the result of the expression is converted to XML. For *query-variable-expression*, a null value is converted to an XML empty sequence.

How *row-xquery-argument* is used in the XPath expression depends on whether the argument is specified as an *xquery-context-item-expression* or an *xquery-variable-expression*.

row-xquery-argument must not contain a NEXT VALUE or PREVIOUS VALUE expression or an OLAP specification.

xquery-context-item-expression

Specifies an SQL expression that returns a value that is XML or that is a type that has a supported conversion to XML.

xquery-context-item-expression specifies the initial context item for the *row-xquery-expression*. The value of the initial context item is the result of *xquery-context-item-expression* after being converted to XML. *xquery-context-item-expression* must not be specified more than one time.

xquery-variable-expression

Specifies an SQL expression whose value is available to the XPath expression specified by *row-xquery-expression-constant* during execution. The expression must return a value that is XML or that is a type that has a supported conversion to XML.

xquery-variable-expression specifies an argument that will be passed to *row-xquery-expression-constant* as an XPath variable. If *xquery-variable-expression* is the null value, the XPath variable is set to an XML empty sequence. The scope of the XPath variables that are created from the PASSING clause is the XPath expression specified by *row-xquery-expression-constant*.

AS identifier

Specifies that the value generated by *xquery-variable-expression* will be passed to *row-xquery-expression-constant* as an XPath variable. The *identifier* is a name that must be in the form of an XML NCName. See the W3C XML namespace specifications for more details on valid names. The leading dollar sign (\$) that precedes variable names in the XPath language must not be included as part of *identifier*. The identifier must not be greater than 128 bytes in length. Two arguments within the same PASSING clause cannot use the same identifier.

BY VALUE

Specifies that *xquery-variable-expression* is passed by value. When XML values are passed by value, the XPath evaluation uses a copy of the XML data. Db2 for i binds the XPath variable expression to a document node that represents the XML input value. If BY VALUE is not specified following *xquery-variable-expression*, XML arguments are passed using the default passing mechanism that is provided through the syntax that follows the PASSING keyword.

This clause is only valid for input values with the XML data type. Non-XML values always create a copy of the value during the cast to XML.

Table 69. Supported SQL to XML conversions

SQL type	XML type	Notes
SMALLINT	xs:integer	
INTEGER	xs:integer	
BIGINT	xs:integer	
DECIMAL NUMERIC	xs:decimal	Decimal numbers with a precision greater than 34 can lose precision during processing.
FLOAT DOUBLE DECFLOAT	xs:double	

Table 69. Supported SQL to XML conversions (continued)

SQL type	XML type	Notes
CHAR VARCHAR CLOB GRAPHIC VARGRAPHIC DBCLOB	xs:string	When character string values are cast to XML values, the resulting xs:string atomic value cannot contain illegal XML characters. If the input character string is not in Unicode, the input characters are converted to Unicode. CHAR and VARCHAR strings cannot have a CCSID of 65535 or be defined for bit data.
DATE	xs:date	The xs:date value will not have a timezone component. For comparisons, the timezone is implicitly assumed to be UTC. If needed, the fn:adjust-timezone() function can be used to explicitly set the timezone.
TIME	xs:time	The xs:time value will not have a timezone component. For comparisons, the timezone is implicitly assumed to be UTC. If needed, the fn:adjust-timezone() function can be used to explicitly set the timezone.
TIMESTAMP	xs:dateTime	The xs:dateTime value will not have a timezone component. For comparisons, the timezone is implicitly assumed to be UTC. If needed, the fn:adjust-timezone() function can be used to explicitly set the timezone.

COLUMNS

Specifies the output columns of the result table including the column name, data type, and how the column value is computed for each row. If this clause is not specified, a single unnamed column of type XML is returned with the value based on the sequence item from evaluating the XPath expression in the *row-xquery-expression* (equivalent to specifying `PATH ' . '`). To reference this result column, a *column-name* must be specified in the *correlation-clause* following the table function.

The sum of all the result column lengths cannot exceed 64K bytes. For information on the byte counts of columns according to data type, see [“Maximum row sizes” on page 1154](#). Assume the number of *row-xquery-arguments* is *N*. There must be no more than 8000-*N* columns.

xml-table-regular-column-definition

Specifies one output column of the result table including the column name, data type, and an XPath expression to extract the value from the sequence item for the row.

column-name

Specifies the name of the column in the result table. The name cannot be qualified and the same name cannot be used for more than one column of the result table.

data-type

Specifies the data type of the column. For CHAR and VARCHAR columns, the CCSID cannot be 65535.

BY VALUE

Specifies that the result column is returned by value. When XML values are returned by value, a copy of the XML data is returned. This is the default behavior. Db2 for i constructs a document node for the XML result when the value is returned from the table function. This clause must not be specified for a column with a data type that is not XML.

default-clause

Specifies a default value for the column. For XMLTABLE result columns, the default is applied when the processing of the XPath expression contained in *column-xquery-expression-constant* returns an empty sequence.

PATH column-xquery-expression-constant

Specifies a string constant that is interpreted as an XPath expression using supported XPath language syntax. The *column-xquery-expression-constant* specifies an XPath expression that determines the column value with respect to an item that is the result of evaluating the XPath expression in *row-xquery-expression-constant*. Given an item from the result of processing the *row-xquery-expression-constant* as the externally provided context item, the *column-xquery-expression-constant* is evaluated and returns an output sequence. The column value is determined based on this output sequence as follows:

- If an empty sequence is returned, the *default-clause* provides the value of the column.
- If an empty sequence is returned and no *default-clause* was specified, the null value is assigned to the column.
- If a non-empty sequence is returned, the value is converted to the data-type specified for the column. An error could be returned from processing this implicit conversion.

The value for *column-xquery-expression-constant* must not be an empty string or a string of all blanks. If this clause is not specified, the default XPath expression is the *column-name*.

xml-table-ordinality-column-definition

Specifies the ordinality column of the result table.

column-name

Specifies the name of the column in the result table. The name cannot be qualified and the same name cannot be used for more than one column of the result table.

FOR ORDINALITY

Specifies that *column-name* is the ordinality column of the result table. The data type of this column is BIGINT. The value of this column in the result table is the sequential number of the item for the row in the resulting sequence from evaluating the XPath expression in *row-xquery-expression-constant*.

XML type	SQL type	Notes
xs:integer	SMALLINT INTEGER BIGINT	
xs:decimal	DECIMAL NUMERIC	The resulting xs:decimal value is converted, if necessary, to the precision and scale of the target data type. The necessary number of leading zeros is added or removed. In the fractional part of the number, the necessary number of trailing zeros is added or the necessary number of digits is eliminated. This truncation behavior is similar to the behavior of the cast from DECIMAL to DECIMAL. Decimal numbers with a precision greater than 34 can lose precision during processing.

Table 70. Supported XML to SQL result column conversions (continued)

XML type	SQL type	Notes
xs:double	FLOAT DOUBLE REAL DECFLOAT	<p>If the target type is FLOAT, DOUBLE, or REAL and the source XML value after the XPath cast is an xs:double value of INF, -INF, or NaN, an error is returned. If the source value is an xs:double negative zero, the value is converted to positive zero. If the source value is beyond the range of the target data type, an overflow error is returned. If the source value contains more significant digits than the precision of the target data type, the source value is rounded to the precision of the target data type.</p> <p>If the target type is DECFLOAT and the source XML value is an xs:double value of INF, -INF, or NaN, the result will be the corresponding special DECFLOAT values INF, -INF, or NaN. If the source value is an xs:double negative zero, the result is negative zero. If the target type is DECFLOAT(16) and the source value is beyond the range of DECFLOAT(16), an overflow error is returned. If the source value has more than 16 significant digits, the value is rounded according to the ROUNDING mode that is in effect. This rounding behavior is the same as what is used during the cast of DECFLOAT(34) to DECFLOAT(16).</p>
xs:string	CHAR VARCHAR CLOB GRAPHIC VARGRAPHIC DBCLOB	<p>The resulting XML value is converted, if necessary, to the CCSID of the target data type using the rules described in “Conversion rules for assignments” on page 96 before it is converted to the target type with a limited length. Truncation occurs if the specified length limit is smaller than the length of the resulting string after CCSID conversion. A warning occurs if any non-blank characters are truncated. If the target type is a fixed-length string type (CHAR or GRAPHIC) and the specified length of the target type is greater than the length of the resulting string from CCSID conversion, blanks are padded at the end. This truncation and padding behavior is similar to retrieval assignment of character or graphic strings.</p>
xs:date	DATE	<p>The resulting XML value is adjusted to UTC time and the time zone component is removed. The year part of the resulting xs:date value must be in the range of 0001 to 9999.</p>
xs:time	TIME	<p>The resulting XML value is adjusted to UTC time and the time zone component is removed. Any fractional seconds are truncated from the result.</p>
xs:dateTime	TIMESTAMP	<p>The resulting XML value is adjusted to UTC time and the time zone component is removed. The year part of the resulting xs:dateTime value must be in the range of 0001 to 9999. If the target timestamp type has a precision less than 12, the fractional seconds part of the xs:dateTime value is truncated to the target timestamp precision.</p>

The result of the function is a table. If the evaluation of any of the XPath expressions results in an error, then the XMLTABLE function returns the XPath error.

Example

- List as a table result the purchase order items for orders with a status of 'Unshipped'.

```
SELECT U."PO ID", U."Part #", U."Product Name",
       U."Quantity", U."Price", U."Order Date"
FROM PURCHASEORDER P,
     XMLTABLE('$po/PurchaseOrder/itemlist/item' PASSING P.PORDER AS "po"
              COLUMNS "PO ID"          INTEGER    PATH './@PoNum',
                       "Part #"        CHAR(10)   PATH 'partid',
                       "Product Name"  VARCHAR(50) PATH 'name',
                       "Quantity"      INTEGER    PATH 'quantity',
                       "Price"         DECIMAL(9,2) PATH 'price',
                       "Order Date"    DATE       PATH './@OrderDate'
              ) AS U
WHERE P.STATUS = 'Unshipped'
```

Chapter 5. Procedures

This chapter contains syntax diagrams, semantic descriptions, rules, and examples of the use of the system supplied procedures.

CREATE_WRAPPED

The CREATE_WRAPPED procedure transforms a readable DDL statement into an obfuscated DDL statement and then deploys the object in the database.

► CREATE_WRAPPED — (— *object-definition-string* —) ►

In an obfuscated DDL statement, the procedural logic and embedded SQL statements are scrambled in such a way that any intellectual property in the logic cannot be easily extracted.

The schema is SYSIBMADM.

object-definition-string

A string of type CLOB containing a DDL statement. It can be one of the following SQL statements:

- CREATE FUNCTION (SQL scalar)
- CREATE FUNCTION (SQL table)
- CREATE PROCEDURE (SQL)
- CREATE TRIGGER

The procedure transforms the input into an obfuscated DDL statement string and then dynamically executes that DDL statement. The encoding consists of a prefix of the original statement up to and including the routine signature or trigger name, followed by the keyword WRAPPED. This keyword is followed by information about the application server that invoked the function. The information has the form *pppvrrm* where:

- *ppp* identifies the product using the following 3 characters:
 - DSN for Db2 for z/OS
 - QSQ for Db2 for i
 - SQL for Db2 for LUW
- *vv* is a two-digit version identifier, such as '07'
- *rr* is a two-digit release identifier, such as '02'
- *m* is a one-character modification level identifier, such as '0'

For example Db2 for i version 7.3 is identified as 'QSQ07030'.

This application server information is followed by a string of letters (a-z and A-Z), digits (0-9), underscores, and colons.

The encoded DDL statement may be up to one-third longer than the plain text form of the statement. If the result exceeds the maximum length for SQL statements, an error is issued.

Note

The encoding of the statement is meant to obfuscate the content and should not be considered as a form of strong encryption.

Examples

Example 1: Produce an obfuscated version of a function that computes a yearly salary from an hourly wage given a 40 hour work week.

```
CALL CREATE_WRAPPED('CREATE FUNCTION salary(wage DECFLOAT)
                    RETURNS DECFLOAT RETURN wage * 40 * 52');

SELECT ROUTINE_DEFINITION FROM QSYS2.SYSROUTINES
       WHERE routine_name = 'SALARY' AND routine_schema = CURRENT SCHEMA;
```

Upon successful completion of the CALL statement, the ROUTINE_DEFINITION column in QSYS2.SYSROUTINES for the row corresponding to routine 'SALARY' would be something of the form:

```
WRAPPED QSQ07020 <encoded-suffix>
```

Example 2: Produce an obfuscated version of a trigger that sets a complex default.

```
CALL CREATE_WRAPPED('CREATE OR REPLACE TRIGGER trig1 BEFORE INSERT ON emp  
REFERENCING NEW AS n FOR EACH ROW  
WHEN (n.bonus IS NULL) SET n.bonus = n.salary * .04');  
  
SELECT ACTION_STATEMENT FROM QSYS2.SYSTRIGGERS  
WHERE trigname = 'TRIG1' AND trigschema = CURRENT SCHEMA;
```

Upon successful completion of the CALL statement, the ACTION_STATEMENT column in QSYS2.SYSTRIGGERS for the row corresponding to trigger 'TRIG1' would be something of the form:

```
WRAPPED QSQ07020 <encoded-suffix>
```

XDBDECOMPXML

The XDBDECOMPXML procedure extracts values from serialized XML data and populates relational tables with the values.

Authorization

The privileges held by the authorization ID of the statement must include the following:

- The following system authorities:
 - The system authority *EXECUTE on the XDBDECOMPXML service program associated with the procedure, and
 - The USAGE privilege on the SYSPROC schema.

The privileges held by the authorization ID of the statement must include:

- The INSERT privilege on any tables specified in the annotations, or
- Database administrator authority

Syntax

```
➔ XDBDECOMPXML ( rschema , name , xml doc , )
                |
                | NULL
                +----->
                |
                | documentid
                |
                | NULL
                +----->
```

Description

The schema is SYSPROC.

The XDBDECOMPXML stored procedure uses an XML schema which contains annotations that indicate which columns and tables should be used to store the decomposed XML values. The referenced XML schema must exist in the XSR and must be enabled for decomposition. You can enable an XML schema for decomposition by using the XSR_COMPLETE stored procedure. If your XML schema references tables that did not exist when you invoked the XSR_COMPLETE stored procedure, Db2 will return an error.

rschema

An input parameter of type VARCHAR(128) that specifies the SQL schema for the XML schema. It must be a valid SQL identifier. The SQL schema is one part of the qualified name used to identify this XML schema in the XSR. (The other part of the name is supplied by the *name* parameter). This parameter can have the NULL value which indicates that *name* is implicitly qualified based on the rules specified in [“Qualification of unqualified object names”](#) on page 57.

If *rschema* is specified, it cannot be QSYS, QSYS2, SYSIBM, SYSPROC, or QTEMP.

name

An input parameter of type VARCHAR(128) that specifies the name of the XML schema. It must be a valid SQL identifier. The complete name for the XML schema for which decomposition is to be performed is *rschema.name*. The XML schema name must already exist and be enabled for decomposition as a result of calling the XSR_COMPLETE stored procedure. This parameter cannot have the NULL value.

xml doc

An input parameter of type BLOB(2G) that points to the XML value that is to be decomposed. This parameter cannot be null.

documentid

An input parameter of type VARCHAR(1024) that contains a string that the caller can use to identify the input XML document. This parameter can be null.

XSR_ADDSCHEMADOC

The XSR_ADDSCHEMADOC stored procedure adds every XML schema other than the primary XML schema document to the XSR.

Authorization

Each XML schema in the XSR can consist on one or more XML schema documents. When an XML schema consists of multiple documents, you need to call XSR_ADDSCHEMADOC for the additional documents.

The privileges held by the authorization ID of the statement must include the following:

- The following system authorities:
 - The system authority *EXECUTE on the service program associated with the procedure,
 - The USAGE privilege on the SYSPROC schema,
 - The USAGE privilege on the schema containing the *SQLXSR object, and
 - The ALTER privilege for the *SQLXSR object.
- Database administrator authority

The privileges held by the authorization ID of the statement must include at least one of the following:

- For the XSROBJECTCOMPONENTS and XSROBJECTHIERARCHIES catalog tables:
 - The INSERT privilege on the table, and
 - The USAGE privilege on schema QSYS2.
- Database administrator authority

The user ID of the caller of the procedure must have the EXECUTE privilege on the XSR_ADDSCHEMADOC stored procedure and must be the definer of the XSR object as recorded in the XSROBJECTS catalog table.

Syntax

```
► XSR_ADDSCHEMADOC ( ( rschema , name , schemalocation ,  
    content , docproperty ) ►
```

Description

The schema is SYSPROC.

rschema

An input parameter of type VARCHAR(128) that specifies the SQL schema for the XML schema. It must be a valid SQL identifier. The SQL schema is one part of the qualified name used to identify this XML schema in the XSR. (The other part of the name is supplied by the *name* parameter). This parameter can have the NULL value which indicates that *name* is implicitly qualified based on the rules specified in [“Qualification of unqualified object names”](#) on page 57.

If *rschema* is specified, it cannot be QSYS, QSYS2, SYSIBM, SYSPROC, or QTEMP.

name

An input parameter of type VARCHAR(128) that specifies the name of the XML schema. It must be a valid SQL identifier. The complete name for the XML schema is *rschema.name*. The XML schema must already exist as a result of calling the XSR_REGISTER stored procedure and XML schema registration cannot yet be completed. This parameter cannot have the NULL value.

schemalocation

An input parameter of type VARCHAR(1000), which can have the NULL value, that indicates the schema location of the primary XML schema document to which the XML schema document is being

added. This argument is the external name of the XML schema, that is, the primary document can be identified in the XML instance documents with the `xsi:schemaLocation` attribute. The document that references the *schemalocation* must use a valid URI format.

content

An input parameter of type BLOB(30M) that contains the content of the XML schema document being added. This argument cannot have the NULL value; an XML schema document must be supplied. The content of the XML schema document must be encoded in UTF-8.

docproperty

An input parameter of type BLOB(5M) that indicates the properties for the XML schema document being added. This argument can have the NULL value; otherwise, the value is an XML document.

Example

The following example calls the XSR_ADDSCHEMADOC stored procedure:

```
CALL SYSPROC.XSR_ADDSCHEMADOC(  
  'MyLib',  
  'MySchema',  
  'http://myschema/addschema1.xsd',  
  :schema_content,  
  :schema_docproperties)
```

XSR_COMPLETE

The XSR_COMPLETE procedure is the final stored procedure to be called as part of the XML schema registration process, which registers XML schemas with the XSR. An XML schema is not available for validation until the schema registration completes through a call to this stored procedure.

Authorization

The privileges held by the authorization ID of the statement must include the following:

- The following system authorities:
 - The system authority *EXECUTE on the service program associated with the procedure,
 - The USAGE privilege on the SYSPROC schema,
 - The USAGE privilege on the schema containing the *SQLXSR object, and
 - The ALTER privilege for the *SQLXSR object.
- Database administrator authority

The privileges held by the authorization ID of the statement must include at least one of the following:

- For the XSROBJECTS, XSROBJECTCOMPONENTS, XSROBJECTHIERARCHIES, and XSRANNOTATIONINFO catalog tables:
 - The UPDATE privilege on XSROBJECTS, XSROBJECTCOMPONENTS, and XSROBJECTHIERARCHIES,
 - The INSERT privilege on XSRANNOTATIONINFO, and
 - The USAGE privilege on schema QSYS2.
- Database administrator authority

The user ID of the caller of the procedure must have the EXECUTE privilege on the XSR_COMPLETE stored procedure.

Syntax

```
►► XSR_COMPLETE ( ( rschema , name , schemaproperties , issuedfordecomposition ) )
```

Description

The schema is SYSPROC.

rschema

An input parameter of type VARCHAR(128) that specifies the SQL schema for the XML schema. It must be a valid SQL identifier. The SQL schema is one part of the qualified name used to identify this XML schema in the XSR. (The other part of the name is supplied by the *name* parameter). This parameter can have the NULL value which indicates that *name* is implicitly qualified based on the rules specified in [“Qualification of unqualified object names” on page 57](#).

If *rschema* is specified, it cannot be QSYS, QSYS2, SYSIBM, SYSPROC, or QTEMP.

name

An input parameter of type VARCHAR(128) that specifies the name of the XML schema. It must be a valid SQL identifier. The complete name for the XML schema for which a completion check is to be performed is *rschema.name*. The XML schema name must already exist as a result of calling the XSR_REGISTER stored procedure, and XML schema registration cannot yet be completed. This parameter cannot have the NULL value. Rules for valid characters and delimiters that apply to any SQL identifier also apply to this parameter.

schemaproperties

An input parameter of type BLOB(5M) that specifies properties, if any, associated with the XML schema. The values for this parameter is either NULL, if there are no associated properties, or an XML document representing the properties for the XML schema.

issuedfordecomposition

An input parameter of type INTEGER that indicates if an XML schema is to be used for decomposition. If an XML schema is to be used for decomposition, this value should be set to 1; otherwise, it should be set to 0.

Example

The following example calls the XSR_COMPLETE stored procedure:

```
CALL SYSPROC.XSR_COMPLETE(  
    'MyLib',  
    'MySchema',  
    :schemaproperty_host_var,  
    0)
```

XSR_REGISTER

The XSR_REGISTER procedure is the first stored procedure to be called as part of the XML schema registration process, which registers XML schemas with the XML schema repository (XSR).

Authorization

The user that calls this stored procedure is considered the creator of this XML schema. Db2 obtains the namespace attribute from the schema document when XSR_COMPLETE is invoked.

The privileges held by the authorization ID of the statement must include the following:

- The following system authorities:
 - The system authority *EXECUTE on the service program associated with the procedure, and
 - The USAGE privilege on the SYSPROC schema.

The privileges held by the authorization ID of the statement must include as least one of the following:

- The privilege to create in the schema
- Database administrator authority

The privileges held by the authorization ID of the statement must include at least one of the following:

- For the XSROBJECTS, XSROBJECTCOMPONENTS, and XSROBJECTHIERARCHIES catalog tables:
 - The INSERT privilege on the table, and
 - The USAGE privilege on schema QSYS2.
- Database administrator authority

Syntax

```
► XSR_REGISTER ( ( rschema , name , schemalocation , content ,  
    docproperty ) ) ►
```

Description

The schema is SYSPROC.

rschema

An input parameter of type VARCHAR(128) that specifies the SQL schema for the XML schema. It must be a valid SQL identifier. The SQL schema is one part of the qualified name used to identify this XML schema in the XSR. (The other part of the name is supplied by the *name* parameter). This parameter can have the NULL value which indicates that *name* is implicitly qualified based on the rules specified in [“Qualification of unqualified object names” on page 57](#).

If *rschema* is specified, it cannot be QSYS, QSYS2, SYSIBM, SYSPROC, or QTEMP.

name

An input parameter of type VARCHAR(128) that specifies the name of the XML schema. It must be a valid SQL identifier. The complete name for the XML schema is *rschema.name* and should be unique among all objects in the XSR.

schemalocation

An input parameter of type VARCHAR(1000), which can have the NULL value, that indicates the schema location of the primary XML schema document. This parameter is the external name of the XML schema, that is, the primary document can be identified in the XML instance documents with the xsi:schemaLocation attribute.

content

An input parameter of type BLOB(30M) that contains the content of the primary XML schema document. This parameter cannot have the NULL value; an XML schema document must be supplied. The content of the XML schema document must be encoded in UTF-8.

docproperty

An input parameter of type BLOB(5M) that indicates the properties for the primary XML schema document. This parameter can have the NULL value; otherwise, the value is an XML document.

Example

The following example calls the XSR_REGISTER stored procedure:

```
CALL SYSPROC.XSR_REGISTER(  
  'MyLib',  
  'MySchema',  
  'http://myschema/primary.xsd',  
  :content_host_var,  
  :docproperty_host_var)
```

XSR_REMOVE

The XSR_REMOVE procedure is used to remove all components of an XML schema. After the XML schema is removed, you can reuse the name of the removed XML schema when you register a new XML schema.

Authorization

The privileges held by the authorization ID of the statement must include the following:

- The following system authorities:
 - The system authority *EXECUTE on the service program associated with the procedure, and
 - The USAGE privilege on the SYSPROC schema.

The privileges held by the authorization ID of the statement must include at least one of the following:

- The following system authorities:
 - The system authority *OBJOPR and *OBJEXIST on the object associated with the XSR object, and
 - The USAGE privilege on the schema that contains the XSR object to be dropped, and
 - The DELETE privilege on the XSROBJECTS, XSROBJECTCOMPONENTS, XSROBJECTHIERARCHIES, and XSRANNOTATIONINFO catalog tables, and
 - The USAGE privilege on schema QSYS2.
- Database administrator authority

Syntax

➔ XSR_REMOVE (*rschema* , *name*) ➔
 └── NULL ─┘

Description

The schema is SYSPROC.

rschema

An input parameter of type VARCHAR(128) that specifies the SQL schema for the XML schema. It must be a valid SQL identifier. The SQL schema is one part of the qualified name used to identify this XML schema in the XSR. (The other part of the name is supplied by the *name* parameter). This parameter can have the NULL value which indicates that *name* is implicitly qualified based on the rules specified in “[Qualification of unqualified object names](#)” on page 57.

If *rschema* is specified, it cannot be QSYS, QSYS2, SYSIBM, SYSPROC, or QTEMP.

name

An input parameter of type VARCHAR(128) that specifies the name of the XML schema. It must be a valid SQL identifier. The complete name for the XML schema that is to be removed is *rschema.name*. The XML schema name must already exist as a result of calling the XSR_REGISTER stored procedure. This parameter cannot have the NULL value.

Example

The following example calls the XSR_REMOVE stored procedure:

```
CALL SYSPROC.XSR_REMOVE(  
  'MyLib',  
  'MySchema')
```

Chapter 6. Queries

A *query* specifies a result table or an intermediate result table. A query is a component of certain SQL statements.

The three forms of a query are the *subselect*, the *fullselect*, and the *select-statement*. There is another SQL statement that can be used to retrieve at most a single row described under [“SELECT INTO” on page 1482](#).

Authorization

For any form of a query, the privileges held by the authorization ID of the statement must include at least one of the following:

- For each table or view identified in the statement,
 - The SELECT privilege on the table or view, and
 - The USAGE privilege on the schema containing the table or view
- Database administrator authority

If a query includes a user-defined function, the privileges held by the authorization ID of the statement must include at least one of the following:

- For each user-defined function identified in the statement:
 - The EXECUTE privilege on the function
- Database administrator authority

For information about the system authorities corresponding to SQL privileges, see [Corresponding System Authorities When Checking Privileges to a Table or View](#) or [Corresponding System Authorities When Checking Privileges to a Function or Procedure](#).

If the query references a table that contains active row or column access control and row permissions or column masks are defined for the table, the authorization ID of the statement does not need authority to reference objects that are specified in the definitions of those row permissions or column masks.

subselect

The *subselect* is a component of the *fullselect*.

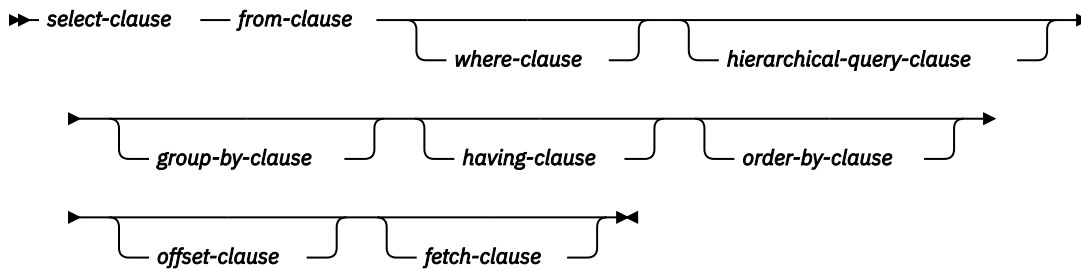

A subselect specifies a result table derived from the tables or views identified in the FROM clause. The derivation can be described as a sequence of operations in which the result of each operation is input for the next. (This is only a way of describing the subselect. The method used to perform the derivation may be quite different from this description. If portions of the subselect do not actually need to be executed for the correct result to be obtained, they may or may not be executed.)

When a subselect directly or indirectly references a table for which row or column access control is enforced, the rules that are defined in the row permissions or column masks affect how the rows in the result table are derived. Typically those rules are based on the authorization ID of the process.

A *scalar-subselect* is a subselect, enclosed in parentheses, that returns a single result row and a single result column. If the result of the subselect is no rows, then the null value is returned. An error is returned if there is more than one row in the result.

The sequence of the (hypothetical) operations is:

1. FROM clause
2. hierarchical-query clause
3. WHERE clause
4. GROUP BY clause
5. HAVING clause
6. SELECT clause
7. ORDER BY clause
8. OFFSET clause
9. FETCH clause

select-clause

The SELECT clause specifies the columns of the final result table.

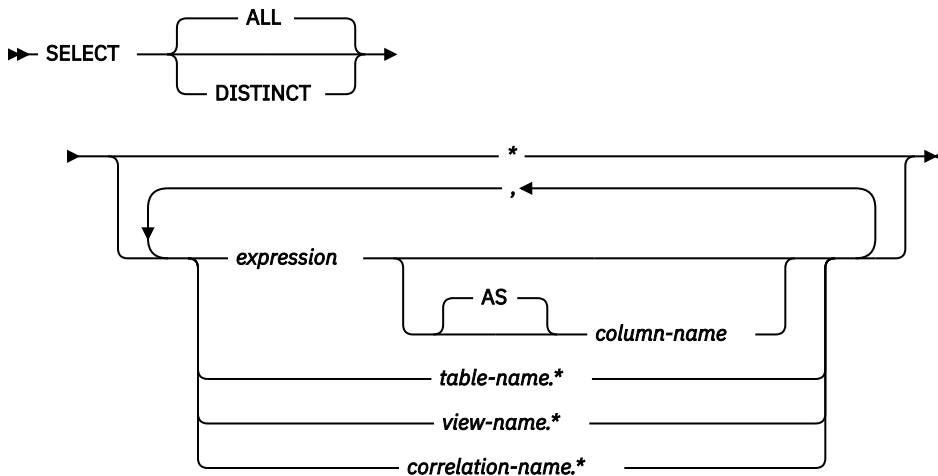

The column values are produced by the application of the *select list* to R. The select list is the names or expressions specified in the SELECT clause, and R is the result of the previous operation of the subselect. For example, if the only clauses specified are SELECT, FROM, and WHERE, R is the result of that WHERE clause.

ALL

Selects all rows of the final result table and does not eliminate duplicates. This is the default.

DISTINCT

Eliminates all but one of each set of duplicate rows of the final result table. Two rows are duplicates of one another only if each value in the first row is equal to the corresponding value in the second row. (For determining duplicate rows, two null values are considered equal.) The collating sequence is also used for determining distinct values.

DISTINCT is not allowed if the *select-list* contains a DATALINK or XML column, or an expression that returns a value that is the XML data type.

Column access controls do not affect the operation of SELECT DISTINCT. The elimination of duplicated rows is based on the original column values, not the masked values. However, after the application of column masks, the masked values in the final result table might not reflect the uniqueness that is enforced by SELECT DISTINCT.

If a column mask is applied to a column that directly or indirectly derives the result of SELECT DISTINCT, SELECT DISTINCT can return a result that is not deterministic. The following conditions are a few examples of when a result that is not deterministic might be returned:

- The definition of the column mask references other columns of the table to which the column mask is applied.
- The column is referenced in the argument of a built-in scalar function, such as COALESCE, IFNULL, NULLIF, MAX, MIN, LOCATE, etc.
- The column is referenced in the argument of an aggregate function.
- The column is embedded in an expression and the expression contains a function that is not deterministic or has an external action.

Select list notation

*

Represents a list of columns of table R in the order the columns are produced by the FROM clause. Any columns defined with the hidden attribute will not be included. The list of names is established

when the statement containing the SELECT clause is prepared. Therefore, * does not identify any columns that have been added to a table after the statement has been prepared.

* cannot be used in the definition of a row permission or a column mask.

expression

Specifies the values of a result column. Each *column-name* in the *expression* must unambiguously identify a column of R.

column-name or AS column-name

Names or renames the result column. The name must not be qualified and does not have to be unique.

name.*

Represents a list of columns of *name*. Any columns defined with the hidden attribute are not included. The *name* can be a table name, view name, or correlation name, and must designate an exposed table, view, or correlation name in the FROM clause immediately following the SELECT clause. The first name in the list identifies the first column of the table or view, the second name in the list identifies the second column of the table or view, and so on.

The list of names is established when the statement containing the SELECT clause is prepared. Therefore, * does not identify any columns that have been added to a table after the statement has been prepared.

*name.** cannot be used in the definition of a row permission or a column mask.

Normally, when SQL statements are implicitly rebound, the list of names is not reestablished. Therefore, the number of columns returned by the statement does not change. However, there are four cases where the list of names is established again and the number of columns can change:

- When an SQL program or SQL package is saved and then restored on a IBM i product that is not the same release as the system from which it was saved.
- When SQL naming is specified for an SQL program or package and the owner of the program has changed since the SQL program or package was created.
- When an SQL statement is executed for the first time after the install of a more recent release of the IBM i operating system.
- When the SELECT * occurs in the fullselect of an INSERT statement or in a fullselect within a predicate, and a table or view referenced in the fullselect has been deleted and recreated with additional columns.

The number of columns in the result of SELECT is the same as the number of expressions in the operational form of the select list (that is, the list established at prepare time), and cannot exceed 8000. The result of a subquery must be a single expression, unless the subquery is used in the EXISTS predicate.

Applying the select list

The results of applying the select list to R depend on whether GROUP BY or HAVING is used:

If GROUP BY or HAVING is used

- Each *column-name* in the select list must identify a grouping expression, or be specified within an aggregate function, or be a correlated reference:
 - If the grouping expression is a column name, the select list may apply additional operators to the column name. For example, if the grouping expression is column C1, the select list may contain C1+1.
 - If the grouping expression is not a column name, the select list may not apply additional operators to the expression. For example, if the grouping expression is C1+1, the select list may contain C1+1, but not (C1+1)/8.
- The select list is applied to each group of R, and the result contains as many rows as there are groups in R. When the select list is applied to a group of R, that group is the source of the arguments of the aggregate functions in the select list.

- The RRN, RID, DATAPARTITIONNAME, DATAPARTITIONNUM, DBPARTITIONNAME, DBPARTITIONNUM, and HASHED_VALUE functions cannot be specified in the select list.

If neither GROUP BY nor HAVING is used

- The select list must not include any aggregate functions, or each *column-name* must be specified in an aggregate function or be a correlated reference.
- If the select list does not include aggregate functions, it is applied to each row of R and the result contains as many rows as there are rows in R.
- If the select list is a list of aggregate functions, R is the source of the arguments of the functions and the result of applying the select list is one row.

In either case the *n*th column of the result contains the values specified by applying the *n*th expression in the operational form of the select list.

Effect of column masks on result columns: When column masks are enabled, they determine the values in the final result table of an outermost select list. When a column mask is enabled for a column, if the column appears in the outermost select list (either implicitly or explicitly), the column mask is applied to the column to produce the values for the final result table. If the column itself does not appear in the outermost select list, but is included in the output (for example, it appears in a materialized table expression or a view), the masked value is included in the result table of the table expression or view so that it can be used in the final result table.

The enabled column masks do not interfere with the operations of other clauses within the statement, such as the WHERE, GROUP BY, HAVING, SELECT DISTINCT, and ORDER BY clauses.

The rows that are returned in the final result table remain the same, except that the values in the result rows might be masked. As such, if a column with masked values also appears in an ORDER BY clause with a sort-key expression, the order is based on the original column values (the masked values in the final result table might not reflect that order). Similarly, the masked values might not reflect the uniqueness enforced by a SELECT DISTINCT. If the masked column is embedded in an expression, the result of the expression might be different because the column mask is applied to the column before the expression is evaluated. For example, a column mask on column SSN can change the result of the function COUNT(DISTINCT SSN) because the DISTINCT operation is performed on the masked values.

When the definition of a column mask is applied to an SQL statement to mask column values in the final result table, the semantics of the column mask might conflict with certain SQL semantics in the statement. In these situations, the combination of the statement and the column mask might return an error.

See [“ALTER TABLE” on page 858](#) for more information about the application of enabled column masks.

Null attributes of result columns

Result columns allow null values if they are derived from:

- Any aggregate function but COUNT and COUNT_BIG
- Any column that allows null values
- A scalar function or expression with an operand that allows null values
- A host variable that has an indicator variable, an SQL parameter or variable, or in the case of Java, a variable or expression whose type is able to represent a Java null value
- A result of a UNION or INTERSECT if at least one of the corresponding items in the select list is nullable
- An arithmetic expression in the outer select list
- A *scalar-fullselect*
- A user-defined scalar or table function
- A GROUPING SETS *grouping-expression*

Names of result columns

- If the AS clause is specified, the name of the result column is the name specified on the AS clause.
- If the AS clause is not specified and a column list is specified in the correlation clause, the name of the result column is the corresponding name in the correlation column list.
- If neither an AS clause nor a column list in the correlation clause is specified and the result column is derived only from a single column (without any functions or operators), then the result column name is the unqualified name of that column.
- If neither an AS clause nor a column list in the correlation clause is specified and the result column is derived only from a single variable (without any functions or operators), then the result column name is the unqualified name of that variable.
- If neither an AS clause nor a column list in the correlation clause is specified and the result column is derived only from a single pseudo column (without any functions or operators), then the result column name is the name of that pseudo column.
- All other result columns are unnamed.

Data types of result columns

Each column of the result of SELECT acquires a data type from the expression from which it is derived.

When the expression is:	The data type of the result column is:
the name of any numeric column	the same as the data type of the column, with the same precision and scale for decimal columns.
an integer constant	INTEGER or BIGINT (if the value of the constant is outside the range of INTEGER, but within the range of BIGINT).
a decimal or floating-point constant	the same as the data type of the constant, with the same precision and scale for decimal constants.
the name of a DECFLOAT(7) variable	DECFLOAT(16)
the name of any numeric variable	the same as the data type of the variable, with the same precision and scale for decimal variables. If the data type of the variable is not identical to an SQL data type (for example, DISPLAY SIGN LEADING SEPARATE in COBOL), the result column is decimal.
an expression	the same as the data type of the result, with the same precision and scale for decimal results as described under “Expressions” on page 159 .
any function	the data type of the result of the function. For a built-in function, see Chapter 4, “Built-in functions,” on page 245 to determine the data type of the result. For a user-defined function, the data type of the result is what was defined in the CREATE FUNCTION statement for the function.
the name of any string column	the same as the data type of the column, with the same length attribute.
the name of any string variable	the same as the data type of the variable, with a length attribute equal to the length of the variable. If the data type of the variable is not identical to an SQL data type (for example, a NUL-terminated string in C), the result column is a varying-length string.
a character-string constant of length <i>n</i>	VARCHAR(<i>n</i>)

When the expression is:	The data type of the result column is:
a graphic-string constant of length <i>n</i>	VARGRAPHIC(<i>n</i>)
the name of an XML column or variable	XML
the name of a datetime column, or an ILE RPG compiler or an ILE COBOL compiler datetime host variable	the same as the data type of the column or variable.
the name of a distinct type column	the same as the distinct type of the column, with the same length, precision, and scale attributes, if any.
the name of a datalink column	a datalink, with the same length attribute.
the name of a row ID column or a row ID variable	ROWID

from-clause

The FROM clause specifies an intermediate result table.

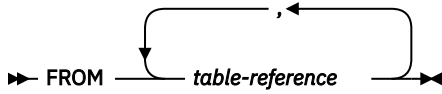

If only one *table-reference* is specified, the intermediate result table is simply the result of that *table-reference*. If more than one *table-reference* is specified in the FROM clause, the intermediate result table consists of all possible combinations of the rows of the specified *table-references* (the Cartesian product). Each row of the result is a row from the first *table-reference* concatenated with a row from the second *table-reference*, concatenated in turn with a row from the third, and so on. The number of rows in the result is the product of the number of rows in all the individual *table-references*.

If *table-reference* has row access controls enforced, *table-reference* has at least one row permission: the default row permission. When there are multiple row permissions defined for a *table-reference*, a row access control search condition is derived by applying the logical OR operator to the search condition in each enabled permission. This derived search condition acts as a filter to the *table-reference* to determine the result table of the *table-reference* that is accessible to the authorization ID of the subselect.

table-reference

A *table-reference* specifies an intermediate result table.

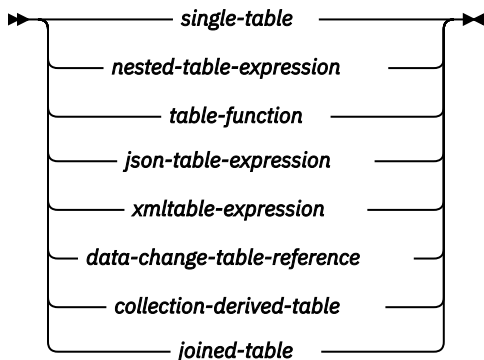

single-table

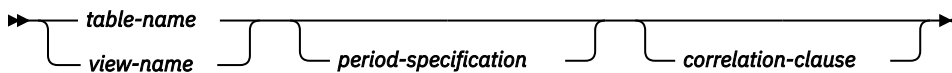

nested-table-expression

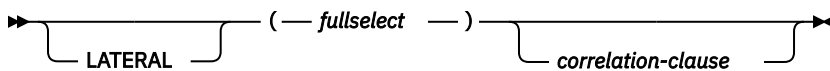
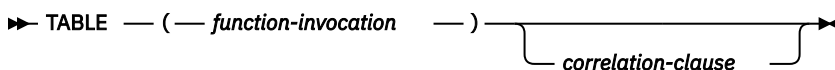
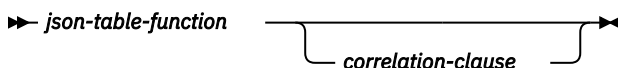

table-function



json-table-expression



xmltable-expression

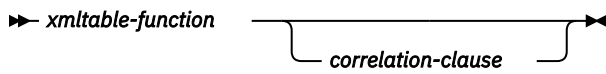

data-change-table-reference

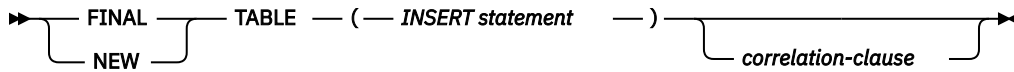

collection-derived-table

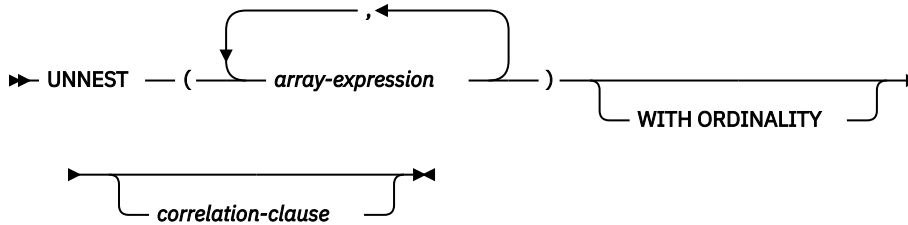

period-specification

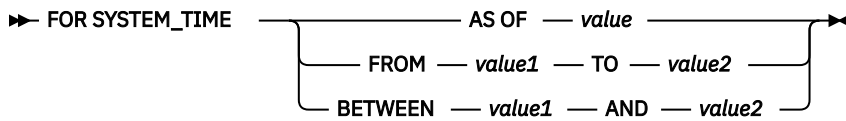

correlation-clause

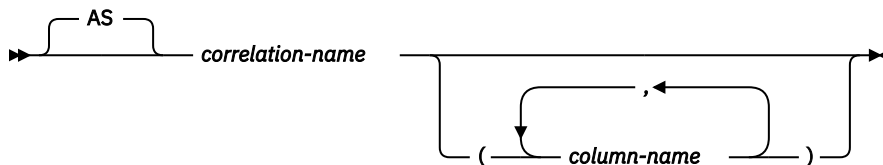

- If a single table or view is identified without a *period-specification*, the intermediate result table is simply that table or view. If a *period-specification* is specified for a *table-name* or *view-name*, the intermediate result table consists of the rows of the temporal table where the period matches the specification.
- A fullselect in parentheses called a *nested table expression*.⁷⁹ If a nested table expression is specified, the result table is the result of that nested table expression. The columns of the result do not need unique names, but a column with a non-unique name cannot be explicitly referenced.
- If a *function-name* , *json-table-expression*, or *xmltable-expression* is specified, the intermediate result table is the set of rows returned by the table function.
- If a *data-change-table-reference* is specified, the intermediate result table is the set of rows inserted by the INSERT statement.
- If a *collection-derived-table* is specified, the intermediate result table is a set of rows from one or more arrays.
- If a *joined-table* is specified, the intermediate result table is the result of one or more join operations. For more information, see “[joined-table](#)” on page 738.

If *table-reference* identifies a distributed table or a table that has a read trigger, the query cannot contain:

- EXCEPT or INTERSECT operations,
- VALUES in a fullselect,
- OLAP specifications,
- recursive common table expressions and CONNECT BY,
- ORDER OF,

⁷⁹ A *nested table expression* is also called a *derived table*.

- scalar fullselects (scalar subselects are supported),
- full outer join,
- LOBs in a GROUP BY,
- grouping sets or super groups,
- ORDER BY or FETCH clause in a subselect,
- OFFSET clause, or FETCH clause with a variable for N rows,
- CORRELATION, COVARIANCE, COVARIANCE_SAMP, LISTAGG, MEDIAN, PERCENTILE_CONT, PERCENTILE_DISC, or Regression aggregate functions,
- VERIFY_GROUP_FOR_USER, LOCATE_IN_STRING, LTRIM or RTRIM with 2 arguments, EXTRACT function with EPOCH, HASH functions,
- BSON_TO_JSON, JSON_ARRAY, JSON_ARRAYAGG, JSON_OBJECT, JSON_OBJECTAGG, JSON_QUERY, JSON_TABLE, JSON_TO_BSON, and JSON_VALUE functions, and the IS JSON and JSON_EXISTS predicates,
- XMLAGG, XMLATTRIBUTES, XMLCOMMENT, XMLCONCAT, XMLDOCUMENT, XMLELEMENT, XMLFOREST, XMLGROUP, XMLNAMESPACES, XMLPI, XMLROW, XMLTABLE, or XMLTEXT functions,
- CONTAINS or SCORE functions,
- default values for user defined functions,
- global variables, or
- references to arrays.

If the CURRENT TEMPORAL SYSTEM_TIME special register is set to a non-null value *CTST*, the value of the SYSTIME option is YES, and *table-name* or *view-name* identifies a system-period temporal table, the table reference is executed as if it contained the following specification with the special register set to the null value:

```
table-name FOR SYSTEM_TIME AS OF CTST
```

or

```
view-name FOR SYSTEM_TIME AS OF CTST
```

The list of names in the FROM clause must conform to these rules:

- Each *table-name* and *view-name* must name an existing table or view at the current server or the *table-identifier* of a common table expression defined preceding the subselect containing the *table-reference*.
- The exposed names must be unique. An exposed name is:
 - A *correlation-name*
 - A *table-name* or *view-name* that is not followed by a *correlation-name*
 - The *table-name* or *view-name* that is the target of the *data-change-table-reference* when the *data-change-table-reference* is not followed by a *correlation-name*

If a *correlation-clause* is not specified for a *nested-table-expression*, *table-function*, *json-table-expression*, *xmltable-expression*, *data-change-table-reference*, or *collection-derived-table*, there is no exposed name for that table reference.

- Each *function-name*, together with the types of its arguments, must resolve to a table function that exists at the current server. An algorithm called function resolution, which is described in [“Function resolution”](#) on page 150, uses the function name and the arguments to determine the exact function to use.
- Each *array-variable-name* must identify an array variable in the SQL routine.

Each *correlation-name* is defined as a designator of the intermediate result table specified by the immediately preceding *table-reference*.

Any qualified reference to a column must use the exposed name. If the same table name or view name is specified twice, at least one specification must be followed by a *correlation-name*. The *correlation-name* is used to qualify references to the columns of the table or view. When a *correlation-name* is specified, column-names can also be specified to give names to the columns of the *table-reference*. If a column list is specified, there must be a name in the column list for each column in the table or view and for each result column in the *nested-table-expression*, *table-function*, *json-table-expression*, *xmltable-expression*, *data-change-table-reference*, or *collection-derived-table*. For more information, see [“Correlation names” on page 133](#). If the *correlation-clause* does not include *column-names*, the exposed column names are:

- Column names of the referenced table or view when the *table-reference* is a *table-name* or *view-name*.
- Column names specified in the RETURNS clause of the CREATE FUNCTION statement when the *table-reference* is a *function-name* reference.
- Column names specified in the COLUMNS clause of the *json-table-expression* or *xmltable-expression* when the *table-reference* is a *json-table-expression* or *xmltable-expression*.
- Column names returned by the fullselect when the *table-reference* is a *nested-table-expression*.
- Column names from the target table of the data change statement, along with any defined INCLUDE columns, when the *table-reference* is a *data-change-table-reference*.

In general, *nested-table-expressions*, *table-functions*, and *collection-derived-tables* can be specified in any FROM clause. Columns from the nested table expressions, table functions, and collection derived tables can be referenced in the select list and in the rest of the subselect using the correlation name. The scope of this correlation name is the same as correlation names for other table or view names in the FROM clause. A nested table expression can be used:

- in place of a view to avoid creating the view (when general use of the view is not required)
- when the desired result table is based on variables.

period-specification

Specifies that a period specification applies to the *table-reference*. A query with a *period-specification* is a temporal query. A *period-specification* cannot be specified for a table or view that has a column referenced in a CONTAINS or SCORE built-in function.

The rows of the table reference are derived by application of the period specification. The intermediate result table of a temporal query does not include rows in the associated history table that were added for the ON DELETE ADD EXTRA ROW attribute in the system-period temporal table definition.

The rows of a view reference are derived by application of the period specification to all of the temporal tables that are accessed when computing the result table of the view. If the view does not access any temporal tables, the period specification has no effect on the result table of the view. If a *period-specification* was specified for any of the table references within the view definition, a table reference of that view cannot include a *period-specification*. The definition of the view must not reference an external function with a data access indication other than NO SQL and must not reference an SQL function unless it is an inline function.

If the CURRENT TEMPORAL SYSTEM_TIME special register is set to a value other than the null value, a *period-specification* is not allowed unless the value of the SYSTIME option is NO.

FOR SYSTEM_TIME

Specifies that the SYSTEM_TIME period is used for the period-specification. The table reference must be a view or a system-period temporal table.

AS OF value

Specifies that the *table-reference* includes each row for which the begin value for the specified period is less than or equal to *value* and the end value for the period is greater than *value*. The *table-reference* contains zero rows if *value* is the null value.

value

Specifies an expression that returns a value of a built-in data type. The result of the expression must be comparable to TIMESTAMP(12) according to the comparison rules specified in [“Datetime comparisons” on page 104](#).

The expression must not contain a column reference, a scalar fullselect, or a function that is non-deterministic, external action, or modifies SQL data.

FROM *value1* TO *value2*

Specifies that the *table-reference* includes rows that exist for the period that is specified from *value1* up to *value2*. A row is included in the *table-reference* if the start value for the period in the row is less than *value2* and the end value for the period in the row is greater than *value1*. The *table-reference* contains zero rows if *value1* is greater than or equal to *value2* or if *value1* or *value2* is the null value.

value1* or *value2

Specifies an expression that returns a value of a built-in data type. The result of the expression must be comparable to `TIMESTAMP(12)` according to the comparison rules specified in [“Datetime comparisons”](#) on page 104.

The expression must not contain a column reference, a scalar fullselect, or a function that is non-deterministic, external action, or modifies SQL data.

BETWEEN *value1* AND *value2*

Specifies that the *table-reference* includes rows in which the specified period overlaps at any point in time between *value1* and *value2*. A row is included in the *table-reference* if the start value for the period in the row is less than or equal to *value2* and the end value for the period in the row is greater than *value1*. The *table-reference* contains zero rows if *value1* is greater than *value2* or if *value1* or *value2* is the null value. If *value1* = *value2*, the expression is equivalent to `AS OF value1`.

value1* or *value2

Specifies an expression that returns a value of a built-in data type. The result of the expression must be comparable to `TIMESTAMP(12)` according to the comparison rules specified in [“Datetime comparisons”](#) on page 104.

The expression must not contain a column reference, a scalar fullselect, or a function that is non-deterministic, external action, or modifies SQL data.

Syntax alternatives:

- `AS OF TIMESTAMP` can be specified in place of `FOR SYSTEM_TIME AS OF`
- `VERSIONS BETWEEN TIMESTAMP` can be specified in place of `FOR SYSTEM_TIME BETWEEN`

json-table-function

Specifies an invocation of the built-in `JSON_TABLE` table function. See [“JSON_TABLE”](#) on page 682 for more information.

xmltable-function

Specifies an invocation of the built-in `XMLTABLE` table function. See [“XMLTABLE”](#) on page 702 for more information.

Data change table reference

A *data-change-table-reference* specifies an intermediate result table that is based on the rows that are directly changed by the `INSERT` statement included in the clause. A *data-change-table-reference* must be the only *table-reference* in the `FROM` clause of the outer fullselect that is used in a select-statement, a `SELECT INTO` statement, a `SET variable` statement, or as the only fullselect in an assignment statement.

The intermediate result table for a *data-change-table-reference* includes all rows that were inserted. All columns of the inserted table may be referenced in the subselect, along with any `INCLUDE` columns defined on the `INSERT` statement. A *data-change-table-reference* has the following restrictions:

- It can appear only in the outer level fullselect.
- The target table or view of the `INSERT` statement is considered a table or view referenced in the query. Therefore, the authorization ID of the query must be authorized to the table or view as well as having the necessary privileges required by the `INSERT`.

- A fullselect in the INSERT statement cannot contain correlated references to columns outside the fullselect of the INSERT statement.
- A *data-change-table-reference* in a select-statement makes the cursor READ ONLY. This means that UPDATE WHERE CURRENT OF and DELETE WHERE CURRENT OF cannot be used.
- If the INSERT references a view, the view must be defined using WITH CASCADED CHECK OPTION or could have been defined using WITH CHECK OPTION. In addition, the view cannot have a WHERE clause that contains:
 - a function that modifies SQL data
 - a function that is not deterministic or has external action
- A *data-change-table-reference* clause cannot be specified in a view definition or a materialized query table definition.
- If the target of the SQL data change statement is a view that is defined with an INSTEAD OF INSERT trigger, an error is returned.

If row access control is enforced for the target of the data change statement, the rows in the intermediate result table already satisfy the rules that are specified in the enabled row permissions. If column access control is enforced for the target of the data change statement, the enabled column masks are applied to the outermost select list. See [“select-clause” on page 725](#) for more information.

FINAL TABLE

Specifies that the rows of the intermediate result table represent the set of rows that are inserted by the SQL data change statement as they appear at the completion of the data change statement. If there are AFTER INSERT triggers or referential constraints that result in further changes to the inserted rows of the table that is the target of the data change statement, an error is returned.

NEW TABLE

Specifies that the rows of the intermediate result table represent the set of rows that are changed by the SQL data change statement prior to the application of referential constraints and AFTER triggers. Data in the target table at the completion of the statement might not match the data in the intermediate result table because of additional processing for referential constraints and AFTER triggers.

Collection derived table

A collection derived table can be used to unnest the elements of arrays into rows.

array-expression

An expression that returns an array data type. The expression must be one of the following expressions:

- An SQL variable
- An SQL parameter
- A CAST specification of a parameter marker

Names for the result columns produced by the UNNEST function can be provided as part of the correlation-clause of the collection-derived-table clause.

The result table depends on the input arguments.

- If a single array argument is specified, the result is a single column table with a column data type that matches the array element data type.
- If more than one array is specified, the first array provides the first column in the result table, the second array provides the second column, and so on. The data type of each column matches the data type of the array elements of the corresponding array argument. If WITH ORDINALITY is specified, an extra column of type BIGINT, which contains the position of the elements in the arrays, is appended.

If the cardinalities of the arrays are not identical, the cardinality of the result table is the same as the array with the largest cardinality. The column values in the table are set to the null value for all rows whose array index value is greater than the cardinality of the corresponding array. In other words, if

each array is viewed as a table with two columns (one for the subindices and one for the data), then UNNEST performs an OUTER JOIN among the arrays using equality on the subindices as the join predicate.

UNNEST can only be specified within an SQL procedure or SQL function.

Correlated references in table-references

Correlated references can be used in *nested-table-expressions*. The basic rule that applies is that the correlated reference must be from a *table-reference* at a higher level in the hierarchy of subqueries. This hierarchy includes the *table-references* that have already been resolved in the left-to-right processing of the FROM clause. For nested table expressions, the TABLE or LATERAL keyword must appear before the fullselect. For more information see [“References to SQL parameters and SQL variables” on page 1571](#)

A table function can contain one or more correlated references to other tables in the same FROM clause if the referenced tables precede the reference in the left-to-right order of the tables in the FROM clause. The same capability exists for nested table expressions if the optional keyword TABLE or LATERAL is specified. Otherwise, only references to higher levels in the hierarchy of subqueries is allowed.

A nested table expression or table function that contains correlated references to other tables in the same FROM clause:

- Cannot participate in a RIGHT OUTER JOIN, FULL OUTER JOIN, or RIGHT EXCEPTION JOIN
- Can participate in LEFT OUTER JOIN or an INNER JOIN if the referenced tables precede the reference in the left-to-right order of the tables in the FROM clause

If *table-reference* identifies a distributed table or a table that has a read trigger; a nested table expression cannot contain a correlated reference to other tables in the same FROM clause when:

- The nested table expression contains a UNION, EXCEPT, or INTERSECT.
- The nested table expression uses the DISTINCT keyword in the select list.
- The nested table expression contains an ORDER BY and FETCH clause.
- The nested table expression is in the FROM clause of another nested table expression that contains one of these restrictions.

Syntax Alternatives: TABLE can be specified in place of LATERAL.

Example 1

The following example is valid:

```
SELECT D.DEPTNO, D.DEPTNAME, EMPINFO.AVGSAL, EMPINFO.EMPCOUNT
FROM DEPARTMENT D,
     (SELECT AVG(E.SALARY) AS AVGSAL, COUNT (*) AS EMPCOUNT
      FROM EMPLOYEE E
      WHERE E.WORKDEPT =
           (SELECT X.DEPTNO
            FROM DEPARTMENT X
            WHERE X.DEPTNO = E.WORKDEPT ) ) AS EMPINFO
```

The following example is not valid because the reference to D.DEPTNO in the WHERE clause of the *nested-table-expression* attempts to reference a table that is outside the hierarchy of subqueries:

```
SELECT D.DEPTNO, D.DEPTNAME,
       EMPINFO.AVGSAL, EMPINFO.EMPCOUNT
FROM DEPARTMENT D,
     (SELECT AVG(E.SALARY) AS AVGSAL, COUNT (*) AS EMPCOUNT
      FROM EMPLOYEE E
      WHERE E.WORKDEPT = D.DEPTNO ) AS EMPINFO
***INCORRECT***
```

The following example is valid because the reference to D.DEPTNO in the WHERE clause of the *nested-table-expression* references DEPT, which precedes the *nested-table-expression* and the LATERAL keyword was specified:

```

SELECT D.DEPTNO, D.DEPTNAME,
       EMPINFO.AVGSAL, EMPINFO.EMPCOUNT
FROM DEPARTMENT D,
LATERAL (SELECT AVG(E.SALARY) AS AVGSAL, COUNT (*) AS EMPCOUNT
         FROM EMPLOYEE E
         WHERE E.WORKDEPT = D.DEPTNO ) AS EMPINFO

```

Example 2

The following example of a table function is valid:

```

SELECT t.c1, z.c5
FROM t, TABLE(tf3 (t.c2 ) ) AS z
WHERE t.c3 = z.c4

```

The following example is not valid because the reference to t.c2 is for a table that is to the right of the table function in the FROM clause:

```

SELECT t.c1, z.c5
FROM TABLE(tf6 (t.c2 ) ) AS z, t
WHERE t.c3 = z.c4
***INCORRECT***

```

Example 3

The following example of a table function is valid:

```

SELECT t.c1, z.c5
FROM t, TABLE(tf4 (2 * t.c2 ) ) AS z
WHERE t.c3 = z.c4

```

The following example is not valid because the reference to b.c2 is for the table function that is to the right of the table function containing the reference to b.c2 in the FROM clause:

```

SELECT a.c1, b.c5
FROM TABLE(tf7a (b.c2 ) ) AS z,
      TABLE(tf7b (a.c6 ) ) AS b
WHERE a.c3 = b.c4
***INCORRECT***

```

joined-table

A *joined-table* specifies an intermediate result table that is the result of either an inner, outer, cross, or exception join. The table is derived by applying one of the join operators: INNER, LEFT OUTER, RIGHT OUTER, FULL OUTER, LEFT EXCEPTION, RIGHT EXCEPTION, or CROSS to its operands.

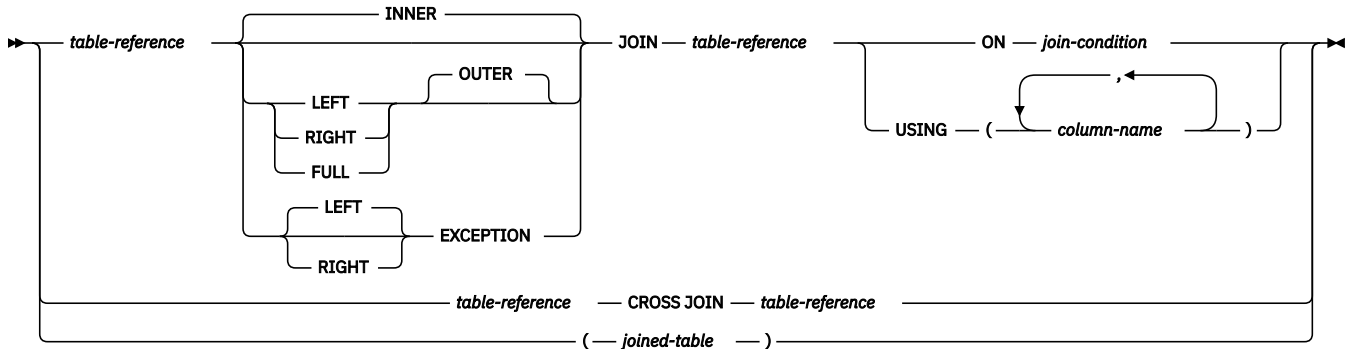

If a join operator is not specified, INNER is implicit. The order in which multiple joins are performed can affect the result. Joins can be nested within other joins. The order of processing for joins is generally from left to right, but based on the position of the required *join-condition* or USING clause. Parentheses are recommended to make the order of nested joins more readable. For example:

```
TB1 LEFT JOIN TB2 ON TB1.C1=TB2.C1
LEFT JOIN TB3 LEFT JOIN TB4 ON TB3.C1=TB4.C1
ON TB1.C1=TB3.C1
```

is the same as

```
(TB1 LEFT JOIN TB2 ON TB1.C1=TB2.C1)
LEFT JOIN (TB3 LEFT JOIN TB4 ON TB3.C1=TB4.C1)
ON TB1.C1=TB3.C1
```

An inner join combines each row of the left table with every row of the right table keeping only the rows where the *join-condition* (or USING clause) is true. Thus, the result table may be missing rows from either or both of the joined tables. Outer joins include the rows produced by the inner join as well as the missing rows, depending on the type of outer join. Exception joins include only the missing rows, depending on the type of exception join.

- A left outer join includes the rows from the left table that were missing from the inner join.
- A right outer join includes the rows from the right table that were missing from the inner join.
- A full outer join includes the rows from both tables that were missing from the inner join.
- A left exception join includes only the rows from the left table that were missing from the inner join.
- A right exception join includes only the rows from the right table that were missing from the inner join.

A joined table can be used in any context in which any form of the SELECT statement is used. A view or a cursor is read-only if its SELECT statement includes a joined table.

Join condition

The *join-condition* is a *search-condition* that must conform to these rules:

- It cannot contain a quantified subquery, IN predicate with a subselect, or EXISTS subquery. It can contain basic predicate subqueries and scalar-fullselects.
- Any column referenced in an expression of the *join-condition* must be a column of one of the operand tables of the associated join (in the scope of the same joined-table clause).
- Each column name must unambiguously identify a column in one of the tables in the *from-clause*.
- Aggregate functions cannot be used in the *expression*.

For any type of join, column references in an expression of the *join-condition* are resolved using the rules for resolution of column name qualifiers specified in “Column names” on page 133 before any rules about which tables the columns must belong to are applied.

Join USING

The USING clause specifies a shorthand way of defining the join condition. This form is known as a *named-columns-join*.

column-name

Must unambiguously identify a column that exists in both *table-references* of the joined table. The column must not be a DATALINK column.

The result table of the join contains the columns from the USING clause first, then the columns from the first table of the join that were not in the USING clause, followed by the remaining columns from the second table of the join that were not in the USING clause. Any column specified in the USING clause cannot be qualified in the query.

The USING clause is equivalent to a *join-condition* in which each column from the left *table-reference* is compared equal to a column of the same name in the right *table-reference*. For example, assume that TB1 and TB2 have columns C1, C2, ... Cn, D1, D2 *named-columns-join* of the form:

```
TB1 INNER JOIN TB2
      USING (C1, C2, ... Cn)
```

defines a result table that is equivalent to:

```
SELECT TB1.*, TB2.D1, TB2.D2
FROM TB1 INNER JOIN TB2
      ON TB1.C1 = TB2.C1 AND
      TB1.C2 = TB2.C2 AND
      ...
      TB1.Cn = TB2.Cn
```

Join operations

A *join-condition* (or USING clause) specifies pairings of T1 and T2, where T1 and T2 are the left and right operand tables of the JOIN operator of the *join-condition* (or USING clause). For all possible combinations of rows of T1 and T2, a row of T1 is paired with a row of T2 if the *join-condition* (or USING clause) is true. When a row of T1 is joined with a row of T2, a row in the result consists of the values of that row of T1 concatenated with the values of that row of T2. In the case of OUTER joins, the execution might involve the generation of a null row. The null row of a table consists of a null value for each column of the table, regardless of whether the columns allow null values.

INNER JOIN or JOIN

The result of T1 INNER JOIN T2 consists of their paired rows.

Using the INNER JOIN syntax with a *join-condition* (or USING clause) will produce the same result as specifying the join by listing two tables in the FROM clause separated by commas and using the *where-clause* to provide the join condition.

LEFT JOIN or LEFT OUTER JOIN

The result of T1 LEFT OUTER JOIN T2 consists of their paired rows and, for each unpaired row of T1, the concatenation of that row with the null row of T2. All columns derived from T2 allow null values.

RIGHT JOIN or RIGHT OUTER JOIN

The result of T1 RIGHT OUTER JOIN T2 consists of their paired rows and, for each unpaired row of T2, the concatenation of that row with the null row of T1. All columns derived from T1 allow null values.

FULL JOIN or FULL OUTER JOIN

The result of T1 FULL OUTER JOIN T2 consists of their paired rows and, for each unpaired row of T2, the concatenation of that row with the null row of T1 and, for each unpaired row of T1, the concatenation of that row with the null row of T2. All columns derived from T1 and T2 allow null values.

FULL OUTER JOIN is not allowed if the query specifies:

- a distributed table,
- a table with a read trigger, or
- a logical file built over multiple physical file members.

LEFT EXCEPTION JOIN and EXCEPTION JOIN

The result of T1 LEFT EXCEPTION JOIN T2 consists only of each unpaired row of T1, the concatenation of that row with the null row of T2. All columns derived from T2 allow null values.

RIGHT EXCEPTION JOIN

The result of T1 RIGHT EXCEPTION JOIN T2 consists only of each unpaired row of T2, the concatenation of that row with the null row of T1. All columns derived from T1 allow null values.

CROSS JOIN

The result of T1 CROSS JOIN T2 consists of each row of T1 paired with each row of T2. CROSS JOIN is also known as Cartesian product.

Hierarchical queries

Hierarchical queries are a form of recursive query that provides support for retrieving a hierarchy, such as a bill of materials, from relational data using a CONNECT BY clause.

Connect-by recursion uses the same subquery for the seed (start) and the recursive step (connect). This combination provides a concise method of representing recursions such as bills-of-material, reports-to-chains, or email threads.

Connect-by recursion returns an error if a cycle occurs. A cycle occurs when a row produces itself, either directly or indirectly. Using the optional CONNECT BY NOCYCLE clause, the recursion can be directed to ignore the duplicated row, thus avoiding both the cycle and the error.

subselect

Hierarchical query support includes the following extensions to the subselect.

- The subselect includes a *hierarchical-query-clause*
- The clauses of the subselect are processed in the following sequence:
 1. FROM clause
 2. *hierarchical-query-clause*
 3. WHERE clause
 4. GROUP BY clause
 5. HAVING clause
 6. SELECT clause
 7. ORDER BY clause
 8. OFFSET clause
 9. FETCH clause
- If the subselect includes a *hierarchical-query-clause*, special rules apply for the order of processing the predicates in the WHERE clause. The *search-condition* is factored into predicates along with its AND conditions (conjunction). If a predicate is an implicit join predicate (that is, it references more than one table in the FROM clause), the predicate is applied before the *hierarchical-query-clause*. Any predicate referencing at most one table in the FROM clause is applied to the intermediate result table of the *hierarchical-query-clause*.

A hierarchical query involving joins should be written using explicit joined tables with an ON clause to avoid confusion about the application of WHERE clause predicates.

- The ORDER SIBLINGS BY clause can be specified if the subselect includes a *hierarchical-query-clause*. This clause specifies that the ordering applies only to siblings within the hierarchies.

hierarchical-query-clause

A subselect that includes a *hierarchical-query-clause* is called a hierarchical query.

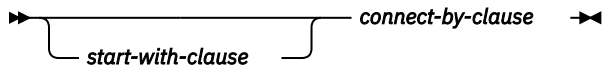

start-with-clause

▶▶ START WITH — *search-condition* ▶▶

connect-by-clause

▶▶ CONNECT BY — *search-condition* ▶▶
 └─ NOCYCLE ─┘

After establishing a first intermediate result table H_1 , subsequent intermediate result tables H_2 , H_3 , and so forth are generated by joining H_n with R using the *connect-by-clause* as a join condition to produce H_{n+1} . R is the result of the FROM clause of the subselect and any join predicates in the WHERE clause. The process stops when H_{n+1} has yielded an empty result table or when processing has reached the maximum supported depth level of 250. The result table H of the *hierarchical-query-clause* is the UNION ALL of every H_i .

start-with-clause

Specifies the intermediate result table H_1 for the hierarchical query that consists of those rows of R for which the *search-condition* is true. If the *start-with-clause* is not specified, H_1 is the entire intermediate result table R .

connect-by-clause

Produces the intermediate result table H_{n+1} from H_n by joining H_n with R , using the *search-condition*.

If the intermediate result table H_{n+1} would return a row from R for a hierarchical path that is the same as a row from R that is already in that hierarchical path, an error is returned.

NOCYCLE

Specifies that an error is not returned, but the repeated row is not included in the intermediate result table H_{n+1} .

The rules for the *search-condition* in the *start-with-clause* and the *connect-by-clause* are the same as for the *where-clause*.

The unary operator PRIOR is used to distinguish column references to H_n , the last prior recursive step, from column references to R . For example:

```
CONNECT BY MGRID = PRIOR EMPID
```

MGRID is resolved with R , and EMPID is resolved within the previous intermediate result table H_n .

A subselect that is a hierarchical query returns the intermediate result set in a partial order unless that order is destroyed through the use of an explicit ORDER BY clause, a GROUP BY or HAVING clause, or a DISTINCT keyword in the select list. The partial order returns rows, such that rows produced in H_{n+1} for a given hierarchy immediately follow the row in H_n that produced them. The ORDER SIBLINGS BY clause can be used to enforce order within a set of rows produced by the same parent.

A NEXT VALUE expression cannot be specified in:

- The parameter list of a CONNECT_BY_ROOT operator or a SYS_CONNECT_BY_PATH function
- The START WITH or CONNECT BY clauses

Examples

- The following reports-to-chain example illustrates connect-by recursion. The example is based on a table named MY_EMP, which is created and populated with data as follows:

```
CREATE TABLE MY_EMP(  
  EMPID  INTEGER NOT NULL PRIMARY KEY,  
  NAME   VARCHAR(10),  
  SALARY DECIMAL(9, 2),  
  MGRID  INTEGER);  
  
INSERT INTO MY_EMP VALUES ( 1, 'Jones',    30000, 10);  
INSERT INTO MY_EMP VALUES ( 2, 'Hall',     35000, 10);  
INSERT INTO MY_EMP VALUES ( 3, 'Kim',      40000, 10);  
INSERT INTO MY_EMP VALUES ( 4, 'Lindsay',  38000, 10);  
INSERT INTO MY_EMP VALUES ( 5, 'McKeough', 42000, 11);  
INSERT INTO MY_EMP VALUES ( 6, 'Barnes',   41000, 11);  
INSERT INTO MY_EMP VALUES ( 7, 'O'Neil',  36000, 12);  
INSERT INTO MY_EMP VALUES ( 8, 'Smith',    34000, 12);  
INSERT INTO MY_EMP VALUES ( 9, 'Shoeman',  33000, 12);  
INSERT INTO MY_EMP VALUES (10, 'Monroe',   50000, 15);  
INSERT INTO MY_EMP VALUES (11, 'Zander',   52000, 16);  
INSERT INTO MY_EMP VALUES (12, 'Henry',    51000, 16);  
INSERT INTO MY_EMP VALUES (13, 'Aaron',    54000, 15);  
INSERT INTO MY_EMP VALUES (14, 'Scott',    53000, 16);  
INSERT INTO MY_EMP VALUES (15, 'Mills',    70000, 17);  
INSERT INTO MY_EMP VALUES (16, 'Goyal',    80000, 17);  
INSERT INTO MY_EMP VALUES (17, 'Urbassek', 95000, NULL);
```

The following query returns all employees working for Goyal, as well as some additional information, such as the reports-to-chain:

```
1 SELECT NAME,  
2     LEVEL,  
3     SALARY,  
4     CONNECT_BY_ROOT NAME AS ROOT,  
5     SUBSTR(SYS_CONNECT_BY_PATH(NAME, ':'), 1, 25) AS CHAIN  
6 FROM MY_EMP  
7 START WITH NAME = 'Goyal'  
8 CONNECT BY PRIOR EMPID = MGRID  
9 ORDER SIBLINGS BY SALARY;
```

NAME	LEVEL	SALARY	ROOT	CHAIN
Goyal	1	80000.00	Goyal	:Goyal
Henry	2	51000.00	Goyal	:Goyal:Henry
Shoeman	3	33000.00	Goyal	:Goyal:Henry:Shoeman
Smith	3	34000.00	Goyal	:Goyal:Henry:Smith
O'Neil	3	36000.00	Goyal	:Goyal:Henry:O'Neil
Zander	2	52000.00	Goyal	:Goyal:Zander
Barnes	3	41000.00	Goyal	:Goyal:Zander:Barnes
McKeough	3	42000.00	Goyal	:Goyal:Zander:McKeough
Scott	2	53000.00	Goyal	:Goyal:Scott

Lines 7 and 8 comprise the core of the recursion. The optional START WITH clause describes the WHERE clause that is to be used on the source table to seed the recursion. In this case, only the row for employee Goyal is selected. If the START WITH clause is omitted, the entire source table is used to seed the recursion. The CONNECT BY clause describes how, given the existing rows, the next set of rows is to be found. The unary operator PRIOR is used to distinguish values in the previous step from those in the current step. PRIOR identifies EMPID as the employee ID of the previous recursive step, and MGRID as originating from the current recursive step.

LEVEL in line 2 is a pseudo column that describes the current level of recursion.

CONNECT_BY_ROOT is a unary operator that always returns the value of its argument as it was during the first recursive step; that is, the values that are returned by an explicit or implicit START WITH clause.

SYS_CONNECT_BY_PATH() is a binary function that prepends the second argument to the first and then appends the result to the value that it produced in the previous recursive step.

Unless explicitly overridden, connect-by recursion returns a result set in a partial order; that is, the rows that are produced by a recursive step always follow the row that produced them. Siblings at the same level of recursion have no specific order. The ORDER SIBLINGS BY clause in line 9 defines an order for these siblings, which further refines the partial order, potentially into a total order.

- Return the organizational structure of the DEPARTMENT table. Use the level of the department to visualize the hierarchy.

```
SELECT LEVEL, CAST(SPACE((LEVEL - 1) * 4) || '/' || DEPTNAME
AS VARCHAR(40)) AS DEPTNAME
FROM DEPARTMENT
START WITH DEPTNO = 'A00'
CONNECT BY NOCYCLE PRIOR DEPTNO = ADMRDEPT
```

The query returns:

```
LEVEL      DEPTNAME
-----
1 /SPIFFY COMPUTER SERVICE DIV.
2 /PLANNING
2 /INFORMATION CENTER
2 /DEVELOPMENT CENTER
3 /MANUFACTURING SYSTEMS
3 /ADMINISTRATION SYSTEMS
2 /SUPPORT SERVICES
3 /OPERATIONS
3 /SOFTWARE SUPPORT
3 /BRANCH OFFICE F2
3 /BRANCH OFFICE G2
3 /BRANCH OFFICE H2
3 /BRANCH OFFICE I2
3 /BRANCH OFFICE J2
```

pseudo columns

A pseudo column is an identifier that shares the same namespace as columns and variables. After regular name resolution for a column has failed, Db2 attempts to match an unqualified identifier to a pseudo column name.

CONNECT_BY_ISCYCLE

CONNECT_BY_ISCYCLE is a pseudo column for use in hierarchical queries. The column returns the value 1 if the row is part of a cycle in the hierarchy; that is, the row has itself as a direct or indirect ancestor given the CONNECT BY clause's *search-condition*. If the row is not part of a cycle, the column returns the value 0.

The data type of the column is SMALLINT and it cannot be null.

CONNECT_BY_ISCYCLE must be specified in the context of a hierarchical query but cannot be specified in the START WITH clause or the CONNECT BY clause, as an argument of the CONNECT_BY_ROOT operator, or as an argument of the SYS_CONNECT_BY_PATH function.

CONNECT_BY_ISLEAF

CONNECT_BY_ISLEAF is a pseudo column for use in hierarchical queries. The column returns the value 1 if the row is a leaf in the hierarchy as defined by the CONNECT BY clause. If the row is not a leaf, the column returns the value 0.

The data type of the column is SMALLINT and it cannot be null.

CONNECT_BY_ISLEAF must be specified in the context of a hierarchical query but cannot be specified in the START WITH clause or the CONNECT BY clause, as an argument of the CONNECT_BY_ROOT operator, or as an argument of the SYS_CONNECT_BY_PATH function.

LEVEL

LEVEL is a pseudo column for use in hierarchical queries. The column returns the recursive step in the hierarchy at which the row was produced. All rows produced by the START WITH clause return the value 1. Rows produced by applying the first iteration of the CONNECT BY clause return 2, and so on.

The data type of the column is INTEGER and it cannot be null.

LEVEL must be specified in the context of a hierarchical query but cannot be specified in the START WITH clause, as an argument of the CONNECT_BY_ROOT operator, or as an argument of the SYS_CONNECT_BY_PATH function.

CONNECT_BY_ROOT

The CONNECT_BY_ROOT unary operator is for use only in hierarchical queries. For every row in the hierarchy, this operator returns the expression for the row's root ancestor.

► CONNECT_BY_ROOT — *expression* ◄

expression

An expression that does not contain a NEXT VALUE expression, a hierarchical query construct (such as the LEVEL pseudocolumn), the SYS_CONNECT_BY_PATH function, or an OLAP specification.

The result data type and length of the operator is the same as the result data type and length of the expression.

A CONNECT_BY_ROOT operator cannot be specified in the START WITH clause or the CONNECT BY clause of a hierarchical query. It cannot be specified as an argument to the SYS_CONNECT_BY_PATH function.

A CONNECT_BY_ROOT operator has a higher precedence than any infix operator. Therefore, to pass an expression with infix operators (such as + or ||) as an argument, parentheses must be used. For example:

```
CONNECT_BY_ROOT FIRSTNME || LASTNAME
```

returns the FIRSTNME value of the root ancestor row concatenated with the LASTNAME value of the actual row in the hierarchy, because this expression is equivalent to:

```
(CONNECT_BY_ROOT FIRSTNME) || LASTNAME
```

rather than:

```
CONNECT_BY_ROOT (FIRSTNME || LASTNAME)
```

Example

- Return the hierarchy of departments and their root departments in the DEPARTMENT table.

```
SELECT CONNECT_BY_ROOT DEPTNAME AS ROOT, DEPTNAME
FROM DEPARTMENT
START WITH DEPTNO IN ('B01','C01','D01','E01')
CONNECT BY PRIOR DEPTNO = ADMRDEPT
```

This query returns:

ROOT	DEPTNAME
-----	-----
PLANNING	PLANNING
INFORMATION CENTER	INFORMATION CENTER
DEVELOPMENT CENTER	DEVELOPMENT CENTER
DEVELOPMENT CENTER	MANUFACTURING SYSTEMS
DEVELOPMENT CENTER	ADMINISTRATION SYSTEMS
SUPPORT SERVICES	SUPPORT SERVICES
SUPPORT SERVICES	OPERATIONS
SUPPORT SERVICES	SOFTWARE SUPPORT
SUPPORT SERVICES	BRANCH OFFICE F2
SUPPORT SERVICES	BRANCH OFFICE G2
SUPPORT SERVICES	BRANCH OFFICE H2
SUPPORT SERVICES	BRANCH OFFICE I2
SUPPORT SERVICES	BRANCH OFFICE J2

PRIOR

The PRIOR unary operator is for use only in the CONNECT BY clause of hierarchical queries.

►► PRIOR — *expression* ◄◄

The CONNECT BY clause performs an inner join between the intermediate result table H_n of the hierarchical query and the source result table specified in the FROM clause. All column references to tables that are referenced in the FROM clause, and which are arguments to the PRIOR operator, are considered to be ranging over H_n .

The primary key of the intermediate result table H_n is typically joined to the foreign keys of the source result table to recursively traverse the hierarchy.

```
CONNECT BY PRIOR T.PK = T.FK
```

If the primary key is a composite key, care must be taken to prefix each column with PRIOR:

```
CONNECT BY PRIOR T.PK1 = T.FK1 AND PRIOR T.PK2 = T.FK2
```

expression

An expression that does not contain a NEXT VALUE expression, a hierarchical query construct (such as the LEVEL pseudocolumn), the SYS_CONNECT_BY_PATH function, or an OLAP specification.

The result data type and length of the operator is the same as the result data type and length of the expression.

A PRIOR operator has a higher precedence than any infix operator. Therefore, to pass an expression with infix operators (such as + or ||) as an argument, parentheses must be used. For example:

```
PRIOR FIRSTNME || LASTNAME
```

returns the FIRSTNME value of the prior row concatenated with the LASTNAME value of the actual row in the hierarchy, because this expression is equivalent to:

```
(PRIOR FIRSTNME) || LASTNAME
```

rather than:

```
PRIOR (FIRSTNME || LASTNAME)
```

Example

- Return the hierarchy of departments in the DEPARTMENT table.

```
SELECT LEVEL, DEPTNAME
FROM DEPARTMENT
START WITH DEPTNO = 'A00'
CONNECT BY NOCYCLE PRIOR DEPTNO = ADMRDEPT
```

This query returns:

```
LEVEL      DEPTNAME
-----
1 SPIFFY COMPUTER SERVICE DIV.
2 PLANNING
2 INFORMATION CENTER
2 DEVELOPMENT CENTER
3 MANUFACTURING SYSTEMS
3 ADMINISTRATION SYSTEMS
2 SUPPORT SERVICES
3 OPERATIONS
3 SOFTWARE SUPPORT
3 BRANCH OFFICE F2
3 BRANCH OFFICE G2
3 BRANCH OFFICE H2
```

3 BRANCH OFFICE I2
3 BRANCH OFFICE J2

SYS_CONNECT_BY_PATH

The SYS_CONNECT_BY_PATH function is used in hierarchical queries to build a string representing a path from the root row to this row.

► **SYS_CONNECT_BY_PATH** — (— *string-expression1* — , — *string-expression2* —) ►

The string for a given row at LEVEL *n* is built as follows:

- Step 1 (using the values of the root row from the first intermediate result table H₁):

```
path1 := string-expression2 || string-expression1
```

- Step *n* (based on the row from the intermediate result table H_{*n*}):

```
pathn := pathn-1 || string-expression2 || string-expression1
```

string-expression1

A character string expression that identifies the row. It must be a built-in character string data type. The expression must not include a NEXT VALUE expression for a sequence, any hierarchical query construct such as the LEVEL pseudocolumn or the CONNECT_BY_ROOT operator, an OLAP specification, or an aggregate function.

string-expression2

A character string expression that serves as a separator. It must be a built-in character string data type. The expression must not include a NEXT VALUE expression for a sequence, any hierarchical query construct such as the LEVEL pseudocolumn or the CONNECT_BY_ROOT operator, an OLAP specification, or an aggregate function.

The result is a CLOB(1M).

The SYS_CONNECT_BY_PATH function must not be used outside of the context of a hierarchical query. It cannot be used in a START WITH clause or a CONNECT BY clause.

Example

- Return the hierarchy of departments in the DEPARTMENT table.

```
SELECT CAST(SYS_CONNECT_BY_PATH(DEPTNAME, '/')
           AS VARCHAR(76)) AS ORG
FROM DEPARTMENT
START WITH DEPTNO = 'A00'
CONNECT BY NOCYCLE PRIOR DEPTNO = ADMRDEPT
```

This query returns:

```
ORG
-----
/SPIFFY COMPUTER SERVICE DIV.
/SPIFFY COMPUTER SERVICE DIV./PLANNING
/SPIFFY COMPUTER SERVICE DIV./INFORMATION CENTER
/SPIFFY COMPUTER SERVICE DIV./DEVELOPMENT CENTER
/SPIFFY COMPUTER SERVICE DIV./DEVELOPMENT CENTER/MANUFACTURING SYSTEMS
/SPIFFY COMPUTER SERVICE DIV./DEVELOPMENT CENTER/ADMINISTRATION SYSTEMS
/SPIFFY COMPUTER SERVICE DIV./SUPPORT SERVICES
/SPIFFY COMPUTER SERVICE DIV./SUPPORT SERVICES/OPERATIONS
/SPIFFY COMPUTER SERVICE DIV./SUPPORT SERVICES/SOFTWARE SUPPORT
/SPIFFY COMPUTER SERVICE DIV./SUPPORT SERVICES/BRANCH OFFICE F2
/SPIFFY COMPUTER SERVICE DIV./SUPPORT SERVICES/BRANCH OFFICE G2
/SPIFFY COMPUTER SERVICE DIV./SUPPORT SERVICES/BRANCH OFFICE H2
/SPIFFY COMPUTER SERVICE DIV./SUPPORT SERVICES/BRANCH OFFICE I2
/SPIFFY COMPUTER SERVICE DIV./SUPPORT SERVICES/BRANCH OFFICE J2
```

where-clause

The WHERE clause specifies an intermediate result table that consists of those rows of R for which the *search-condition* is true. R is the result of the FROM clause of the statement.

► WHERE — *search-condition* ◄

The *search-condition* must conform to the following rules:

- Each *column-name* must unambiguously identify a column of R or be a correlated reference. A *column-name* is a correlated reference if it identifies a column of a table, view, *common-table-expression*, or *nested-table-expression* identified in an outer fullselect.
- An aggregate function must not be specified unless the WHERE clause is specified in a subquery of a HAVING clause and the argument of the function is a correlated reference to a group.

Any subquery in the *search-condition* is effectively executed for each row of R and the results are used in the application of the *search-condition* to the given row of R. A subquery is executed for each row of R if it includes a correlated reference to a column of R. A subquery with no correlated reference is typically executed just once.

If row access controls are enabled for a table and no other row permission is defined, the row access control search condition is the default row permission, $1 = 0$. If only one row permission is defined, the row access control search condition is the search conditions that are specified by that permission. Otherwise, if multiple row permissions are defined for a table, the row access control search condition is derived by application of the logical OR operator to the search conditions that are specified by each row permission. This row access control search condition, as a whole, is connected by application of the logical AND operator to the search conditions specified by the WHERE clause and has the same precedence level as other search conditions in the WHERE clause. This process is repeated for each *table-reference* in the FROM clause of the subselect for which row access controls are enabled.

The row access control search condition acts as a filter to the *table-reference* to determine the results of the *table-reference* that are accessible to the authorization ID of the subselect. Because the order in which operators are evaluated is undefined for operators at the same precedence level, other search conditions in the WHERE clause might be evaluated before the row access control search condition. So, the other search conditions have access to the rows that are restricted by the row permission rules. To ensure that sensitive data is protected, the predicates that reference user-defined functions that are defined with the NOT SECURED option are always evaluated after the row access control search condition.

Column access control does not affect the operation of the WHERE clause.

If a collating sequence other than *HEX is in effect when the statement that contains the WHERE clause is executed and if the *search-condition* contains operands that are SBCS data, mixed data, or Unicode data, then the comparison for those predicates is done using weighted values. The weighted values are derived by applying the collating sequence to the operands of the predicate.

group-by-clause

The GROUP BY clause specifies an intermediate result table that consists of a grouping of the rows of R. R is the result of the previous clause of the subselect.

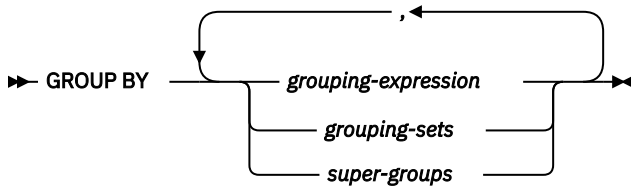

In its simplest form, a GROUP BY clause contains a *grouping-expression*. A *grouping-expression* is an expression that defines the grouping of R. The following restrictions apply to *grouping-expression*.

- Each column name included in *grouping-expression* must unambiguously identify a column of R.
- The result of *grouping-expression* cannot be a DataLink or XML data type or a distinct type that is based on a DataLink or XML.
- *grouping-expression* cannot include any of the following items:
 - A correlated column
 - A variable
 - An aggregate function
 - Any function that is non-deterministic

More complex forms of the GROUP BY clause include *grouping-sets* and *super-groups*. For a description of these forms, see [“grouping-sets” on page 752](#) and [“super-groups” on page 752](#), respectively.

The result of the GROUP BY clause is a set of groups of rows. In each group of more than one row, all values of each *grouping-expression* are equal, and all rows with the same set of values of the *grouping-expressions* are in the same group. For grouping, all null values for a *grouping-expression* are considered equal.

Because every row of a group contains the same value of any *grouping-expression*, *grouping-expressions* can be used in a search condition in a HAVING clause, in the SELECT clause, or in a *sort-key-expression* of an ORDER BY clause (see [“order-by-clause” on page 765](#) for details). In each case, the reference specifies only one value for each group. The *grouping-expression* specified in these clauses must exactly match the *grouping-expression* in the GROUP BY clause, except that blanks are not significant. For example, a *grouping-expression* of

```
SALARY*.10
```

will match the expression in a *having-clause* of

```
HAVING SALARY*.10
```

but will not match

```
HAVING .10 *SALARY  
OR  
HAVING (SALARY*.10)+100
```

If the *grouping-expression* contains varying-length strings with trailing blanks, the values in the group can differ in the number of trailing blanks and may not all have the same length. In that case, a reference to the *grouping-expression* still specifies only one value for each group, but the value for a group is chosen arbitrarily from the available set of values. Thus, the actual length of the result value is unpredictable.

Column access controls do not affect the operation of the GROUP BY clause. The grouping is performed using the original column values.

If a collating sequence other than *HEX is in effect when the statement that contains the GROUP BY clause is executed, and the *grouping-expressions* are SBCS data, mixed data, or Unicode data, then the rows are placed into groups using the weighted values. The weighted values are derived by applying the collating sequence to the *grouping-expressions*. In that case, a reference to the *grouping-expression* still specifies only one value for each group, but the value for a group is chosen arbitrarily from the available set of values. Thus, the actual value of the result is unpredictable.

grouping-sets

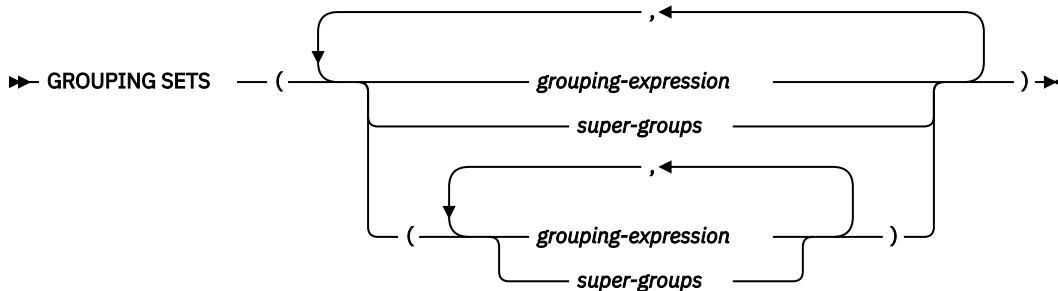

A *grouping-sets* specification allows multiple grouping clauses to be specified in a single statement. This can be thought of as the union of two or more groups of rows into a single result set. It is logically equivalent to the union of multiple subselects with the group by clause in each subselect corresponding to one grouping set. A grouping set can be a single element or can be a list of elements delimited by parentheses, where an element is either a *grouping-expression* or a *super-group*. Using grouping sets allows the groups to be computed with a single pass over the base table.

The *grouping-sets* specification allows either a simple *grouping-expression* to be used, or the more complex forms of *super-groups*. For a description of *super-groups*, see [“super-groups”](#) on page 752.

Note that grouping sets are the fundamental building blocks for GROUP BY operations. A simple GROUP BY with a single column can be considered a grouping set with one element. For example:

GROUP BY a

is the same as

GROUP BY GROUPING SETS((a))

and

GROUP BY a, b, c

is the same as

GROUP BY GROUPING SETS((a,b,c))

Non-aggregation columns from the select list of the subselect that are excluded from a grouping set will return a null for such columns for each row generated for that grouping set. This reflects the fact that aggregation was done without considering the values for those columns.

If a *table-reference* in the previous clauses of the query identifies a distributed table or a table that has a read trigger; a *grouping-sets* specification is not allowed.

Example C2 through Example C7 illustrate the use of grouping sets.

super-groups

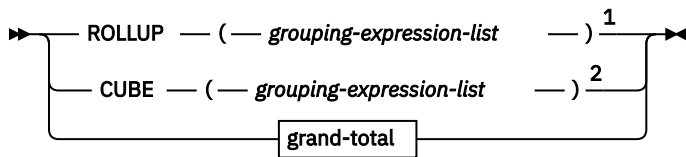

Notes:

¹ Alternate specification when used alone in *group-by-clause* is: *grouping-expression-list* WITH ROLLUP.

² Alternate specification when used alone in *group-by-clause* is: *grouping-expression-list* WITH CUBE.

grouping-expression-list

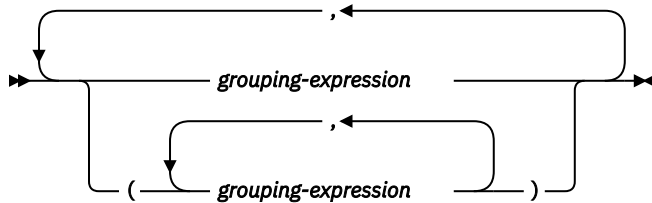

grand-total

► (—) ◄

ROLLUP (grouping-expression-list)

A *ROLLUP grouping* is an extension to the GROUP BY clause that produces a result set containing *sub-total* rows in addition to the "regular" grouped rows. *Sub-total* rows are "super-aggregate" rows that contain further aggregates whose values are derived by applying the same aggregate functions that were used to obtain the grouped rows. These rows are called sub-total rows because that is their most common use; however, any aggregate function can be used for the aggregation. For instance, MAX and AVG are used in example C8.

A ROLLUP grouping is a series of *grouping-sets*. The general specification of a ROLLUP with *n* elements

```
GROUP BY ROLLUP ( C1, C2, . . . , Cn-1, Cn )
```

is equivalent to

```
GROUP BY GROUPING SETS ( (C1, C2, . . . , Cn-1, Cn),
                          (C1, C2, . . . , Cn-1),
                          . . .
                          (C1, C2),
                          (C1),
                          ( ) )
```

Note that the *n* elements of the ROLLUP translate to *n+1* grouping sets. Note also that the order in which the *grouping-expressions* are specified is significant for ROLLUP. For example:

```
GROUP BY ROLLUP ( a, b )
```

is equivalent to

```
GROUP BY GROUPING SETS ( ( a, b ),
                          ( a ),
                          ( ) )
```

while

```
GROUP BY ROLLUP ( b, a )
```

is equivalent to

```
GROUP BY GROUPING SETS ( (b,a),
                          (b),
                          () )
```

The ORDER BY clause is the only way to guarantee the order of the rows in the result set. Example C3 illustrates the use of ROLLUP.

CUBE (*grouping-expression-list*)

A *CUBE grouping* is an extension to the GROUP BY clause that produces a result set that contains all the rows of a ROLLUP aggregation and, in addition, contains "cross-tabulation" rows. *Cross-tabulation* rows are additional "super-aggregate" rows that are not part of an aggregation with sub-totals. Only 10 expressions are allowed in the *grouping-expression-list*.

Like a ROLLUP, a CUBE grouping can also be thought of as a series of *grouping-sets*. In the case of a CUBE, all permutations of the cubed *grouping-expression-list* are computed along with the grand total. Therefore, the n elements of a CUBE translate to $2^{**} n$ (2 to the power n) grouping-sets. For instance, a specification of

```
GROUP BY CUBE (a,b,c)
```

is equivalent to

```
GROUP BY GROUPING SETS ( (a,b,c),
                          (a,b),
                          (a,c),
                          (b,c),
                          (a),
                          (b),
                          (c),
                          () )
```

Notice that the 3 elements of the CUBE translate to 8 grouping sets.

The order of specification of elements does not matter for CUBE. 'CUBE(DayOfYear, Sales_Person)' and 'CUBE(Sales_Person, DayOfYear) yield the same result sets. The use of the word 'same' applies to content of the result set, not to its order. The ORDER BY clause is the only way to guarantee the order of the rows in the result set. Example C4 illustrates the use of CUBE.

grouping-expression-list

A *grouping-expression-list* is used within a CUBE or ROLLUP grouping to define the number of elements in the CUBE or ROLLUP operation. This is controlled by using parentheses to delimit elements with multiple *grouping-expressions*.

The rules for a *grouping-expression* are described in "group-by-clause" on page 751. For example, suppose that a query is to return the total expenses for the ROLLUP of City within a Province but not within a County. However, the clause

```
GROUP BY ROLLUP (Province, County, City)
```

results in unwanted sub-total rows for the County. In the clause

```
GROUP BY ROLLUP (Province, (County, City))
```

the composite (County, City) forms one element in the ROLLUP and, therefore, a query that uses this clause will yield the wanted result. In other words, the two element ROLLUP

```
GROUP BY ROLLUP (Province, (County, City))
```

generates

```
GROUP BY GROUPING SETS ( (Province, County, City),
                          (Province)
                          () )
```

while the three element ROLLUP generates

```
GROUP BY GROUPING SETS ( (Province, County, City),
                          (Province, County),
```



```
(Province),  
( )
```

Example C2 also uses composite column values.

grand-total

Both CUBE and ROLLUP return a row which is the overall (grand total) aggregation. This may be separately specified with empty parentheses within the GROUPING SETS clause. It may also be specified directly in the GROUP BY clause, although there is no effect on the result of the query. Example C4 uses the grand-total syntax.

Combining grouping sets

This can be used to combine any of the types of GROUP BY clauses. When simple *grouping-expressions* are combined with other groups, they are "appended" to the beginning of the resulting *grouping sets*. When ROLLUP and CUBE expressions are combined, they operate like "multipliers" on the remaining expression, forming additional grouping set entries according to the definition of either ROLLUP or CUBE.

For instance, combining *grouping-expression* elements acts as follows

```
GROUP BY a, ROLLUP (b,c)
```

is equivalent to

```
GROUP BY GROUPING SETS( (a,b,c),  
                          (a,b),  
                          (a) )
```

Or similarly

```
GROUP BY a,b, ROLLUP (c,d)
```

is equivalent to

```
GROUP BY GROUPING SETS( (a,b,c,d),  
                          (a,b,c),  
                          (a,b) )
```

Combining of ROLLUP elements acts as follows:

```
GROUP BY ROLLUP(a), ROLLUP (b,c)
```

is equivalent to

```
GROUP BY GROUPING SETS( (a,b,c),  
                          (a,b),  
                          (a),  
                          (b,c),  
                          (b),  
                          ( ) )
```

Similarly,

```
GROUP BY ROLLUP(a), CUBE (b,c)
```

is equivalent to

```
GROUP BY GROUPING SETS( (a,b,c),  
                          (a,b),  
                          (a,c),  
                          (a),  
                          (b,c),  
                          (b),  
                          (c),  
                          ( ) )
```

Combining of CUBE and ROLLUP elements acts as follows:

```
GROUP BY CUBE(a,b), ROLLUP (c,d)
```

is equivalent to

```
GROUP BY GROUPING SETS( (a,b,c,d),
                        (a,b,c),
                        (a,b),
                        (a,c,d),
                        (a,c),
                        (a),
                        (b,c,d),
                        (b,c),
                        (b),
                        (c,d),
                        (c),
                        () )
```

Like a simple *grouping-expression*, combining grouping sets also eliminates duplicates within each grouping set. For instance,

```
GROUP BY a, ROLLUP (a,b)
```

is equivalent to

```
GROUP BY GROUPING SETS( (a,b),
                        (a) )
```

A more complete example of combining grouping sets is to construct a result set that eliminates certain rows that would be returned for a full CUBE aggregation.

For example, consider the following GROUP BY clause:

```
GROUP BY Region,
        ROLLUP (Sales_Person, WEEK(Sales_Date)),
        CUBE (YEAR(Sales_Date), MONTH(Sales_Date))
```

The column listed immediately to the right of GROUP BY is grouped, those within the parentheses following ROLLUP are rolled up, and those within the parentheses following CUBE are cubed. Thus, the above clause results in a cube of MONTH within YEAR which is then rolled up within WEEK within Sales_Person within the Region aggregation. It does not result in any grand total row or any cross-tabulation rows on Region, Sales_Person, or WEEK(Sales_Date) so produces fewer rows than the clause:

```
GROUP BY ROLLUP (Region, Sales_Person, WEEK(Sales_Date),
                YEAR(Sales_Date), MONTH(Sales_Date))
```

Examples of grouping sets, cube, and rollup

The queries in Example C1 through C4 use a subset of the rows in the SALES table based on the predicate 'WEEK(SALES_DATE) = 13'.

```
SELECT WEEK(SALES_DATE) AS WEEK,
        DAYOFWEEK(SALES_DATE) AS DAY_WEEK,
        SALES_PERSON,
        SALES AS UNITS_SOLD
FROM SALES
WHERE WEEK(SALES_DATE) = 13
```

which results in:

WEEK	DAY_WEEK	SALES_PERSON	UNITS_SOLD
13	6	LUCCHESSI	3
13	6	LUCCHESSI	1
13	6	LEE	2
13	6	LEE	2
13	6	LEE	3

13	6 LEE	5
13	6 GOUNOT	3
13	6 GOUNOT	1
13	6 GOUNOT	7
13	7 LUCCHESSI	1
13	7 LUCCHESSI	2
13	7 LUCCHESSI	1
13	7 LEE	7
13	7 LEE	3
13	7 LEE	7
13	7 LEE	4
13	7 GOUNOT	2
13	7 GOUNOT	18
13	7 GOUNOT	1

Example C1:

Here is a query with a basic GROUP BY over 3 columns:

```
SELECT WEEK(SALES_DATE) AS WEEK,
       DAYOFWEEK(SALES_DATE) AS DAY_WEEK,
       SALES_PERSON,
       SUM(SALES) AS UNITS_SOLD
FROM SALES
WHERE WEEK(SALES_DATE) = 13
GROUP BY WEEK(SALES_DATE), DAYOFWEEK(SALES_DATE), SALES_PERSON
ORDER BY WEEK, DAY_WEEK, SALES_PERSON
```

This results in:

WEEK	DAY_WEEK	SALES_PERSON	UNITS_SOLD
13	6	GOUNOT	11
13	6	LEE	12
13	6	LUCCHESSI	4
13	7	GOUNOT	21
13	7	LEE	21
13	7	LUCCHESSI	4

Example C2:

Produce the result based on two different grouping sets of rows from the SALES table.

```
SELECT WEEK(SALES_DATE) AS WEEK,
       DAYOFWEEK(SALES_DATE) AS DAY_WEEK,
       SALES_PERSON,
       SUM(SALES) AS UNITS_SOLD
FROM SALES
WHERE WEEK(SALES_DATE) = 13
GROUP BY GROUPING SETS( (WEEK(SALES_DATE), SALES_PERSON),
                        (DAYOFWEEK(SALES_DATE), SALES_PERSON) )
ORDER BY WEEK, DAY_WEEK, SALES_PERSON
```

This results in:

WEEK	DAY_WEEK	SALES_PERSON	UNITS_SOLD
13	-	GOUNOT	32
13	-	LEE	33
13	-	LUCCHESSI	8
-	6	GOUNOT	11
-	6	LEE	12
-	6	LUCCHESSI	4
-	7	GOUNOT	21
-	7	LEE	21
-	7	LUCCHESSI	4

The rows with WEEK 13 are from the first grouping set and the other rows are from the second grouping set.

Example C3:

If you use 3 distinct columns involved in the grouping sets of Example C2 and perform a ROLLUP, you can see grouping sets for (WEEK, DAY_WEEK, SALES_PERSON), (WEEK, DAY_WEEK), (WEEK), and grand total.

```
SELECT WEEK(SALES_DATE) AS WEEK,
       DAYOFWEEK(SALES_DATE) AS DAY_WEEK,
       SALES_PERSON,
       SUM(SALES) AS UNITS_SOLD
FROM SALES
WHERE WEEK(SALES_DATE) = 13
GROUP BY ROLLUP( WEEK(SALES_DATE), DAYOFWEEK(SALES_DATE), SALES_PERSON )
ORDER BY WEEK, DAY_WEEK, SALES_PERSON
```

This results in:

WEEK	DAY_WEEK	SALES_PERSON	UNITS_SOLD
13	6	GOUNOT	11
13	6	LEE	12
13	6	LUCCHESSI	4
13	6	-	27
13	7	GOUNOT	21
13	7	LEE	21
13	7	LUCCHESSI	4
13	7	-	46
13	-	-	73
-	-	-	73

Example C4:

If you run the same query as Example C3 only replace ROLLUP with CUBE, you can see additional grouping sets for (WEEK, SALES_PERSON), (DAY_WEEK, SALES_PERSON), (DAY_WEEK), and (SALES_PERSON) in the result.

```
SELECT WEEK(SALES_DATE) AS WEEK,
       DAYOFWEEK(SALES_DATE) AS DAY_WEEK,
       SALES_PERSON,
       SUM(SALES) AS UNITS_SOLD
FROM SALES
WHERE WEEK(SALES_DATE) = 13
GROUP BY CUBE( WEEK(SALES_DATE), DAYOFWEEK(SALES_DATE), SALES_PERSON )
ORDER BY WEEK, DAY_WEEK, SALES_PERSON
```

This results in:

WEEK	DAY_WEEK	SALES_PERSON	UNITS_SOLD
13	6	GOUNOT	11
13	6	LEE	12
13	6	LUCCHESSI	4
13	6	-	27
13	7	GOUNOT	21
13	7	LEE	21
13	7	LUCCHESSI	4
13	7	-	46
13	-	GOUNOT	32
13	-	LEE	33
13	-	LUCCHESSI	8
13	-	-	73
-	6	GOUNOT	11
-	6	LEE	12
-	6	LUCCHESSI	4
-	6	-	27
-	7	GOUNOT	21
-	7	LEE	21
-	7	LUCCHESSI	4
-	7	-	46
-	-	GOUNOT	32
-	-	LEE	33
-	-	LUCCHESSI	8
-	-	-	73

Example C5:

Obtain a result set which includes a grand total of selected rows from the SALES table together with a group of rows aggregated by SALES_PERSON and MONTH.

```
SELECT SALES_PERSON,  
       MONTH(SALES_DATE) AS MONTH,  
       SUM(SALES) AS UNITS_SOLD  
FROM SALES  
GROUP BY GROUPING SETS( (SALES_PERSON, MONTH(SALES_DATE)),  
                        ( ) )  
ORDER BY SALES_PERSON, MONTH
```

This results in:

SALES_PERSON	MONTH	UNITS_SOLD
GOUNOT	3	35
GOUNOT	4	14
GOUNOT	12	1
LEE	3	60
LEE	4	25
LEE	12	6
LUCCHESSI	3	9
LUCCHESSI	4	4
LUCCHESSI	12	1
-	-	155

Example C6:

This example shows two simple ROLLUP queries followed by a query which treats the two ROLLUPs as grouping sets in a single result set and specifies row ordering for each column involved in the grouping sets.

Example C6-1:

```
SELECT WEEK(SALES_DATE) AS WEEK,  
       DAYOFWEEK(SALES_DATE) AS DAY_WEEK,  
       SUM(SALES) AS UNITS_SOLD  
FROM SALES  
GROUP BY ROLLUP( WEEK(SALES_DATE), DAYOFWEEK(SALES_DATE) )  
ORDER BY WEEK, DAY_WEEK
```

This results in:

WEEK	DAY_WEEK	UNITS_SOLD
13	6	27
13	7	46
13	-	73
14	1	31
14	2	43
14	-	74
53	1	8
53	-	8
-	-	155

Example C6-2:

```
SELECT MONTH(SALES_DATE) AS MONTH,  
       REGION,  
       SUM(SALES) AS UNITS_SOLD  
FROM SALES  
GROUP BY ROLLUP( MONTH(SALES_DATE), REGION )  
ORDER BY MONTH, REGION
```

This results in:

MONTH	REGION	UNITS_SOLD
3	Manitoba	22

```

3 Ontario-North      8
3 Ontario-South     34
3 Quebec            40
3 -                 104
4 Manitoba           17
4 Ontario-North      1
4 Ontario-South     14
4 Quebec            11
4 -                 43
12 Manitoba          2
12 Ontario-South    4
12 Quebec           2
12 -                 8
- -                 155

```

Example C6-3:

```

SELECT WEEK(SALES_DATE) AS WEEK,
       DAYOFWEEK(SALES_DATE) AS DAY_WEEK,
       MONTH(SALES_DATE) AS MONTH,
       REGION,
       SUM(SALES) AS UNITS_SOLD
FROM SALES
GROUP BY GROUPING SETS(ROLLUP(WEEK(SALES_DATE), DAYOFWEEK(SALES_DATE) ),
                       ROLLUP( MONTH(SALES_DATE), REGION ) )
ORDER BY WEEK, DAY_WEEK, MONTH, REGION

```

This results in:

WEEK	DAY_WEEK	MONTH	REGION	UNITS_SOLD
13	6	-	-	27
13	7	-	-	46
13	-	-	-	73
14	1	-	-	31
14	2	-	-	43
14	-	-	-	74
53	1	-	-	8
53	-	-	-	8
-	-	3	Manitoba	22
-	-	3	Ontario-North	8
-	-	3	Ontario-South	34
-	-	3	Quebec	40
-	-	3	-	104
-	-	4	Manitoba	17
-	-	4	Ontario-North	1
-	-	4	Ontario-South	14
-	-	4	Quebec	11
-	-	4	-	43
-	-	12	Manitoba	2
-	-	12	Ontario-South	4
-	-	12	Quebec	2
-	-	12	-	8
-	-	-	-	155
-	-	-	-	155

Using the two ROLLUPs as grouping sets causes the result to include duplicate rows. There are even two grand total rows.

Observe how the use of ORDER BY has affected the results:

- In the first grouped set, week 53 has been repositioned to the end
- In the second grouped set, month 12 has now been positioned to the end and the regions now appear in alphabetic order.
- Null values are sorted high.

Example C7:

In queries that perform multiple ROLLUPs in a single pass (such as Example C6-3) you may want to be able to indicate which grouping set produced each row. The following steps demonstrate how to provide a column (called GROUP) which indicates the origin of each row in the result set. By origin means which one of the two grouping sets produced the row in the result set.

Step 1: Introduce a way of generating new data values using a query which selects from a VALUES clause (which is an alternate form of a fullselect). This query shows how a table called X can be derived that has 2 columns, R1 and R2, and one row of data.

```
SELECT R1, R2
FROM (VALUES ('GROUP 1', 'GROUP 2')) AS X(R1, R2)
```

Results in:

```
R1      R2
-----
GROUP 1 GROUP 2
```

Step 2: Form the cross product of this table X with the SALES table. This adds columns R1 and R2 to every row.

```
SELECT R1, R2,
       WEEK(SALES_DATE) AS WEEK,
       DAYOFWEEK(SALES_DATE) AS DAY_WEEK,
       MONTH(SALES_DATE) AS MONTH,
       REGION,
       SALES AS UNITS_SOLD
FROM SALES,
     (VALUES ('GROUP 1', 'GROUP 2')) AS X(R1, R2)
```

Step 3: Now these columns are combined with the grouping sets to include these columns in the rollup analysis.

```
SELECT R1, R2,
       WEEK(SALES_DATE) AS WEEK,
       DAYOFWEEK(SALES_DATE) AS DAY_WEEK,
       MONTH(SALES_DATE) AS MONTH,
       REGION,
       SUM(SALES) AS UNITS_SOLD
FROM SALES,
     (VALUES ('GROUP 1', 'GROUP 2')) AS X(R1, R2)
GROUP BY GROUPING SETS((R1, ROLLUP(WEEK(SALES_DATE), DAYOFWEEK(SALES_DATE))),
                       (R2, ROLLUP(MONTH(SALES_DATE), REGION)))
ORDER BY WEEK, DAY_WEEK, MONTH, REGION
```

This results in:

R1	R2	WEEK	DAY_WEEK	MONTH	REGION	UNITS_SOLD
GROUP 1	-	13	6	-	-	27
GROUP 1	-	13	7	-	-	46
GROUP 1	-	13	-	-	-	73
GROUP 1	-	14	1	-	-	31
GROUP 1	-	14	2	-	-	43
GROUP 1	-	14	-	-	-	74
GROUP 1	-	53	1	-	-	8
GROUP 1	-	53	-	-	-	8
-	GROUP 2	-	-	3	Manitoba	22
-	GROUP 2	-	-	3	Ontario-North	8
-	GROUP 2	-	-	3	Ontario-South	34
-	GROUP 2	-	-	3	Quebec	40
-	GROUP 2	-	-	3	-	104
-	GROUP 2	-	-	4	Manitoba	17
-	GROUP 2	-	-	4	Ontario-North	1
-	GROUP 2	-	-	4	Ontario-South	14
-	GROUP 2	-	-	4	Quebec	11
-	GROUP 2	-	-	4	-	43
-	GROUP 2	-	-	12	Manitoba	2
-	GROUP 2	-	-	12	Ontario-South	4
-	GROUP 2	-	-	12	Quebec	2
-	GROUP 2	-	-	12	-	8
-	GROUP 2	-	-	-	-	155
GROUP 1	-	-	-	-	-	155

Step 4: Notice that because R1 and R2 are used in different grouping sets, whenever R1 is non-null in the result, R2 is null and whenever R2 is non-null in the result, R1 is null. That means you can consolidate

these columns into a single column using the COALESCE function. You can also use this column in the ORDER BY clause to keep the results of the two grouping sets together.

```

SELECT COALESCE(R1, R2) AS GROUP,
       WEEK(SALES_DATE) AS WEEK,
       DAYOFWEEK(SALES_DATE) AS DAY_WEEK,
       MONTH(SALES_DATE) AS MONTH,
       REGION,
       SUM(SALES) AS UNITS_SOLD
FROM SALES,
     (VALUES ('GROUP 1', 'GROUP 2')) AS X(R1, R2)
GROUP BY GROUPING SETS((R1, ROLLUP(WEEK(SALES_DATE), DAYOFWEEK(SALES_DATE))),
                       (R2, ROLLUP(MONTH(SALES_DATE), REGION)))
ORDER BY GROUP, WEEK, DAY_WEEK, MONTH, REGION

```

This results in:

GROUP	WEEK	DAY_WEEK	MONTH	REGION	UNITS_SOLD
GROUP 1		13	6	- -	27
GROUP 1		13	7	- -	46
GROUP 1		13	-	- -	73
GROUP 1		14	1	- -	31
GROUP 1		14	2	- -	43
GROUP 1		14	-	- -	74
GROUP 1		53	1	- -	8
GROUP 1		53	-	- -	8
GROUP 1		-	-	- -	155
GROUP 2		-	-	3 Manitoba	22
GROUP 2		-	-	3 Ontario-North	8
GROUP 2		-	-	3 Ontario-South	34
GROUP 2		-	-	3 Quebec	40
GROUP 2		-	-	3 -	104
GROUP 2		-	-	4 Manitoba	17
GROUP 2		-	-	4 Ontario-North	1
GROUP 2		-	-	4 Ontario-South	14
GROUP 2		-	-	4 Quebec	11
GROUP 2		-	-	4 -	43
GROUP 2		-	-	12 Manitoba	2
GROUP 2		-	-	12 Ontario-South	4
GROUP 2		-	-	12 Quebec	2
GROUP 2		-	-	12 -	8
GROUP 2		-	-	- -	155

Example C8

The following example illustrates the use of various aggregate functions when performing a CUBE. The example also makes use of cast functions and rounding to produce a decimal result with reasonable precision and scale.

```

SELECT MONTH(SALES_DATE) AS MONTH,
       REGION,
       SUM(SALES) AS SALES,
       MAX(SALES) AS BEST_SALE,
       CAST(ROUND(AVG(DECIMAL(SALES)),2) AS DECIMAL(5,2)) AS AVG_UNITS_SOLD
FROM SALES
GROUP BY CUBE (MONTH(SALES_DATE), REGION)
ORDER BY MONTH, REGION

```

This results in:

MONTH	REGION	UNITS_SOLD	BEST_SALE	AVG_UNITS_SOLD
3	Manitoba	22	7	3.14
3	Ontario-North	8	3	2.67
3	Ontario-South	34	14	4.25
3	Quebec	40	18	5.00
3	-	104	18	4.00
4	Manitoba	17	9	5.67
4	Ontario-North	1	1	1.00
4	Ontario-South	14	8	4.67
4	Quebec	11	8	5.50
4	-	43	9	4.78

12 Manitoba	2	2	2.00
12 Ontario-South	4	3	2.00
12 Quebec	2	1	1.00
12 -	8	3	1.60
- Manitoba	41	9	3.73
- Ontario-North	9	3	2.25
- Ontario-South	52	14	4.00
- Quebec	53	18	4.42
- -	155	18	3.87

having-clause

The HAVING clause specifies an intermediate result table that consists of those groups of R for which the *search-condition* is true. R is the result of the previous clause of the subselect. If this clause is not GROUP BY, R is considered a single group with no grouping expressions.

►► HAVING — *search-condition* ◄◄

Each expression that contains a *column-name* in the search condition must do one of the following:

- Unambiguously identify a grouping expression of R.
- Be specified within an aggregate function.
- Be a correlated reference. A *column-name* is a correlated reference if it identifies a column of a table, view, common table expression, or nested table expression identified in an outer subselect.

The RRN, RID, DATAPARTITIONNAME, DATAPARTITIONNUM, DBPARTITIONNAME, DBPARTITIONNUM, and HASHED_VALUE functions cannot be specified in the HAVING clause unless it is within an aggregate function. See [“Aggregate functions” on page 259](#) for restrictions that apply to the use of aggregate functions.

A group of R to which the search condition is applied supplies the argument for each aggregate function in the search condition, except for any function whose argument is a correlated reference.

If the search condition contains a subquery, the subquery can be thought of as being executed each time the search condition is applied to a group of R, and the results used in applying the search condition. In actuality, the subquery is executed for each group only if it contains a correlated reference. For an illustration of the difference, see examples 6 and 7 under [“Examples of a subselect” on page 769](#).

A correlated reference to a group of R must either identify a grouping column or be contained within an aggregate function.

When HAVING is used without GROUP BY, any column name in the select list must appear within an aggregate function.

If a collating sequence other than *HEX is in effect when the statement that contains the HAVING clause is executed and if the *search-condition* contains operands that have SBCS data, mixed data, or Unicode data, the comparison for those predicates is done using weighted values. The weighted values are derived by applying the collating sequence to the operands in the predicate.

order-by-clause

The ORDER BY clause specifies an ordering of the rows of the result table.

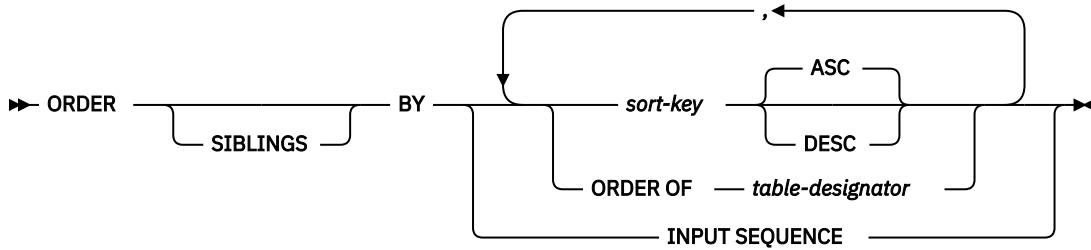

sort-key

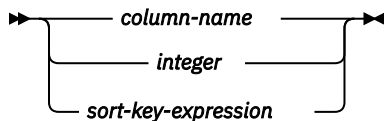

A subselect that contains an ORDER BY clause cannot be specified in the outermost fullselect of a view.

Note: An ORDER BY clause in a subselect does not affect the order of the rows returned by a query. An ORDER BY clause only affects the order of the rows returned if it is specified in the outermost fullselect.

If the subselect is not enclosed within parentheses and is not the outermost fullselect, the ORDER BY clause cannot be specified.

If a single sort specification (one *sort-key* with associated ascending or descending ordering specification) is identified, the rows are ordered by the values of that specification. If more than one sort specification is identified, the rows are ordered by the values of the first identified sort specification, then by the values of the second identified sort specification, and so on.

If the subselect includes a *hierarchical-query-clause*, ORDER SIBLINGS BY can be specified. This specifies that the ordering applies to siblings within the hierarchies only and parent rows are sorted before their child rows.

If a collating sequence other than *HEX is in effect when the statement that contains the ORDER BY clause is executed and if the ORDER BY clause involves sort specifications that are SBCS data, mixed data, or Unicode data, the comparison for those sort specifications is done using weighted values. The weighted values are derived by applying the collating sequence to the values of the sort specifications.

A named column in the select list may be identified by a *sort-key* that is a *integer* or a *column-name*. An unnamed column in the select list may be identified by a *integer* or, in some cases by a *sort-key-expression* that matches the expression in the select list (see details of *sort-key-expression*). “Names of result columns” on page 728 defines when result columns are unnamed. If the fullselect includes a UNION operator, see “fullselect” on page 771 for the rules on named columns in a fullselect.

Ordering is performed in accordance with the comparison rules described in Chapter 2, “Language elements,” on page 43. The null value is higher than all other values. If your ordering specification does not determine a complete ordering, rows with duplicate values of the last identified *sort-key* have an arbitrary order. If the ORDER BY clause is not specified, the rows of the result table have an arbitrary order.

The sum of the length attributes of the *sort-keys* must not exceed 3.5 gigabytes.

column-name

Must unambiguously identify a column of the result table. The column must not be a DATALINK or XML column and must not be the result of the ARRAY_AGG function. The rules for unambiguous column references are the same as in the other clauses of the fullselect. See “Column name qualifiers to avoid ambiguity” on page 135 for more information.

If the fullselect includes a UNION, UNION ALL, EXCEPT, or INTERSECT, the column name cannot be qualified.

The *column-name* may also identify a column name of a table, view, or *nested-table-expression* identified in the FROM clause. This includes columns defined as implicitly hidden. An error occurs if the subselect includes an aggregation in the select list and the *column-name* is not a *grouping-expression*.

integer

Must be greater than 0 and not greater than the number of columns in the result table. The integer *n* identifies the *n*th column of the result table. The identified column must not be a DATALINK or XML column and must not be the result of the ARRAY_AGG function.

sort-key-expression

An expression that is not simply a column name or an unsigned integer constant. The query to which ordering is applied must be a subselect to use this form of *sort-key*.

The *sort-key-expression* cannot contain RRN, RID, DATAPARTITIONNAME, DATAPARTITIONNUM, DBPARTITIONNAME, DBPARTITIONNUM, and HASHED_VALUE scalar functions if the *fullselect* includes a UNION, UNION ALL, EXCEPT, or INTERSECT. The result of the *sort-key-expression* must not be DATALINK or XML.

If the subselect is grouped, the *sort-key-expression* can be an expression in the select list of the subselect or can include an aggregate function, constant, or variable.

ASC

Uses the values of the column in ascending order. This is the default.

DESC

Uses the values of the column in descending order.

ORDER OF table-designator

Specifies that the same ordering used in *table-designator* should be applied to the result table of the subselect. There must be a table reference matching *table-designator* in the FROM clause of the subselect that specifies this clause and the table reference must identify a *nested-table-expression* or *common-table-expression*. The ordering that is applied is the same as if the columns of the ORDER BY clause in the *nested-table-expression* or *common-table-expression* were included in the outer subselect (or fullselect), and these columns were specified in place of the ORDER OF clause. If the *nested-table-expression* or *common-table-expression* has no ORDER BY clause, the order is not defined.

ORDER OF is not allowed if the query specifies:

- a distributed table,
- a table with a read trigger, or
- a logical file built over multiple physical file members.

INPUT SEQUENCE

Specifies that the result table reflects the input order of the rows of an INSERT statement. INPUT SEQUENCE ordering can be specified only when an INSERT statement is specified in a *from-clause*. If INPUT SEQUENCE is specified and the input data is not ordered, the INPUT SEQUENCE clause is ignored.

Column access controls do not effect the operation of the ORDER BY clause. The order is based on the original column values. However, after column masks are applied, the masked values in the final result table might not reflect the order of the original column values.

A *sort-key* must not be LOB if the query specifies:

- a distributed table,
- a table with a read trigger, or
- a logical file built over multiple physical file members.

offset-clause

The *offset-clause* sets the number of rows to skip before any rows are retrieved. It lets the database manager know that the application does not want to start retrieving rows until *offset-row-count* rows have been skipped. If *offset-clause* is not specified, the default is equivalent to `OFFSET 0 ROWS`. If *offset-row-count* specifies more rows than the number of rows in the intermediate result table, the intermediate result table is treated as an empty result table.

►► `OFFSET` — *offset-row-count* 

offset-row-count

An expression that specifies the number of rows to skip before any rows are retrieved. *offset-row-count* must not contain a *scalar-fullselect*, a column reference, a table reference, a user-defined function reference, or a built-in scalar function identified as restricted in a check constraint; see [check-constraint](#). If the data type of the expression is not `BIGINT`, the result of the expression is cast to a `BIGINT` value. The value of *offset-row-count* must be a positive number or zero. It cannot be the null value.

Determining a predictable set of rows to skip requires the specification of an `ORDER BY` clause with sort keys that uniquely identify the sort order of each row in the intermediate result table. If the intermediate result table includes duplicate sort keys for some rows, the order of the rows is not deterministic. If there is no `ORDER BY` clause, the intermediate result table is not in a deterministic order. If the order of the intermediate result table is not deterministic, the set of skipped rows is unpredictable.

An *offset-clause* cannot be specified in the outermost fullselect of a view.

If the fullselect contains an SQL data change statement in the `FROM` clause, all the rows are modified regardless of the number of rows to skip.

Notes

select-list restriction: The *select-list* of the fullselect containing an *offset-clause* must not contain a `NEXT VALUE` sequence expression and must not contain a function that is non-deterministic, external action, or modifies SQL data.

Syntax alternatives: See the Notes entry associated with the *fetch-clause* for alternative syntax to set the number of rows to skip when specifying the maximum number of rows to retrieve.

fetch-clause

The *fetch-clause* sets a maximum number of rows that can be retrieved.

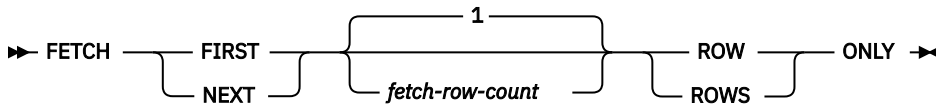

The *fetch-clause* sets a maximum number of rows that can be retrieved. It lets the database manager know that the application does not want to retrieve more than *fetch-row-count* rows, regardless of how many rows there are in the intermediate result table. An attempt to fetch beyond *fetch-row-count* rows is handled the same way as normal end of data.

A *fetch-clause* cannot be specified in the outermost fullselect of a view.

Determining a predictable set of rows to retrieve requires the specification of an **ORDER BY** clause with sort keys that uniquely identify the sort order of each row in the intermediate result table. If the intermediate result table includes duplicate sort keys for some rows, the order of the rows is not deterministic. If there is no **ORDER BY** clause, the intermediate result table is not in a deterministic order. If the order of the intermediate result table is not deterministic, the set of rows retrieved is unpredictable. If both the *order-by-clause* and *fetch-clause* are specified, the *fetch-clause* is processed on the ordered data.

fetch-row-count

An expression that specifies the maximum number of rows to retrieve. *fetch-row-count* must not contain a *scalar-fullselect*, a column reference, a table reference, a user-defined function reference, or a built-in scalar function identified as restricted in a check constraint; see [check-constraint](#). If the data type of the expression is not **BIGINT**, the result of the expression is cast to a **BIGINT** value. The value of *fetch-row-count* must be a positive number or zero. It cannot be the null value.

Limiting the result table to a specified number of rows can improve performance. In some cases, the database manager will cease processing the query when it has determined the specified number of rows. If the *offset-clause* is also specified, the database manager will also consider the offset value in determining when to cease processing.

If the fullselect contains an SQL data change statement in the **FROM** clause, all the rows are modified regardless of the limit on the number of rows to fetch.

Row access controls can indirectly affect the **FETCH FIRST** clause because row access controls affect the rows that are accessible to the authorization ID of the subselect.

Notes

Syntax alternatives:

- The keywords **FIRST** and **NEXT** can be used interchangeably. The result is unchanged; however, using the keyword **NEXT** is more readable when the *offset-clause* is used.
- The following are supported for compatibility with SQL used by other database products. These alternatives are non-standard and should not be used.

Alternative syntax	Equivalent syntax
LIMIT <i>x</i>	FETCH FIRST <i>x</i> ROWS ONLY
LIMIT <i>x</i> OFFSET <i>y</i>	OFFSET <i>y</i> ROWS FETCH FIRST <i>x</i> ROWS ONLY
LIMIT <i>y</i> , <i>x</i>	OFFSET <i>y</i> ROWS FETCH FIRST <i>x</i> ROWS ONLY

Examples of a subselect

subselect can be used in many different ways.

Example 1

Select all columns and rows from the EMPLOYEE table.

```
SELECT * FROM EMPLOYEE
```

Example 2

Join the EMPPROJECT and EMPLOYEE tables, select all the columns from the EMPPROJECT table and add the employee's surname (LASTNAME) from the EMPLOYEE table to each row of the result.

```
SELECT EMPPROJECT.*, LASTNAME
FROM EMPPROJECT, EMPLOYEE
WHERE EMPPROJECT.EMPNO = EMPLOYEE.EMPNO
```

Example 3

Join the EMPLOYEE and DEPARTMENT tables, select the employee number (EMPNO), employee surname (LASTNAME), department number (WORKDEPT in the EMPLOYEE table and DEPTNO in the DEPARTMENT table) and department name (DEPTNAME) of all employees who were born (BIRTHDATE) earlier than 1930.

```
SELECT EMPNO, LASTNAME, WORKDEPT, DEPTNAME
FROM EMPLOYEE, DEPARTMENT
WHERE WORKDEPT = DEPTNO
AND YEAR(BIRTHDATE) < 1930
```

This subselect could also be written as follows:

```
SELECT EMPNO, LASTNAME, WORKDEPT, DEPTNAME
FROM EMPLOYEE INNER JOIN DEPARTMENT
ON WORKDEPT = DEPTNO
WHERE YEAR(BIRTHDATE) < 1930
```

Example 4

Select the job (JOB) and the minimum and maximum salaries (SALARY) for each group of rows with the same job code in the EMPLOYEE table, but only for groups with more than one row and with a maximum salary greater than or equal to 27000.

```
SELECT JOB, MIN(SALARY), MAX(SALARY)
FROM EMPLOYEE
GROUP BY JOB
HAVING COUNT(*) > 1 AND MAX(SALARY) >= 27000
```

Example 5

Select all the rows of EMPPROJECT table for employees (EMPNO) in department (WORKDEPT) 'E11'. (Employee department numbers are shown in the EMPLOYEE table.)

```
SELECT * FROM EMPPROJECT
WHERE EMPNO IN (SELECT EMPNO FROM EMPLOYEE
WHERE WORKDEPT = 'E11')
```

Example 6

From the EMPLOYEE table, select the department number (WORKDEPT) and maximum departmental salary (SALARY) for all departments whose maximum salary is less than the average salary for all employees.

```
SELECT WORKDEPT, MAX(SALARY)
FROM EMPLOYEE
GROUP BY WORKDEPT
HAVING MAX(SALARY) < (SELECT AVG(SALARY)
FROM EMPLOYEE)
```

The subquery in the HAVING clause would only be executed once in this example.

Example 7

Using the EMPLOYEE table, select the department number (WORKDEPT) and maximum departmental salary (SALARY) for all departments whose maximum salary is less than the average salary in all other departments.

```
SELECT WORKDEPT, MAX(SALARY)
FROM EMPLOYEE EMP_COR
GROUP BY WORKDEPT
HAVING MAX(SALARY) < (SELECT AVG(SALARY)
FROM EMPLOYEE
WHERE NOT WORKDEPT = EMP_COR.WORKDEPT)
```

In contrast to example 6, the subquery in the HAVING clause would need to be executed for each group.

Example 8

Join the EMPLOYEE and EMPPROJECT tables, select all of the employees and their project numbers. Return even those employees that do not have a project number currently assigned.

```
SELECT EMPLOYEE.EMPNO, PROJNO
FROM EMPLOYEE LEFT OUTER JOIN EMPPROJECT
ON EMPLOYEE.EMPNO = EMPPROJECT.EMPNO
```

Any employee in the EMPLOYEE table that does not have a project number in the EMPPROJECT table will return one row in the result table containing the EMPNO value and the null value in the PROJNO column.

fullselect

The *fullselect* is a component of the *select-statement*, ALTER TABLE statement for the definition of a materialized query table, CREATE TABLE statement, CREATE VIEW statement, DECLARE GLOBAL TEMPORARY TABLE statement, INSERT statement, SET transition-variable statement, SET VARIABLE statement, UPDATE statement, and *assignment-statement*.

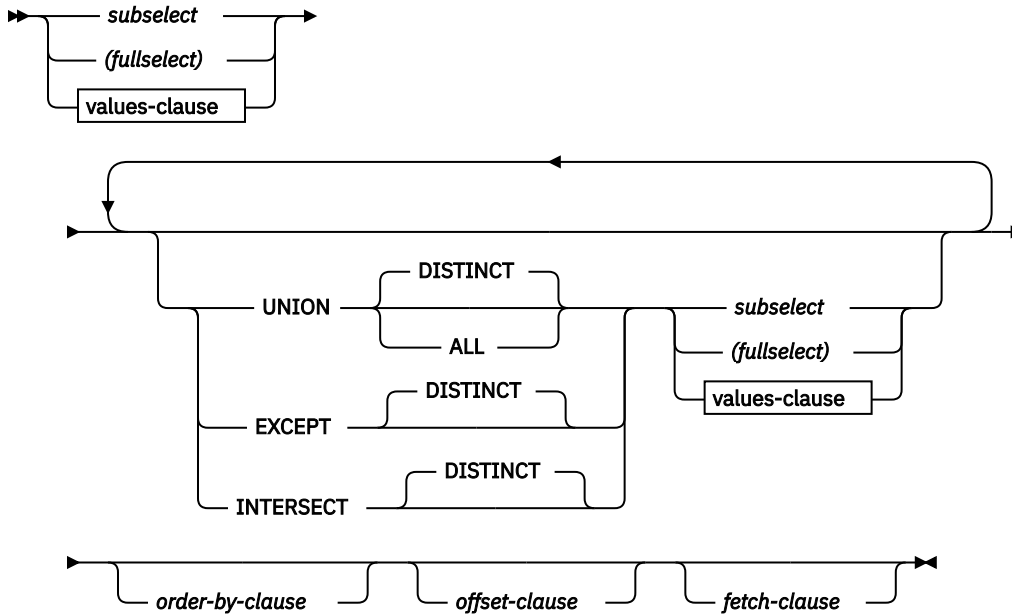

values-clause

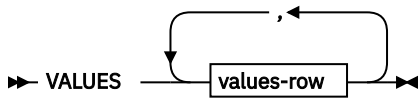

values-row

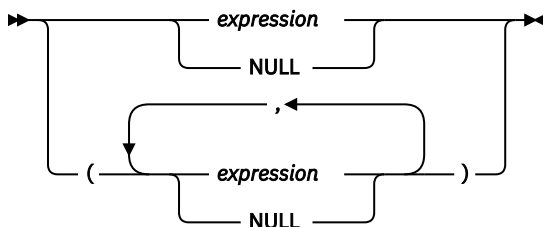

A fullselect that is enclosed in parenthesis is called a *subquery*. For example, a *subquery* can be used in a search condition.

A *scalar-fullselect* is a fullselect, enclosed in parentheses, that returns a single result row and a single result column. If the result of the fullselect is no rows, then the null value is returned. An error is returned if there is more than one row in the result.

A *fullselect* specifies a result table. If *UNION*, *EXCEPT*, or *INTERSECT* is not used, the result of the fullselect is the result of the specified subselect or *values-clause*.

values-clause

Derives a result table by specifying the actual values, using expressions, for each column of a row in the result table. Multiple rows may be specified.

NULL can only be used with multiple specifications of *values-row*, and at least one row in the same column must not be *NULL*.

A *values-row* is specified by:

- A single expression for a single column result table or,
- n expressions (or NULL) separated by commas and enclosed in parentheses, where n is the number of columns in the result table.

A multiple row VALUES clause must have the same number of expressions in each *values-row*.

The following are examples of *values-clauses* and their meanings.

VALUES (1), (2), (3)	- 3 rows of 1 column
VALUES 1, 2, 3	- 3 rows of 1 column
VALUES (1, 2, 3)	- 1 row of 3 columns
VALUES (1,21), (2,22), (3,23)	- 3 rows of 2 columns

A *values-clause* that is composed of n specifications of *values-row*, RE_1 to RE_n , where n is greater than 1 is equivalent to:

```
RE1 UNION ALL RE2 ... UNION ALL REn
```

This means that the corresponding expressions of each *values-row* must be comparable. All result columns in a *values-row* are unnamed.

UNION, EXCEPT, or INTERSECT

The set operators UNION, EXCEPT, and INTERSECT correspond to the relational operators union, difference, and intersection. A fullselect specifies a result table. If a set operator is not used, the result of the fullselect is the result of the specified subselect. Otherwise, the result table is derived by combining two other result tables (R1 and R2) subject to the specified set operator.

UNION DISTINCT or UNION ALL

If UNION is specified without the ALL option, the result is the set of all rows in either R1 or R2, with duplicate rows eliminated. In either case, however, each row of the UNION table is either a row from R1 or a row from R2.

EXCEPT DISTINCT

The result consists of all rows that are only in R1, with duplicate rows in the result of this operation eliminated. Each row in the result table of the difference is a row from R1 that does not have a matching row in R2.

INTERSECT DISTINCT

The result consists of all rows that are in both R1 and R2, with the duplicate rows eliminated. Each row in the result table of the intersection is a row that exists in both R1 and R2.

The expression that corresponds to the n th column in R1 and R2 can reference columns with column masks. The n th column of the result of the set operation can be derived from the masked values in R1 or R2.

With DISTINCT, the elimination of the duplicate rows is based on the unmasked values in R1 and R2. Because all rows are from R1 or R2, the output values in the result table of the set operation may vary when one or more of the following conditions occur:

- The expression corresponding to the n th column in R1 references columns with column masks, but the expression corresponding to the n th column in R2 does not, or vice versa.
- The expressions corresponding to the n th column in R1 and R2 reference columns with different column masks.
- The column mask definition references columns that are not the same target column for which the column mask is defined, and those columns are not part of the DISTINCT operation. It is recommended that the column mask definition does not reference other columns from the target table.

For example, a row in R1 is derived from the masked value, and a row in R2 is derived from the unmasked value. If the DISTINCT picks the row for the result table from R1, the masked value is returned. If the DISTINCT picks the row for the result table from R2, the unmasked value is returned.

Rules for columns:

- R1 and R2 must have the same number of columns, and the data type of the *n*th column of R1 must be compatible with the data type of the *n*th column of R2. Character-string values are compatible with datetime values.
- The *n*th column of the result of UNION, UNION ALL, EXCEPT, or INTERSECT is derived from the *n*th columns of R1 and R2. The attributes of the result columns are determined using the rules for result columns.
- If the *n*th column of R1 is named, then the *n*th column of the result table has that result column name. Otherwise, the result column is unnamed.
- If UNION, INTERSECT, or EXCEPT is specified, no column can be a DATALINK or XML column.

For information on the valid combinations of operand columns and the data type of the result column, see “Rules for result data types” on page 107.

EXCEPT and INTERSECT restrictions: VALUES, INTERSECT, and EXCEPT are not allowed if the query specifies one of the following:

- A distributed table
- A table with a read trigger
- A logical file built over multiple physical file members

Duplicate rows: Two rows are duplicates if each value in the first is equal to the corresponding value of the second. (For determining duplicates, two null values are considered equal.)

Operator precedence: UNION, UNION ALL, and INTERSECT are associative set operations. However, when UNION, UNION ALL, EXCEPT, and INTERSECT are used in the same statement, the result depends on the order in which the operations are performed. Operations within parenthesis are performed first. When the order is not specified by parentheses, operations are performed in left-to-right order with the exception that all INTERSECT operations are performed before UNION or EXCEPT operations.

Results of set operators: In the following example, the values of tables R1 and R2 are shown on the left. The other headings listed show the values as a result of various set operations on R1 and R2.

R1	R2	UNION ALL	UNION	EXCEPT	INTERSECT
1	1	1	1	2	1
1	1	1	2	5	3
1	3	1	3		4
2	3	1	4		
2	3	1	5		
2	3	2			
3	4	2			
4		2			
4		3			
5		3			
		3			
		3			
		3			
		4			
		4			
		4			

R1	R2	UNION ALL	UNION	EXCEPT	INTERSECT

5

Collating sequence: If a collating sequence other than *HEX is in effect when the statement that contains the UNION, EXCEPT, or INTERSECT keyword is executed and if the result tables contain columns that are SBCS data, mixed data, or Unicode data, the comparison for those columns is done using weighted values. The weighted values are derived by applying the collating sequence to each value.

Examples of a fullselect

Example 1

Select all columns and rows from the EMPLOYEE table.

```
SELECT * FROM EMPLOYEE
```

Example 2

List the employee numbers (EMPNO) of all employees in the EMPLOYEE table whose department number (WORKDEPT) either begins with 'E' or who are assigned to projects in the EMPPROJECT table whose project number (PROJNO) equals 'MA2100', 'MA2110', or 'MA2112'.

```
SELECT EMPNO FROM EMPLOYEE
WHERE WORKDEPT LIKE 'E%'
UNION
SELECT EMPNO FROM EMPPROJECT
WHERE PROJNO IN('MA2100', 'MA2110', 'MA2112')
```

Example 3

Make the same query as in example 2, only use UNION ALL so that no duplicate rows are eliminated.

```
SELECT EMPNO FROM EMPLOYEE
WHERE WORKDEPT LIKE 'E%'
UNION ALL
SELECT EMPNO FROM EMPPROJECT
WHERE PROJNO IN('MA2100', 'MA2110', 'MA2112')
```

Example 4

Make the same query as in example 2, and, in addition, "tag" the rows from the EMPLOYEE table with 'emp' and the rows from the EMPPROJECT table with 'empproject'. Unlike the result from example 2, this query may return the same EMPNO more than once, identifying which table it came from by the associated "tag".

```
SELECT EMPNO, 'emp' FROM EMPLOYEE
WHERE WORKDEPT LIKE 'E%'
UNION
SELECT EMPNO, 'empproject' FROM EMPPROJECT
WHERE PROJNO IN('MA2100', 'MA2110', 'MA2112')
```

Example 5

This example of EXCEPT produces all rows that are in T1 but not in T2, with duplicate rows removed.

```
(SELECT * FROM T1)
EXCEPT DISTINCT
(SELECT * FROM T2)
```

If no NULL values are involved, this example returns the same results as:

```
(SELECT DISTINCT *
FROM T1
WHERE NOT EXISTS (SELECT * FROM T2
WHERE T1.C1 = T2.C1 AND T1.C2 = T2.C2 AND... ) )
```

where C1, C2, and so on represent the columns of T1 and T2.

Example 6

This example of INTERSECT produces all rows that are in both tables T1 and T2, with duplicate rows removed.

```
(SELECT * FROM T1)
INTERSECT DISTINCT
(SELECT * FROM T2)
```

If no NULL values are involved, this example returns the same results as:

```
(SELECT DISTINCT *
FROM T1
WHERE EXISTS (SELECT * FROM T2
              WHERE T1.C1 = T2.C1 AND T1.C2 = T2.C2 AND... ) )
```

where C1, C2, and so on represent the columns of T1 and T2.

Example 7

Make the same query as in example 3, only include an additional two employees currently not in any table and tag these rows as "new".

```
SELECT EMPNO, 'emp' FROM EMPLOYEE
WHERE WORKDEPT LIKE 'E%'
UNION
SELECT EMPNO, 'empproject' FROM EMPPROJACT
WHERE PROJNO IN('MA2100', 'MA2110', 'MA2112')
UNION
VALUES ('NEWAAA', 'new'), ('NEWBBB', 'new')
```

select-statement

The *select-statement* is the form of a query that can be directly specified in a DECLARE CURSOR or FOR statement, prepared and then referenced in a DECLARE CURSOR statement, or directly specified in an SQLJ assignment clause. It can also be issued interactively. In any case, the table specified by a *select-statement* is the result of the fullselect.

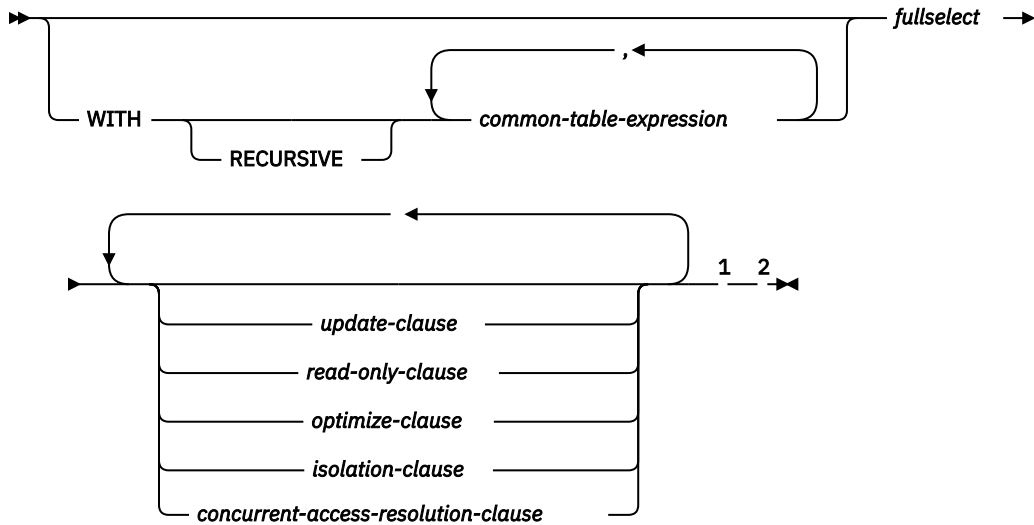

Notes:

- ¹ The update-clause and read-only-clause cannot both be specified in the same select-statement.
- ² Each clause may be specified only once.

RECURSIVE

Indicates that a *common-table-expression* is potentially recursive.

common-table-expression

A *common-table-expression* permits defining a result table with a *table-identifier* that can be specified as a table name in any FROM clause of the fullselect that follows. Multiple common table expressions can be specified following the single WITH keyword. Each common table expression specified can also be referenced by name in the FROM clause of subsequent common table expressions.

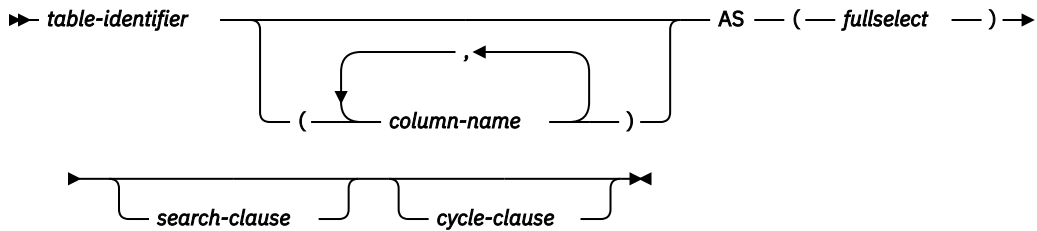

search-clause

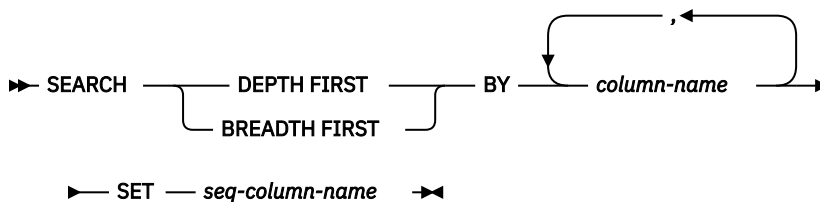

cycle-clause

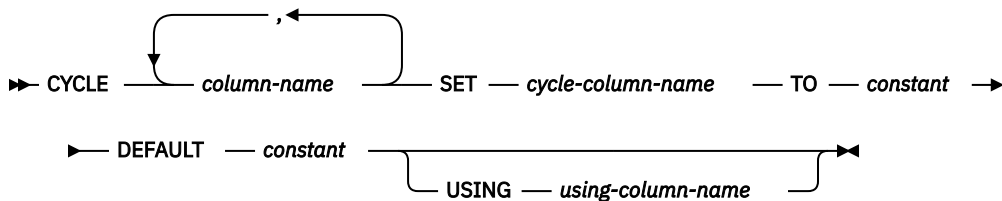

If a list of columns is specified, it must consist of as many names as there are columns in the result table of the fullselect. Each *column-name* must be unique and unqualified. If these column names are not specified, the names are derived from the select list of the subselect used to define the common table expression.

The *table-identifier* of a common table expression must be different from any other common table expression *table-identifier* in the same statement. A common table expression *table-identifier* can be specified as a table name in any FROM clause throughout the fullselect. A *table-identifier* of a common table expression overrides any existing table, view, or alias (in the catalog) with the same unqualified name or any *table-identifier* specified for a trigger.

If more than one common table expression is defined in the same statement, cyclic references between the common table expressions are not permitted. A *cyclic reference* occurs when two common table expressions *dt1* and *dt2* are created such that *dt1* refers to *dt2* and *dt2* refers to *dt1*.

The *table name* of a common table expression can only be referenced in the *select-statement*, INSERT statement, or CREATE VIEW statement that defines it.

If a *select-statement*, INSERT statement, or CREATE VIEW statement refers to an unqualified table name, the following rules are applied to determine which table is actually being referenced:

- If the unqualified name corresponds to one or more common table expression names that are specified in the *select-statement*, the name identifies the common table expression that is in the innermost scope.
- If in a CREATE TRIGGER statement and the unqualified name corresponds to a transition table name, the name identifies that transition table.

- Otherwise, the name identifies a persistent table, a temporary table, or a view that is present in the default schema.

A *common-table-expression* can be used:

- In place of a view to avoid creating the view (when general use of the view is not required and positioned UPDATE or DELETE is not used)
- To enable grouping by a column that is derived from a scalar-fullselect or function that is not deterministic
- When the required result table is based on variables
- When the same result table needs to be shared in a *fullselect*
- When the result needs to be derived using recursion

If a *fullselect* of a common table expression contains a reference to itself in a FROM clause, the common table expression is a *recursive table expression*. Queries using recursion are useful in supporting applications such as bill of materials (BOM), reservation systems, and network planning.

The following restrictions must be true of a recursive *common-table-expression*:

- Each fullselect that is part of the recursion cycle must start with SELECT or SELECT ALL. Use of SELECT DISTINCT is not allowed.
- The UNION ALL set operator must be specified.
- A list of *column-names* must be specified following the *table-identifier* of the *common-table-expression*.
- The first *fullselect* of the first union (the initialization *fullselect*) must not include a reference to the *common-table-expression* itself in any FROM clause.
- Each *fullselect* that is part of the recursion cycle must not include any aggregate functions, GROUP BY clauses, or HAVING clauses.
- The FROM clauses of these *fullselects* can include at most one reference to a *common-table-expression* that is part of a recursion cycle.
- The table being defined in the *common-table-expression* cannot be referenced in a subquery of a *fullselect* that defines the *common-table-expression*.
- LEFT OUTER JOIN and FULL OUTER JOIN are not allowed if the *common-table-expression* is the right operand. RIGHT OUTER JOIN and FULL OUTER JOIN are not allowed if the *common-table-expression* is the left operand.
- Each *fullselect* other than the initialization *fullselect* that is part of the recursion cycle must not include an ORDER BY clause.

If a column name of the *common-table-expression* is referred to in the iterative *fullselect*, the attributes of the result columns are determined using the rules for result columns. For more information see [“Rules for result data types”](#) on page 107.

search-clause

The SEARCH clause in the definition of the recursive *common-table-expression* is used to specify the order in which the result rows are to be returned.

SEARCH DEPTH FIRST

Each parent or containing item appears in the result before the items that it contains.

SEARCH BREADTH FIRST

Sibling items are grouped before subordinate items.

BY *column-name*,...

Identifies the columns that associate the parent and child relationship of the recursive query. Each *column-name* must unambiguously identify a column of the parent. The column must not be a DATALINK or XML column. The rules for unambiguous column references are the same as in the other clauses of the fullselect. See [“Column name qualifiers to avoid ambiguity”](#) on page 135 for more information.

The *column-name* must identify a column name of the recursive *common-table-expression*. The *column-name* must not be qualified.

SET *seq-column-name*

Specifies the name of a result column that contains an ordinal number of the current row in the recursive query result. The data type of the *seq-column-name* is BIGINT.

The *seq-column-name* may only be referenced in the ORDER BY clause of the outer fullselect that references the *common-table-expression*. The *seq-column-name* cannot be referenced in the fullselect that defines the *common-table-expression*.

The *seq-column-name* must not be the same as *using-column-name* or *cycle-column-name*.

cycle-clause

The CYCLE clause in the definition of the recursive *common-table-expression* is used to prevent an infinite loop in the recursive query when the parent and child relationship of the data results in a loop.

CYCLE *column-name*,...

Specifies the list of columns that represent the parent/child join relationship values for the recursion. Any new row from the query is first checked for a duplicate value (per these column names) in the existing rows that lead to this row in the recursive query results to determine if there is a cycle.

Each *column-name* must identify a result column of the common table expression. It must not be an XML or DataLink column. The same *column-name* must not be specified more than once.

SET *cycle-column-name*

Specifies the name of a result column that is set based on whether a cycle has been detected in the recursive query:

- If a duplicate row is encountered, indicating that a cycle has been detected in the data, the *cycle-column-name* is set to the TO *constant*.
- If a duplicate row is not encountered, indicating that a cycle has not been detected in the data, the *cycle-column-name* is set to the DEFAULT *constant*.

The data type of the *cycle-column-name* is CHAR(1).

When cyclic data in the row is encountered, the duplicate row is not returned to the recursive query process for further recursion and that child branch of the query is stopped. By specifying the provided *cycle-column-name* is in the result set of the main fullselect, the existence of cyclic data can actually be determined and even corrected if that is wanted.

The *cycle-column-name* must not be the same as *using-column-name* or *seq-column-name*.

The *cycle-column-name* can be referenced in the fullselect that defines the *common-table-expression*.

TO *constant*

Specifies a CHAR(1) constant value to assign to the *cycle-column* if a cycle has been detected in the data. The TO *constant* must not be equal to the DEFAULT *constant*.

DEFAULT *constant*

Specifies a CHAR(1) constant value to assign to the *cycle-column* if a cycle has not been detected in the data. The DEFAULT *constant* must not be equal to the TO *constant*.

USING *using-column-name*

Identifies the temporary results consisting of the columns from the CYCLE column list. The temporary result is used by the database manager to identify duplicate rows in the query result.

The *using-column-name* must not be the same as *cycle-column-name* or *seq-column-name*.

When developing recursive common table expressions, remember that an infinite recursion cycle (loop) can be created. Ensure that recursion cycles will end. This is especially important if the data involved is cyclic. A recursive common table expression is expected to include a predicate that will prevent an infinite loop. The recursive common table expression is expected to include:

- In the iterative *fullselect*, an integer column incremented by a constant.

- A predicate in the WHERE clause of the iterative *fullselect* in the form "counter_col < constant" or "counter_col < :hostvar".

A warning is issued if this syntax is not found in the recursive common table expression.

Recursive common table expressions are not allowed if the query specifies:

- a distributed table,
- a table with a read trigger, or
- a logical file built over multiple physical file members.

Recursion example: bill of materials

Bill of materials (BOM) applications are a common requirement in many business environments. To illustrate the capability of a recursive common table expression for BOM applications, consider a table of parts with associated subparts and the quantity of subparts required by the part.

For this example, create the table as follows:

```
CREATE TABLE PARTLIST
( PART      VARCHAR(8),
  SUBPART   VARCHAR(8),
  QUANTITY  INTEGER )
```

To give query results for this example, assume that the PARTLIST table is populated with the following values:

PART	SUBPART	QUANTITY
00	01	5
00	05	3
01	02	2
01	03	3
01	04	4
01	06	3
02	05	7
02	06	6
03	07	6
04	08	10
04	09	11
05	10	10
05	11	10
06	12	10
06	13	10
07	14	8
07	12	8

Example 1: Single level explosion

The first example is called single level explosion. It answers the question, "What parts are needed to build the part identified by '01'?". The list will include the direct subparts, subparts of the subparts and so on. However, if a part is used multiple times, its subparts are only listed once.

```
WITH RPL (PART, SUBPART, QUANTITY) AS
( SELECT ROOT.PART, ROOT.SUBPART, ROOT.QUANTITY
  FROM PARTLIST ROOT
  WHERE ROOT.PART = '01'
  UNION ALL
  SELECT CHILD.PART, CHILD.SUBPART, CHILD.QUANTITY
  FROM RPL PARENT, PARTLIST CHILD
  WHERE PARENT.SUBPART = CHILD.PART
)
SELECT DISTINCT PART, SUBPART, QUANTITY
FROM RPL
ORDER BY PART, SUBPART, QUANTITY
```

The above query includes a common table expression, identified by the name RPL, that expresses the recursive part of this query. It illustrates the basic elements of a recursive common table expression.

The first operand (fullselect) of the UNION, referred to as the initialization fullselect, gets the direct children of part '01'. The FROM clause of this fullselect refers to the source table and will never refer to itself (RPL in this case). The result of this first fullselect goes into the common table expression RPL (Recursive PARTLIST). As in this example, the UNION must always be a UNION ALL.

The second operand (fullselect) of the UNION uses RPL to compute subparts of subparts by having the FROM clause refer to the common table expression RPL and the source table with a join of a part from the source table (child) to a subpart of the current result contained in RPL (parent). The result goes back to RPL again. The second operand of UNION is then used repeatedly until no more children exist.

The SELECT DISTINCT in the main fullselect of this query ensures the same part/subpart is not listed more than once.

The result of the query is as follows:

PART	SUBPART	QUANTITY
01	02	2
01	03	3
01	04	4
01	06	3
02	05	7
02	06	6
03	07	6
04	08	10
04	09	11
05	10	10
05	11	10
06	12	10
06	13	10
07	12	8
07	14	8

Observe in the result that part '01' goes to '02' which goes to '06' and so on. Further, notice that part '06' is reached twice, once through '01' directly and another time through '02'. In the output, however, its subcomponents are listed only once (this is the result of using a SELECT DISTINCT) as required.

Example 2: Summarized explosion

The second example is a summarized explosion. The question posed here is, what is the total quantity of each part required to build part '01'. The main difference from the single level explosion is the need to aggregate the quantities. The first example indicates the quantity of subparts required for the part whenever it is required. It does not indicate how many of the subparts are needed to build part '01'.

```
WITH RPL (PART, SUBPART, QUANTITY) AS
(
  SELECT ROOT.PART, ROOT.SUBPART, ROOT.QUANTITY
  FROM PARTLIST ROOT
  WHERE ROOT.PART = '01'
  UNION ALL
  SELECT PARENT.PART, CHILD.SUBPART, PARENT.QUANTITY*CHILD.QUANTITY
  FROM RPL PARENT, PARTLIST CHILD
  WHERE PARENT.SUBPART = CHILD.PART
)
SELECT PART, SUBPART, SUM(QUANTITY) AS "Total Qty Used"
FROM RPL
GROUP BY PART, SUBPART
ORDER BY PART, SUBPART
```

In the above query, the select list of the second operand of the UNION in the recursive common table expression, identified by the name RPL, shows the aggregation of the quantity. To find out how much of a subpart is used, the quantity of the parent is multiplied by the quantity per parent of a child. If a part is used multiple times in different places, it requires another final aggregation. This is done by the grouping over the common table expression RPL and using the SUM aggregate function in the select list of the main fullselect.

The result of the query is as follows:

PART	SUBPART	Total Qty Used
01	02	2
01	03	3
01	04	4
01	06	3
02	05	7
02	06	6
03	07	6
04	08	10
04	09	11
05	10	10
05	11	10
06	12	10
06	13	10
07	12	8
07	14	8

01	02	2
01	03	3
01	04	4
01	05	14
01	06	15
01	07	18
01	08	40
01	09	44
01	10	140
01	11	140
01	12	294
01	13	150
01	14	144

Looking at the output, consider the line for subpart '06'. The total quantity used value of 15 is derived from a quantity of 3 directly for part '01' and a quantity of 6 for part '02' which is needed 2 times by part '01'.

Example 3: Controlling depth

The question may come to mind, what happens when there are more levels of parts in the table than you are interested in for your query? That is, how is a query written to answer the question, "What are the first two levels of parts needed to build the part identified by '01'?" For the sake of clarity in the example, the level is included in the result.

```

WITH RPL ( LEVEL, PART, SUBPART, QUANTITY)
AS ( SELECT 1, ROOT.PART, ROOT.SUBPART, ROOT.QUANTITY
      FROM PARTLIST ROOT
      WHERE ROOT.PART = '01'
      UNION ALL
      SELECT PARENT.LEVEL+1, CHILD.PART, CHILD.SUBPART, CHILD.QUANTITY
      FROM RPL PARENT, PARTLIST CHILD
      WHERE PARENT.SUBPART = CHILD.PART
      AND PARENT.LEVEL < 2
      )
SELECT PART, LEVEL, SUBPART, QUANTITY
FROM RPL

```

This query is similar to example 1. The column LEVEL was introduced to count the levels from the original part. In the initialization fullselect, the value for the LEVEL column is initialized to 1. In the subsequent fullselect, the level from the parent is incremented by 1. Then to control the number of levels in the result, the second fullselect includes the condition that the parent level must be less than 2. This ensures that the second fullselect only processes children to the second level.

The result of the query is:

PART	LEVEL	SUBPART	QUANTITY
01	1	02	2
01	1	03	3
01	1	04	4
01	1	06	3
02	2	05	7
02	2	06	6
03	2	07	6
04	2	08	10
04	2	09	11
06	2	12	10
06	2	13	10

update-clause

The UPDATE clause identifies the columns that can appear as targets in an assignment clause in a subsequent positioned UPDATE statement. Each *column-name* must be unqualified and must identify a column of the table or view identified in the first FROM clause of the fullselect. The clause must not be specified if the result table of the fullselect is read-only.

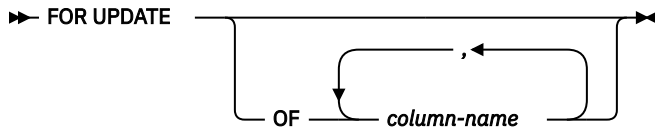

If an UPDATE clause is specified with a *column-name* list, and extended indicators are not enabled, then *column-name* must be an updatable column.

If the UPDATE clause is specified without *column-name* list, then the implicit *column-name* list is determined as follows:

- If extended indicators are enabled, all the columns of the table or view identified in the first FROM clause of the fullselect.
- Otherwise, all the updatable columns of the table or view identified in the first FROM clause of the fullselect.

If the UPDATE clause is not specified in a *select-statement* and its result table is not *read-only*, then an implicit UPDATE clause will result. The implicit *column-name* list is determined as follows:

- If extended indicators are enabled, all the columns of the table or view identified in the first FROM clause of the fullselect are included.
- Otherwise, all the updatable columns of the table or view identified in the first FROM clause of the fullselect are included.

The UPDATE clause must not be specified if the result table of the fullselect is read-only (for more information see [“DECLARE CURSOR”](#) on page 1207) or if the FOR READ ONLY clause is used.

When the UPDATE clause is used, FETCH operations referencing the cursor acquire an exclusive row lock.

read-only-clause

The READ ONLY clause indicates that the result table is read-only; therefore, the cursor cannot be used for positioned UPDATE and DELETE statements.

► FOR READ ONLY ◄

Some result tables are read-only by nature. (For example, a table based on a read-only view). FOR READ ONLY can still be specified for such tables, but the specification has no effect.

For result tables in which updates and deletes are allowed, specifying FOR READ ONLY can possibly improve the performance of FETCH operations by allowing the database manager to do blocking and avoid exclusive locks. For example, in programs that contain dynamic SQL statements without the FOR READ ONLY or ORDER BY clause, the database manager might open cursors as if the UPDATE clause was specified.

A read-only result table must not be referred to in an UPDATE or DELETE statement, whether it is read-only by nature or specified as FOR READ ONLY.

To guarantee that selected data is not locked by any other job, you can specify the optional syntax of USE AND KEEP EXCLUSIVE LOCKS on the *isolation-clause*. This guarantees that the selected data can later be updated or deleted without incurring a row lock conflict.

Syntax Alternatives: FOR FETCH ONLY can be specified in place of FOR READ ONLY.

optimize-clause

The *optimize-clause* tells the database manager to assume that the program does not intend to retrieve more than *integer* rows from the result table. Without this clause, or with the keyword ALL, the database manager assumes that all rows of the result table are to be retrieved. Optimizing for *integer* rows can improve performance. The database manager will optimize the query based on the specified number of rows.

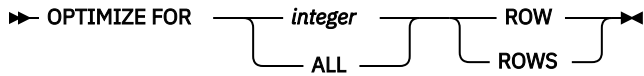

The clause does not change the result table or the order in which the rows are fetched. Any number of rows can be fetched, but performance can possibly degrade after *integer* fetches.

The value of *integer* must be a positive integer (not zero).

Row access controls indirectly affect the *optimize-clause* because row access controls affect the rows that are accessible to the authorization ID of the subselect.

isolation-clause

The *isolation-clause* specifies an isolation level at which the select statement is executed.

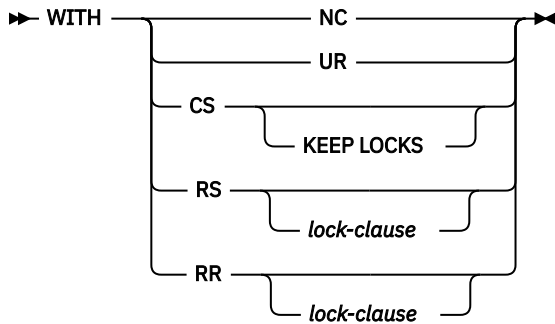

lock-clause

➤ USE AND KEEP EXCLUSIVE LOCKS ➤

RR

Repeatable Read

USE AND KEEP EXCLUSIVE LOCKS

Exclusive row locks are acquired and held until a COMMIT or ROLLBACK statement is executed.

RS

Read Stability

USE AND KEEP EXCLUSIVE LOCKS

Exclusive row locks are acquired and held until a COMMIT or ROLLBACK statement is executed. The USE AND KEEP EXCLUSIVE LOCKS clause is only allowed in the *isolation-clause* in the following SQL statements:

- DECLARE CURSOR
- FOR
- *select-statement*
- SELECT INTO
- PREPARE in the ATTRIBUTES string

It is not allowed on updatable cursors.

CS

Cursor Stability

KEEP LOCKS

The KEEP LOCKS clause specifies that any read locks acquired will be held for a longer duration. Normally, read locks are released when the next row is read. If the isolation clause is associated with a cursor, the locks will be held until the cursor is closed or until a COMMIT or ROLLBACK statement is executed. Otherwise, the locks will be held until the completion of the SQL statement.

UR

Uncommitted Read

NC

No Commit

If *isolation-clause* is not specified, the default isolation is used with the exception of a default isolation level of uncommitted read. See [“Isolation level” on page 23](#) for a description of how the default is determined.

Exclusive locks: The USE AND KEEP EXCLUSIVE LOCKS clause should be used with caution. If it is specified, the exclusive row locks that are acquired on rows will prevent concurrent access to those rows by other users running COMMIT(*CS), COMMIT(*RS), and COMMIT(*RR) till the end of the unit of work. Concurrent access by users running COMMIT(*NC) or COMMIT(*UR) is not prevented.

Keyword Synonyms: The following keywords are synonyms supported for compatibility to prior releases. These keywords are non-standard and should not be used:

- The keyword NONE can be used as a synonym for NC.
- The keyword CHG can be used as a synonym for UR.
- The keyword ALL can be used as a synonym for RS.

concurrent-access-resolution-clause

The *concurrent-access-resolution-clause* specifies the concurrent access resolution to use for the statement.

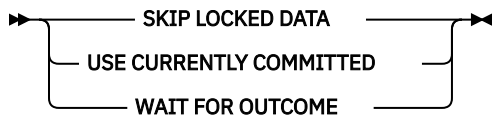

SKIP LOCKED DATA

Specifies that the *select-statement*, searched UPDATE statement (including a searched update operation in a MERGE statement), or searched DELETE statement that is prepared in the PREPARE statement will skip rows when incompatible locks are held on the row by other transactions. These rows can belong to any accessed table that is specified in the statement. SKIP LOCKED DATA can be used only when isolation level NC, UR, CS, or RS is in effect.

SKIP LOCKED DATA is ignored if it is specified when the isolation level that is in effect is RR.

USE CURRENTLY COMMITTED

Specifies that the database manager can use the currently committed version of the data for applicable scans when it is in the process of being updated or deleted. Rows in the process of being inserted can be skipped. This clause applies if possible when the isolation level is CS without the KEEP LOCKS clause and is ignored otherwise. Applicable scans include read-only scans.

WAIT FOR OUTCOME

Specifies to wait for the commit or rollback when encountering data in the process of being updated or deleted. Rows encountered that are in the process of being inserted are not skipped. This clause applies if possible when the isolation level is CS or RS. It is ignored when an isolation level of NC, UR, or RR is in effect.

Examples of a select-statement

You can use select-statement in many different ways.

Example 1

Select all columns and rows from the EMPLOYEE table.

```
SELECT * FROM EMPLOYEE
```

Example 2

Select the project name (PROJNAME), start date (PRSTDATE), and end date (PRENDATE) from the PROJECT table. Order the result table by the end date with the most recent dates appearing first.

```
SELECT PROJNAME, PRSTDATE, PRENDATE  
FROM PROJECT  
ORDER BY PRENDATE DESC
```

Example 3

Select the department number (WORKDEPT) and average departmental salary (SALARY) for all departments in the EMPLOYEE table. Arrange the result table in ascending order by average departmental salary.

```
SELECT WORKDEPT, AVG(SALARY)  
FROM EMPLOYEE  
GROUP BY WORKDEPT  
ORDER BY AVGSAL
```

Example 4

Declare a cursor named UP_CUR, to be used in a C program, that updates the start date (PRSTDATE) and the end date (PRENDATE) columns in the PROJECT table. The program must receive both of these values together with the project number (PROJNO) value for each row. The declaration specifies that the access path for the query be optimized for the retrieval of a maximum of 2 rows. Even so, the program can retrieve more than 2 rows from the result table. However, when more than 2 rows are retrieved, performance could possibly degrade.

```
EXEC SQL DECLARE UP_CUR CURSOR FOR  
SELECT PROJNO, PRSTDATE, PRENDATE  
FROM PROJECT  
FOR UPDATE OF PRSTDATE, PRENDATE  
OPTIMIZE FOR 2 ROWS ;
```

Example 5

Select items from a table with an isolation level of Read Stability (RS).

```
SELECT NAME, SALARY  
FROM PAYROLL  
WHERE DEPT = 704  
WITH RS
```

Example 6

This example names the expression SALARY+BONUS+COMM as TOTAL_PAY:

```

SELECT SALARY+BONUS+COMM AS TOTAL_PAY
FROM EMPLOYEE
ORDER BY TOTAL_PAY

```

Example 7

Determine the employee number and salary of sales representatives along with the average salary and head count of their departments. Also, list the average salary of the department with the highest average salary.

Using a common table expression for this case saves the overhead of creating the DINFO view as a regular view. Because of the context of the rest of the fullselect, only the rows for the department of the sales representatives need to be considered by the view.

```

WITH
  DINFO (DEPTNO, AVGSALARY, EMPCOUNT) AS
    (SELECT OTHERS.WORKDEPT, AVG(OTHERS.SALARY), COUNT(*)
     FROM EMPLOYEE OTHERS
     GROUP BY OTHERS.WORKDEPT),
  DINFOMAX AS
    (SELECT MAX(AVGSALARY) AS AVGMAX
     FROM DINFO)
SELECT THIS_EMP.EMPNO, THIS_EMP.SALARY, DINFO.AVGSALARY, DINFO.EMPCOUNT,
       DINFOMAX.AVGMAX
FROM EMPLOYEE THIS_EMP, DINFO, DINFOMAX
WHERE THIS_EMP.JOB = 'SALESREP'
AND THIS_EMP.WORKDEPT = DINFO.DEPTNO

```

Example 8

Find the average charges for each subscriber (SNO) in the state of California during the last Friday of each month in the first quarter of 2000. Group the result according to SNO. Each MONTHnn table has columns for SNO, CHARGES, and DATE. The CUST table has columns for SNO and STATE.

```

SELECT V.SNO, AVG(V.CHARGES)
FROM CUST, LATERAL (
  SELECT SNO, CHARGES, DATE
  FROM MONTH1
  WHERE DATE BETWEEN '01/01/2000' AND '01/31/2000'
  UNION ALL
  SELECT SNO, CHARGES, DATE
  FROM MONTH2
  WHERE DATE BETWEEN '02/01/2000' AND '02/29/2000'
  UNION ALL
  SELECT SNO, CHARGES, DATE
  FROM MONTH3
  WHERE DATE BETWEEN '03/01/2000' AND '03/31/2000'
) AS V (SNO, CHARGES, DATE)
WHERE CUST.SNO=V.SNO
AND CUST.STATE='CA'
AND DATE IN ('01/28/2000', '02/25/2000', '03/31/2000')
GROUP BY V.SNO

```

Chapter 7. Statements

This section contains syntax diagrams, semantic descriptions, rules, and examples of the use of the SQL statements.

The statements are listed in the following table.

Table 71. SQL Schema Statements

SQL Statement	Description	Page
ALTER FUNCTION (external scalar)	Alters the description of an external scalar function	“ALTER FUNCTION (external scalar)” on page 808
ALTER FUNCTION (external table)	Alters the description of an external table function	“ALTER FUNCTION (external table)” on page 813
ALTER FUNCTION (SQL scalar)	Alters the description of an SQL scalar function	“ALTER FUNCTION (SQL scalar)” on page 818
ALTER FUNCTION (SQL table)	Alters the description of an SQL table function	“ALTER FUNCTION (SQL table)” on page 826
ALTER MASK	Alters the state of a mask	“ALTER MASK” on page 834
ALTER PERMISSION	Alters the state of a permission	“ALTER PERMISSION” on page 836
ALTER PROCEDURE (external)	Alters the description of an external procedure	“ALTER PROCEDURE (external)” on page 838
ALTER PROCEDURE (SQL)	Alters the description of an SQL procedure	“ALTER PROCEDURE (SQL)” on page 843
ALTER SEQUENCE	Alters the description of a sequence	“ALTER SEQUENCE” on page 853
ALTER TABLE	Alters the description of a table	“ALTER TABLE” on page 858
ALTER TRIGGER	Alters the description of a trigger	“ALTER TRIGGER” on page 910
COMMENT	Adds or replaces a comment to the description of an object	“COMMENT” on page 930
CREATE ALIAS	Creates an alias	“CREATE ALIAS” on page 961
CREATE FUNCTION	Creates a user-defined function	“CREATE FUNCTION” on page 965
CREATE FUNCTION (external scalar)	Creates an external scalar function	“CREATE FUNCTION (external scalar)” on page 970
CREATE FUNCTION (external table)	Creates an external table function	“CREATE FUNCTION (external table)” on page 990
CREATE FUNCTION (sourced)	Creates a user-defined function based on another existing scalar or aggregate function	“CREATE FUNCTION (sourced)” on page 1008

Table 71. SQL Schema Statements (continued)

SQL Statement	Description	Page
CREATE FUNCTION (SQL scalar)	Creates an SQL scalar function	“CREATE FUNCTION (SQL scalar)” on page 1018
CREATE FUNCTION (SQL table)	Creates an SQL table function	“CREATE FUNCTION (SQL table)” on page 1032
CREATE INDEX	Creates an index on a table	“CREATE INDEX” on page 1045
CREATE MASK	Creates a column mask for a table	“CREATE MASK” on page 1054
CREATE PERMISSION	Creates a row permission for a table	“CREATE PERMISSION” on page 1060
CREATE PROCEDURE	Creates a procedure.	“CREATE PROCEDURE” on page 1064
CREATE PROCEDURE (external)	Creates an external procedure.	“CREATE PROCEDURE (external)” on page 1065
CREATE PROCEDURE (SQL)	Creates an SQL procedure.	“CREATE PROCEDURE (SQL)” on page 1080
CREATE SCHEMA	Creates a schema and a set of objects in that schema	“CREATE SCHEMA” on page 1093
CREATE SEQUENCE	Creates a sequence	“CREATE SEQUENCE” on page 1098
CREATE TABLE	Creates a table	“CREATE TABLE” on page 1105
CREATE TRIGGER	Creates a trigger	“CREATE TRIGGER” on page 1160
CREATE TYPE	Creates a type	“CREATE TYPE (distinct)” on page 1184
CREATE VARIABLE	Creates a global variable	“CREATE VARIABLE” on page 1192
CREATE VIEW	Creates a view of one or more tables or views	“CREATE VIEW” on page 1198
DROP	Drops an alias, function, index, package, procedure, schema, sequence, table, trigger, type, variable, view, or XSR object.	“DROP” on page 1280
GRANT (function or procedure privileges)	Grants privileges on a function or procedure	“GRANT (function or procedure privileges)” on page 1349
GRANT (variable privileges)	Grants privileges on a global variable	“GRANT (variable privileges)” on page 1377
GRANT (package privileges)	Grants privileges on a package	“GRANT (package privileges)” on page 1357
GRANT (schema privileges)	Grants privileges on a schema	“GRANT (schema privileges)” on page 1360

Table 71. SQL Schema Statements (continued)

SQL Statement	Description	Page
GRANT (sequence privileges)	Grants privileges on a sequence	“GRANT (sequence privileges)” on page 1363
GRANT (table or view privileges)	Grants privileges on a table or view	“GRANT (table or view privileges)” on page 1366
GRANT (type privileges)	Grants privileges on a type	“GRANT (type privileges)” on page 1374
GRANT (XML schema privileges)	Grants privileges on an XML schema	“GRANT (XML schema privileges)” on page 1380
LABEL	Adds or replaces a label to the description of an object	“LABEL” on page 1399
RENAME	Renames a table, view, or index.	“RENAME” on page 1450
REVOKE (function or procedure privileges)	Revokes privileges on a function or procedure	“REVOKE (function or procedure privileges)” on page 1453
REVOKE (variable privileges)	Revokes privileges on a global variable	“REVOKE (variable privileges)” on page 1471
REVOKE (package privileges)	Revokes the privilege to execute statements in a package	“REVOKE (package privileges)” on page 1459
REVOKE (schema privileges)	Revokes privileges on a schema	“REVOKE (schema privileges)” on page 1461
REVOKE (sequence privileges)	Revokes privileges on a sequence	“REVOKE (sequence privileges)” on page 1463
REVOKE (table or view privileges)	Revokes privileges on a table or view	“REVOKE (table or view privileges)” on page 1465
REVOKE (type privileges)	Revokes the privilege to use a type	“REVOKE (type privileges)” on page 1469
REVOKE (XML schema privileges)	Revokes privileges on an XML schema	“REVOKE (XML schema privileges)” on page 1473
TRANSFER OWNERSHIP	Transfers ownership of an object to a different authorization ID	“TRANSFER OWNERSHIP” on page 1546

Table 72. SQL Data Change Statements

SQL Statement	Description	Page
DELETE	Deletes one or more rows from a table	“DELETE” on page 1251
INSERT	Inserts one or more rows into a table	“INSERT” on page 1387
MERGE	Updates a target table using data from a source table	“MERGE” on page 1410
TRUNCATE	Deletes all the rows from a table	“TRUNCATE” on page 1549
UPDATE	Updates the values of one or more columns in one or more rows of a table	“UPDATE” on page 1552

Table 73. SQL Data Statements

SQL Statement	Description	Page
	All SQL data change statements	Table 72 on page 795
ALLOCATE CURSOR	Allocates a cursor for the result set identified by the result set locator variable.	“ALLOCATE CURSOR” on page 805
ASSOCIATE LOCATORS	Gets the result set locator value for each result set returned by a procedure.	“ASSOCIATE LOCATORS” on page 913
CLOSE	Closes a cursor	“CLOSE” on page 928
DECLARE CURSOR	Defines an SQL cursor	“DECLARE CURSOR” on page 1207
FETCH	Positions a cursor on a row of the result table; can also assign values from one or more rows of the result table to variables	“FETCH” on page 1303
FREE LOCATOR	Removes the association between a LOB locator variable and its value	“FREE LOCATOR” on page 1310
HOLD LOCATOR	Allows a LOB locator variable to retain its association with a value beyond a unit of work	“HOLD LOCATOR” on page 1383
LOCK TABLE	Either prevents concurrent processes from changing a table or prevents concurrent processes from using a table	“LOCK TABLE” on page 1408
OPEN	Opens a cursor	“OPEN” on page 1421
REFRESH TABLE	Refreshes the data in a materialized query table	“REFRESH TABLE” on page 1445
SELECT	Executes a query	“SELECT” on page 1481
SELECT INTO	Assigns values to variables	“SELECT INTO” on page 1482
SET variable	Assigns values to a variable	“SET variable” on page 1539
VALUES	Executes a query.	“VALUES” on page 1563
VALUES INTO	Specifies a result table of no more than one row and assigns the values to variables.	“VALUES INTO” on page 1564

Table 74. SQL Transaction Statements

SQL Statement	Description	Page
COMMIT	Ends a unit of work and commits the database changes made by that unit of work	“COMMIT” on page 940
RELEASE SAVEPOINT	Releases a savepoint within a unit of work	“RELEASE SAVEPOINT” on page 1449
ROLLBACK	Ends a unit of work and backs out the database changes made by that unit of work or made since the specified savepoint	“ROLLBACK” on page 1475
SAVEPOINT	Sets a savepoint within a unit of work	“SAVEPOINT” on page 1479

Table 74. SQL Transaction Statements (continued)

SQL Statement	Description	Page
SET TRANSACTION	Changes the isolation level for the current unit of work	“SET TRANSACTION” on page 1536

Table 75. SQL Connection Statements

SQL Statement	Description	Page
CONNECT (type 1)	Connects to an application server and establishes the rules for remote unit of work	“CONNECT (type 1)” on page 952
CONNECT (type 2)	Connects to an application server and establishes the rules for application-directed distributed unit of work	“CONNECT (type 2)” on page 957
DISCONNECT	Immediately ends one or more connections	“DISCONNECT” on page 1278
RELEASE (connection)	Places one or more connections in the release-pending state	“RELEASE (connection)” on page 1447
SET CONNECTION	Establishes the application server of the process by identifying one of its existing connections	“SET CONNECTION” on page 1485

Table 76. SQL Dynamic Statements

SQL Statement	Description	Page
ALLOCATE DESCRIPTOR	Allocates an SQL descriptor	“ALLOCATE DESCRIPTOR” on page 806
Compound (dynamic)	Groups other statements together in an executable routine	“compound (dynamic)” on page 943
DEALLOCATE DESCRIPTOR	Deallocates an SQL descriptor	“DEALLOCATE DESCRIPTOR” on page 1206
DESCRIBE	Describes the result columns of a prepared statement	“DESCRIBE” on page 1258
DESCRIBE CURSOR	Describes the cursor.	“DESCRIBE CURSOR” on page 1263
DESCRIBE INPUT	Describes the input parameter markers of a prepared statement	“DESCRIBE INPUT” on page 1265
DESCRIBE PROCEDURE	Describes the result sets returned by a procedure.	“DESCRIBE PROCEDURE” on page 1268
DESCRIBE TABLE	Describes the columns of a table or view	“DESCRIBE TABLE” on page 1274
EXECUTE	Executes a prepared SQL statement	“EXECUTE” on page 1296
EXECUTE IMMEDIATE	Prepares and executes an SQL statement	“EXECUTE IMMEDIATE” on page 1301
GET DESCRIPTOR	Gets information from an SQL descriptor	“GET DESCRIPTOR” on page 1311
PREPARE	Prepares an SQL statement for execution	“PREPARE” on page 1427

Table 76. SQL Dynamic Statements (continued)

SQL Statement	Description	Page
SET DESCRIPTOR	Sets items in an SQL descriptor	“SET DESCRIPTOR” on page 1498

Table 77. SQL Session Statements

SQL Statement	Description	Page
DECLARE GLOBAL TEMPORARY TABLE	Defines a declared temporary table	“DECLARE GLOBAL TEMPORARY TABLE” on page 1215
SET CURRENT DEBUG MODE	Assigns a value to the CURRENT DEBUG MODE special register	“SET CURRENT DEBUG MODE” on page 1488
SET CURRENT DECFLOAT ROUNDING MODE	Assigns a value to the CURRENT DECFLOAT ROUNDING MODE special register	“SET CURRENT DECFLOAT ROUNDING MODE” on page 1490
SET CURRENT DEGREE	Assigns a value to the CURRENT DEGREE special register	“SET CURRENT DEGREE” on page 1492
SET CURRENT IMPLICIT XMLPARSE OPTION	Assigns a value to the CURRENT IMPLICIT XMLPARSE OPTION special register	“SET CURRENT IMPLICIT XMLPARSE OPTION” on page 1495
SET CURRENT TEMPORAL SYSTEM_TIME	Assigns a value to the CURRENT TEMPORAL SYSTEM_TIME special register	“SET CURRENT TEMPORAL SYSTEM_TIME” on page 1497
SET ENCRYPTION PASSWORD	Assigns a value to the default encryption password and default encryption password hint	“SET ENCRYPTION PASSWORD” on page 1503
SET PATH	Assigns a value to the CURRENT PATH special register	“SET PATH” on page 1524
SET SCHEMA	Assigns a value to the CURRENT SCHEMA special register	“SET SCHEMA” on page 1530
SET SESSION AUTHORIZATION	Changes the user of the job and the USER special register	“SET SESSION AUTHORIZATION” on page 1533

Table 78. SQL Embedded Host Language Statements

SQL Statement	Description	Page
BEGIN DECLARE SECTION	Marks the beginning of an SQL declare section	“BEGIN DECLARE SECTION” on page 918
CALL	Calls a procedure	“CALL” on page 920
DECLARE PROCEDURE	Defines an external procedure	“DECLARE PROCEDURE” on page 1236
DECLARE STATEMENT	Declares the names used to identify prepared SQL statements	“DECLARE STATEMENT” on page 1246
DECLARE VARIABLE	Declares a subtype or normalized other than the default for a host variable	“DECLARE VARIABLE” on page 1248

Table 78. SQL Embedded Host Language Statements (continued)

SQL Statement	Description	Page
END DECLARE SECTION	Marks the end of an SQL declare section	“END DECLARE SECTION” on page 1295
GET DIAGNOSTICS	Obtains information about the previously executed SQL statement	“GET DIAGNOSTICS” on page 1324
INCLUDE	Inserts declarations into a source program	“INCLUDE” on page 1385
SET OPTION	Establishes the options for processing SQL statements	“SET OPTION” on page 1505
SET RESULT SETS	Identifies the result sets in a procedure	“SET RESULT SETS” on page 1527
SIGNAL	Signals an error or warning condition	“SIGNAL” on page 1542
TAG	Identifies the branch location for a WHENEVER statement in ILE RPG.	“TAG” on page 1545
WHENEVER	Defines actions to be taken on the basis of SQL return codes	“WHENEVER” on page 1567

Table 79. SQL Control Statements

SQL Statement	Description	Page
assignment-statement	Assigns a value to an output parameter or to a local variable	“assignment-statement” on page 1580
CALL	Calls a procedure	“CALL statement” on page 1584
CASE	Selects an execution path based on multiple conditions	“CASE statement” on page 1586
compound-statement	Groups other statements together in an SQL routine	“compound-statement” on page 1588
FOR	Executes a statement for each row of a table	“FOR statement” on page 1596
GET DIAGNOSTICS	Obtains information about the previously executed SQL statement	“GET DIAGNOSTICS statement” on page 1598
GOTO	Branches to a user-defined label within an SQL routine or trigger	“GOTO statement” on page 1606
IF	Provides conditional execution based on the truth value of a condition	“IF statement” on page 1608
ITERATE	Causes the flow of control to return to the beginning of a labeled loop	“ITERATE statement” on page 1613
LEAVE	Continues execution by leaving a block or loop	“LEAVE statement” on page 1615
LOOP	Repeats the execution of a statement	“LOOP statement” on page 1616
REPEAT	Repeats the execution of a statement	“REPEAT statement” on page 1620

Table 79. SQL Control Statements (continued)

SQL Statement	Description	Page
RESIGNAL	Resignals an error or warning condition	“RESIGNAL statement” on page 1622
RETURN	Returns from a routine	“RETURN statement” on page 1626
SIGNAL	Signals an error or warning condition	“SIGNAL statement” on page 1629
WHILE	Repeats the execution of a statement while a specified condition is true	“WHILE statement” on page 1633

How SQL statements are invoked

The SQL statements described in this chapter are classified as *executable* or *nonexecutable*. The *Invocation* section in the description of each statement indicates whether the statement is executable.

An *executable statement* can be invoked in any of the following ways:

- Embedded in an application program
- Dynamically prepared and executed
- Issued interactively

Note: Statements embedded in REXX or processed using RUNSQLSTM are prepared and executed dynamically.

Depending on the statement, some or all of these methods can be used. The *Invocation* section in the description of each statement tells you which methods can be used.

A *nonexecutable statement* can only be embedded in an application program.

Embedding a statement in an application program

SQL statements can be included in a source program that will be submitted to the precompiler by using the CRTSQLCBL, CRTSQLCBLI, CRTSQLCI, CRTSQLCPPI, CRTSQLPLI, CRTSQLRPG, or CRTSQLRPGI commands. Such statements are said to be *embedded* in the program.

An embedded statement can be placed anywhere in the program where a host language statement is allowed. Each embedded statement must be preceded by a keyword (or keywords) to indicate that the statement is an SQL statement:

- In C, COBOL, PL/I, and RPG, each embedded statement must be preceded by the keywords EXEC and SQL.
- In Java, each embedded statement must be preceded by the keywords #sql.
- In REXX, each embedded statement must be preceded by the keyword EXECSQL.

Executable statements

An executable statement embedded in an application program is executed every time a statement of the host language would be executed if specified in the same place. This means that a statement within a loop is executed every time the loop is executed, and a statement within a conditional construct is executed only when the condition is satisfied.

An embedded statement can contain references to variables. A variable referenced in this way can be used in two ways:

- As input (the current value of the variable is used in the execution of the statement)
- As output (the variable is assigned a new value as a result of executing the statement)

In particular, all references to variables in expressions and predicates are effectively replaced by current values of the variables; that is, the variables are used as input. The treatment of other references is described individually for each statement.

Follow all executable statements with a test of the SQL return state or the SQL return code. Alternatively, the `WHENEVER` statement (which is itself nonexecutable) can be used to change the flow of control immediately after the execution of an embedded statement.

Objects referenced in SQL statements need not exist when the statements are prepared.

Nonexecutable statements

An embedded nonexecutable statement is processed only by the precompiler. The precompiler reports any errors encountered in the statement. The statement is *never* executed, and acts as a no-operation if placed among executable statements of the application program. Therefore, do not follow such statements by a test of an SQL return code.

Dynamic preparation and execution

An application program can dynamically build an SQL statement in the form of a character string placed in a variable. In general, the statement is built from some data available to the program (for example, input from a workstation).

The statement can be prepared for execution using the (embedded) statement `PREPARE` and executed by the (embedded) statement `EXECUTE`. Alternatively, the (embedded) statement `EXECUTE IMMEDIATE` can be used to prepare and execute a statement in one step. In Java, the statement can be prepared for execution by means of the `Statement`, `PreparedStatement`, and `CallableStatement` classes, and executed by means of their respective `execute()` methods.

A statement that is dynamically prepared must not contain references to host variables. Instead, the statement can contain parameter markers. See [“PREPARE” on page 1427](#) for rules concerning the parameter markers. When the prepared statement is executed, the parameter markers are effectively replaced by the current values of the variables specified in the `EXECUTE` statement. See [“EXECUTE” on page 1296](#) for rules concerning this replacement. After a statement is prepared, it can be executed several times with different values of variables. Parameter markers are not allowed in `EXECUTE IMMEDIATE`.

In C, COBOL, PL/I, REXX, and RPG, the successful or unsuccessful execution of the statement is indicated by the values returned in the stand-alone `SQLCODE` or `SQLSTATE` after the `EXECUTE` (or `EXECUTE IMMEDIATE`) statement. The SQL return code should be checked as described above for embedded statements. See the topic [“SQL diagnostic information” on page 802](#) for more information. In Java, the successful or unsuccessful execution of the statement is handled by Java Exceptions.

Static invocation of a select-statement

A *select-statement* can be included as a part of the (nonexecutable) statement `DECLARE CURSOR`.

Such a statement is executed every time the cursor is opened by means of the (embedded) statement `OPEN`. After the cursor is open, the result table can be retrieved one row at a time by successive executions of the `FETCH` statement or multiple rows at a time by using the multiple-row `FETCH` statement.

Used in this way, the *select-statement* can contain references to variables. These references are effectively replaced by the values that the variables have at the moment of executing `OPEN`.

Dynamic invocation of a select-statement

An application program can dynamically build a *select-statement* in the form of a character string placed in a variable.

In general, the statement is built from some data available to the program (for example, a query obtained from a workstation). The statement is then executed every time the cursor is opened by means of the

(embedded) statement OPEN. After the cursor is open, the result table can be retrieved one row at a time by successive executions of the FETCH statement or multiple rows at a time by using the multiple-row FETCH statement.

Used in this way, the *select-statement* must not contain references to variables. It can instead contain parameter markers. See [“PREPARE” on page 1427](#) for rules concerning the parameter markers. The parameter markers are effectively replaced by the values of the variables specified in the OPEN statement. See [“OPEN” on page 1421](#) for rules concerning this replacement.

Interactive invocation

A capability for entering SQL statements from a workstation is part of the architecture of the database manager. A statement entered in this way is said to be issued interactively.

A statement issued interactively must be an executable statement that does not contain parameter markers or references to variables, because these make sense only in the context of an application program.

The Db2 for i database provides the Start Structured Query Language (STRSQL) command, the Start Query Manager (STRQM) command, and the Run SQL Script support of System i Navigator for this facility. Other products are also available.

SQL diagnostic information

The database manager uses a diagnostics area to store status information and diagnostic information about the execution of an executable SQL statement. When an SQL statement other than GET DIAGNOSTICS or *compound-statement* is processed, the current diagnostics area is cleared, before processing the SQL statement. As each SQL statement is processed, information about the execution of that SQL statement is recorded in the current diagnostics area as one or more completion conditions or exception conditions.

A completion condition indicates the SQL statement completed successfully, completed with a warning condition, or completed with a not found condition. An exception condition indicates that the statement was not successful. The GET DIAGNOSTICS statement can be used in most languages to return conditions and other information about the previously executed SQL statement from the diagnostics area. For more information, see [“GET DIAGNOSTICS” on page 1324](#). Additionally, the condition information is provided through language specific mechanisms:

- For SQL procedures, SQL functions, and SQL triggers, see [“SQL-procedure-statement” on page 1576](#).
- For host languages, see [“Detecting and processing error and warning conditions in host language applications” on page 802](#).

Detecting and processing error and warning conditions in host language applications

Each host language provides a mechanism for handling diagnostic information:

- In C, COBOL, and PL/I, an application program containing executable SQL statements must provide at least one of the following:
 - A structure named SQLCA.
 - A stand-alone CHAR(5) (CHAR(6) in C) variable named SQLSTATE.
 - A stand-alone integer variable named SQLCODE.

A stand-alone SQLSTATE or SQLCODE must not be declared in a host structure. Both a stand-alone SQLSTATE and SQLCODE may be provided.

An SQLCA can be obtained by using the INCLUDE SQLCA statement. If an SQLCA is provided, neither a stand-alone SQLSTATE or SQLCODE can be provided. The SQLCA includes a character-string variable named SQLSTATE and an integer variable named SQLCODE.

A stand-alone SQLSTATE should be used to conform with the SQL 2003 Core standard.

- In Java, for error conditions, the `getSQLState` method can be used to get the SQLSTATE and the `getErrorCode` method can be used to get the SQLCODE.
- In REXX and RPG, an SQLCA is provided automatically.

SQLSTATE

The database manager sets SQLSTATE after each SQL statement (other than GET DIAGNOSTICS or a compound statement) is executed. Thus, application programs can check the execution of SQL statements by testing SQLSTATE instead of SQLCODE.

SQLSTATE provides application programs with common codes for common error conditions. Furthermore, SQLSTATE is designed so that application programs can test for specific errors or classes of errors. The scheme is the same for all database managers and is based on the ISO/ANSI SQL 2003 Core standard. A complete list of SQLSTATE classes and SQLSTATEs associated with each SQLCODE is supplied in the [SQL Messages and Codes](#) topic collection.

SQLCODE

The database manager sets SQLCODE after each SQL statement (other than GET DIAGNOSTICS or a compound statement) is executed. SQLCODE is set as follows:

- If SQLCODE = 0 and SQLWARN0 is blank, execution was successful.
- If SQLCODE = 100, no data was found. For example, a FETCH statement returned no data, because the cursor was positioned after the last row of the result table.
- If SQLCODE > 0 and not = 100, execution was successful with a warning.
- If SQLCODE = 0 and SQLWARN0 = 'W', execution was successful with a warning.
- If SQLCODE < 0, execution was not successful.

A complete listing of Db2 for i SQLCODEs and their corresponding SQLSTATEs is provided in the [SQL Messages and Codes](#) topic collection.

SQL comments

In most host languages, static SQL statements can include host language or SQL comments. In Java and REXX, static SQL statements cannot include host language or SQL comments.

Dynamic SQL statements can include SQL comments.

There are two types of SQL comments:

simple comments

Simple comments are introduced by two consecutive hyphens.

bracketed comments

Bracketed comments are introduced by `/*` and end with `*/`.

These rules apply to the use of simple comments:

- The two hyphens must be on the same line and must not be separated by a space.
- Simple comments can be started wherever a space is valid (except within a delimiter token or between 'EXEC' and 'SQL').
- Simple comments cannot be continued to the next line.
- In COBOL, the hyphens must be preceded by a space.

These rules apply to the use of bracketed comments:

- The `/*` must be on the same line and not separated by a space.
- The `*/` must be on the same line and not separated by a space.

- Bracketed comments can be started wherever a space is valid (except within a delimiter token or between 'EXEC' and 'SQL').
- Bracketed comments can be continued to the next line.
- Bracketed comments can be nested within other bracketed comments.

A comment embedded in an SQL statement that precedes a name (such as a table name) may cause object names in the text saved for a view, trigger, variable, or MQT to not be maintained correctly. Similarly, names in rows of a dependency view (such as SYSTRIGDEP) may not be correctly qualified.

Example 1

This example shows how to include simple comments in a statement:

```
CREATE VIEW PRJ_MAXPER      -- PROJECTS WITH MOST SUPPORT PERSONNEL
AS SELECT PROJNO, PROJNAME -- NUMBER AND NAME OF PROJECT
FROM PROJECT
WHERE DEPTNO = 'E21'      -- SYSTEMS SUPPORT DEPT CODE
AND PRSTAFF > 1
```

Example 2

This example shows how to include bracketed comments in a statement:

```
CREATE VIEW PRJ_MAXPER      /* PROJECTS WITH MOST SUPPORT
                             PERSONNEL */
AS SELECT PROJNO, PROJNAME /* NUMBER AND NAME OF PROJECT */
FROM PROJECT
WHERE DEPTNO = 'E21'      /* SYSTEMS SUPPORT DEPT CODE */
AND PRSTAFF > 1
```

ALLOCATE CURSOR

The ALLOCATE CURSOR statement defines a cursor and associates it with a result set locator variable.

Invocation

This statement can be embedded in an application program. It is an executable statement that can be dynamically prepared. It cannot be issued interactively. It must not be specified in REXX.

Authorization

None required.

Syntax

```
➤ ALLOCATE — cursor-name — CURSOR FOR RESULT SET — rs-locator-variable ➤
```

Description

cursor-name

Names the cursor. The name must not identify a cursor that has already been declared in the source program.

CURSOR FOR RESULT SET *rs-locator-variable*

Specifies a result set locator variable that has been declared in the application program according to the rules for declaring result set locator variables.

The result set locator variable must contain a valid result set locator value as returned by the ASSOCIATE LOCATORS or DESCRIBE PROCEDURE SQL statement. The value of the result set locator variable is used at the time the cursor is allocated. Subsequent changes to the value of the result set locator have no effect on the allocated cursor. The result set locator value must not be the same as a value used for another cursor allocated in the source program.

Rules

- The following rules apply when you use an allocated cursor:
 - You cannot open an allocated cursor with the OPEN statement.
 - You can close an allocated cursor with the CLOSE statement. Closing an allocated cursor closes the associated cursor defined in the stored procedure.
 - You can allocate only one cursor to each result set.
- Allocated cursors follow the same rules as declared cursors in a program with the CLOSQLCSR option. The CLOSQLCSR option can be specified on the CRTSQLxxx command or using the SET OPTION statement.
- A commit operation closes allocated cursors that were declared without the WITH HOLD clause by the procedure including any that are running with a commit level of *NONE.
- Closing an allocated cursor closes the associated cursor in the procedure.

Example

This SQL procedure example defines and associates cursor C1 with the result set locator variable LOC1 and the related result set returned by the SQL procedure:

```
ALLOCATE C1 CURSOR FOR RESULT SET LOC1;
```

ALLOCATE DESCRIPTOR

The ALLOCATE DESCRIPTOR statement allocates an SQL descriptor.

Invocation

This statement can only be embedded in an application program, SQL function, SQL procedure, or trigger. It cannot be issued interactively. It is an executable statement that cannot be dynamically prepared. It must not be specified in REXX.

Authorization

None required.

Syntax

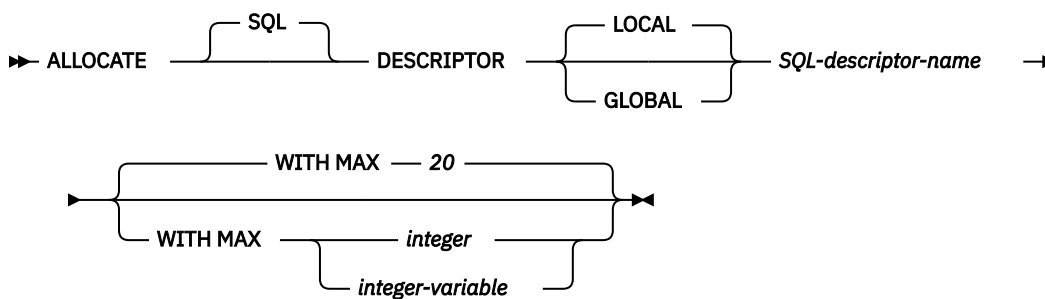

Description

LOCAL

Defines the scope of the name of the descriptor to be local to the program invocation. The descriptor will not be known outside this scope. For example, a program called from another separately compiled program cannot use a descriptor that was allocated by the calling program. The scope of the descriptor is also limited to the thread in which the program that contains the descriptor is running. For example, if the same program is running in two separate threads in the same job, the second thread cannot use a descriptor that was allocated by the first thread.

GLOBAL

Defines the scope of the name of the descriptor to be global to the SQL session. The descriptor will be known to any program that executes using the same database connection.

SQL-descriptor-name

Names the descriptor to allocate. The name must not be the same as a descriptor that already exists with the specified scope.

WITH MAX

The descriptor is allocated to support the specified maximum number of items. If this clause is not specified, the descriptor is allocated with a maximum of 20 items.

integer

Specifies the number of items to allocate. The value of *integer* must be greater than zero and not greater than 8000.

integer-variable

Specifies an integer variable (or decimal or numeric variable with zero scale) that contains the number of items to allocate. It cannot be a global variable. The value of *integer-variable* must be greater than zero and not greater than 8000.

Notes

Descriptor persistence: Local descriptors are implicitly deallocated based on the CLOSQLCSR option:

- For ILE programs, if CLOSQLCSR(*ENDACTGRP) is specified (the default), local descriptors are implicitly deallocated when the activation group ends. If CLOSQLCSR(*ENDMOD) is specified, local descriptors are implicitly deallocated on exit from the module.
- For OPM programs, if CLOSQLCSR(*ENDPGM) is specified (the default), local descriptors are implicitly deallocated when the program ends. If CLOSQLCSR(*ENDSQL) is specified, local descriptors are implicitly deallocated when the first SQL program on the call stack ends. If CLOSQLCSR(*ENDJOB) is specified, local descriptors are implicitly deallocated when the job ends.

Global descriptors are implicitly deallocated when the activation group ends.

Both local and global descriptors can be explicitly deallocated using the DEALLOCATE DESCRIPTOR statement.

Examples

Allocate a descriptor called 'NEWDA' large enough to hold 20 items.

```
EXEC SQL ALLOCATE DESCRIPTOR 'NEWDA'  
WITH MAX 20
```

ALTER FUNCTION (external scalar)

The ALTER FUNCTION (external scalar) statement alters an external scalar function at the current server.

Invocation

This statement can be embedded in an application program or issued interactively. It is an executable statement that can be dynamically prepared.

Authorization

The privileges held by the authorization ID of the statement must include at least one of the following:

- For the function identified in the statement:
 - The ALTER privilege for the function, and
 - The USAGE privilege on the schema containing the function.
- Database administrator authority

If a different external program is specified, the privileges held by the authorization ID of the statement must also include the same privileges required to create a new external scalar function. For more information, see [“CREATE FUNCTION \(external scalar\)”](#) on page 970.

If the SECURED option is specified or if the function is currently secure:

- The authorization ID of the statement must have security administrator authority. See [“Administrative authority”](#) on page 15.

For information about the system authorities corresponding to SQL privileges, see [Corresponding System Authorities When Checking Privileges to a Function or Procedure](#), [Corresponding System Authorities When Checking Privileges to a Table or View](#), and [Corresponding System Authorities When Checking Privileges to a Distinct Type](#).

Syntax

►► ALTER →

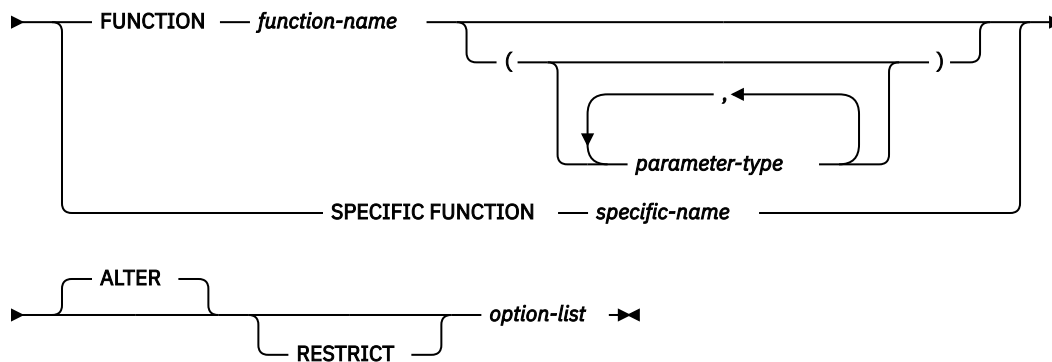

parameter-type

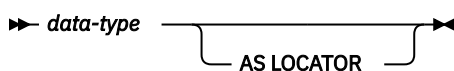

data-type

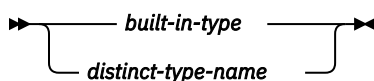

option-list

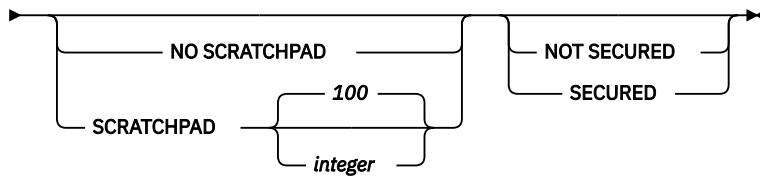
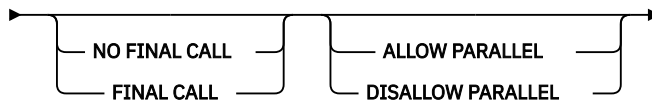
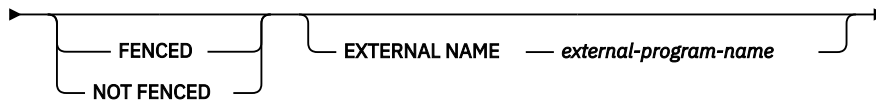
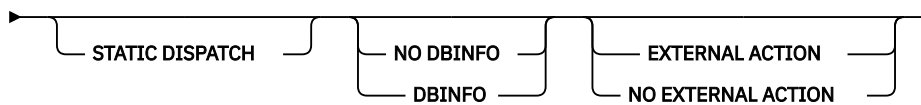
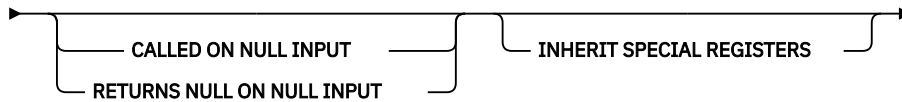
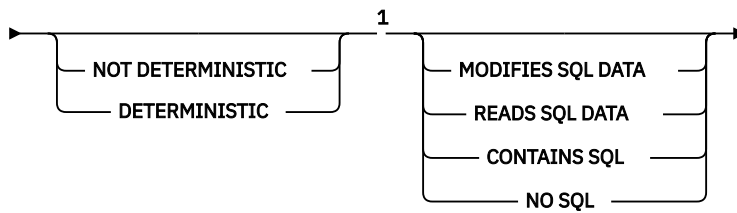
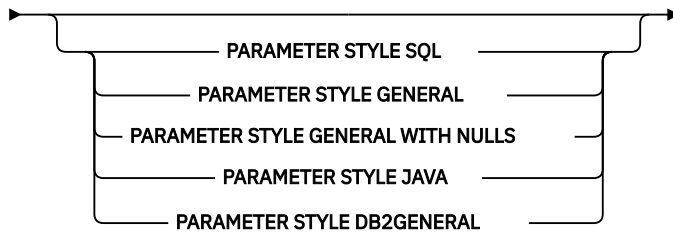
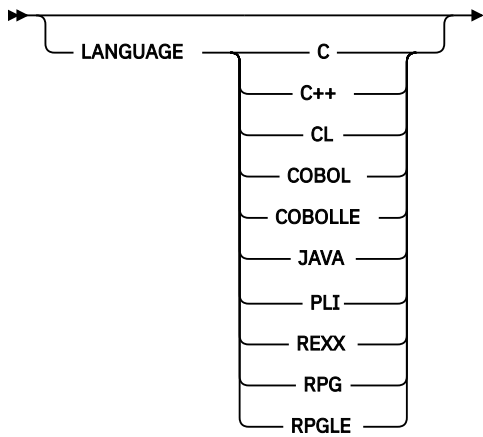

Notes:

¹ The clauses in the *option-list* can be specified in any order.

built-in-type

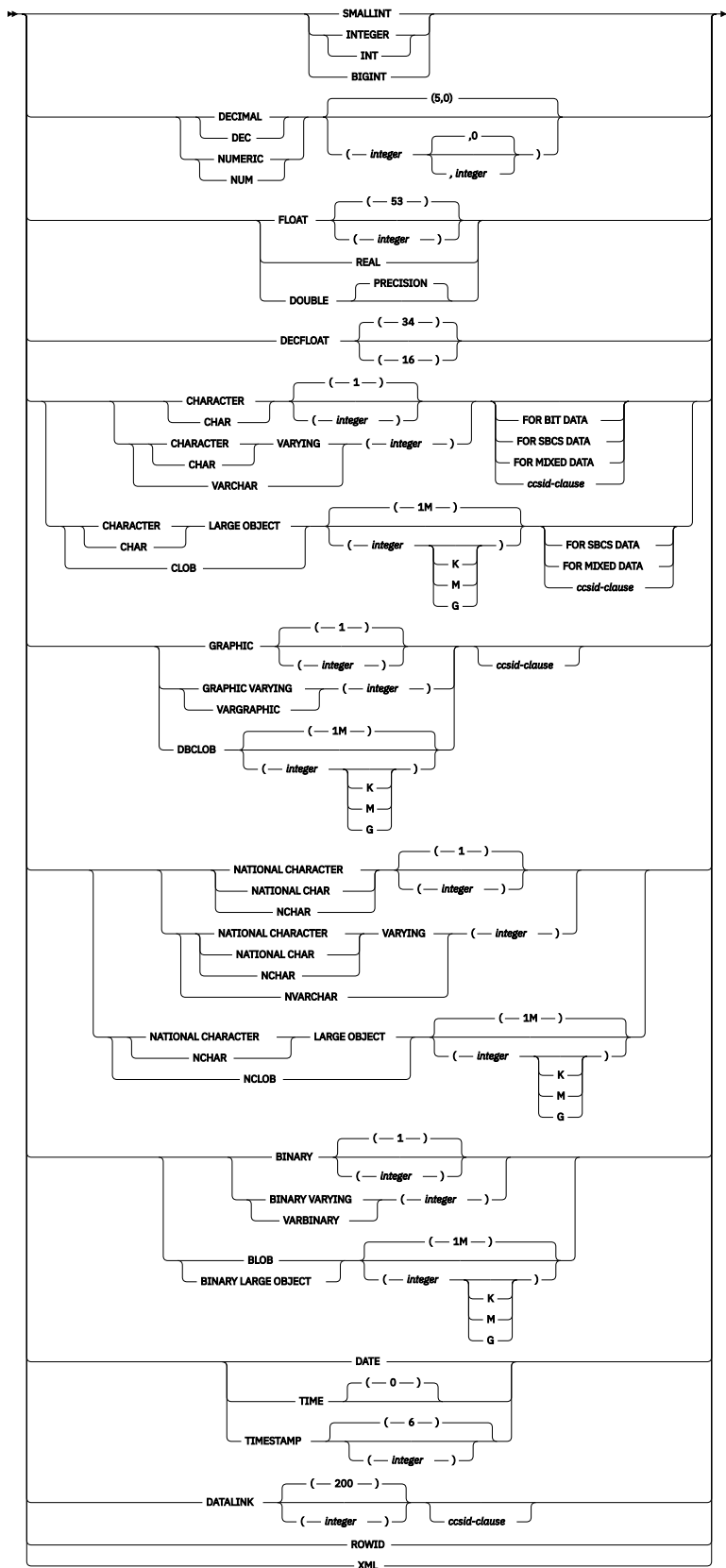

ccsid-clause

➤ CCSID — *integer* ➤

Description

FUNCTION or SPECIFIC FUNCTION

Identifies the function to alter. *function-name* must identify an external scalar function that exists at the current server. It cannot identify a built-in function, a sourced function, or an SQL function. An external table function cannot be altered to be an external scalar function.

The specified function is altered. The owner of the function is preserved. If the external program or service program exists at the time the function is altered, all privileges on the function are preserved.

FUNCTION *function-name*

Identifies the function by its name. The *function-name* must identify exactly one function. The function may have any number of parameters defined for it. If there is more than one function of the specified name in the specified or implicit schema, an error is returned.

FUNCTION *function-name (parameter-type,...)*

Identifies the function by its function signature, which uniquely identifies the function. The *function-name (parameter-type,...)* must identify a function with the specified function signature. The specified parameters must match the data types in the corresponding position that were specified when the function was created. The number of data types, and the logical concatenation of the data types is used to identify the specific function instance which is being altered. Synonyms for data types are considered a match. Parameters that have defaults must be included in this signature.

If *function-name()* is specified, the function identified must have zero parameters.

function-name

Identifies the name of the function.

(parameter-type,...)

Identifies the parameters of the function.

If an unqualified distinct type name is specified, the database manager searches the SQL path to resolve the schema name for the distinct type.

For data types that have a length, precision, or scale attribute, use one of the following:

- Empty parenthesis indicates that the database manager ignores the attribute when determining whether the data types match. For example, DEC() will be considered a match for a parameter of a function defined with a data type of DEC(7,2). However, FLOAT cannot be specified with empty parenthesis because its precision value indicates a specific data type (REAL or DOUBLE).
- If a specific value for a length, precision, or scale attribute is specified, the value must exactly match the value that was specified (implicitly or explicitly) in the CREATE FUNCTION statement. If the data type is FLOAT, the precision does not have to exactly match the value that was specified because matching is based on the data type (REAL or DOUBLE).
- If length, precision, or scale is not explicitly specified, and empty parentheses are not specified, the default attributes of the data type are implied. The implicit length must exactly match the value that was specified (implicitly or explicitly) in the CREATE FUNCTION statement.

Specifying the FOR DATA clause or CCSID clause is optional. Omission of either clause indicates that the database manager ignores the attribute when determining whether the data types match. If either clause is specified, it must match the value that was implicitly or explicitly specified in the CREATE FUNCTION statement.

AS LOCATOR

Specifies that the function is defined to receive a locator for this parameter. If AS LOCATOR is specified, the data type must be LOB or XML or a distinct type based on a LOB or XML.

SPECIFIC FUNCTION *specific-name*

Identifies the function by its specific name. The *specific-name* must identify a specific function that exists at the current server.

ALTER option-list

Indicates that one or more of the options of the function are to be altered. If an option is not specified, the value from the existing function definition is used. See [“CREATE FUNCTION \(external scalar\)”](#) on page 970 for a description of each option.

RESTRICT

Indicates that the function will not be altered if it is referenced by any view, function, procedure, or materialized query table.

Notes

General considerations for defining or replacing functions: See CREATE FUNCTION (external scalar) for general information about defining a function. ALTER FUNCTION (external scalar) allows individual attributes to be altered while preserving the privileges on the function.

Altering a function from NOT SECURED to SECURED: The function is considered secure after the ALTER FUNCTION statement is executed. Db2 treats the SECURED attribute as an assertion that declares that the user has established an audit procedure for all changes to the user-defined function. Db2 assumes that all subsequent ALTER FUNCTION statements are being reviewed through this audit process.

Invoking other user-defined functions in a secure function: When a secure user-defined function is referenced in an SQL data change statement that references a table that is using row access control or column access control, and if the secure user-defined function invokes other user-defined functions, the nested user-defined functions are not validated as secure. If those nested functions can access sensitive data, a user authorized to the Database Security Administrator function of IBM i needs to ensure that those functions are allowed to access that data and should ensure that a change control audit procedure has been established for all changes to those functions.

Syntax alternatives: The following keywords are synonyms supported for compatibility to prior releases. These keywords are non-standard and should not be used:

- The keywords VARIANT and NOT VARIANT can be used as synonyms for NOT DETERMINISTIC and DETERMINISTIC.
- The keywords NULL CALL and NOT NULL CALL can be used as synonyms for CALLED ON NULL INPUT and RETURNS NULL ON NULL INPUT.
- The keywords SIMPLE CALL can be used as a synonym for GENERAL.
- The keyword DB2GENRL may be used as a synonym for DB2GENERAL.
- The value DB2SQL may be used as a synonym for SQL.
- The keywords PARAMETER STYLE in the PARAMETER STYLE clause are optional.
- The keywords IS DETERMINISTIC may be used as a synonym for DETERMINISTIC.

Example

Modify the definition for function MYFUNC to change the name of the external program that will be invoked when the function is invoked. The name of the external program is PROG10B.

```
ALTER FUNCTION MYFUNC
EXTERNAL NAME PROG10B
```

ALTER FUNCTION (external table)

The ALTER FUNCTION (external table) statement alters an external table function at the current server.

Invocation

This statement can be embedded in an application program or issued interactively. It is an executable statement that can be dynamically prepared.

Authorization

The privileges held by the authorization ID of the statement must include at least one of the following:

- For the function identified in the statement:
 - The ALTER privilege for the function, and
 - The USAGE privilege on the schema containing the function.
- Database administrator authority

If a different external program is specified, the privileges held by the authorization ID of the statement must also include the same privileges required to create a new external table function. For more information, see [“CREATE FUNCTION \(external table\)”](#) on page 990.

If the SECURED option is specified or if the function is currently secure:

- The authorization ID of the statement must have security administrator authority. See [“Administrative authority”](#) on page 15.

For information about the system authorities corresponding to SQL privileges, see [Corresponding System Authorities When Checking Privileges to a Function or Procedure](#), [Corresponding System Authorities When Checking Privileges to a Table or View](#), and [Corresponding System Authorities When Checking Privileges to a Distinct Type](#).

Syntax

➤ ALTER ➔

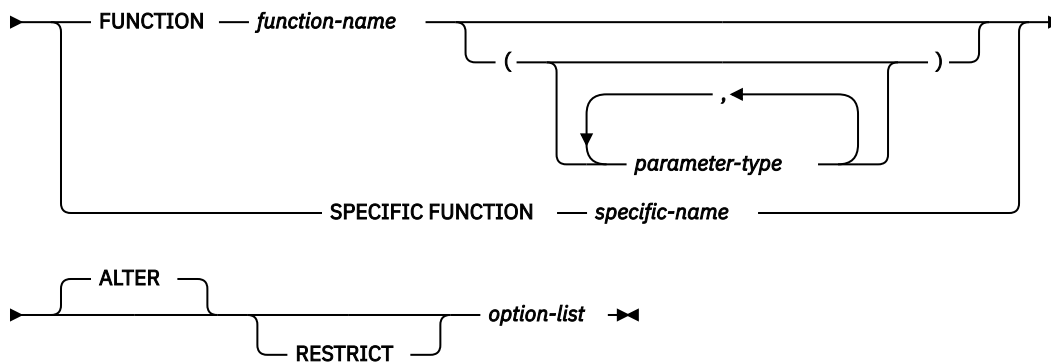

parameter-type

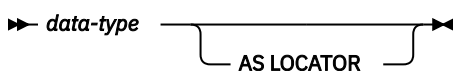

data-type

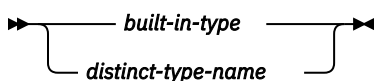

option-list

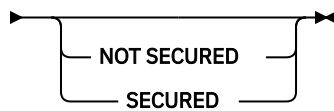
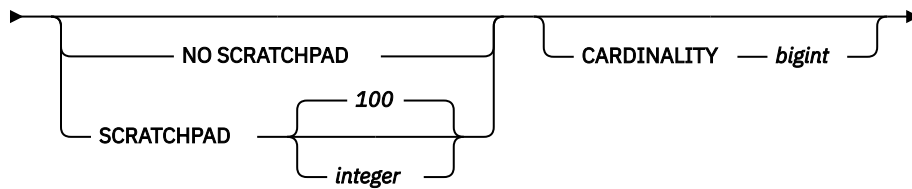
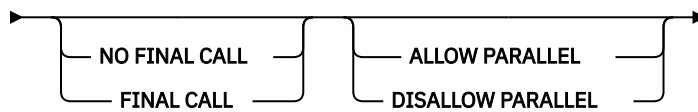
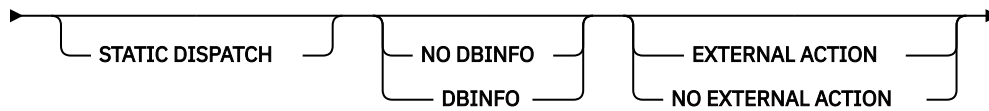
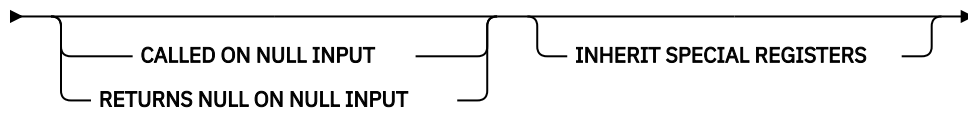
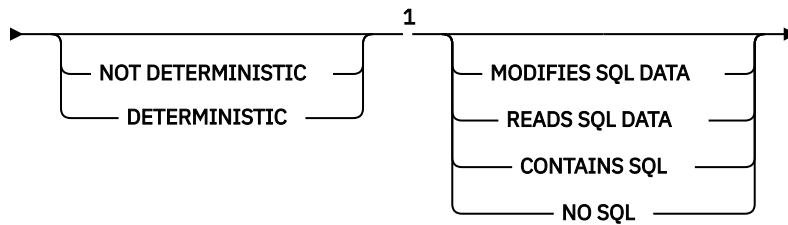
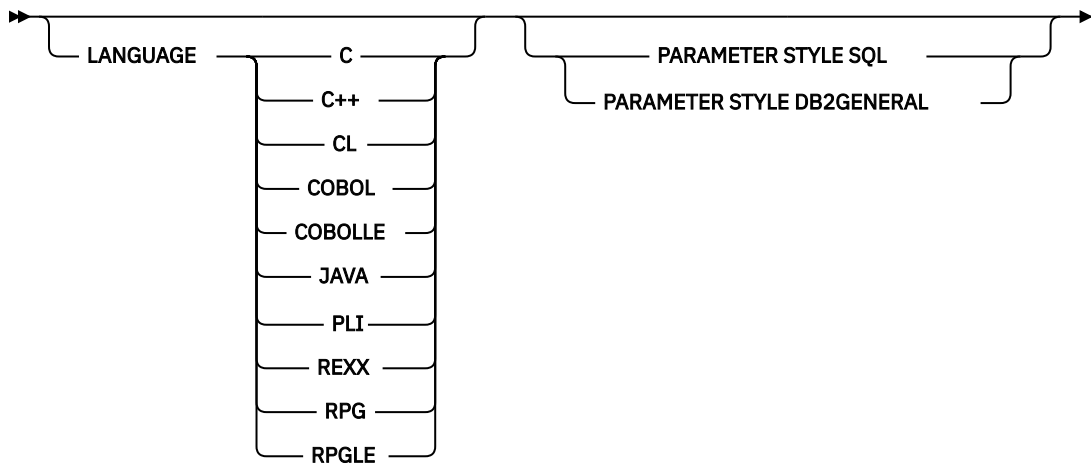

Notes:

¹ The clauses in the *option-list* can be specified in any order.

built-in-type

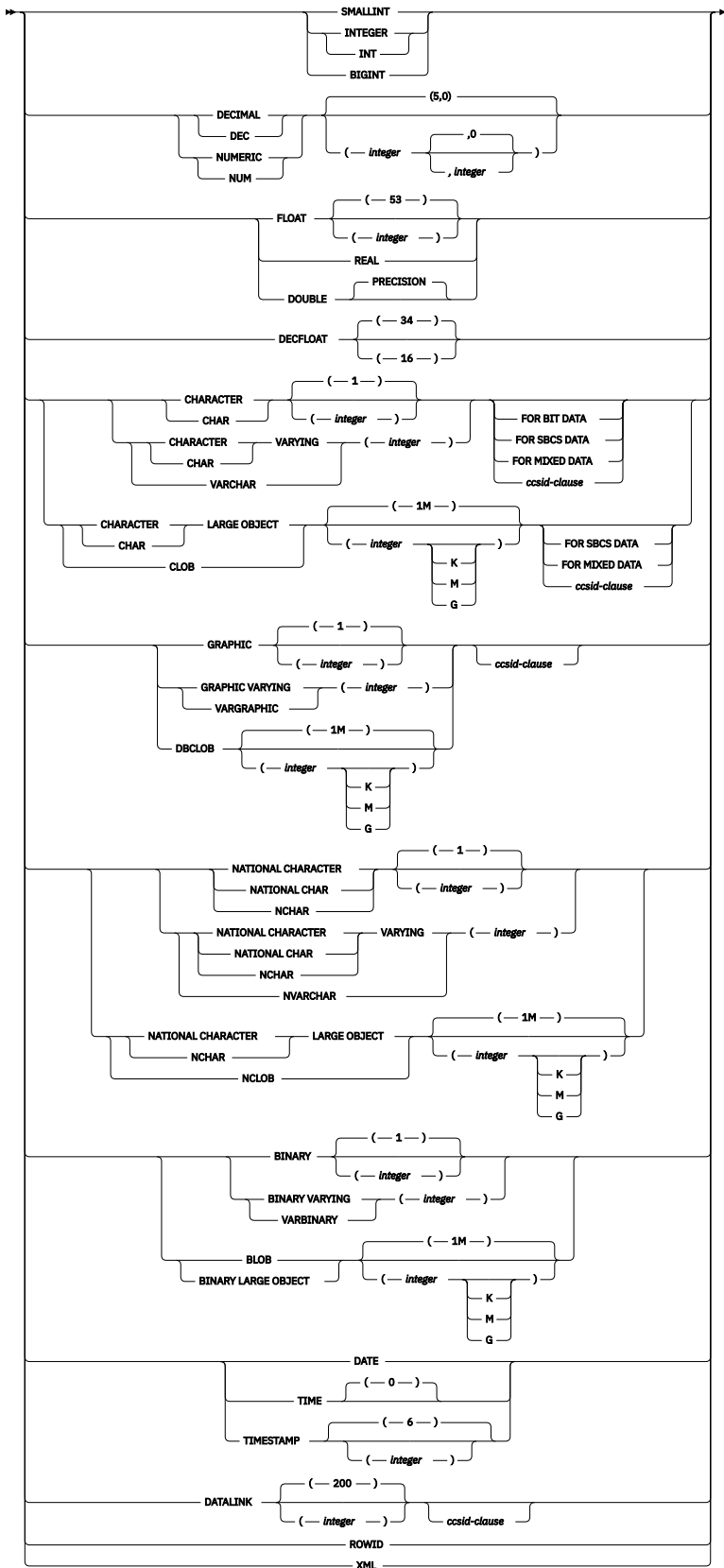

ccsid-clause

➔ CCSID — *integer* ➔

Description

FUNCTION or SPECIFIC FUNCTION

Identifies the function to alter. *function-name* must identify an external table function that exists at the current server. It cannot identify a built-in function, a sourced function, or an SQL function. An external scalar function cannot be altered to be an external table function.

The specified function is altered. The owner of the function is preserved. If the external program or service program exists at the time the function is altered, all privileges on the function are preserved.

FUNCTION *function-name*

Identifies the function by its name. The *function-name* must identify exactly one function. The function may have any number of parameters defined for it. If there is more than one function of the specified name in the specified or implicit schema, an error is returned.

FUNCTION *function-name (parameter-type,...)*

Identifies the function by its function signature, which uniquely identifies the function. The *function-name (parameter-type,...)* must identify a function with the specified function signature. The specified parameters must match the data types in the corresponding position that were specified when the function was created. The number of data types, and the logical concatenation of the data types is used to identify the specific function instance which is being altered. Synonyms for data types are considered a match. Parameters that have defaults must be included in this signature.

If *function-name()* is specified, the function identified must have zero parameters.

function-name

Identifies the name of the function.

(parameter-type,...)

Identifies the parameters of the function.

If an unqualified distinct type name is specified, the database manager searches the SQL path to resolve the schema name for the distinct type.

For data types that have a length, precision, or scale attribute, use one of the following:

- Empty parenthesis indicates that the database manager ignores the attribute when determining whether the data types match. For example, DEC() will be considered a match for a parameter of a function defined with a data type of DEC(7,2). However, FLOAT cannot be specified with empty parenthesis because its precision value indicates a specific data type (REAL or DOUBLE).
- If a specific value for a length, precision, or scale attribute is specified, the value must exactly match the value that was specified (implicitly or explicitly) in the CREATE FUNCTION statement. If the data type is FLOAT, the precision does not have to exactly match the value that was specified because matching is based on the data type (REAL or DOUBLE).
- If length, precision, or scale is not explicitly specified, and empty parentheses are not specified, the default attributes of the data type are implied. The implicit length must exactly match the value that was specified (implicitly or explicitly) in the CREATE FUNCTION statement.

Specifying the FOR DATA clause or CCSID clause is optional. Omission of either clause indicates that the database manager ignores the attribute when determining whether the data types match. If either clause is specified, it must match the value that was implicitly or explicitly specified in the CREATE FUNCTION statement.

AS LOCATOR

Specifies that the function is defined to receive a locator for this parameter. If AS LOCATOR is specified, the data type must be a LOB or XML or a distinct type based on a LOB or XML.

SPECIFIC FUNCTION *specific-name*

Identifies the function by its specific name. The *specific-name* must identify a specific function that exists at the current server.

ALTER option-list

Indicates that one or more of the options of the function are to be altered. If an option is not specified, the value from the existing function definition is used. See [“CREATE FUNCTION \(external table\)”](#) on page 990 for a description of each option.

RESTRICT

Indicates that the function will not be altered if it is referenced by any view, function, procedure, or materialized query table.

Notes

General considerations for defining or replacing functions: See CREATE FUNCTION (external table) for general information about defining a function. ALTER FUNCTION (external table) allows individual attributes to be altered while preserving the privileges on the function.

Altering a function from NOT SECURED to SECURED: The function is considered secure after the ALTER FUNCTION statement is executed. Db2 treats the SECURED attribute as an assertion that declares that the user has established an audit procedure for all changes to the user-defined function. Db2 assumes that all subsequent ALTER FUNCTION statements are being reviewed through this audit process.

Invoking other user-defined functions in a secure function: When a secure user-defined function is referenced in an SQL data change statement that references a table that is using row access control or column access control, and if the secure user-defined function invokes other user-defined functions, the nested user-defined functions are not validated as secure. If those nested functions can access sensitive data, a user authorized to the Database Security Administrator function of IBM i needs to ensure that those functions are allowed to access that data and should ensure that a change control audit procedure has been established for all changes to those functions.

Syntax alternatives: The following keywords are synonyms supported for compatibility to prior releases. These keywords are non-standard and should not be used:

- The keywords VARIANT and NOT VARIANT can be used as synonyms for NOT DETERMINISTIC and DETERMINISTIC.
- The keywords NULL CALL and NOT NULL CALL can be used as synonyms for CALLED ON NULL INPUT and RETURNS NULL ON NULL INPUT.
- The keyword DB2GENRL may be used as a synonym for DB2GENERAL.
- The value DB2SQL may be used as a synonym for SQL.
- The keywords PARAMETER STYLE in the PARAMETER STYLE clause are optional.
- The keywords IS DETERMINISTIC may be used as a synonym for DETERMINISTIC.

Example

Modify the definition for an external table function to set the estimated cardinality to 10,000.

```
ALTER FUNCTION GET_TABLE  
ALTER CARDINALITY 10000
```

ALTER FUNCTION (SQL scalar)

The ALTER FUNCTION (SQL scalar) statement alters an SQL scalar function at the current server.

Invocation

This statement can be embedded in an application program or issued interactively. It is an executable statement that can be dynamically prepared.

Authorization

The privileges held by the authorization ID of the statement must include at least one of the following:

- For the function identified in the statement:
 - The ALTER privilege for the function, and
 - The USAGE privilege on the schema containing the function.
- Database administrator authority

If a different external program is specified, the privileges held by the authorization ID of the statement must also include the same privileges required to create a new external scalar function. For more information, see [“CREATE FUNCTION \(SQL scalar\)”](#) on page 1018.

If the SECURED option is specified or if the function is currently secure:

- The authorization ID of the statement must have security administrator authority. See [“Administrative authority”](#) on page 15.

For information about the system authorities corresponding to SQL privileges, see [Corresponding System Authorities When Checking Privileges to a Function or Procedure](#), [Corresponding System Authorities When Checking Privileges to a Table or View](#), and [Corresponding System Authorities When Checking Privileges to a Distinct Type](#).

Syntax

➤ ALTER ➤

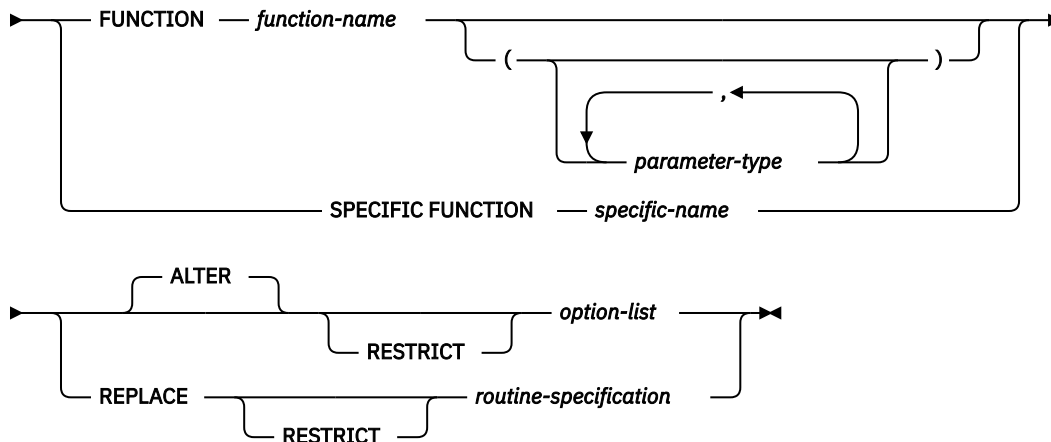

parameter-type

➤ *data-type1* AS LOCATOR

data-type1, data-type2, data-type3

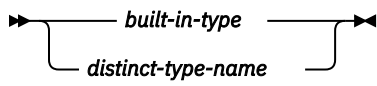

routine-specification

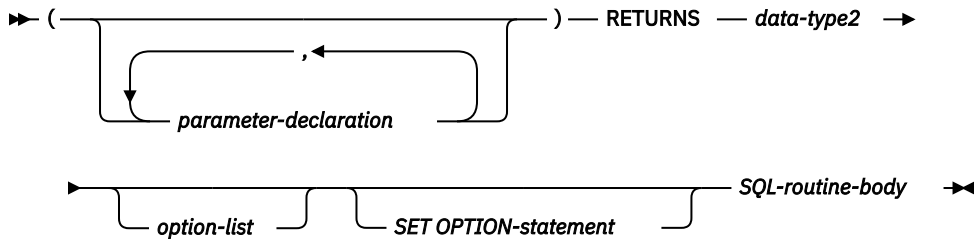

parameter-declaration

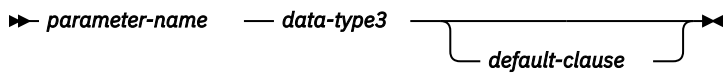

SQL-routine-body



option-list

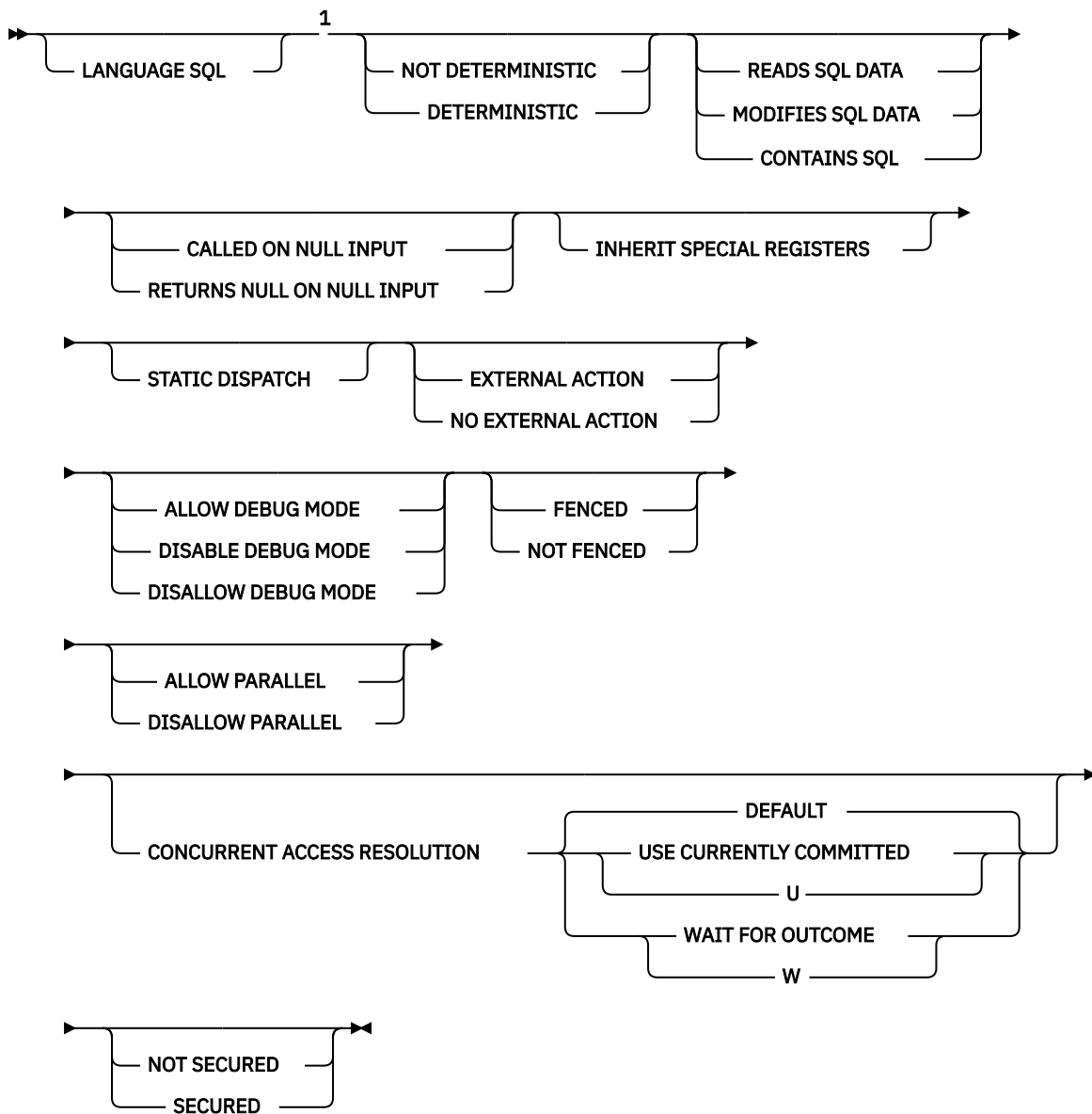

Notes:

¹ The clauses in the *option-list* can be specified in any order.

built-in-type

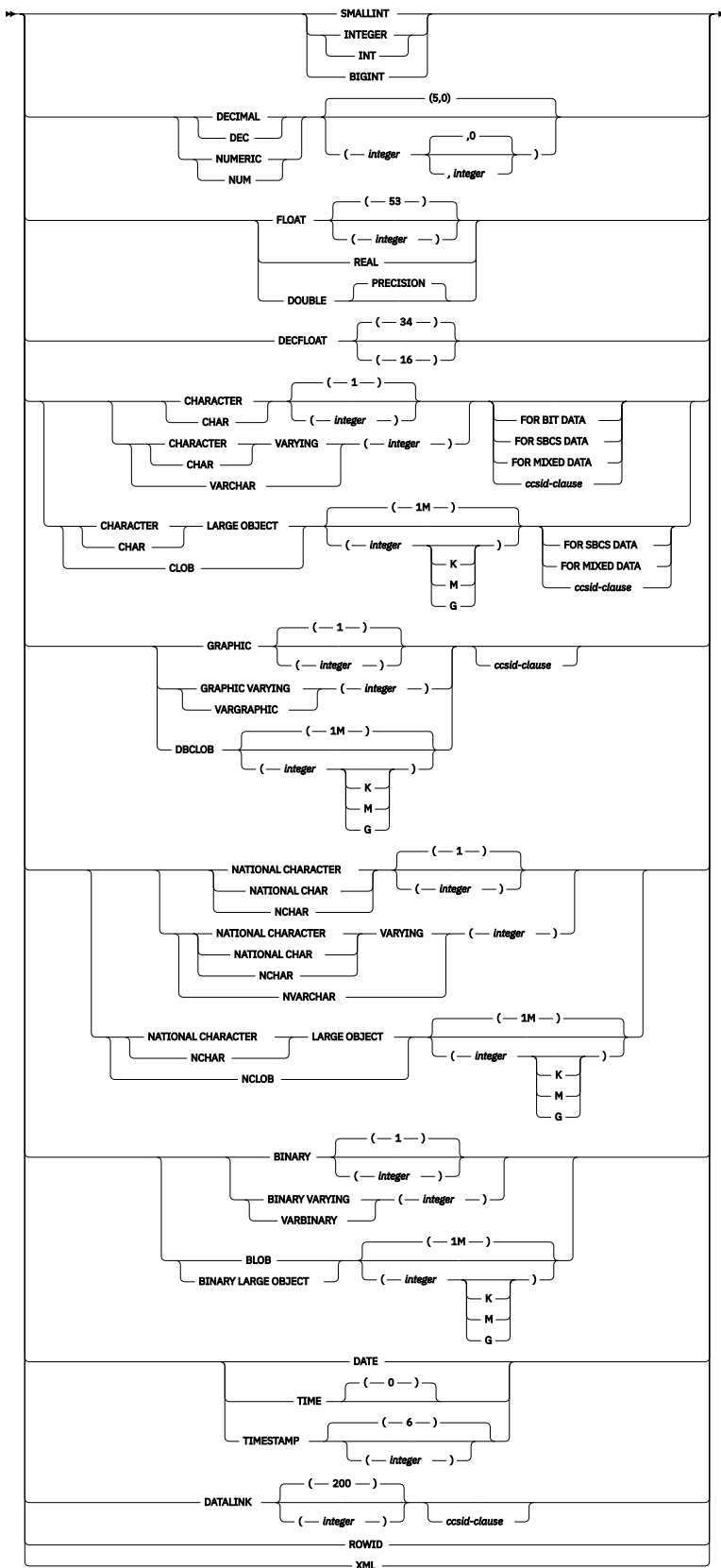

ccsid-clause

► CCSID — *integer* ◄

default-clause

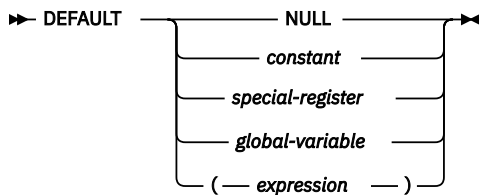

Description

FUNCTION or SPECIFIC FUNCTION

Identifies the function to alter. *function-name* must identify an SQL scalar function that exists at the current server.

The specified function is altered. The owner of the function and all privileges on the function are preserved.

FUNCTION *function-name*

Identifies the function by its name. The *function-name* must identify exactly one function. The function may have any number of parameters defined for it. If there is more than one function of the specified name in the specified or implicit schema, an error is returned.

FUNCTION *function-name (parameter-type,...)*

Identifies the function by its function signature, which uniquely identifies the function. The *function-name (parameter-type,...)* must identify a function with the specified function signature. The specified parameters must match the data types in the corresponding position that were specified when the function was created. The number of data types, and the logical concatenation of the data types is used to identify the specific function instance which is being altered. Synonyms for data types are considered a match. Parameters that have defaults must be included in this signature.

If *function-name()* is specified, the function identified must have zero parameters.

function-name

Identifies the name of the function.

(parameter-type,...)

Identifies the parameters of the function.

If an unqualified distinct type name is specified, the database manager searches the SQL path to resolve the schema name for the distinct type.

For data types that have a length, precision, or scale attribute, use one of the following:

- Empty parenthesis indicates that the database manager ignores the attribute when determining whether the data types match. For example, DEC() will be considered a match for a parameter of a function defined with a data type of DEC(7,2). However, FLOAT cannot be specified with empty parenthesis because its precision value indicates a specific data type (REAL or DOUBLE).
- If a specific value for a length, precision, or scale attribute is specified, the value must exactly match the value that was specified (implicitly or explicitly) in the CREATE FUNCTION statement. If the data type is FLOAT, the precision does not have to exactly match the value that was specified because matching is based on the data type (REAL or DOUBLE).
- If length, precision, or scale is not explicitly specified, and empty parentheses are not specified, the default attributes of the data type are implied. The implicit length must exactly match the value that was specified (implicitly or explicitly) in the CREATE FUNCTION statement.

Specifying the FOR DATA clause or CCSID clause is optional. Omission of either clause indicates that the database manager ignores the attribute when determining whether the data types match. If either clause is specified, it must match the value that was implicitly or explicitly specified in the CREATE FUNCTION statement.

AS LOCATOR

Specifies that the function is defined to receive a locator for this parameter. If AS LOCATOR is specified, the data type must be a LOB or XML or a distinct type based on a LOB or XML.

SPECIFIC FUNCTION *specific-name*

Identifies the function by its specific name. The *specific-name* must identify a specific function that exists at the current server.

ALTER *option-list*

Indicates that one or more of the options of the function are to be altered. If ALTER FUNCTION ALTER *option-list* is specified and an option is not specified, the value from the existing function definition is used. See [“CREATE FUNCTION \(SQL scalar\)” on page 1018](#) for a description of each option.

REPLACE *routine-specification*

Indicates that the existing function definition, including options and parameters, is to be replaced by those specified in this statement. The values of all options are replaced when a function is replaced. If an option is not specified, the same default is used as when a new SQL scalar function is created, for more information see [“CREATE FUNCTION \(SQL scalar\)” on page 1018](#).

If the routine has a comment or label, they are removed from the routine definition.

RESTRICT

Indicates that the function will not be altered or replaced if it is referenced by any function, materialized query table, procedure, trigger, or view.

(*parameter-declaration,...*)

Specifies the number of parameters of the function, the data type of each parameter, and the name of each parameter.

The maximum number of parameters allowed in an SQL function is 2000.

parameter-name

Names the parameter. The name is used to refer to the parameter within the body of the function. The name cannot be the same as any other *parameter-name* in the parameter list.

data-type3

Specifies the data type of the input parameter. If a CCSID is specified, the parameter will be converted to that CCSID prior to passing it to the function. If a CCSID is not specified, the CCSID is determined by the default CCSID at the current server at the time the function is invoked.

default-clause

Specifies a default value for the parameter. The default can be a constant, a special register, a global variable, an expression, or the keyword NULL. The expression is any expression defined in [“Expressions” on page 159](#), that does not include an aggregate function or column name. If a default value is not specified, the parameter has no default and cannot be omitted on invocation. The maximum length of the expression string is 64K.

The default expression must be assignment compatible to the parameter data type.

Any comma in the default expression that is intended as a separator of numeric constants in a list must be followed by a space.

A default cannot be specified for a parameter of type array.

RETURNS

Specifies the output of the function.

data-type2

Specifies the data type and attributes of the output.

You can specify any built-in data type (except LONG VARCHAR, or LONG VARGRAPHIC) or a distinct type.

If a CCSID is specified and the CCSID of the return data is encoded in a different CCSID, the data is converted to the specified CCSID.

If a CCSID is not specified the return data is converted to the CCSID of the job (or associated graphic CCSID of the job for graphic string return values), if the CCSID of the return data is encoded in a different CCSID. To avoid any potential loss of characters during the conversion, consider explicitly specifying a CCSID that can represent any characters that will be returned from the function. This is especially important if the data type is graphic string data. In this case, consider using CCSID 1200 or 13488 (Unicode graphic string data).

option-list

List of options for the function being altered. These options are the same ones that are listed above under ALTER *option-list*. If a specific option is not specified, the same default that is used when a new function is created is used. For more information see [“CREATE FUNCTION \(SQL scalar\)” on page 1018](#).

SET OPTION-statement

Specifies the options that will be used to create the function. For example, to create a debuggable function, the following statement could be included:

```
SET OPTION DBGVIEW = *SOURCE
```

For more information, see [“SET OPTION” on page 1505](#).

The options CNULRQD, COMPILEOPT, NAMING, and SQLCA are not allowed in the ALTER FUNCTION statement. The following options are used when processing default value expressions: ALWCPYDTA, CONACC, DATFMT, DATSEP, DECFLTRND, DECMPT, DECRESULT, DFTRDBCOL, LANGID, SQLCURRULE, SQLPATH, SRTSEQ, TGTRLS, TIMFMT, and TIMSEP.

SQL-routine-body

Specifies a single SQL statement, including a compound statement. See [“SQL control statements” on page 1569](#) for more information about defining SQL functions.

A call to a procedure that issues a CONNECT, SET CONNECTION, RELEASE, DISCONNECT, COMMIT, ROLLBACK, and SET TRANSACTION statement is not allowed in a function.

The *SQL-routine-body* must contain at least one RETURN statement and a RETURN statement must be executed when the function is called.

ALTER PROCEDURE (SQL), ALTER FUNCTION (SQL scalar), and ALTER FUNCTION (SQL table) with a REPLACE keyword are not allowed in an *SQL-routine-body*.

Notes

General considerations for defining or replacing functions: See CREATE FUNCTION (SQL scalar) for general information about defining a function. ALTER FUNCTION (SQL scalar) allows individual attributes to be altered while preserving the privileges on the function.

Cascaded effects: If REPLACE is specified without RESTRICT and the function signature or result data type is altered, the results from any function, materialized query table, procedure, trigger, or view that references the function may be unpredictable. Any referenced objects should be recreated.

Obfuscated statements: A function that was created using an obfuscated statement can be altered. When the statement is altered the encoded version of the statement that is saved in the catalog is modified and could exceed the maximum length for an SQL statement. If this happens an error will be issued and the alter will fail.

Altering a function from NOT SECURED to SECURED: The function is considered secure after the ALTER FUNCTION statement is executed. Db2 treats the SECURED attribute as an assertion that declares that the user has established an audit procedure for all changes to the user-defined function. Db2 assumes that all subsequent ALTER FUNCTION statements are being reviewed through this audit process.

Invoking other user-defined functions in a secure function: When a secure user-defined function is referenced in an SQL data change statement that references a table that is using row access control or column access control, and if the secure user-defined function invokes other user-defined functions, the nested user-defined functions are not validated as secure. If those nested functions can access sensitive data, a user authorized to the Database Security Administrator function of IBM i needs to ensure that

those functions are allowed to access that data and should ensure that a change control audit procedure has been established for all changes to those functions.

Syntax alternatives: The following keywords are synonyms supported for compatibility to prior releases. These keywords are non-standard and should not be used:

- The keywords `VARIANT` and `NOT VARIANT` can be used as synonyms for `NOT DETERMINISTIC` and `DETERMINISTIC`.
- The keywords `NULL CALL` and `NOT NULL CALL` can be used as synonyms for `CALLED ON NULL INPUT` and `RETURNS NULL ON NULL INPUT`.
- The keywords `IS DETERMINISTIC` may be used as a synonym for `DETERMINISTIC`.

Example

Modify the definition for an SQL scalar function to indicate that the function is deterministic.

```
ALTER FUNCTION MY_UDF1
DETERMINISTIC
```

ALTER FUNCTION (SQL table)

The ALTER FUNCTION (SQL table) statement alters an SQL table function at the current server.

Invocation

This statement can be embedded in an application program or issued interactively. It is an executable statement that can be dynamically prepared.

Authorization

The privileges held by the authorization ID of the statement must include at least one of the following:

- For the function identified in the statement:
 - The ALTER privilege for the function, and
 - The USAGE privilege on the schema containing the function.
- Database administrator authority

If a different external program is specified, the privileges held by the authorization ID of the statement must also include the same privileges required to create a new external table function. For more information, see [“CREATE FUNCTION \(SQL table\)”](#) on page 1032.

If the SECURED option is specified or if the function is currently secure:

- The authorization ID of the statement must have security administrator authority. See [“Administrative authority”](#) on page 15.

For information about the system authorities corresponding to SQL privileges, see [Corresponding System Authorities When Checking Privileges to a Function or Procedure](#), [Corresponding System Authorities When Checking Privileges to a Table or View](#), and [Corresponding System Authorities When Checking Privileges to a Distinct Type](#).

Syntax

►► ALTER ►

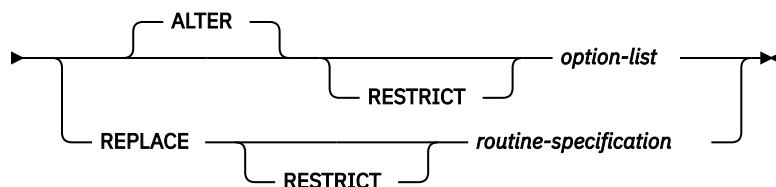
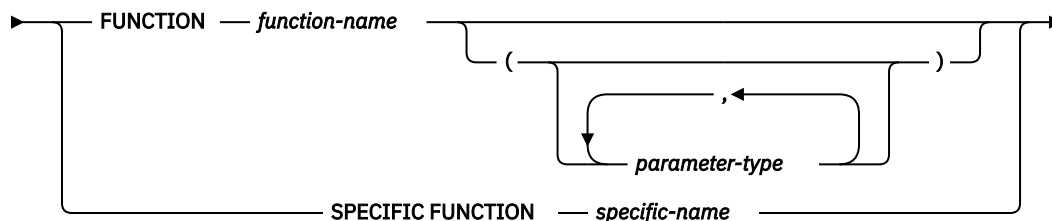

parameter-type

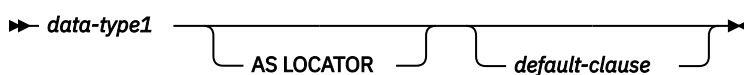

data-type1, data-type2, data-type3

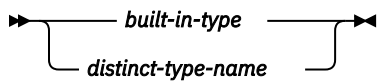

default-clause

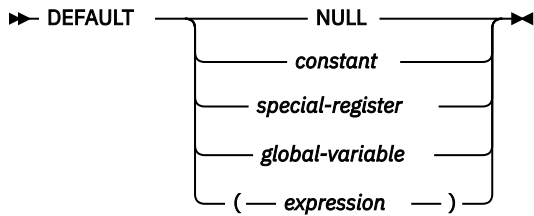

routine-specification

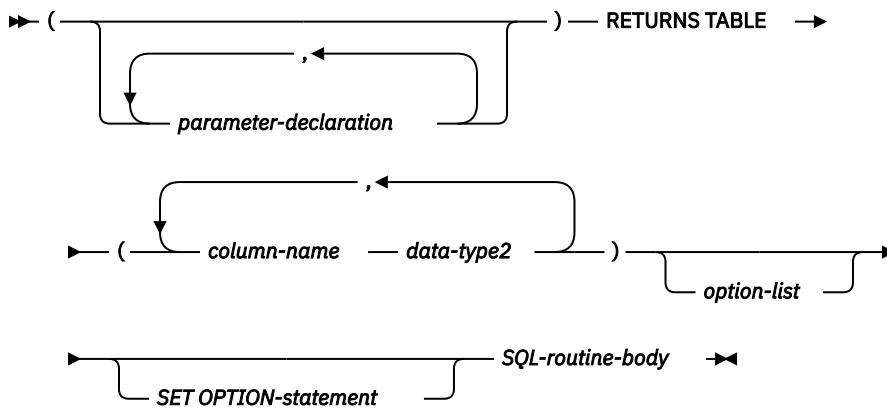

parameter-declaration



SQL-routine-body



option-list

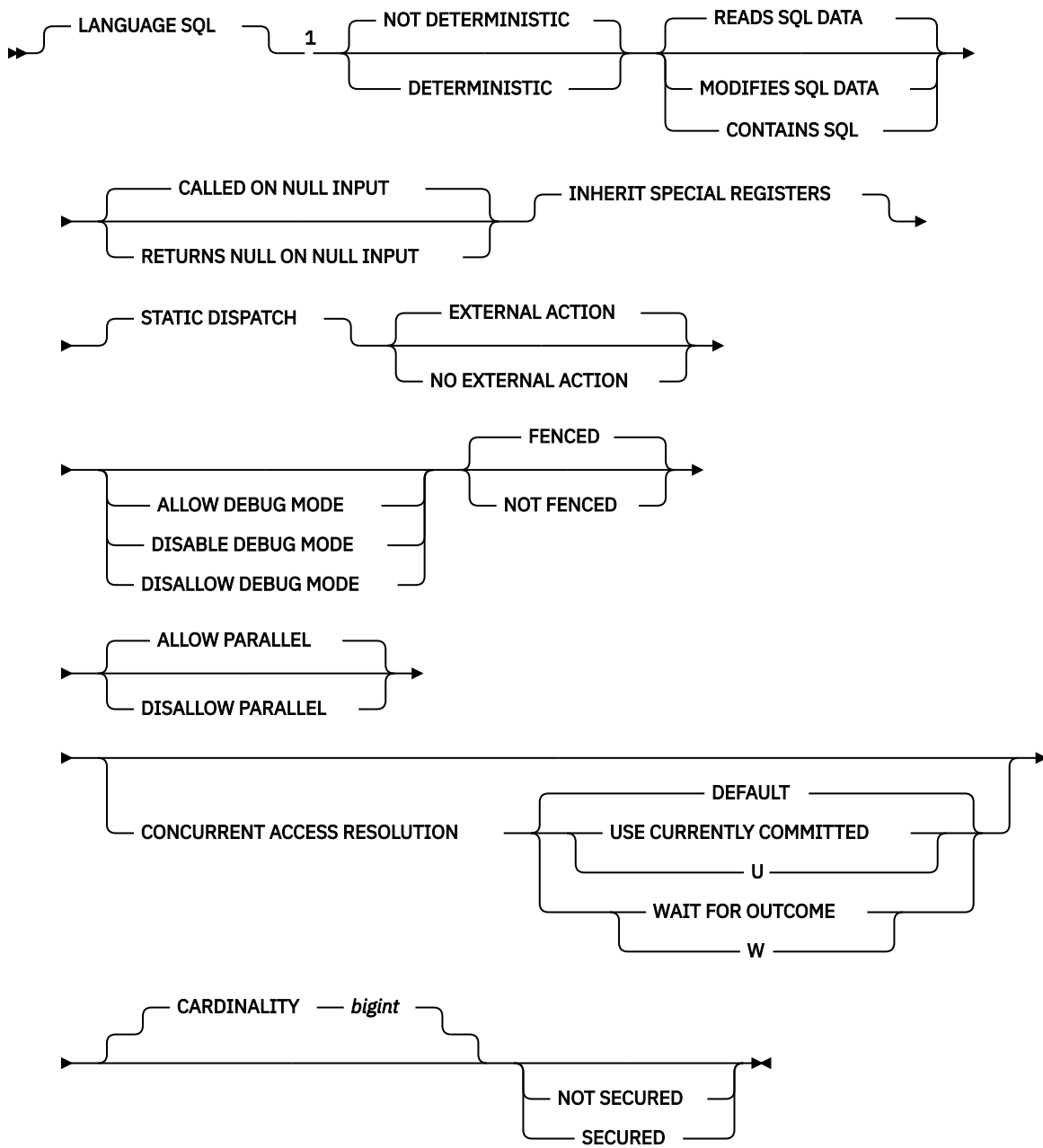

Notes:

¹ The clauses in the *option-list* can be specified in any order.

built-in-type

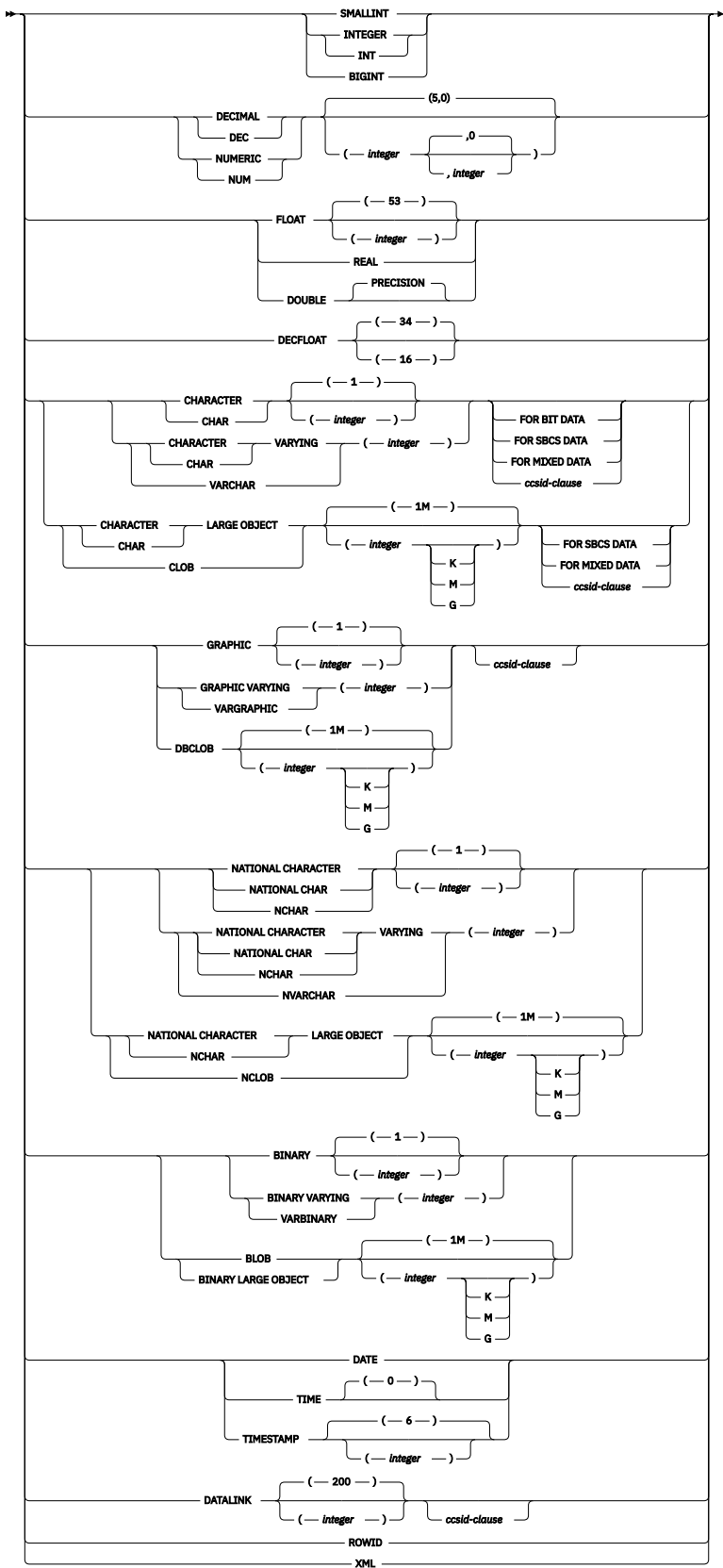

ccsid-clause

➤ CCSID — integer ➤

Description

FUNCTION or SPECIFIC FUNCTION

Identifies the function to alter. *function-name* must identify an SQL table function that exists at the current server.

The specified function is altered. The owner of the function and all privileges on the function are preserved.

FUNCTION *function-name*

Identifies the function by its name. The *function-name* must identify exactly one function. The function may have any number of parameters defined for it. If there is more than one function of the specified name in the specified or implicit schema, an error is returned.

FUNCTION *function-name (parameter-type,...)*

Identifies the function by its function signature, which uniquely identifies the function. The *function-name (parameter-type,...)* must identify a function with the specified function signature. The specified parameters must match the data types in the corresponding position that were specified when the function was created. The number of data types, and the logical concatenation of the data types is used to identify the specific function instance which is being altered. Synonyms for data types are considered a match. Parameters that have defaults must be included in this signature.

If *function-name()* is specified, the function identified must have zero parameters.

function-name

Identifies the name of the function.

(parameter-type,...)

Identifies the parameters of the function.

If an unqualified distinct type name is specified, the database manager searches the SQL path to resolve the schema name for the distinct type.

For data types that have a length, precision, or scale attribute, use one of the following:

- Empty parenthesis indicates that the database manager ignores the attribute when determining whether the data types match. For example, DEC() will be considered a match for a parameter of a function defined with a data type of DEC(7,2). However, FLOAT cannot be specified with empty parenthesis because its precision value indicates a specific data type (REAL or DOUBLE).
- If a specific value for a length, precision, or scale attribute is specified, the value must exactly match the value that was specified (implicitly or explicitly) in the CREATE FUNCTION statement. If the data type is FLOAT, the precision does not have to exactly match the value that was specified because matching is based on the data type (REAL or DOUBLE).
- If length, precision, or scale is not explicitly specified, and empty parentheses are not specified, the default attributes of the data type are implied. The implicit length must exactly match the value that was specified (implicitly or explicitly) in the CREATE FUNCTION statement.

Specifying the FOR DATA clause or CCSID clause is optional. Omission of either clause indicates that the database manager ignores the attribute when determining whether the data types match. If either clause is specified, it must match the value that was implicitly or explicitly specified in the CREATE FUNCTION statement.

AS LOCATOR

Specifies that the function is defined to receive a locator for this parameter. If AS LOCATOR is specified, the data type must be a LOB or XML or a distinct type based on a LOB or XML.

SPECIFIC FUNCTION *specific-name*

Identifies the function by its specific name. The *specific-name* must identify a specific function that exists at the current server.

ALTER *option-list*

Indicates that one or more of the options of the function are to be altered. If ALTER FUNCTION ALTER *option-list* is specified and an option is not specified, the value from the existing function definition is used. See [“CREATE FUNCTION \(SQL table\)”](#) on page 1032 for a description of each option.

REPLACE *routine-specification*

Indicates that the existing function definition, including options and parameters, is to be replaced by those specified in this statement. The values of all options are replaced when a function is replaced. If an option is not specified, the same default is used as when a new SQL table function is created, for more information see [“CREATE FUNCTION \(SQL table\)”](#) on page 1032.

If the routine has a comment or label, they are removed from the routine definition.

RESTRICT

Indicates that the function will not be altered or replaced if it is referenced by any function, materialized query table, procedure, trigger, or view.

(*parameter-declaration,...*)

Specifies the number of parameters of the function, the data type of each parameter, and the name of each parameter.

The maximum number of parameters allowed in an SQL function is 2000.

parameter-name

Names the parameter. The name is used to refer to the parameter within the body of the function. The name cannot be the same as any other *parameter-name* in the parameter list.

data-type3

Specifies the data type of the input parameter. If a CCSID is specified, the parameter will be converted to that CCSID prior to passing it to the function. If a CCSID is not specified, the CCSID is determined by the default CCSID at the current server at the time the function is invoked.

default-clause

Specifies a default value for the parameter. The default can be a constant, a special register, a global variable, an expression, or the keyword NULL. The expression is any expression defined in [“Expressions”](#) on page 159, that does not include an aggregate function or column name. If a default value is not specified, the parameter has no default and cannot be omitted on invocation. The maximum length of the expression string is 64K.

The default expression must be assignment compatible to the parameter data type.

Any comma in the default expression that is intended as a separator of numeric constants in a list must be followed by a space.

A default cannot be specified for a parameter of type array.

RETURNS TABLE

Specifies the output table of the function.

Assume the number of parameters is *N*. There must be no more than 2000-*N* columns.

column-name

Specifies the name of a column of the output table. Do not specify the same name more than once.

data-type2

Specifies the data type and attributes of the output.

You can specify any built-in data type (except LONG VARCHAR, or LONG VARGRAPHIC) or a distinct type.

If a CCSID is specified and the CCSID of the return data is encoded in a different CCSID, the data is converted to the specified CCSID.

If a CCSID is not specified the return data is converted to the CCSID of the job (or associated graphic CCSID of the job for graphic string return values), if the CCSID of the return data is

encoded in a different CCSID. To avoid any potential loss of characters during the conversion, consider explicitly specifying a CCSID that can represent any characters that will be returned from the function. This is especially important if the data type is graphic string data. In this case, consider using CCSID 1200 or 13488 (Unicode graphic string data).

option-list

List of options for the function being altered. These options are the same ones that are listed above under ALTER *option-list*. If a specific option is not specified, the same default that is used when a new function is created is used. For more information see [“CREATE FUNCTION \(SQL table\)”](#) on page 1032.

SET OPTION-statement

Specifies the options that will be used to create the function. For example, to create a debuggable function, the following statement could be included:

```
SET OPTION DBGVIEW = *SOURCE
```

For more information, see [“SET OPTION”](#) on page 1505.

The options CNULRQD, COMPILEOPT, NAMING, and SQLCA are not allowed in the ALTER FUNCTION statement. The following options are used when processing default value expressions: ALWCPYDTA, CONACC, DATFMT, DATSEP, DECFLTRND, DECMPT, DECRESULT, DFTRDBCOL, LANGID, SQLCURRULE, SQLPATH, SRTSEQ, TGTRLS, TIMFMT, and TIMSEP.

SQL-routine-body

Specifies a single SQL statement, including a compound statement. See [“SQL control statements”](#) on page 1569 for more information about defining SQL functions.

A call to a procedure that issues a CONNECT, SET CONNECTION, RELEASE, DISCONNECT, COMMIT, ROLLBACK, and SET TRANSACTION statement is not allowed in a function.

The *SQL-routine-body* must contain at least one RETURN statement and a RETURN statement must be executed when the function is called.

ALTER PROCEDURE (SQL), ALTER FUNCTION (SQL scalar), and ALTER FUNCTION (SQL table) with a REPLACE keyword are not allowed in an *SQL-routine-body*.

Notes

General considerations for defining or replacing functions: See CREATE FUNCTION (SQL table) for general information about defining a function. ALTER FUNCTION (SQL table) allows individual attributes to be altered while preserving the privileges on the function.

Cascaded effects: If REPLACE is specified without RESTRICT and the function signature or result data types are altered, the results from any function, materialized query table, procedure, trigger, or view that references the function may be unpredictable. Any referenced objects should be recreated.

Obfuscated statements: A function that was created using an obfuscated statement can be altered. When the statement is altered the encoded version of the statement that is saved in the catalog is modified and could exceed the maximum length for an SQL statement. If this happens an error will be issued and the alter will fail.

Altering a function from NOT SECURED to SECURED: The function is considered secure after the ALTER FUNCTION statement is executed. Db2 treats the SECURED attribute as an assertion that declares that the user has established an audit procedure for all changes to the user-defined function. Db2 assumes that all subsequent ALTER FUNCTION statements are being reviewed through this audit process.

Invoking other user-defined functions in a secure function: When a secure user-defined function is referenced in an SQL data change statement that references a table that is using row access control or column access control, and if the secure user-defined function invokes other user-defined functions, the nested user-defined functions are not validated as secure. If those nested functions can access sensitive data, a user authorized to the Database Security Administrator function of IBM i needs to ensure that those functions are allowed to access that data and should ensure that a change control audit procedure has been established for all changes to those functions.

Syntax alternatives: The following keywords are synonyms supported for compatibility to prior releases. These keywords are non-standard and should not be used:

- The keywords VARIANT and NOT VARIANT can be used as synonyms for NOT DETERMINISTIC and DETERMINISTIC.
- The keywords NULL CALL and NOT NULL CALL can be used as synonyms for CALLED ON NULL INPUT and RETURNS NULL ON NULL INPUT.
- The keywords IS DETERMINISTIC may be used as a synonym for DETERMINISTIC.

Example

Modify the definition for an SQL table function to set the estimated cardinality to 10,000.

```
ALTER FUNCTION GET_TABLE  
ALTER CARDINALITY 10000
```

ALTER MASK

The ALTER MASK statement alters a column mask that exists at the current server.

Invocation

This statement can be embedded in an application program or issued interactively. It is an executable statement that can be dynamically prepared.

Authorization

The authorization ID of the statement must have security administrator authority. See [“Administrative authority”](#) on page 15.

Syntax

```
➤➤ ALTER MASK — mask-name { ENABLE | DISABLE | REGENERATE }
```

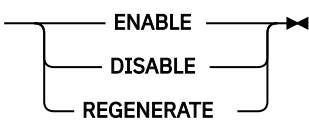

Description

mask-name

Identifies the column mask to be altered. It must identify a column mask that exists at the current server.

ENABLE, DISABLE, or REGENERATE

ENABLE

Specifies that the column mask is to be enabled for column access control. If column access control is not currently activated for the table, the column mask will become effective when column access control is activated for the table. If column access control is currently activated for the table, the column mask becomes effective immediately.

A column mask that gets an error when trying to be enabled cannot be enabled until any errors in the mask definition are resolved. This may require the column mask to be dropped and recreated with a modified definition.

ENABLE is ignored if the column mask is already defined as enabled for column access control.

DISABLE

Specifies that the column mask is to be disabled for column access control. If column access control is not currently activated for the table, the column mask will remain ineffective when column access control is activated for the table. If column access control is currently activated for the table, the column mask becomes ineffective.

DISABLE is ignored if the column mask is already defined as disabled for column access control.

REGENERATE

Specifies that the column mask is to be regenerated. The column mask definition in the catalog is used and existing dependencies and authorizations, if any, are retained. The column mask definition is reevaluated as if the column mask were being created. The user-defined functions that are referenced in the column mask definition must be resolved to the same secure UDFs as were resolved during the column mask creation.

Examples

Example 1: Enable column mask M1.

```
ALTER MASK M1 ENABLE
```

Example 2: Disable column mask M1.

```
ALTER MASK M1 DISABLE
```

Example 3: Regenerate column mask M1.

```
ALTER MASK M1 REGENERATE
```

ALTER PERMISSION

The ALTER PERMISSION statement alters a row permission that exists at the current server.

Invocation

This statement can be embedded in an application program or issued interactively. It is an executable statement that can be dynamically prepared.

Authorization

The authorization ID of the statement must have security administrator authority. See [“Administrative authority”](#) on page 15.

Syntax

➤ ALTER PERMISSION — *permission-name* — { ENABLE | DISABLE | REGENERATE } ➤

Description

permission-name

Identifies the row permission to be altered. It must identify a row permission that exists at the current server. It cannot be a default permission.

ENABLE, DISABLE, or REGENERATE

ENABLE

Specifies that the row permission is to be enabled for row access control. If row access control is not currently activated for the table, the row permission will become effective when row access control is activated for the table. If row access control is currently activated for the table, the row permission becomes effective immediately.

A row permission that gets an error when trying to be enabled cannot be enabled until any errors in the permission definition are resolved. This may require the row permission to be dropped and recreated with a modified definition.

ENABLE is ignored if the row permission is already defined as enabled for row access control.

DISABLE

Specifies that the row permission is to be disabled for row access control. If row access control is not currently activated for the table, the row permission will remain ineffective when row access control is activated for the table. If row access control is currently activated for the table, the row permission becomes ineffective.

If row access control is currently activated for the table and all row permissions are disabled, a default row permission that allows no access to any row of the table will be used.

DISABLE is ignored if the row permission is already defined as disabled for row access control.

REGENERATE

Specifies that the row permission is to be regenerated. The row permission definition in the catalog is used and existing dependencies and authorizations, if any, are retained. The row permission definition is reevaluated as if the row permission were being created. The user-defined functions that are referenced in the row permission must be resolved to the same secure UDFs as were resolved during the row permission creation.

Examples

Example 1: Enable permission P1.

```
ALTER PERMISSION P1 ENABLE
```

Example 2: Disable permission P1.

```
ALTER PERMISSION P1 DISABLE
```

Example 3: Regenerate permission P1.

```
ALTER PERMISSION P1 REGENERATE
```

ALTER PROCEDURE (external)

The ALTER PROCEDURE (external) statement alters an external procedure at the current server.

Invocation

This statement can be embedded in an application program or issued interactively. It is an executable statement that can be dynamically prepared.

Authorization

The privileges held by the authorization ID of the statement must include at least one of the following:

- For the procedure identified in the statement:
 - The ALTER privilege for the procedure, and
 - The USAGE privilege on the schema containing the procedure.
- Database administrator authority

If a different external program is specified, the privileges held by the authorization ID of the statement must also include the same privileges required to create a new external procedure. For more information, see “CREATE PROCEDURE (external)” on page 1065.

For information about the system authorities corresponding to SQL privileges, see [Corresponding System Authorities When Checking Privileges to a Function or Procedure](#), [Corresponding System Authorities When Checking Privileges to a Table or View](#), and [Corresponding System Authorities When Checking Privileges to a Distinct Type](#).

Syntax

➤ ALTER ➔

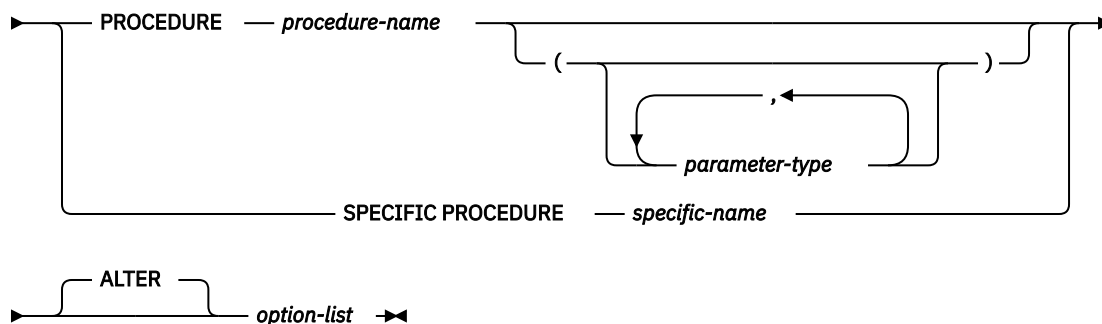

parameter-type



data-type

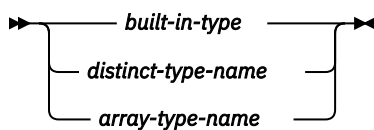

option-list

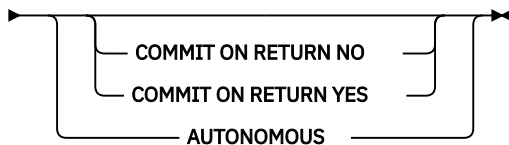
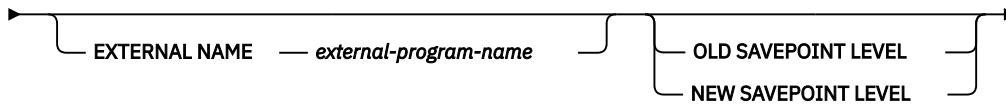
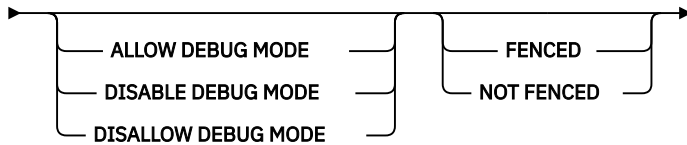
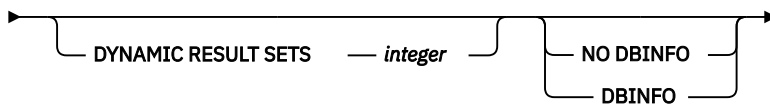
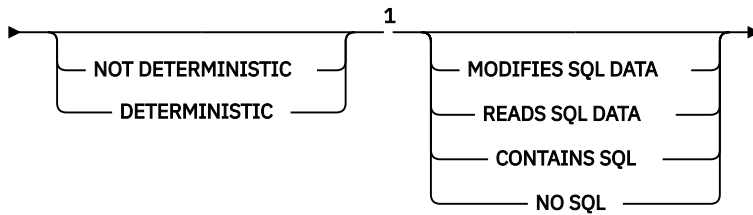
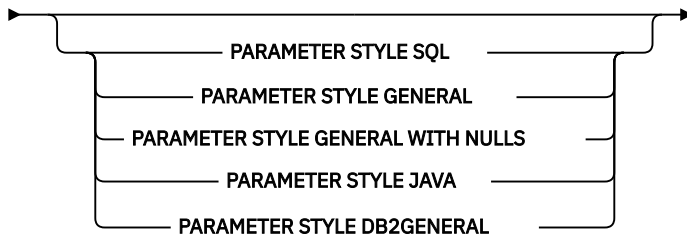
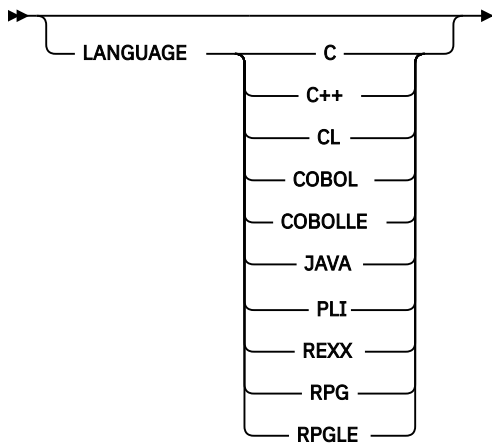

Notes:

¹ The clauses in the *option-list* can be specified in any order.

built-in-type

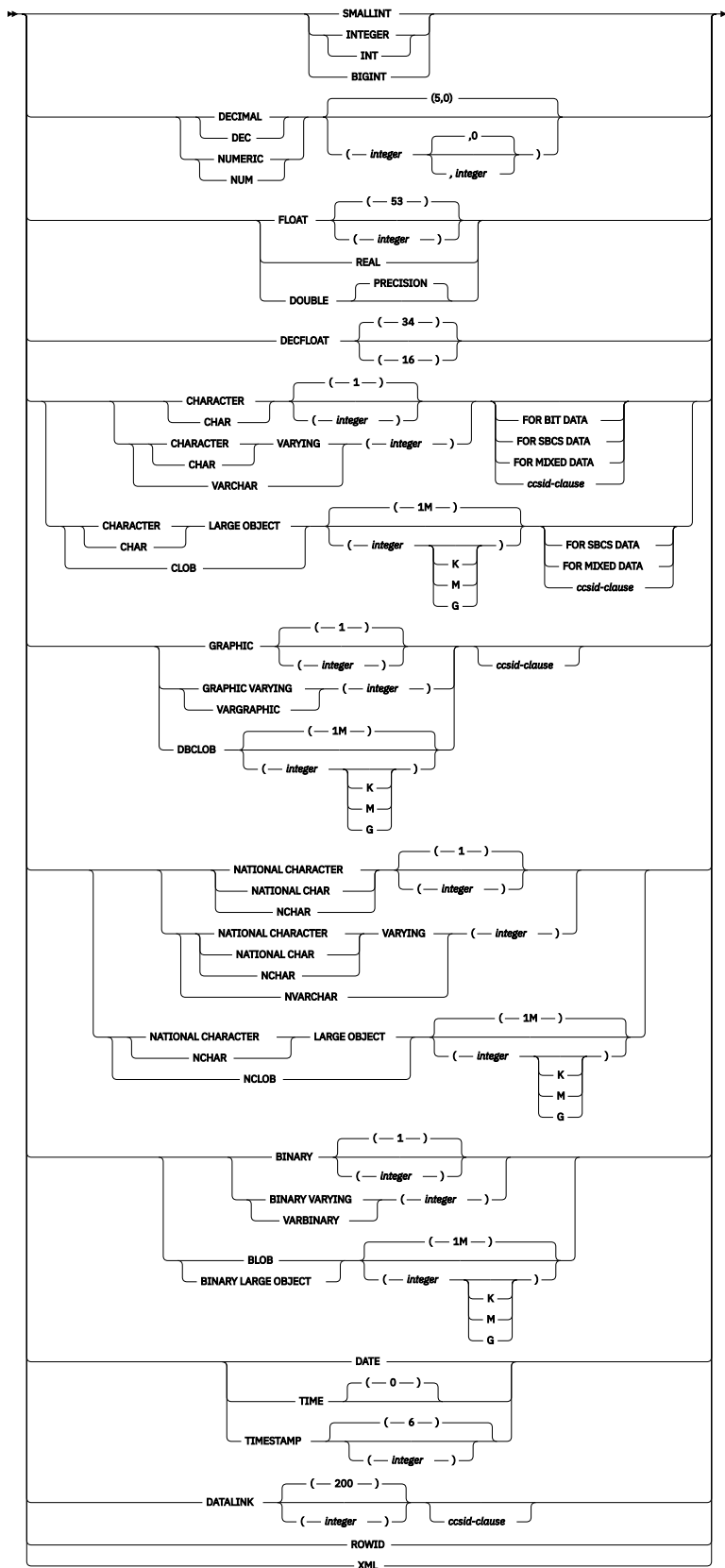

ccsid-clause

➤ CCSID — *integer* ➤

Description

PROCEDURE or SPECIFIC PROCEDURE

Identifies the procedure to alter. *procedure-name* must identify an external procedure that exists at the current server.

The specified procedure is altered. The owner of the procedure is preserved. If the external program or service program exists at the time the procedure is altered, all privileges on the procedure are preserved.

PROCEDURE *procedure-name*

Identifies the procedure by its name. The *procedure-name* must identify exactly one external procedure. The procedure may have any number of parameters defined for it. If there is more than one procedure of the specified name in the specified or implicit schema, an error is returned.

PROCEDURE *procedure-name (parameter-type,...)*

Identifies the procedure by its procedure signature, which uniquely identifies the procedure. The *procedure-name (parameter-type,...)* must identify an external procedure with the specified procedure signature. The specified parameters must match the data types in the corresponding position that were specified when the procedure was created. The number of data types and the logical concatenation of the data types is used to identify the specific procedure instance which is being altered. Synonyms for data types are considered a match. Parameters that have defaults must be included in this signature.

If *procedure-name()* is specified, the procedure identified must have zero parameters.

procedure-name

Identifies the name of the procedure.

(parameter-type,...)

Identifies the parameters of the procedure.

If an unqualified distinct type or array type name is specified, the database manager searches the SQL path to resolve the schema name for the distinct type or array type.

For data types that have a length, precision, or scale attribute, use one of the following:

- Empty parenthesis indicates that the database manager ignores the attribute when determining whether the data types match. For example, DEC() will be considered a match for a parameter of a procedure defined with a data type of DEC(7,2). However, FLOAT cannot be specified with empty parenthesis because its precision value indicates a specific data type (REAL or DOUBLE).
- If a specific value for a length, precision, or scale attribute is specified, the value must exactly match the value that was specified (implicitly or explicitly) in the CREATE PROCEDURE statement. If the data type is FLOAT, the precision does not have to exactly match the value that was specified because matching is based on the data type (REAL or DOUBLE).
- If length, precision, or scale is not explicitly specified, and empty parentheses are not specified, the default attributes of the data type are implied. The implicit length must exactly match the value that was specified (implicitly or explicitly) in the CREATE PROCEDURE statement.

Specifying the FOR DATA clause or CCSID clause is optional. Omission of either clause indicates that the database manager ignores the attribute when determining whether the data types match. If either clause is specified, it must match the value that was implicitly or explicitly specified in the CREATE PROCEDURE statement.

AS LOCATOR

Specifies that the procedure is defined to receive a locator for this parameter. If AS LOCATOR is specified, the data type must be a LOB or XML or a distinct type based on a LOB or XML.

SPECIFIC PROCEDURE *specific-name*

Identifies the procedure by its specific name. The *specific-name* must identify a specific procedure that exists at the current server.

ALTER option-list

Indicates that one or more of the options of the procedure are to be altered. If an option is not specified, the value from the existing procedure definition is used. See [“CREATE PROCEDURE \(external\)”](#) on page 1065 for a description of each option.

Notes

General considerations for defining or changing a procedure: See CREATE PROCEDURE for general information about defining a procedure. ALTER PROCEDURE (external) allows individual attributes to be altered while preserving the privileges on the procedure.

Syntax alternatives: The following keywords are synonyms supported for compatibility to prior releases. These keywords are non-standard and should not be used:

- The keywords VARIANT and NOT VARIANT can be used as synonyms for NOT DETERMINISTIC and DETERMINISTIC.
- The keywords NULL CALL can be used as synonyms for CALLED ON NULL INPUT.
- DYNAMIC RESULT SET, RESULT SETS, and RESULT SET may be used as synonyms for DYNAMIC RESULT SETS.
- The value DB2SQL may be used as a synonym for SQL.

Examples

Modify the definition for procedure MYPROC to change the name of the external program that is invoked when the procedure is called. The name of the external program is PROG10A.

```
ALTER PROCEDURE MYPROC  
EXTERNAL NAME PROG10A
```

ALTER PROCEDURE (SQL)

The ALTER PROCEDURE (SQL) statement alters a procedure at the current server.

Invocation

This statement can be embedded in an application program or issued interactively. It is an executable statement that can be dynamically prepared.

Authorization

The privileges held by the authorization ID of the statement must include at least one of the following:

- For the procedure identified in the statement:
 - The ALTER privilege for the procedure, and
 - The USAGE privilege on the schema containing the procedure.
- Database administrator authority

If a distinct type is referenced in a *parameter-declaration*, the privileges held by the authorization ID of the statement must include at least one of the following:

- For each distinct type identified in the statement:
 - The USAGE privilege on the distinct type, and
 - The USAGE privilege on the schema containing the distinct type
- Administrative authority

For information about the system authorities corresponding to SQL privileges, see [Corresponding System Authorities When Checking Privileges to a Function or Procedure](#) and [Corresponding System Authorities When Checking Privileges to a Distinct Type](#).

Syntax

➤ ALTER ➔

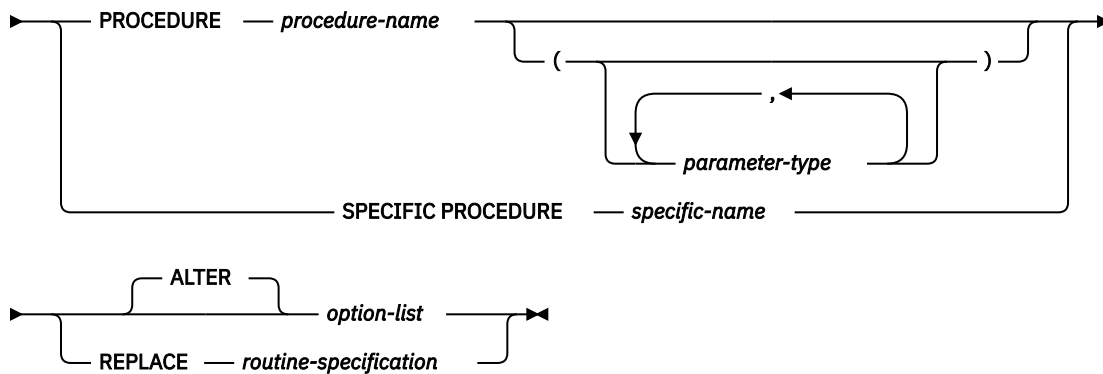

routine-specification

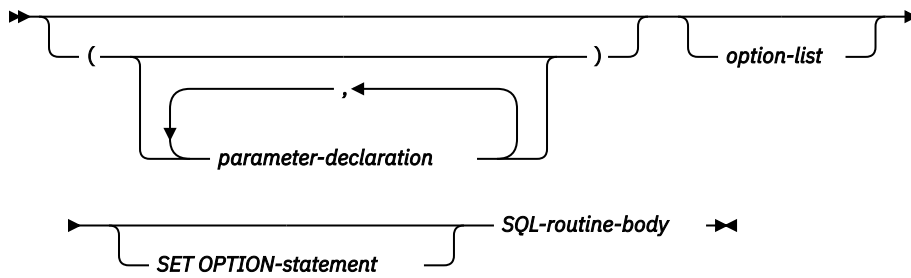

parameter-declaration

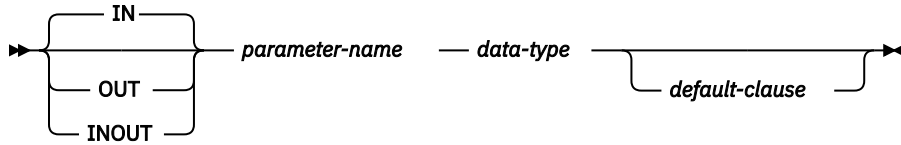

parameter-type

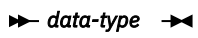

data-type

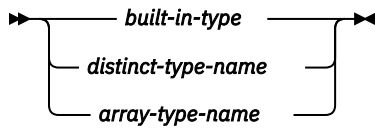

default-clause

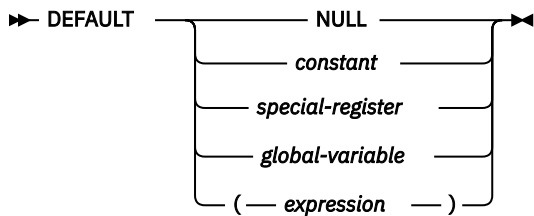

option-list

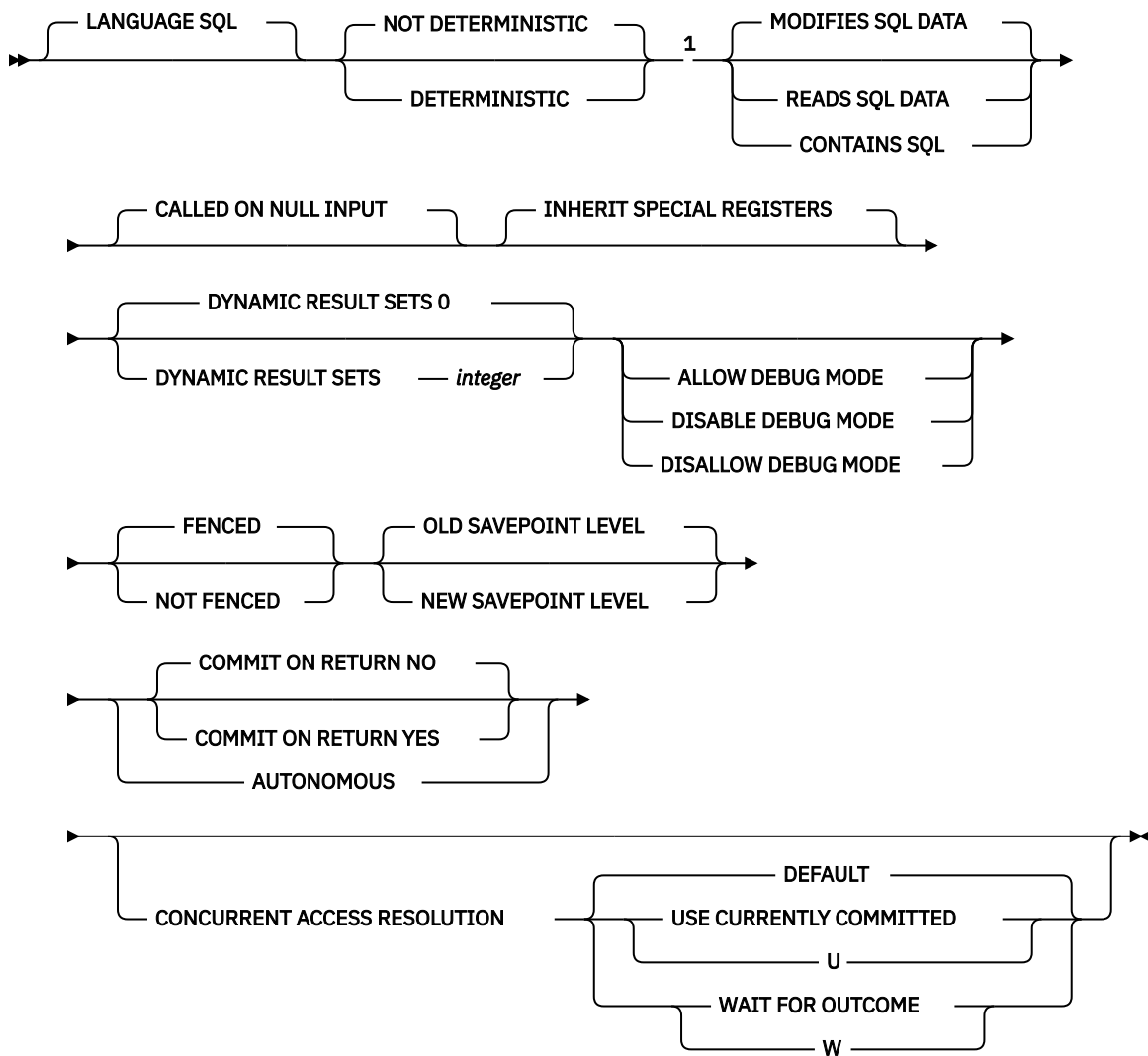

Notes:

¹ The clauses in the *option-list* can be specified in any order.

SQL-routine-body

<i>SQL-control-statement</i>
<i>ALLOCATE CURSOR-statement</i>
<i>ALLOCATE DESCRIPTOR-statement</i>
<i>ALTER FUNCTION-statement</i>
<i>ALTER MASK-statement</i>
<i>ALTER PERMISSION-statement</i>
<i>ALTER PROCEDURE-statement</i>
<i>ALTER SEQUENCE-statement</i>
<i>ALTER TABLE-statement</i>
<i>ALTER TRIGGER-statement</i>
<i>ASSOCIATE LOCATORS-statement</i>
<i>COMMENT-statement</i>
<i>COMMIT-statement</i>
<i>CONNECT-statement</i>
<i>CREATE ALIAS-statement</i>
<i>CREATE FUNCTION (external scalar)-statement</i>
<i>CREATE FUNCTION (external table)-statement</i>
<i>CREATE FUNCTION (sourced)-statement</i>
<i>CREATE INDEX-statement</i>
<i>CREATE MASK-statement</i>
<i>CREATE PERMISSION-statement</i>
<i>CREATE PROCEDURE (external)-statement</i>
<i>CREATE SCHEMA-statement</i>
<i>CREATE SEQUENCE-statement</i>
<i>CREATE TABLE-statement</i>
<i>CREATE TYPE-statement</i>
<i>CREATE VIEW-statement</i>
<i>DEALLOCATE DESCRIPTOR-statement</i>
<i>DECLARE GLOBAL TEMPORARY TABLE-statement</i>
<i>DELETE-statement</i>
<i>DESCRIBE-statement</i>
<i>DESCRIBE CURSOR-statement</i>
<i>DESCRIBE INPUT-statement</i>
<i>DESCRIBE PROCEDURE-statement</i>
<i>DESCRIBE TABLE-statement</i>
<i>DISCONNECT-statement</i>

SQL-routine-body (continued)

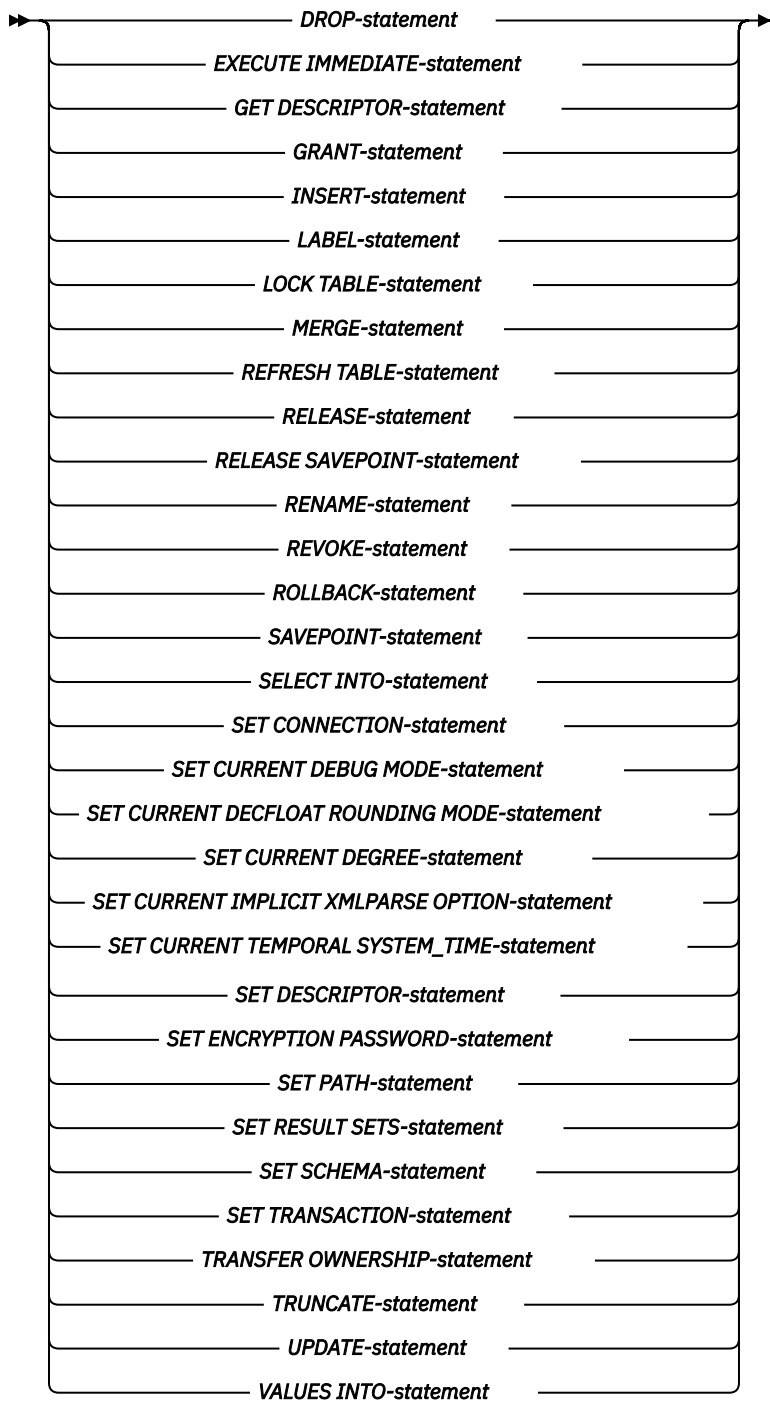

built-in-type

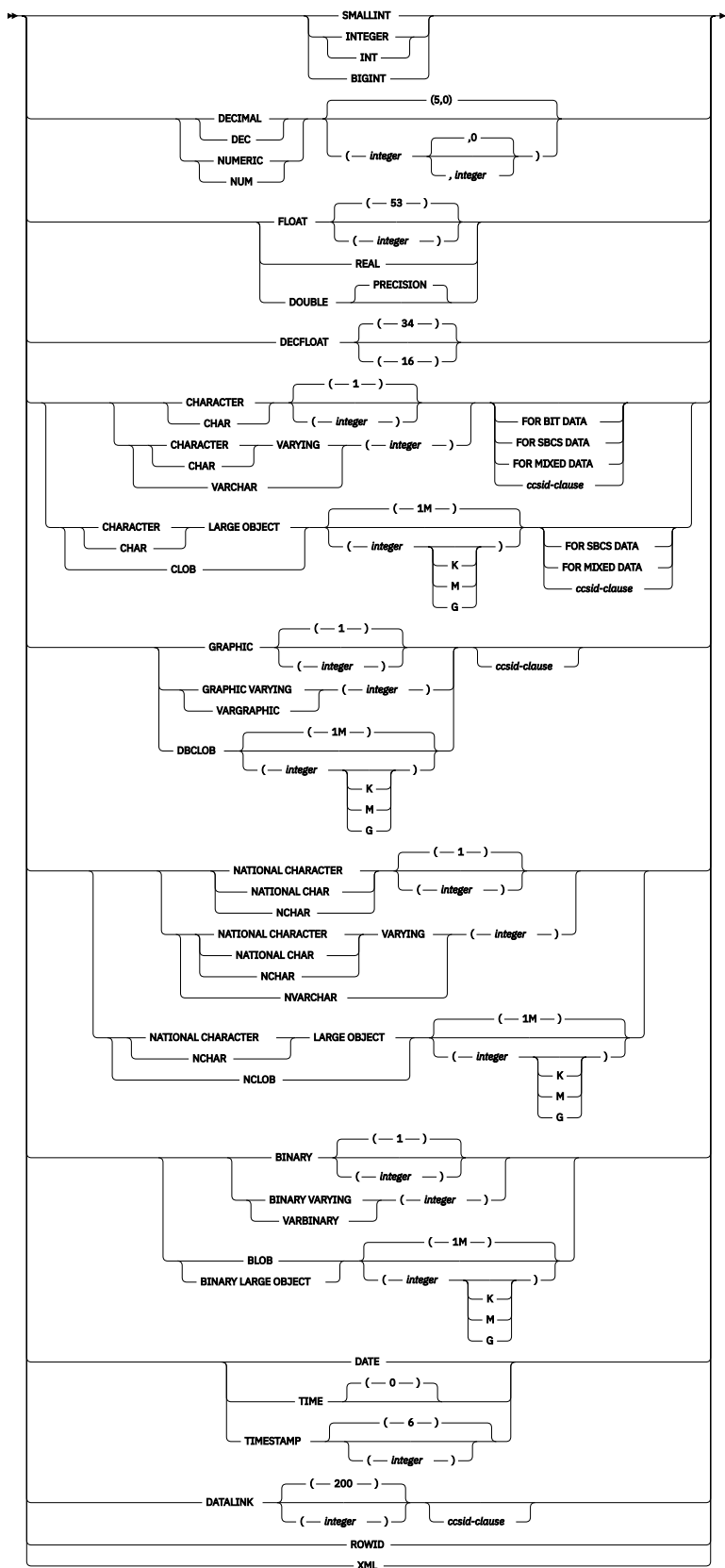

ccsid-clause

➤ CCSID — *integer* ➤

Description

PROCEDURE or SPECIFIC PROCEDURE

Identifies the procedure to alter. *procedure-name* must identify an SQL procedure that exists at the current server.

The specified procedure is altered. The owner of the procedure and all privileges on the procedure are preserved.

PROCEDURE *procedure-name*

Identifies the procedure by its name. The *procedure-name* must identify exactly one SQL procedure. The procedure may have any number of parameters defined for it. If there is more than one procedure of the specified name in the specified or implicit schema, an error is returned.

PROCEDURE *procedure-name (parameter-type,...)*

Identifies the procedure by its procedure signature, which uniquely identifies the procedure. The *procedure-name (parameter-type,...)* must identify an SQL procedure with the specified procedure signature. The specified parameters must match the data types in the corresponding position that were specified when the procedure was created. The number of data types and the logical concatenation of the data types is used to identify the specific procedure instance which is being altered. Synonyms for data types are considered a match. Parameters that have defaults must be included in this signature.

If *procedure-name()* is specified, the procedure identified must have zero parameters.

procedure-name

Identifies the name of the procedure.

(parameter-type,...)

Identifies the parameters of the procedure.

If an unqualified distinct type or array type name is specified, the database manager searches the SQL path to resolve the schema name for the distinct type or array type.

For data types that have a length, precision, or scale attribute, use one of the following:

- Empty parenthesis indicates that the database manager ignores the attribute when determining whether the data types match. For example, DEC() will be considered a match for a parameter of a procedure defined with a data type of DEC(7,2). However, FLOAT cannot be specified with empty parenthesis because its precision value indicates a specific data type (REAL or DOUBLE).
- If a specific value for a length, precision, or scale attribute is specified, the value must exactly match the value that was specified (implicitly or explicitly) in the CREATE PROCEDURE statement. If the data type is FLOAT, the precision does not have to exactly match the value that was specified because matching is based on the data type (REAL or DOUBLE).
- If length, precision, or scale is not explicitly specified, and empty parentheses are not specified, the default attributes of the data type are implied. The implicit length must exactly match the value that was specified (implicitly or explicitly) in the CREATE PROCEDURE statement.

Specifying the FOR DATA clause or CCSID clause is optional. Omission of either clause indicates that the database manager ignores the attribute when determining whether the data types match. If either clause is specified, it must match the value that was implicitly or explicitly specified in the CREATE PROCEDURE statement.

AS LOCATOR

Specifies that the procedure is defined to receive a locator for this parameter. If AS LOCATOR is specified, the data type must be a LOB or a distinct type based on a LOB.

SPECIFIC PROCEDURE *specific-name*

Identifies the procedure by its specific name. The *specific-name* must identify a specific procedure that exists at the current server.

ALTER *option-list*

Indicates that one or more of the options of the procedure are to be altered. If ALTER PROCEDURE ALTER *option-list* is specified and an option is not specified, the value from the existing procedure definition is used. See [“CREATE PROCEDURE \(SQL\)” on page 1080](#) for a description of each option.

REPLACE *routine-specification*

Indicates that the existing procedure definition, including options and parameters, is to be replaced by those specified in this statement. The values of all options are replaced when a procedure is replaced. If an option is not specified, the same default is used as when a new SQL procedure is created, for more information see [“CREATE PROCEDURE \(SQL\)” on page 1080](#).

If the routine has a comment or label, they are removed from the routine definition.

(*parameter-declaration*,...)

Specifies the number of parameters of the procedure, the data type of each parameter, and the name of each parameter. A parameter for a procedure can be used for input only, for output only, or for both input and output.

The maximum number of parameters allowed in an SQL procedure is 2000.

IN

Identifies the parameter as an input parameter to the procedure.

OUT

Identifies the parameter as an output parameter that is returned by the procedure. If the parameter is not set within the procedure, the null value is returned.

INOUT

Identifies the parameter as both an input and output parameter for the procedure. If the parameter is not set within the procedure, its input value is returned. If an INOUT parameter is defined with a default and the default is used when calling the procedure, no value for the parameter is returned.

parameter-name

Names the parameter for use as an SQL variable. The name cannot be the same as any other *parameter-name* for the procedure.

data-type

Specifies the data type of the parameter. If a CCSID is specified, the parameter will be converted to that CCSID prior to passing it to the procedure. If a CCSID is not specified, the CCSID is determined by the default CCSID at the current server at the time the procedure is called.

default-clause

Specifies a default value for the parameter. The default can be a constant, a special register, a global variable, an expression, or the keyword NULL. The expression is any expression defined in [“Expressions” on page 159](#), that does not include an aggregate function or column name. If a default value is not specified, the parameter has no default and cannot be omitted on invocation. The maximum length of the expression string is 64K.

The default expression must not modify SQL data. The expression must be assignment compatible to the parameter data type. All objects referenced in a default expression must exist when the procedure is created.

Any comma in the default expression that is intended as a separator of numeric constants in a list must be followed by a space.

A default cannot be specified:

- for an OUT parameter.
- for a parameter of type array.

option-list

List of options for the procedure being altered. These options are the same ones that are listed above under ALTER *option-list*. If a specific option is not specified, the same default that is used when a new procedure is created is used. For more information see [“CREATE PROCEDURE \(SQL\)” on page 1080](#).

SET OPTION-statement

Specifies the options that will be used to create the procedure. For example, to create a debuggable procedure, the following statement could be included:

```
SET OPTION DBGVIEW = *SOURCE
```

For more information, see [“SET OPTION” on page 1505](#).

The options CLOSQLCSR, CNULRQD, COMPILEOPT, NAMING, and SQLCA are not allowed in the ALTER PROCEDURE statement. The following options are used when processing default value expressions: ALWCPYDTA, CONACC, DATFMT, DATSEP, DECFLTRND, DECMPT, DECRESULT, DFTRDBCOL, LANGID, SQLCURRULE, SQLPATH, SRTSEQ, TGTRLS, TIMFMT, and TIMSEP.

SQL-routine-body

Specifies a single SQL statement, including a compound statement. See [“SQL control statements” on page 1569](#) for more information about defining SQL procedures.

CONNECT, SET CONNECTION, RELEASE, DISCONNECT, and SET TRANSACTION statements are not allowed in a procedure that is running on a remote application server. COMMIT and ROLLBACK statements are not allowed in an ATOMIC SQL procedure or in a procedure that is running on a connection to a remote application server.

ALTER PROCEDURE (SQL), ALTER FUNCTION (SQL scalar), and ALTER FUNCTION (SQL table) with a REPLACE keyword are not allowed in an *SQL-routine-body*.

Notes

General considerations for defining or replacing procedures: See CREATE PROCEDURE for general information about defining a procedure. ALTER PROCEDURE (SQL) allows individual attributes or the routine specification to be altered while preserving the privileges on the procedure.

Alter Procedure Replace considerations: When an SQL procedure definition is replaced, SQL creates a temporary source file that will contain C source code with embedded SQL statements. A program object is then created using the CRTPGM command. The SQL options used to create the program are the options that are in effect at the time the ALTER PROCEDURE (SQL) statement is executed. The program is created with ACTGRP(*CALLER).

When an SQL procedure is altered, a new *PGM or *SRVPGM object is created and the procedure's attributes are stored in the created program object. If the *PGM or *SRVPGM object is saved and then restored to this or another system, the catalogs are automatically updated with those attributes.

The specific name is used as the name of the member in the source file and the name of the program object, if it is a valid system name. If the procedure name is not a valid system name, a unique name is generated. If a source file member with the same name already exists, the member is overlaid. If a module or a program with the same name already exists, the objects are not overlaid, and a unique name is generated. The unique names are generated according to the rules for generating system table names.

Target release considerations: When an SQL procedure definition is replaced, the target release will be the current release in which the ALTER statement is executed unless the user explicitly specifies a different target release. The target release can be explicitly specified using the TGTRLS keyword in the SET OPTION statement. If the ALTER is specified in the source for a RUNSQLSTM or CRTSQLxxx command, the TGTRLS keyword can also be specified on the command.

If the procedure definition is not replaced, the target release of the existing procedure will be preserved unless the target release level of the procedure is earlier than the earliest supported release level. In this case, the target release will be changed to the earliest supported release level.

Obfuscated statements: A procedure that was created using an obfuscated statement can be altered. When the statement is altered the encoded version of the statement that is saved in the catalog is modified and could exceed the maximum length for an SQL statement. If this happens an error will be issued and the alter will fail.

Syntax alternatives: The following keywords are synonyms supported for compatibility to prior releases. These keywords are non-standard and should not be used:

- The keywords VARIANT and NOT VARIANT can be used as synonyms for NOT DETERMINISTIC and DETERMINISTIC.
- The keywords NULL CALL can be used as synonyms for CALLED ON NULL INPUT.
- DYNAMIC RESULT SET, RESULT SETS, and RESULT SET may be used as synonyms for DYNAMIC RESULT SETS.

Examples

Modify the definition for an SQL procedure so that SQL changes are committed on return from the SQL procedure.

```
ALTER PROCEDURE UPDATE_SALARY_2  
ALTER COMMIT ON RETURN YES
```

ALTER SEQUENCE

The ALTER SEQUENCE statement can be used to change a sequence.

The ALTER SEQUENCE statement can be used to change a sequence in any of these ways:

- Restarting the sequence
- Changing the increment between future sequence values
- Setting or eliminating the minimum or maximum values
- Changing the number of cached sequence numbers
- Changing the attribute that determines whether the sequence can cycle or not
- Changing whether sequence numbers must be generated in order of request

Invocation

This statement can be embedded in an application program or issued interactively. It is an executable statement that can be dynamically prepared.

Authorization

The privileges held by the authorization ID of the statement must include at least one of the following:

- For the sequence identified in the statement:
 - The USAGE privilege on the schema containing the sequence
 - The ALTER privilege for the sequence
- Database administrator authority

The privileges held by the authorization ID of the statement must include at least one of the following:

- The following system authorities:
 - *USE to the Change Data Area (CHGDTAARA) command
 - *USE to the Retrieve Data Area (RTVDTAARA) command
- Administrative authority

The privileges held by the authorization ID of the statement must include at least one of the following:

- For the SYSSEQOBJECTS catalog table:
 - The UPDATE privilege on the table, and
 - The USAGE privilege on schema QSYS2
- Administrative authority

If a distinct type is referenced, the privileges held by the authorization ID of the statement must include at least one of the following:

- For the distinct type identified in the statement:
 - The USAGE privilege on the distinct type, and
 - The USAGE privilege on the schema containing the distinct type
- Administrative authority

For information on the system authorities corresponding to SQL privileges, see [Corresponding System Authorities When Checking Privileges to a Sequence](#), [Corresponding System Authorities When Checking Privileges to a Table or View](#), and [Corresponding System Authorities When Checking Privileges to a Distinct Type](#).

Syntax

➤ ALTER SEQUENCE — *sequence-name* ➔

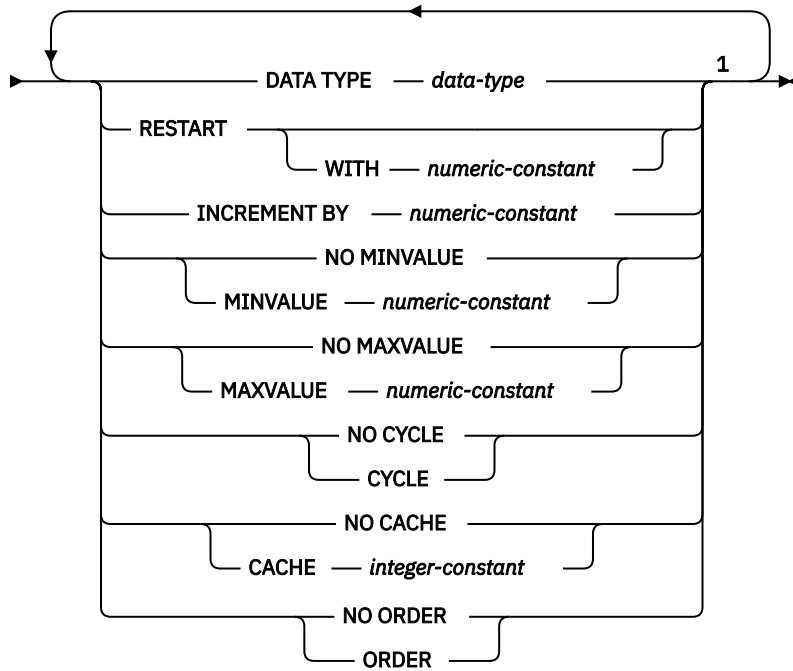

Notes:

¹ The same clause must not be specified more than once.

data-type

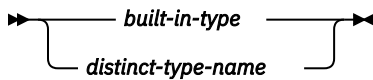

built-in-type

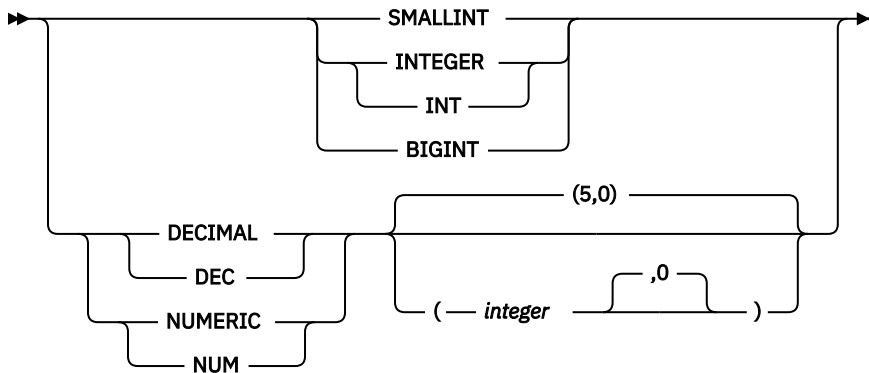

Description

sequence-name

Identifies the sequence to be altered. The name must identify a sequence that already exists at the current server.

DATA TYPE data-type

Specifies the new data type to be used for the sequence value. The data type can be any exact numeric type (SMALLINT, INTEGER, BIGINT, DECIMAL, or NUMERIC) with a scale of zero, or a user-defined distinct type for which the source type is an exact numeric type with a scale of zero.

Each of the existing START WITH, INCREMENT BY, MINVALUE, and MAXVALUE attributes that are not changed by the ALTER SEQUENCE statement must contain a value that could be assigned to a column of the data type associated with the new data type.

built-in-type

Specifies the new built-in data type used as the basis for the internal representation of the sequence. If the data type is DECIMAL or NUMERIC, the precision must be less than or equal to 63 and the scale must be 0. See [“CREATE TABLE” on page 1105](#) for a more complete description of each built-in data type.

For portability of applications across platforms, use DECIMAL instead of a NUMERIC data type.

distinct-type-name

Specifies that the new data type of the sequence is a distinct type (a user-defined data type). If the source type is DECIMAL or NUMERIC, the precision of the sequence is the precision of the source type of the distinct type. The precision of the source type must be less than or equal to 63 and the scale must be 0. If a distinct type name is specified without a schema name, the distinct type name is resolved by searching the schemas on the SQL path.

RESTART

Restarts the sequence. If *numeric-constant* is not specified, the sequence is restarted at the value specified implicitly or explicitly as the starting value on the CREATE SEQUENCE statement that originally created the sequence.

WITH numeric-constant

Restarts the sequence with the specified value. This value can be any positive or negative value that could be assigned to a column of the data type associated with the sequence, without nonzero digits to the right of the decimal point.

INCREMENT BY *numeric-constant*

Specifies the interval between consecutive values of the sequence. This value can be any positive or negative value that could be assigned to a column of the data type associated with the sequence, and does not exceed the value of a large integer constant, without nonzero digits existing to the right of the decimal point.

If this value is negative, then this is a descending sequence. If this value is 0 or positive, this is an ascending sequence after the ALTER statement.

NO MINVALUE or MINVALUE

Specifies the minimum value at which a descending sequence either cycles or stops generating values, or an ascending sequence cycles to after reaching the maximum value.

NO MINVALUE

For an ascending sequence, the value is the original starting value. For a descending sequence, the value is the minimum value of the data type (and precision, if DECIMAL or NUMERIC) associated with the sequence.

MINVALUE *numeric-constant*

Specifies the numeric constant that is the minimum value that is generated for this sequence. This value can be any positive or negative value that could be assigned to a column of the data type associated with the sequence and without non-zero digits to the right of the decimal point. The value must be less than or equal to the maximum value.

NO MAXVALUE or MAXVALUE

Specifies the maximum value at which an ascending sequence either cycles or stops generating values, or a descending sequence cycles to after reaching the minimum value.

NO MAXVALUE

For an ascending sequence, the value is the maximum value of the data type (and precision, if DECIMAL or NUMERIC) associated with the sequence. For a descending sequence, the value is the original starting value.

MAXVALUE *numeric-constant*

Specifies the numeric constant that is the maximum value that is generated for this sequence. This value can be any positive or negative value that could be assigned to a column of the data

type associated with the sequence and without non-zero digits to the right of the decimal point. The value must be greater than or equal to the minimum value.

CYCLE or NO CYCLE

Specifies whether this sequence should continue to generate values after reaching either the maximum or minimum value of the sequence.

NO CYCLE

Specifies that values will not be generated for the sequence once the maximum or minimum value for the sequence has been reached.

CYCLE

Specifies that values continue to be generated for this sequence after the maximum or minimum value has been reached. If this option is used, after an ascending sequence reaches the maximum value of the sequence, it generates its minimum value. After a descending sequence reaches its minimum value of the sequence, it generates its maximum value. The maximum and minimum values for the sequence determine the range that is used for cycling.

When CYCLE is in effect, duplicate values can be generated for a sequence by the database manager.

CACHE or NO CACHE

Specifies whether to keep some preallocated values in memory. Preallocating and storing values in the cache improves the performance of the NEXT VALUE sequence expression.

CACHE *integer-constant*

Specifies the maximum number of sequence values that are preallocated and kept in memory. Preallocating and storing values in the cache reduces synchronous I/O when values are generated for the sequence.

In certain situations, such as system failure, all cached sequence values that have not been used in committed statements are lost, and thus, will never be used. The value specified for the CACHE option is the maximum number of sequence values that could be lost in these situations.

The minimum value is 2.

NO CACHE

Specifies that values of the sequence are not to be preallocated. It ensures that there is not a loss of values in situations, such as system failure. When this option is specified, the values of the sequence are not stored in the cache. In this case, every request for a new value for the sequence results in synchronous I/O.

NO ORDER or ORDER

Specifies whether the sequence numbers must be generated in order of request.

NO ORDER

Specifies that the sequence numbers do not need to be generated in order of request.

ORDER

Specifies that the sequence numbers are generated in order of request. If ORDER is specified, the performance of the NEXT VALUE sequence expression will be worse than if NO ORDER is specified.

Notes

Altering a sequence:

- Only future sequence numbers are affected by the ALTER SEQUENCE statement.
- All the cached values are lost when a sequence is altered.
- After restarting a sequence or changing it to cycle, it is possible that a generated value will duplicate a value previously generated for that sequence.

Syntax alternatives: The following keywords are synonyms supported for compatibility to prior releases of other Db2 products. These keywords are non-standard and should not be used:

- The keywords NOMINVALUE, NOMAXVALUE, NOCYCLE, NOCACHE, and NOORDER can be used as synonyms for NO MINVALUE, NO MAXVALUE, NO CYCLE, NO CACHE, and NO ORDER.

Examples

A possible reason for specifying RESTART without a numeric value would be to reset the sequence to the START WITH value. In this example, the goal is to generate the numbers from 1 up to the number of rows in a table and then inserting the numbers into a column added to the table using temporary tables.

```
ALTER SEQUENCE ORG_SEQ RESTART  
  
DECLARE GLOBAL TEMPORARY TABLE TEMP_ORG AS  
  (SELECT NEXT VALUE FOR ORG_SEQ, ORG.*  
   FROM ORG) WITH DATA  
  
INSERT INTO TEMP_ORG  
  (SELECT NEXT VALUE FOR ORG_SEQ, ORG.*  
   FROM ORG
```

Another use would be to get results back where all the resulting rows are numbered:

```
ALTER SEQUENCE ORG_SEQ RESTART  
  
SELECT NEXT VALUE FOR ORG_SEQ, ORG.*  
FROM ORG
```

ALTER TABLE

The ALTER TABLE statement alters the definition of a table.

Invocation

This statement can be embedded in an application program or issued interactively. It is an executable statement that can be dynamically prepared.

Authorization

The privileges held by the authorization ID of the statement must include at least one of the following:

- For the table identified in the statement,
 - The ALTER privilege on the table, and
 - The USAGE privilege on the schema containing the table
- Database administrator authority

To define a foreign key, the privileges held by the authorization ID of the statement must include at least one of the following on the parent table:

- The REFERENCES privilege or object management authority for the table
- The REFERENCES privilege on each column of the specified parent key
- Database administrator authority

If a field procedure is defined, the privileges held by the authorization ID of the statement must include at least one of the following:

- The following system authorities:
 - The system authority *EXECUTE on the program, and
 - The USAGE privilege on the schema containing the program
- Database administrator authority

If a *select-statement* is specified, the privileges held by the authorization ID of the statement must include at least one of the following on the tables or views specified in these clauses:

- The SELECT privilege for the table or view
- Database administrator authority

If a distinct type is referenced, the privileges held by the authorization ID of the statement must include at least one of the following:

- For each distinct type identified in the statement:
 - The USAGE privilege on the distinct type, and
 - The USAGE privilege on the schema containing the distinct type
- Database administrator authority

If an ACTIVATE or DEACTIVATE clause is specified:

- The authorization ID of the statement must have security administrator authority. See [“Administrative authority” on page 15](#).

To drop a partition from a table that has active row permissions with DELETE ROWS, the privileges held by the authorization ID of the statement must include at least one of the following:

- The system authorities of *OBJOPR and *OBJEXIST on the table
- Database administrator authority

To attach a partition, the privileges held by the authorization ID of the statement must also include at least one of the following:

- For the source table identified in the statement,
 - The SELECT privilege, and
 - The system authority of *OBJEXIST, and
 - The USAGE privilege on the schema containing the source table
- Database administrator authority

To detach a partition, the privileges held by the authorization ID of the statement must also include at least one of the following:

- For the source table identified in the statement,
 - The SELECT, DELETE, and ALTER privileges, and
 - The USAGE privilege on the schema containing the source table
- Database administrator authority

To detach a partition, the privileges held by the authorization ID of the statement must include at least one of the following:

- The privilege to create in the schema. For more information, see [Privileges necessary to create in a schema](#).
- Database administrator authority

To alter a table to become a system-period temporal table (with the ADD VERSIONING clause), alter a system-period temporal table when one or more of the changes also result in changes to the associated history table, or to DROP VERSIONING, the privileges that are held by the authorization ID of the statement must also include at least one of the following authorities:

- The following system authorities:
 - The ALTER privilege on the history table, and
 - The USAGE privilege on the schema containing the history table
- Database administrator authority

For information on the system authorities corresponding to SQL privileges, see [Corresponding System Authorities When Checking Privileges to a Table or View](#) and [Corresponding System Authorities When Checking Privileges to a Distinct Type](#).

Syntax

► ALTER TABLE — *table-name* ►

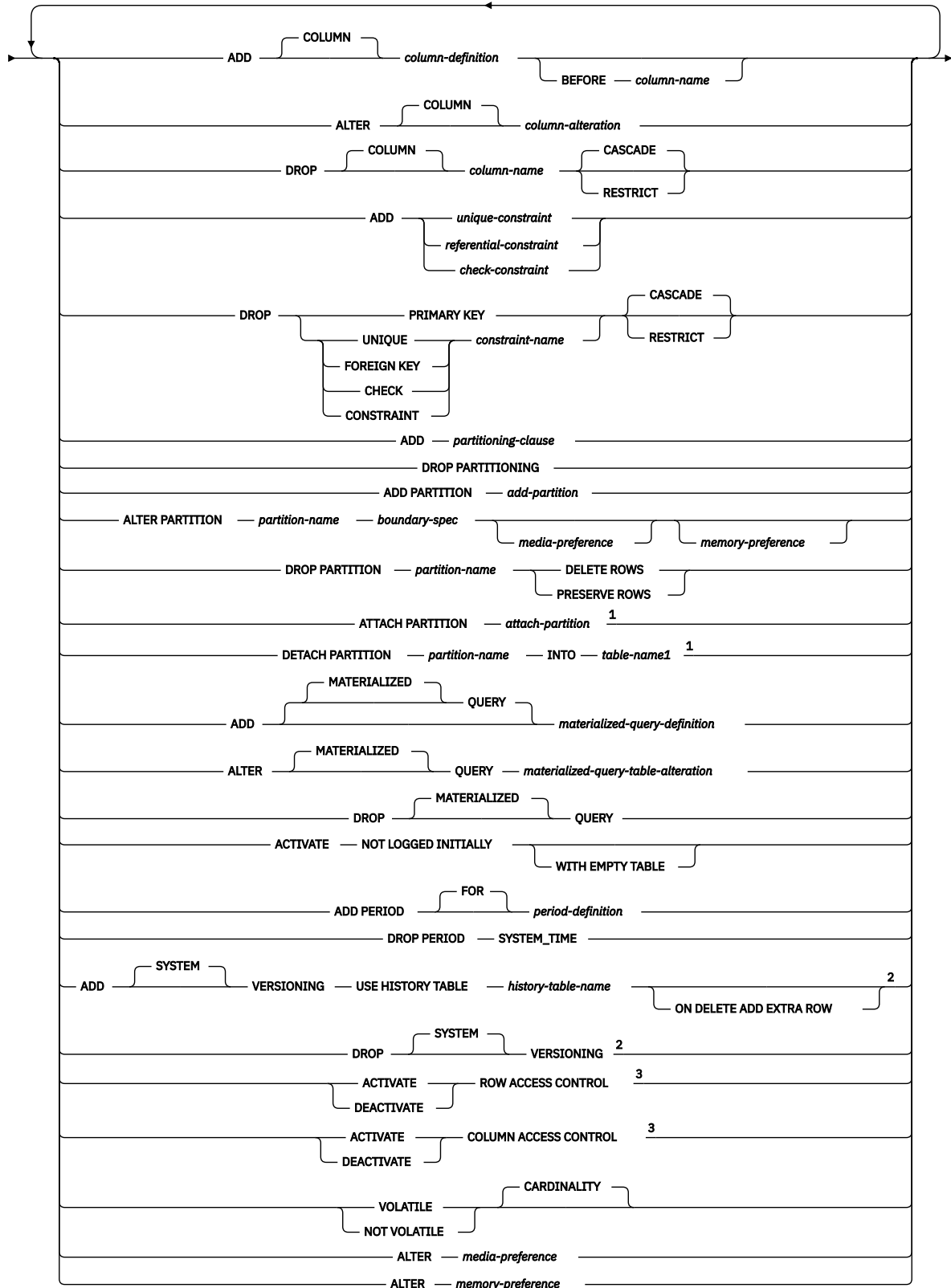

media-preference

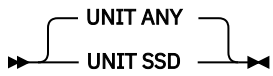

memory-preference

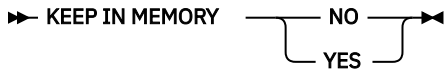

column-definition

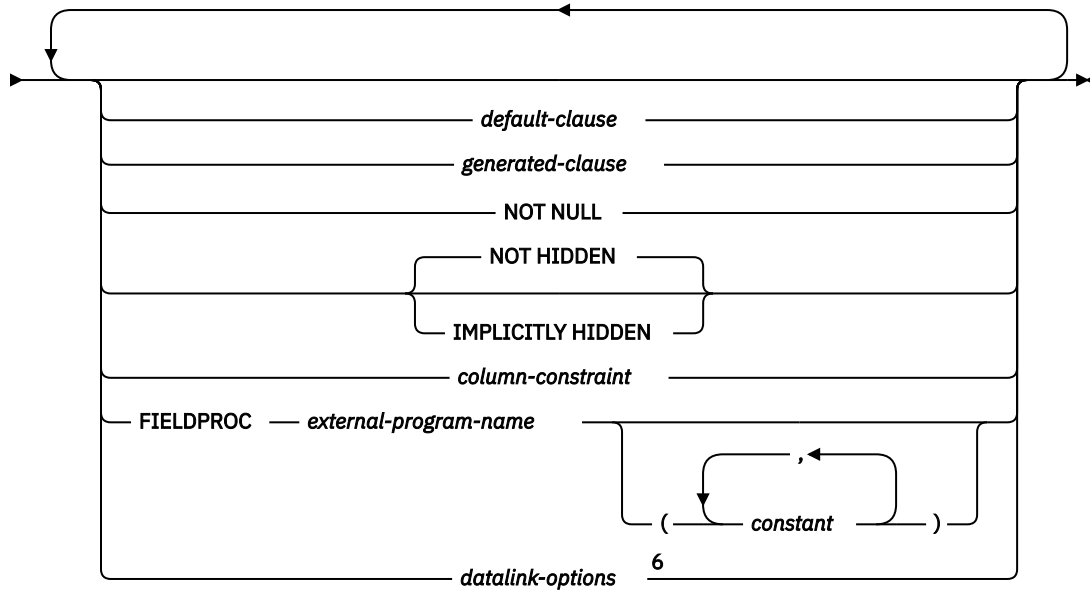
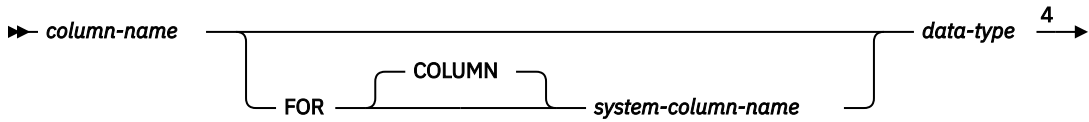

data-type

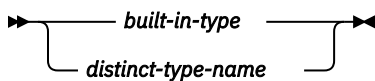

Notes:

- ¹ ATTACH PARTITION or DETACH PARTITION cannot be specified with any other clause.
- ² ADD VERSIONING or DROP VERSIONING cannot be specified with any other clause.
- ³ If an ACTIVATE or DEACTIVATE clause is specified, clauses other than ACTIVATE or DEACTIVATE are not allowed on the ALTER TABLE statement. Each clause must not be specified more than once.
- ⁴ *data-type* is optional for row change timestamp, row-begin, row-end, and transaction-start-ID columns.
- ⁵ The same clause must not be specified more than once.
- ⁶ The *datalink-options* can only be specified for DATALINKs and distinct types sourced on DATALINKs.

built-in-type

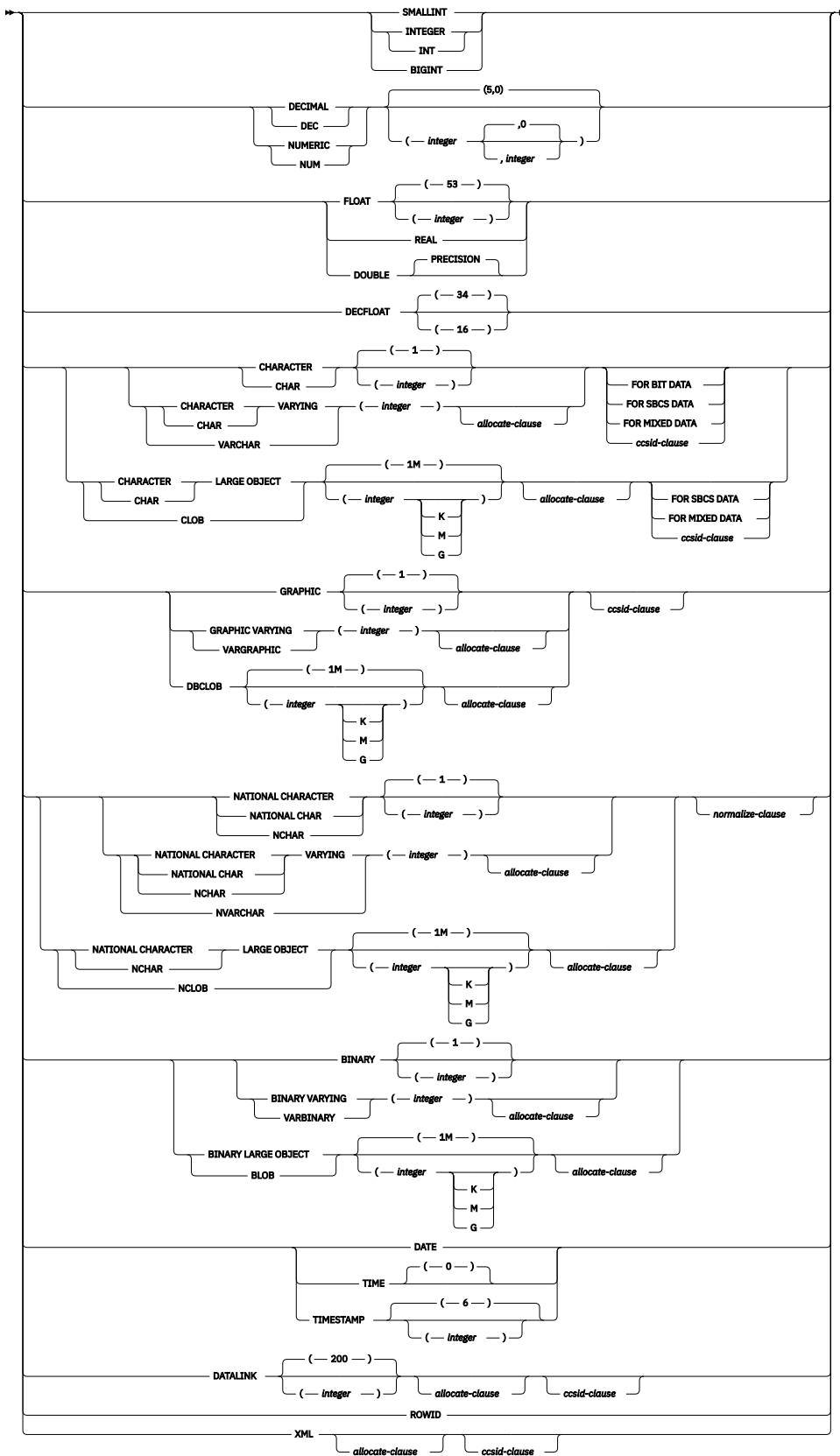

allocate-clause

➔ ALLOCATE — (*integer*) ➔

ccsid-clause

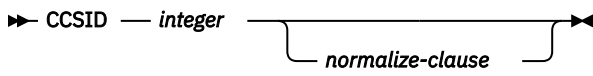

normalize-clause

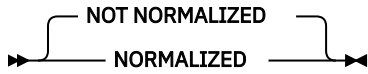

default-clause

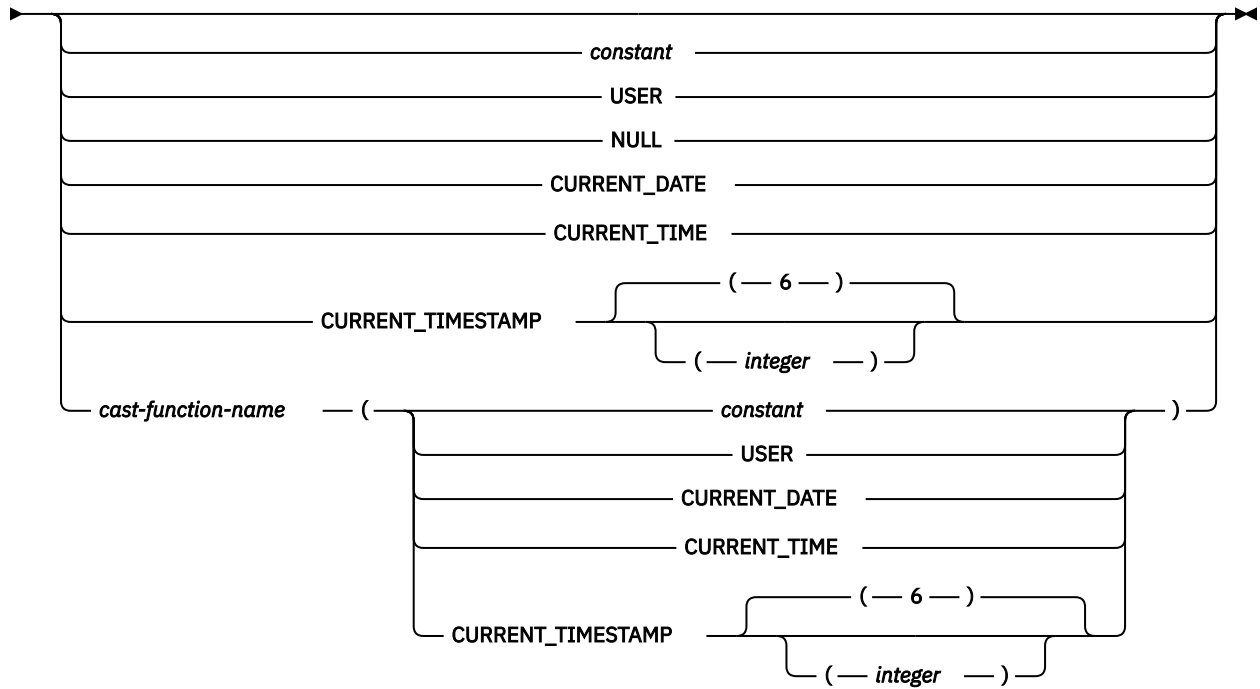

generated-clause

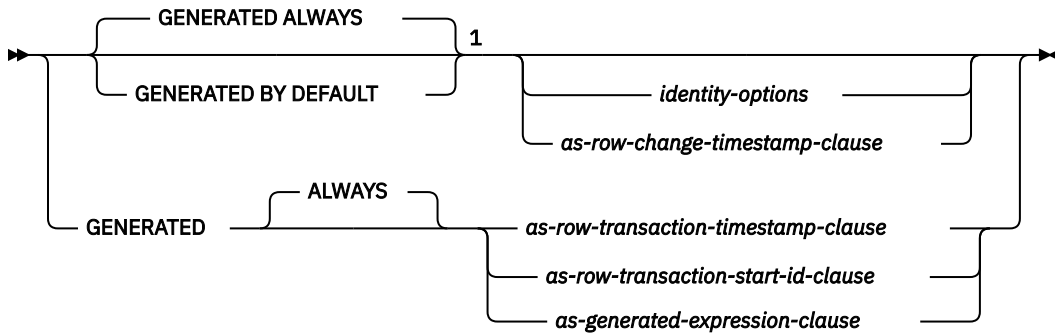

identity-options

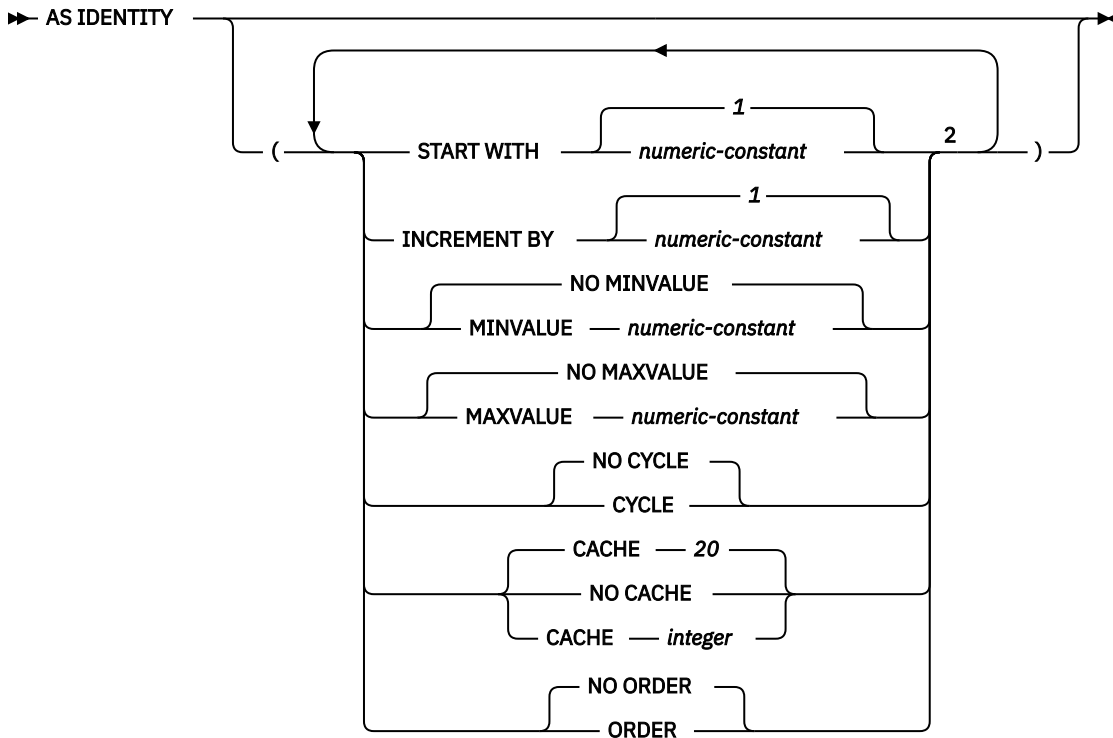

as-row-change-timestamp-clause

FOR EACH ROW ON UPDATE AS ROW CHANGE TIMESTAMP

as-row-transaction-timestamp-clause

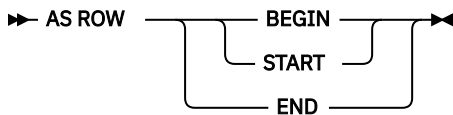

as-row-transaction-start-id-clause

AS TRANSACTION START ID

as-generated-expression-clause

AS (non-deterministic-expression)

non-deterministic-expression

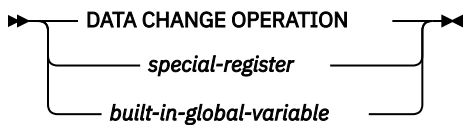

special-register

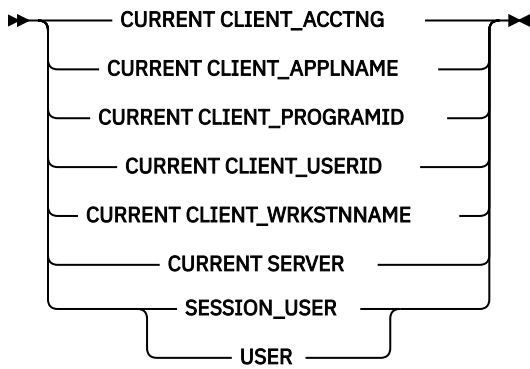

built-in-global-variable

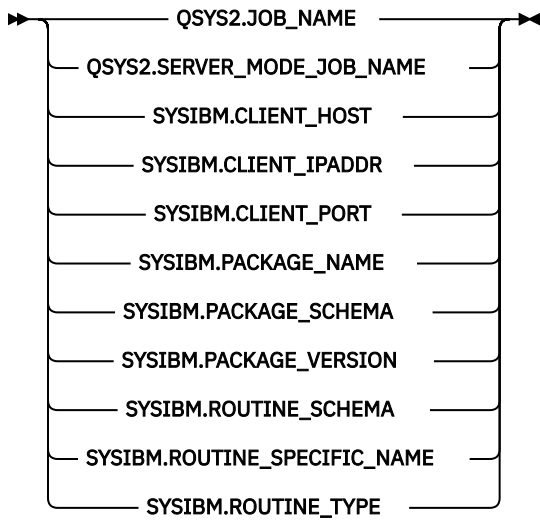

column-constraint

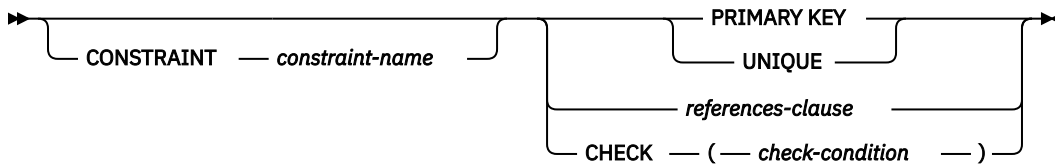

datalink-options

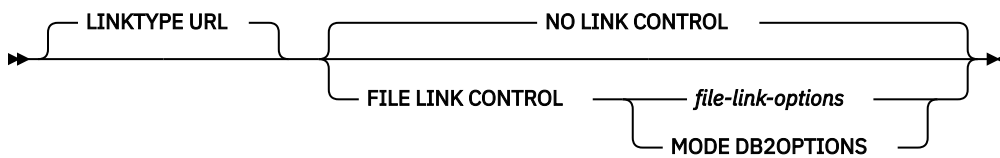

file-link-options

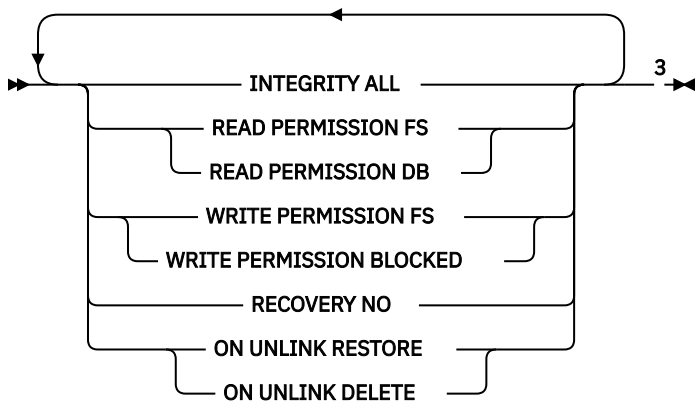

column-alteration

► *column-name* →

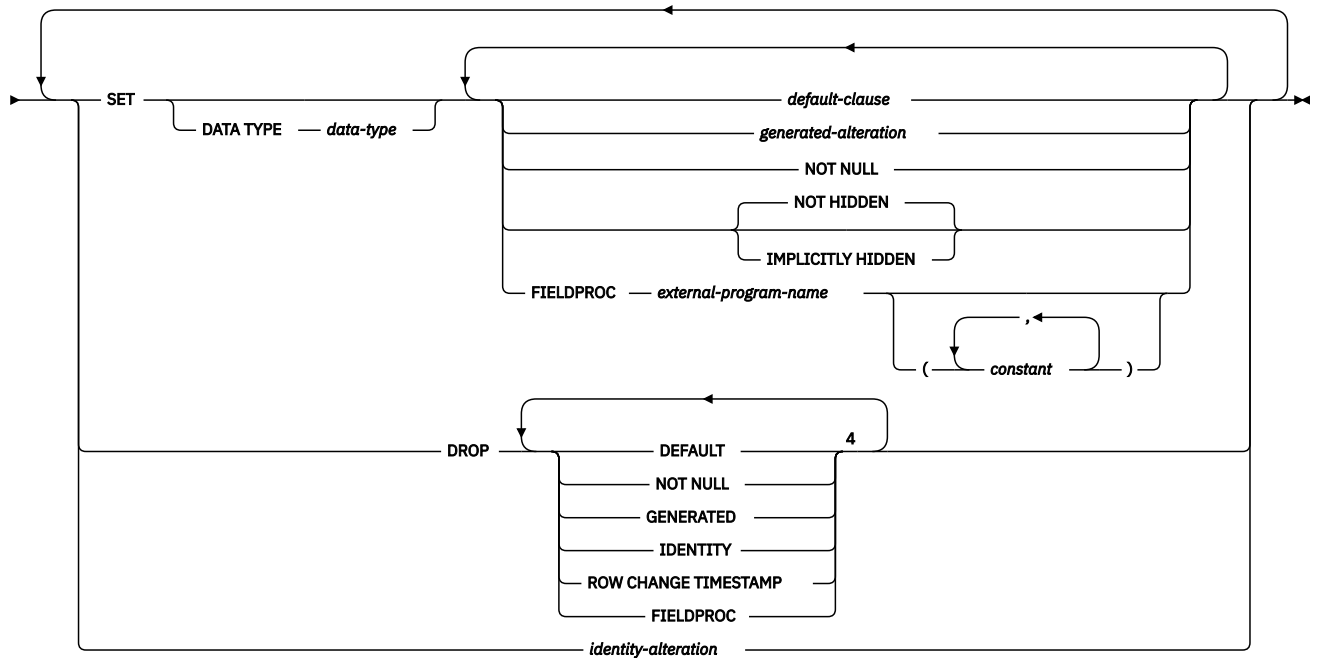

generated-alteration

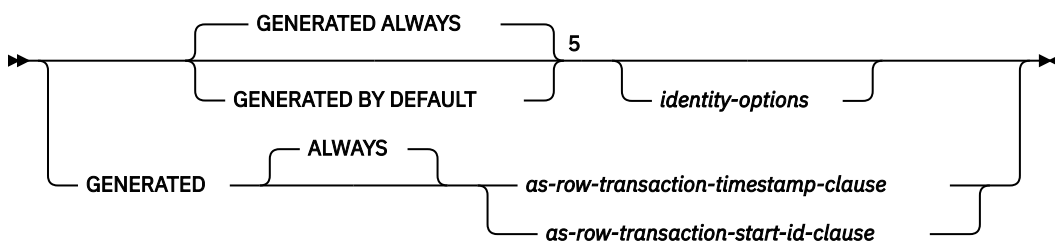

identity-alteration

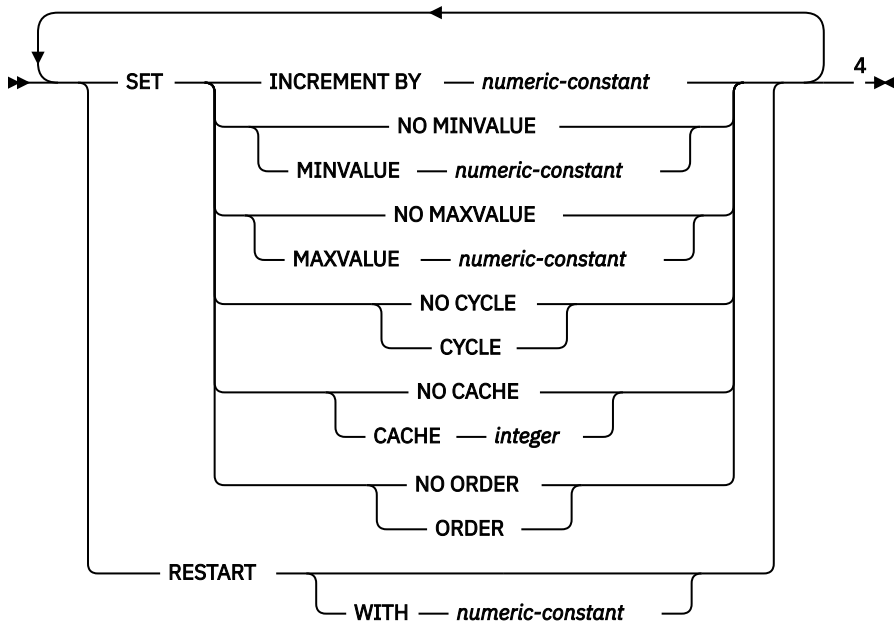

unique-constraint

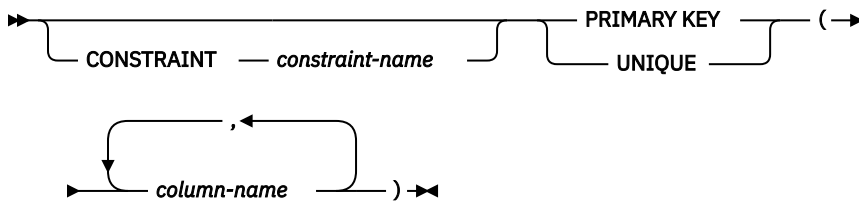

referential-constraint

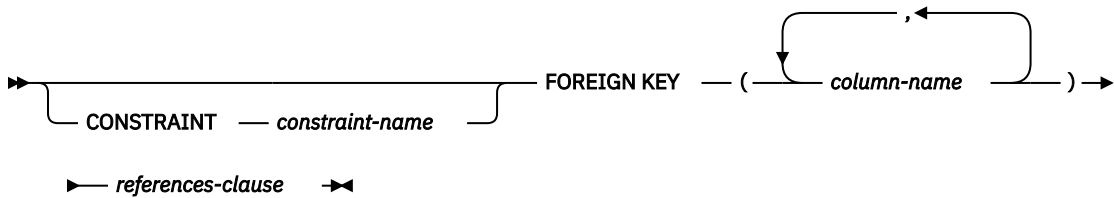

references-clause

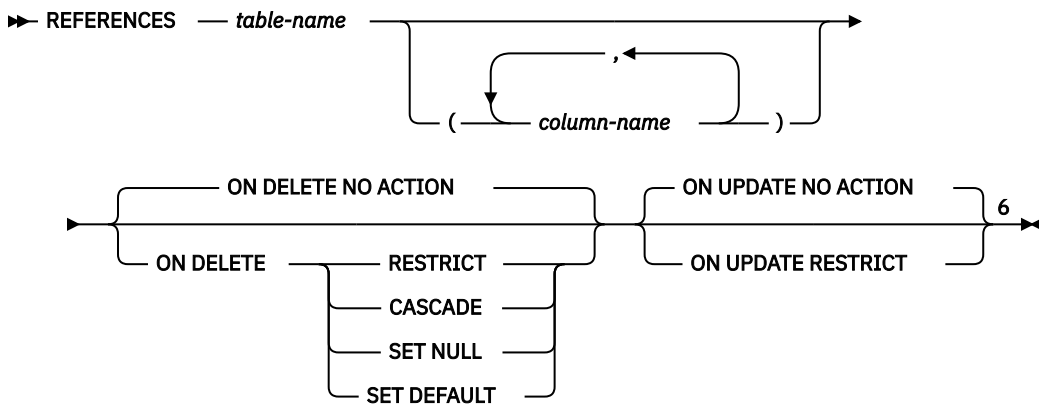

check-constraint

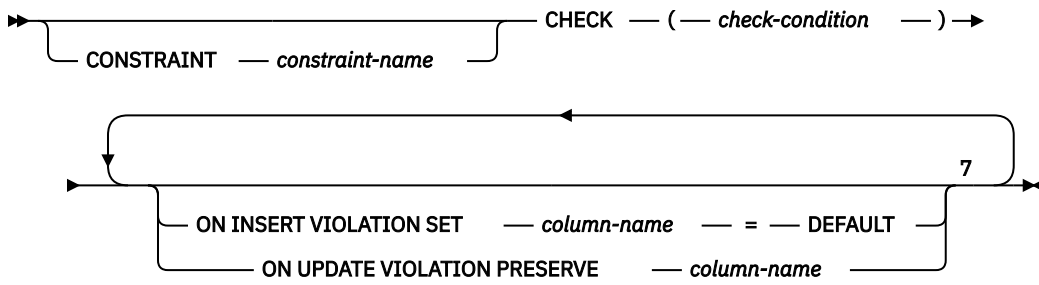

period-definition

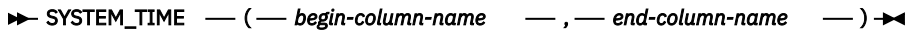

partitioning-clause

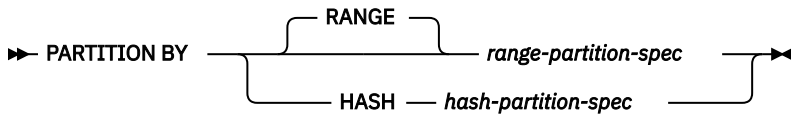

range-partition-spec

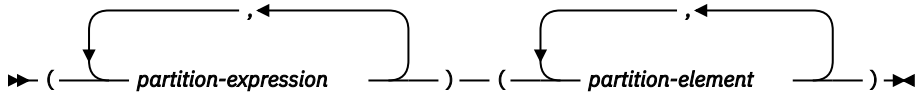

partition-expression

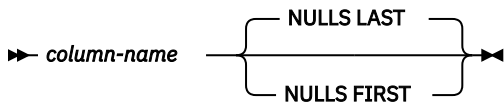

partition-element

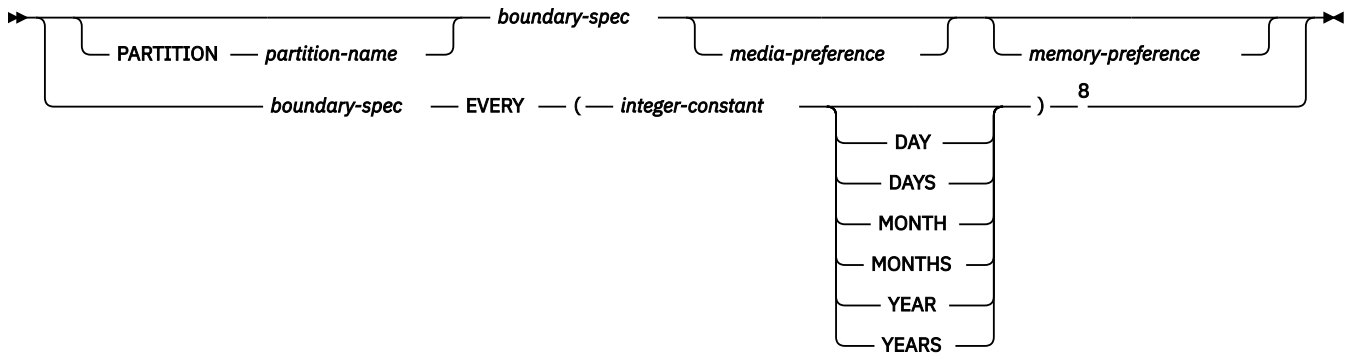

boundary-spec



starting-clause

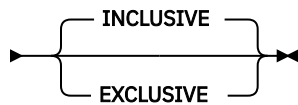
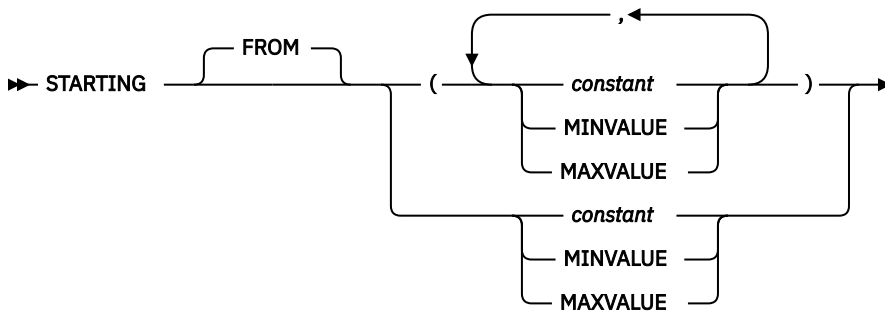

ending-clause

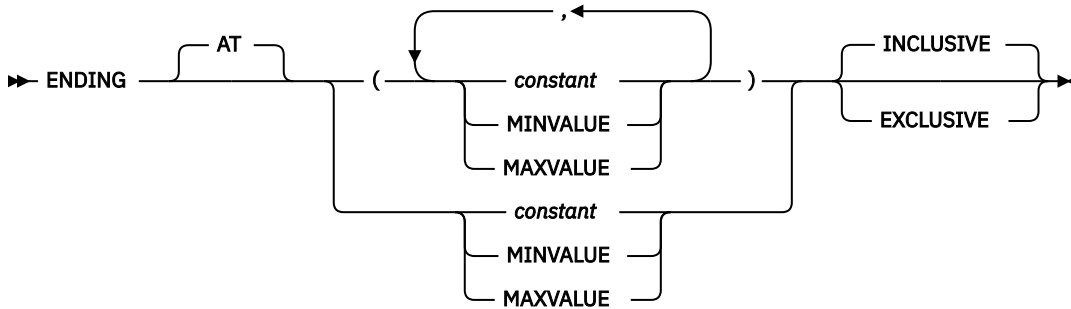

hash-partition-spec

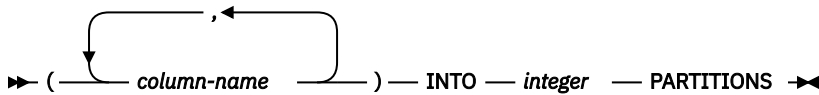

add-partition

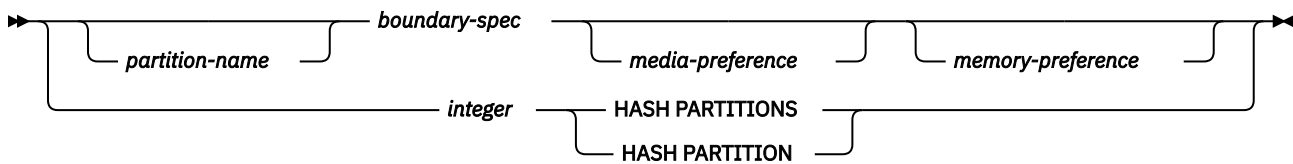

attach-partition

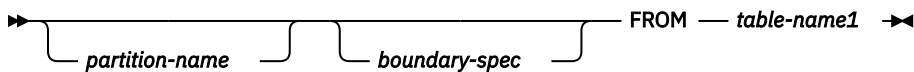

materialized-query-definition

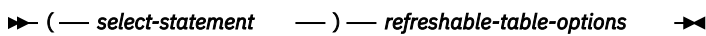

refreshable-table-options

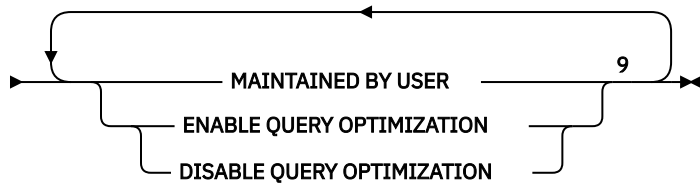
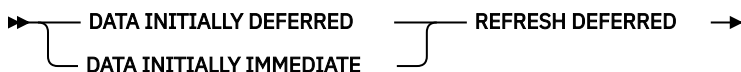

materialized-query-table-alteration

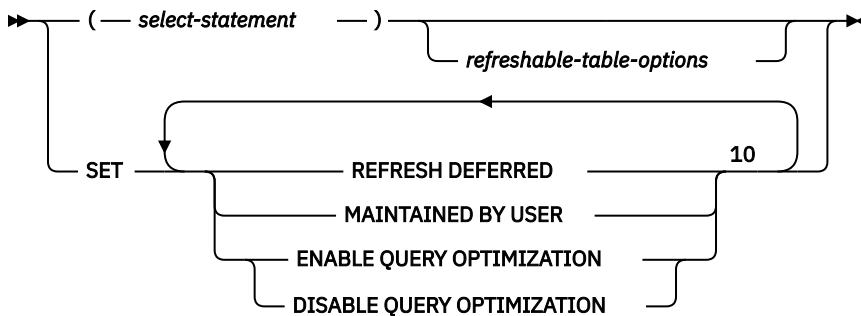

Notes:

- ¹ GENERATED can be specified only if the column has a ROWID data type (or a distinct type that is based on a ROWID data type), or the column is an identity column, or the column is a row change timestamp.
- ² The same clause must not be specified more than once.
- ³ All five *file-link-options* must be specified, but they can be specified in any order.
- ⁴ The same clause must not be specified more than once.
- ⁵ GENERATED can be specified only if the column has a ROWID data type (or a distinct type that is based on a ROWID data type), the column is an identity column, *identity-options* are specified, *as-row-transaction-timestamp-clause* is specified, *as-row-transaction-start-id-clause* is specified, or the column is a row change timestamp.
- ⁶ The ON DELETE and ON UPDATE clauses may be specified in either order.
- ⁷ The same clause must not be specified more than once.
- ⁸ This syntax for a *partition-element* is valid if there is only one *partition-expression* with a numeric or datetime data type.
- ⁹ The same clause must not be specified more than once. MAINTAINED BY USER must be specified.
- ¹⁰ The same clause must not be specified more than once.

Description

table-name

Identifies the table to be altered. The *table-name* must identify a table that exists at the current server. It must not be a view, a catalog table, or a declared temporary table. If *table-name* identifies a materialized query table or a history table, *ADD column-definition*, *ALTER column-alteration*, or *DROP COLUMN* are not allowed. If *table-name* identifies a materialized query table or a temporal table, *ATTACH PARTITION* and *DETACH PARTITION* are not allowed.

ADD COLUMN *column-definition*

Adds a column to the table. The table cannot be a history table. If the table has rows, every value of the column is set to its default value, unless the column is a ROWID column or a generated column. The database manager generates default values for ROWID columns and generated columns. If the table previously had n columns, the ordinality of the new column is $n+1$. The value of $n+1$ must not exceed 8000.

A table can have only one ROWID and one of each type of generated column.

A DataLink column with FILE LINK CONTROL cannot be added to a table that is a dependent in a referential constraint with a delete rule of CASCADE or to a system period temporal table. A ROWID column cannot be added to a system-period temporal table.

Adding a new column must not make the sum of the row buffer byte counts of the columns be greater than 32766 or, if a VARCHAR, VARBINARY, or VARGRAPHIC column is specified, 32740. Additionally, if a LOB or XML column is specified, the sum of the byte counts of the columns must not be greater than 3 758 096 383 at the time of insert or update. For information on the byte counts of columns according to data type, see “Maximum row sizes” on page 1154.

If the table is a system-period temporal table, the column is also added to the associated history table. The following attributes are copied for the column in the history table:

- Column name and system column name
- Data type
- Length, precision, and scale
- FOR BIT DATA, FOR SBCS DATA, FOR MIXED DATA attribute
- CCSID
- Allocate attribute
- Null attribute
- Hidden attribute
- Field procedure

column-name

Names the column to be added to the table. Do not use the same name for more than one column of the table or for a *system-column-name* of the table. A column named SYSTEM_TIME cannot be added to a table that has a period. Do not qualify *column-name*.

FOR COLUMN *system-column-name*

Provides an IBM i name for the column. Do not use the same name for more than one *column-name* or *system-column-name* of the table.

If the *system-column-name* is not specified, and the *column-name* is not a valid *system-column-name*, a system column name is generated. For more information about how system column names are generated, see [“Rules for Column Name Generation” on page 1156](#).

data-type

Specifies the data type of the column. The data type can be a built-in data type or a distinct type.

built-in-type

Specifies a built-in data type. See [“CREATE TABLE” on page 1105](#) for a description of built-in types.

distinct-type-name

Specifies that the data type of a column is a distinct type. The length, precision, and scale of the column are respectively the length, precision, and scale of the source type of the distinct type. If a distinct type name is specified without a schema name, the distinct type name is resolved by searching the schemas on the SQL path.

DEFAULT

Specifies a default value for the column. This clause cannot be specified more than once in the same *column-definition*. DEFAULT cannot be specified for the following types of columns because the system generates default values:

- a ROWID column
- an identity column
- a row change timestamp column
- a row-begin column
- a row-end column
- a transaction-start-ID column
- a generated expression column

For an XML column, the default is NULL unless NOT NULL is specified; in that case there is no default.

If a value is not specified following the DEFAULT keyword or a DEFAULT clause is not specified, then:

- if the column is a generated column, the default depends on the type of generated column. For these values, see [“GENERATED” on page 874](#) keyword.
- if the column is nullable, the default value is the null value.

- if the column is not nullable, the default depends on the data type of the column:

Data type	Default value
Numeric	0
Fixed-length character or graphic string	Blanks
Fixed-length binary string	Hexadecimal zeros
Varying-length string	A string length of 0
Date	For existing rows, a date corresponding to January 1, 0001. For added rows, the current date.
Time	For existing rows, a time corresponding to 0 hours, 0 minutes, and 0 seconds. For added rows, the current time.
Timestamp	For existing rows, a date corresponding to January 1, 0001 and a time corresponding to 0 hours, 0 minutes, 0 seconds, and 0 fractional seconds. For added rows, the current timestamp.
Datalink	A value corresponding to DLVALUE(';', 'URL;')
<i>distinct-type</i>	The default value of the corresponding source type of the distinct type.

Omission of NOT NULL and DEFAULT from a *column-definition* is an implicit specification of DEFAULT NULL.

constant

Specifies the constant as the default for the column. The specified constant must represent a value that could be assigned to the column in accordance with the rules of assignment as described in “Assignments and comparisons” on page 91. A floating-point constant or decimal floating-point constant must not be used for a SMALLINT, INTEGER, BIGINT, DECIMAL, or NUMERIC column. A decimal constant must not contain more digits to the right of the decimal point than the specified scale of the column.

USER

Specifies the value of the USER special register at the time of INSERT or UPDATE as the default value for the column. The data type of the column must be CHAR or VARCHAR with a length attribute that is greater than or equal to the length attribute of the USER special register. For existing rows, the value is that of the USER special register at the time the ALTER TABLE statement is processed.

NULL

Specifies null as the default for the column. If NOT NULL is specified, DEFAULT NULL must not be specified within the same *column-definition*.

CURRENT_DATE

Specifies the current date as the default for the column. If CURRENT_DATE is specified, the data type of the column must be DATE or a distinct type based on a DATE.

CURRENT_TIME

Specifies the current time as the default for the column. If CURRENT_TIME is specified, the data type of the column must be TIME or a distinct type based on a TIME.

CURRENT_TIMESTAMP or CURRENT_TIMESTAMP(*integer*)

Specifies the current timestamp as the default for the column. If CURRENT_TIMESTAMP is specified, the data type of the column must be TIMESTAMP or a distinct type based on a TIMESTAMP. The timestamp precision of the CURRENT_TIMESTAMP special register used as the default will always match the timestamp precision of the column, regardless of the precision specified for the special register.

cast-function-name

This form of a default value can only be used with columns defined as a strongly typed distinct type, BINARY, VARBINARY, BLOB, CLOB, DBCLOB, DATE, TIME, or TIMESTAMP data types. The following table describes the allowed uses of these *cast-functions*.

Data Type	Cast Function Name
Strongly typed distinct type N based on a BINARY, VARBINARY, BLOB, CLOB, or DBCLOB	BINARY, VARBINARY, BLOB, CLOB, or DBCLOB *
Strongly typed distinct type N based on a DATE, TIME, or TIMESTAMP	N (the user-defined cast function that was generated when N was created) ** or DATE, TIME, or TIMESTAMP *
Strongly typed distinct type N based on other data types	N (the user-defined cast function that was generated when N was created) **
BINARY, VARBINARY, BLOB, CLOB, or DBCLOB	BINARY, VARBINARY, BLOB, CLOB, or DBCLOB *
DATE, TIME, or TIMESTAMP	DATE, TIME, or TIMESTAMP *
Notes: * The name of the function must match the name of the data type (or the source type of the strongly typed distinct type) with an implicit or explicit schema name of QSYS2. ** The name of the function must match the name of the distinct type for the column. If qualified with a schema name, it must be the same as the schema name for the distinct type. If not qualified, the schema name from function resolution must be the same as the schema name for the distinct type.	

constant

Specifies a constant as the argument. The constant must conform to the rules of a constant for the source type of the distinct type or for the data type if not a distinct type. For BINARY, VARBINARY, BLOB, CLOB, DBCLOB, DATE, TIME, and TIMESTAMP functions, the constant must be a string constant.

USER

Specifies the value of the USER special register at the time of INSERT or UPDATE as the default value for the column. The data type of the source type of the distinct type of the column must be CHAR or VARCHAR with a length attribute that is greater than or equal to the length attribute of USER. For existing rows, the value is that of the USER special register at the time the ALTER TABLE statement is processed.

CURRENT_DATE

Specifies the current date as the default for the column. If CURRENT_DATE is specified, the data type of the source type of the distinct type of the column must be DATE.

CURRENT_TIME

Specifies the current time as the default for the column. If CURRENT_TIME is specified, the data type of the source type of the distinct type of the column must be TIME.

CURRENT_TIMESTAMP or CURRENT_TIMESTAMP(integer)

Specifies the current timestamp as the default for the column. If CURRENT_TIMESTAMP is specified, the data type of the source type of the distinct type of the column must be TIMESTAMP. The timestamp precision of the CURRENT_TIMESTAMP special register used as the default will always match the timestamp precision of the column, regardless of the precision specified for the special register.

If the value specified is not valid, an error is returned.

GENERATED

Specifies that the database manager generates values for the column. GENERATED may be specified if the column is to be considered an identity column (defined with the AS IDENTITY clause), a row change timestamp column, a row-begin column, a row-end column, a transaction-start-ID column, or a generated expression column. It may also be specified if the data type of the column is a ROWID (or a distinct type that is based on a ROWID). Otherwise, it must not be specified. An identity, ROWID, or row change timestamp column cannot be added to a system-period temporal table.

If the column is nullable, the null value is assigned as the value for the column in existing rows. Otherwise, the value for the column in existing rows depends on the type of generated column:

- IDENTITY generates an identity value for each row
- ROW CHANGE TIMESTAMP uses a value that corresponds to the timestamp of the ALTER TABLE statement
- ROW BEGIN uses a date that corresponds to January 1, 0001 and a time that corresponds to 0 hours, 0 minutes, 0 seconds, and 0 fractional seconds
- ROW END uses a date that corresponds to December 30, 9999, and a time that corresponds to 0 hours, 0 minutes, 0 seconds, and 0 fractional seconds
- TRANSACTION START ID uses a date that corresponds to January 1, 0001, and a time that corresponds to 0 hours, 0 minutes, 0 seconds, and 0 fractional seconds
- A generated expression uses 0 for numeric columns, a string with length 0 for varying-length character string columns, and blanks for fixed-length character string columns.

ALWAYS

Specifies that the database manager will always generate a value for the column when a row is inserted or updated and a default value must be generated. ALWAYS is the recommended value.

BY DEFAULT

Specifies that the database manager will generate a value for the column when a row is inserted or updated and a default value must be generated, unless an explicit value is specified.

For a ROWID column, the database manager uses a specified value, but it must be a valid unique row ID value that was previously generated by the database manager or Db2 for i.

For an identity column or row change timestamp column, the database manager inserts or updates a specified value but does not verify that it is a unique value for the column unless the identity column or row change timestamp column has a unique constraint or a unique index that solely specifies the identity column or row change timestamp column.

AS IDENTITY

Specifies that the column is an identity column for the table. A table can have only one identity column. An identity column is not allowed in a distributed table. AS IDENTITY can be specified only if the data type for the column is an exact numeric type with a scale of zero (SMALLINT, INTEGER, BIGINT, DECIMAL or NUMERIC with a scale of zero, or a distinct type based on one of these data types). If a DECIMAL or NUMERIC data type is specified, the precision must not be greater than 31.

An identity column is implicitly NOT NULL. See the AS IDENTITY clause in [“CREATE TABLE”](#) on page 1105 for the descriptions of the identity attributes.

FOR EACH ROW ON UPDATE AS ROW CHANGE TIMESTAMP

Specifies that the column is a timestamp and the values will be generated by the database manager. The database manager generates a value for the column for each row as a row is inserted, and for every row in which any column is updated. The value generated for a row change timestamp column is a timestamp corresponding to the time of the insert or update of the row. If multiple rows are inserted with a single SQL statement, the value for the row change timestamp column may be different for each row to reflect when each row was inserted. The generated value is not guaranteed to be unique.

A table can have only one row change timestamp column. If *data-type* is specified, it must be a TIMESTAMP with a precision of 6 or a distinct type based on a TIMESTAMP with a precision of 6. A row change timestamp column cannot have a DEFAULT clause and must be NOT NULL.

AS ROW BEGIN

Specifies that the column contains timestamp data and that the values are generated by the database manager. The database manager generates a value for the column for each row as the row is inserted, and for every row in which any column is updated. The generated value is a timestamp that corresponds to the start time that is associated with the most recent transaction. If multiple rows are inserted with a single SQL statement, the values for the transaction start timestamp column are the same for each row.

For a system-period temporal table, the database manager ensures uniqueness of the generated values for a row-begin column across transactions. The timestamp value might be adjusted to ensure that rows inserted into an associated history table have the end timestamp value greater than the begin timestamp value. This can happen when a conflicting transaction is updating the same row in the system-period temporal table. The `SYSTIME_PERIOD_ADJ QAQQINI` option must be set to `*ADJUST` for this adjustment to the timestamp value to occur. If multiple rows are inserted or updated within a single SQL transaction and an adjustment is not needed, the values for the row-begin column are the same for all the rows and are unique from the values generated for the column for another transaction.

A row-begin column is intended to be used for a system-period temporal table and is required as the first column of a `SYSTEM_TIME` period. A table can have only one row-begin column. If *data-type* is not specified, the column is defined as `TIMESTAMP(12)`. If *data-type* is specified, it must be `TIMESTAMP(12)`. It cannot be a distinct type. The column cannot have a `DEFAULT` clause and must be defined as `NOT NULL`. A row-begin column is not updatable.

For existing rows, the value of the column is set to a date that corresponds to January 1, 0001 and a time that corresponds to 0 hours, 0 minutes, 0 seconds, and 0 fractional seconds.

AS ROW END

Specifies that a value for the data type of the column is assigned by the database manager whenever a row is inserted or any column in the row is updated. The assigned value is `TIMESTAMP '9999-12-30-00.00.00.000000000000'`. For a system-period temporal table, when a row is deleted, the value of the row-end column in the historical row reflects when the row was deleted. If multiple rows are deleted with a single SQL statement, the values for the column in the historical rows are the same.

A row-end column is intended to be used for a system-period temporal table and is required as the second column of a `SYSTEM_TIME` period. A table can have only one row-end column. If *data-type* is not specified, the column is defined as `TIMESTAMP(12)`. If *data-type* is specified, it must be `TIMESTAMP(12)`. It cannot be a distinct type. The column cannot have a `DEFAULT` clause and must be defined as `NOT NULL`. A row-end column is not updatable.

For existing rows, the value of the column is set to a date that corresponds to December 30, 9999 and a time that corresponds to 0 hours, 0 minutes, 0 seconds, and 0 fractional seconds.

AS TRANSACTION START ID

Specifies that the value is assigned by the database manager whenever a row is inserted into the table or any column in the row is updated. The database manager assigns a unique timestamp value per transaction or the null value. The null value is assigned to the transaction-start-ID column if the column is nullable and if there is a row-begin column in the table for which the value did not need to be adjusted. Otherwise the value is generated. If multiple rows are inserted or updated within a single SQL transaction, the values for the transaction-start-ID column are the same for all the rows and are unique from the values generated for the column for another transaction.

A transaction-start-ID column is intended to be used for a system-period temporal table and is required for a system-period temporal table. A table can have only one transaction-start-ID column. If *data-type* is not specified, the column is defined as `TIMESTAMP(12)`. If *data-type* is specified it must be `TIMESTAMP(12)`. It cannot be a distinct type. A transaction-start-ID column cannot have a `DEFAULT` clause. A transaction-start-ID column is not updatable.

For existing rows, if the column is nullable, the null value is assigned as the value of the column. Otherwise, the value of the column is set to a timestamp with a date that corresponds to January 1, 0001 and a time that corresponds to 0 hours, 0 minutes, 0 seconds, and 0 fractional seconds.

DATA CHANGE OPERATION

Specifies that the database manager generates a value for each row that is inserted, for every row in which any column is updated, and for all rows deleted from a system-period temporal table when the history table is defined with ON DELETE ADD EXTRA ROW. The column will contain one of the following values:

I

insert operation

U

update operation

D

delete operation

If *data-type* is not specified, the column is defined as CHAR(1). If *data-type* is specified it must be CHAR(1). It cannot be a distinct type. The column cannot have a DEFAULT clause or a field procedure.

For existing rows, if the column is nullable, the null value is assigned as the value of the column. Otherwise, the value of the column is set to blank.

special-register

Specifies that the value of a special register is assigned by the database manager for each row that is inserted, for every row in which any column is updated, and for all rows deleted from a system-period temporal table when the history table is defined with ON DELETE ADD EXTRA ROW. The value of the special register at the time of the data change statement is used. If multiple rows are changed with a single SQL statement, the value for the column will be the same for all of the rows.

data-type must be defined according to the following table. It cannot be a distinct type.

Special register	Data type for the column
CURRENT CLIENT_ACCTNG	VARCHAR(255)
CURRENT CLIENT_APPLNAME	VARCHAR(255)
CURRENT CLIENT_PROGRAMID	VARCHAR(255)
CURRENT CLIENT_USERID	VARCHAR(255)
CURRENT CLIENT_WRKSTNNAME	VARCHAR(255)
CURRENT SERVER	VARCHAR(18)
SESSION_USER	VARCHAR(128)
USER	VARCHAR(18)

The column cannot have a DEFAULT clause or a field procedure.

For existing rows, if the column is nullable, the null value is assigned as the value of the column. Otherwise, the value of the column is set to a string with length 0.

built-in-global-variable

Specifies that the value of a built-in global variable is assigned by the database manager for each row that is inserted, for every row in which any column is updated, and for all rows deleted from a system-period temporal table when the history table is defined with ON DELETE ADD EXTRA ROW. The value of the built-in global variable at the time of the data change statement is used. If multiple rows are changed with a single SQL statement, the value for the column will be the same for all of the rows.

data-type must be defined according to the following table. It cannot be a distinct type.

Built-in global variable	Data type for the column
QSYS2.JOB_NAME	VARCHAR(28)
QSYS2.SERVER_MODE_JOB_NAME	VARCHAR(28)
SYSIBM.CLIENT_HOST	VARCHAR(255)

Built-in global variable	Data type for the column
SYSIBM.CLIENT_IPADDR	VARCHAR(128)
SYSIBM.CLIENT_PORT	INTEGER
SYSIBM.PACKAGE_NAME	VARCHAR(128)
SYSIBM.PACKAGE_SCHEMA	VARCHAR(128)
SYSIBM.PACKAGE_VERSION	VARCHAR(64)
SYSIBM.ROUTINE_SCHEMA	VARCHAR(128)
SYSIBM.ROUTINE_SPECIFIC_NAME	VARCHAR(128)
SYSIBM.ROUTINE_TYPE	CHAR(1)

The column cannot have a DEFAULT clause or a field procedure.

For existing rows, if the column is nullable, the null value is assigned as the value of the column. Otherwise, the value of the column is set to 0 for numeric columns, a string with length 0 for varying-length character string columns, and blanks for fixed-length character string columns.

NOT NULL

Prevents the column from containing null values. Omission of NOT NULL implies that the column can contain null values. If NOT NULL is specified in the column definition, then DEFAULT must also be specified unless the column is an identity column. NOT NULL is required for a row change timestamp column, a row-begin column, and a row-end column.

NOT HIDDEN

Indicates the column is included in implicit references to the table in SQL statements. This is the default.

IMPLICITLY HIDDEN

Indicates the column is not visible in SQL statements unless it is referred to explicitly by name. For example, SELECT * does not include any hidden columns in the result. A table must contain at least one column that is not IMPLICITLY HIDDEN.

column-constraint

The *column-constraint* of a *column-definition* provides a shorthand method of defining a constraint composed of a single column. Thus, if a *column-constraint* is specified in the definition of column C, the effect is the same as if that constraint were specified as a *unique-constraint*, *referential-constraint* or *check-constraint* in which C is the only identified column.

CONSTRAINT *constraint-name*

A *constraint-name* must not be the same as a constraint name that was previously specified in the ALTER TABLE statement and must not identify a constraint that already exists at the current server.

If the clause is not specified, a unique constraint name is generated by the database manager.

PRIMARY KEY

Provides a shorthand method of defining a primary key composed of a single column. Thus, if PRIMARY KEY is specified in the definition of column C, the effect is the same as if the PRIMARY KEY(C) clause is specified as a separate clause.

This clause must not be specified in more than one *column-definition* and must not be specified at all if the UNIQUE clause is specified in the column definition. The column must not be a LOB, DataLink, or XML column. If a sort sequence is specified, the column must not contain a field procedure.

When a primary key is added, a CHECK constraint is implicitly added to enforce the rule that the NULL value is not allowed in the column that makes up the primary key.

UNIQUE

Provides a shorthand method of defining a unique constraint composed of a single column. Thus, if UNIQUE is specified in the definition of column C, the effect is the same as if the UNIQUE (C) clause is specified as a separate clause.

This clause cannot be specified more than once in a column definition and must not be specified if PRIMARY KEY is specified in the *column-definition*. The column must not be a LOB, DataLink, or XML column. If a sort sequence is specified, the column must not contain a field procedure.

references-clause

The *references-clause* of a column-definition provides a shorthand method of defining a foreign key composed of a single column. Thus, if a *references-clause* is specified in the definition of column C, the effect is the same as if that references-clause were specified as part of a FOREIGN KEY clause in which C is the only identified column. The *references-clause* is not allowed if the table is a declared global temporary table, a distributed table, or a history table. The column cannot be a row change timestamp column.

CHECK(*check-condition*)

Provides a shorthand method of defining a check constraint whose *check-condition* only references a single column. Thus, if CHECK is specified in the column definition of column C, no columns other than C can be referenced in the *check-condition* of the check constraint. The effect is the same as if the check constraint were specified as a separate clause.

ROWID, XML, or DATALINK with FILE LINK CONTROL columns cannot be referenced in a CHECK constraint. For additional restrictions see, [“ADD check-constraint” on page 884](#).

FIELDPROC

Designates an *external-program-name* as the field procedure exit routine for the column. It must be an ILE program that does not contain SQL. It cannot be a service program.

The field procedure encodes and decodes column values. Before a value is inserted in the column, it is passed to the field procedure for encoding. Before a value from the column is used, it is passed to the field procedure for decoding.

The field procedure is also invoked during the processing of the ALTER TABLE statement. When so invoked, the procedure provides Db2 with the column's field description. The field description defines the data characteristics of the encoded values. By contrast, the information supplied for the column defines the data characteristics of the decoded values.

constant

Specifies a parameter that is passed to the field procedure when it is invoked. A parameter list is optional.

A field procedure cannot be defined for a column that is a ROWID or DATALINK or a distinct type based on a ROWID or DATALINK. The column must not be an identity column, a row change timestamp column, a row-begin column, a row-end column, a transaction-start-ID column, or a generated expression column. The column must not have a default value of CURRENT DATE, CURRENT TIME, CURRENT TIMESTAMP, or USER. The column cannot be referenced in a check condition, unless it is referenced in a NULL predicate. If it is part of a foreign key, the corresponding parent key column must use the same field procedure. See [SQL Programming](#) for more details on how to create a field procedure.

datalink-options

Specifies the options associated with a DATALINK column. See [“CREATE TABLE” on page 1105](#) for a description of *datalink-options*.

BEFORE *column-name*

Identifies the column before which the new column is added. The name must not be qualified and must identify an existing column in the table. If the BEFORE clause is not specified, the column is added at the end of the row.

ALTER COLUMN *column-alteration*

Alters the definition of a column, including the attributes of an existing identity column. Only the attributes specified will be altered. Others will remain unchanged. If the table is a system-period temporal table, the change will be made to the corresponding history table column, except any change to the default value or a generated column attribute such as identity or row change timestamp is not copied.

column-name

Identifies the column to be altered. The name must not be qualified and must identify an existing column in the table. The name must not identify a column that is being added or dropped in the same ALTER TABLE statement.

SET DATA TYPE *data-type*

Specifies the new data type of the column to be altered. The new data type must be compatible with the existing data type of the column. For more information about the compatibility of data types see [“Assignments and comparisons” on page 91](#). The following alters are not allowed:

- Numeric data type to a character-string data type
- Character-string data type to a numeric data type
- Datetime data type to character-string data type
- Datetime data type to a different datetime data type

For an XML column, only the CCSID can be changed.

The specified length, precision, and scale may be larger, smaller, or the same as the existing length, precision, and scale. However, if the new length, precision, or scale is smaller, truncation or numeric conversion errors may occur.

If the specified column has a default value and a new default value is not specified, the existing default value must represent a value that could be assigned to the column in accordance with the rules for assignment as described in [“Assignments and comparisons” on page 91](#).

A row change timestamp column cannot be altered to a timestamp with a precision other than 6.

A row-begin, row-end, or transaction-start-ID column cannot be altered to a timestamp with a precision other than 12.

A generated expression column cannot be altered to a data type and length different than its required definition.

If the table is a system-period temporal table, the column is also changed in the associated history table. If the table is a system-period temporal table, the column cannot be altered in any way that could cause data loss, such as a shorter string length or lower precision.

If the column is specified in a unique, primary, or foreign key, the new sum of the lengths of the columns of the keys must not exceed $32766-n$, where n is the number of columns specified that allow nulls.

Changing the attributes will cause any existing values in the column to be converted to the new column attributes according to the rules for assignment to a column, except that string values will be truncated.

Altering the data type attributes of a column can affect a row permission or column mask that is defined for the table. When data type attributes of a column change, row permissions and column masks are reevaluated using the new column attributes. If an error is encountered during the reevaluation process, the ALTER statement fails.

If a row permission or a column mask defined on a different table references this column, the row permission or column mask will not be reevaluated until it is used or is the object of an ALTER REGENERATE. A reevaluation error will result in failure of either the regenerate or the statement that first requires use of the column mask or row permission. The row permission or column mask may need to be dropped and recreated to fix the error.

SET default-clause

Specifies the new default value of the column to be altered. The specified default value must represent a value that could be assigned to the column in accordance with the rules for assignment as described in [“Assignments and comparisons”](#) on page 91.

SET GENERATED ALWAYS or GENERATED BY DEFAULT

Specifies that the database manager generates values for the column. GENERATED may be specified if the column is to be considered an identity column (defined with the AS IDENTITY clause), row change timestamp column, or the data type of the column is a ROWID (or a distinct type that is based on a ROWID). For a row-begin, row-end, transaction-start-ID column, and generated expression column, only GENERATED ALWAYS is allowed. Otherwise, GENERATED must not be specified.

AS IDENTITY

Specifies that the column is changed to an identity column for the table. A table can have only one identity column. An identity column is not allowed in a distributed table. AS IDENTITY can be specified only if the data type for the column is an exact numeric type with a scale of zero (SMALLINT, INTEGER, BIGINT, DECIMAL or NUMERIC with a scale of zero, or a distinct type based on one of these data types). If a DECIMAL or NUMERIC data type is specified, the precision must not be greater than 31.

The column must not be nullable. If the column has an explicit default value, the default value is dropped. See the AS IDENTITY clause in [“CREATE TABLE”](#) on page 1105 for the descriptions of the identity attributes.

as-row-transaction-timestamp-clause

Specifies that the column is changed to a row-begin or row-end column for the table. The column must be a TIMESTAMP(12), must not have a default and must not be nullable.

as-row-transaction-start-id-clause

Specifies that the column is changed to a transaction-start-id column for the table. The column must be a TIMESTAMP(12) and must not have a default.

SET NOT NULL

Specifies that the column cannot contain null values. All values for this column in existing rows of the table must be not null. If the specified column has a default value and a new default value is not specified, the existing default value must not be NULL. SET NOT NULL is not allowed if the column is identified in the foreign key of a referential constraint with a DELETE rule of SET NULL and no other nullable columns exist in the foreign key.

SET NOT HIDDEN or IMPLICITLY HIDDEN

Specifies the hidden attribute for the column.

NOT HIDDEN

Indicates the column is included in implicit references to the table in SQL statements.

IMPLICITLY HIDDEN

Indicates the column is not visible in SQL statements unless it is referred to explicitly by name. For example, SELECT * does not include any hidden columns in the result. A table must contain at least one column that is not IMPLICITLY HIDDEN.

SET FIELDPROC

Designates an *external-program-name* as the field procedure exit routine for the column. It must be an ILE program that does not contain SQL. It cannot be a service program.

The field procedure encodes and decodes column values. Before a value is inserted in the column, it is passed to the field procedure for encoding. Before a value from the column is used, it is passed to the field procedure for decoding.

The field procedure is also invoked during the processing of the ALTER TABLE statement. When so invoked, the procedure provides Db2 with the column's field description. The field description defines the data characteristics of the encoded values. By contrast, the information supplied for the column defines the data characteristics of the decoded values.

constant

Specifies a parameter that is passed to the field procedure when it is invoked. A parameter list is optional.

A field procedure cannot be defined for a column that is a ROWID or DATALINK or a distinct type based on a ROWID or DATALINK. The column must not be an identity column, a row change timestamp column, a row-begin column, a row-end column, a transaction-start-ID column, or a generated expression column. The column must not have a default value of CURRENT DATE, CURRENT TIME, CURRENT TIMESTAMP, or USER. The nullability attribute of the encoded and decoded form of the field must match. The column cannot be referenced in a check condition, unless it is referenced in a NULL predicate. If it is part of a foreign key, the corresponding parent key column must use the same field procedure. See [SQL Programming](#) topic collection for an example of a field procedure.

DROP DEFAULT

Drops the current default for the column. The specified column:

- must have a default value and must not have NOT NULL as the null attribute, or
- can have a default value of NULL if the default for the column was defined with DEFAULT NULL.

The new default value is the null value.

DROP NOT NULL

Drops the NOT NULL attribute of the column, allowing the column to have the null value. If a default value is not specified or does not already exist, the new default value is the null value. DROP NOT NULL is not allowed if the column is specified in the primary key of the table or is an identity column, row change timestamp column, row-begin column, row-end column, or ROWID.

DROP GENERATED

Drops the generated attribute of the column. The column must be an identity column, a row change timestamp column, a row-begin column, a row-end column, a transaction-start-ID column, or a generated expression column. The generated attribute cannot be dropped for a row-begin column, row-end column, or transaction-start-ID column if versioning is active.

DROP IDENTITY

Drops the identity attributes of the column, making the column a simple numeric data type column. DROP IDENTITY is not allowed if the column is not an identity column.

DROP ROW CHANGE TIMESTAMP

Drops the row change timestamp attribute of the column, making the column a simple timestamp column. DROP ROW CHANGE TIMESTAMP is not allowed if the column is not a row change timestamp column.

DROP FIELDPROC

Drops the field procedure for the column. DROP FIELDPROC is not allowed if the column does not have a field procedure defined.

identity-alteration

Alters the identity attributes of the column. The column must exist in the specified table and must already be defined with the IDENTITY attribute. For a description of the attributes, see [AS IDENTITY](#).

RESTART

Specifies the next value for an identity column. If WITH *numeric-constant* is not specified, the sequence is restarted at the value specified implicitly or explicitly as the starting value when the identity column was originally created. RESTART does not change the original START WITH value.

WITH *numeric-constant*

Specifies that *numeric-constant* will be used as the next value for the column. The *numeric-constant* must be an exact numeric constant that can be any positive or negative value that could be assigned to this column, without nonzero digits existing to the right of the decimal point.

DROP COLUMN

Drops the identified column from the table.

column-name

Identifies the column to be dropped. The column name must not be qualified. The name must identify a column of the specified table. The name must not identify:

- a column that was already added or altered in this ALTER TABLE statement
- the only column of a table
- the last column of the table that is not hidden
- a partition key of a partitioned table or a distributed table
- a column in a system-period temporal table
- a column in a history table
- a column referenced in the definition of a period

When a column is dropped, any column mask defined for that column is dropped. A column referenced in the definition of a row permission or column mask for a different column cannot be dropped.

CASCADE

Specifies that any views, indexes, triggers, or constraints that are dependent on the column being dropped are also dropped.⁸⁰

RESTRICT

Specifies that the column cannot be dropped if any views, indexes, triggers, materialized query tables, or constraints are dependent on the column.⁸⁰

If all the columns referenced in a constraint are dropped in the same ALTER TABLE statement, RESTRICT does not prevent the drop.

ADD unique-constraint**CONSTRAINT constraint-name**

Names the constraint. A *constraint-name* must not be the same as a constraint name that was previously specified in the ALTER TABLE statement and must not identify a constraint that already exists at the current server. The *constraint-name* must be unique within a schema.

If not specified, a unique constraint name is generated by the database manager.

UNIQUE (column-name,...)

Defines a unique constraint composed of the identified columns. Each *column-name* must be an unqualified name that identifies a column of the table. The same column must not be identified more than once. The column must not be a LOB, DATALINK, or XML column. If a sort sequence is specified, the column must not contain a field procedure. The number of identified columns must not exceed 120, and the sum of their lengths must not exceed 32766-*n*, where *n* is the number of columns specified that allow nulls. UNIQUE is not allowed if the table is a history table.

The set of identified columns cannot be the same as the set of columns specified in another UNIQUE constraint or PRIMARY KEY on the table. For example, UNIQUE (A,B) is not allowed if UNIQUE (B,A) or PRIMARY KEY (A,B) already exists on the table. Any existing nonnull values in the set of columns must be unique. Multiple null values are allowed.

If a unique index already exists on the identified columns, that index is designated as a unique constraint index. Otherwise, a unique index is created to support the uniqueness of the unique key. The unique index is created as part of the system physical file, not as a separate system logical file.

PRIMARY KEY (column-name,...)

Defines a primary key composed of the identified columns. Each *column-name* must be an unqualified name that identifies a column of the table. The same column must not be identified more than once. The column must not be a LOB, DATALINK, or XML column. If a sort sequence is specified, the column must not contain a field procedure. The number of identified columns must not exceed 120, and the

⁸⁰ A trigger is dependent on the column if it is referenced in the UPDATE OF column list or anywhere in the triggered action.

sum of their lengths must not exceed 32766. The table must not already have a primary key. PRIMARY KEY is not allowed if the table is a history table.

The identified columns cannot be the same as the columns specified in another UNIQUE constraint on the table. For example, PRIMARY KEY (A,B) is not allowed if UNIQUE (B,A) already exists on the table. Any existing values in the set of columns must be unique.

When a primary key is added, a CHECK constraint is implicitly added to enforce the rule that the NULL value is not allowed in any of the columns that make up the primary key.

If a unique index already exists on the identified columns, that index is designated as a primary index. Otherwise, a primary index is created to support the uniqueness of the primary key. The unique index is created as part of the system physical file, not a separate system logical file.

ADD referential-constraint

CONSTRAINT *constraint-name*

Names the constraint. A *constraint-name* must not identify a constraint that already exists at the current server.

If not specified, a unique constraint name is generated by the database manager.

FOREIGN KEY

Defines a referential constraint. FOREIGN KEY is not allowed if the table is a declared global temporary table, a distributed table, or a history table.

Let T1 denote the table being altered.

(*column-name*,...)

The foreign key of the referential constraint is composed of the identified columns. Each *column-name* must be an unqualified name that identifies a column of T1. The same column must not be identified more than once. The column must not be a LOB, DATALINK, or XML column and must not be a row change timestamp column. If a sort sequence is specified, the column must not contain a field procedure. The number of the identified columns must not exceed 120, and the sum of their lengths must not exceed $32766-n$, where n is the number of columns specified that allows nulls.

REFERENCES *table-name*

The *table-name* specified in a REFERENCES clause must identify a base table that exists at the current server, but it must not identify a catalog table, a declared temporary table, a distributed table, or a history table. If the parent is a partitioned table, the unique index that enforces the parent unique constraint must be non-partitioned. This table is referred to as the parent table in the constraint relationship.

A referential constraint is a *duplicate* if its foreign key, parent key, and parent table are the same as the foreign key, parent key, and parent table of an existing referential constraint on the table. Duplicate referential constraints are allowed, but not recommended.

Let T2 denote the identified parent table.

(*column-name*,...)

The parent key of the referential constraint is composed of the identified columns. Each *column-name* must be an unqualified name that identifies a column of T2. The same column must not be identified more than once. The column must not be a LOB, DATALINK, or XML column and must not be a row change timestamp column. If a sort sequence is specified, the column must not contain a field procedure. The number of identified columns must not exceed 120, and the sum of their lengths must not exceed $32766-n$, where n is the number of columns specified that allow nulls.

The list of column names must be identical to the list of column names in the primary key of T2 or a UNIQUE constraint that exists on T2. The names may be specified in any order. For example, if (A,B) is specified, a unique constraint defined as UNIQUE (B,A) would satisfy the requirement. If a column name list is not specified then T2 must have a primary key. Omission of the column name list is an implicit specification of the columns of that primary key.

The specified foreign key must have the same number of columns as the parent key of T2. The description of the *n*th column of the foreign key and the *n*th column of the parent key must have identical data types, lengths, CCSIDs, and FIELDPROCs.

Unless the table is empty, the values of the foreign key must be validated before the table can be used. Values of the foreign key are validated during the execution of the ALTER TABLE statement. Therefore, every nonnull value of the foreign key must match some value of the parent key of T2.

The referential constraint specified by the FOREIGN KEY clause defines a relationship in which T2 is the parent and T1 is the dependent.

ON DELETE

Specifies what action is to take place on the dependent tables when a row of the parent table is deleted. There are five possible actions:

- NO ACTION (default)
- RESTRICT
- CASCADE
- SET NULL
- SET DEFAULT

SET NULL must not be specified unless some column of the foreign key allows null values. SET NULL and SET DEFAULT must not be specified if T1 has an update trigger.

CASCADE must not be specified if T1 has a delete trigger.

CASCADE must not be specified if T1 contains a DataLink column with FILE LINK CONTROL.

The delete rule applies when a row of T2 is the object of a DELETE or propagated delete operation and that row has dependents in T1. Let *p* denote such a row of T2.

- If RESTRICT or NO ACTION is specified, an error occurs and no rows are deleted.
- If CASCADE is specified, the delete operation is propagated to the dependents of *p* in T1.
- If SET NULL is specified, each nullable column of the foreign key of each dependent of *p* in T1 is set to null.
- If SET DEFAULT is specified, each column of the foreign key of each dependent of *p* in T1 is set to its default value.

ON UPDATE

Specifies what action is to take place on the dependent tables when a row of the parent table is updated.

The update rule applies when a row of T2 is the object of an UPDATE or propagated update operation and that row has dependents in T1. Let *p* denote such a row of T2.

- If RESTRICT or NO ACTION is specified, an error occurs and no rows are updated.

ADD check-constraint

CONSTRAINT *constraint-name*

Names the constraint. A *constraint-name* must not identify a constraint that already exists at the current server. The *constraint-name* must be unique within a schema.

If not specified, a unique constraint name is generated by the database manager.

CHECK(*check-condition*)

Defines a check constraint. The *check-condition* must be true or unknown for every row of the table.

The *check-condition* is a *search-condition*, except:

- It can only refer to columns of the table and the column names must not be qualified.
- The result of any expression in the *check-condition* cannot be a ROWID, XML, or DATALINK with FILE LINK CONTROL data type.

- It must not contain any of the following:
 - Subqueries
 - Aggregate functions
 - Variables
 - Global variables
 - Parameter markers
 - *Sequence-references*
 - Complex expressions that contain LOBs (such as concatenation)
 - OLAP specifications
 - ROW CHANGE expressions
 - IS JSON, JSON_EXISTS, or REGEXP_LIKE predicates
 - Special registers
 - Any function that is not deterministic
 - User-defined functions other than functions that were implicitly generated with the creation of a strongly typed distinct type
 - The following built-in scalar functions:

ATAN2	DLURLSCHEME	JSON_QUERY	REPLACE
BSON_TO_JSON	DLURLSERVER	JSON_TO_BSON	ROUND_TIMESTAMP
CARDINALITY	DLVALUE	JSON_VALUE	RPAD
CONTAINS	ENCRYPT_AES	LOCATE_IN_STRING	SCORE
CURDATE	ENCRYPT_RC2	LPAD	SOUNDEX
CURTIME	ENCRYPT_TDES	MAX_CARDINALITY	TABLE_NAME
DATAPARTITIONNAME	GENERATE_UNIQUE	MONTHNAME	TABLE_SCHEMA
DATAPARTITIONNUM	GETHINT	MONTHS_BETWEEN	TIMESTAMP_FORMAT
DAYNAME	HASH	NEXT_DAY	TIMESTAMPDIFF
DBPARTITIONNAME	HASH_MD5	NOW	TRUNC_TIMESTAMP
DECRYPT_BINARY	HASH_SHA1	OVERLAY	VARCHAR_FORMAT
DECRYPT_BIT	HASH_SHA256	RAISE_ERROR	VERIFY_GROUP_FOR_USER
DECRYPT_CHAR	HASH_SHA512	RAND	WEEK_ISO
DECRYPT_DB	IDENTITY_VAL_LOCAL	REGEXP_COUNT	WRAP
DIFFERENCE	INSERT	REGEXP_INSTR	XMLPARSE
DLURLCOMPLETE ¹	INTERPRET	REGEXP_REPLACE	XMLVALIDATE
DLURLPATH	JSON_ARRAY	REGEXP_SUBSTR	XSLTRANSFORM
DLURLPATHONLY	JSON_OBJECT	REPEAT	

¹ For DataLinks with an attribute of FILE LINK CONTROL and READ PERMISSION DB.

ON INSERT VIOLATION

Specifies the action to take if the *check-condition* is false for a row being inserted. If this clause is not specified, an error will occur if the *check-condition* is false for an insert.

SET *column-name* = DEFAULT

The default value for *column-name* is inserted into the table instead of the value provided by the insert operation.

column-name must be referenced in the *check-condition*.

ON UPDATE VIOLATION

Specifies the action to take if the *check-condition* is false for a row being updated. If this clause is not specified, an error will occur if the *check-condition* is false for an update.

PRESERVE *column-name*

The current value for *column-name* remains in the table rather than being replaced by the value provided by the update operation.

column-name must be referenced in the *check-condition*.

For more information about search-condition, see [“Search conditions” on page 228](#).

DROP

PRIMARY KEY

Drops the definition of the primary key and all referential constraints in which the primary key is a parent key. The table must have a primary key.

UNIQUE *constraint-name*

Drops the unique constraint *constraint-name* and all referential constraints dependent on this unique constraint. The *constraint-name* must identify a unique constraint on the table. DROP UNIQUE will not drop a PRIMARY KEY unique constraint.

FOREIGN KEY *constraint-name*

Drops the referential constraint *constraint-name*. The *constraint-name* must identify a referential constraint in which the table is a dependent.

CHECK *constraint-name*

Drops the check constraint *constraint-name*. The *constraint-name* must identify a check constraint on the table.

CONSTRAINT *constraint-name*

Drops the constraint *constraint-name*. The *constraint-name* must identify a unique, referential, or check constraint on the table. If the constraint is a PRIMARY KEY or UNIQUE constraint, all referential constraints in which the primary key or unique key is a parent are also dropped.

CASCADE

Specifies for unique constraints that any referential constraints that are dependent on the constraint being dropped are also dropped.

RESTRICT

Specifies for unique constraints that the constraint cannot be dropped if any referential constraints are dependent on the constraint.

ADD partitioning-clause

Changes a non-partitioned table into a partitioned table. If the specified table is a distributed table or already a partitioned table, an error is returned. A DDS-created physical file cannot be partitioned. See [“CREATE TABLE” on page 1105](#) for a description of the *partitioning-clause*.

Changing a non-partitioned table that contains data into a partitioned table will require data movement between the data partitions. When using range partitioning, all existing data in the table must be assignable to the specified range partitions.

DROP PARTITIONING

Changes a partitioned table into a non-partitioned table. If the specified table is already non-partitioned, an error is returned.

Changing a partitioned table that contains data into a non-partitioned table will require data movement between the data partitions.

ADD PARTITION *add-partition*

Adds one or more partitions to a partitioned table. The specified table must be a partitioned table. The number of partitions must not exceed 256.

Changing the number of hash partitions in a partitioned table that contains data will require data movement between the data partitions.

partition-name

Names the partition. A *partition-name* must not identify a data partition that already exists in the table.

If the clause is not specified, a unique partition name is generated by the database manager.

boundary-spec

Specifies the boundaries of a range partition. If the specified table is not a range partitioned table, an error is returned. Both a *starting-clause* and an *ending-clause* must be specified. See [“CREATE TABLE” on page 1105](#) for a description of the *boundary-spec*.

***integer* HASH PARTITIONS**

Specifies the number of hash partitions to be added. If the specified table is not a hash partitioned table, an error is returned.

ALTER PARTITION

Alters the boundaries of a partition of a range partitioned table. If the specified table is not a range partitioned table, an error is returned.

Changing the boundaries of one or more partitions of a table that contains data may require data movement between the data partitions. All existing data in the table must be assignable to the specified range partitions.

partition-name

Specifies the name of the partition to alter. The *partition-name* must identify a data partition that exists in the table.

boundary-spec

Specifies the new boundaries of a range partition. Both a *starting-clause* and an *ending-clause* must be specified. See [“CREATE TABLE” on page 1105](#) for a description of the *boundary-spec*.

DROP PARTITION

Drops a partition of a partitioned table. If the specified table is not a partitioned table, an error is returned. If the last remaining partition of a partitioned table is specified, an error is returned. A partition cannot be dropped from a system-period temporal table unless the PRESERVE ROWS option is specified or the partition is empty.

partition-name

Specifies the name of the partition to drop. The *partition-name* must identify a data partition that exists in the table.

DELETE ROWS

Specifies that any data in the specified partition will be discarded. All data stored in the partition is dropped from the table without processing any delete triggers.

PRESERVE ROWS

Specifies that any data in the specified partition will be preserved by moving it to the remaining partitions without processing any delete or insert triggers. If the specified table is a range partitioned table, PRESERVE ROWS must not be specified. Dropping a hash partition will require data movement between the remaining data partitions.

ATTACH PARTITION

Attaches another table as a new data partition. The data in the table being attached becomes a new partition of the table being attached to. There is no data movement involved. If the specified target table is not a partitioned table, an error is returned. If the target table already has the maximum number of partitions, an error is returned. If the table is hash partitioned, an error is returned.

If the table being attached has either row level access control or column level access control activated then the table to attach to must have the same controls activated. No row permissions or column masks are automatically carried over from the table being attached to the target table. The column masks and row permissions do not necessarily need to be exactly the same on both tables, although this would be best from a security perspective. But if the table being attached has row level access control activated then the table to attach to must also have row level access control activated. Similarly, if the table being attached has column level access control activated and at least one column mask enabled then the table to attach to must also have column level access control activated and a column mask enabled for the corresponding columns.

partition-name

Names the data partition. The name must not be the same as any other data partition for the table. If this clause is not specified and the source table is partitioned, the partition name of the source table will be used. Otherwise, if this clause is not specified, a unique partition name is generated by the database manager.

boundary-spec

Specifies the boundaries for the new partition. If a *boundary-spec* is not specified:

- The source table must be a partitioned table with a single partition and the *boundary-spec* of that partition will be implicitly used.
- The number of partition keys and the partition key names of the source table must be the same as those of the target table.

The implicit or explicit range must not overlap that of an existing data partition. See [“CREATE TABLE” on page 1105](#) for a description of the *boundary-spec*. If a *boundary-spec* is specified, the data in the source table must conform to the specified range or subsequent SQL operations may be unpredictable.

FROM *table-name1*

Specifies the table that is to be used as the source of data for the new partition. The table must exist in the same relational database as the target table. If the specified table is not a partitioned table, an error is returned. If the table is hash partitioned, an error is returned. The table must not be a view, a materialized query table, a declared global temporary table, a system-period temporal table, a history table, or a system table. The table must not have a NOT LOGGED INITIALLY attribute. The table definition of *table-name1* cannot have multiple partitions, and it must match the altered table in the following ways:

- The number of columns must be the same.
- The data types, attributes, field procedures, generated expressions, default values, and CCSIDs of the columns in the same ordinal position in the table must be the same.
- The nullability characteristic of the columns in the same ordinal position in the table must be the same.
- If the target table has a row change timestamp column, the corresponding column of the source table must be a row change timestamp column.
- For varying length or LOB data types, the ALLOCATE length of columns in the same ordinal position in the table must be the same.

After the data from *table-name1* is successfully attached, an operation equivalent to DROP TABLE *table-name1* CASCADE is performed to remove this table, which no longer has data, from the database.

DETACH PARTITION

Detaches a partition of a partitioned table. If the specified table is not a partitioned table, an error is returned. A new partitioned table named *table-name1* with one partition will be created to contain the detached partition data. *partition-name* cannot be the last remaining partition of the table being altered. The table being altered must not be a system-period temporal table, a parent table of an enforced referential constraint, or use HASH partitioning.

If the source table contains an identity column, the corresponding column in the created table will not be an identity column. All other column attributes from the source table are defined for the corresponding column in the created table. If the source table has constraints, similar constraints are not added to the created table.

When a partition is detached from a table for which either row level access control or column level access control is activated, the new table that is created for the detached data will automatically have row level access control activated to protect the detached data. Direct access to this new table will return no rows until appropriate row permissions are defined for the table or row level access control is deactivated for this table.

Privileges on the source table are not propagated to the created table.

partition-name

Specifies the name of the partition to detach. *partition-name* must identify a data partition that exists in the table.

table-name1

Names the table. The name, including the implicit or explicit qualifier, must not identify an alias, file, index, table, or view that already exists at the current server.

If SQL names were specified, the table will be created in the schema specified by the implicit or explicit qualifier.

If system names were specified, the table will be created in the schema that is specified by the qualifier. If not qualified:

- If the value of the CURRENT_SCHEMA special register is *LIBL, the table will be created in the current library (*CURLIB).
- Otherwise, the table will be created in the current schema.

If the specified partitioned table is journaled, the new table will be journaled to the same journal. Otherwise, the new table will not be journaled.

Table ownership: If SQL names were specified:

- If a user profile with the same name as the schema into which the table is created exists, the *owner* of the table is that user profile.
- Otherwise, the *owner* of the table is the user profile or group user profile of the thread executing the statement.

If system names were specified, the *owner* of the table is the user profile or group user profile of the thread executing the statement.

Table authority: If SQL names are used, the table is created with the system authority of *EXCLUDE to *PUBLIC. If system names are used, the table is created with the authority to *PUBLIC as determined by the create authority (CRTAUT) parameter of the schema.

ADD MATERIALIZED QUERY *materialized-query-definition*

Changes a base table to a materialized query table. If the specified table is already a materialized query table or if the table is referenced in another materialized query table, an error is returned.

select-statement

Defines the query on which the table is based. The columns of the existing table must meet the following characteristics:

- The number of columns in the table must be the same as the number of result columns in the *select-statement*.
- The column attributes of each column of the table must be compatible to the column attributes of the corresponding result column in the *select-statement*.

The *select-statement* for a materialized query table must not contain a reference to the table being altered, a view over the table being altered, or another materialized query table. For additional details about specifying *select-statement* for a materialized query table, see [“CREATE TABLE” on page 1105](#).

refreshable-table-options

Specifies the materialized query table options for altering a base table to a materialized query table.

DATA INITIALLY DEFERRED

Specifies that the data in the table is not validated as part of the ALTER TABLE statement. A REFRESH TABLE statement can be used to make sure the data in the materialized query table is the same as the result of the query in which the table is based.

DATA INITIALLY IMMEDIATE

Specifies that the data is inserted in the table from the result of the query as part of processing the ALTER TABLE statement.

REFRESH DEFERRED

Specifies that the data in the table can be refreshed at any time using the REFRESH TABLE statement. The data in the table only reflects the result of the query as a snapshot at the time when the REFRESH TABLE statement is processed or when it was last updated.

MAINTAINED BY USER

Specifies that the materialized query table is maintained by the user. The user can use INSERT, DELETE, UPDATE, or REFRESH TABLE statements on the table.

ENABLE QUERY OPTIMIZATION or DISABLE QUERY OPTIMIZATION

Specifies whether this materialized query table can be used for query optimization.

ENABLE QUERY OPTIMIZATION

The materialized query table can be used for query optimization.

DISABLE QUERY OPTIMIZATION

The materialized query table will not be used for query optimization. The table can still be queried directly.

If row level or column level access control is activated for any table that is directly or indirectly referenced in the *select-statement* and row access control is not activated for the table being altered, row access control is implicitly activated for the altered table. This restricts direct access to the contents of the materialized query table. A query that explicitly references the table will return a warning that there is no data in the table. To provide access to the materialized query table, an appropriate row permission can be created or an ALTER TABLE DEACTIVATE ROW ACCESS CONTROL on the materialized query table can be issued to remove the row level protection if that is appropriate.

ALTER MATERIALIZED QUERY *materialized-query-table-alteration*

Changes the attributes of a materialized query table. The *table-name* must identify a materialized query table.

select-statement

Defines the query on which the table is based. The columns of the existing table must meet the following characteristics:

- The number of columns in the table must be the same as the number of result columns in the *select-statement*.
- The column attributes of each column of the table must be compatible to the column attributes of the corresponding result column in the *select-statement*.

The *select-statement* for a materialized query table must not contain a reference to the table being altered, a view over the table being altered, or another materialized query table. For additional details about specifying *select-statement* for a materialized query table, see [“CREATE TABLE” on page 1105](#).

refreshable-table-options

Specifies the materialized query table options for altering a base table to a materialized query table.

DATA INITIALLY DEFERRED

Specifies that the data in the table is not refreshed or validated as part of the ALTER TABLE statement. A REFRESH TABLE statement can be used to make sure the data in the materialized query table is the same as the result of the query in which the table is based.

DATA INITIALLY IMMEDIATE

Specifies that the data is inserted in the table from the result of the query as part of processing the ALTER TABLE statement.

REFRESH DEFERRED

Specifies that the data in the table can be refreshed at any time using the REFRESH TABLE statement. The data in the table only reflects the result of the query as a snapshot at the time when the REFRESH TABLE statement is processed or when it was last updated.

MAINTAINED BY USER

Specifies that the materialized query table is maintained by the user. The user can use INSERT, DELETE, UPDATE, or REFRESH TABLE statements on the table.

ENABLE QUERY OPTIMIZATION or DISABLE QUERY OPTIMIZATION

Specifies whether this materialized query table can be used for query optimization.

ENABLE QUERY OPTIMIZATION

The materialized query table can be used for query optimization.

DISABLE QUERY OPTIMIZATION

The materialized query table will not be used for query optimization. The table can still be queried directly.

SET refreshable-table-alteration

Changes how the table is maintained or whether the table can be used in query optimization.

MAINTAINED BY USER

Specifies that the materialized query table is maintained by the user. The user can use INSERT, DELETE, UPDATE, or REFRESH TABLE statements on the table.

REFRESH DEFERRED

Specifies that the data in the table can be refreshed at any time using the REFRESH TABLE statement. The data in the table only reflects the result of the query as a snapshot at the time when the REFRESH TABLE statement is processed or when it was last updated.

ENABLE QUERY OPTIMIZATION or DISABLE QUERY OPTIMIZATION

Specifies whether this materialized query table can be used for query optimization.

ENABLE QUERY OPTIMIZATION

The materialized query table can be used for query optimization.

DISABLE QUERY OPTIMIZATION

The materialized query table will not be used for query optimization. The table can still be queried directly.

DROP MATERIALIZED QUERY

Changes a materialized query table so that it is no longer a materialized query table. The table specified by *table-name* must be defined as a materialized query table. The definition of columns are not changed, but the table can no longer be used for query optimization and is no longer valid for use with the REFRESH TABLE statement. Row level access and column level access for the table remain in their current activated or deactivated state.

ACTIVATE NOT LOGGED INITIALLY

Activates the NOT LOGGED INITIALLY attribute of the table for this current unit of work.

Any changes made to the table by INSERT, DELETE, or UPDATE statements in the same unit of work after the table is altered by this statement are not logged (journalled).

At the completion of the current unit of work, the NOT LOGGED INITIALLY attribute is deactivated and all operations that are done on the table in subsequent units of work are logged (journalled).

ACTIVATE NOT LOGGED INITIALLY is not allowed in a transaction if data change operations are pending for *table-name* or cursors are currently open under commit that reference *table-name*.

ACTIVATE NOT LOGGED INITIALLY is not allowed if the table is a system-period temporal table or a history table. It is ignored if the table has a DATALINK column with FILE LINK CONTROL or if running with isolation level No Commit (NC).

WITH EMPTY TABLE

Causes all data currently in the table to be removed. If the unit of work in which this ALTER statement was issued is rolled back, the table data will NOT be returned to its original state. When this action is requested, no DELETE triggers defined on the affected table are fired.

WITH EMPTY TABLE cannot be specified for a materialized query table or for a parent in a referential constraint. WITH EMPTY TABLE is ignored if running with isolation level No Commit (NC).

A DELETE statement without a WHERE clause will typically perform as well or better than ACTIVATE NOT LOGGED INITIALLY WITH EMPTY TABLE and will allow a ROLLBACK to rollback the delete of the rows in the table.

ADD PERIOD FOR *period-definition*

Adds a period definition to the table.

SYSTEM_TIME (*begin-column-name*, *end-column-name*)

Defines a system period with the name SYSTEM_TIME. There must not be a column in the table with the name SYSTEM_TIME. A table can have only one SYSTEM_TIME period. *begin-column-name* must be defined as ROW BEGIN and *end-column-name* must be defined as ROW END

DROP PERIOD SYSTEM_TIME

Drops the SYSTEM_TIME period from the table. The SYSTEM_TIME period cannot be dropped if the table is a system-period temporal table.

ADD VERSIONING USE HISTORY TABLE *history-table-name*

Specifies that the table is a system-period temporal table. The table must not already be defined as a system-period temporal table or a history table. A SYSTEM_TIME period and a transaction-start-ID column must be defined in the table. The table must not be a materialized query table or a distributed table and must not have a ROWID column or a DATALINK column with FILE LINK CONTROL. Neither the table nor the history table can have the NOT LOGGED INITIALLY attribute activated.

Historical versions of the rows in the table are retained by the database manager. An associated history table is used to store the historical rows of the table. The database manager records extra information that indicates when a row was inserted into the table, and when it was updated or deleted. When a row in a system-period temporal table is updated, a previous version of the row is kept. When data in a system-period temporal table is deleted, the old version of the row is inserted as a historical record.

References to the table can include a period specification to indicate which versions of the data are to be returned.

history-table-name

Identifies a history table where historical rows of the system-period temporal table are kept. *history-table-name* must identify a table that exists at the current server, and is not a catalog table, an

existing system-period temporal table, an existing history table, a declared global temporary table, a materialized query table, or a view.

The identified history table must not contain an identity column, row change timestamp column, row-begin column, row-end column, transaction start-ID column, or include a period. It cannot be part of a referential constraint or have a unique or primary key constraint.

Once a table has been defined as a history table, no direct inserts or updates can be performed on the table. Deletes are allowed.

ON DELETE ADD EXTRA ROW

Indicates that when a row is deleted from the system-period temporal table, the deleted row is added to the history table. This additional history row is not returned for a query with a period specification for a system-period temporal table. Values for the row begin, row end, and any generated expression columns are generated when this row is added.

The ON DELETE ADD EXTRA ROW clause is intended to be used when the system-period temporal table contains generated expression columns. The generated expression columns in an extra row contain information about the delete operation that resulted in the extra row in the history table.

The system-period temporal table and the identified history table must be in the same schema and must have the same number and order of columns. The following attributes for the corresponding columns of the two tables must be the same:

- Name and system column name
- Data type
- Length, precision, and scale
- FOR BIT DATA, FOR SBCS DATA, FOR MIXED DATA attribute
- CCSID
- Null attribute
- Hidden attribute
- Field procedure
- Date and time formats and separators
- Sort sequence and language ID

If the history table contains data, ensure that the data accurately represents historical rows. If the data does not accurately represent historical rows, the results of temporal queries might be unexpected.

If row access control or column access control is activated for the system-period temporal table and row access control is not activated on the history table, the database manager automatically activates row access control on the history table and creates a default row permission for the history table.

DROP VERSIONING

Specifies that the table is no longer a system-period temporal table. The table must be a system-period temporal table. Historical data is no longer recorded and maintained for the table. The definition of the columns and data of the table are not changed, but the table is no longer treated as a system-period temporal table. The SYSTEM_TIME period is retained. Subsequent queries that reference the table must not specify a SYSTEM_TIME period specification for the table. The relationship between the system-period temporal table and the associated history table is removed. The history table is not dropped and the contents of the history table are not affected.

ACTIVATE ROW ACCESS CONTROL or DEACTIVATE ROW ACCESS CONTROL

Specifies whether enabled row permissions are to be applied by Db2 to control the set of rows in the table that are accessible.

ACTIVATE ROW ACCESS CONTROL

Specifies to activate row access control for the table. If the table is an alias, row access control is activated for the base table. Row access control cannot be activated for a declared global temporary table or a table in QTEMP.

A default row permission is implicitly created and allows no access to any rows of the table unless an enabled row permission exists that provides access for the authorization IDs or group profiles that are specified in the definition of the permission. A query that references the table before such a row permission exists will return a warning that there is no data in the table.

If a trigger exists for the table, the trigger must be defined with the SECURED attribute and must not be a READ trigger.

The table must not be referenced in the definition of a view if an INSTEAD OF trigger that is defined with the NOT SECURED attribute exists for the view.

When the table is referenced in a data manipulation statement, all enabled row permissions that have been created for the table, including the default row permission, are applied by Db2 to control the set of rows in the table that are accessible. A permission that gets an error when trying to be activated cannot be activated until any errors in the permission definition are resolved. This may require the permission to be dropped and recreated with a modified definition.

If a materialized query table that depends on the table (directly, or indirectly through a view) for which row level access control is being activated and that materialized query table does not already have row level access control activated, row level access control is implicitly activated for the materialized query table. This restricts direct access to the contents of the materialized query table. A query that explicitly references the table before such a row permission is defined will return a warning that there is no data in the table. To provide access to the materialized query table, an appropriate row permission can be created, or an ALTER TABLE DEACTIVATE ROW ACCESS CONTROL on the materialized query table can be issued to remove the row level protection if that is appropriate.

ACTIVATE ROW ACCESS CONTROL is ignored if row access control is already defined as activated for the table.

If the table is a system-period temporal table and row access control is not already activated on the history table, the database manager automatically activates row access control on the history table and creates a default row permission for the history table.

DEACTIVATE ROW ACCESS CONTROL

Specifies to deactivate row access control for the table. When the table is referenced in a data manipulation statement, any enabled row permissions defined on the table are not applied by Db2 to control the set of rows in the table that are accessible.

DEACTIVATE ROW ACCESS CONTROL is ignored if row access control is already defined as not activated for the table.

ACTIVATE COLUMN ACCESS CONTROL or DEACTIVATE COLUMN ACCESS CONTROL

Specifies whether enabled column masks are to be applied by Db2 to mask column values returned from the table.

ACTIVATE COLUMN ACCESS CONTROL

Specifies to activate column access control for the table. If the table is an alias, column access control is activated for the base table.

If a trigger exists for the table, the trigger must be defined with the SECURED attribute and must not be a READ trigger.

The table must not be referenced in the definition of a view if an INSTEAD OF trigger that is defined with the NOT SECURED attribute exists for the view.

The access to the table is not restricted but when the table is referenced in a data manipulation statement, all enabled column masks that have been created for the table are applied by Db2 to mask the values returned for the columns referenced in the final result table of the queries or to determine

the new values used in the data change statements. A column mask that gets an error when trying to be activated cannot be activated until any errors in the mask definition are resolved. This may require the column mask to be dropped and recreated with a modified definition.

If a materialized query table that depends on the table (directly, or indirectly through a view) for which column level access control is being activated and that materialized query table does not already have row level access control activated, row level access control is implicitly activated for the materialized query table. This restricts direct access to the contents of the materialized query table. A query that explicitly references the table before such a row permission is defined will return a warning that there is no data in the table. To provide access to the materialized query table, an appropriate row permission can be created, or an ALTER TABLE DEACTIVATE ROW ACCESS CONTROL on the materialized query table can be issued to remove the row level protection if that is appropriate.

ACTIVATE COLUMN ACCESS CONTROL is ignored if column access control is already defined as activated for the table.

If the table is a system-period temporal table and row access control is not already activated on the history table, the database manager automatically activates row access control on the history table and creates a default row permission for the history table.

DEACTIVATE COLUMN ACCESS CONTROL

Specifies to deactivate column access control for the table. When the table is referenced in a data manipulation statement, any enabled column masks defined on the table are not applied by Db2 to control the values returned for the columns referenced in the final result table of the queries or to determine whether the new values can be used in the data change statements.

DEACTIVATE COLUMN ACCESS CONTROL is ignored if column access control is already defined as not activated for the table.

VOLATILE or NOT VOLATILE

Indicates to the optimizer whether the cardinality of table *table-name* can vary significantly at run time. Volatility applies to the number of rows in the table, not to the table itself. The default is NOT VOLATILE.

VOLATILE

Specifies that the cardinality of *table-name* can vary significantly at run time, from empty to large. To access the table, the optimizer will typically use an index, if possible.

NOT VOLATILE

Specifies that the cardinality of *table-name* is not volatile. Access plans that reference this table will be based on the cardinality of the table at the time the access plan is built.

media-preference

Specifies the preferred storage media for the table or partition.

UNIT ANY

No storage media is preferred. Storage for the table or partition will be allocated from any available storage media. If UNIT ANY is specified on the table, any *media-preference* that is specified on a partition is used. If the table or partition is currently on solid state disk storage, it may be moved asynchronously onto other media, if available.

UNIT SSD

Solid state disk storage media is preferred. Storage for the table or partition may be allocated from solid state disk storage media, if available. If UNIT SSD is specified on the table, any *media-preference* specified on a partition is ignored. If the table or partition is not currently on solid state disk storage, it may be moved asynchronously onto solid state disk storage media, if available.

memory-preference

KEEP IN MEMORY

Specifies whether the data for the table should be brought into a main storage pool when the data is used in a query.

NO

The data will not be brought into a main storage pool.

YES

The data will be brought into a main storage pool.

Notes

Column references: A column can only be referenced *once* in an ADD, ALTER, or DROP COLUMN clause in a single ALTER TABLE statement. However, that same column can be referenced multiple times for adding or dropping constraints in the same ALTER TABLE statement.

Order of operations: The order of operations within an ALTER TABLE statement is:

- drop period
- drop constraints
- drop materialized query table
- drop partition
- drop partitioning
- drop columns for which the RESTRICT option was specified
- alter all other column definitions
 - drop columns for which the CASCADE option was specified
 - alter column drop attributes (for example, DROP DEFAULT)
 - alter column alter attributes
 - alter column add attributes
 - add columns
- alter partition
- add or alter materialized query table
- add partition or add partitioning
- add constraints
- add period

Within each of these stages, the order in which the user specifies the clauses is the order in which they are performed, with one exception. If any columns are being dropped, that operation is logically done before any column definitions are added or altered.

QTEMP considerations: Any views or logical files in another job's QTEMP that are dependent on the table being altered will be dropped as a result of an ALTER TABLE statement. These objects will not be dropped if the alter is changing cardinality, media preference, memory preference, adding or dropping constraints, activating or deactivating row and column access control, or when specifying ACTIVATE NOT LOGGED INITIALLY.

Authority checking: Authority checking is performed only on the table being altered and any object explicitly referenced in the ALTER TABLE statement (such as tables referenced in the fullselect). Other objects may be accessed by the ALTER TABLE statement, but no authority to those objects is required. For example, no authority is required on views that exist on the table being altered, nor on dependent tables that reference the table being altered through a referential constraint.

Backup recommendation: It is strongly recommended that a current backup of the table and dependent views and logical files exist prior to altering a table.

Performance considerations: The following performance considerations apply to an ALTER TABLE statement when adding, altering, or dropping columns from a table:

- The data in the table may be copied.⁸¹

Adding and dropping columns require the data to be copied.

Altering a column usually requires the data to be copied. The data does not need to be copied, however, if the alter only includes the following changes:

- The length attribute of a VARCHAR or VARBINARY column is increasing and the current length attribute is greater than 20.
- The length attribute of a VARGRAPHIC column is increasing and the current length attribute is greater than 10.
- The allocated length of a VARCHAR or VARBINARY column is changing and the current and new allocated lengths are both less than or equal to 20.
- The allocated length of a VARGRAPHIC column is changing and the current and new allocated lengths are both less than or equal to 10.
- The CCSID of a column is changing but no conversion is necessary between the old and new CCSID. For example, if one CCSID is 65535, no data conversion is necessary.
- The default value is changing, and the length of the default value is not greater than the current allocated length.
- DROP DEFAULT is specified.
- DROP NOT NULL is specified, but at least one nullable column will still exist in the table after the alter table is complete.

Altering a column that has a field procedure defined might require the field procedure to be run two times.

- Indexes may need to be rebuilt.⁸²

An index does not need to be rebuilt when columns are added to a table or when columns are dropped or altered and those columns are not referenced in the index key.

Altering a column that is used in the key of an index or constraint usually requires the index to be rebuilt. The index does not need to be rebuilt, however, in the following cases:

- The length attribute of a VARCHAR, VARBINARY, or VARGRAPHIC key is increasing.
- The CCSID of a column is changing but no conversion is necessary between the old and new CCSID. For example, if one CCSID is 65535.

Adding a generated column: When you add a row change timestamp column, row-begin column, row-end column, transaction-start-ID column, or generated expression column to an existing table, the initial values are generated during the alter operation.

Considerations for implicitly hidden columns: A column that is defined as implicitly hidden can be explicitly referenced on the ALTER statement. For example, an implicitly hidden column can be altered, can be specified as part of a referential constraint or a check constraint, or a materialized query table definition.

Altering materialized query tables: The isolation level at the time when a base table is first altered to become a materialized query table by the ALTER TABLE statement is the isolation level for the materialized query table.

Altering a table to change it to a materialized query table with query optimization enabled makes the table eligible for use in optimization. Therefore, ensure that the data in the table is accurate. The DATA INITIALLY IMMEDIATE clause can be used to refresh the data when the table is altered.

ATTACH PARTITION effects on dependent views, indexes, and materialized query tables:

- Views and DDS-created logical files on the source table are dropped.
- Views that reference the target table will now include the new partition.

⁸¹ In cases where enough storage does not exist to make a complete copy, a special copy that only requires approximately 16-32 megabytes of free storage is performed.

⁸² Any indexes that need to be rebuilt are rebuilt asynchronously by database server jobs.

- DDS-created logical files that referenced all the partitions prior to the attach will now include the new partition.
- Materialized query tables on the source table are dropped.
- Materialized query tables on the target table will be preserved but users will need to refresh the materialized query tables to include the data associated with the new partition.
- Partitioned (non-spanning) indexes on the source table that correspond to partitioned indexes on the target table will be preserved as part of the target table's partitioned index as long as the logical page size of the index is the same. If the logical page size is different, the index over that partition will be dropped.
- Partitioned (non-spanning) indexes on the source table that do not correspond to partitioned indexes on the target table will be dropped.
- Partitioned (non-spanning) indexes on the target table that do not correspond to indexes on the source table will be modified to include the new partition.
- Non-partitioned (spanning) indexes on the target table will be rebuilt to include the new partition.

DETACH PARTITION effects on dependent views, indexes, and materialized query tables:

- Views on the source table will no longer include the detached partition.
- DDS-created logical files that referenced all the partitions prior to the detach will include the remaining partitions.
- Materialized query tables on the source table will be preserved but users will need to refresh the materialized query tables to remove the data associated with the detached partition.
- Any partitioned (non-spanning) index on the source table will be modified to remove the detached partition index.
- Any non-partitioned (spanning) index on the source table will be rebuilt.

Considerations for using row access control and column access control:

Row access control that is activated explicitly: The ACTIVATE ROW ACCESS CONTROL clause is used to activate row access control for a table. When this happens, a default row permission is implicitly created and allows no access to any rows of the table, unless later another enabled row permission exists that provides access for the authorization IDs that are specified in the definition of the permission. The default row permission is always enabled.

When the table is referenced in a data manipulation statement, all enabled row permissions that have been created for the table, including the default row permission, are implicitly applied by Db2 to control which rows in the table are accessible. A row access control search condition is derived by application of the logical OR operator to the search condition in each enabled row permission. This derived search condition acts as a filter to the table before any user specified operations such as predicates, grouping, ordering, etc. are processed. This derived search condition permits the authorization IDs that are specified in the permission definitions to access certain rows in the table. See the description of subselect for information on how the application of enabled row permissions affects the fetch operation. See the data change statements for information on how the application of enabled row permissions affects the data change operation.

Row access control remains enforced until the DEACTIVATE ROW ACCESS CONTROL clause is used to stop enforcing it.

Implicit row permission that is created when row access control is activated for a table: When the ACTIVATE ROW ACCESS CONTROL clause is used to activate row access control for a table, Db2 implicitly creates a default row permission for the table. The default row permission prevents all access to the table. The implicitly created row permission is in the same schema of the base table and has a name in the form of QIBM_DEFAULT_ *system-table-name_system_schema_name*.

The default row permission is always enabled.

The default row permission is dropped when row access control is deactivated or when the table is dropped.

Activating column access control: The `ACTIVATE COLUMN ACCESS CONTROL` clause is used to activate column access control for a table. The access to the table is not restricted but when the table is referenced in a data manipulation statement, all enabled column masks that have been created for the table are applied to mask the column values referenced in the final result table of the query or to determine the new values used in the data change statements.

When column masks are used to mask the column values, they determine the values in the final result table. If a column has a column mask and the column (a simple reference to a column name or embedded in an expression) appears in the outermost select list, the column mask is applied to the column to produce the value for the final result table. If the column does not appear in the outermost select list but it participates in the final result table, for example, it appears in a nested table expression or view, the column mask is applied to the column returned in the result table of the nested table expression or view so that it can be used in the final result table.

The application of column masks does not interfere with the operations of other clauses within the statement such as the `WHERE`, `GROUP BY`, `HAVING`, `SELECT DISTINCT`, and `ORDER BY`. The rows returned in the final result table remain the same, except that the values in the resultant rows might have been masked by the column masks. As such, if the masked column also appears in an `ORDER BY` sort-key, the order is based on the original column values and the masked values in the final result table might not reflect that order. Similarly, the masked values might not reflect the uniqueness enforced by `SELECT DISTINCT`. If the masked column is embedded in an expression, the result of the expression can become different because the column mask is applied on the column before the expression evaluation can take place. For example, applying a column mask on column `SSN` can change the result of aggregate function `COUNT(DISTINCT SSN)` because the `DISTINCT` operation is performed on the masked values. On the other hand, if the expression in a query is the same as the expression used to mask the column value in the column mask definition, the result of the expression in the query might remain unchanged. For example, the expression in the query is `'XXX-XX-' || SUBSTR(SSN, 8, 4)` and the same expression appears in the column mask definition. In this particular example, the user can replace the expression in the query with column `SSN` to avoid the same expression being evaluated twice.

The following are the contexts where the column masks are used by Db2 to mask the column values for the result of a query. Certain restrictions might apply to some contexts. Those restrictions are described in a separate list.

- The outermost `SELECT` clause of a `SELECT` or `SELECT INTO` statement, or if the column does not appear in the outermost select list but it participates in the final result table, the outermost `SELECT` clause of the corresponding nested table expression, common table expression, or view where the column appears.
- The outermost `SELECT` clause that is used to derive the new values for an `INSERT`, `UPDATE`, or `MERGE` statement.
- A scalar-fullselect expression that appears in the outermost `SELECT` clause of the above statements, the right side of a `SET` variable assignment statement, the `VALUES INTO` statement, or the `VALUES` statement.

A column mask is created without knowing all of the contexts in which it might be used. To mask a column value in the final result table, the column mask definition is merged into the statement by Db2. When the column mask definition is brought into the context of the statement, it might conflict with certain SQL semantics in the statement. Therefore, in some situations the combination of the statement and the application of a column mask can return an error. The following describes when the error might be returned:

- If the `FROM` clause in a subselect references a recursive common table expression, and if the result of the recursive common table expression is used to derive the final result table, the column mask cannot be applied to a column that is referenced in the fullselect of the recursive common table expression.
- If a user-defined function is defined with the `NOT SECURED` option, the argument of the function must not reference a column for which a column mask is enabled and column access control is activated for its table. This rule applies to user-defined functions that are referenced anywhere in the statement.

To avoid the above error situations, one of the following actions must be taken:

- modify or remove the above contexts from the statement

- disable the column mask
- drop the column mask, modify the definition, and recreate the column mask
- deactivate column access control for the table

In some situations, if the statement contains a SELECT DISTINCT or a GROUP BY and a column mask is applied to a column that directly or indirectly derives the result of SELECT DISTINCT or GROUP BY, the statement might return a result that is not deterministic. These situations include:

- The column mask definition references other columns from the same table as the column to which the column mask is applied.
- The column is referenced in the argument of built-in scalar functions (such as COALESCE, IFNULL, NULLIF, MAX, MIN, LOCATE).
- The column is referenced in the argument of an aggregate function.
- The column is embedded in an expression and the expression contains a function that is not deterministic or has an external action.

If the column is not nullable, the definition of its column mask will not, most likely, consider a null value for the column. After the column access control is activated for the table, if the table is the null-padded table in an outer join, the value of the column in the final result table might be a null. To ensure that the column mask can mask a null value, if the table is the null-padded table in an outer join, Db2 will add "WHEN target-column IS NULL THEN NULL" as the first WHEN clause to the column mask definition. This forces a null value to always be masked as a null value. For a nullable column, this removes the ability to mask a null value as something else. Example 4 shows this added WHEN clause.

For INSERT, UPDATE, and MERGE, when a column is referenced while deriving the values of a new row, if that column has an enabled column mask, the masked value is used to derive the new values. If the object table also has column access control activated, the column mask that is applied to derive the new values must return the column itself, not a constant or an expression. If the column mask does not mask the column to itself, the new value cannot be used for insert or update and an error is returned. The rules that are used to apply column masks in order to derive the new values follow the same rules described above for the final result table of a query. See the data change statements for how the column masks are used to affect the insertability and updatability.

A column mask can be applied only to a base table column. If a view, nested table expression, or common table expression column is involved in the final result table, the above error situations can occur inside the view, nested table expression, or common table expression.

Column access control does not affect the XMLTABLE built-in function. If the input to the XMLTABLE function is a column with a column mask, the column mask is not applied.

Column access control remains activated until the DEACTIVATE COLUMN ACCESS CONTROL clause is used to stop enforcing it.

Column masks and trigger transition variables: Values for OLD ROW and OLD TABLE transition variables will never contain masked values.

A SET *transition-variable* assignment statement can assign masked data to the variable. If a violation check constraint does not exist for the column, the masked data will be inserted or updated in the column and no error will be issued.

Stop enforcing row or column access control: The DEACTIVATE ROW ACCESS CONTROL clause is used to stop enforcing row access control for a table. The default row permission is dropped. Thereafter, when the table is referenced in a data manipulation statement, explicitly created row permissions are not applied. The table is accessible based on the granted privileges.

The DEACTIVATE COLUMN ACCESS CONTROL clause is used to stop enforcing column access control for a table. Thereafter, when the table is referenced in a data manipulation statement, the column masks are not applied. The unmasked column values are used for the final result table. The explicitly created row permissions or column masks, if any, remain but have no effect.

Secure triggers for row and column access control: Triggers are used for database integrity, and as such a balance between row and column access control (security) and database integrity is needed. Enabled

row permissions and column masks are not applied to the initial values of transition variables and transition tables. Row and column access control enforced for the triggering table is also ignored for any transition variables or transition tables referenced in the trigger body. To ensure there is no security concern for SQL statements in the trigger action to access sensitive data in transition variables and transition tables, the trigger must be created or altered with the SECURED option. If a trigger is not secure, row and column access control cannot be enforced for the triggering table.

Secure user-defined functions for row and column access control: If a row permission or column mask definition references a user-defined function, the function must be altered with the SECURED option because the sensitive data might be passed as arguments to the function.

Db2 considers the SECURED option an assertion that declares the user has established a change control audit procedure for all changes to the user-defined function. It is assumed that such a control audit procedure is in place for all versions of the user-defined function, and that all subsequent ALTER FUNCTION statements or changes to external programs are being reviewed by this audit process.

Database operations where row and column access control is not applicable: Row and column access control must not compromise database integrity. Columns involved in primary keys, unique keys, indexes, check constraints, and referential integrity must not be subject to row and column access control. Column masks can be defined for those columns but they are not applied during the process of key building or constraint or RI enforcement.

Defining a system-period temporal table: A system-period temporal table definition includes the following aspects:

- A system period named SYSTEM_TIME which is defined using a row-begin column and a row-end column. See [“AS ROW BEGIN” on page 875](#), [“AS ROW END” on page 875](#), and [“ADD PERIOD FOR period-definition” on page 892](#)
- A transaction-start-ID column. See [“AS TRANSACTION START ID” on page 875](#)
- A system-period data versioning definition specified on a subsequent ALTER TABLE statement using the ADD VERSIONING action which includes the name of the associated history table. See [“ADD VERSIONING USE HISTORY TABLE history-table-name” on page 892](#).

Considerations for transaction-start-ID columns: A transaction-start-ID column contains a null value if the column allows null values and there is a row-begin column and the value of the row-begin column is unique from values of row-begin columns generated for other transactions. Given that the column may contain null values, it is recommended that one of the following methods be used when retrieving a value from the column:

- COALESCE (transaction_start_id_col, row_begin_col)
- CASE WHEN transaction_start_id_col IS NOT NULL THEN transaction_start_id_col ELSE row_begin_col END

Considerations for system-period temporal tables and row and column access control: Row and column access control can be defined on both the system-period temporal table and the associated history table.

- When a system-period temporal table is accessed, any row and column access rules defined on the system-period temporal table are applied to all of the rows returned from the system-period temporal table, regardless of whether the rows are stored in the system-period temporal table or the history table. The row and column access rules defined on the history table are not applied.
- When the history table is accessed directly, the row and column access rules defined on the history table are applied.

When a system-period temporal table is defined and row access control or column access control is activated for the system-period temporal table and row access control is not already activated on the history table, the database manager automatically activates row access control on the history table and creates a default row permission for the history table.

Managing a history table: For an authorized user, limited modifications can be made directly to the history table. Rows can be deleted from the table and partitions can be added or dropped.

Read-only cursors and read-only views: The rules that are used to determine a read-only cursor or a read-only view remain unaffected by row and column access control. The effect of application of enabled column masks is not known until run time. Therefore, the data change operation on a writable cursor or a writable view could still fail at run time.

Syntax alternatives: The following syntax is supported for compatibility to prior releases. The syntax is non-standard and should not be used:

- INLINE LENGTH is a synonym for ALLOCATE.
- If an ADD constraint is the first clause of the ALTER TABLE statement, the ADD keyword is optional, but strongly recommended. Otherwise, it is required.
- *constraint-name* (without the CONSTRAINT keyword) may be specified following the FOREIGN KEY keywords in a *referential-constraint*.
- PART is a synonym for PARTITION.
- PARTITION *partition-number* may be specified instead of PARTITION *partition-name*. A *partition-number* must not identify an existing partition of the table or a partition that was previously specified in the ALTER TABLE statement.

If a *partition-number* is not specified, a unique partition number is generated by the database manager.

- VALUES is a synonym for ENDING AT.
- SET MATERIALIZED QUERY AS DEFINITION ONLY is a synonym for DROP MATERIALIZED QUERY.
- SET SUMMARY AS DEFINITION ONLY is a synonym for DROP MATERIALIZED QUERY
- SET MATERIALIZED QUERY AS (*select-statement*) is a synonym for ADD MATERIALIZED QUERY (*select-statement*)
- SET SUMMARY AS (*select-statement*) is a synonym for ADD MATERIALIZED QUERY (*select-statement*)

Cascaded Effects

Adding a column has no cascaded effects to SQL views, materialized query tables, or most logical files. For example, adding a column to a table does not cause the column to be added to any dependent views, even if those views were created with a SELECT * clause.

Adding a column does cause any SQL triggers to be recreated and include the new column.

Dropping or altering a column may cause several cascaded effects. [Table 80 on page 902](#) lists the cascaded effects of dropping a column.

<i>Table 80. Cascaded effects of dropping a column</i>		
Operation	RESTRICT Effect	CASCADE Effect
Drop of a column referenced by a view	The drop of the column is not allowed.	The view and all views dependent on that view are dropped.

⁸³ A column will also be added to a logical file that shares its physical file's format when a column is added to that physical file (unless that format is used again in the logical file with another based-on file).

Table 80. Cascaded effects of dropping a column (continued)

Operation	RESTRICT Effect	CASCADE Effect
Drop of a column referenced by a non-view logical file	<p>The drop is allowed, and the column is dropped from the logical file if:</p> <ul style="list-style-type: none"> • The logical file shares a format with the file being altered, and • The dropped column is not used as a key field or in select/omit specifications, and • That format is not used again in the logical file with another based-on file. <p>Otherwise, the drop of the column is not allowed.</p>	<p>The drop is allowed, and the column is dropped from the logical file if:</p> <ul style="list-style-type: none"> • The logical file shares a format with the file being altered, and • The dropped column is not used as a key field or in select or omit specifications, and • That format is not used again in the logical file with another based-on file. <p>Otherwise, the logical file is dropped.</p>
Drop of a column referenced in an index as part of a key, in the WHERE clause, in the INCLUDE clause, or as an explicit or implicit column in the ADD columns clause	<p>The drop of the index is not allowed.</p>	<p>The index is dropped.</p>
Drop of a column referenced in the key of an keyed physical file where the key is not a PRIMARY KEY	<p>The physical file is changed to a non-keyed physical file.</p>	<p>The physical file is changed to a non-keyed physical file.</p>
Drop of a column referenced in a unique constraint	<p>If all the columns referenced in the unique constraint are dropped in the same ALTER COLUMN statement and the unique constraint is not referenced by a referential constraint, the columns and the constraint are dropped. (Hence, the index used to satisfy the constraint is also dropped.) For example, if column A is dropped, and a unique constraint of UNIQUE (A) or PRIMARY KEY (A) exists and no referential constraints reference the unique constraint, the operation is allowed.</p> <p>Otherwise, the drop of the column is not allowed.</p>	<p>The unique constraint is dropped as are any referential constraints that refer to that unique constraint. (Hence, any indexes used by those constraints are also dropped).</p>

Table 80. Cascaded effects of dropping a column (continued)

Operation	RESTRICT Effect	CASCADE Effect
Drop of a column referenced in a referential constraint	If all the columns referenced in the referential constraint are dropped at the same time, the columns and the constraint are dropped. (Hence, the index used by the foreign key is also dropped). For example, if column B is dropped and a referential constraint of FOREIGN KEY (A) exists, the operation is allowed. Otherwise, the drop of the column is not allowed.	The referential constraint is dropped. (Hence, the index used by the foreign key is also dropped).
Drop of a column referenced in an SQL trigger	The drop of the column is not allowed.	The SQL trigger is dropped.
Drop of a column referenced in an MQT	The drop of the column is not allowed.	The MQT is dropped.

Table 81 on page 904 lists the cascaded effects of altering a column. (Alter of a column in the following chart means altering a data type, precision, scale, length, or nullability characteristic.)

Table 81. Cascaded effects of altering a column

Operation	Effect
Alter of a column referenced by a view	The alter is allowed. The views that are dependent on the table will be recreated. The new column attributes will be used when recreating the views.
Alter of a column referenced by a non-view logical file	The alter is allowed. The non-view logical files that are dependent on the table will be recreated. If the logical file shares a format with the file being altered, and that format is not used again in the logical file with another based-on file, the new column attributes will be used when recreating the logical file. Otherwise, the new column attributes will not be used when recreating the logical file. Instead, the current logical file attributes are used.
Alter of a column referenced in the key of an index.	The alter is allowed. (Hence, the index will usually be rebuilt.)
Alter of a column referenced in a unique constraint	The alter is allowed. (Hence, the index will usually be rebuilt.) If the unique constraint is referenced by a referential constraint, the attributes of the foreign keys no longer match the attributes of the unique constraint including the field procedure. The constraint will be placed in a defined and check-pending state.

Table 81. Cascaded effects of altering a column (continued)

Operation	Effect
Alter of a column referenced in a referential constraint	The alter is allowed. <ul style="list-style-type: none"> • If the referential constraint is in the defined but check-pending state, the alter is allowed and an attempt is made to put the constraint in the enabled state. (Hence, the index used to satisfy the unique constraint will usually to be rebuilt.) • If the referential constraint is in the enabled state, the constraint is placed in the defined and check-pending state.
Alter of a column referenced in an SQL trigger	The trigger is recreated.
Alter of a column referenced in an MQT	The MQT is recreated to include the new attributes.

Examples

Example 1: Add a new column named RATING, which is one character long, to the DEPARTMENT table.

```
ALTER TABLE DEPARTMENT
ADD RATING CHAR
```

Example 2: Add a new column named PICTURE_THUMBNAIL to the EMPLOYEE table. Create PICTURE_THUMBNAIL as a BLOB column with a maximum length of 1K characters.

```
ALTER TABLE EMPLOYEE
ADD PICTURE_THUMBNAIL BLOB(1K)
```

Example 3: Assume a new table EQUIPMENT has been created with the following columns:

```
EQUIP_NO
INT
```

```
EQUIP_DESC
VARCHAR(50)
```

```
LOCATION
VARCHAR(50)
```

```
EQUIP_OWNER
CHAR(3)
```

Add a referential constraint to the EQUIPMENT table so that the owner (EQUIP_OWNER) must be a department number (DEPTNO) that is present in the DEPARTMENT table. If a department is removed from the DEPARTMENT table, the owner (EQUIP_OWNER) values for all equipment owned by that department should become unassigned (or set to null). Give the constraint the name DEPTQUIP.

```
ALTER TABLE EQUIPMENT
FOREIGN KEY DEPTQUIP (EQUIP_OWNER)
REFERENCES DEPARTMENT
ON DELETE SET NULL
```

Change the default value for the EQUIP_OWNER column to 'ABC'.

```
ALTER TABLE EQUIPMENT
ALTER COLUMN EQUIP_OWNER
SET DEFAULT 'ABC'
```

Drop the LOCATION column. Also drop any views, indexes, or constraints that are built on that column.

```
ALTER TABLE EQUIPMENT  
DROP COLUMN LOCATION CASCADE
```

Alter the table so that a new column called SUPPLIER is added, the existing column called LOCATION is dropped, a unique constraint over the new column SUPPLIER is added, and a primary key is built over the existing column EQUIP_NO.

```
ALTER TABLE EQUIPMENT  
ADD COLUMN SUPPLIER INT  
DROP COLUMN LOCATION  
ADD UNIQUE SUPPLIER  
ADD PRIMARY KEY EQUIP_NO
```

Notice that the column EQUIP_DESC is a variable length column. If an allocated length of 25 was specified, the following ALTER TABLE statement would not change that allocated length.

```
ALTER TABLE EQUIPMENT  
ALTER COLUMN EQUIP_DESC  
SET DATA TYPE VARCHAR(60)
```

Example 4: Alter the EMPLOYEE table. Add the check constraint named REVENUE defined so that each employee must make a total of salary and commission greater than \$30,000.

```
ALTER TABLE EMPLOYEE  
ADD CONSTRAINT REVENUE  
CHECK (SALARY + COMM > 30000)
```

Example 5: Alter EMPLOYEE table. Drop the constraint REVENUE which was previously defined.

```
ALTER TABLE EMPLOYEE  
DROP CONSTRAINT REVENUE
```

Example 6: Alter the EMPLOYEE table. Alter the column PHONENO to accept up to 20 characters for a phone number.

```
ALTER TABLE EMPLOYEE  
ALTER COLUMN PHONENO SET DATA TYPE VARCHAR (20)
```

Example 7: Alter the base table TRANSCOUNT to a materialized query table. The result of the *select-statement* must provide a set of columns that match the columns in the existing table (same number of columns and compatible attributes).

```
ALTER TABLE TRANSCOUNT  
ADD MATERIALIZED QUERY  
(SELECT ACCTID, LOCID, YEAR, COUNT(*) AS CNT  
 FROM TRANS  
 GROUP BY ACCTID, LOCID, YEAR )  
DATA INITIALLY DEFERRED  
REFRESH DEFERRED  
MAINTAINED BY USER
```

Example 8: Alter the CUSTOMER table to allow versioning.

First, add the columns and the period definition that are required for versioning along with two columns that will be used for tracking identity of row changes:

```
ALTER TABLE CUSTOMER  
ADD COLUMN SYSTEM_START TIMESTAMP(12) NOT NULL GENERATED ALWAYS AS ROW BEGIN  
ADD COLUMN SYSTEM_END TIMESTAMP(12) NOT NULL GENERATED ALWAYS AS ROW END  
ADD COLUMN TRANSACTION_ID TIMESTAMP(12) GENERATED ALWAYS AS TRANSACTION START ID  
ADD COLUMN AUDIT_TYPE_CHANGE CHAR(1) GENERATED ALWAYS AS (DATA CHANGE OPERATION)  
ADD COLUMN AUDIT_USER VARCHAR(128) GENERATED ALWAYS AS (SESSION_USER)  
ADD PERIOD FOR SYSTEM_TIME (SYSTEM_START, SYSTEM_END);
```

Next, create the history table:

```
CREATE TABLE CUSTOMER_HISTORY LIKE CUSTOMER;
```

Finally, define a versioned relationship for the tables:

```
ALTER TABLE CUSTOMER ADD VERSIONING USE HISTORY TABLE CUSTOMER_HISTORY
ON DELETE ADD EXTRA ROW;
```

Examples for column access control

Example 1: Based on the data in the CUSTOMER table, the SELECT DISTINCT statement returns one row with the SALARY value 100,000. A column mask, SALARY_MASK, is created to mask the salary value. After column access control is activated for the CUSTOMER table, the column mask is applied to SALARY column. A user with the 'MGR' authorization ID issues a SELECT DISTINCT statement. The SELECT DISTINCT statement still returns one row because the removal of duplicates is based on the unmasked value of the SALARY column, but the value that is returned in that row is based on the masked SALARY value, which can be either 125,000 or 110,000.

The table CUSTOMER contains:

SALARY	COMMISSION	EMPID
100,000	25,000	123456
100,000	10,000	654321

```
CREATE MASK SALARY_MASK ON CUSTOMER
FOR COLUMN SALARY RETURN
CASE WHEN (SESSION_USER = 'MGR')
THEN SALARY + COMMISSION
ELSE SALARY
END
ENABLE;

COMMIT;

ALTER TABLE CUSTOMER
ACTIVATE COLUMN ACCESS CONTROL;

COMMIT;

SELECT DISTINCT SALARY FROM CUSTOMER;
```

Example 2: Based on the data in T1 and T2 tables, the SELECT DISTINCT statement using the COALESCE function returns one row with the T1.C1 value of 1. A column mask, C1_MASK, is created to mask the value of T1.C1. After column access control is activated for table T1, the column mask is applied to column C1 of table T1. A user with the 'EMP' authorization ID issues a SELECT DISTINCT statement. The SELECT DISTINCT statement still returns one row because the removal of duplicates is based on the unmasked value of T1.C1 from the COALESCE function, but the value that is returned in that row is based on the masked value of T1.C1 from the COALESCE function. The returned value can be either 2 or 3.

```
INSERT INTO T1(C1) VALUES(1);
INSERT INTO T1(C1) VALUES(1);

INSERT INTO T2(C1) VALUES(2);
INSERT INTO T2(C1) VALUES(3);

CREATE MASK C1_MASK ON T1
FOR COLUMN C1 RETURN
CASE WHEN (SESSION_USER = 'EMP')
THEN NULL
ELSE C1
END
ENABLE;

COMMIT;

ALTER TABLE T1
ACTIVATE COLUMN ACCESS CONTROL;

COMMIT;
```

```
SELECT DISTINCT COALESCE(T1.C1, T2.C1) FROM T1, T2;
```

Example 3: Based on the data in the CUSTOMER table, the maximum income is the same in the states CA and IL, 50,000, thus, the SELECT DISTINCT statement returns one row. A column mask, INCOME_MASK, is created to mask the income value. After column access control is activated for the CUSTOMER table, the column mask is applied to the INCOME column before the MAX aggregate function is evaluated. However, the INCOME_MASK column mask, masks the income value of 0 as 100,000 in state IL. As a result, the maximum income becomes 100,000 for state IL, but the maximum income is still 50,000 for state CA. X.B is used in a predicate in the SELECT DISTINCT statement, therefore, the original INCOME values and the original results of the MAX(INCOME) function must be preserved. So the SELECT DISTINCT statement still returns one row, but the value in that row might not be deterministic, that is, the value might be 50,000 from the 'CA' row or might be 100,000 from the 'IL' row.

The CUSTOMER table contains:

STATE	INCOME
CA	40,000
CA	50,000
IL	0
IL	10,000
IL	50,000

```
CREATE MASK INCOME_MASK ON CUSTOMER
FOR COLUMN INCOME RETURN
CASE WHEN(INCOME = 0)
THEN 100000
ELSE INCOME
END
ENABLE;

COMMIT;

ALTER TABLE CUSTOMER
ACTIVATE COLUMN ACCESS CONTROL;

COMMIT;

SELECT DISTINCT B FROM
(SELECT STATE, MAX(INCOME) FROM CUSTOMER
GROUP BY STATE)
X(A, B)
WHERE B > 10000;
```

Example 4: The expression INCOME + RAND() is not deterministic because the RAND function is not deterministic. Based on the data in the CUSTOMER table, the SELECT DISTINCT statement will, most likely, return two distinct rows. However, it could return only one row. A column mask, INCOME_MASK, is created to mask the income value. After column access control is activated for the CUSTOMER table, the column mask is applied to the INCOME column, which causes the masked value for both rows to be the same. Because the RAND function is not deterministic, the SELECT DISTINCT statement will, most likely, still return two distinct rows, but it could return only one row. The uncertainty caused by the RAND function causes the result of the SELECT DISTINCT statement to not be deterministic.

The CUSTOMER table contains:

STATE	INCOME
CA	40,000
CA	50,000

```
CREATE MASK INCOME_MASK ON CUSTOMER
FOR COLUMN INCOME RETURN
```

```

CASE WHEN(INCOME = 40,000)
  THEN 50000
  ELSE INCOME
END
ENABLE;

COMMIT;

ALTER TABLE CUSTOMER
  ACTIVATE COLUMN ACCESS CONTROL;

COMMIT;

SELECT DISTINCT A FROM
  (SELECT INCOME + RAND() FROM CUSTOMER)
  X(A)
WHERE A > 10000;

```

Example 5: A column mask, STATE_MASK, is created for the STATE column of the CUSTOMER table to return a value that shows the city name with the state if the city is SJ, SFO, or OKLD. Otherwise the city is not returned, just the state. After column access control is activated for the CUSTOMER table, a SELECT statement which groups results using the STATE column is issued. However, because the CITY column that is referenced in the STATE_MASK column mask is not a grouping column, an error is returned to signify that the STATE_MASK column mask is not appropriate for this statement.

The CUSTOMER table contains:

STATE	CITY	INCOME
CA	SJ	40,000
CA	SC	30,000
CA	SB	60,000
CA	SFO	80,000
CA	OKLD	50,000
CA	SJ	70,000
NY	NY	50,000

```

CREATE MASK STATE_MASK ON CUSTOMER
FOR COLUMN STATE RETURN
CASE WHEN(CITY = 'SJ')
  THEN CITY||', '||STATE
  WHEN(CITY = 'SFO')
  THEN CITY||', '||STATE
  WHEN(CITY = 'OKLD')
  THEN CITY||', '||STATE
  ELSE STATE
END
ENABLE;

COMMIT;

ALTER TABLE CUSTOMER
  ACTIVATE COLUMN ACCESS CONTROL;

COMMIT;

SELECT STATE, AVG(INCOME) FROM CUSTOMER
  GROUP BY STATE
  HAVING STATE = 'CA';

```

ALTER TRIGGER

The ALTER TRIGGER statement changes the description of the trigger at the current server.

Invocation

This statement can be embedded in an application program or issued interactively. It is an executable statement that can be dynamically prepared.

Authorization

If ENABLE or DISABLE is specified, the privileges held by the authorization ID of the statement must include at least one of the following:

- For the trigger identified in the statement:
 - The system authority *USE on the Change Physical File Trigger (CHGPFTRG) command,
 - The ALTER privilege on the table or view on which the trigger is defined, and
 - The USAGE privilege on the schema containing the trigger.
- Database administrator authority

If the SECURED option is specified, or if the NOT SECURED option is specified and the trigger is currently secured:

- The authorization ID of the statement must have security administrator authority. See [“Administrative authority”](#) on page 15.

For information about the system authorities corresponding to SQL privileges, see [Corresponding System Authorities When Checking Privileges to a Table or View](#).

Syntax

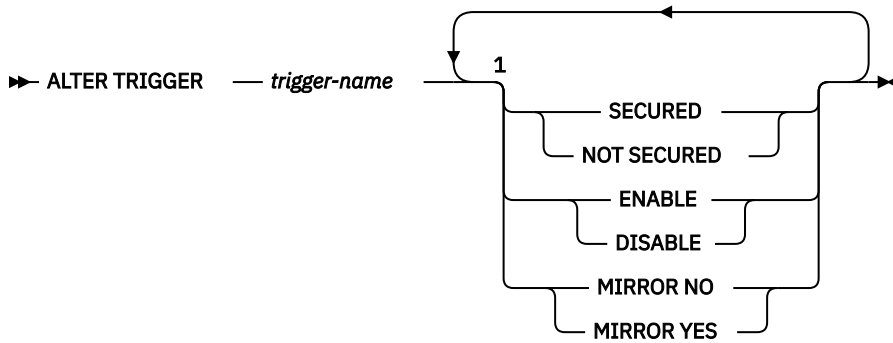

Notes:

¹ The same clause must not be specified more than one time.

Description

trigger-name

Identifies the trigger to be altered. The *trigger-name* must identify a trigger that exists at the current server. It can be either an SQL or a native trigger.

SECURED or NOT SECURED

Specifies whether the trigger is considered secure for row and column access control. If row or column access control is active for the triggering table, altering the trigger from SECURED to NOT SECURED will return an error.

SECURED

Specifies that the trigger is considered secure for row access control and column access control.

SECURED must be specified for a trigger whose subject table is using row access control or column access control. SECURED must also be specified for a trigger that is created for a view and one or more of the underlying tables in the view definition is using row access control or column access control.

NOT SECURED

Specifies that the trigger is considered not secure for row access control and column access control.

NOT SECURED must not be specified for a trigger whose subject table is using row access control or column access control. NOT SECURED must also not be specified for a trigger that is created for a view and one or more of the underlying tables in the view definition is using row access control or column access control.

ENABLE or DISABLE

Specifies the state to which the trigger is to be changed.

ENABLE

The trigger will be fired during the appropriate data change operations.

DISABLE

The trigger will not be fired during the appropriate data change operations.

MIRROR NO or MIRROR YES

Specifies where the trigger will be fired in a mirrored environment. This option is ignored if the table on which the trigger is defined is not replicated.

MIRROR NO

In a mirrored environment, the trigger will be fired only on the source node.

MIRROR YES

In a mirrored environment, the trigger will be fired on both nodes in the mirrored pair when the replication state is ACTIVE. If the replication state is TRACKING, the trigger will fire on the primary node. It will never be fired on the secondary node for any changes made while in TRACKING state.

MIRROR YES is not allowed for an INSTEAD OF trigger or any trigger that is defined as MODE DB2SQL.

Notes

Altering a trigger from NOT SECURED to SECURED: The trigger is considered secure after the ALTER TRIGGER statement is executed. Db2 treats the SECURED attribute as an assertion that declares that the user has established an audit procedure for all activities in the trigger body. If a secure trigger references user-defined functions, Db2 assumes those functions are secure without validation. If those functions can access sensitive data, a user with security administrator authority needs to ensure that those functions are allowed to access that data and that an audit procedure is in place for those functions, and that all subsequent ALTER FUNCTION statements are being reviewed through this audit process.

Transition variable values and row and column access control: Row and column access control is not enforced for transition variables and transition tables. If row or column access control is enforced for the triggering table, row permissions and column masks are not applied to the initial values of transition variables and transition tables. Row and column access control enforced for the triggering table is also ignored for transition variables and transition tables that are referenced in the trigger body or are passed as arguments to user-defined functions invoked within the trigger body. To ensure there are no security concerns for SQL statements accessing sensitive data in transition variables and transition tables, the trigger must be created with the SECURED option. If the trigger is not secure, row access control and column access control cannot be enforced for the triggering table.

Example

Example 1: Change the definition of trigger TRIGGER1 to secured:

```
ALTER TRIGGER TRIGGER1
SECURED
```

Example 2: Change the definition of trigger TRIGGER1 to not secured:

```
ALTER TRIGGER TRIGGER1
NOT SECURED
```

ASSOCIATE LOCATORS

The ASSOCIATE LOCATORS statement gets the result set locator value for each result set returned by a procedure.

Invocation

This statement can be embedded in an application program. It is an executable statement that can be dynamically prepared. It cannot be issued interactively. It must not be specified in REXX.

Authorization

None required.

Syntax

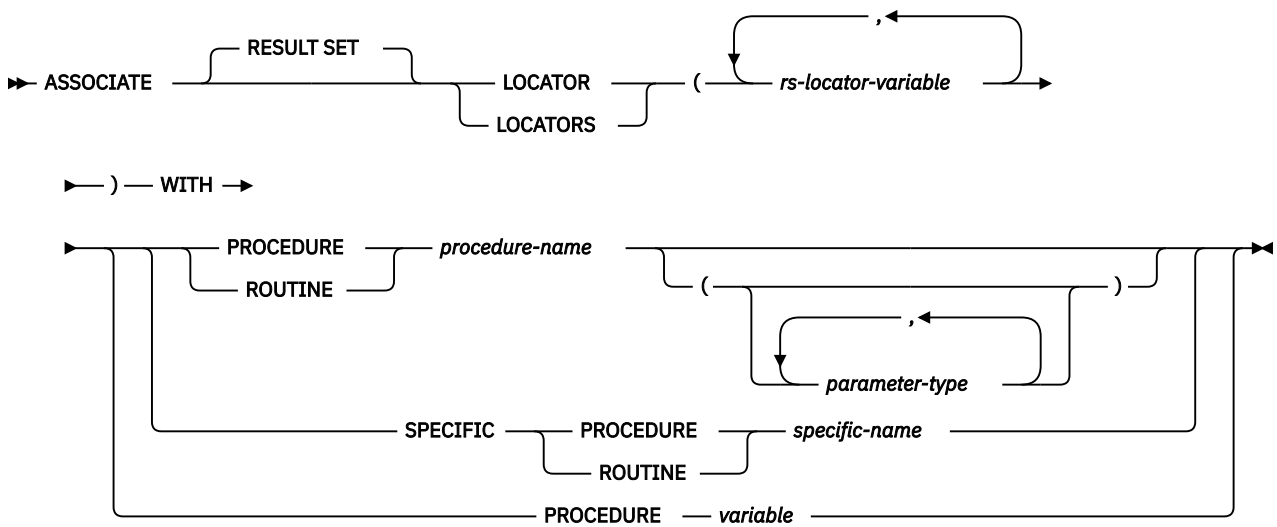

parameter-type

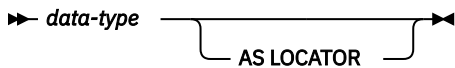

data-type

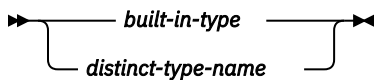

built-in-type

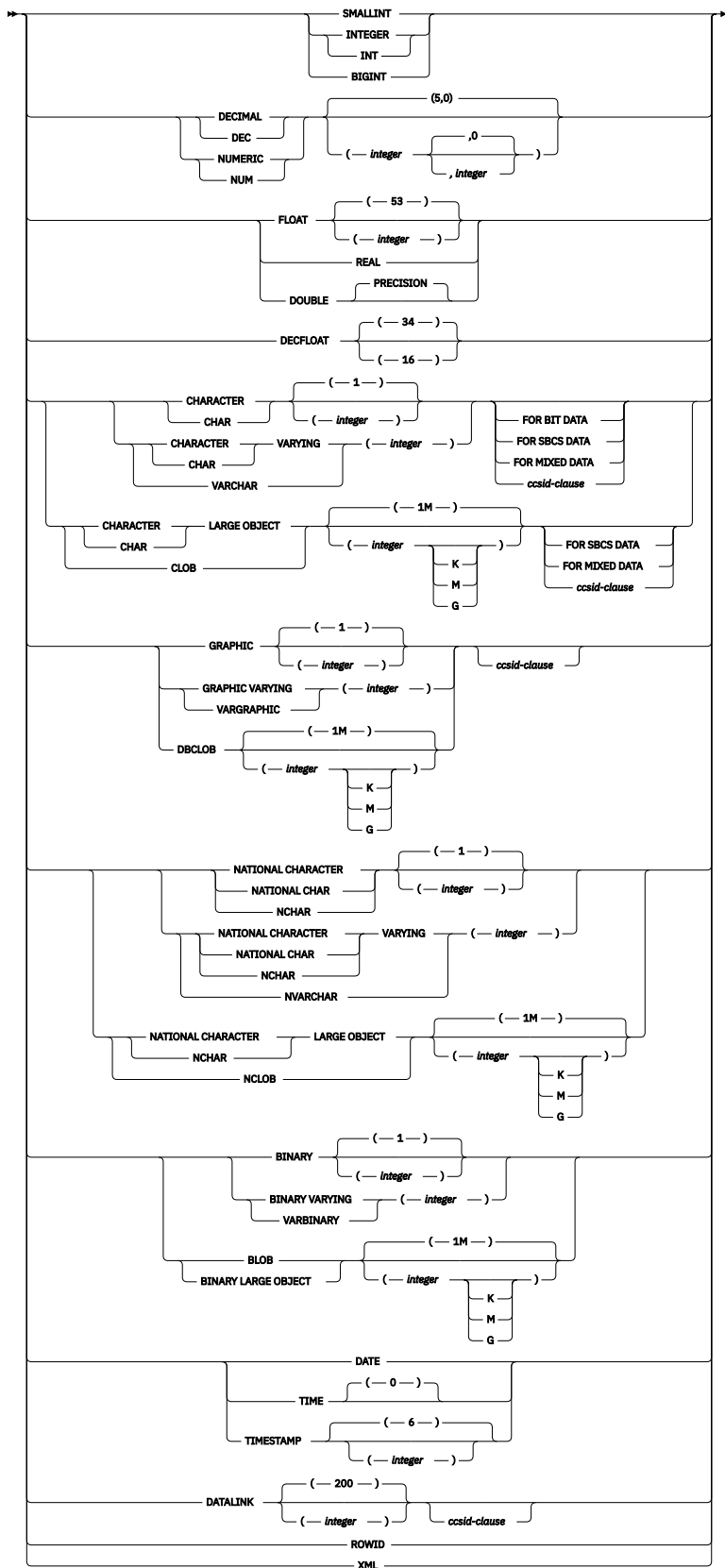

ccsid-clause

➤ CCSID — *integer* ➤

Description

rs-locator-variable

Identifies a result set locator variable that has been declared according to the rules for declaring result set locator variables.

WITH PROCEDURE *procedure-name* or *variable*

Identifies the procedure that returned one or more result sets. When the ASSOCIATE LOCATORS statement is executed, the procedure name must identify a procedure that the requester has already invoked using the SQL CALL statement.

PROCEDURE or SPECIFIC PROCEDURE

Identifies the procedure. The *procedure-name* must identify a procedure that exists at the current server.

PROCEDURE *procedure-name*

Identifies the procedure by its name. The *procedure-name* must identify exactly one procedure. The procedure may have any number of parameters defined for it. If there is more than one procedure of the specified name in the specified or implicit schema, an error is returned.

PROCEDURE *procedure-name (parameter-type, ...)*

Identifies the procedure by its procedure signature, which uniquely identifies the procedure. The *procedure-name (parameter-type, ...)* must identify a procedure with the specified procedure signature. The specified parameters must match the data types in the corresponding position that were specified when the procedure was created. The number of data types, and the logical concatenation of the data types is used to identify the specific procedure instance which is to be labeled on. Synonyms for data types are considered a match. Parameters that have defaults must be included in this signature.

If *procedure-name ()* is specified, the procedure identified must have zero parameters.

procedure-name

Identifies the name of the procedure.

(parameter-type, ...)

Identifies the parameters of the procedure.

If an unqualified distinct type or array type name is specified, the database manager searches the SQL path to resolve the schema name for the distinct type or array type.

For data types that have a length, precision, or scale attribute, use one of the following:

- Empty parentheses indicate that the database manager ignores the attribute when determining whether the data types match. For example, DEC() will be considered a match for a parameter of a procedure defined with a data type of DEC(7,2). However, FLOAT cannot be specified with empty parenthesis because its parameter value indicates a specific data type (REAL or DOUBLE).
- If a specific value for a length, precision, or scale attribute is specified, the value must exactly match the value that was specified (implicitly or explicitly) in the CREATE PROCEDURE statement. If the data type is FLOAT, the precision does not have to exactly match the value that was specified because matching is based on the data type (REAL or DOUBLE).
- If length, precision, or scale is not explicitly specified, and empty parentheses are not specified, the default attributes of the data type are implied. The implicit length must exactly match the value that was specified (implicitly or explicitly) in the CREATE PROCEDURE statement.

Specifying the FOR DATA clause or CCSID clause is optional. Omission of either clause indicates that the database manager ignores the attribute when determining whether the data types match. If either clause is specified, it must match the value that was implicitly or explicitly specified in the CREATE PROCEDURE statement.

AS LOCATOR

Specifies that the procedure is defined to receive a locator for this parameter. If AS LOCATOR is specified, the data type must be a LOB or XML or a distinct type based on a LOB or XML. If AS LOCATOR is specified, FOR SBCS DATA or FOR MIXED DATA must not be specified.

SPECIFIC PROCEDURE *specific-name*

Identifies the procedure by its specific name. The *specific-name* must identify a specific procedure that exists at the current server.

variable

Specifies a variable that contains a procedure or specific name. If *variable* is specified:

- It must be a character-string variable or Unicode graphic-string variable. It cannot be a global variable.
- It must not be followed by an indicator variable.
- The name that is contained within the variable must be left-justified and must be padded on the right with blanks if its length is less than that of the variable.
- The name must be in uppercase unless it is a delimited name.

If only one procedure with this name has been invoked using the CALL statement, the variable is used as a procedure name. If multiple procedures with this name have been invoked, the variable is used as a specific name.

Notes

Assignment of locator values. If a SET RESULT SETS statement was executed in the procedure, the SET RESULT SETS statement identifies the result sets. The locator values are assigned to the items in the descriptor area or the SQLVAR entries in the SQLDA in the order specified on the SET RESULT SETS statement. If a SET RESULT SETS statement was not executed in the procedure, locator values are assigned to the locator variables in the order that the associated cursors are opened at runtime. Locator values are assigned to the locator variables in the same order that they would be placed in the entries in the SQL descriptor area or the SQLDA as a result of a DESCRIBE PROCEDURE statement.

Locator values are not provided for cursors that are closed when control is returned to the invoking application. If a cursor was closed and later re-opened before returning to the invoking application, the most recently executed OPEN CURSOR statement for the cursor is used to determine the order in which the locator values are returned for the procedure result sets. For example, assume procedure P1 opens three cursors A, B, C, closes cursor B, and then issues another OPEN CURSOR statement for cursor B before returning to the invoking application. The locator values assigned for the following ASSOCIATE LOCATORS statement will be in the order A, C, B.

```
ASSOCIATE RESULT SET LOCATORS (:loc1, :loc2, :loc3) WITH PROCEDURE P1;
```

More than one locator can be associated with a result set. You can issue multiple ASSOCIATE LOCATORS statements for the same procedure with different result set locator variables to associate multiple locators with each result set.

- If the number of result set locator variables specified in the ASSOCIATE LOCATORS statement is less than the number of result sets returned by the procedure, all locator variables specified in the statement are assigned a value and a warning is issued. For example, assume procedure P1 exists and returns four result sets. Each of the following ASSOCIATE LOCATORS statements returns information on the first result set along with a warning that not enough locators were provided to obtain information about all the result sets.

```
CALL P1;
```

```
ASSOCIATE RESULT SET LOCATORS (:loc1) WITH PROCEDURE P1; -> loc1 is assigned a value for first result set, and a warning is returned
```

```
ASSOCIATE RESULT SET LOCATORS (:loc2) WITH PROCEDURE P1; -> loc2 is assigned a value for first result set, and a warning is returned
```

ASSOCIATE RESULT SET LOCATORS (:loc3) WITH PROCEDURE P1; -> loc3 is assigned a value for first result set, and a warning is returned

ASSOCIATE RESULT SET LOCATORS (:loc4) WITH PROCEDURE P1; -> loc4 is assigned a value for first result set, and a warning is returned

- If the number of result set locator variables that are listed in the ASSOCIATE LOCATORS statement is greater than the number of locators returned by the procedure, the extra locator variables are assigned a value of 0.

Multiple calls to the same procedure: When multiple calls to the same procedure are made from the same program, the result sets of earlier invocations are lost unless an ASSOCIATE LOCATOR statement is executed prior to a subsequent CALL to the procedure. The ASSOCIATE LOCATORS statement will refer to the most recent CALL

```
EXEC SQL CALL P1; /* Returns 2 result sets */
EXEC SQL CALL P1; /* Returns 2 result sets, result sets from first invocation are closed */
EXEC SQL ASSOCIATE RESULT SET LOCATORS (:a, :b) WITH PROCEDURE P1; /* Refers to second call */
EXEC SQL CALL P1; /* Returns 2 result sets */
EXEC SQL ASSOCIATE RESULT SET LOCATORS (:c, :d) WITH PROCEDURE P1; /* Refers to third call */

/* The following statements process the result sets from the second call */
EXEC SQL ALLOCATE C1 CURSOR FOR RESULT SET :a;
EXEC SQL ALLOCATE C2 CURSOR FOR RESULT SET :b;
EXEC SQL FETCH C1 INTO :h1;
EXEC SQL CLOSE C1;
EXEC SQL FETCH C2 INTO :h2;
EXEC SQL CLOSE C2;

/* The following statements process the result sets from the third call */
EXEC SQL ALLOCATE C3 CURSOR FOR RESULT SET :c;
EXEC SQL ALLOCATE C4 CURSOR FOR RESULT SET :d;
EXEC SQL FETCH C3 INTO :h1;
EXEC SQL CLOSE C3;
EXEC SQL FETCH C4 INTO :h2;
EXEC SQL CLOSE C4;
```

RETURN TO CLIENT procedures: A result set of a RETURN TO CLIENT procedure becomes associated with the highest procedure on the invocation stack. To associate a locator with such a result set, the procedure name of the highest procedure on the invocation stack must be specified.

Example

Allocate result set locators for procedure P1 which returns 3 result sets

```
ASSOCIATE RESULT SET LOCATORS (:loc11, :loc2, :loc3) WITH PROCEDURE P1;
```

BEGIN DECLARE SECTION

The BEGIN DECLARE SECTION statement marks the beginning of an SQL declare section. An SQL declare section contains declarations of host variables that are eligible to be used as host variables in SQL statements in a program.

Invocation

This statement can only be embedded in an application program. It is not an executable statement. It must not be specified in Java, RPG, or REXX.

Authorization

None required.

Syntax

➤➤ BEGIN DECLARE SECTION ➤➤

Description

The BEGIN DECLARE SECTION statement is used to indicate the beginning of an SQL declare section. It can be coded in the application program wherever variable declarations can appear in accordance with the rules of the host language. It cannot be coded in the middle of a host structure declaration. An SQL declare section ends with an END DECLARE SECTION statement, described in [“END DECLARE SECTION” on page 1295](#).

The BEGIN DECLARE SECTION and the END DECLARE SECTION statements must be paired and cannot be nested.

SQL statements should not be included within a declare section, with the exception of the DECLARE VARIABLE and INCLUDE statements.

If SQL declare sections are specified in the program, only the variables declared within the SQL declare sections can be used as host variables. If SQL declare sections are not specified in the program, all variables in the program are eligible for use as host variables.

SQL declare sections should be specified for host languages, other than RPG and REXX, so that the source program conforms to the IBM SQL standard of SQL. SQL declare sections are required for all host variables in C++. The SQL declare section should appear before the first reference to the variable. Host variables are declared without the use of these statements in Java and RPG, and they are not declared at all in REXX.

Variables declared outside an SQL declare section should not have the same name as variables declared within an SQL declare section.

More than one SQL declare section can be specified in the program.

Examples

Example 1: Define the host variables hv_smint (SMALLINT), hv_vchar24 (VARCHAR(24)), and hv_double (DOUBLE) in a C program.

```
EXEC SQL BEGIN DECLARE SECTION;
static short hv_smint;
static struct {
    short hv_vchar24_len;
    char hv_vchar24_value[24];
} hv_vchar24;
static double hv_double;
EXEC SQL END DECLARE SECTION;
```

Example 2: Define the host variables HV-SMINT (smallint), HV-VCHAR24 (varchar(24)), and HV-DEC72 (dec(7,2)) in a COBOL program.

```
WORKING-STORAGE SECTION.  
  EXEC SQL BEGIN DECLARE SECTION END-EXEC.  
01 HV-SMINT          PIC S9(4)          BINARY.  
01 HV-VCHAR24.  
  49 HV-VCHAR24-LENGTH PIC S9(4)          BINARY.  
  49 HV-VCHAR24-VALUE  PIC X(24).  
01 HV-DEC72         PIC S9(5)V9(2)  PACKED-DECIMAL.  
  EXEC SQL END DECLARE SECTION END-EXEC.
```

CALL

The CALL statement calls a procedure.

Invocation

This statement can be embedded in an application program or issued interactively. It is an executable statement that can be dynamically prepared.

Authorization

The privileges held by the authorization ID of the statement must include at least one of the following:

- If the procedure is an SQL procedure:
 - The EXECUTE privilege on the procedure, and
 - The USAGE privilege on the schema containing the SQL procedure
- If the procedure is a Java external procedure:
 - Read authority (*R) to the integrated file system file that contains the Java class.
 - Read and execute authority (*RX) to all directories that must be accessed in order to find the integrated file system file.
- If the procedure is a REXX external procedure:
 - The system authorities *OBJOPR, *READ, and *EXECUTE on the source file associated with the procedure,
 - The USAGE privilege on the schema containing the source file, and
 - The system authority *USE to the CL command,
- If the procedure is an external procedure, but not a REXX or Java external procedure:
 - The system authority *EXECUTE on the program or service program associated with the procedure, and
 - The USAGE privilege on the schema containing the program or service program associated with the procedure
- Database administrator authority

If a global variable is referenced as an IN or INOUT parameter, the privileges held by the authorization ID for the statement must include at least one of the following:

- The READ privilege on the global variable.
- Database administrator authority

If a global variable is referenced as an OUT or INOUT parameter, the privileges held by the authorization ID for the statement must include at least one of the following:

- The WRITE privilege on the global variable.
- Database administrator authority

For information on the system authorities corresponding to SQL privileges, see [Corresponding System Authorities When Checking Privileges to a Function or Procedure](#).

Syntax

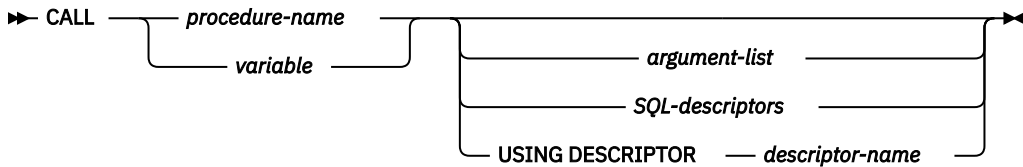

argument-list

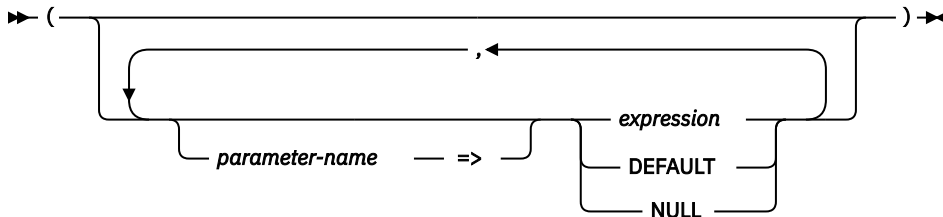

SQL-descriptors

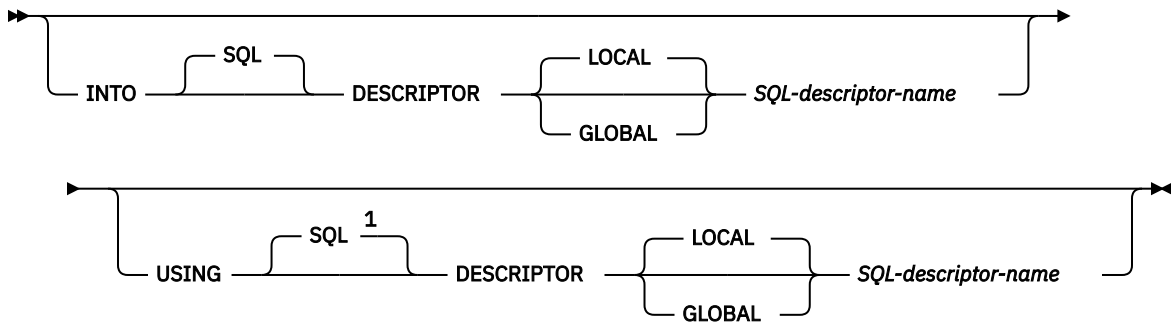

Notes:

¹ If an SQL descriptor is specified in the USING clause and the INTO clause is not specified, USING DESCRIPTOR is not allowed and USING SQL DESCRIPTOR must be specified.

Description

procedure-name or variable

Identifies the procedure to call by the specified *procedure-name* or the procedure name contained in the *variable*. The identified procedure must exist at the current server.

If a *variable* is specified:

- It must be a character-string variable or Unicode graphic-string. It cannot be a global variable.
- It must not be followed by an indicator variable.
- The procedure name that is contained within the variable must be left-justified and must be padded on the right with blanks if its length is less than that of the variable.
- The name of the procedure must be in uppercase unless the procedure name is a delimited name.

If the procedure name is unqualified, it is implicitly qualified based on the path and number of parameters. For more information see [“Qualification of unqualified object names”](#) on page 57.

If the procedure-name identifies a procedure that was defined by a DECLARE PROCEDURE statement, and the current server is a Db2 for i product, then:

- The DECLARE PROCEDURE statement determines the name of the external program, language, and calling convention.
- The attributes of the parameters of the procedure are defined by the DECLARE PROCEDURE statement.

If there is no DECLARE PROCEDURE and the procedure name identifies a procedure that was defined by a CREATE PROCEDURE statement, and the current server is Db2 for i, then:

- The CREATE PROCEDURE statement determines the name of the external program, language, and calling convention.
- The attributes of the parameters of the procedure are defined by the CREATE PROCEDURE statement.

Otherwise:

- The current server determines the name of the external program, language, and calling convention.
- If the current server is Db2 for i:
 - The external program name is assumed to be the same as the external procedure name.
 - If the program attribute information associated with the program identifies a recognizable language, then that language is used. Otherwise, the language is assumed to be C.
 - The calling convention is assumed to be GENERAL.
- The application requester assumes all parameters that are variables or parameter markers are INOUT. All parameters that are not variables are assumed to be IN.
- The actual attributes of the parameters are determined by the current server.

If the current server is a Db2 for i, the attributes of the parameters will be the same as the attributes of the arguments specified on the CALL statement.⁸⁴

argument-list

Identifies a list of values to be passed as parameters to the procedure. The nth unnamed argument corresponds to the nth parameter in the procedure.

Each parameter defined (using a CREATE PROCEDURE or DECLARE PROCEDURE statement) as OUT must be specified as a variable. A default cannot be specified for an OUT parameter. If a default is used for an INOUT parameter, then the default expression is used to initialize the parameter for input to the procedure. No value is returned for this parameter when the procedure exits.

When a procedure is called, arguments must be specified for all parameters that are not defined to have a default value. When an argument is assigned to a parameter using the named syntax, then all the arguments that follow it must also be assigned using the named syntax.

Any references to date, time, or timestamp special register values in the argument list will use one clock reading for any default expressions and a separate clock reading for any references in the explicit arguments.

If any argument is an array, all other arguments must be literals, special registers, NULL, or DEFAULT.

The application requester assumes all parameters that are variables are INOUT parameters except for Java, where it is assumed all parameters that are variables are IN unless the mode is explicitly specified in the variable reference. All parameters that are not variables are assumed to be input parameters. The actual attributes of the parameters are determined by the current server.

parameter-name

Name of the parameter to which the argument value is assigned. The name must match a parameter name defined for the procedure. Named arguments correspond to the same named parameter regardless of the order in which they are specified in the argument list. When an argument is assigned to a parameter by name, all the arguments that follow it must also be assigned by name.

A named argument must be specified only one time (implicitly or explicitly).

Named arguments are only allowed on a call to a procedure that was defined using a CREATE PROCEDURE statement.

⁸⁴ Note that in the case of decimal constants, leading zeroes are significant when determining the attributes of the argument. Normally, leading zeroes are not significant.

expression

An *expression* of the type described in [“Expressions” on page 159](#), that does not include an aggregate function or column name. If extended indicator variables are enabled, the extended indicator variable values of DEFAULT and UNASSIGNED must not be used for that expression.

DEFAULT

Specifies the default as defined in the CREATE PROCEDURE statement is used as an argument to the procedure. If no default is defined for the parameter, the NULL value is used.

NULL

Specifies a null value as an argument to the procedure.

SQL-descriptors

If SQL descriptors are specified on CALL, a procedure that has IN and INOUT parameters requires an SQL descriptor to be specified in the USING clause; and a procedure that has OUT or INOUT parameters requires an SQL descriptor to be specified in the INTO clause. If all the parameters of the procedure are INOUT parameters, the same descriptor can be used for both clauses. For more information, see [Multiple SQL descriptors on CALL](#).

INTO

Identifies an SQL descriptor which contains valid descriptions of the output variables to be used with the CALL statement. Before the CALL statement is executed, a descriptor must be allocated using the ALLOCATE DESCRIPTOR statement. The COUNT field in the descriptor header must be set to reflect the number of OUT and INOUT parameters for the procedure. The item information, including TYPE, and where applicable, DATETIME_INTERVAL_CODE, LENGTH, DB2_CCSID, PRECISION, and SCALE, must be set for the variables that are used when processing the statement.

LOCAL

Specifies the scope of the name of the descriptor to be local to program invocation. The information is returned from the descriptor known in this local scope.

GLOBAL

Specifies the scope of the name of the descriptor to be global to the SQL session. The information is returned from the descriptor known to any program that executes using the same database connection.

SQL-descriptor-name

Names the SQL descriptor. The name must identify a descriptor that already exists with the specified scope.

See [“GET DESCRIPTOR” on page 1311](#) for an explanation of the information that is placed in the SQL descriptor.

USING

Identifies an SQL descriptor which contains valid descriptions of the input variables to be used with the CALL statement. Before the CALL statement is executed, a descriptor must be allocated using the ALLOCATE DESCRIPTOR statement. The COUNT field in the descriptor header must be set to reflect the number of IN and INOUT parameters for the procedure. The item information, including TYPE, and where applicable, DATETIME_INTERVAL_CODE, LENGTH, DB2_CCSID, PRECISION, and SCALE, must be set for the variables that are used when processing the statement. The DATA item and when nulls are used, the INDICATOR item, must be set for the input variables.

LOCAL

Specifies the scope of the name of the descriptor to be local to program invocation.

GLOBAL

Specifies the scope of the name of the descriptor to be global to the SQL session.

SQL-descriptor-name

Names the SQL descriptor. The name must identify a descriptor that already exists with the specified scope.

See [“SET DESCRIPTOR”](#) on page 1498 for an explanation of the information in the SQL descriptor.

USING DESCRIPTOR *descriptor-name*

Identifies an SQLDA that must contain a valid description of variables.

Before the CALL statement is processed, you must set the following fields in the SQLDA. (The rules for REXX are different. For more information, see the [Embedded SQL Programming](#) topic collection.)

- SQLN to indicate the number of SQLVAR occurrences provided in the SQLDA
- SQLDABC to indicate the number of bytes of storage allocated for the SQLDA
- SQLD to indicate the number of variables used in the SQLDA when processing the statement
- SQLVAR occurrences to indicate the attributes of the variables.

The SQLDA must have enough storage to contain all SQLVAR occurrences. Therefore, the value in SQLDABC must be greater than or equal to $16 + \text{SQLN} * (80)$, where 80 is the length of an SQLVAR occurrence. If LOBs or distinct types are specified, there must be two SQLVAR entries for each parameter marker and SQLN must be set to two times the number of parameter markers.

SQLD must be set to a value greater than or equal to zero and less than or equal to SQLN. It must be the same as the number of parameters in the CALL statement. The *n*th variable described by the SQLDA corresponds to the *n*th parameter marker in the prepared statement. (For a description of an SQLDA, see [Appendix D, “SQLDA \(SQL descriptor area\),”](#) on page 1667.)

Note that RPG/400 does not provide the function for setting pointers. Because the SQLDA uses pointers to locate the appropriate variables, you have to set these pointers outside your RPG/400 application.

The USING DESCRIPTOR clause is not supported for a CALL statement within a Java program.

Notes

Parameter assignments: When the CALL statement is executed, the value of each of its parameters is assigned (using storage assignment rules) to the corresponding parameter of the procedure. A parameter value that is defined to have a default value can be omitted from the argument list when invoking the procedure. Control is passed to the procedure according to the calling conventions of the host language. When execution of the procedure is complete, the value of each parameter of the procedure is assigned (using storage assignment rules for SQL parameters, otherwise using retrieval assignment rules) to the corresponding parameter of the CALL statement defined as OUT or INOUT. For details on the assignment rules, see [“Assignments and comparisons”](#) on page 91.

Global variables: A global variable may be specified and will be modified if used as a parameter that is INOUT or OUT.

Procedure signatures: A procedure is identified by its schema, a procedure name, and the number of parameters. This is called a procedure signature, which must be unique within the database. There can be more than one procedure with the same name in a schema, provided that the number of parameters is different for each procedure.

SQL path: A procedure can be invoked by referring to a qualified name (schema and procedure name), followed by an optional list of arguments enclosed by parentheses. A procedure can also be invoked without the schema name, resulting in a choice of possible procedures in different schemas with the same number of parameters. In this case, the SQL path is used to assist in procedure resolution.

Procedure resolution: For details of how procedure resolution is performed, see [“Procedure resolution”](#) on page 63 .

Cursors and prepared statements in procedures: All cursors opened in the called procedure that are not result set cursors are closed, and all statements prepared in the called procedure are destroyed when the procedure ends. CLOSQLCSR(*ENDACTGRP) can be used to keep cursors open when the procedure ends. For more information, see [“SET OPTION”](#) on page 1505.

Result sets from procedures: There are three ways to return result sets from a procedure:

- If a SET RESULT SETS statement is executed in the procedure, the last SET RESULT SETS statement executed in the procedure identifies the result sets. The result sets are returned in the order specified on the SET RESULT SETS statement.
- If a SET RESULT SETS statement is not executed in the procedure,
 - If no cursors have specified a WITH RETURN clause, each cursor that the procedure opens and leaves open when it returns identifies a result set. The result sets are returned in the order in which the cursors are opened.
 - If any cursors have specified a WITH RETURN clause, each cursor that is defined with the WITH RETURN clause that the procedure opens and leaves open when it returns identifies a result set. The result sets are returned in the order in which the cursors are opened.

When a result set is returned using an open cursor, the rows are returned starting with the current cursor position.

If a cursor result set references an SQL array type, an error will be returned if the array reference would cause incorrect results when processing the result set.

Locks in procedures: All locks that have been acquired in the called procedure are retained until the end of the unit of work.

Errors from procedures: A procedure can return errors (or warnings) using the SQLSTATE like other SQL statements. Applications should be aware of the possible SQLSTATES that can be expected when invoking a procedure. The possible SQLSTATES depend on how the procedure is coded. Procedures may also return SQLSTATES such as those that begin with '38' or '39' if the database manager encounters problems executing the procedure. Applications should therefore be prepared to handle any error SQLSTATE that may result from issuing a CALL statement.

Nesting CALL statements: A program that is executing as a procedure, a user-defined function, or a trigger can issue a CALL statement. When a procedure, user-defined function, or trigger calls a procedure, user-defined function, or trigger, the call is considered to be nested. There is no limit on how many levels procedures and functions can be nested, but triggers can only be nested up to 200 levels deep.

If a procedure returns any query result sets, the result sets are returned to the caller of the procedure. If the SQL CALL statement is nested, the result sets are visible only to the program that is at the previous nesting level. For example, if a client program calls procedure PROCA, which in turn calls procedure PROCB. Only PROCA can access any result sets that PROCB returns; the client program has no access to the query result sets.

When an SQL or an external procedure is called, an attribute is set for SQL data-access that was defined when the procedure was created. The possible values for the attribute are:

NONE
CONTAINS
READS
MODIFIES

If a second procedure is invoked within the execution of the current procedure, an error is issued if:

- The invoked procedure possibly contains SQL and the invoking procedure does not allow SQL
- The invoked procedure reads SQL data and the invoking procedure does not allow reading SQL data
- The invoked procedure modifies SQL data and the invoking procedure does not allow modifying SQL data

REXX procedures: If the external procedure to be called is a REXX procedure, then the procedure must be declared using the CREATE PROCEDURE or DECLARE PROCEDURE statement.

Variables cannot be used in the CALL statement within a REXX procedure. Instead, the CALL must be the object of a PREPARE and EXECUTE using parameter markers.

Multiple SQL descriptors on CALL: If SQL descriptors are specified on CALL and a procedure has IN or INOUT parameters and OUT or INOUT parameters, two descriptors must be specified. The number of

variables that must be allocated in the SQL descriptors depends on how the SQL descriptor attributes are set and the number of each type of parameter.

- If the input SQL descriptor attributes were set using DESCRIBE INPUT and the output SQL descriptor attributes were set using DESCRIBE (OUTPUT), the SQL descriptors will have attributes that match the actual procedure definition at the current server prior to calling the procedure. In this case, the output SQL descriptor will contain one variable for each OUT and INOUT parameter. Likewise, the input SQL descriptor will contain one variable for each IN and INOUT parameter.

This is the recommended technique for specifying multiple SQL descriptors on a CALL statement.

- Otherwise, the actual procedure definition at the current server is unknown prior to calling the procedure, so each parameter is assumed to be INOUT at the time the procedure is called. This means that both SQL descriptors must be specified, and since each parameter is assumed to be INOUT, they must have the same number of variables and the TYPE, DATETIME_INTERVAL_CODE, LENGTH, DB2_CCSID, PRECISION, and SCALE of each variable in the output SQL descriptor must be exactly the same as the corresponding variable in the input SQL descriptor. Otherwise, an error is returned.

If multiple SQL descriptors are specified, the DATA or INDICATOR items associated with any INOUT parameters in the input SQL descriptor may also be modified when the procedure is called. Thus, a SET DESCRIPTOR may be necessary to reset the DATA and INDICATOR items for such an input SQL descriptor prior to its use in another SQL statement.

Examples

Example 1: Call procedure PGM1 and pass two parameters.

```
CALL PGM1 (:hv1, :hv2)
```

Example 2: In C, invoke a procedure called SALARY_PROC using the SQLDA named INOUT_SQLDA.

```
struct sqlda *INOUT_SQLDA;  
/* Setup code for SQLDA variables goes here */  
CALL SALARY_PROC USING DESCRIPTOR :*INOUT_SQLDA;
```

Example 3: A Java procedure is defined in the database using the following statement:

```
CREATE PROCEDURE PARTS_ON_HAND (IN PARTNUM INTEGER,  
                                OUT COST DECIMAL(7,2),  
                                OUT QUANTITY INTEGER)  
LANGUAGE JAVA PARAMETER STYLE JAVA  
EXTERNAL NAME 'parts!onhand';
```

A Java application calls this procedure on the connection context 'ctx' using the following code fragment:

```
...  
int      variable1;  
BigDecimal variable2;  
Integer  variable3;  
...  
#sql [ctx] {CALL PARTS_ON_HAND(:IN variable1, :OUT variable2, :OUT variable3)};  
...
```

This application code fragment will invoke the Java method *onhand* in class *parts* since the *procedure-name* specified on the CALL statement is found in the database and has the external name 'parts!onhand'.

Example 4: Call procedure PGM2 on relational database BRANCHRDB2 and pass one parameter.

```
CALL BRANCHRDB2.SCHEMA3.PGM2 (:hv1)
```

Example 5: Assume the following procedure exists.

```
CREATE PROCEDURE update_order(  
    IN IN_POID BIGINT,  
    IN IN_CUSTID BIGINT DEFAULT GLOBAL_CUST_ID,
```

```
IN NEW_STATUS VARCHAR(10) DEFAULT NULL,  
IN NEW_ORDERDATE DATE DEFAULT NULL,  
IN NEW_COMMENTS VARCHAR(1000) DEFAULT NULL)...
```

Also assume that the global variable GLOBAL_CUST_ID is set to the value 1002. Call the procedure to change the status of order 5000 for customer 1002 to 'Shipped'. Leave the rest of the order data as it is by allowing the rest of the arguments to default to the null value.

```
CALL update_order (5000, NEW_STATUS => 'Shipped')
```

The customer with ID 1001 has called and indicated that they received their shipment for purchase order 5002 and are satisfied. Update their order.

```
CALL update_order (5002,  
                  IN_CUSTID => 1001,  
                  NEW_STATUS => 'Received',  
                  NEW_COMMENTS => 'Customer satisfied with the order.')
```

CLOSE

The CLOSE statement closes a cursor. If a result table was created when the cursor was opened, that table is destroyed.

Invocation

This statement can only be embedded in an application program. It is an executable statement that cannot be dynamically prepared. It must not be specified in Java.

Authorization

None required. See [“DECLARE CURSOR” on page 1207](#) for the authorization required to use a cursor.

Syntax

➤ CLOSE — *cursor-name* ➤

Description

cursor-name

Identifies the cursor to be closed. The *cursor-name* must identify a declared cursor as explained in the DECLARE CURSOR statement. When the CLOSE statement is executed, the cursor must be in the open state.

Notes

Implicit cursor close: All cursors in a program are in the closed state when:

- The program is called.
 - If CLOSQLCSR(*ENDPGM) is specified, all cursors are in the closed state each time the program is called.
 - If CLOSQLCSR(*ENDSQL) is specified, all cursors are in the closed state only the first time the program is called as long as one SQL program remains on the call stack.
 - If CLOSQLCSR(*ENDJOB) is specified, all cursors are in the closed state only the first time the program is called in the job.
 - If CLOSQLCSR(*ENDMOD) is specified, all cursors are in the closed state each time the module is initiated.
 - If CLOSQLCSR(*ENDACTGRP) is specified, all cursors are in the closed state the first time the module in the program is initiated within the activation group.
- A program starts a new unit of work by executing a COMMIT or ROLLBACK statement without a HOLD option. Cursors declared with the HOLD option are not closed by a COMMIT statement.

Note: The Db2 for i database manager will open files in order to implement queries. The closing of the files can be separate from the SQL CLOSE statement. For more information, see [SQL Programming](#).

Close cursors for performance: Explicitly closing cursors as soon as possible can improve performance.

Procedure considerations: Special rules apply to cursors within procedures that have not been closed before returning to the calling program. For more information, see [“CALL” on page 920](#).

Example

In a COBOL program, use the cursor C1 to fetch the values from the first four columns of the EMPPROJACT table a row at a time and put them in the following host variables:

- EMP (CHAR(6))

- PRJ (CHAR(6))
- ACT (SMALLINT)
- TIM (DECIMAL(5,2))

Finally, close the cursor.

```

EXEC SQL BEGIN DECLARE SECTION END-EXEC.
  77 EMP          PIC X(6).
  77 PRJ          PIC X(6).
  77 ACT          PIC S9(4) BINARY.
  77 TIM          PIC S9(3)V9(2) PACKED-DECIMAL.
EXEC SQL END DECLARE SECTION END-EXEC.
.
.
.

EXEC SQL DECLARE C1 CURSOR FOR
      SELECT EMPNO, PROJNO, ACTNO, EMPTIME
      FROM EMPPROJACT                               END-EXEC.

EXEC SQL OPEN C1  END-EXEC.

EXEC SQL FETCH C1 INTO :EMP, :PRJ, :ACT, :TIM  END-EXEC.

IF SQLSTATE = '02000'
  PERFORM DATA-NOT-FOUND
ELSE
  PERFORM GET-REST-OF-ACTIVITY UNTIL SQLSTATE IS NOT EQUAL TO '00000'.

EXEC SQL CLOSE C1  END-EXEC.

GET-REST-OF-ACTIVITY
EXEC SQL FETCH C1 INTO :EMP, :PRJ, :ACT, :TIM  END-EXEC.
.
.
.

```

COMMENT

The COMMENT statement adds or replaces comments in the catalog descriptions of various database objects.

Invocation

This statement can be embedded in an application program or issued interactively. It is an executable statement that can be dynamically prepared.

Authorization

To comment on a table, view, alias, column, type, package, sequence, variable, or XSR object, the privileges held by the authorization ID of the statement must include at least one of the following:

- For the table, view, alias, type, package, sequence, variable, or XSR object in the statement,
 - The ALTER privilege on the table, view, alias, type, package, sequence, variable, or XSR object, and
 - The USAGE privilege on the schema that contains the table, view, alias, index, type, package, sequence, variable, or XSR object
- Administrative authority

To comment on a constraint or trigger, the privileges held by the authorization ID of the statement must include at least one of the following:

- For the subject table of the constraint or trigger in the statement:
 - The ALTER privilege on the subject table, and
 - The USAGE privilege on the schema that contains the subject table
- Database administrator authority

To comment on an index, the privileges held by the authorization ID of the statement must include at least one of the following:

- For the index identified in the statement,
 - The system authority *OBJALTER on the index, and
 - The USAGE privilege on the schema containing the index.
- Administrative authority

To comment on a function, the privileges held by the authorization ID of the statement must include at least one of the following:

- For the SYSPROCS and SYSROUTINES catalog view and table:
 - The UPDATE privilege on SYSROUTINES,
 - The system authority *OBJOPR on SYSPROCS, and
 - The USAGE privilege on schema QSYS2
- Administrative authority

To comment on a procedure, the privileges held by the authorization ID of the statement must include at least one of the following:

- For the SYSPROCS and SYSROUTINES catalog view and table:
 - The UPDATE privilege on SYSROUTINES,
 - The system authority *OBJOPR on SYSPROCS, and
 - The USAGE privilege on schema QSYS2
- Administrative authority

To comment on a parameter, the privileges held by the authorization ID of the statement must include at least one of the following:

- For the SYSPARMS catalog table:
 - The UPDATE privilege on the table, and
 - The USAGE privilege on schema QSYS2
- Administrative authority

To comment on a mask or permission:

- The authorization ID of the statement must be authorized to the Database Security Administrator function of IBM i. See [“Administrative authority” on page 15](#).

To comment on a sequence, the privileges held by the authorization ID of the statement must also include at least one of the following:

- *USE authority to the Change Data Area (CHGDTAARA), CL command
- Administrative authority

To comment on a variable, the privileges held by the authorization ID of the statement must also include at least one of the following:

- For the SYSVARIABLES catalog table:
 - The UPDATE privilege on SYSVARIABLES, and
 - The USAGE privilege on schema QSYS2
- Administrative authority

To comment on an XSR object, the privileges held by the authorization ID of the statement must also include at least one of the following:

- For the XSROBJECTS catalog table:
 - The UPDATE privilege on XSROBJECTS, and
 - The USAGE privilege on schema QSYS2
- Administrative authority

For information about the system authorities corresponding to SQL privileges, see [Corresponding System Authorities When Checking Privileges to a Table or View](#), [Corresponding System Authorities When Checking Privileges to a User-defined Type](#), [Corresponding System Authorities When Checking Privileges to a Sequence](#), [Corresponding System Authorities When Checking Privileges to a Variable](#), [Corresponding System Authorities When Checking Privileges to a Package](#), and [Corresponding System Authorities When Checking Privileges to an XSR object](#).

Syntax

► COMMENT — ON ►

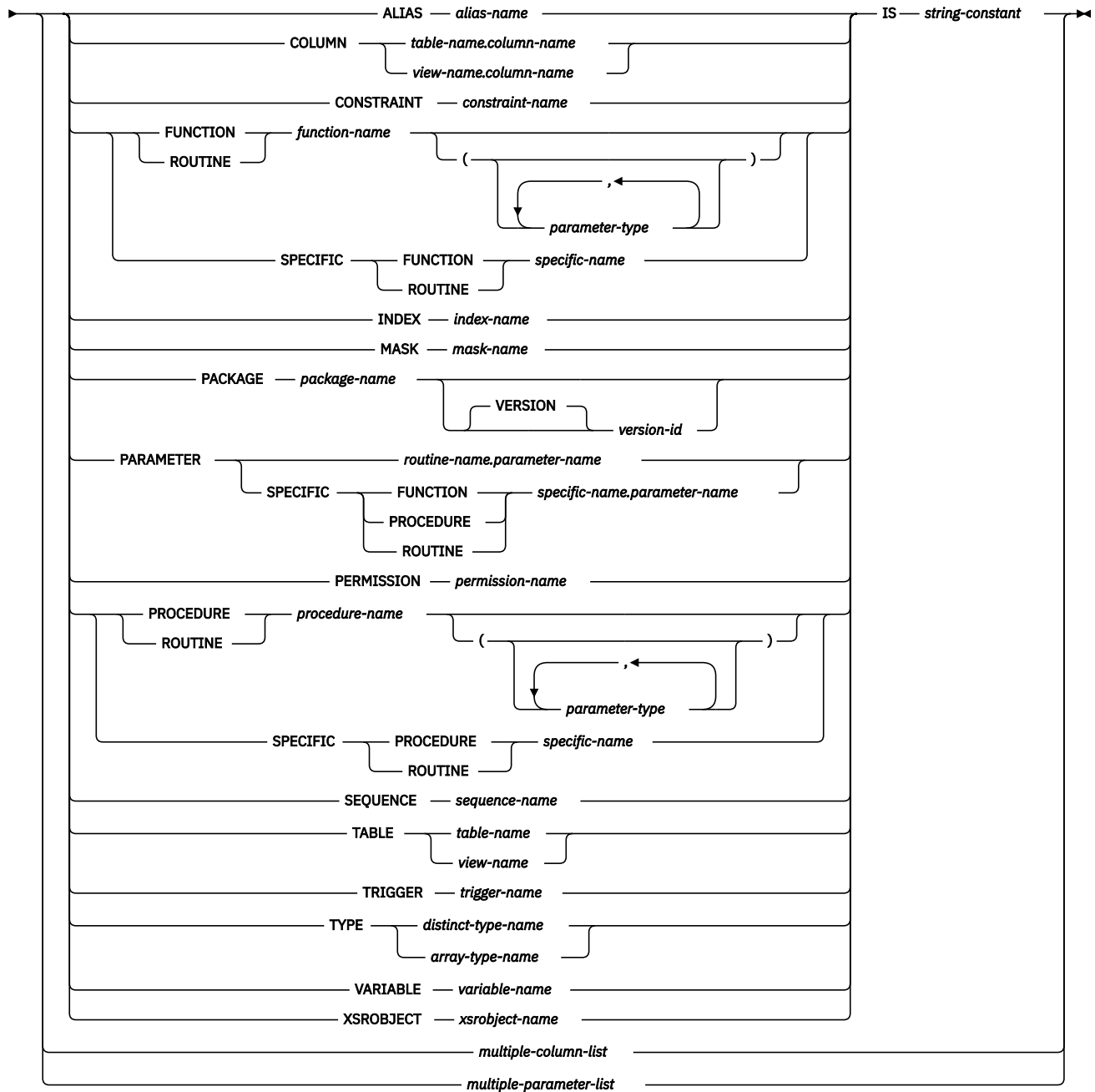

multiple-column-list

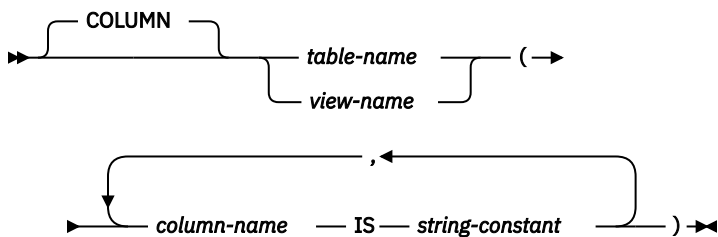

multiple-parameter-list

►► PARAMETER →

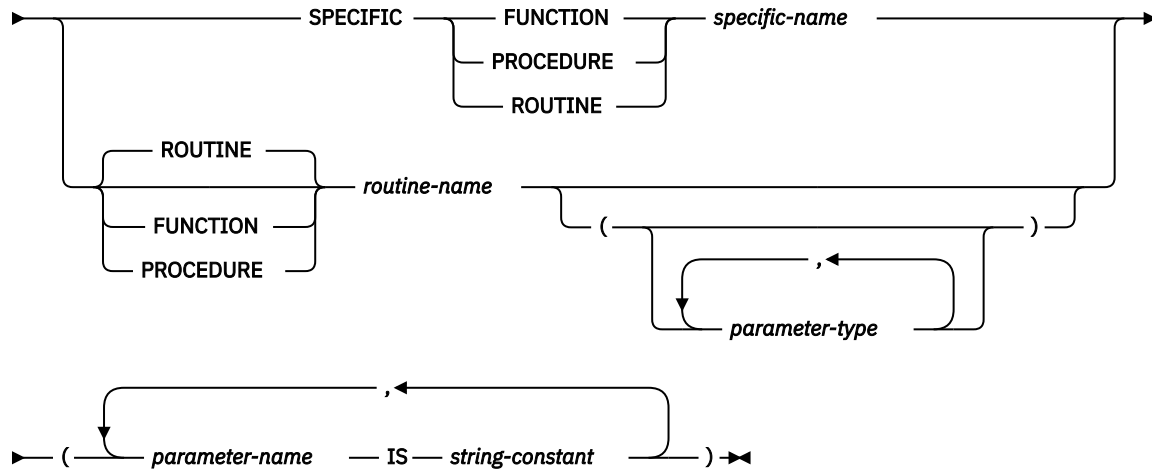

parameter-type

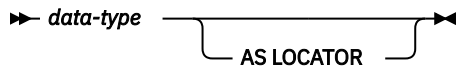

data-type

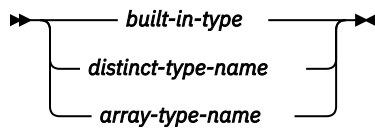

built-in-type

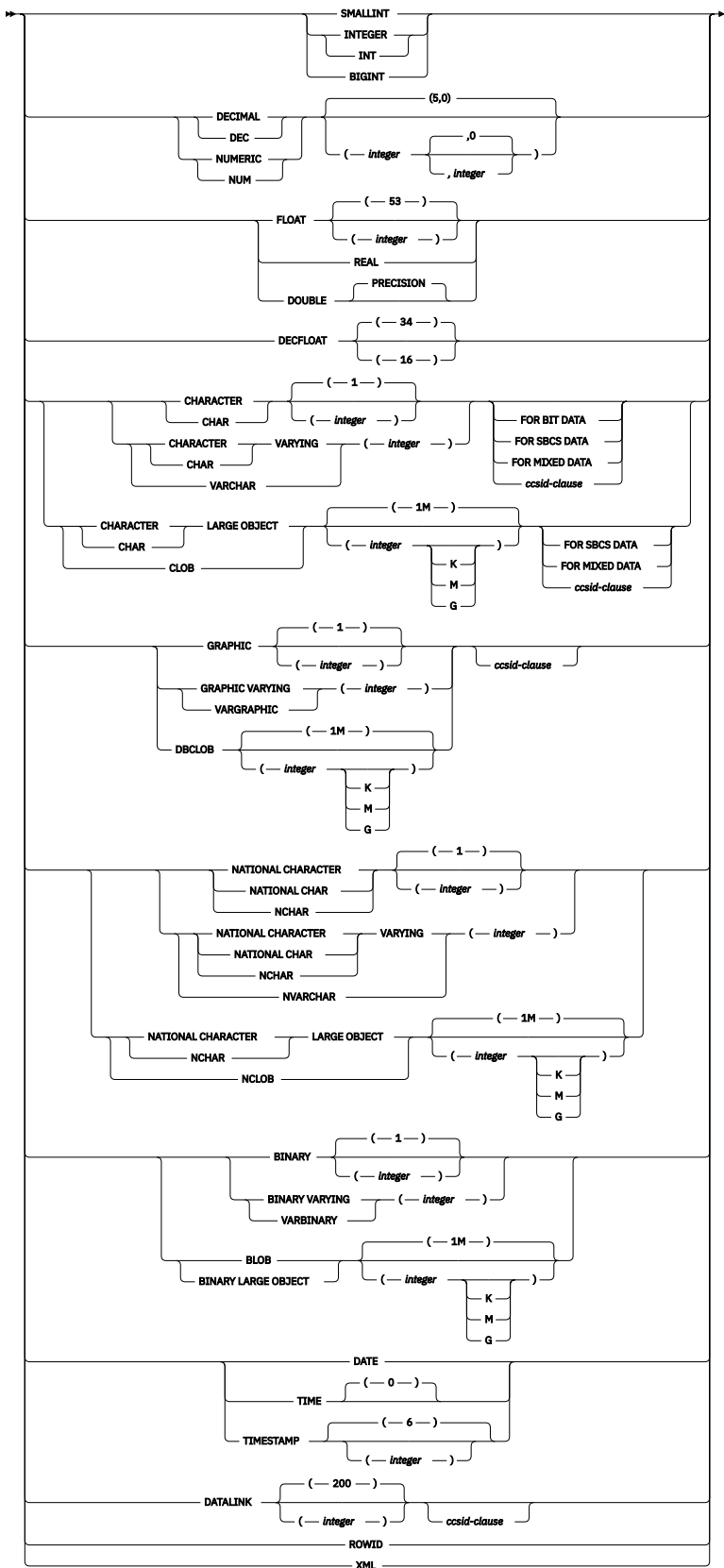

ccsid-clause

➤ CCSID — *integer* ➤

Description

ALIAS *alias-name*

Identifies the alias to which the comment applies. The *alias-name* must identify an alias that exists at the current server.

COLUMN

Specifies that a comment will be added to or replaced for a column.

table-name.column-name* or *view-name.column-name

Identifies the column to which the comment applies. The *table-name* or *view-name* must identify a table or view that exists at the current server, but must not identify a declared temporary table. The *column-name* must identify a column of that table or view.

CONSTRAINT

Specifies that a comment will be added to or replaced for a constraint.

constraint-name

Identifies the constraint to which the comment applies. The *constraint-name* must identify a constraint that exists at the current server.

FUNCTION or SPECIFIC FUNCTION

Identifies the function on which the comment applies. The function must exist at the current server and it must be a user-defined function. The function can be identified by its name, function signature, or specific name.

FUNCTION *function-name*

Identifies the function by its name. The *function-name* must identify exactly one function. The function may have any number of parameters defined for it. If there is more than one function of the specified name in the specified or implicit schema, an error is returned.

FUNCTION *function-name (parameter-type, ...)*

Identifies the function by its function signature, which uniquely identifies the function. The *function-name (parameter-type, ...)* must identify a function with the specified function signature. The specified parameters must match the data types in the corresponding position that were specified when the function was created. The number of data types, and the logical concatenation of the data types is used to identify the specific function instance on which to comment. Synonyms for data types are considered a match. Parameters that have defaults must be included in this signature.

If *function-name ()* is specified, the function identified must have zero parameters.

function-name

Identifies the name of the function.

(parameter-type, ...)

Identifies the parameters of the function.

If an unqualified distinct type name is specified, the database manager searches the SQL path to resolve the schema name for the distinct type.

For data types that have a length, precision, or scale attribute, use one of the following:

- Empty parentheses indicate that the database manager ignores the attribute when determining whether the data types match. For example, DEC() will be considered a match for a parameter of a function defined with a data type of DEC(7,2). However, FLOAT cannot be specified with empty parenthesis because its parameter value indicates a specific data type (REAL or DOUBLE).
- If a specific value for a length, precision, or scale attribute is specified, the value must exactly match the value that was specified (implicitly or explicitly) in the CREATE FUNCTION statement. If the data type is FLOAT, the precision does not have to exactly match the value that was specified because matching is based on the data type (REAL or DOUBLE).
- If length, precision, or scale is not explicitly specified, and empty parentheses are not specified, the default attributes of the data type are implied. The implicit length must exactly

match the value that was specified (implicitly or explicitly) in the CREATE FUNCTION statement.

Specifying the FOR DATA clause or CCSID clause is optional. Omission of either clause indicates that the database manager ignores the attribute when determining whether the data types match. If either clause is specified, it must match the value that was implicitly or explicitly specified in the CREATE FUNCTION statement.

AS LOCATOR

Specifies that the function is defined to receive a locator for this parameter. If AS LOCATOR is specified, the data type must be a LOB or XML or a distinct type based on a LOB or XML. If AS LOCATOR is specified, FOR SBCS DATA or FOR MIXED DATA must not be specified.

SPECIFIC FUNCTION *specific-name*

Identifies the function by its specific name. The *specific-name* must identify a specific function that exists at the current server.

INDEX *index-name*

Identifies the index to which the comment applies. The *index-name* must identify an index that exists at the current server.

MASK *mask-name*

Identifies the mask to which the comment applies. The *mask-name* must identify a mask that exists at the current server.

PACKAGE *package-name*

Identifies the package to which the comment applies. The *package-name* must identify a package that exists at the current server.⁸⁵

VERSION *version-id*

version-id is the version identifier that was assigned to the package when it was created. If *version-id* is not specified, a null string is used as the version identifier.

PARAMETER

Specifies that a comment will be added to or replaced for a parameter.

routine-name.parameter-name

Identifies the parameter to which the comment applies. The parameter could be for a procedure or a function. The *routine-name* must identify a procedure or function that exists at the current server, and the *parameter-name* must identify a parameter of that procedure or function.

specific-name.parameter-name

Identifies the parameter to which the comment applies. The parameter could be for a procedure or a function. The *specific-name* must identify a procedure or function that exists at the current server, and the *parameter-name* must identify a parameter of that procedure or function.

PERMISSION *permission-name*

Identifies the permission to which the comment applies. The *permission-name* must identify a permission that exists at the current server.

PROCEDURE or SPECIFIC PROCEDURE

Identifies the procedure to which the comment applies. The *procedure-name* must identify a procedure that exists at the current server.

PROCEDURE *procedure-name*

Identifies the procedure by its name. The *procedure-name* must identify exactly one procedure. The procedure may have any number of parameters defined for it. If there is more than one procedure of the specified name in the specified or implicit schema, an error is returned.

PROCEDURE *procedure-name (parameter-type, ...)*

Identifies the procedure by its procedure signature, which uniquely identifies the procedure. The *procedure-name (parameter-type, ...)* must identify a procedure with the specified procedure signature. The specified parameters must match the data types in the corresponding position that were specified when the procedure was created. The number of data types, and the logical

⁸⁵ If the identified package has a *version-id*, the comment is limited to 176 bytes.

concatenation of the data types is used to identify the specific procedure instance which is to be commented on. Synonyms for data types are considered a match. Parameters that have defaults must be included in this signature.

If *procedure-name ()* is specified, the procedure identified must have zero parameters.

procedure-name

Identifies the name of the procedure.

(parameter-type, ...)

Identifies the parameters of the procedure.

If an unqualified distinct type or array type name is specified, the database manager searches the SQL path to resolve the schema name for the distinct type or array type.

For data types that have a length, precision, or scale attribute, use one of the following:

- Empty parentheses indicate that the database manager ignores the attribute when determining whether the data types match. For example, DEC() will be considered a match for a parameter of a procedure defined with a data type of DEC(7,2). However, FLOAT cannot be specified with empty parenthesis because its parameter value indicates a specific data type (REAL or DOUBLE).
- If a specific value for a length, precision, or scale attribute is specified, the value must exactly match the value that was specified (implicitly or explicitly) in the CREATE PROCEDURE statement. If the data type is FLOAT, the precision does not have to exactly match the value that was specified because matching is based on the data type (REAL or DOUBLE).
- If length, precision, or scale is not explicitly specified, and empty parentheses are not specified, the default attributes of the data type are implied. The implicit length must exactly match the value that was specified (implicitly or explicitly) in the CREATE PROCEDURE statement.

Specifying the FOR DATA clause or CCSID clause is optional. Omission of either clause indicates that the database manager ignores the attribute when determining whether the data types match. If either clause is specified, it must match the value that was implicitly or explicitly specified in the CREATE PROCEDURE statement.

AS LOCATOR

Specifies that the procedure is defined to receive a locator for this parameter. If AS LOCATOR is specified, the data type must be a LOB or XML or a distinct type based on a LOB or XML. If AS LOCATOR is specified, FOR SBCS DATA or FOR MIXED DATA must not be specified.

SPECIFIC PROCEDURE *specific-name*

Identifies the procedure by its specific name. The *specific-name* must identify a specific procedure that exists at the current server.

SEQUENCE *sequence-name*

Identifies the sequence to which the comment applies. The *sequence-name* must identify a sequence that exists at the current server.

TABLE *table-name* or *view-name*

Identifies the table or view to which the comment applies. The *table-name* or *view-name* must identify a table or view that exists at the current server, but must not identify a declared temporary table.

TRIGGER *trigger-name*

Identifies the trigger to which the comment applies. The *trigger-name* must identify a trigger that exists at the current server.

TYPE *distinct-type-name* or *array-type-name*

Identifies the distinct type or array type to which the comment applies. The *distinct-type-name* or *array-type-name* must identify a type that exists at the current server.

VARIABLE *variable-name*

Identifies the variable to which the comment applies. The *variable-name* must identify a variable that exists at the current server.

XROBJECT *xrobject-name*

Identifies the XSR object to which the comment applies. The *xrobject-name* must identify an XSR object that exists at the current server.

IS

Introduces the comment that to be added or replaced.

string-constant

Can be any character-string constant of up to 2000 characters (500 for a sequence).

multiple-column-list

To comment on more than one column in a table or view, specify the table or view name and then, in parenthesis, a list of the form:

```
(column-name IS string-constant,  
column-name IS string-constant, ... )
```

The column name must not be qualified, each name must identify a column of the specified table or view, and that table or view must exist at the current server.

multiple-parameter-list

To comment on more than one parameter in a procedure or function, specify the procedure name, function name, or specific name, and then, in parenthesis, a list of the form:

```
(parameter-name IS string-constant,  
parameter-name IS string-constant, ... )
```

The parameter name must not be qualified, each name must identify a parameter of the specified procedure or function, and that procedure or function must exist at the current server.

Notes

Syntax alternatives: The following keywords are synonyms supported for compatibility to prior releases. These keywords are non-standard and should not be used:

- The keyword PROGRAM can be used as a synonym for PACKAGE.
- The keywords DATA TYPE or DISTINCT TYPE can be used as a synonym for TYPE.

Examples

Example 1: Insert a comment for the EMPLOYEE table.

```
COMMENT ON TABLE EMPLOYEE  
IS 'Reflects first quarter 2000 reorganization'
```

Example 2: Insert a comment for the EMP_VIEW1 view.

```
COMMENT ON TABLE EMP_VIEW1  
IS 'View of the EMPLOYEE table without salary information'
```

Example 3: Insert a comment for the EDLEVEL column of the EMPLOYEE table.

```
COMMENT ON COLUMN EMPLOYEE.EDLEVEL  
IS 'Highest grade level passed in school'
```

Example 4: Enter comments on two columns in the DEPARTMENT table.

```
COMMENT ON DEPARTMENT  
  (MGRNO IS 'EMPLOYEE NUMBER OF DEPARTMENT MANAGER',  
   ADMRDEPT IS 'DEPARTMENT NUMBER OF ADMINISTERING DEPARTMENT')
```

Example 5: Insert a comment for the PAYROLL package.

```
COMMENT ON PACKAGE PAYROLL  
  IS 'This package is used for distributed payroll processing.'
```

COMMIT

The COMMIT statement ends a unit of work and commits the database changes that were made by that unit of work.

Invocation

This statement can be embedded in an application program or issued interactively. It is an executable statement that can be dynamically prepared.

COMMIT is not allowed in a trigger if the trigger program and the triggering program run under the same commitment definition. COMMIT is not allowed in a procedure if the procedure is called on a Distributed Unit of Work connection to a remote application server or if the procedure is defined as ATOMIC. COMMIT is not allowed in a function.

Authorization

None required.

Syntax

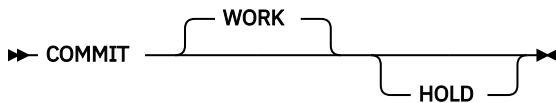

Description

The COMMIT statement ends the unit of work in which it is executed and starts a new unit of work. It commits all changes made by SQL schema statements (except DROP SCHEMA) and SQL data change statements during the unit of work. For information about SQL schema statements and SQL data change statements see [Chapter 7, “Statements,” on page 793](#).

Connections in the release-pending state are ended.

WORK

COMMIT WORK has the same effect as COMMIT.

HOLD

Specifies a hold on resources. If specified, currently open cursors are not closed whether they are declared with a HOLD option or not. All resources acquired during the unit of work are held. Locks on specific rows and objects implicitly acquired during the unit of work are released.

All implicitly acquired locks are released; except for object level locks required for the cursors that are not closed.

All locators that are not held are released. For more information about held locators, see [“HOLD LOCATOR” on page 1383](#).

Notes

Recommended coding practices: An explicit COMMIT or ROLLBACK statement should be coded at the end of an application process. Either an implicit commit or rollback operation will be performed at the end of an application process depending on the application environment. Thus, a portable application should explicitly execute a COMMIT or ROLLBACK before execution ends in those environments where explicit COMMIT or ROLLBACK is permitted.

An implicit COMMIT or ROLLBACK may be performed under the following circumstances.

- For the default activation group:

- An implicit COMMIT is not performed when applications that run in the default activation group end. Interactive SQL, Query Manager, and non-ILE programs are examples of programs that run in the default activation group.
- In order to commit work, you must issue a COMMIT.
- For non-default activation groups when the scope of the commitment definition is to the activation group:
 - If the activation group ends normally, the commitment definition is implicitly committed.
 - If the activation group ends abnormally, the commitment definition is implicitly rolled back.
- Regardless of the type of activation group, if the scope of the commitment definition is the job, an implicit commit is never performed.

Effect of commit: Commit without HOLD causes the following to occur:

- Connections in the release-pending state are ended.
- For existing connections:
- all open cursors that were declared with the WITH HOLD clause are preserved and their current position is maintained, although a FETCH statement is required before a Positioned UPDATE or Positioned DELETE statement can be executed.
 - all open cursors that were declared without the WITH HOLD clause including any opened under isolation level NC are closed.
- All LOB locators that are not held are freed. Note that this is true even when the locators are associated with LOB values retrieved via a cursor that has the WITH HOLD property.
 - All locks acquired by the LOCK TABLE statement are released. All implicitly acquired locks are released, except for those required for the cursors that were not closed.

Row lock limit: A unit of work can include the processing of up to 4 million rows, including rows retrieved during a SELECT or FETCH statement⁸⁶, and rows inserted, deleted, or updated as part of INSERT, DELETE, and UPDATE statements.⁸⁷

Unaffected statements: The commit and rollback operations do not affect the DROP SCHEMA statement, and this statement is not, therefore, allowed in an application program that also specifies COMMIT(*CHG), COMMIT(*CS), COMMIT(*ALL), or COMMIT(*RR).

COMMIT Restrictions: A commit or rollback in a user-defined function in a secondary thread is not allowed.

Commitment definition use: The commitment definition used by SQL is determined as follows:

- If the activation group of the program calling SQL is already using an activation group level commitment definition, then SQL uses that commitment definition.
- If the activation group of the program calling SQL is using the job level commitment definition, then SQL uses the job level commitment definition.
- If the activation group of the program calling SQL is not currently using a commitment definition but the job commitment definition is started, then SQL uses the job commitment definition.

⁸⁶ This limit also includes:

- Any rows accessed or changed through files opened under commitment control through high-level language file processing
- Any rows deleted, updated, or inserted as a result of a trigger or CASCADE, SET NULL, or SET DEFAULT referential integrity delete rule.

⁸⁷ Unless you specified COMMIT(*CHG) or COMMIT(*CS), in which case these rows are not included in this total.

- If the activation group of the program calling SQL is not currently using a commitment definition and the job commitment definition is not started, then SQL implicitly starts a commitment definition. SQL uses the Start Commitment Control (STRCMTCTL) command with:
 - A CMTSCOPE(*ACTGRP) parameter
 - A LCKLVL parameter based on the COMMIT option specified on either the CRTSQLxxx, STRSQL, or RUNSQLSTM commands. In REXX, the LCKLVL parameter is based on the commit option in the SET OPTION statement.

Example

In a C program, transfer a certain amount of commission (COMM) from one employee (EMPNO) to another in the EMPLOYEE table. Subtract the amount from one row and add it to the other. Use the COMMIT statement to ensure that no permanent changes are made to the database until both operations are completed successfully.

```
void main ()
{
    EXEC SQL  BEGIN DECLARE SECTION;
    decimal(5,2) AMOUNT;
    char FROM_EMPNO[7];
    char TO_EMPNO[7];
    EXEC SQL  END DECLARE SECTION;
    EXEC SQL  INCLUDE SQLCA;
    EXEC SQL  WHENEVER SQLERROR GOTO SQLERR;
    ...
    EXEC SQL  UPDATE EMPLOYEE
              SET COMM = COMM - :AMOUNT
              WHERE EMPNO = :FROM_EMPNO;
    EXEC SQL  UPDATE EMPLOYEE
              SET COMM = COMM + :AMOUNT
              WHERE EMPNO = :TO_EMPNO;
    FINISHED:
    EXEC SQL  COMMIT WORK;
    return;

    SQLERR:
    ...
    EXEC SQL  WHENEVER SQLERROR CONTINUE; /* continue if error on rollback */
    EXEC SQL  ROLLBACK WORK;
    return;
}
```

compound (dynamic)

A compound (dynamic) statement groups other statements together in an executable routine. A compound statement allows the declaration of SQL variables, cursors, and condition handlers.

Invocation

This statement can be issued interactively. It is an executable statement that can be dynamically prepared. It cannot be embedded in an application program.

Authorization

The privileges held by the authorization ID of the statement must also include all of the privileges necessary to invoke the SQL statements that are specified in the compound (dynamic) statement.

Syntax

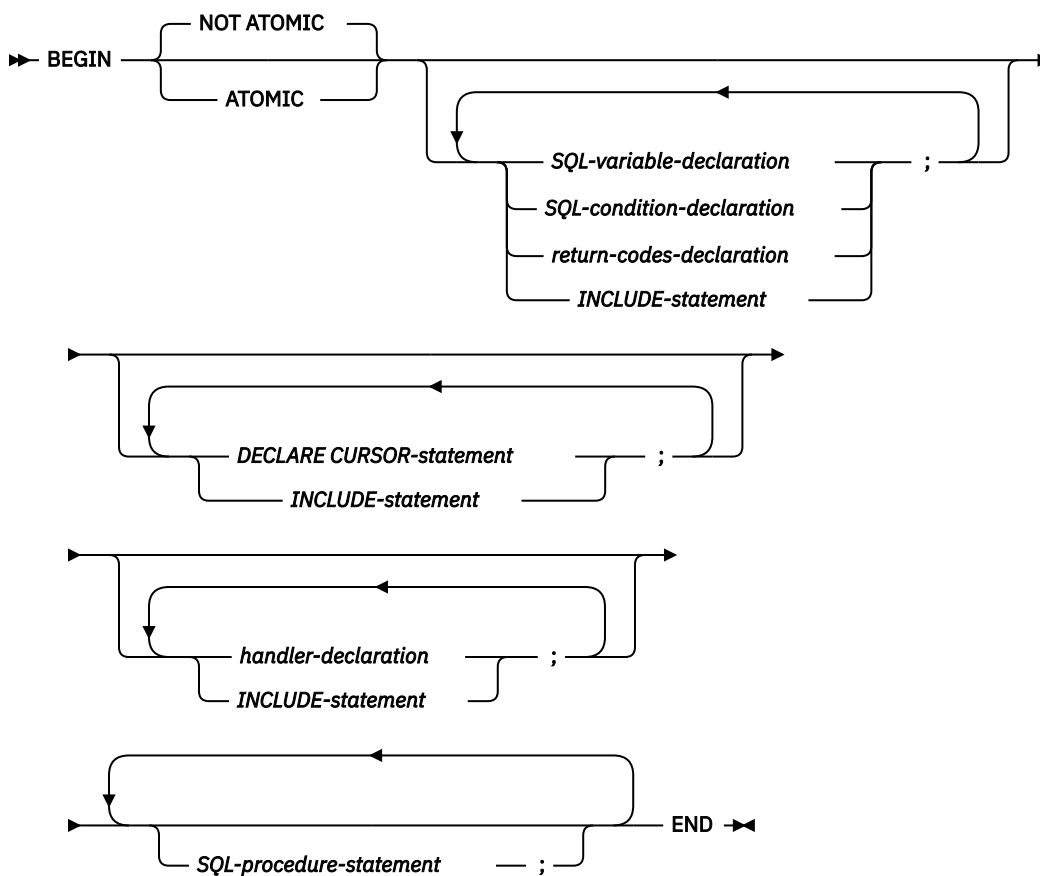

SQL-variable-declaration

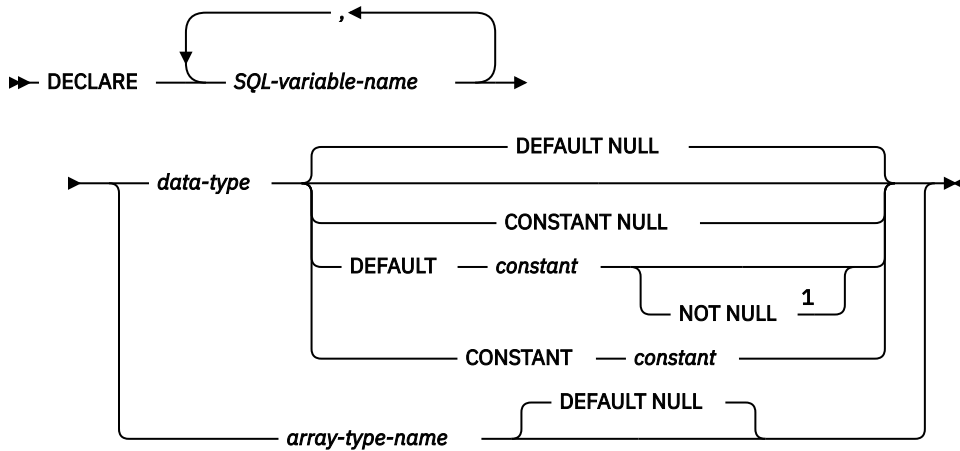

SQL-condition-declaration

→ DECLARE — *SQL-condition-name* — CONDITION →

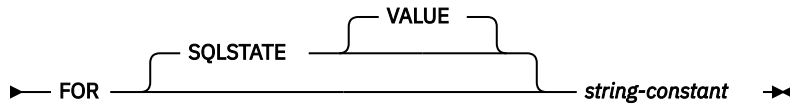

return-codes-declaration

→ DECLARE →

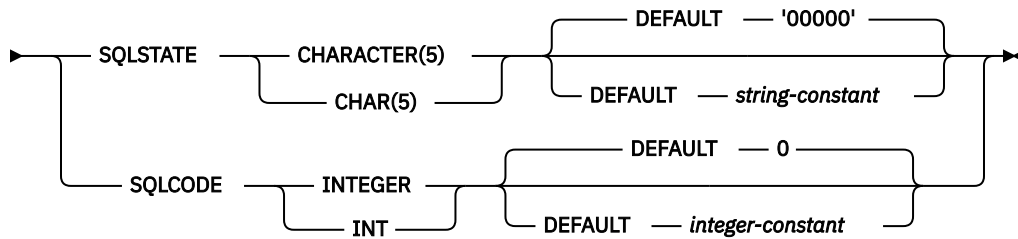

handler-declaration

→ DECLARE → {
 — CONTINUE —
 — EXIT —
 — UNDO —
 } HANDLER FOR → {
 — *specific-condition-value* —
 — *general-condition-value* —
 } → ²

→ *SQL-procedure-statement* →

specific-condition-value

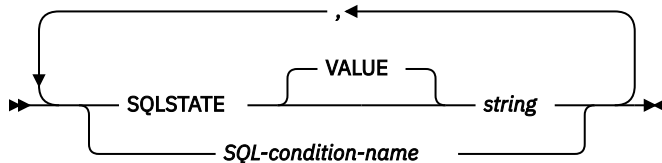

general-condition-value

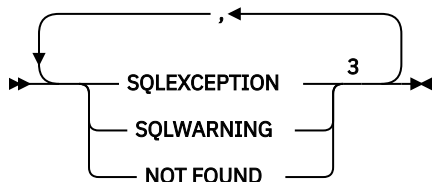

data-type

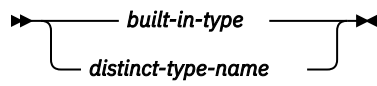

Notes:

- ¹ The DEFAULT and NOT NULL clauses can be specified in either order.
- ² *specific-condition-value* and *general-condition-value* cannot be specified in the same handler declaration.
- ³ The same clause must not be specified more than once.

built-in-type

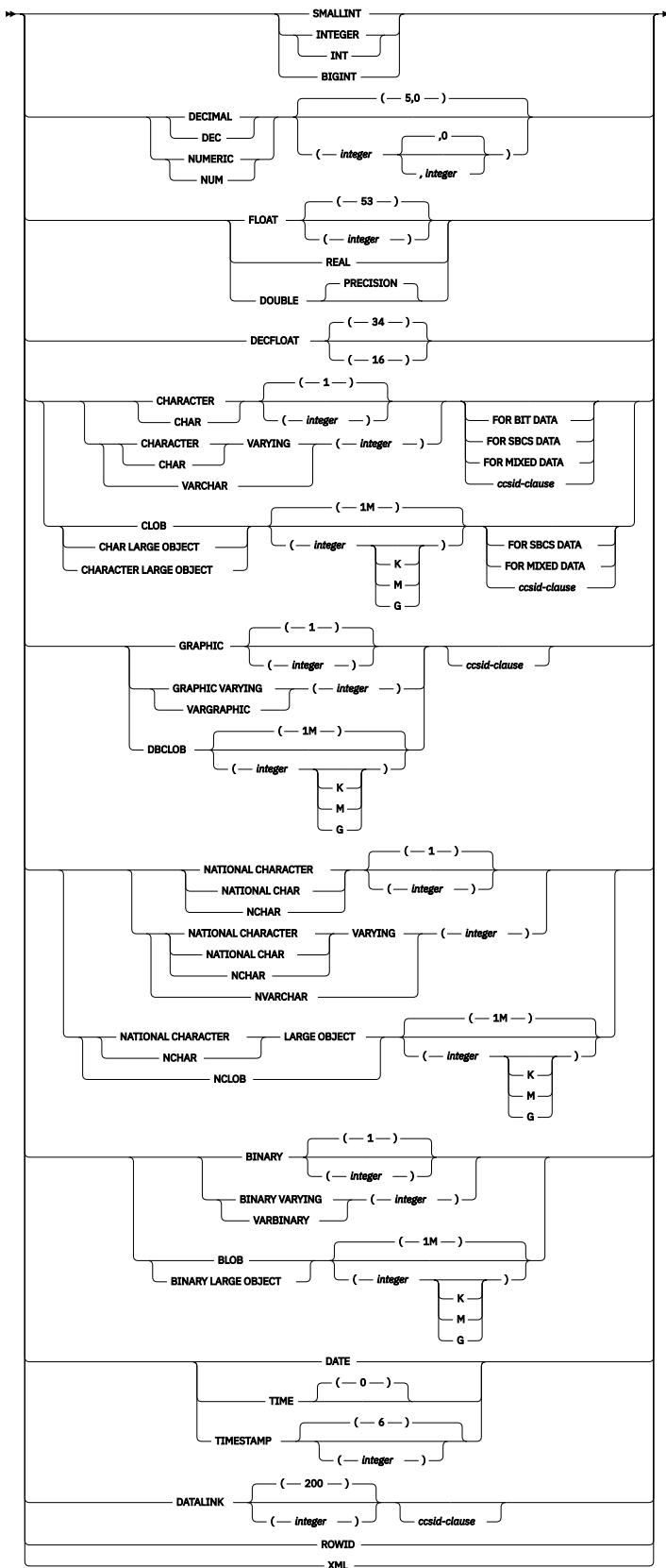

ccsid-clause

➤ CCSID — *integer* ➤

Description

ATOMIC

ATOMIC indicates that an unhandled exception condition within the compound (dynamic) statement causes the compound statement to be rolled back. If ATOMIC is specified, COMMIT, ROLLBACK (ROLLBACK TO SAVEPOINT may be specified), SET CURRENT DEBUG MODE, SET CURRENT DEGREE, SET CURRENT DECFLOAT ROUNDING MODE, SET CURRENT IMPLICIT XMLPARSE OPTION, SET CURRENT TEMPORAL SYSTEM_TIME, SET PATH, and SET SCHEMA statements cannot be specified in the compound statement.

NOT ATOMIC

NOT ATOMIC indicates that an unhandled exception condition within the compound (dynamic) statement does not cause the compound statement to be rolled back.

SQL-variable-declaration

Declares a variable that is local to the compound (dynamic) statement.

SQL-variable-name

Defines the name of a local SQL variable. The database manager converts all undelimited SQL variable names to uppercase. The name must not be the same as another SQL variable within the same compound (dynamic) statement, excluding any declarations in *compound-statements* nested within the compound (dynamic) statement. Do not name SQL variables the same as a column name. See [“References to SQL parameters and SQL variables” on page 1571](#) for how SQL variable names are resolved when there are columns with the same name involved in a statement. Variable names should not begin with 'SQL'.

data-type

Specifies the data type of the variable. See [“CREATE TABLE” on page 1105](#) for a description of data type.

If the *data-type* is a graphic string data type, consider specifying CCSID 1200 or 13488 to indicate UTF-16 or UCS-2 data. If a CCSID is not specified, the CCSID of the graphic string variable will be the associated DBCS CCSID for the job.

array-type-name

Specifies that the SQL variable is an array as defined with the CREATE TYPE (Array) statement.

DEFAULT constant or NULL

Defines the default for the SQL variable. The specified constant must represent a value that could be assigned to the variable in accordance with the rules of assignment as described in [“Assignments and comparisons” on page 91](#). The variable is initialized when the compound (dynamic) statement is invoked. If a default value is not specified, the SQL variable is initialized to NULL. SQL variables of type XML cannot have a default value specified.

NOT NULL

Prevents the SQL variable from containing the NULL value. Omission of NOT NULL implies that the variable can be null. SQL variables of type XML cannot have NOT NULL specified.

CONSTANT constant or NULL

Specifies that the SQL variable has a fixed value that cannot be changed. An SQL variable that is defined using CONSTANT cannot be used as the target of any assignment operation. The specified constant must represent a value that could be assigned to the variable in accordance with the rules of assignment as described in [“Assignments and comparisons” on page 91](#).

SQL-condition-declaration

Declares a condition name and corresponding SQLSTATE value.

SQL-condition-name

Specifies the name of the condition. The condition name must be unique within the compound (dynamic) statement, excluding any declarations in *compound-statements* nested within the compound (dynamic) statement.

FOR SQLSTATE string-constant

Specifies the SQLSTATE associated with this condition. The string constant must be specified as 5 characters. The SQLSTATE class (the first 2 characters) must not be '00'.

return-codes-declaration

Declares special SQL variables called SQLSTATE and SQLCODE that are set for the first condition in the diagnostics area after executing an SQL statement other than GET DIAGNOSTICS or an empty *compound-statement*.

The SQLSTATE and SQLCODE special variables are only intended to be used as a means of obtaining the SQL return codes that resulted from processing the previous SQL statement other than GET DIAGNOSTICS. If there is any intention to use the SQLSTATE and SQLCODE values, save the values immediately to other SQL variables to avoid having the values replaced by the SQL return codes returned after executing the next SQL statement. If a handler is defined that handles an SQLSTATE, you can use an assignment statement to save that SQLSTATE (or the associated SQLCODE) value in another SQL variable, if the assignment is the first statement in the handler.

Assignment to these variables is not prohibited; however, it is not recommended. Assignment to these special variables is ignored by condition handlers. The SQLSTATE and SQLCODE special variables cannot be set to NULL.

DECLARE CURSOR-statement

Declares a cursor in the compound (dynamic) statement. The cursor name must be unique within the compound (dynamic) statement, excluding any declarations in *compound-statements* nested within the compound (dynamic) statement.

A *cursor-name* can only be referenced within the compound (dynamic) statement in which it is declared, including any *compound-statements* nested within the compound (dynamic) statement.

Use an OPEN statement to open the cursor, and a FETCH statement to read rows using the cursor. Any open cursor is closed at the end of the compound (dynamic) statement.

For more information about declaring a cursor, refer to [“DECLARE CURSOR” on page 1207](#).

handler-declaration

Specifies a *handler*, an *SQL-procedure-statement* to execute when an exception or completion condition occurs in the compound (dynamic) statement.

A condition handler declaration cannot reference the same condition value or SQLSTATE value more than once, and cannot reference an SQLSTATE value and a condition name that represent the same SQLSTATE value. For a list of SQLSTATE values as well as more information, see the [SQL messages and codes](#) topic collection.

Furthermore, when two or more condition handlers are declared in a compound (dynamic) statement, no two condition handler declarations may specify the same:

- general condition category or
- specific condition, either as an SQLSTATE value or as a condition name that represents the same value.

A condition handler is active for the set of *SQL-procedure-statements* that follow the *handler-declarations* within the compound (dynamic) statement, including any nested *compound-statements*.

A handler for a condition may exist at several levels of nested compound statements. For example, assume that compound (dynamic) statement *n1* contains another compound statement *n2* which contains another compound statement *n3*. When an exception condition occurs within *n3*, any active handlers within *n3* are first allowed to handle the condition. If no appropriate handler exists in *n3*, then the condition is resignalled to *n2* and the active handlers within *n2* may handle the condition. If no appropriate handler exists in *n2*, then the condition is resignalled to *n1* and the active handlers within *n1* may handle the condition. If no appropriate handler exists in *n1*, the condition is considered unhandled.

There are three types of condition handlers:

CONTINUE

Specifies that after the condition handler is activated and completes successfully, control is returned to the SQL statement following the one that raised the exception. If the error occurs

while executing a comparison as in an IF, CASE, FOR, WHILE, or REPEAT, control returns to the statement following the corresponding END IF, END CASE, END FOR, END WHILE, or END REPEAT.

EXIT

Specifies that after the condition handler is activated and completes successfully, control is returned to the end of the compound (dynamic) statement.

UNDO

Specifies that when the condition handler is activated changes made by the compound (dynamic) statement are rolled back. When the handler completes successfully, control is returned to the end of the compound (dynamic) statement. If UNDO is specified, then ATOMIC must be specified.

The conditions under which the handler is activated are:

SQLSTATE string

Specifies that the handler is invoked when the specific SQLSTATE occurs. The SQLSTATE class (the first 2 characters) must not be '00'.

SQL-condition-name

Specifies that the handler is invoked when the specific SQLSTATE associated with the condition name occurs. The *SQL-condition-name* must be previously defined in a *SQL-condition-declaration*.

SQLEXCEPTION

Specifies that the handler is invoked when an exception condition occurs. An exception condition is represented by an SQLSTATE value where the first two characters are not '00', '01', or '02'.

SQLWARNING

Specifies that the handler is invoked when a warning condition occurs. A warning condition is represented by an SQLSTATE value where the first two characters are '01'.

NOT FOUND

Specifies that the handler is invoked when a NOT FOUND condition occurs. A NOT FOUND condition is represented by an SQLSTATE value where the first two characters are '02'.

SQL-procedure-statement

An SQL statement or SQL control statement as defined in [“SQL-procedure-statement” on page 1576](#). The SET RESULT SETS and SET SESSION AUTHORIZATION SQL statements are not allowed.

Notes

Compound (dynamic) content: See [“SQL control statements” on page 1569](#) for more information on the constructs that can be used in a compound (dynamic) statement.

Nesting compound statements: *Compound-statements* can be nested within a compound (dynamic) statement. Nested compound statements can be used to scope variable definitions, condition names, condition handlers, and cursors to a subset of the statements in the compound (dynamic) statement. This can simplify the processing done for each *SQL-procedure-statement*. Support for nested compound statements enables the use of a compound statement within the declaration of a condition handler.

Compound (dynamic) statement execution: When a compound (dynamic) statement is dynamically prepared and executed, the statements within the compound statement are processed as static statements. A temporary program that embeds the statements for the compound statement is created and then executed. The program name is QTEMP.QCMPDnnnnn, where nnnnn is a unique number for the job.

CURRENT PATH and CURRENT SCHEMA: The current schema and current path apply to the prepared and executed compound (dynamic) statement. Any change to these special registers within the compound statement does not affect subsequent resolution of statements within the same compound statement. For example:

```
SET SCHEMA prodlib;
SET stmt = 'BEGIN SET SCHEMA data1ib; INSERT INTO test_table VALUES(1); END';
PREPARE compound_stmt FROM stmt;
EXECUTE compound_stmt;
```

When the compound statement `compound_stmt` is prepared and executed, the `INSERT` will resolve to `PRODLIB.TEST_TABLE`, not `DATALIB.TEST_TABLE`.

Most end user SQL script interfaces use dynamic SQL to execute SQL statements. For example, executing the following two statements in IBM i Navigator's Run SQL Scripts is logically equivalent to the above example. The `INSERT` will resolve to `PRODLIB.TEST_TABLE`, not `DATALIB.TEST_TABLE`.

```
SET SCHEMA prodlib;
BEGIN
  SET SCHEMA datalib;
  INSERT INTO test_table VALUES(1);
END;
```

Condition handlers: Condition handlers in a compound (dynamic) statement are similar to `WHENEVER` statements used in external SQL application programs. A condition handler can be defined to automatically get control when an exception, warning, or not found condition occurs. The body of a condition handler contains code that is executed when the condition handler is activated. A condition handler can be activated as a result of an exception, warning, or not found condition that is returned by the database manager for the processing of an SQL statement, or the activating condition can be the result of a `SIGNAL` or `RESIGNAL` statement issued within the routine body.

A condition handler is declared within a compound (dynamic) statement, and it is active for the set of *SQL-procedure-statements* that follow all of the condition handler declarations within the compound (dynamic) statement. To be more specific, the scope of a condition handler declaration `H` is the list of *SQL-procedure-statements* that follows the condition handler declarations contained within the compound (dynamic) statement in which `H` appears. This means that the scope of `H` does not include the statements contained in the body of the condition handler `H`, implying that a condition handler cannot handle conditions that arise inside its own body. Similarly, for any two condition handlers `H1` and `H2` declared in the same compound (dynamic) statement, `H1` will not handle conditions arising in the body of `H2`, and `H2` will not handle conditions arising in the body of `H1`.

The declaration of a condition handler specifies the condition that activates it, the type of the condition handler (`CONTINUE`, `EXIT`, or `UNDO`), and the handler action. The type of the condition handler determines where control is returned to after successful completion of the handler action.

Condition handler activation: When a condition other than successful completion occurs in the processing of an *SQL-procedure-statement*, if a condition handler that could handle the condition is within scope, one such condition handler will be activated to process the condition.

In a compound (dynamic) statement with nested *compound-statements*, condition handlers that could handle a specific condition may exist at several levels of the nested compound statements. The condition handler that is activated is a condition handler that is declared innermost to the scope in which the condition was encountered. If more than one condition handler at that nesting level could handle the condition, the condition handler that is activated is the most appropriate handler declared in that compound statement.

The most appropriate handler is a handler that is defined in the compound statement which most closely matches the `SQLSTATE` of the exception or completion condition.

For example, if the innermost compound statement declares a specific handler for `SQLSTATE 22001` as well as a handler for `SQLEXCEPTION`, the specific handler for `SQLSTATE 22001` is the most appropriate handler when an `SQLSTATE 22001` is encountered. In this case, the specific handler is activated.

When a condition handler is activated, the condition handler action is executed. If the handler action completes successfully or with an unhandled warning, the diagnostics area is cleared, and the type of the condition handler (`CONTINUE`, `EXIT`, or `UNDO` handler) determines where control is returned. Additionally, the `SQLSTATE` and `SQLCODE` SQL variables are cleared when a handler completes successfully or with an unhandled warning.

If the handler action does not complete successfully, and an appropriate handler exists for the condition encountered in the handler action, that condition handler is activated. Otherwise, the condition encountered within the condition handler is unhandled.

Unhandled conditions: If a condition is encountered and an appropriate handler does not exist for that condition, the condition is unhandled.

- If the unhandled condition is an exception, the compound statement containing the failing statement is terminated with an unhandled exception condition.
- If the unhandled condition is a warning or not found condition, processing continues with the next statement. Note that the processing of the next SQL statement will cause information about the unhandled condition in the diagnostics area to be overwritten, and evidence of the unhandled condition will no longer exist.

Considerations for using SIGNAL or RESIGNAL statements with nested compound statements: If an *SQL-procedure-statement* specified in the condition handler is either a SIGNAL or RESIGNAL statement with an exception SQLSTATE, the compound (dynamic) statement terminates with the specified exception. This happens even if this condition handler or another condition handler in the same compound (dynamic) statement specifies CONTINUE, since these condition handlers are not in the scope of this exception. If a *compound-statement* is nested in a compound (dynamic) statement, condition handlers in the compound (dynamic) statement may handle the exception from within the *compound-statement* because those condition handlers are within the scope of the exception.

Null values in SQL variables: If the value of an SQL variable is null and it is used in an SQL statement (such as CONNECT or DESCRIBE) that does not allow an indicator variable, an error is returned.

Uncommitted changes: Any uncommitted transactional work is scoped to the activation group of the connection in which the dynamic compound statement is run.

Effect on open cursors: Upon exit from the compound (dynamic) statement for any reason, all open cursors that are declared in that compound statement are closed.

Considerations for SQLSTATE and SQLCODE SQL variables: The compound (dynamic) statement itself does not affect the SQLSTATE and SQLCODE SQL variables. However, SQL statements contained within the compound statement can affect the SQLSTATE and SQLCODE SQL variables. At the end of the compound statement the SQLSTATE and SQLCODE SQL variables reflect the result of the last SQL statement executed within that compound statement that caused a change to the SQLSTATE and SQLCODE SQL variables. If the SQLSTATE and SQLCODE variables were not changed within the compound (dynamic) statement, they contain the same values as when the compound (dynamic) statement was invoked.

CONNECT (type 1)

The CONNECT (type 1) statement connects an activation group within an application process to the identified application server using the rules for remote unit of work. This server is then the current server for the activation group. This type of CONNECT statement is used if RDBCNNMTH(*RUW) was specified on the CRTSQLxxx command.

Differences between the two types of statements are described in “CONNECT (type 1) and CONNECT (type 2) differences” on page 1654. Refer to “Application-directed distributed unit of work” on page 38 for more information about connection states.

Invocation

This statement can only be embedded within an application program or issued interactively. It is an executable statement that cannot be dynamically prepared. It must not be specified in Java or REXX.

CONNECT is not allowed in a trigger or function.

Authorization

The privileges held by the authorization ID of the statement must include communications-level security. (See the section about security in [Distributed Database Programming](#)).

If the application server is Db2 for i, the user profile of the person issuing the statement must also be a valid user profile on the application server system, UNLESS:

- User is specified. In this case, the USER clause must specify a valid user profile on the application server system.
- TCP/IP is used with a server authorization entry for the application server. In this case, the server authorization entry must specify a valid user profile on the application server system.

If a global variable is referenced in a statement, the privileges held by the authorization ID of the statement must include at least one of the following:

- For the global variable identified in the statement,
 - The READ privilege on the global variable, and
 - The USAGE privilege on the schema containing the global variable
- Database administrator authority

Syntax

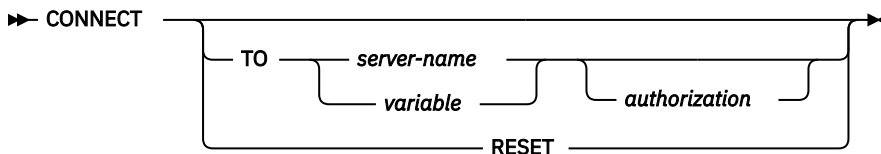

authorization

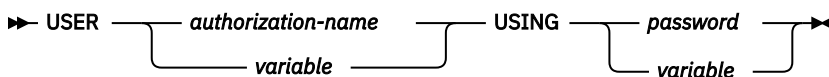

Description

TO server-name or variable

Identifies the application server by the specified server name or the server name contained in the variable. It can be a global variable if it is qualified with schema name. If a variable is specified:

- It must be a CHAR or VARCHAR host variable.

- It must not be followed by an indicator variable.
- The server name must be left-justified within the variable and must conform to the rules for forming an ordinary identifier.
- If the length of the server name is less than the length of the variable, it must be padded on the right with blanks.

When the CONNECT statement is executed, the specified server name or the server name contained in the variable must identify an application server described in the local directory and the activation group must be in the connectable state.

If the *server-name* is a local relational database and an *authorization-name* is specified, it must be the user of the job. If the specified *authorization-name* is different than the user of the job, an error occurs and the application is left in the unconnected state.

USER *authorization-name* or variable

Identifies the authorization name that will be used to connect to the application server. It can be a global variable if it is qualified with schema name.

If a *variable* is specified,

- It must be a CHAR or VARCHAR host variable.
- It must not be followed by an indicator variable.
- The authorization name must be left-justified within the variable and must conform to the rules of forming an authorization name.
- If the length of the authorization name is less than the length of the variable, it must be padded on the right with blanks.
- The value of the server name must not contain lowercase characters.

USING *password* or variable

Identifies the password that will be used to connect to the application server.

If password is specified as a literal, it must be a character string. The maximum length is 128 characters. It must be left justified. The literal form of the password is not allowed in static SQL or REXX.

If a *variable* is specified,

- It cannot be a global variable.
- It must be a CHAR or VARCHAR host variable.
- It must not be followed by an indicator variable.
- The password must be left-justified within the variable.
- If the length of the password is less than that of the variable, it must be padded on the right with blanks.

RESET

CONNECT RESET is equivalent to CONNECT TO x where x is the local server name.

CONNECT with no operand

This form of the CONNECT statement returns information about the current server and has no effect on connection states, open cursors, prepared statements, or locks. The connection information is returned in the connection information items in the SQL Diagnostics Area (or the SQLCA).

Notes

Successful connection: If the CONNECT statement is successful:

- All open cursors are closed, all prepared statements are destroyed, and all locks are released from the current connection.
- The activation group is disconnected from all current and dormant connections, if any, and connected to the identified application server.

- The name of the application server is placed in the CURRENT SERVER special register.
- Information about the application server is placed in the *connection-information-items* in the SQL Diagnostics Area.
- Information about the application server is also placed in the SQLERRP and SQLERRD(4) fields of the SQLCA. If the application server is an IBM relational database product, the information in the SQLERRP field has the form *pppvrrm*, where:
 - *ppp* identifies the product as follows:
 - ARI for Db2 for VM and VSE
 - DSN for Db2 for z/OS
 - QSQ for Db2 for i
 - SQL for all other Db2 products
 - *vv* is a two-digit version identifier such as '09'
 - *rr* is a two-digit release identifier such as '01'
 - *m* is a one-character modification level such as '0'

For example, if the application server is Version 9 of Db2 for z/OS, the value of SQLERRP is 'DSN09010'.

The SQLERRD(4) field of the SQLCA contains values indicating whether the application server allows committable updates to be performed. For a CONNECT (type 1) statement SQLERRD(4) will always contain the value 1. The value 1 indicates that committable updates can be performed, and the connection:

- Uses an unprotected conversation⁸⁸, or
 - Is a connection to an application requester driver program using the *RUW connection method, or
 - Is a local connection using the *RUW connection method.
- Additional information about the connection is placed in the SQLERRMC field of the SQLCA. Refer to [Appendix C, “SQLCA \(SQL communication area\),” on page 1657](#)

Unsuccessful connection: If the CONNECT statement is unsuccessful, the DB2_MODULE_DETECTING_ERROR condition information item in the SQL Diagnostics Area (or the SQLERRP field of the SQLCA) is set to the name of the module at the application requester that detected the error. Note that the first three characters of the module name identify the product. For example, if the application requester is Db2 LUW the first three characters are 'SQL'.

If the CONNECT statement is unsuccessful because the activation group is not in the connectable state, the connection state of the activation group is unchanged.

If the CONNECT statement is unsuccessful for any other reason:

- The activation group remains in a connectable, but unconnected state
- All open cursors are closed, all prepared statements are destroyed, and all locks are released from all current and dormant connections.

An application in a connectable but unconnected state can only execute the CONNECT or SET CONNECTION statements.

Implicit connect:

- When running in the default activation group, the SQL program implicitly connects to a remote relational database when:
 - The activation group is in a connectable state.
 - The first SQL statement in the first SQL program on the program stack is executed.

⁸⁸ To reduce the possibility of confusion between network connections and SQL connections, in this book the term 'conversation' will be used to apply to network connections over TCP/IP as well as over APPC, even though it formally applies only to APPC connections.

- When running in a non-default activation group, the SQL program implicitly connects to a remote relational database when the first SQL statement in the first SQL program for that activation group is executed.

Note: It is a good practice for the first SQL statement executed by an activation group to be the CONNECT statement.

When APPC is used for connecting to an RDB, implicit connect always sends the *authorization-name* of the application requester job and does not send passwords. If the *authorization-name* of the application server job is different, or if a password must be sent, an explicit connect statement must be used.

When TCP/IP is used for connecting to an RDB, an implicit connect is not bound by the above restrictions. Use of the ADDSVRAUTE and other -SVRAUTE commands allows one to specify, for a given user under which the implicit (or explicit) CONNECT is done, the remote authorization-name and password to be used in connecting to a given RDB.

In order for the password to be stored with the ADDSVRAUTE or CHGSVRAUTE command, the QRETSVRSEC system value must be set to '1' rather than the default of '0'. When using these commands for DRDA connection, it is very important to realize that the value of the RDB name entered into the SERVER parameter must be in UPPER CASE. For more information, see Example 2 under Type 2 CONNECT.

For more information about implicit connect, refer to the [SQL Programming](#) topic collection. Once a connection to a relational database for a user profile is established, the password, if specified, may not be validated again on subsequent connections to the same relational database with the same user profile. Revalidation of the password depends on if the conversation is still active. See the [Distributed Database Programming](#) topic collection for more details.

Connection states: For a description of connection states, see [“Remote unit of work connection management”](#) on page 37. Consecutive CONNECT statements can be executed successfully because CONNECT does not remove the activation group from the connectable state.

A CONNECT to either a current or dormant connection in the application group is executed as follows:

- If the connection identified by the server-name was established using a CONNECT (type 1) statement, then no action is taken. Cursors are not closed, prepared statements are not destroyed, and locks are not released.
- If the connection identified by the server-name was established using a CONNECT (type 2) statement, then the CONNECT statement is executed like any other CONNECT statement.

CONNECT cannot execute successfully when it is preceded by any SQL statement other than CONNECT, COMMIT, DISCONNECT, SET CONNECTION, RELEASE, or ROLLBACK. To avoid an error, execute a commit or rollback operation before a CONNECT statement is executed.

If any previous current or dormant connections were established using protected conversations, then the CONNECT (type 1) statement will fail. Either, a CONNECT (type 2) statement must be used, or the connections using protected conversations must be ended by releasing the connections and successfully committing.

For more information about connecting to a remote relational database and the local directory, see [SQL Programming](#) and the [Distributed Database Programming](#).

SET SESSION AUTHORIZATION: If a SET SESSION AUTHORIZATION statement has been executed in the thread, a CONNECT to the local server will fail unless prior to the connect statement, the SYSTEM_USER value is the same as SESSION_USER.

This includes an implicit connect due to invoking a program that specifies ACTGRP(*NEW).

Examples

Example 1: In a C program, connect to the application server TOROLAB.

```
EXEC SQL CONNECT TO TOROLAB;
```

Example 2: In a C program, connect to an application server whose name is stored in the variable APP_SERVER (VARCHAR(18)). Following a successful connection, copy the product identifier of the application server to the variable PRODUCT.

```
void main ()
{
  char product[9] = " ";
  EXEC SQL BEGIN DECLARE SECTION;
  char APP_SERVER[19];
  char username[11];
  char userpass[129];
  EXEC SQL END DECLARE SECTION;
  EXEC SQL INCLUDE SQLCA;
  strcpy(APP_SERVER, "TOROLAB");
  strcpy(username, "JOE");
  strcpy(userpass, "XYZ1");
  EXEC SQL CONNECT TO :APP_SERVER
          USER :username USING :userpass;
  if (stncmp(SQLSTATE, "00000", 5) )
    { EXEC SQL GET DIAGNOSTICS CONDITION 1
      product = DB2_PRODUCT_ID; }
  ...
  return;
}
```

CONNECT (type 2)

The CONNECT (type 2) statement connects an activation group within an application process to the identified application server using the rules for application directed distributed unit of work. This server is then the current server for the activation group. This type of CONNECT statement is used if RDBCNNMTH(*DUW) was specified on the CRTSQLxxx command.

Differences between the two types of statements are described in “CONNECT (type 1) and CONNECT (type 2) differences” on page 1654. Refer to “Application-directed distributed unit of work” on page 38 for more information about connection states.

Invocation

This statement can only be embedded in an application program or issued interactively. It is an executable statement that cannot be dynamically prepared. It must not be specified in Java or REXX.

CONNECT is not allowed in a trigger or function.

Authorization

The privileges held by the authorization ID of the statement must include communications-level security. (See the section about security in the [Distributed Database Programming topic collection](#).)

If the application server is Db2 for i, the profile ID of the person issuing the statement must also be a valid user profile on the application server system, UNLESS:

- USER is specified. If USER is specified, the USER clause must specify a valid user profile on the application server system.
- TCP/IP is used with a server authorization entry for the application server. If this is the case, the server authorization entry must specify a valid user profile on the application server system.

If a global variable is referenced in a statement, the privileges held by the authorization ID of the statement must include at least one of the following:

- For the global variable identified in the statement,
 - The READ privilege on the global variable, and
 - The USAGE privilege on the schema containing the global variable
- Database administrator authority

Syntax

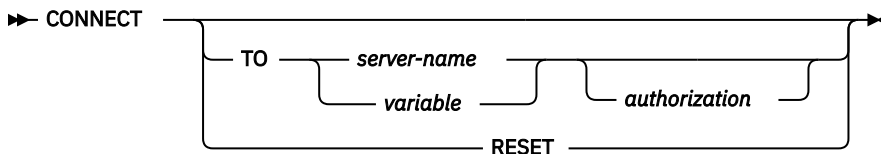

authorization

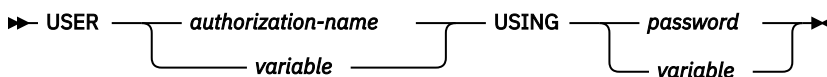

Description

TO server-name or variable

Identifies the application server by the specified server name or the server name contained in the variable. It can be a global variable if it is qualified with schema name. If a variable is specified:

- It must be a CHAR or VARCHAR host variable.

- It must not be followed by an indicator variable.
- The server name must be left-justified within the variable and must conform to the rules for forming an ordinary identifier.
- If the length of the server name is less than the length of the variable, it must be padded on the right with blanks.
- The value of the server name must not contain lowercase characters.

When the CONNECT statement is executed, the specified server name or the server name contained in the variable must identify an application server described in the local directory.

Let S denote the specified server name or the server name contained in the variable. S must not identify an existing connection of the application process.

USER *authorization-name or variable*

Identifies the authorization name that will be used to connect to the application server. It can be a global variable if it is qualified with schema name.

If a *variable* is specified:

- It must be a CHAR or VARCHAR host variable.
- It must not be followed by an indicator variable. The authorization name must be left-justified within the variable and must conform to the rules of forming an authorization name.
- If the length of the authorization name is less than the length of the variable, it must be padded on the right with blanks.

USING *password or variable*

Identifies the password that will be used to connect to the application server.

If password is specified as a literal, it must be a character string. The maximum length is 128 characters. It must be left justified. The literal form of the password is not allowed in static SQL or REXX.

If a *variable* is specified:

- It cannot be a global variable.
- It must be a CHAR or VARCHAR host variable.
- It must not be followed by an indicator variable.
- The password must be left-justified within the variable.
- If the length of the password is less than that of the variable, it must be padded on the right with blanks.

RESET

CONNECT RESET is equivalent to CONNECT TO x where x is the local server name.

CONNECT with no operand

This form of the CONNECT statement returns information about the current server and has no effect on connection states, open cursors, prepared statements, or locks. The connection information is returned in the connection information items in the SQL Diagnostics Area (or the SQLCA).

In addition, the DB2_CONNECTION_STATUS connection information item in the SQL Diagnostics Area (or the SQLERRD(3) field of the SQLCA) will indicate the status of connection for this unit of work. It will have one of the following values:

- 1 - Committable updates can be performed on the connection for this unit of work.
- 2 - No committable updates can be performed on the connection for this unit of work.

Notes

Successful connection: If the CONNECT statement is successful:

- A connection to application server S is created and placed in the current and held states. The previous connection, if any, is placed in the dormant state.
- S is placed in the CURRENT SERVER special register.
- Information about the application server is placed in the *connection-information-items* in the SQL Diagnostics Area.
- Information about application server S is also placed in the SQLERRP and SQLERRD(4) fields of the SQLCA. If the application server is an IBM relational database product, the information in the SQLERRP field has the form *pppvrrm*, where:
 - *ppp* identifies the product as follows:
 - ARI for Db2 for VM and VSE
 - DSN for Db2 for z/OS
 - QSQ for Db2 for i
 - SQL for all other Db2 products
 - *vv* is a two-digit version identifier such as '09'
 - *rr* is a two-digit release identifier such as '01'
 - *m* is a one-character modification level such as '0'

For example, if the application server is Version 9 of Db2 for z/OS, the value of SQLERRP is 'DSN09010'.

The SQLERRD(4) field of the SQLCA contains values indicating whether application server S allows committable updates to be performed. Following is a list of values and their meanings for the SQLERRD(4) field of the SQLCA on the CONNECT:

- 1 - committable updates can be performed. Conversation is unprotected. ⁸⁸
 - 2 - No committable updates can be performed. Conversation is unprotected.
 - 3 - It is unknown if committable updates can be performed. Conversation is protected.
 - 4 - It is unknown if committable updates can be performed. Conversation is unprotected.
 - 5 - It is unknown if committable updates can be performed. The connection is either a local connection or a connection to an application requester driver program.
- Additional information about the connection is placed in the SQLERRMC field of the SQLCA. Refer to [Appendix C, “SQLCA \(SQL communication area\),” on page 1657.](#)

Unsuccessful connection: If the CONNECT statement is unsuccessful, the connection state of the activation group and the states of its connections are unchanged.

Implicit connect: Implicit connect will always send the *authorization-name* of the application requester job and will not send passwords. If the *authorization-name* of the application server job is different or if a password must be sent, an explicit connect statement must be used.

When TCP/IP is used for connecting to an RDB, an implicit connect is not bound by the above restrictions. Use of the ADDSVRAUTE and other -SVRAUTE commands allows one to specify, for a given user under which the implicit (or explicit) CONNECT is done, the remote authorization-name and password to be used in connecting to a given RDB.

In order for the password to be stored with the ADDSVRAUTE or CHGSVRAUTE command, the QRETSVRSEC system value must be set to '1' rather than the default of '0'. When using these commands for DRDA connection, it is very important to realize that the value of the RDB name entered into the SERVER parameter must be in UPPER CASE. For more information, see Example 2 under Type 2 CONNECT.

For more information about implicit connect, refer to [SQL Programming](#). Once a connection to a relational database for a user profile is established, the password, if specified, may not be validated again on subsequent connections to the same relational database with the same user profile. Revalidation of the password depends on if the conversation is still active. See [Distributed Database Programming](#) for more details.

SET SESSION AUTHORIZATION: If a SET SESSION AUTHORIZATION statement has been executed in the thread, a CONNECT to the local server will fail unless prior to the connect statement, the SYSTEM_USER value is the same as SESSION_USER.

This includes an implicit connect due to invoking a program that specifies ACTGRP(*NEW).

Examples

Example 1: Execute SQL statements at TOROLAB and SVLLAB. The first CONNECT statement creates the TOROLAB connection and the second CONNECT statement places it in the dormant state.

```
EXEC SQL CONNECT TO TOROLAB;  
      (execute statements referencing objects at TOROLAB)  
EXEC SQL CONNECT TO SVLLAB;  
      (execute statements referencing objects at SVLLAB)
```

Example 2: Connect to a remote server specifying a userid and password, perform work for the user and then connect as another user to perform further work.

```
EXEC SQL CONNECT TO SVLLAB USER :AUTHID USING :PASSWORD;  
      (execute SQL statements accessing data on the server)  
EXEC SQL COMMIT;  
      (set AUTHID and PASSWORD to new values)  
EXEC SQL CONNECT TO SVLLAB USER :AUTHID USING :PASSWORD;  
      (execute SQL statements accessing data on the server)
```

Example 3: User JOE wants to connect to TOROLAB3 and execute SQL statements under the user ID ANONYMOUS which has a password of SHIBBOLETH. The RDB directory entry for TOROLAB3 specifies *IP for the connection type.

Before running the application, some setup must be done.

This command will be required to allow server security information to be retained in the IBM i operating system, if it has not been previously run:

```
CHGSYSVAL SYSVAL(QRETSVRSEC) VALUE('1')
```

This command adds the required server authorization entry:

```
ADDSVRAUTE USRPRF(JOE) SERVER(TOROLAB3) USRID(ANONYMOUS) +  
          PASSWORD(SHIBBOLETH)
```

This statement, run under JOE's user profile, will now make the wanted connection:

```
EXEC SQL CONNECT TO TOROLAB3;  
      (execute statements referencing objects at TOROLAB3)
```

CREATE ALIAS

The CREATE ALIAS statement defines an alias on a table, partition of a table, view, or member of a database file at the current or remote server.

Invocation

This statement can be embedded in an application program or issued interactively. It is an executable statement that can be dynamically prepared.

Authorization

The privileges held by the authorization ID of the statement must include at least one of the following:

- The privilege to create in the schema. For more information, see [Privileges necessary to create in a schema](#).
- Database administrator authority

The privileges held by the authorization ID of the statement must include at least one of the following:

- The following system authorities:
 - *USE to the Create DDM File (CRTDDMF) command
- Database administrator authority

If SQL names are specified and a user profile exists that has the same name as the library into which the alias is created, and that name is different from the authorization ID of the statement, then the privileges held by the authorization ID of the statement must include at least one of the following:

- The system authority *ADD to the user profile with that name
- Database administrator authority

To replace an existing alias, the privileges held by the authorization ID of the statement must include at least one of the following:

- The following system authorities:
 - The system authority of *OBJMGT on the alias
 - All authorities needed to DROP the alias
- Database administrator authority

Syntax

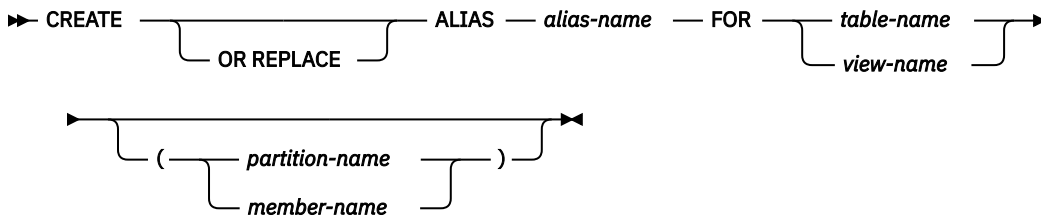

Description

OR REPLACE

Specifies to replace the definition for the alias if one exists at the current server. The existing definition is effectively dropped before the new definition is replaced in the catalog with the exception that privileges that were granted on the alias are not affected. This option is ignored if a definition for the alias does not exist at the current server.

alias-name

Names the alias. The name, including the implicit or explicit qualifier, must not be the same as an index, table, view, alias or file that already exists at the current server.

If the *alias-name* is qualified, the name can be a two-part or three-part name. The schema name should not be a system schema. If a three-part name is used, the first part must identify a relational database name in the relational database directory.

For more information about connecting to a remote relational database and the local directory, see [SQL Programming](#) and the [Distributed Database Programming](#).

If SQL names were specified, the alias will be created in the schema specified by the implicit or explicit qualifier.

If system names were specified, the alias will be created in the schema that is specified by the qualifier. If not qualified, the alias will be created in the same schema as the table or view for which the alias was created. If the table is not qualified and does not exist at the time the alias is created:

- If the value of the CURRENT SCHEMA special register is *LIBL, the alias will be created in the current library (*CURLIB).
- Otherwise, the alias will be created in the current schema.

If the alias name is not a valid system name, Db2 for i will generate a system name. For information about the rules for generating a name, see [“Rules for Table Name Generation”](#) on page 1157.

FOR table-name or view-name

Identifies the table or view at the current or remote server for which the alias is to be defined. An alias name cannot be specified (an alias cannot refer to another alias), unless the name refers to an alias on a remote server.

The *table-name* or *view-name* need not identify a table or view that exists at the time the alias is created. If the table or view does not exist when the alias is created, a warning is returned. If the table or view does not exist when the alias is used, an error is returned.

If SQL names were specified and the *table-name* or *view-name* was not qualified, then the qualifier is the implicit qualifier. For more information, see [“Naming conventions”](#) on page 48.

If system names were specified and the *table-name* or *view-name* is not qualified and does not exist when the alias is created, the *table-name* or *view-name* is qualified by the library in which the alias is created.

partition-name

Identifies a partition of a partitioned table.

If a partition is specified, the alias cannot be used in SQL schema statements. If a partition is not specified, all partitions in the table are included in the alias.

If a partition name is specified, a three-part name should not be specified in the FOR clause. If a three-part name is specified and identifies a different relational database than the relational database of the alias, any attempt to use the alias will fail.

member-name

Identifies a member of a database file. If a member name is not specified and the table is not a partitioned table, *FIRST is used. If a member name is not specified and the table is a partitioned table, all members (partitions) are used.

If a member is specified, the alias cannot be used in most SQL schema statements. It can be used in CREATE PROCEDURE, CREATE FUNCTION and in a CREATE TABLE with an *as-result-table* clause.

If a member name is specified, a three-part name should not be specified in the FOR clause. If a three-part name is specified and identifies a different relational database than the relational database of the alias, any attempt to use the alias will fail.

Notes

Alias references: An alias can be defined to reference either the system name or SQL name. Since system names are generated during create processing, it is generally recommended that the SQL name be specified.

However, if the alias specifies a reference to a three-part name and the alias will be used as a DDM file in native commands or native access, the name specified must be the system name.

The Override Database File (OVRDBF) CL command also allows the database manager to process individual members of a database file. Creating an alias over a partition of a table or member of a database file, however, is easier and performs better by eliminating the need to perform the override.

Alias attributes: An alias is created as a special form of a DDM file. Both an alias and a normal DDM file can be used in SQL, but if the alias or DDM file specifies a non-local relational database name, the specified *table-name* or *view-name* must be the same as the name of the alias.

An alias created over a distributed table is only created on the current server. For more information about distributed tables, see [DB2 Multisystem](#).

Alias ownership: If SQL names were specified:

- If a user profile with the same name as the schema into which the alias is created exists, the *owner* of the alias is that user profile.
- Otherwise, the *owner* of the alias is the user profile or group user profile of the thread executing the statement.

If system names were specified, the *owner* of the alias is the user profile or group user profile of the thread executing the statement.

Alias authority: If SQL names are used, aliases are created with the system authority of *EXCLUDE on *PUBLIC. If system names are used, aliases are created with the authority to *PUBLIC as determined by the create authority (CRTAUT) parameter of the schema.

If the owner of the alias is a member of a group profile (GRPPRF keyword) and group authority is specified (GRPAUT keyword), that group profile will also have authority to the alias.

REPLACE rules: When an alias is recreated by REPLACE:

- Any existing comment or label is discarded.
- Authorized users are maintained. The object owner could change.
- Current journal auditing is preserved.

Packages and three-part aliases: When an application uses three-part name aliases for remote objects and DRDA access, a package for the application program must exist at each location that is specified in the three-part names. A package can be explicitly created using the CRTSQLPKG CL command. If the three-part name alias is referenced and a package does not exist, the database manager will attempt to implicitly create the package.

Syntax alternatives: The following keywords are synonyms supported for compatibility to prior releases. These keywords are non-standard and should not be used:

- The keyword SYNONYM can be used as a synonym for ALIAS.

Examples

Example 1: Create an alias named CURRENT_PROJECTS for the PROJECT table.

```
CREATE ALIAS CURRENT_PROJECTS
FOR PROJECT
```

Example 2: Create an alias named SALES_JANUARY on the JANUARY partition of the SALES table. The sales table has 12 partitions (one for each month of the year).

```
CREATE ALIAS SALES_JANUARY  
FOR SALES(JANUARY)
```

Example 3: Create an alias named REPORTS.SALES for the SALES table in schema REPORTS on relational database USARDB.

```
CREATE ALIAS REPORTS.SALES  
FOR USARDB.REPORTS.SALES
```

CREATE FUNCTION

The CREATE FUNCTION statement defines a user-defined function at the current server.

The following types of functions can be defined:

- **External Scalar**

The function is written in a programming language such as C or Java and returns a scalar value. The external program is referenced by a function defined at the current server along with various attributes of the function. See [“CREATE FUNCTION \(external scalar\)”](#) on page 970.

- **External Table**

The function is written in a programming language such as C or Java and returns a set of rows. The external program is referenced by a function defined at the current server along with various attributes of the function. See [“CREATE FUNCTION \(external table\)”](#) on page 990.

- **Sourced**

The function is implemented by invoking another function (built-in, external, sourced, or SQL) that already exists at the current server. A sourced function can return a scalar result, or the result of an aggregate function. See [“CREATE FUNCTION \(sourced\)”](#) on page 1008. The function inherits attributes of the underlying source function.

- **SQL Scalar**

The function is written exclusively in SQL and returns a scalar value. The body of an SQL function is written in the SQL procedural language, SQL PL. The function body is defined at the current server along with various attributes of the function. See [“CREATE FUNCTION \(SQL scalar\)”](#) on page 1018.

- **SQL Table**

The function is written exclusively in SQL and returns a set of rows. The body of an SQL function is written in the SQL procedural language, SQL PL. The function body is defined at the current server along with various attributes of the function. See [“CREATE FUNCTION \(SQL table\)”](#) on page 1032.

Notes

Choosing the schema and function name: If a qualified function name is specified, the *schema-name* cannot be one of the system schemas (see “Schemas” on page 4). If *function-name* is not qualified, it is implicitly qualified with the default schema name.

The unqualified function name must not be one of the following names reserved for system use even if they are specified as delimited identifiers:

=	<	>	>=
<=	<>	¬=	¬<
¬<	!=	!<	!>
ALL	FALSE	POSITION	XMLAGG
AND	FOR	RID	XMLATTRIBUTES
ANY	FROM	RRN	XMLCOMMENT
ARRAY_AGG	HASHED_VALUE	SELECT	XMLCONCAT
BETWEEN	IN	SIMILAR	XMLDOCUMENT
BOOLEAN	IS	SOME	XMLELEMENT
CASE	LIKE	STRIP	XMLFOREST
CAST	MATCH	SUBSTRING	XMLGROUP
CHECK	NODENAME	TABLE	XMLNAMESPACES
DATAPARTITIONNAME	NODENUMBER	THEN	XMLPARSE
DATAPARTITIONNUM	NOT	TRIM	XMLPI
DBPARTITIONNAME	NULL	TRUE	XMLROW
DBPARTITIONNUM	ONLY	TYPE	XMLSERIALIZE
DISTINCT	OR	UNIQUE	XMLTEXT
EXCEPT	OVERLAPS	UNKNOWN	XMLVALIDATE
EXISTS	PARTITION	WHEN	XSLTRANSFORM
EXTRACT			

Defining the parameters: The input parameters for the function are specified as a list within parenthesis.

The maximum number of parameters allowed in CREATE FUNCTION is 2000.

A function can have no input parameters. In this case, an empty set of parenthesis must be specified, for example:

```
CREATE FUNCTION WOOFER()
```

The data type of the result of the function is specified in the RETURNS clause for the function.

- **Choosing data types for parameters:** When choosing the data types of the input and result parameters for a function, the rules of promotion that can affect the values of the parameters need to be considered. See “Promotion of data types” on page 85. For example, a constant that is one of the input arguments to the function might have a built-in data type that is different from the data type that the function expects, and more significantly, might not be promotable to that expected data type. Based on the rules of promotion, using the following data types is recommended:

- INTEGER instead of SMALLINT
- DOUBLE instead of REAL

- VARCHAR instead of CHAR
- VARGRAPHIC instead of GRAPHIC

For portability of functions across platforms that are not Db2 for i, do not use the following data type names, which might have different representations on different platforms:

- FLOAT. Use DOUBLE or REAL instead.
- NUMERIC. Use DECIMAL instead.
- **Specifying AS LOCATOR for a parameter:** Passing a locator instead of a value can result in fewer bytes being passed in or out of the function. This can be useful when the value of the parameter is very large. The AS LOCATOR clause specifies that a locator to the value of the parameter is passed instead of the actual value. Specify AS LOCATOR only for parameters that have a LOB or XML data type or a distinct type based on a LOB or XML data type and only when LANGUAGE JAVA is not in effect.

The AS LOCATOR clause has no effect on determining whether data types can be promoted, nor does it affect the function signature, which is used in function resolution.

AS LOCATOR cannot be specified for SQL functions.

Determining the uniqueness of functions in a schema: The same name can be used for more than one function in a schema if the function signature of each function is unique. The function signature is the qualified function name combined with the number and data types of the input parameters. The combination of name, schema name, the number of parameters, and the data type each parameter (without regard for other attributes such as length, precision, scale, or CCSID) must not identify a user-defined function that exists at the current server. The return type has no impact on the determining uniqueness of a function. Two different schemas can each contain a function with the same name that have the same data types for all of their corresponding data types. However, a schema must not contain two functions with the same name that have the same data types for all of their corresponding data types.

When determining whether corresponding data types match, the database manager does not consider any length, precision, or scale attributes in the comparison. The database manager considers the synonyms of data types a match. For example, REAL and FLOAT, and DOUBLE and FLOAT are considered a match. Therefore, CHAR(8) and CHAR(35) are considered to be the same, as are DECIMAL(11,2), and DECIMAL(4,3). Furthermore, the character and graphic types are considered to be the same. For example, the following are considered to be the same type: CHAR and GRAPHIC, VARCHAR and VARGRAPHIC, and CLOB and DBCLOB. CHAR(13) and GRAPHIC(8) are considered to be the same type. A weakly typed distinct type specified for a parameter is considered to be the same data type as the source type of the distinct type. An error is returned if the signature of the function being created is a duplicate of a signature for an existing user-defined function with the same name and schema.

Assume that the following statements are executed to create four functions in the same schema. The second and fourth statements fail because they create functions that are duplicates of the functions that the first and third statements created.

```
CREATE FUNCTION PART (INT, CHAR(15)) ...
CREATE FUNCTION PART (INTEGER, CHAR(40)) ...

CREATE FUNCTION ANGLE (DECIMAL(12,2)) ...
CREATE FUNCTION ANGLE (DEC(10,7)) ...
```

Specifying a specific name for a function: When defining multiple functions with the same name and schema (with different parameter lists), it is recommended that a specific name also be specified. The specific name can be used to uniquely identify the function such as when sourcing on this function, dropping the function, or commenting on the function. However, the function cannot be invoked by its specific name.

The specific name is implicitly or explicitly qualified with a schema name. If a schema name is not specified on CREATE FUNCTION, it is the same as the explicit or implicit schema name of the function name (*function-name*). If a schema name is specified, it must be the same as the explicit or implicit

schema name of the function name. The name, including the schema name must not identify the specific name of another function or procedure that exists at the current server.

If a specific name is not specified, it is set to the function name. If a function or procedure with that specific name already exists, a unique name is generated similar to the rules used to generate unique table names.

Extending or overriding a built-in function:

Giving a user-defined function the same name as a built-in function is not a recommended practice unless the functionality of the built-in function needs to be extended or overridden.

- **Extending the functionality of existing built-in functions:**

Create the new user-defined function with the same name as the built-in function, and a unique function signature. For example, a user-defined function similar to the built-in function ROUND that accepts the strongly typed distinct type MONEY as input rather than the built-in numeric types might be necessary. In this case, the signature for the new user-defined function named ROUND is different from all the function signatures supported by the built-in ROUND function.

- **Overriding a built-in function:**

Create the new user-defined function with the same name and signature as an existing built-in function. The new function has the same name and data type as the corresponding parameters of the built-in function but implements different logic. For example, a user-defined function similar to the built-in function ROUND that uses different rules for rounding than the built-in ROUND function might be necessary. In this case, the signature for the new user-defined function named ROUND will be the same as a signature that is supported by the built-in ROUND function.

Once a built-in function has been overridden, if the schema for the new function appears in the SQL path before the system schemas, the database manager may choose a user-defined function rather than the built-in function. An application that uses the unqualified function name and was previously successful using the built-in function of that name might fail, or perhaps even worse, appear to run successfully but provide a different result if the user-defined function is chosen by the database manager rather than the built-in function.

The DISTINCT keyword can be passed on the invocation of a user-defined function that is sourced on one of the built-in aggregate functions. For example, assume that MY_AVG is a user-defined function that is sourced on the built-in AVG function. The user-defined function could be invoked with MY_AVG (DISTINCT *expression*). This results in the underlying built-in AVG function being invoked with the DISTINCT keyword.

Special registers in functions: The settings of the special registers of the invoker are inherited by the function on invocation and restored upon return to the invoker. Special registers may be changed in a function that can execute SQL statements, but these changes do not affect the caller.

Creating a secure function: Db2 treats the SECURED attribute as an assertion that declares that the user has established an audit procedure for all changes to the user-defined function. Db2 assume that such an audit control procedure is in place for all subsequent ALTER FUNCTION statements.

Invoking other user-defined functions in a secure function: When a secure user-defined function is referenced in an SQL statement that references a table that is using row access control or column access control, and if the secure user-defined function invokes other user-defined functions, the nested user-defined functions are not validated as secure. If those nested functions can access sensitive data, a user authorized who has security administrator authority i needs to ensure that those functions are allowed to access that data and should ensure that a change control audit procedure has been established for all changes to those functions.

MODIFIES SQL DATA and EXTERNAL ACTION functions: If a MODIFIES SQL DATA or EXTERNAL ACTION function is invoked in other than the outermost select list, the results are unpredictable since the number of times the function is invoked will vary depending on the access plan used.

Functions and adopted authority: Fenced functions run in separate threads. If ALLOW PARALLEL is specified for a NOT FENCED function, that function may also run in a separate thread. Functions that run

in separate threads will not run under any adopted authority that might be specified by the invoking application.

Restore considerations: When a function's associated program or service program is saved and subsequently restored and the object was updated with the function attributes when the function was created, the saved attributes will be processed and possibly changed during the restore.

If the 'Saved library' (SAVLIB) of the program or service program is different from the 'Restore to library' (RSTLIB), the function's schema name, specific schema name, and the external name may be changed as a result of the restore.

- If the saved function schema name and the library name of the saved object match, the function schema will be changed to the 'Restore to library' (RSTLIB). Otherwise, the function schema name is the saved function schema name.
- The specific schema name is always the same as function schema name.
- If the saved EXTERNAL NAME library and the library name of the saved object match, the EXTERNAL NAME library will be changed to the 'Restore to library' (RSTLIB). Otherwise, the EXTERNAL NAME library is the saved library name. If the saved EXTERNAL NAME library is *LIBL, it will not change.

If the same function signature already exists in the catalog:

- If the external program name or service program name is the same as the one that already exists in the catalog, the information in the catalog for that procedure will be replaced with the saved attributes (including the specific name).
- Otherwise, the saved attributes are not restored, and a warning (SQL9015) is issued.

If the same specific name already exists in the catalog, a warning is issued and a new specific name is generated. Otherwise, the specific name of the function is preserved.

CREATE FUNCTION (external scalar)

This CREATE FUNCTION (external scalar) statement defines an external scalar function at the current server. A user-defined external scalar function returns a single value each time it is invoked.

Invocation

This statement can be embedded in an application program, or issued interactively. It is an executable statement that can be dynamically prepared.

Authorization

The privileges held by the authorization id of the statement must include at least one of the following:

- For the SYSFUNCS catalog view and SYSPARMS catalog table⁸⁹:
 - The INSERT privilege on the table, and
 - The USAGE privilege on schema QSYS2
- Database administrator authority

If the external program or service program exists, the privileges held by the authorization ID of the statement must include at least one of the following:

- For the external program or service program that is referenced in the SQL statement:
 - The USAGE privilege on the schema that contains the external program or service program.
 - The system authority *EXECUTE on the external program or service program, and
 - The system authority *CHANGE on the program or service program. The system needs this authority to update the program object to contain the information necessary to save/restore the function to another system. If user does not have this authority, the function is still created, but the program object is not updated.
- Database administrator authority

If SQL names are specified and a user profile exists that has the same name as the library into which the function is created, and that name is different from the authorization ID of the statement, then the privileges held by the authorization ID of the statement must include at least one of the following:

- The system authority *ADD to the user profile with that name
- Database administrator authority

If a distinct type is referenced, the privileges held by the authorization ID of the statement must include at least one of the following:

- For each distinct type identified in the statement:
 - The USAGE privilege on the distinct type, and
 - The USAGE privilege on the schema containing the distinct type
- Database administrator authority

To replace an existing function, the privileges held by the authorization ID of the statement must include at least one of the following:

- The following system authorities:
 - The system authority of *OBJMGT on the service program object associated with the function
 - All authorities needed to DROP the function
 - The system authority *READ to the SYSFUNCS catalog view and SYSPARMS catalog table

⁸⁹ The GRTOBJAUT CL command must be used to grant these privileges.

- Database administrator authority

For information about the system authorities corresponding to SQL privileges, see [Corresponding System Authorities When Checking Privileges to a Table or View](#) and [Corresponding System Authorities When Checking Privileges to a Distinct Type](#).

Syntax

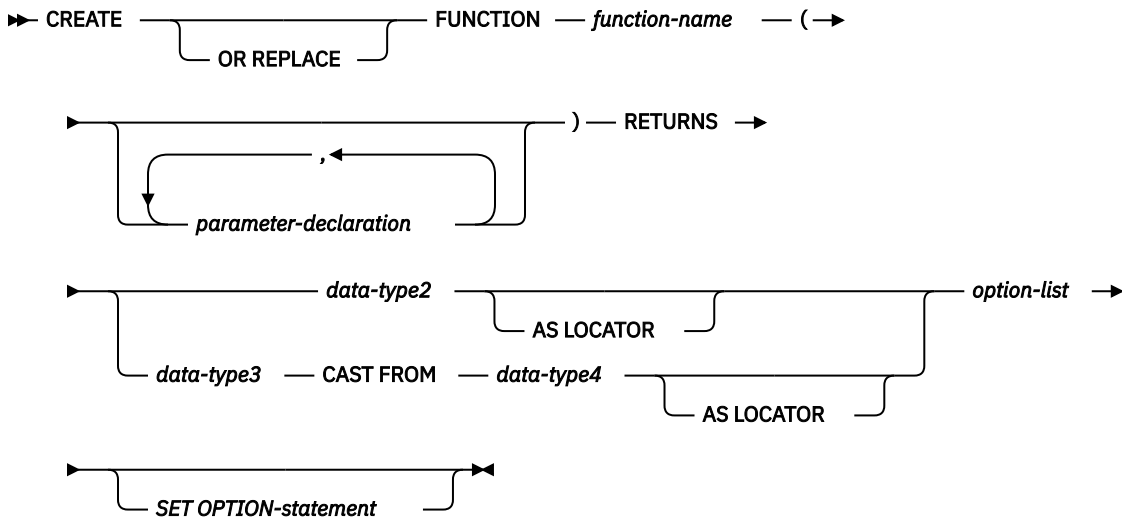

parameter-declaration

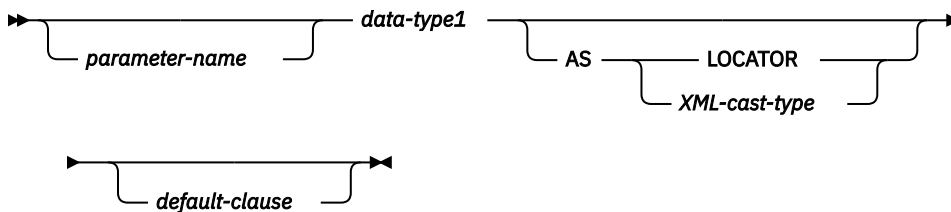

data-type1, data-type2, data-type3, data-type4

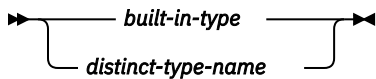

XML-cast-type

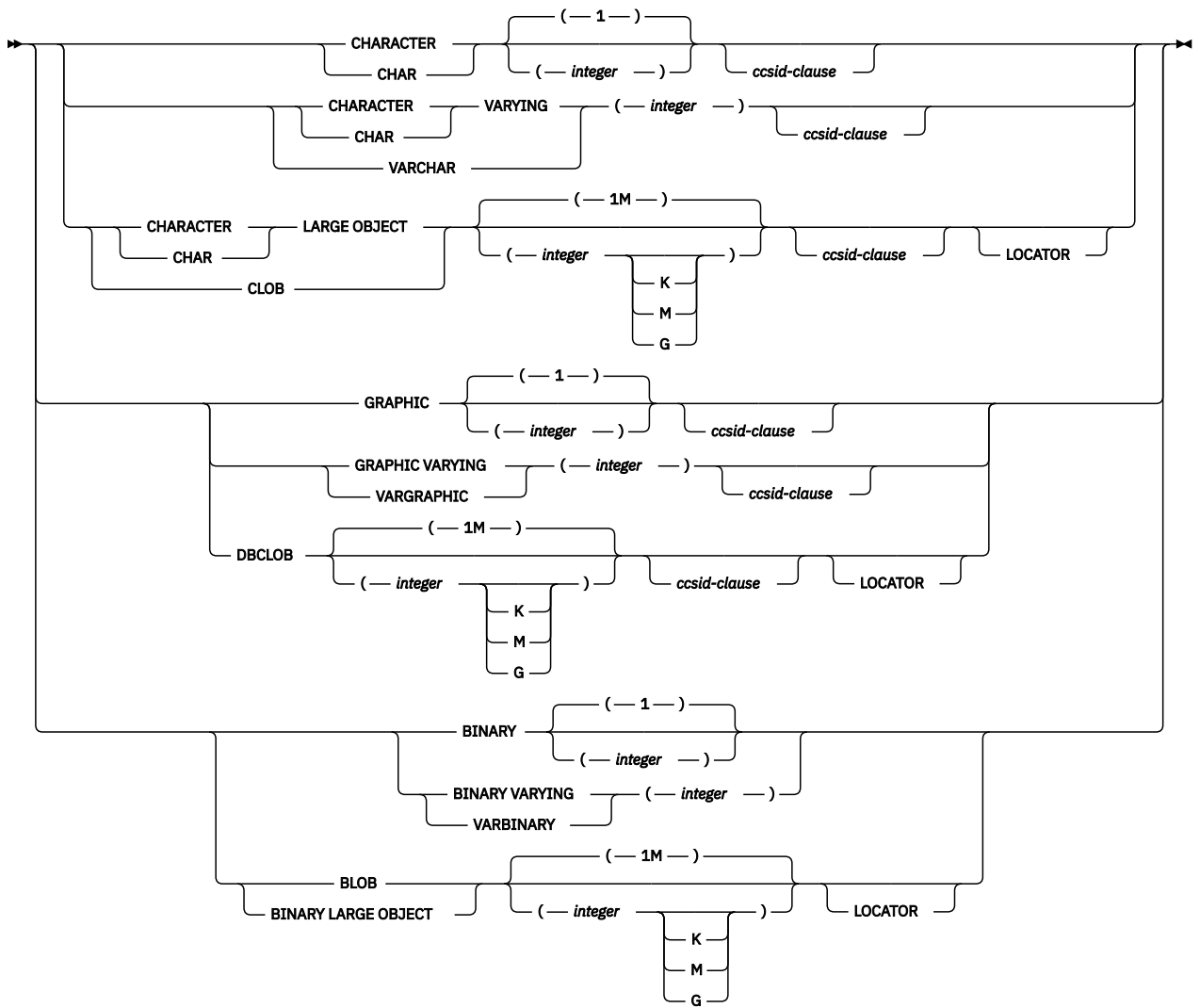

built-in-type

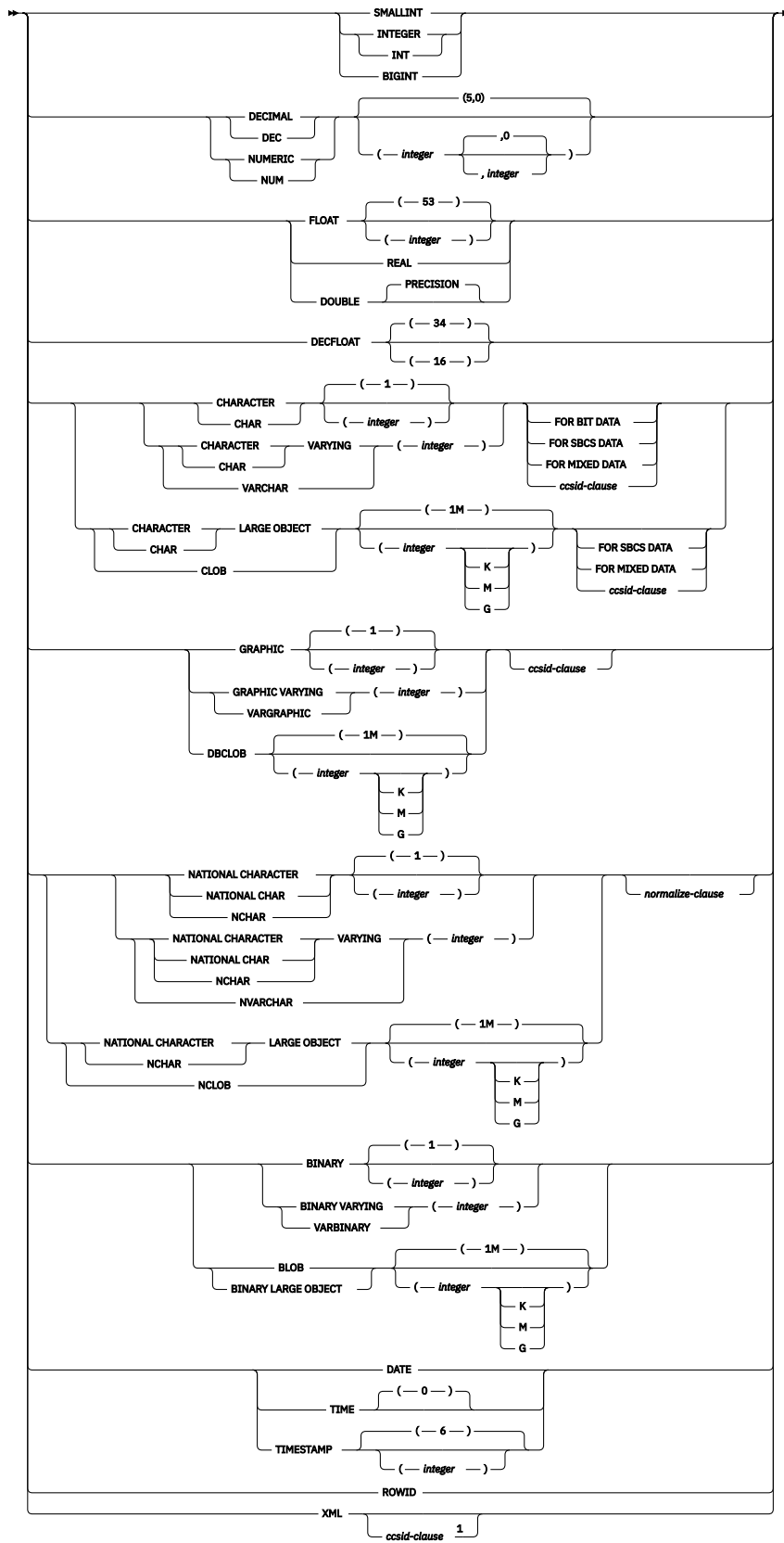

Notes:

¹ The *ccsid-clause* for XML is only allowed for *data-type2* and *data-type3*.

ccsid-clause

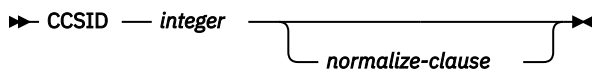

normalize-clause

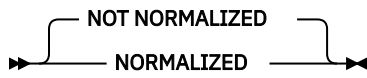

default-clause

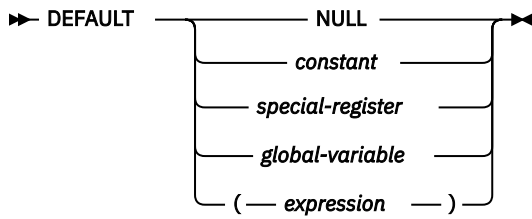

option-list

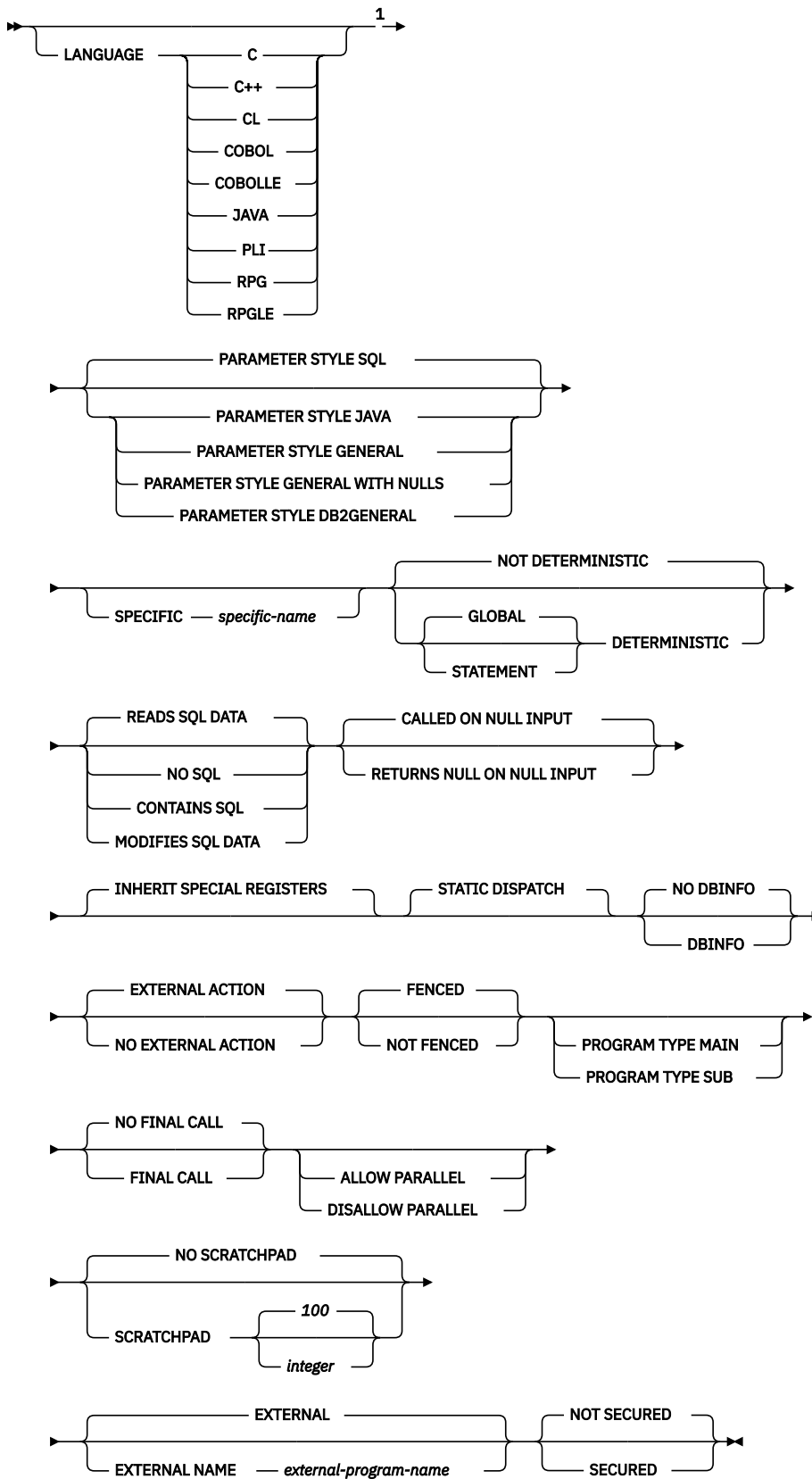

Notes:

¹ This clause and the clauses that follow in the option-list can be specified in any order. Each clause can be specified at most once.

Description

OR REPLACE

Specifies to replace the definition for the function if one exists at the current server. The existing definition is effectively dropped before the new definition is replaced in the catalog with the exception that privileges that were granted on the function are not affected. This option is ignored if a definition for the function does not exist at the current server. To replace an existing function, the *specific-name* and *function-name* of the new definition must be the same as the *specific-name* and *function-name* of the old definition, or the signature of the new definition must match the signature of the old definition. Otherwise, a new function is created.

function-name

Names the user-defined function. The combination of name, schema name, the number of parameters, and the data type of each parameter (without regard for any length, precision, scale, or CCSID attributes of the data type) must not identify a user-defined function that exists at the current server unless OR REPLACE is specified.

For SQL naming, the function will be created in the schema specified by the implicit or explicit qualifier.

For system naming, the function will be created in the schema that is specified by the qualifier. If no qualifier is specified:

- If the value of the CURRENT SCHEMA special register is *LIBL, the function will be created in the current library (*CURLIB).
- Otherwise, the function will be created in the current schema.

In general, more than one function can have the same name if the function signature of each function is unique.

Certain function names are reserved for system use. For more information see [Choosing the schema and function name in “CREATE FUNCTION” on page 965](#).

(parameter-declaration,...)

Specifies the number of input parameters of the function and the data type of each parameter. Each *parameter-declaration* specifies an input parameter for the function.

The maximum number of parameters depends on the type of language:

- For JAVA and ILE programs and service programs, the maximum is 2000.
- For OPM programs, the maximum is 90.

The maximum number of parameters can be further limited by the maximum number of parameters allowed by the language.

A function can have zero or more input parameters. There must be one entry in the list for each parameter that the function expects to receive. All the parameters for a function are input parameters and are nullable. In the case of JAVA, numeric parameters other than the DECIMAL and NUMERIC types are not nullable. A runtime error will occur if a null value is input to such a parameter for a CALLED ON NULL INPUT function. For more information, see [Defining the parameters in “CREATE FUNCTION” on page 965](#).

parameter-name

Names the parameter. Although not required, a parameter name can be specified for each parameter. The name cannot be the same as any other *parameter-name* in the parameter list.

data-type1

Specifies the data type of the input parameter. The data type can be a built-in data type or a distinct type. It cannot be an array type.

built-in-type

Specifies a built-in data type. For a more complete description of each built-in data type, see [“CREATE TABLE” on page 1105](#). Some data types are not supported in all languages. For details on the mapping between the SQL data types and host language data types, see

Embedded SQL Programming topic collection. Built-in data type specifications can be specified if they correspond to the language that is used to write the user-defined function.

distinct-type-name

Specifies a user-defined distinct type. The length, precision, or scale attributes for the parameter are those of the source type of the distinct type (those specified on CREATE TYPE). For more information on creating a distinct type, see [“CREATE TYPE \(distinct\)”](#) on page 1184.

If the name of the distinct type is unqualified, the database manager resolves the schema name by searching the schemas in the SQL path.

If a CCSID is specified, the parameter will be converted to that CCSID prior to passing it to the function. If a CCSID is not specified, the CCSID is determined by the default CCSID at the current server at the time the function is invoked.

Date, time, and timestamp parameters are passed to the procedure as character strings in ISO format.

Any parameter that has an XML type must specify either the *XML-cast-type* clause or the AS LOCATOR clause.

AS LOCATOR

Specifies that a locator to the value of the parameter is passed to the function instead of the actual value. Specify AS LOCATOR only for parameters with a LOB or XML data type or a distinct type based on a LOB or XML data type. If AS LOCATOR is specified, FOR SBCS DATA or FOR MIXED DATA must not be specified.

For more information on the AS LOCATOR clause, see [Specifying AS LOCATOR for a parameter in “CREATE FUNCTION”](#) on page 965.

AS XML-cast-type

Specifies the data type passed to the function for a parameter that is XML type or a distinct type based on XML type. If LOCATOR is specified, the parameter is a locator to the value rather than the actual value.

If a CCSID value is specified, only Unicode CCSID values can be specified for graphic data types. If a CCSID value is not specified, the CCSID is established at the time the function is created according to the SQL_XML_DATA_CCSD QAQQINI option setting. The default CCSID is 1208. See [“XML Values”](#) on page 80 for a description of this option.

default-clause

Specifies a default value for the parameter. The default can be a constant, a special register, a global variable, an expression, or the keyword NULL. The expression is any expression defined in [“Expressions”](#) on page 159, that does not include an aggregate function or column name. If a default value is not specified, the parameter has no default and cannot be omitted on invocation. The maximum length of the expression string is 64K.

The default expression must be assignment compatible to the parameter data type.

Any comma in the default expression that is intended as a separator of numeric constants in a list must be followed by a space.

All objects referenced in a default expression must exist when the function is created. When the function is invoked, the default will be evaluated using the authority of the invoker.

A default cannot be specified for a parameter of type array.

RETURNS

Specifies the data type for the result of the function. Consider this clause in conjunction with the optional CAST FROM clause.

data-type2

Specifies the data type and attributes of the output.

You can specify any built-in data type (except LONG VARCHAR, LONG VARGRAPHIC, or DataLink) or a distinct type (that is not based on a DataLink). You cannot specify an array type.

If a CCSID is specified,

- If AS LOCATOR is not specified, the result returned is assumed to be encoded in that CCSID.
- If AS LOCATOR is specified and the CCSID of the data the locator points to is encoded in a different CCSID, the data is converted to the specified CCSID.

If a CCSID is not specified and the function is not referenced in the outermost select list of a view,

- If AS LOCATOR is not specified, the result returned is assumed to be encoded in the CCSID of the job (or associated graphic CCSID of the job for graphic string return values).
- If AS LOCATOR is specified, the data the locator points to is converted to the CCSID of the job, if the CCSID of the data the locator points to is encoded in a different CCSID. To avoid any potential loss of characters during the conversion, consider explicitly specifying a CCSID that can represent any characters that will be returned from the function. This is especially important if the data type is graphic string data. In this case, consider using CCSID 1200 or 13488 (Unicode graphic string data).

If a CCSID is not specified and the function is referenced in the outermost select list of a view,

- If AS LOCATOR is not specified, the result returned is assumed to be encoded in the CCSID of the associated view column.
- If AS LOCATOR is specified, the data the locator points to is converted to the CCSID of the associated view column, if the CCSID of the data the locator points to is encoded in a different CCSID. To avoid any potential loss of characters during the conversion, consider explicitly specifying a CCSID that can represent any characters that will be returned from the function. This is especially important if the data type is graphic string data. In this case, consider using CCSID 1200 or 13488 (Unicode graphic string data).

AS LOCATOR

Specifies that the function returns a locator to the value rather than the actual value. Specify AS LOCATOR only if the result of the function has a LOB or XML data type or a distinct type based on a LOB or XML data type. If AS LOCATOR is specified, FOR SBCS DATA or FOR MIXED DATA must not be specified.

For more information on the AS LOCATOR clause, see [Specifying AS LOCATOR for a parameter in “CREATE FUNCTION” on page 965](#).

data-type3* CAST FROM *data-type4

Specifies the data type and attributes of the function (*data-type4*) and the data type in which that result is returned to the invoking statement (*data-type3*). The two data types can be different. For example, for the following definition, the function returns a DOUBLE value, which the database manager converts to a DECIMAL value and then passes to the statement that invoked the function:

```
CREATE FUNCTION SQRT (DECIMAL15,0)  
RETURNS DECIMAL(15,0)  
CAST FROM DOUBLE  
...
```

The value of *data-type4* must not be XML or a distinct type and must be castable to *data-type3*. The value for *data-type3* can be any built-in data type or distinct type. (For information on casting data types, see [“Casting between data types” on page 87](#)).

For CCSID information, see the preceding description of *data-type2*.

AS LOCATOR

Specifies that the function returns a locator to the value rather than the actual value. Specify AS LOCATOR only if the result of the function has a LOB data type or a distinct type based on a LOB data type. If AS LOCATOR is specified, FOR SBCS DATA or FOR MIXED DATA must not be specified.

For more information on the AS LOCATOR clause, see [Specifying AS LOCATOR for a parameter in “CREATE FUNCTION” on page 965](#).

LANGUAGE

Specifies the language interface convention to which the function body is written. All programs must be designed to run in the server's environment.

If LANGUAGE is not specified, the LANGUAGE is determined from the program attribute information associated with the external program at the time the function is created. The language of the program is assumed to be C if:

- The program attribute information associated with the program does not identify a recognizable language
- The program cannot be found

C

The external program is written in C.

C++

The external program is written in C++.

CL

The external program is written in CL or ILE CL.

COBOL

The external program is written in COBOL.

COBOLLE

The external program is written in ILE COBOL.

JAVA

The external program is written in JAVA. The database manager will call the user-defined function, which must be a public static method of the specified Java class

Do not specify LANGUAGE JAVA when SCRATCHPAD, FINAL CALL, or DBINFO is specified.

PLI

The external program is written in PL/I.

RPG

The external program is written in RPG.

RPGLE

The external program is written in ILE RPG.

PARAMETER STYLE

Specifies the conventions used for passing parameters to and returning the values from functions:

SQL

All applicable parameters are passed. The parameters are defined to be in the following order:

- n parameters for the input parameters that are specified for the function.
- A parameter for the result of the function.
- n parameters for indicator variables for the input parameters.
- A parameter for the indicator variable for the result.
- A CHAR(5) output parameter for SQLSTATE. The SQLSTATE returned indicates the success or failure of the function. The SQLSTATE returned can either be:
 - the SQLSTATE from the last SQL statement executed in the external program,
 - an SQLSTATE that is assigned by the external program.

The user may set the SQLSTATE to any valid value in the external program to return an error or warning from the function.

- A VARCHAR(517) input parameter for the fully qualified function name.
- A VARCHAR(128) input parameter for the specific name.
- A VARCHAR(1000) output parameter for the message text.

When control is returned to the invoking program, the message text can be found in the 6th token of the SQLERRMC field of the SQLCA. Only a portion of the message text is available. For information on the layout of the message data in the SQLERRMC, see the replacement data descriptions for message SQL0443 in message file QSQLMSG. The complete message text can be retrieved using the GET DIAGNOSTICS statement. For more information, see [“GET DIAGNOSTICS”](#) on page 1324.

- Zero to three optional parameters:
 - A structure (consisting of an INTEGER followed by a CHAR(n)) input and output parameter for the scratchpad, if SCRATCHPAD was specified on the CREATE FUNCTION statement.
 - An INTEGER input parameter for the call type, if FINAL CALL was specified on the CREATE FUNCTION statement.
 - A structure for the dbinfo structure, if DBINFO was specified on the CREATE FUNCTION statement.

These parameters are passed according to the specified LANGUAGE. For example, if the language is C or C++, the VARCHAR parameters are passed as NUL-terminated strings. For more information about the parameters passed, see the include sqludf in the appropriate source file in library QSYSINC. For example, for C, sqludf can be found in QSYSINC/H.

DB2GENERAL

This parameter style is used to specify the conventions for passing parameters to and returning the value from external functions that are defined as a method in a Java class. All applicable parameters are passed. The parameters are defined to be in the following order:

- The first N parameters are the input parameters that are specified on the CREATE FUNCTION statement.
- A parameter for the result of the function.

DB2GENERAL is only allowed when the LANGUAGE is JAVA.

GENERAL

All applicable parameters are passed. The parameters are defined to be in the following order:

- The first N parameters are the input parameters that are specified on the CREATE FUNCTION statement.

Note that the result is returned as a value of a C value returning function. For example:

```
return_val func(parameter-1, parameter-2, ...)
```

GENERAL is only allowed when EXTERNAL NAME identifies a service program.

GENERAL WITH NULLS

All applicable parameters are passed. The parameters are defined to be in the following order:

- The first N parameters are the input parameters that are specified on the CREATE FUNCTION statement.
- An additional argument is passed for an indicator variable array.
- A parameter for the indicator variable for the result.

Note that the result is returned as a value of a C value returning function. For example:

```
return_val func(parameter-1, parameter-2, ...)
```

GENERAL WITH NULLS is only allowed when EXTERNAL NAME identifies a service program.

JAVA

Specifies that the function will use a parameter passing convention that conforms to the Java language and ISO/IEC FCD 9075-13:2003, *Information technology - Database languages - SQL - Part 13: Java Routines and Types (SQL/JRT)* specification. All applicable parameters are passed. The parameters are defined to be in the following order:

- The first N parameters are the input parameters that are specified on the CREATE FUNCTION statement.

Note that the result is returned as a value of a C value returning function. For example:

```
return_val func(parameter-1, parameter-2, ...)
```

JAVA is only allowed when the LANGUAGE is JAVA.

Note that the language of the external function determines how the parameters are passed. For example, in C, any VARCHAR or CHAR parameters are passed as NUL-terminated strings. For more information, see the [SQL Programming](#) topic collection. For Java routines, see the [IBM Developer Kit for Java](#) topic collection.

SPECIFIC *specific-name*

Specifies a unique name for the function. For more information on specific names, see [Specifying a specific name for a function in “CREATE FUNCTION” on page 965](#).

GLOBAL DETERMINISTIC or STATEMENT DETERMINISTIC or NOT DETERMINISTIC

Specifies whether the function returns the same results each time that the function is invoked with the same input arguments. The default is NOT DETERMINISTIC.

NOT DETERMINISTIC

Specifies that the function might not return the same result each time that the function is invoked with the same input arguments. The function depends on some state values that affect the results. The database manager uses this information during optimization of SQL statements. An example of a function that is not deterministic is one that generates random numbers.

A function that is not deterministic might return incorrect results if the function is executed by parallel tasks. Specify the DISALLOW PARALLEL clause for these functions.

NOT DETERMINISTIC should be specified if the function contains a reference to a special register, a non-deterministic function, or a sequence.

GLOBAL DETERMINISTIC

Specifies that the function always returns the same result each time that the function is invoked with the same input arguments. The database manager uses this information during optimization of SQL statements. The query optimizer may choose to cache global deterministic scalar function results.⁹⁰ An example of a global deterministic function is a function that calculates the square root of the input argument.

STATEMENT DETERMINISTIC

Specifies that the function might not return the same result each time that the function is invoked with the same input arguments, but multiple invocations of the function within a single SQL statement are considered deterministic. The query optimizer will not cache statement deterministic scalar function results.⁹¹ An example of a statement deterministic function is a function that performs currency conversion.

CONTAINS SQL, READS SQL DATA, MODIFIES SQL DATA, or NO SQL

Specifies the classification of SQL statements and nested routines that the function can execute. The database manager verifies that the SQL statements issued by the function, and all routines locally invoked by the function, are consistent with this specification. The verification is not performed when nested remote routines are invoked. For the classification of each statement, see [Appendix B, “Characteristics of SQL statements,” on page 1643](#). The default is READS SQL DATA. This option is ignored for parameter default expressions.

⁹⁰ If the result of the function contains sensitive data, consider using STATEMENT DETERMINISTIC or the DETERMINISTIC_UDF_SCOPE QAQQINI option or create the function NOT DETERMINISTIC to prevent inadvertent access to the result. For more information, see the [Database Performance and Query Optimization](#) topic collection.

⁹¹ The DETERMINISTIC_UDF_SCOPE QAQQINI option can be used to get this same behavior for a GLOBAL DETERMINISTIC function. For more information, see the [Database Performance and Query Optimization](#) topic collection.

READS SQL DATA

Specifies that the function can execute statements with a data access classification of READS SQL DATA, CONTAINS SQL, or NO SQL. The function cannot execute SQL statements that modify data.

NO SQL

Specifies that the function can execute only SQL statements with a data access classification of NO SQL.

CONTAINS SQL

Specifies that the function can execute only SQL statements with a data access classification of CONTAINS SQL or NO SQL. The function cannot execute any SQL statements that read or modify data.

MODIFIES SQL DATA

The function can execute any SQL statement except those statements that are not supported in any function.

RETURNS NULL ON NULL INPUT or CALLED ON NULL INPUT

Specifies whether the function is called if any of the input arguments is null at execution time. CALLED ON NULL INPUT is the default.

RETURNS NULL ON INPUT

Specifies that the function is not invoked if any of the input arguments is null. The result is the null value.

CALLED ON NULL INPUT

Specifies that the function is to be invoked, if any, or all, argument values are null. This specification means that the function must be coded to test for null argument values. The function can return a null or nonnull value.

INHERIT SPECIAL REGISTERS

Specifies that existing values of special registers are inherited upon entry to the function.

STATIC DISPATCH

Specifies that the function is dispatched statically. All functions are statically dispatched.

NO DBINFO or DBINFO

Specifies whether additional status information is passed when the function is invoked. The default is NO DBINFO.

NO DBINFO

Specifies that no additional information is passed.

DBINFO

Specifies that the database manager should pass a structure containing status information to the function. Table 82 on page 982 contains a description of the DBINFO structure. Detailed information about the DBINFO structure can be found in include sqludf in the appropriate source file in library QSYSINC. For example, for C, sqludf can be found in QSYSINC/H.

DBINFO is only allowed with PARAMETER STYLE SQL or PARAMETER STYLE DB2GENERAL.

<i>Table 82. DBINFO fields</i>		
Field	Data Type	Description
Relational database	VARCHAR(128)	The name of the current server.
Authorization ID	VARCHAR(128)	The run-time authorization ID.

Table 82. DBINFO fields (continued)

Field	Data Type	Description
CCSID Information	INTEGER INTEGER INTEGER INTEGER INTEGER INTEGER INTEGER INTEGER INTEGER INTEGER CHAR(8)	The CCSID information of the job. Three sets of three CCSIDs are returned. The following information identifies the three CCSIDs in each set: <ul style="list-style-type: none"> • SBCS CCSID • DBCS CCSID • Mixed CCSID Following the three sets of CCSIDs is an integer that indicates which set of three sets of CCSIDs is applicable and eight bytes of reserved space. Each set of CCSIDs is for a different encoding scheme (EBCDIC, ASCII, and Unicode). If a CCSID is not explicitly specified for a parameter on the CREATE FUNCTION statement, the input string is assumed to be encoded in the CCSID of the job at the time the function is executed. If the CCSID of the input string is not the same as the CCSID of the parameter, the input string passed to the external function will be converted before calling the external program.
Target column	VARCHAR(128) VARCHAR(128) VARCHAR(128)	If a user-defined function is specified on the right-hand side of a SET clause in an UPDATE statement, the following information identifies the target column: <ul style="list-style-type: none"> • Schema name • Base table name • Column name If the user-defined function is not on the right-hand side of a SET clause in an UPDATE statement, these fields are blank.
Version and release	CHAR(8)	The version, release, and modification level of the database manager.
Platform	INTEGER	The server's platform type.

EXTERNAL ACTION or NO EXTERNAL ACTION

Specifies whether the function takes an action that changes the state of an object that the database manager does not manage. An example of an external action is sending a message or writing a record to a stream file. The default is EXTERNAL ACTION.

EXTERNAL ACTION

Specifies that the function can take an action that changes the state of an object that the database manager does not manage. Thus, the function must be invoked with each successive function invocation. EXTERNAL ACTION should be specified if the function contains a reference to another function that has an external action.

NO EXTERNAL ACTION

The function does not perform an external action. It need not be called with each successive function invocation.

NO EXTERNAL ACTION functions might perform better than EXTERNAL ACTION functions because they might not be invoked for each successive function invocation.

FENCED or NOT FENCED

Specifies whether the external function runs in an environment that is isolated from the database manager environment. FENCED is the default.

FENCED

The function will run in a separate thread.

FENCED functions cannot keep SQL cursors open across individual calls to the function. However, the cursors in one thread are independent of the cursors in any other threads which reduces the possibility of cursor name conflicts.

NOT FENCED

The function may run in the same thread as the invoking SQL statement.

NOT FENCED functions can keep SQL cursors open across individual calls to the function. Since cursors can be kept open, the cursor position will also be preserved between calls to the function. However, cursor names may conflict since the UDF is now running in the same thread as the invoking SQL statement and other NOT FENCED UDFs.

NOT FENCED functions usually perform better than FENCED functions.

PROGRAM TYPE MAIN or PROGRAM TYPE SUB

This parameter is allowed for compatibility with other products. It indicates whether the routine's external program is a program (*PGM) or a procedure in a service program (*SRVPGM).

PROGRAM TYPE MAIN

Specifies that the routine executes as the main entry point in a program. The external program must be a *PGM object.

PROGRAM TYPE SUB

Specifies that the routine executes as a procedure in a service program. The external program must be a *SRVPGM object.

NO FINAL CALL or FINAL CALL

Specifies whether a *final call* is made to the function. A final call enables the function to free any system resources that it has acquired. A final call is useful when the function has been defined with the SCRATCHPAD keyword and the function acquires system resources and stores them in the scratchpad. The default is NO FINAL CALL.

NO FINAL CALL

Specifies that a final call is not made to the function. The function does not receive an additional argument that specifies the type of call.

FINAL CALL

Specifies that a final call is made to the function. To differentiate between final calls and other calls, the function receives an additional argument that specifies the type of call.

FINAL CALL is only allowed with PARAMETER STYLE SQL or PARAMETER STYLE DB2GENERAL.

The types of calls are:

First Call

Specifies the first call to the function for this reference to the function in this SQL statement. A first call is a normal call. SQL arguments are passed and the function is expected to return a result.

Normal Call

Specifies that SQL arguments are passed and the function is expected to return a result.

Final Call

Specifies the last call to the function to enable the function to free resources. A final call is not a normal call. If an error occurs, the database manager attempts to make the final call.

A final call occurs at these times:

- *End of statement*: When the cursor is closed for cursor-oriented statements, or the execution of the statement has completed.

- *End of a parallel task*: When the function is executed by parallel tasks.
- *End of transaction*: When normal end of statement processing does not occur. For example, the logic of an application, for some reason, bypasses closing the cursor.

Some functions that use a final call can receive incorrect results if parallel tasks execute the function. For example, if a function sends a note for each final call to it, one note is sent for each parallel task instead of once for the function. Specify the `DISALLOW PARALLEL` clause for functions that have inappropriate actions when executed in parallel.

If a commit operation occurs while a cursor defined as `WITH HOLD` is open, a final call is made when the cursor is closed or the application ends. If a commit occurs at the end of a parallel task, a final call is made regardless of whether a cursor defined as `WITH HOLD` is open.

Committable operations should not be performed during a `FINAL CALL`, because the `FINAL CALL` may occur during a close that is invoked as part of a `COMMIT` operation.

ALLOW PARALLEL or DISALLOW PARALLEL

Specifies whether the function can be run in parallel.

The default is `DISALLOW PARALLEL` if one or more of the following clauses are specified: `NOT DETERMINISTIC`, `EXTERNAL ACTION`, `FINAL CALL`, `MODIFIES SQL DATA`, or `SCRATCHPAD`. Otherwise, `ALLOW PARALLEL` is the default.

ALLOW PARALLEL

Specifies that the database manager can consider parallelism for the function. The database manager is not required to use parallelism on the SQL statement that invokes the function or on any SQL statement issued from within the function.

See the descriptions of `NOT DETERMINISTIC`, `EXTERNAL ACTION`, `MODIFIES SQL DATA`, `SCRATCHPAD`, and `FINAL CALL` for considerations that apply to specification of `ALLOW PARALLEL`.

DISALLOW PARALLEL

Specifies that the database manager must not use parallelism for the function.

NO SCRATCHPAD or SCRATCHPAD

Specifies whether the function requires a static memory area.

NO SCRATCHPAD

Specifies that the function does not require a persistent memory area.

SCRATCHPAD integer

Specifies that the function requires a persistent memory area of length integer. The integer can range from 1 to 16,000,000. If the memory area is not specified, the size of the area is 100 bytes. If parameter style SQL is specified, a pointer is passed following the required parameters that points to a static storage area. If `ALLOW PARALLEL` is specified, a memory area is allocated for each user-defined function reference in the statement. If `DISALLOW PARALLEL` is specified, only 1 memory area will be allocated for the function.

The scope of a scratchpad is the SQL statement. For each reference to the function in an SQL statement, there is one scratchpad. For example, assuming that function `UDFX` was defined with the `SCRATCHPAD` keyword, three scratchpads are allocated for the three references to `UDFX` in the following SQL statement:

```
SELECT A, UDFX(A)
FROM TABLEB
WHERE UDFX(A) > 103 OR UDFX(A) < 19
```

If the function is run under parallel tasks, one scratchpad is allocated for each parallel task of each reference to the function in the SQL statement. This can lead to unpredictable results. For example, if a function uses the scratchpad to count the number of times that it is invoked, the count reflects the number of invocations done by the parallel task and not the SQL statement. Specify the `DISALLOW PARALLEL` clause for functions that will not work correctly with parallelism.

`SCRATCHPAD` is only allowed with `PARAMETER STYLE SQL` or `PARAMETER STYLE DB2GENERAL`.

EXTERNAL

Specifies that the CREATE FUNCTION statement is being used to define a new function that is based on code that is written in an external programming language.

If *external-program-name* is not specified, the external program name is assumed to be the same as the function name.

NAME *external-program-name*

Specifies the program, service program, or Java class that will be executed when the function is invoked in an SQL statement. The name must identify a program, service program, or Java class that exists at the application server at the time the function is invoked. If the naming option is *SYS and the name is not qualified:

- The current path will be used to search for the program at the time the function is invoked.
- *LIBL will be used to search for the program or service program at the time COMMENT, GRANT, LABEL, or REVOKE operations are performed on the function.

The validity of the name is checked at the application server. If the format of the name is not correct, an error is returned.

The program, service program, or Java class need not exist at the time the function is created, but it must exist at the time the function is invoked.

CONNECT, SET CONNECTION, RELEASE, DISCONNECT, COMMIT, ROLLBACK, and SET TRANSACTION statements are not allowed in the external program of the function.

NOT SECURED or SECURED

Specifies whether the function is considered secure for row access control and column access control.

NOT SECURED

Specifies that the function is considered not secure for row access control and column access control. This is the default.

When the function is invoked, the arguments of the function must not reference a column for which a column mask is enabled when the table is using active column access control.

SECURED

Specifies that the function is considered secure for row access control and column access control. This option can be used for an external function that is written in C, C++, ILE RPG, ILE COBOL, ILE CL, or Java. The program or service program must exist when the CREATE FUNCTION statement is executed.

A function must be defined as secure when it is referenced in a row permission or a column mask.

SET OPTION-statement

Specifies the options that will be used for parameter defaults. The default values for the options depend on the options in effect at create time. For more information, see [“SET OPTION” on page 1505](#).

The following options are used when processing default value expressions: ALWCPYDTA, CONACC, DATFMT, DATSEP, DECFLTRND, DECMPT, DECRESULT, DFTRDBCOL, LANGID, SQLCURRULE, SQLPATH, SRTSEQ, TGTRLS, TIMFMT, and TIMSEP. The options CNULRQD, CNULIGN, COMPILEOPT, EXTIND, NAMING, and SQLCA are not allowed in the CREATE FUNCTION statement. Other options are accepted but will be ignored.

Notes

General considerations for defining user-defined functions: See [“CREATE FUNCTION” on page 965](#) for general information on defining user-defined functions.

REPLACE rules: When an external function is recreated by REPLACE:

- Any existing comment or label is discarded.

- If a different external program is specified:
 - Authorized users are not copied to the new program.
 - Journal auditing is not changed.
- Otherwise:
 - Authorized users are maintained. The object owner will not change.
 - Current journal auditing is not changed.

Creating the function: When an external function associated with an ILE external program or service program is created, an attempt is made to save the function's attributes in the associated program or service program object. If the *PGM or *SRVPGM object is saved and then restored to this or another system, the attributes are used to update the catalogs.

The attributes can be saved for external functions subject to the following restrictions:

- The external program library must not be QSYS.
- The external program must exist when the CREATE FUNCTION statement is issued.
 - If system naming is specified and the external program name is not qualified, the external program must be found in the library list.
- The external program must be an ILE *PGM or *SRVPGM object.

If the object cannot be updated, the function will still be created.

Invoking the function: When an external function is invoked, it runs in whatever activation group was specified when the external program or service program was created. However, ACTGRP(*CALLER) should normally be used so that the function runs in the same activation group as the calling program. ACTGRP(*NEW) is not allowed.

LANGUAGE JAVA functions always run in the default activation group (*DFTACTGRP). Caution should be used when writing MODIFIES SQL DATA Java functions. Since changes performed by the Java function are performed in the default activation group, transaction problems may occur if the invoker runs in a new activation group (*NEW).

Notes for Java functions: To be able to run Java functions, you must have the IBM Developer Kit for Java (5770-JV1) installed on your system. Otherwise, an SQLCODE of -443 will be returned and a CPDB521 message will be placed in the job log.

If an error occurs while running a Java function, an SQLCODE of -443 will be returned. Depending on the error, other messages may exist in the job log of the job where the function was run.

Syntax alternatives: The following keywords are synonyms supported for compatibility to prior releases. These keywords are non-standard and should not be used:

- The keywords VARIANT and NOT VARIANT can be used as synonyms for NOT DETERMINISTIC and DETERMINISTIC.
- The keywords NULL CALL and NOT NULL CALL can be used as synonyms for CALLED ON NULL INPUT and RETURNS NULL ON NULL INPUT.
- The keywords SIMPLE CALL can be used as a synonym for GENERAL.
- The keyword DB2GENRL may be used as a synonym for DB2GENERAL.
- The value DB2SQL may be used as a synonym for SQL.
- The keywords PARAMETER STYLE in the PARAMETER STYLE clause are optional.
- The keywords IS DETERMINISTIC may be used as a synonym for DETERMINISTIC.

Examples

Example 1: Assume an external function program in C is needed that implements the following logic:

```
rslt = 2 * input - 4
```

The function should return a null value if and only if one of the input arguments is null. The simplest way to avoid a function call and get a null result when an input value is null is to specify RETURNS NULL ON NULL INPUT on the CREATE FUNCTION statement. The following statement defines the function, using the specific name MINENULL1.

```
CREATE FUNCTION NTEST1 (SMALLINT)
  RETURNS SMALLINT
  EXTERNAL NAME NTESTMOD
  SPECIFIC MINENULL1
  LANGUAGE C
  DETERMINISTIC
  NO SQL
  FENCED
  PARAMETER STYLE SQL
  RETURNS NULL ON NULL INPUT
  NO EXTERNAL ACTION
```

The program code:

```
void nudft1
(int *input,           /* ptr to input argument      */
 int *output,         /* ptr to output argument     */
 short *input_ind,    /* ptr to input indicator     */
 short *output_ind,   /* ptr to output indicator    */
 char sqlstate[6],    /* sqlstate                   */
 char fname[140],     /* fully qualified function name */
 char finst[129],     /* function specific name     */
 char msgtext[71])   /* msg text buffer            */
{
  if (*input_ind == -1)
    *output_ind = -1;
  else
  {
    *output = 2>(*input)-4;
    *output_ind = 0;
  }
  return;
}
```

Example 2: Assume that a user wants to define an external function named CENTER. The function program will be written in C. The following statement defines the function, and lets the database manager generate a specific name for the function. The name of the program containing the function body is the same as the name of the function, so the EXTERNAL clause does not include 'NAME external-program-name'.

```
CREATE FUNCTION CENTER (INTEGER, FLOAT)
  RETURNS FLOAT
  LANGUAGE C
  DETERMINISTIC
  NO SQL
  PARAMETER STYLE SQL
  NO EXTERNAL ACTION
```

Example 3: Assume that user McBride (who has database administrator authority) wants to define an external function named CENTER in the SMITH schema. McBride plans to give the function specific name FOCUS98. The function program uses a scratchpad to perform some one-time only initialization and save the results. The function program returns a value with a DOUBLE data type. The following statement written by user McBride defines the function and ensures that when the function is invoked, it returns a value with a data type of DECIMAL(8,4).

```
CREATE FUNCTION SMITH.CENTER (DOUBLE, DOUBLE, DOUBLE)
  RETURNS DECIMAL(8,4)
  CAST FROM DOUBLE
  EXTERNAL NAME CMOD
  SPECIFIC FOCUS98
  LANGUAGE C
  DETERMINISTIC
  NO SQL
  FENCED
  PARAMETER STYLE SQL
  NO EXTERNAL ACTION
```

**SCRATCHPAD
NO FINAL CALL**

Example 4: The following example defines a Java user-defined function that returns the position of the first vowel in a string. The user-defined function is written in Java, is to be run fenced, and is the FINDVWL method of class JAVAUDFS.

```
CREATE FUNCTION FINDV (VARCHAR(32000))  
  RETURNS INTEGER  
  FENCED  
  LANGUAGE JAVA  
  PARAMETER STYLE JAVA  
  EXTERNAL NAME 'JAVAUDFS.FINDVWL'  
  NO EXTERNAL ACTION  
  CALLED ON NULL INPUT  
  DETERMINISTIC  
  NO SQL
```

CREATE FUNCTION (external table)

This CREATE FUNCTION (external table) statement defines an external table function at the current server. The function returns a result table.

An external user-defined *table function* may be used in the FROM clause of a subselect, and returns a table to the subselect by returning one row each time it is invoked.

Invocation

This statement can be embedded in an application program or issued interactively. It is an executable statement that can be dynamically prepared.

Authorization

The privileges held by the authorization id of the statement must include at least one of the following:

- For the SYSFUNCS catalog view and SYSPARMS catalog table:
 - The INSERT privilege on the table, and
 - The USAGE privilege on schema QSYS2
- Database administrator authority

If the external program or service program exists, the privileges held by the authorization ID of the statement must include at least one of the following:

- For the external program or service program that is referenced in the SQL statement:
 - The USAGE privilege on the schema that contains the external program or service program.
 - The system authority *EXECUTE on the external program or service program, and
 - The system authority *CHANGE on the program or service program. The system needs this authority to update the program object to contain the information necessary to save/restore the function to another system. If user does not have this authority, the function is still created, but the program object is not updated.
- Database administrator authority

If SQL names are specified and a user profile exists that has the same name as the library into which the function is created, and that name is different from the authorization ID of the statement, then the privileges held by the authorization ID of the statement must include at least one of the following:

- The system authority *ADD to the user profile with that name
- Database administrator authority

If a distinct type is referenced, the privileges held by the authorization ID of the statement must include at least one of the following:

- For each distinct type identified in the statement:
 - The USAGE privilege on the distinct type, and
 - The USAGE privilege on the schema containing the distinct type
- Database administrator authority

To replace an existing function, the privileges held by the authorization ID of the statement must include at least one of the following:

- The following system authorities:
 - The system authority of *OBJMGT on the service program object associated with the function
 - All authorities needed to DROP the function
 - The system authority *READ to the SYSFUNCS catalog view and SYSPARMS catalog table

- Database administrator authority

For information about the system authorities corresponding to SQL privileges, see [Corresponding System Authorities When Checking Privileges to a Table or View](#) and [Corresponding System Authorities When Checking Privileges to a Distinct Type](#).

Syntax

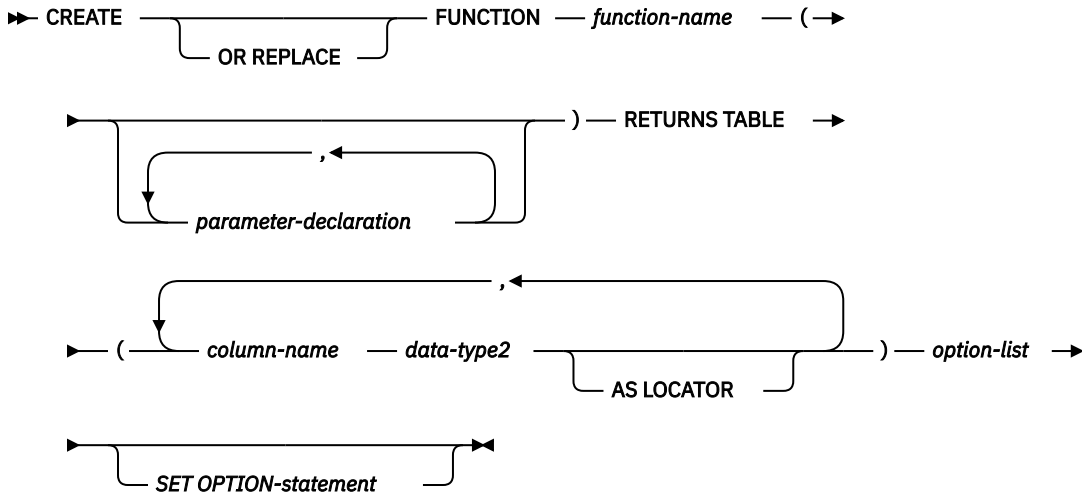

parameter-declaration

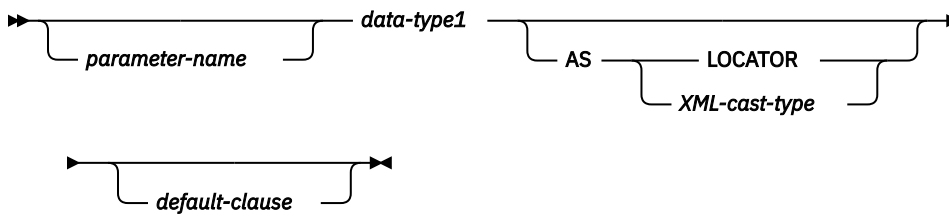

data-type1, data-type2

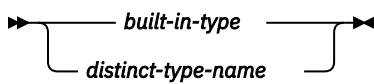

XML-cast-type

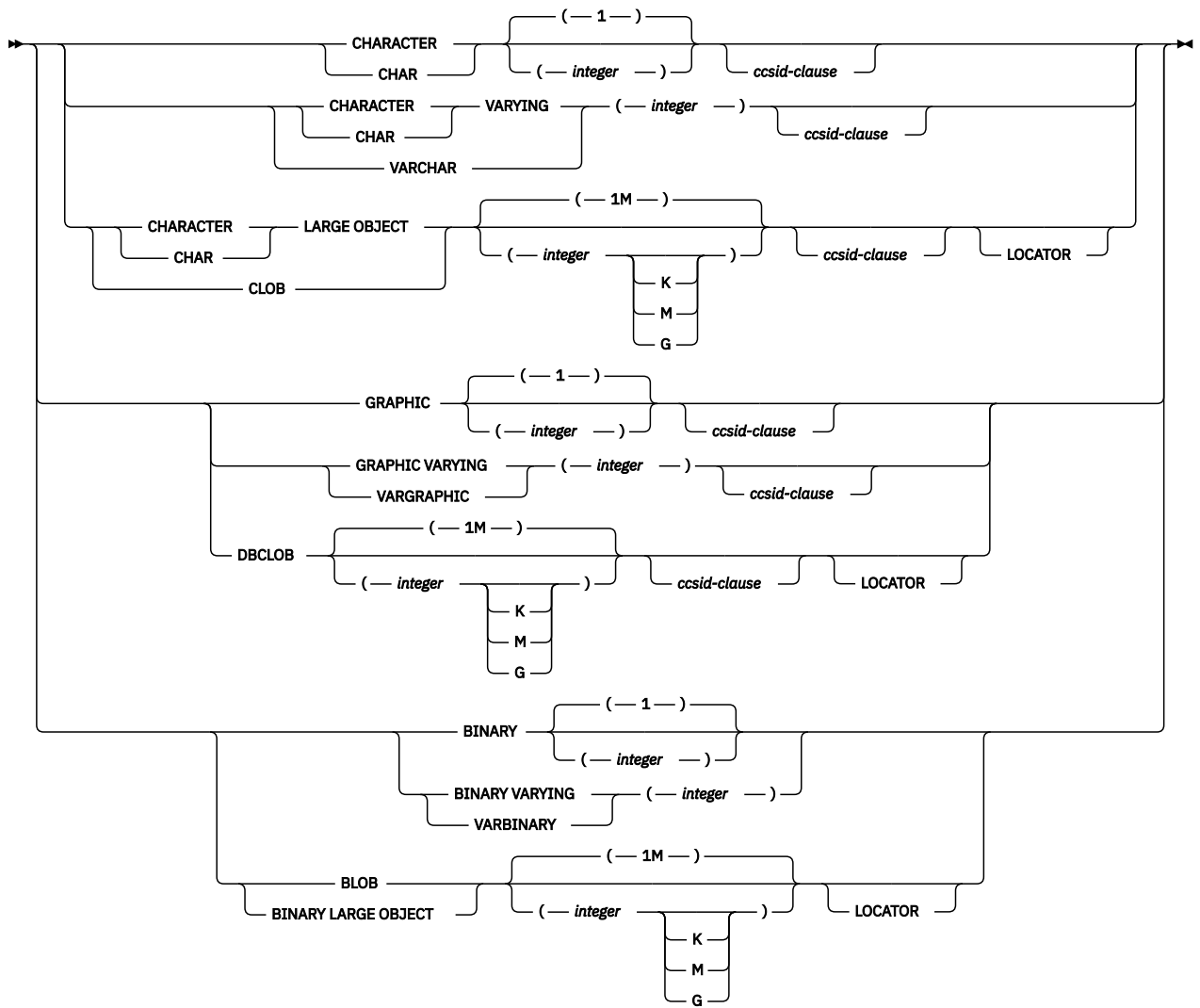

built-in-type

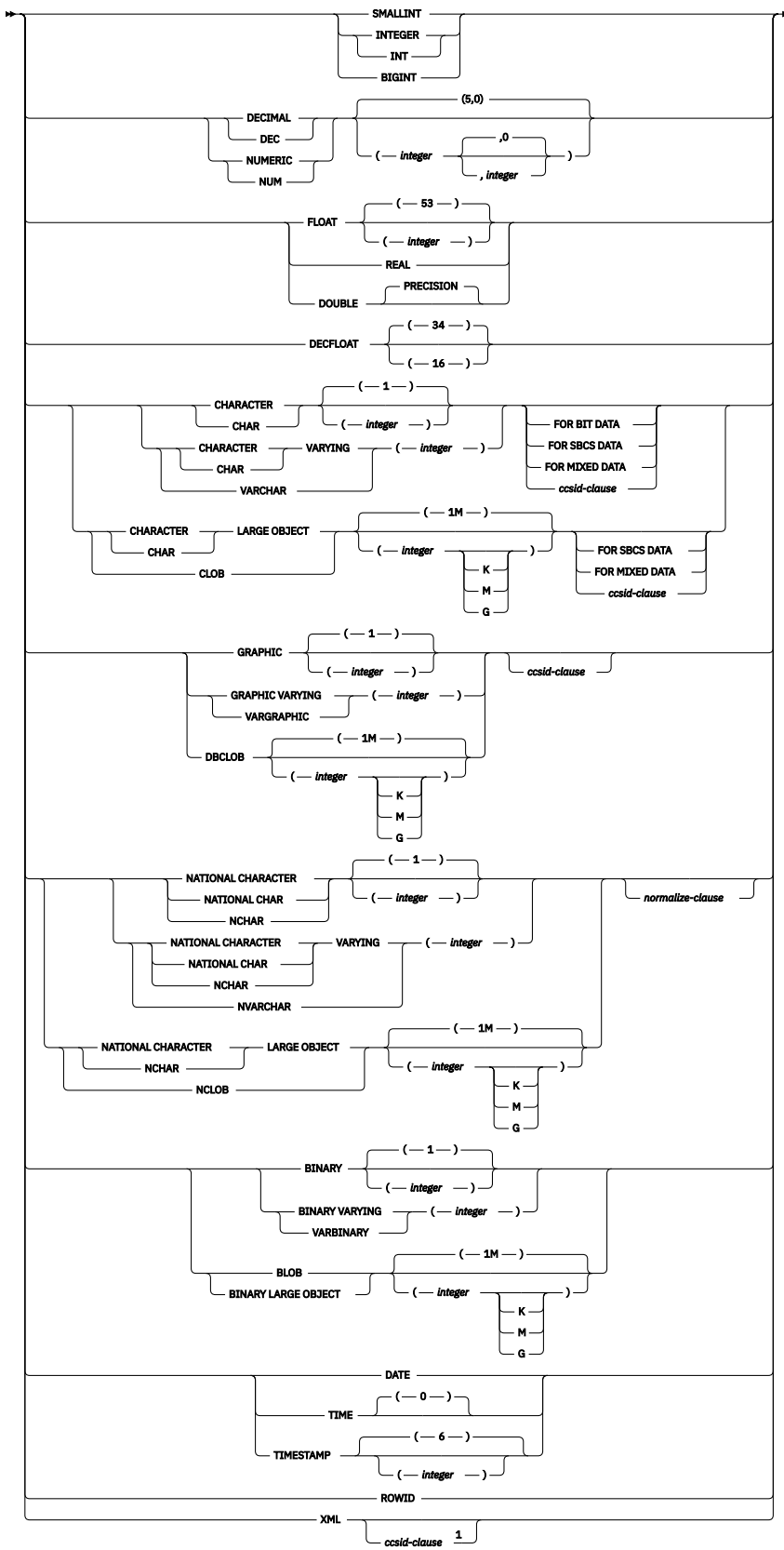

ccsid-clause

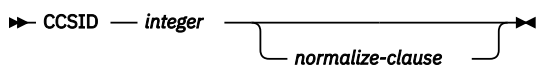

normalize-clause

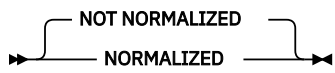

default-clause

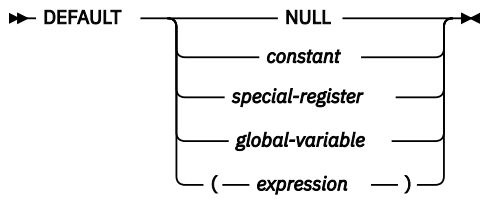

Notes:

¹ The *ccsid-clause* for XML is only allowed for *data-type2*

option-list

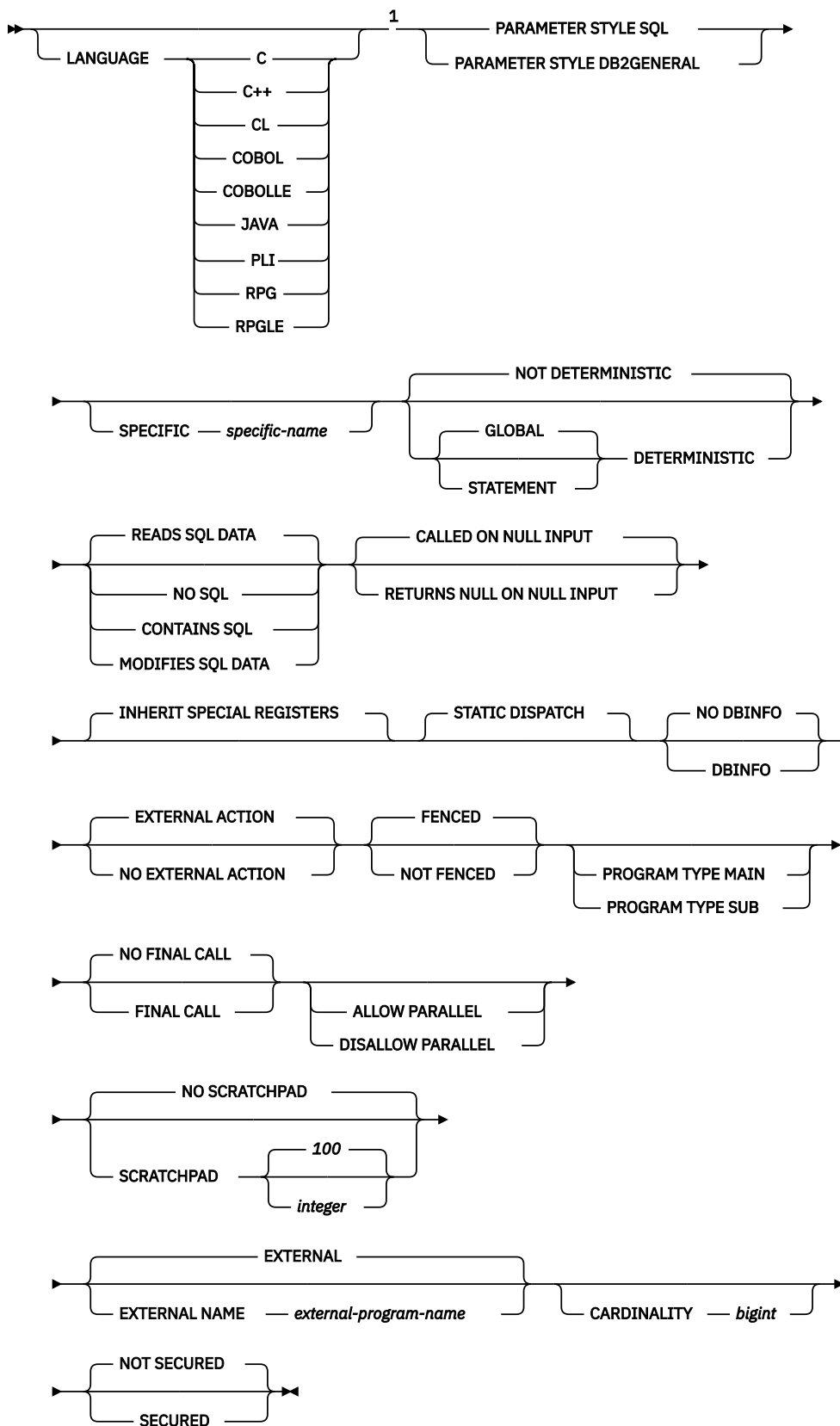

Notes:

¹ This clause and the clauses that follow in the option-list can be specified in any order. Each clause can be specified at most once.

Description

OR REPLACE

Specifies to replace the definition for the function if one exists at the current server. The existing definition is effectively dropped before the new definition is replaced in the catalog with the exception that privileges that were granted on the function are not affected. This option is ignored if a definition for the function does not exist at the current server. To replace an existing function, the *specific-name* and *function-name* of the new definition must be the same as the *specific-name* and *function-name* of the old definition, or the signature of the new definition must match the signature of the old definition. Otherwise, a new function is created.

function-name

Names the user-defined function. The combination of name, schema name, the number of parameters, and the data type of each parameter (without regard for any length, precision, scale, or CCSID attributes of the data type) must not identify a user-defined function that exists at the current server unless OR REPLACE is specified.

For SQL naming, the function will be created in the schema specified by the implicit or explicit qualifier.

For system naming, the function will be created in the schema that is specified by the qualifier. If no qualifier is specified:

- If the value of the CURRENT SCHEMA special register is *LIBL, the function will be created in the current library (*CURLIB).
- Otherwise, the function will be created in the current schema.

In general, more than one function can have the same name if the function signature of each function is unique.

Certain function names are reserved for system use. For more information see Choosing the Schema and Function Name in [“CREATE FUNCTION”](#) on page 965.

(parameter-declaration,...)

Specifies the number of input parameters of the function and the data type of each parameter. Each *parameter-declaration* specifies an input parameter for the function.

The maximum number of parameters depends on the type of language:

- For JAVA and ILE programs and service programs, the maximum is 2000.
- For OPM programs, the maximum is 90.

The maximum number of parameters can be further limited by the maximum number of parameters allowed by the language.

A function can have zero or more input parameters. There must be one entry in the list for each parameter that the function expects to receive. All the parameters for a function are input parameters and are nullable. In the case of JAVA, numeric parameters other than the DECIMAL and NUMERIC types are not nullable. A runtime error will occur if a null value is input to such a parameter for a CALLED ON NULL INPUT function. For more information, see Defining the parameters in [“CREATE FUNCTION”](#) on page 965.

parameter-name

Names the parameter. Although not required, a parameter name can be specified for each parameter. The name cannot be the same as any other *parameter-name* in the parameter list.

data-type1

Specifies the data type of the input parameter. The data type can be a built-in data type or a distinct type. It cannot be an array type.

built-in-type

Specifies a built-in data type. For a more complete description of each built-in data type, see [“CREATE TABLE”](#) on page 1105. Some data types are not supported in all languages. For details on the mapping between the SQL data types and host language data types, see

Embedded SQL Programming topic collection. Built-in data type specifications can be specified if they correspond to the language that is used to write the user-defined function.

distinct-type-name

Specifies a user-defined distinct type. The length, precision, or scale attributes for the parameter are those of the source type of the distinct type (those specified on CREATE TYPE). For more information about creating a distinct type, see [“CREATE TYPE \(distinct\)” on page 1184](#)

If the name of the distinct type is unqualified, the database manager resolves the schema name by searching the schemas in the SQL path.

Parameters with a large object (LOB) data type are not supported when PARAMETER STYLE JAVA is specified.

If a CCSID is specified, the parameter will be converted to that CCSID prior to passing it to the function. If a CCSID is not specified, the CCSID is determined by the default CCSID at the current server at the time the function is invoked.

Date, time, and timestamp parameters are passed to the procedure as character strings in ISO format.

Any parameter that has an XML type must specify either the *XML-cast-type* clause or the AS LOCATOR clause.

AS LOCATOR

Specifies that the input parameter is a locator to the value rather than the actual value. You can specify AS LOCATOR only if the input parameter has a LOB or XML data type or a distinct type based on a LOB or XML data type. If AS LOCATOR is specified, FOR SBCS DATA or FOR MIXED DATA must not be specified.

For more information on the AS LOCATOR clause, see [Specifying AS LOCATOR for a parameter in “CREATE FUNCTION” on page 965](#).

AS XML-cast-type

Specifies the data type passed to the function for a parameter that is XML type or a distinct type based on XML type. If LOCATOR is specified, the parameter is a locator to the value rather than the actual value.

If a CCSID value is specified, only Unicode CCSID values can be specified for graphic data types. If a CCSID value is not specified, the CCSID is established at the time the function is created according to the SQL_XML_DATA_CCSID QAQQINI option setting. The default CCSID is 1208. See [“XML Values” on page 80](#) for a description of this option.

default-clause

Specifies a default value for the parameter. The default can be a constant, a special register, a global variable, an expression, or the keyword NULL. The expression is any expression defined in [“Expressions” on page 159](#), that does not include an aggregate function or column name. If a default value is not specified, the parameter has no default and cannot be omitted on invocation. The maximum length of the expression string is 64K.

The default expression must be assignment compatible to the parameter data type.

Any comma in the default expression that is intended as a separator of numeric constants in a list must be followed by a space.

All objects referenced in a default expression must exist when the function is created. When the function is invoked, the default will be evaluated using the authority of the invoker.

A default cannot be specified for a parameter of type array.

RETURNS TABLE

Specifies that the output of the function is a table. The parenthesis that follow this clause enclose a list of names and the data types of the columns of the result table.

The maximum number of result columns depends on the type of language. Assume that the number of parameters is N .

- For JAVA and ILE programs and service programs, there must be no more than $8000 - N$ columns.
- For OPM programs, there must be no more than $125 - N$ columns.

column-name

Specifies the name of a column of the output table. Do not specify the same name more than once.

data-type2

Specifies the data type of the column. The column is nullable.

You can specify any built-in data type (except LONG VARCHAR, LONG VARGRAPHIC, or DataLink) or a distinct type (that is not based on a DataLink). You cannot specify an array type.

If a DATE or TIME is specified, the table function must return the date or time in ISO format.

If a CCSID is specified,

- If AS LOCATOR is not specified, the result returned is assumed to be encoded in that CCSID.
- If AS LOCATOR is specified and the CCSID of the data the locator points to is encoded in a different CCSID, the data is converted to the specified CCSID.

If a CCSID is not specified,

- If AS LOCATOR is not specified, the result returned is assumed to be encoded in the CCSID of the job (or associated graphic CCSID of the job for graphic string return values).
- If AS LOCATOR is specified, the data the locator points to is converted to the CCSID of the job, if the CCSID of the data the locator points to is encoded in a different CCSID. To avoid any potential loss of characters during the conversion, consider explicitly specifying a CCSID that can represent any characters that will be returned from the function. This is especially important if the data type is graphic string data. In this case, consider using CCSID 1200 or 13488 (Unicode graphic string data).

AS LOCATOR

Specifies that the function returns a locator to the value for the column rather than the actual value. You can specify AS LOCATOR only for a LOB or XML data type or a distinct type based on a LOB or XML data type. If AS LOCATOR is specified, FOR SBCS DATA or FOR MIXED DATA must not be specified.

For more information on the AS LOCATOR clause, see [Specifying AS LOCATOR for a parameter in "CREATE FUNCTION" on page 965](#).

LANGUAGE

The language clause specifies the language of the external program.

If LANGUAGE is not specified, the LANGUAGE is determined from the program attribute information associated with the external program at the time the function is created. The language of the program is assumed to be C if:

- The program attribute information associated with the program does not identify a recognizable language
- The program cannot be found

C

The external program is written in C.

C++

The external program is written in C++.

CL

The external program is written in CL or ILE CL.

COBOL

The external program is written in COBOL.

COBOLLE

The external program is written in ILE COBOL.

JAVA

The external program is written in JAVA. The database manager will call the user-defined function as a method in a Java class.

PLI

The external program is written in PL/I.

RPG

The external program is written in RPG.

RPGLE

The external program is written in ILE RPG.

PARAMETER STYLE

Specifies the conventions used for passing parameters to and returning the values from functions:

DB2GENERAL

This parameter style is used to specify the conventions for passing parameters to and returning the value from external functions that are defined as a method in a Java class. All applicable parameters are passed. The parameters are defined to be in the following order:

- The first N parameters are the input parameters that are specified on the CREATE FUNCTION statement.
- The next M parameters are the result columns of the function that are specified on the RETURNS TABLE clause.

DB2GENERAL is only allowed when the LANGUAGE is JAVA.

SQL

All applicable parameters are passed. The parameters are defined to be in the following order:

- The first N parameters are the input parameters that are specified on the CREATE FUNCTION statement.
- The next M parameters are the result columns of the function that are specified on the RETURNS TABLE clause.
- N parameters for indicator variables for the input parameters.
- M parameters for the indicator variables of the result columns of the function that are specified on the RETURNS TABLE clause
- A CHAR(5) output parameter for SQLSTATE. The SQLSTATE returned indicates the success or failure of the function. The SQLSTATE returned either be:
 - the SQLSTATE from the last SQL statement executed in the external program,
 - an SQLSTATE that is assigned by the external program.

The user may set the SQLSTATE to any valid value in the external program to return an error or warning from the function.

- A VARCHAR(517) input parameter for the fully qualified function name.
- A VARCHAR(128) input parameter for the specific name.
- A VARCHAR(1000) output parameter for the message text.
- A structure (consisting of an INTEGER followed by a CHAR(n)) input and output parameter for the scratchpad, if SCRATCHPAD was specified on the CREATE FUNCTION statement.
- An INTEGER input parameter for the call type.
- A structure for the dbinfo structure, if DBINFO was specified on the CREATE FUNCTION statement.

These parameters are passed according to the specified LANGUAGE. For example, if the language is C or C++, the VARCHAR parameters are passed as NUL-terminated strings. For more information about the parameters passed, see the include sqludf in the appropriate source file in library QSYSINC. For example, for C, sqludf can be found in QSYSINC/H.

Note that the language of the external function determines how the parameters are passed. For example, in C, any VARCHAR or CHAR parameters are passed as NUL-terminated strings. For more information, see the [SQL Programming](#) topic collection. For Java routines, see the [IBM Developer Kit for Java](#) topic collection.

SPECIFIC *specific-name*

Specifies a unique name for the function. For more information on specific names, see [Specifying a specific name for a function in "CREATE FUNCTION"](#) on page 965.

GLOBAL DETERMINISTIC or STATEMENT DETERMINISTIC or NOT DETERMINISTIC

Specifies whether the function returns the same results each time that the function is invoked with the same input arguments. The default is NOT DETERMINISTIC.

NOT DETERMINISTIC

Specifies that the function might not return the same result each time that the function is invoked with the same input arguments. The function depends on some state values that affect the results. The database manager uses this information during optimization of SQL statements. An example of a table function that is not deterministic is one that references special registers, non-deterministic functions, or a sequence in a way that affects the table function result table.

GLOBAL DETERMINISTIC

Specifies that the function always returns the same result table each time that the function is invoked with the same input arguments. The database manager uses this information during optimization of SQL statements. The query optimizer may choose to cache global deterministic function results.

STATEMENT DETERMINISTIC

Specifies that the function might not return the same result each time that the function is invoked with the same input arguments, but multiple invocations of the function within a single SQL statement are considered deterministic. The query optimizer will not cache statement deterministic function results.⁹²

CONTAINS SQL, READS SQL DATA, MODIFIES SQL DATA, or NO SQL

Specifies the classification of SQL statements and nested routines that the function can execute. The database manager verifies that the SQL statements issued by the function, and all routines locally invoked by the function, are consistent with this specification. The verification is not performed when nested remote routines are invoked. For the classification of each statement, see [Appendix B, "Characteristics of SQL statements,"](#) on page 1643. The default is READS SQL DATA. This option is ignored for parameter default expressions.

READS SQL DATA

Specifies that the function can execute statements with a data access classification of READS SQL DATA, CONTAINS SQL, or NO SQL. The function cannot execute SQL statements that modify data.

NO SQL

Specifies that the function can execute only SQL statements with a data access classification of NO SQL.

CONTAINS SQL

Specifies that the function can execute only SQL statements with a data access classification of CONTAINS SQL or NO SQL. The function cannot execute any SQL statements that read or modify data.

⁹² The DETERMINISTIC_UDF_SCOPE QAQQINI option can be used to get this same behavior for a GLOBAL DETERMINISTIC function. For more information, see the [Database Performance and Query Optimization](#) topic collection.

MODIFIES SQL DATA

The function can execute any SQL statement except those statements that are not supported in any function.

RETURNS NULL ON NULL INPUT or CALLED ON NULL INPUT

Specifies whether the function is called if any of the input arguments is null at execution time. CALLED ON NULL INPUT is the default.

RETURNS NULL ON NULL INPUT

Specifies that the function is not called if any of the input arguments is null. The result is an empty table, which is a table with no rows.

CALLED ON NULL INPUT

Specifies that the function is to be invoked, if any argument values are null. This specification means that the function must be coded to test for null argument values. The function can return an empty table, depending on its logic.

INHERIT SPECIAL REGISTERS

Specifies that existing values of special registers are inherited upon entry to the function.

STATIC DISPATCH

Specifies that the function is dispatched statically. All functions are statically dispatched.

NO DBINFO or DBINFO

Specifies whether additional status information is passed when the function is invoked. The default is NO DBINFO.

NO DBINFO

Specifies that no additional information is passed.

DBINFO

Specifies that the database manager should pass a structure containing status information to the function. Table 83 on page 1001 contains a description of the DBINFO structure. Detailed information about the DBINFO structure can be found in sqludf in the appropriate source file in library QSYSINC. For example, for C, sqludf can be found in QSYSINC/H.

Field	Data Type	Description
Relational database	VARCHAR(128)	The name of the current server.
Authorization ID	VARCHAR(128)	The run-time authorization ID.

Table 83. DBINFO fields (continued)

Field	Data Type	Description
CCSID Information	<p>INTEGER INTEGER INTEGER</p> <p>INTEGER INTEGER INTEGER</p> <p>INTEGER INTEGER INTEGER</p> <p>INTEGER</p> <p>CHAR(8)</p>	<p>The CCSID information of the job. Three sets of three CCSIDs are returned. The following information identifies the three CCSIDs in each set:</p> <ul style="list-style-type: none"> • SBCS CCSID • DBCS CCSID • Mixed CCSID <p>Following the three sets of CCSIDs is an integer that indicates which set of three sets of CCSIDs is applicable and eight bytes of reserved space.</p> <p>Each set of CCSIDs is for a different encoding scheme (EBCDIC, ASCII, and Unicode).</p> <p>If a CCSID is not explicitly specified for a parameter on the CREATE FUNCTION statement, the input string is assumed to be encoded in the CCSID of the job at the time the function is executed. If the CCSID of the input string is not the same as the CCSID of the parameter, the input string passed to the external function will be converted before calling the external program.</p>
Target column	<p>VARCHAR(128) VARCHAR(128) VARCHAR(128)</p>	<p>If a user-defined function is specified on the right-hand side of a SET clause in an UPDATE statement, the following information identifies the target column:</p> <ul style="list-style-type: none"> • Schema name • Base table name • Column name <p>If the user-defined function is not on the right-hand side of a SET clause in an UPDATE statement, these fields are blank.</p>
Version and release	CHAR(8)	The version, release, and modification level of the database manager.
Platform	INTEGER	The server's platform type.
Number of table function column list entries	SMALLINT	The number of non-zero entries in the table function column list specified in the "Table function column list" field below.
Reserved	CHAR(24)	Reserved for future use.

Table 83. DBINFO fields (continued)

Field	Data Type	Description
Table function column list	Pointer (16 Bytes)	<p>This field is a pointer to an array of short integers which is dynamically allocated by the database manager. Only the first n entries, where n is specified in the "Number of table function column list entries" field, are of interest, n may be equal to 0, and is less than or equal to the number of result columns defined for the function in the RETURNS TABLE clause. The values correspond to the ordinal numbers of the columns which this statement needs from the table function. A value of 1 means the first defined result column, 2 means the second defined result column, and so on. The values may be in any order. Note that n could be equal to zero for a statement that is similar to <code>SELECT COUNT(*) FROM TABLE(TF(...)) AS QQ</code>, where no actual column values are needed by the query.</p> <p>This array represents an opportunity for optimization. The function need not return all values for all the result columns of the table function. Only a subset of the values may be needed in a particular context, and these are the columns identified (by number) in the array. Since this optimization may complicate the function logic, the function can choose to return every defined column.</p>

EXTERNAL ACTION or NO EXTERNAL ACTION

Specifies whether the function takes an action that changes the state of an object that the database manager does not manage. An example of an external action is sending a message or writing a record to a stream file. The default is EXTERNAL ACTION.

EXTERNAL ACTION

Specifies that the function can take an action that changes the state of an object that the database manager does not manage. Thus, the function must be invoked with each successive function invocation. EXTERNAL ACTION should be specified if the function contains a reference to another function that has an external action.

NO EXTERNAL ACTION

The function does not perform an external action. It need not be called with each successive function invocation.

NO EXTERNAL ACTION functions might perform better than EXTERNAL ACTION functions because they might not be invoked for each successive function invocation.

FENCED or NOT FENCED

Specifies whether the external function runs in an environment that is isolated from the database manager environment. FENCED is the default.

FENCED

The function will run in a separate thread.

FENCED functions cannot keep SQL cursors open across individual calls to the function. However, the cursors in one thread are independent of the cursors in any other threads which reduces the possibility of cursor name conflicts.

NOT FENCED

The function may run in the same thread as the invoking SQL statement.

NOT FENCED functions can keep SQL cursors open across individual calls to the function. Since cursors can be kept open, the cursor position will also be preserved between calls to the function. However, cursor names may conflict since the UDF is now running in the same thread as the invoking SQL statement and other NOT FENCED UDFs.

NOT FENCED functions usually perform better than FENCED functions.

PROGRAM TYPE MAIN or PROGRAM TYPE SUB

This parameter is allowed for compatibility with other products. It indicates whether the routine's external program is a program (*PGM) or a procedure in a service program (*SRVPGM).

PROGRAM TYPE MAIN

Specifies that the routine executes as the main entry point in a program. The external program must be a *PGM object.

PROGRAM TYPE SUB

Specifies that the routine executes as a procedure in a service program. The external program must be a *SRVPGM object.

NO FINAL CALL or FINAL CALL

Specifies whether a separate *first call* and *final call* are made to the function. To differentiate between types of calls, the function receives an additional argument that specifies the type of call. For table functions, the *call-type* argument is always present (regardless of whether FINAL CALL or NO FINAL CALL is in effect), and it indicates first call, open call, fetch call, close call, or final call.

With NO FINAL CALL, the database manager will only make three types of calls to the table function: open, fetch and close. However, if FINAL CALL is specified, then in addition to open, fetch and close, a first call and a final call can be made to the table function.

A final call enables the function to free any system resources that it has acquired. A final call is useful when the function has been defined with the SCRATCHPAD keyword and the function acquires system resources and stores them in the scratchpad. The default is NO FINAL CALL.

NO FINAL CALL

Specifies that separate first and final calls are not made to the function. However, the open, fetch, and close calls are still made to the function, and the table function always receives an additional argument that specifies the type of call.

FINAL CALL

Specifies that separate first and final calls are made to the function. It also controls when the scratchpad is re-initialized.

The types of calls are:

First Call

Specifies the first call to the function for this reference to the function in this SQL statement.

Open Call

Specifies a call to open the table function result in this SQL statement.

Fetch Call

Specifies a call to fetch a row from the table function in this SQL statement.

Close Call

Specifies a call to close the table function result in this SQL statement.

Final Call

Specifies the last call to the function to enable the function to free resources. If an error occurs, the database manager attempts to make the final call.

A final call occurs at these times:

- *End of statement:* When the cursor is closed for cursor-oriented statements, or the execution of the statement has completed.
- *End of transaction:* When normal end of statement processing does not occur. For example, the logic of an application, for some reason, bypasses closing the cursor.

If a commit operation occurs while a cursor defined as WITH HOLD is open, a final call is made when the cursor is closed or the application ends.

Committable operations should not be performed during a FINAL CALL, because the FINAL CALL may occur during a close invoked as part of a COMMIT operation.

ALLOW PARALLEL or DISALLOW PARALLEL

Specifies whether the function can be run in parallel.

The default is DISALLOW PARALLEL if one or more of the following clauses are specified: NOT DETERMINISTIC, EXTERNAL ACTION, FINAL CALL, MODIFIES SQL DATA, or SCRATCHPAD. Otherwise, ALLOW PARALLEL is the default.

ALLOW PARALLEL

Specifies that the database manager can consider parallelism for the function. The database manager is not required to use parallelism on the SQL statement that invokes the function or on any SQL statement issued from within the function.

See the descriptions of NOT DETERMINISTIC, EXTERNAL ACTION, MODIFIES SQL DATA, SCRATCHPAD, and FINAL CALL for considerations that apply to specification of ALLOW PARALLEL.

DISALLOW PARALLEL

Specifies that the database manager must not use parallelism for the function.

NO SCRATCHPAD or SCRATCHPAD

Specifies whether the function requires a static memory area.

NO SCRATCHPAD

Specifies that the function does not require a persistent memory area.

SCRATCHPAD integer

Specifies that the function requires a persistent memory area of length integer. The integer can range from 1 to 16,000,000. If the memory area is not specified, the size of the area is 100 bytes. If parameter style SQL is specified, a pointer is passed following the required parameters that points to a static storage area. Only 1 memory area will be allocated for the function.

The scope of a scratchpad is the SQL statement. For each reference to the function in an SQL statement, there is one scratchpad. For example, assuming that function UDFX was defined with the SCRATCHPAD keyword, two scratchpads are allocated for the two references to UDFX in the following SQL statement:

```
SELECT A.C1, B.C1
FROM TABLE(UDFX(:hv1)) AS A, TABLE(UDFX(:hv1)) AS B
```

EXTERNAL

Specifies that the CREATE FUNCTION statement is being used to define a new function that is based on code that is written in an external programming language.

If *external-program-name* is not specified, the external program name is assumed to be the same as the function name.

NAME external-program-name

Specifies the program, service program, or Java class that will be executed when the function is invoked in an SQL statement. The name must identify a program, service program, or Java class that exists at the application server at the time the function is invoked. If the naming option is *SYS and the name is not qualified:

- The current path will be used to search for the program at the time the function is invoked.
- *LIBL will be used to search for the program or service program at the time COMMENT, GRANT, LABEL, or REVOKE operations are performed on the function.

The validity of the name is checked at the application server. If the format of the name is not correct, an error is returned.

The program, service program, or Java class need not exist at the time the function is created, but it must exist at the time the function is invoked.

CONNECT, SET CONNECTION, RELEASE, DISCONNECT, COMMIT, ROLLBACK, and SET TRANSACTION statements are not allowed in the external program of the function.

CARDINALITY *bigint*

Specifies an estimate of the expected number of rows to be returned by the function for the database manager to use during optimization. *bigint* must be in the range from 0 to 9 223 372 036 854 775 807 inclusive. The database manager assumes a finite value if CARDINALITY is not specified.

A table function that returns a row every time it is called and never returns the end-of-table condition has infinite cardinality. A query that invokes such a function and requires an eventual end-of-table condition before it can return any data will not return unless interrupted. Table functions that never return the end-of-table condition should not be used in queries involving DISTINCT, GROUP BY, or ORDER BY.

NOT SECURED or SECURED

Specifies whether the function is considered secure for row access control and column access control.

NOT SECURED

Specifies that the function is considered not secure for row access control and column access control. This is the default.

When the function is invoked, the arguments of the function must not reference a column for which a column mask is enabled when the table is using active column access control.

SECURED

Specifies that the function is considered secure for row access control and column access control. This option can be used for an external function that is written in C, C++, ILE RPG, ILE COBOL, ILE CL, or Java. The program or service program must exist when the CREATE FUNCTION statement is executed.

A function must be defined as secure when it is referenced in a row permission or a column mask.

SET OPTION-statement

Specifies the options that will be used parameter defaults. The default values for the options depend on the options in effect at create time. For more information, see [“SET OPTION” on page 1505](#).

The following options are used when processing default value expressions: ALWCPYCTA, CONACC, DATFMT, DATSEP, DECFLTRND, DECMPT, DECRESULT, DFTRDBCOL, LANGID, SQLCURRULE, SQLPATH, SRTSEQ, TGTRLS, TIMFMT, and TIMSEP. The options CNULRQD, CNULIGN, COMPILEOPT, EXTIND, NAMING, and SQLCA are not allowed in the CREATE FUNCTION statement. Other options are accepted but will be ignored.

Notes

General considerations for defining user-defined functions: See [“CREATE FUNCTION” on page 965](#) for general information about defining user-defined functions.

REPLACE rules: When an external function is recreated by REPLACE:

- Any existing comment or label is discarded.
- If a different external program is specified:
 - Authorized users are not copied to the new program.
 - Journal auditing is not changed.
- Otherwise:
 - Authorized users are maintained. The object owner will not change.
 - Current journal auditing is not changed.

Creating the function: When an external function associated with an ILE external program or service program is created, an attempt is made to save the function's attributes in the associated program or service program object. If the *PGM or *SRVPGM object is saved and then restored to this or another system, the attributes are used to update the catalogs.

The attributes can be saved for external functions subject to the following restrictions:

- The external program library must not be SYSIBM, QSYS, or QSYS2.

- The external program must exist when the CREATE FUNCTION statement is issued.

If system naming is specified and the external program name is not qualified, the external program must be found in the library list.

- The external program must be an ILE *PGM or *SRVPGM object.

If the object cannot be updated, the function will still be created.

Invoking the function: When an external function is invoked, it runs in whatever activation group was specified when the external program or service program was created. However, ACTGRP(*CALLER) should normally be used so that the function runs in the same activation group as the calling program. ACTGRP(*NEW) is not allowed.

LANGUAGE JAVA functions always run in the default activation group (*DFTACTGRP). Caution should be used when writing MODIFIES SQL DATA Java functions. Since changes performed by the Java function are performed in the default activation group, transaction problems may occur if the invoker runs in a new activation group (*NEW).

Notes for Java functions: To be able to run Java functions, you must have the IBM Developer Kit for Java (5770-JV1) installed on your system. Otherwise, an SQLCODE of -443 will be returned and a CPDB521 message will be placed in the job log.

If an error occurs while running a Java function, an SQLCODE of -443 will be returned. Depending on the error, other messages may exist in the job log of the job where the function was run.

Syntax alternatives: The following keywords are synonyms supported for compatibility to prior releases. These keywords are non-standard and should not be used:

- The keywords VARIANT and NOT VARIANT can be used as synonyms for NOT DETERMINISTIC and DETERMINISTIC.
- The keywords NULL CALL and NOT NULL CALL can be used as synonyms for CALLED ON NULL INPUT and RETURNS NULL ON NULL INPUT.
- The value DB2GENRL may be used as a synonym for DB2GENERAL.
- The keywords PARAMETER STYLE in the PARAMETER STYLE clause are optional.
- The keywords IS DETERMINISTIC may be used as a synonym for DETERMINISTIC.
- The keywords PARAMETER STYLE DB2SQL may be used as a synonym for PARAMETER STYLE SQL.

Example

The following creates a table function written to return a row consisting of a single document identifier column for each known document in a text management system. The first parameter matches a given subject area and the second parameter contains a given string.

Within the context of a single session, the UDF will always return the same table, and therefore it is defined as DETERMINISTIC. Note the RETURNS clause which defines the output from DOCMATCH. FINAL CALL must be specified for each table function. Although the size of the output for DOCMATCH is highly variable, CARDINALITY 20 is a representative value, and is specified to help the optimizer.

```
CREATE FUNCTION DOCMATCH (VARCHAR(30), VARCHAR(255))
  RETURNS TABLE (DOCID CHAR(16))
  EXTERNAL NAME 'MYLIB/RAJIV(UDFMATCH) '
  LANGUAGE C
  PARAMETER STYLE SQL
  NO SQL
  DETERMINISTIC
  NO EXTERNAL ACTION
  NOT FENCED
  SCRATCHPAD
  FINAL CALL
  DISALLOW PARALLEL
  CARDINALITY 20
```

CREATE FUNCTION (sourced)

This CREATE FUNCTION (sourced) statement defines a user-defined function, based on another existing scalar or aggregate function, at the current server.

Invocation

This statement can be embedded in an application program or issued interactively. It is an executable statement that can be dynamically prepared.

Authorization

The privileges held by the authorization ID of the statement must include at least one of the following:

- The privilege to create in the schema. For more information, see [Privileges necessary to create in a schema](#).
- Database administrator authority

The privileges held by the authorization id of the statement must include at least one of the following:

- For the SYSFUNCS catalog view and SYSPARMS catalog table:
 - The INSERT privilege on the table, and
 - The USAGE privilege on schema QSYS2
- Database administrator authority

If the source function is a user-defined function, the authorization ID of the statement must include at least one of the following for the source function:

- The EXECUTE privilege on the function
- Database administrator authority

To create a sourced function, the privileges held by the authorization ID of the statement must also include at least one of the following:

- The following system authorities:
 - *USE to the Create Service Program (CRTSRVPGM) command or
 - *USE to the Create Program (CRTPGM) command
- Database administrator authority

If SQL names are specified and a user profile exists that has the same name as the library into which the function is created, and that name is different from the authorization ID of the statement, then the privileges held by the authorization ID of the statement must include at least one of the following:

- The system authority *ADD to the user profile with that name
- Database administrator authority

If a distinct type is referenced, the privileges held by the authorization ID of the statement must include at least one of the following:

- For each distinct type identified in the statement:
 - The USAGE privilege on the distinct type, and
 - The USAGE privilege on the schema containing the distinct type
- Database administrator authority

For information about the system authorities corresponding to SQL privileges, see [Corresponding System Authorities When Checking Privileges to a Table or View](#), [Corresponding System Authorities When Checking Privileges to a Function or Procedure](#), and [Corresponding System Authorities When Checking Privileges to a Distinct Type](#).

Syntax

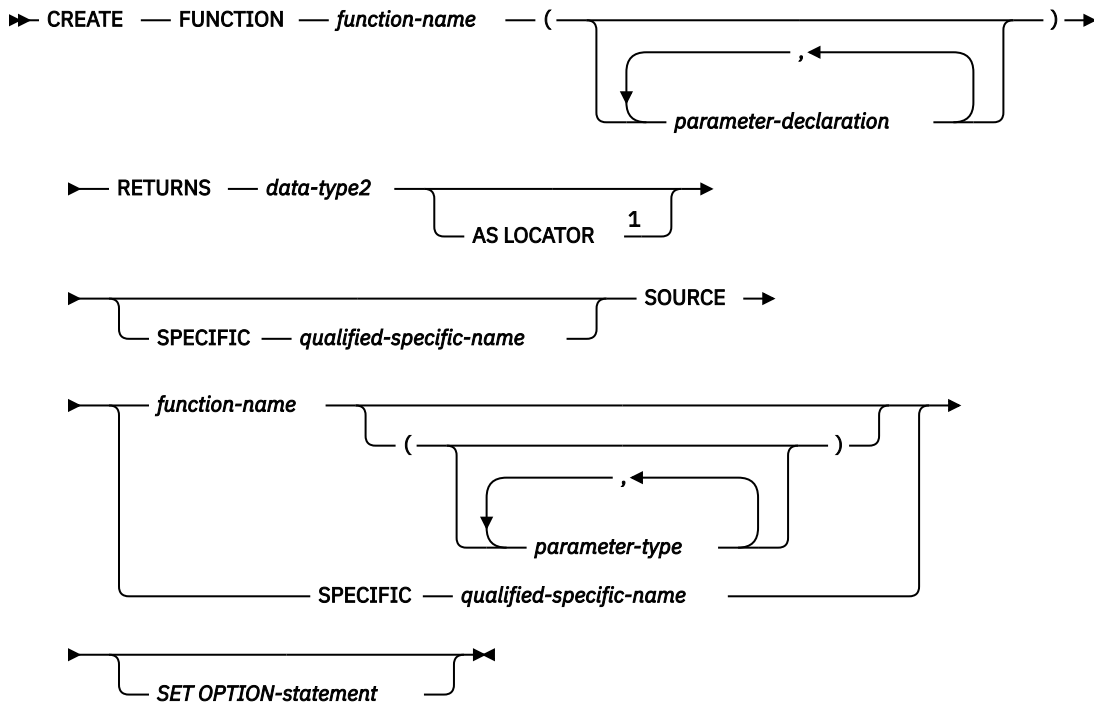

parameter-declaration



data-type1, data-type2, data-type3

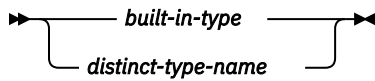

Notes:

¹ The RETURNS, SPECIFIC, and SOURCE clauses can be specified in any order.

built-in-type

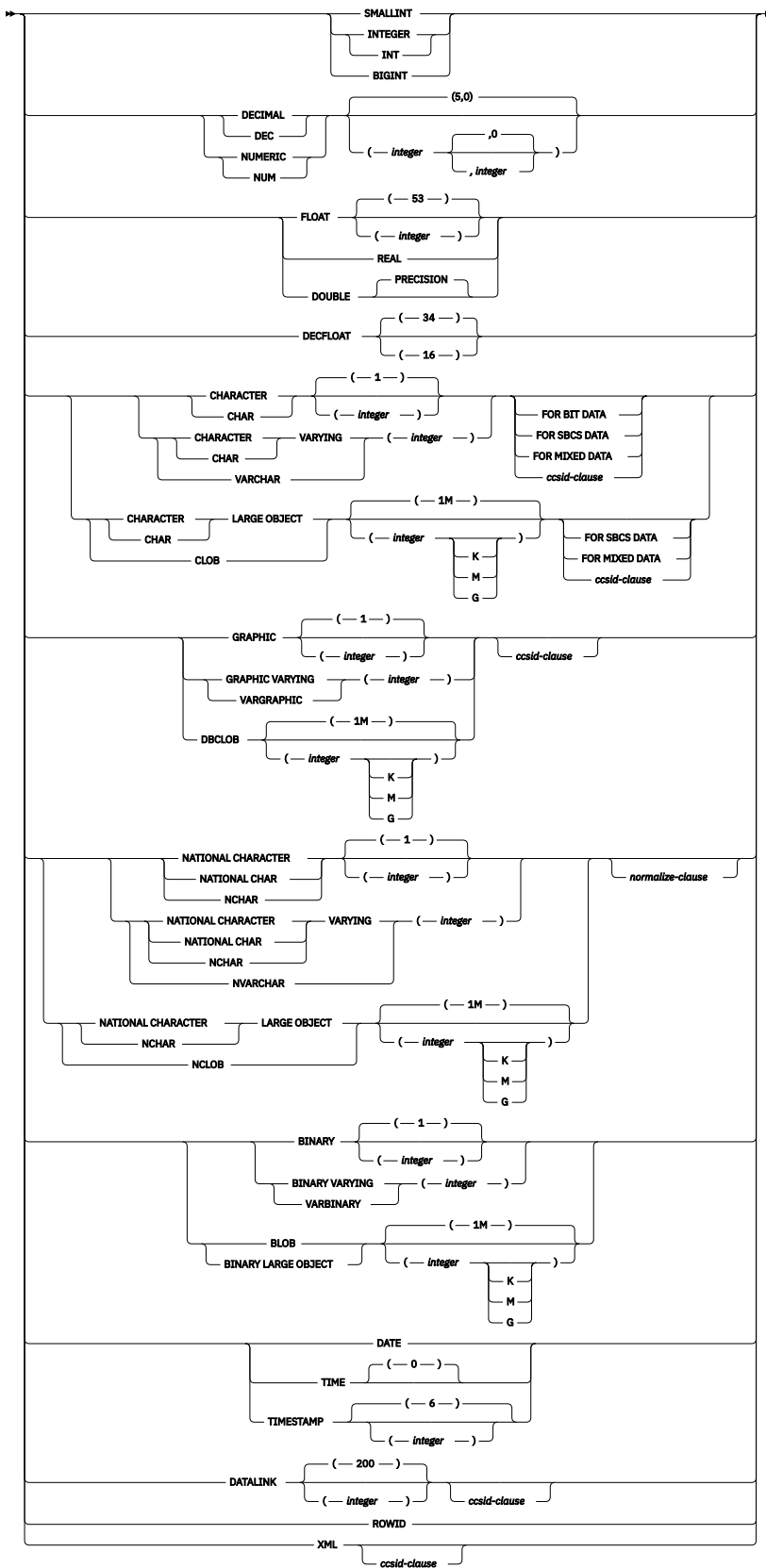

ccsid-clause

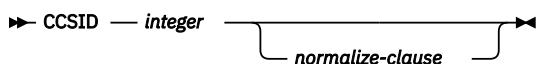

normalize-clause



default-clause

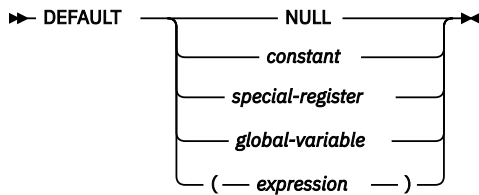

parameter-type

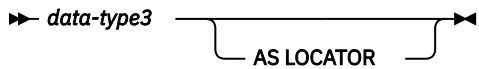

Description

function-name

Names the user-defined function. The combination of name, schema name, the number of parameters, and the data type of each parameter (without regard for any length, precision, scale, or CCSID attributes of the data type) must not identify a user-defined function that exists at the current server unless OR REPLACE is specified.

For SQL naming, the function will be created in the schema specified by the implicit or explicit qualifier.

For system naming, the function will be created in schema that is specified by the qualifier. If no qualifier is specified:

- If the value of the CURRENT SCHEMA special register is *LIBL, the function will be created in the current library (*CURLIB).
- Otherwise, the function will be created in the current schema.

If the function is sourced on an existing function to enable the use of the existing function with a distinct type, the name can be the same name as the existing function. In general, more than one function can have the same name if the function signature of each function is unique.

Certain function names are reserved for system use. For more information see Choosing the schema and function name in [“CREATE FUNCTION” on page 965](#).

(parameter-declaration,...)

Specifies the number of input parameters of the function and the data type of each parameter. Each *parameter-declaration* specifies an input parameter for the function. A maximum of 2000 parameters can be specified. A function can have zero or more input parameters. There must be one entry in the list for each parameter that the function expects to receive. All the parameters for a function are input parameters and are nullable. In the case of JAVA, numeric parameters other than the DECIMAL and NUMERIC types are not nullable. A runtime error will occur if a null value is input to such a parameter for a CALLED ON NULL INPUT function. For more information, see Defining the parameters in [“CREATE FUNCTION” on page 965](#).

parameter-name

Names the parameter. Although not required, a parameter name can be specified for each parameter. The name cannot be the same as any other *parameter-name* in the parameter list.

data-type1

Specifies the data type of the parameter. The data type can be a built-in data type or a distinct data type. It cannot be an array type.

Any valid SQL data type may be used, provided that it is castable to the type of the corresponding parameter of the function identified in the SOURCE clause (for information, see [“Casting between data types” on page 87](#)). However, this checking does not guarantee that an error will not occur when the function is invoked. For more information, see [Considerations for invoking a sourced user-defined function](#).

built-in-type

The data type of the input parameter is a built-in data type. See [“CREATE TABLE” on page 1105](#) for a more complete description of each built-in data type.

distinct-type-name

The data type of the input parameter is a distinct type. The length, precision, or scale attributes for the parameter are those of the source type of the distinct type (those specified on CREATE TYPE). See [“CREATE TYPE \(distinct\)” on page 1184](#) for more information.

If the name of the distinct type is specified without a schema name, the database manager resolves the schema name by searching the schemas in the SQL path.

DataLinks are not allowed for functions sourced on external functions.

If a CCSID is specified, the parameter is converted to that CCSID prior to passing it to the function. If a CCSID is not specified, the CCSID is determined by the default CCSID at the current server at the time the function is invoked.

AS LOCATOR

Specifies that the input parameter is a locator to the value rather than the actual value. You can specify AS LOCATOR only if the input parameter has a LOB data type or a distinct type based on a LOB data type. If AS LOCATOR is specified, FOR SBCS DATA or FOR MIXED DATA must not be specified.

For more information on the AS LOCATOR clause, see [Specifying AS LOCATOR for a parameter in “CREATE FUNCTION” on page 965](#).

default-clause

Specifies a default value for the parameter. The default can be a constant, a special register, a global variable, an expression, or the keyword NULL. The expression is any expression defined in [“Expressions” on page 159](#), that does not include an aggregate function or column name. If a default value is not specified, the parameter has no default and cannot be omitted on invocation. The maximum length of the expression string is 64K.

The default expression must be assignment compatible to the parameter data type.

Any comma in the default expression that is intended as a separator of numeric constants in a list must be followed by a space.

All objects referenced in a default expression must exist when the function is created.

A default cannot be specified for a parameter of type array.

RETURNS

Specifies the result of the function.

data-type2

Specifies the data type of the column. The column is nullable. The data type can be a built-in data type (except LONG VARCHAR, LONG VARGRAPHIC, or a DataLink) or distinct type (that is not based on a DataLink). It cannot be an array type.

Any valid SQL data type can be used provided it is castable from the result type of the source function. (For information about casting data types, see [“Casting between data types” on page 87](#)) However, this checking does not guarantee that an error will not occur when this new function is invoked. For more information, see [Considerations for invoking a sourced user-defined function](#).

AS LOCATOR

Specifies that the function returns a locator to the value rather than the actual value. You can specify AS LOCATOR only if the output from the function has a LOB data type or a distinct type

based on a LOB data type. If AS LOCATOR is specified, FOR SBCS DATA or FOR MIXED DATA must not be specified. The AS LOCATOR clause is not allowed for functions sourced on SQL functions.

For more information on the AS LOCATOR clause, see [Specifying AS LOCATOR for a parameter in “CREATE FUNCTION” on page 965.](#)

SPECIFIC *qualified-specific-name*

Specifies a unique name for the function. For more information on specific names, see [Specifying a specific name for a function in “CREATE FUNCTION” on page 965.](#)

SOURCE

Specifies that the new function is being defined as a sourced function. A *sourced function* is implemented by another function (the *source function*). The function must be a scalar or aggregate function that exists at the current server, and it must be one of the following types of functions:

- A function that was defined with a CREATE FUNCTION statement
- A cast function that was generated by a CREATE TYPE statement
- A built-in function

If the source function is not a built-in function, the particular function can be identified by its name, function signature, or specific name.

If the source function is a built-in function, the SOURCE clause must include a function signature for the built-in function. The source function must not be any of the following built-in functions (If a particular syntax is shown, only the indicated form cannot be specified.):

- ARRAY_AGG
- BINARY when more than one argument is specified
- BLOB when more than one argument is specified
- CARDINALITY
- CHAR when more than one argument is specified
- CLOB when more than one argument is specified
- COALESCE
- CONTAINS
- DATAPARTITIONNAME
- DATAPARTITIONNUM
- DBCLOB when more than one argument is specified
- DBPARTITIONNAME
- DBPARTITIONNUM
- DECFLOAT when more than one argument is specified
- DECIMAL when more than one argument is specified
- DECRYPT_BIN when more than one argument is specified
- DECRYPT_BINARY when more than one argument is specified
- DECRYPT_BIT when more than one argument is specified
- DECRYPT_CHAR when more than one argument is specified
- DECRYPT_DB when more than one argument is specified
- EXTRACT
- GRAPHIC when more than one argument is specified
- GREATEST
- HASH_VALUES
- HASHED_VALUE
- LAND

- LEAST
- LOR
- MAX
- MAX_CARDINALITY
- MIN
- NODENAME
- NODENUMBER
- NVL
- PARTITION
- PERCENTILE_CONT
- PERCENTILE_DISC
- POSITION
- RAISE_ERROR
- RID
- RRN
- SCORE
- SECOND when more than one argument is specified
- STRIP
- SUBSTRING
- TIMESTAMP when the second argument is an integer
- TIMESTAMP_FORMAT when more than two arguments are specified
- TO_CLOB when more than one argument is specified
- TO_DATE when more than two arguments are specified
- TO_TIMESTAMP when more than two arguments are specified
- TRANSLATE when more than one argument is specified
- TRIM
- TRIM_ARRAY
- VALUE
- VARBINARY when more than one argument is specified
- VARCHAR when more than one argument is specified
- VARGRAPHIC when more than one argument is specified
- VERIFY_GROUP_FOR_USER when more than two arguments are specified
- XMLAGG
- XMLATTRIBUTES
- XMLCOMMENT
- XMLCONCAT
- XMLDOCUMENT
- XMLELEMENT
- XMLFOREST
- XMLGROUP
- XMLNAMESPACES
- XMLPARSE
- XMLPI

- XMLROW
- XMLSERIALIZE
- XMLTEXT
- XMLVALIDATE
- XOR
- XSLTRANSFORM
- ZONED when more than one argument is specified

function-name

Identifies the function to be used as the source function by its function name. The source function can be defined with any number of parameters. If more than one function is defined with the specified name in the specified or implicit schema, an error is returned.

If an unqualified *function-name* is specified, the SQL path is used to locate the function. The database manager selects the first schema that has only one function with this name on which the user has EXECUTE authority. An error is returned if a function is not found, or if the database manager encounters a schema that has more than one function with this name.

function-name (parameter-type, ...)

Identifies the function to be used as the source function by its function signature, which uniquely identifies the function. The *function-name (parameter-type,...)* must identify a function with the specified signature at the current server. The specified parameters must match the data types in the corresponding position that were specified when the function was created. The number of data types, and the logical concatenation of the data types is used to identify the specific function instance. Synonyms for data types are considered a match. Parameters that have defaults must be included in this signature.

If *function-name()* is specified, the function identified must have zero parameters.

To use a built-in function as the source function, this syntax variation must be used.

function-name

Identifies the name of the source function. If an unqualified name is specified, the schemas of the SQL path are searched. Otherwise, the database manager searches for the function in the specified schema.

parameter-type,...

Identifies the parameters of the function.

If an unqualified distinct type name is specified, the database manager searches the SQL path to resolve the schema name for the distinct type.

Empty parentheses are allowed for some data types that are specified in this context. For data types that have a length, precision or scale attribute, use one of the following specifications:

- Empty parentheses indicate that the database manager ignores the attribute when determining whether the data types match. For example, DEC() will be considered a match for a parameter of a function defined with a data type of DEC(7,2).
- If a specific value for a length, precision, or scale attribute is specified, the value must exactly match the value that was specified (implicitly or explicitly) in the CREATE FUNCTION statement. If the data type is FLOAT, the precision does not have to exactly match the value that was specified because matching is based on the data type (REAL or DOUBLE).
- If length, precision, or scale is not explicitly specified, and empty parentheses are not specified, the default attributes of the data type are implied. The implicit length must exactly match the value that was specified (implicitly or explicitly) in the CREATE FUNCTION statement.

For data types with a subtype or CCSID attribute, specifying the FOR DATA clause or CCSID clause is optional. Omission of either clause indicates that the database manager ignores the attribute when determining whether the data types match. If you specify either clause, it must match the value that was implicitly or explicitly specified in the CREATE FUNCTION statement.

AS LOCATOR

Specifies that the function is defined to receive a locator for this parameter. If AS LOCATOR is specified, the data type must be a LOB or a distinct type based on a LOB. If AS LOCATOR is specified, FOR SBCS DATA or FOR MIXED DATA must not be specified. If AS LOCATOR is specified and a length is explicitly specified, the data type length is ignored.

For more information on the AS LOCATOR clause, see [Specifying AS LOCATOR for a parameter in “CREATE FUNCTION” on page 965](#).

SPECIFIC *qualified-specific-name*

Identifies the function to be used as the source function by its specific name. The *qualified-specific-name* must identify a specific function that exists in the specified schema.

SET OPTION-statement

Specifies the options that will be used for parameter defaults. The default values for the options depend on the options in effect at create time. For more information, see [“SET OPTION” on page 1505](#). The following options are used when processing default value expressions: ALWCPYDTA, CONACC, DATFMT, DATSEP, DECFLTRND, DECMPT, DECRESULT, DFTRDBCOL, LANGID, SQLCURRULE, SQLPATH, SRTSEQ, TGTRLS, TIMFMT, and TIMSEP. The options CNULRQD, CNULIGN, COMPILEOPT, EXTIND, NAMING, and SQLCA are not allowed in the CREATE FUNCTION statement. Other options are accepted but will be ignored.

The number of input parameters in the function that is being created must be the same as the number of parameters in the source function. If the data type of each input parameter is not the same as or castable to the corresponding parameter of the source function, an error occurs. The data type of the final result of the source function must match or be castable to the result of the sourced function.

If a CCSID is specified and the CCSID of the return data is encoded in a different CCSID, the data is converted to the specified CCSID.

If a CCSID is not specified the return data is converted to the CCSID of the job (or associated graphic CCSID of the job for graphic string return values), if the CCSID of the return data is encoded in a different CCSID. To avoid any potential loss of characters during the conversion, consider explicitly specifying a CCSID that can represent any characters that will be returned from the function. This is especially important if the data type is graphic string data. In this case, consider using CCSID 1200 or 13488 (Unicode graphic string data).

Notes

General considerations for defining user-defined functions: See [“CREATE FUNCTION” on page 965](#) for general information about defining user-defined functions.

Function ownership: If SQL names were specified:

- If a user profile with the same name as the schema into which the function is created exists, the *owner* of the function is that user profile.
- Otherwise, the *owner* of the function is the user profile or group user profile of the thread executing the statement.

If system names were specified, the *owner* of the function is the user profile or group user profile of the thread executing the statement.

Function authority: If SQL names are used, functions are created with the system authority of *EXCLUDE on *PUBLIC. If system names are used, functions are created with the authority to *PUBLIC as determined by the create authority (CRTAUT) parameter of the schema.

If the owner of the function is a member of a group profile (GRPPRF keyword) and group authority is specified (GRPAUT keyword), that group profile will also have authority to the function.

Considerations for invoking a sourced user-defined function: When a sourced function is invoked, each argument to the function is assigned to the associated parameter defined for the function. The values are then cast (if necessary) to the data type of the corresponding parameters of the underlying function. An error can occur either in the assignment or in the cast. For example: an argument passed on input to a

function that matches the data type and length or precision attributes of the parameter for the function might not be castable if the corresponding parameter of the underlying source function has a shorter length or less precision. It is recommended that the data types of the parameters of a sourced function be defined with attributes that are less than or equal to the attributes of the corresponding parameters of the underlying function.

The result of the underlying function is assigned to the RETURNS data type of the sourced function. The RETURNS data type of the underlying function might not be castable to the RETURNS data type of the source function. This can occur when the RETURNS data type of this new source function has a shorter length or less precision than the RETURNS data type of the underlying function. For example, an error would occur when function A is invoked assuming the following functions exist. Function A returns an INTEGER. Function B is a sourced function, is defined to return a SMALLINT, and the definition references function A in the SOURCE clause. It is recommended that the RETURNS data type of a sourced function be defined with attributes that are the same or greater than the attributes defined for the RETURNS data type of the underlying function.

Considerations when the function is based on a user-defined function: If the sourced function is based directly or indirectly on an external scalar function, the sourced function inherits the attributes of the external scalar function. This can involve several layers of sourced functions. For example, assume that function A is sourced on function B, which in turn is sourced on function C. Function C is an external scalar function. Functions A and B inherit all of the attributes for function C.

The sourced function inherits the secure attribute from the user-defined function it is directly based on. A sourced function based on a built-in function is always secure.

Creating the function: When a sourced function is created, a small service program object is created that represents the function. When this service program is saved and restored to another system, the attributes from the CREATE FUNCTION statement are automatically added to the catalog on that system.

Examples

Example 1: Assume that strongly typed distinct type HATSIZE is defined and is based on the built-in data type INTEGER. An AVG function could be defined to compute the average hat size of different departments. Create a sourced function that is based on built-in function AVG.

```
CREATE FUNCTION AVG (HATSIZE)
  RETURNS HATSIZE
  SOURCE AVG (INTEGER)
```

The syntax of the SOURCE clause includes an explicit parameter list because the source function is a built-in function.

When distinct type HATSIZE was created, two cast functions were generated, which allow HATSIZE to be cast to INTEGER for the argument and INTEGER to be cast to HATSIZE for the result of the function.

Example 2: After Smith created the external scalar function CENTER in his schema, there is a need to use this function, but the invocation of the function needs to accept two INTEGER arguments instead of one INTEGER argument and one DOUBLE argument. Create a sourced function that is based on CENTER.

```
CREATE FUNCTION MYCENTER (INTEGER, INTEGER)
  RETURNS DOUBLE
  SOURCE SMITH.CENTER (INTEGER, DOUBLE);
```

CREATE FUNCTION (SQL scalar)

This CREATE FUNCTION (SQL scalar) statement creates an SQL function at the current server. The function returns a single result.

Invocation

This statement can be embedded in an application program or issued interactively. It is an executable statement that can be dynamically prepared.

Authorization

The privileges held by the authorization ID of the statement must include at least one of the following:

- The privilege to create in the schema. For more information, see [Privileges necessary to create in a schema](#).
- Database administrator authority

The privileges held by the authorization id of the statement must include at least one of the following:

- For the SYSFUNCS catalog view and SYSPARMS catalog table:
 - The INSERT privilege on the table, and
 - The USAGE privilege on schema QSYS2
- Database administrator authority

The privileges held by the authorization ID of the statement must also include at least one of the following:

- The following system authorities:
 - *USE to the Create Service Program (CRTSRVPGM) command or
- Database administrator authority

If a distinct type is referenced, the privileges held by the authorization ID of the statement must include at least one of the following:

- For each distinct type identified in the statement:
 - The USAGE privilege on the distinct type, and
 - The USAGE privilege on the schema containing the distinct type
- Database administrator authority

If the SECURED attribute is specified, or the function is secure and OR REPLACE is specified:

- The authorization ID of the statement must have security administrator authority. See [“Administrative authority”](#) on page 15.

To replace an existing function, the privileges held by the authorization ID of the statement must include at least one of the following:

- The following system authorities:
 - The system authority of *OBJMGT on the service program object associated with the function
 - All authorities needed to DROP the function
 - The system authority *READ to the SYSFUNCS catalog view and SYSPARMS catalog table
- Database administrator authority

For information about the system authorities corresponding to SQL privileges, see [Corresponding System Authorities When Checking Privileges to a Table or View](#) and [Corresponding System Authorities When Checking Privileges to a Distinct Type](#).

Syntax

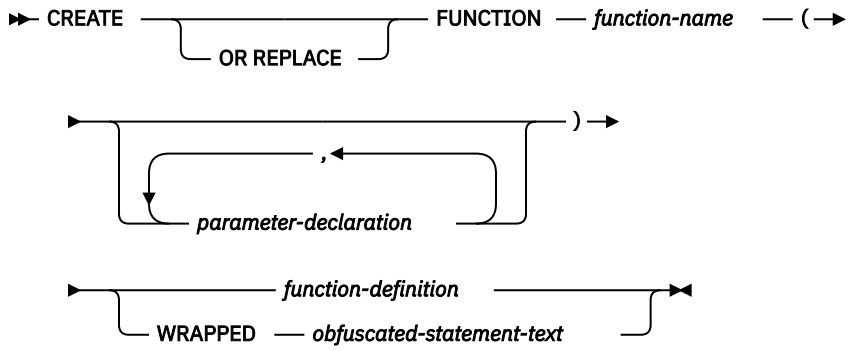

function-definition

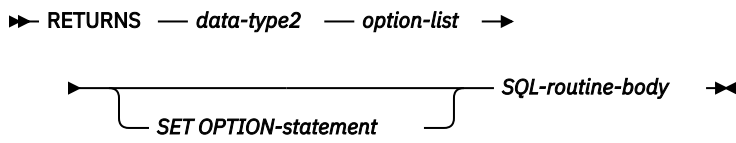

parameter-declaration

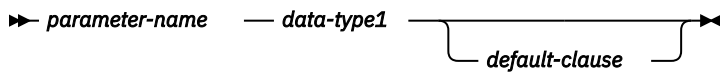

data-type1, data-type2

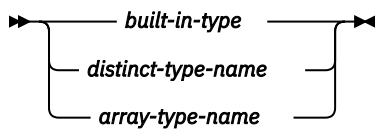

built-in-type

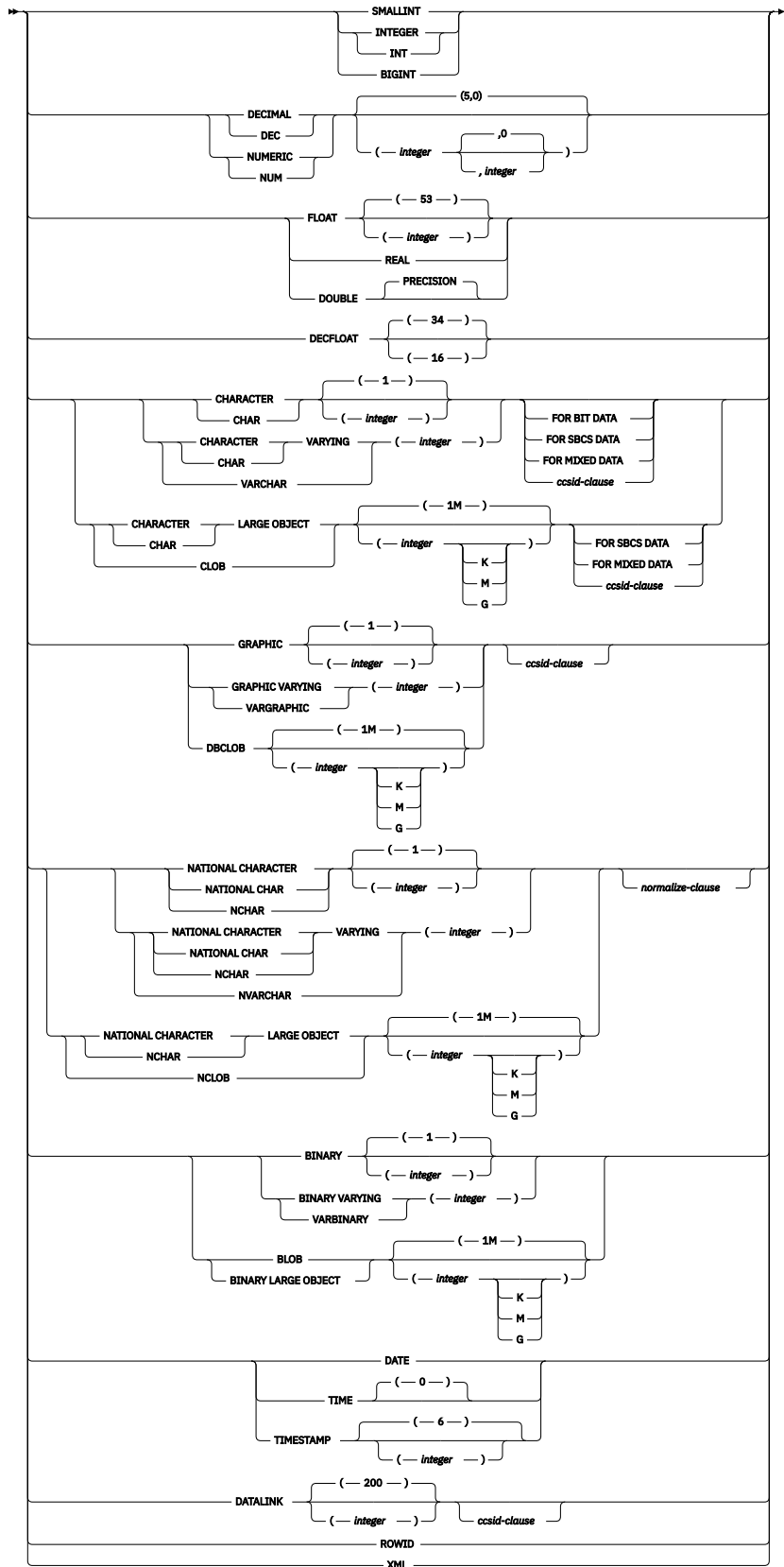

ccsid-clause

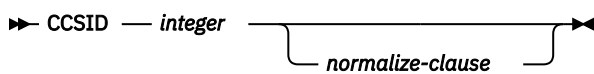

normalize-clause

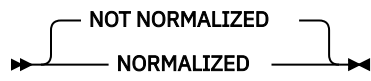

default-clause

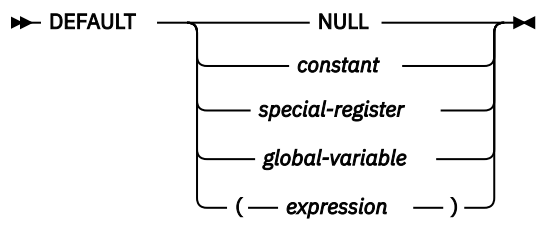

option-list

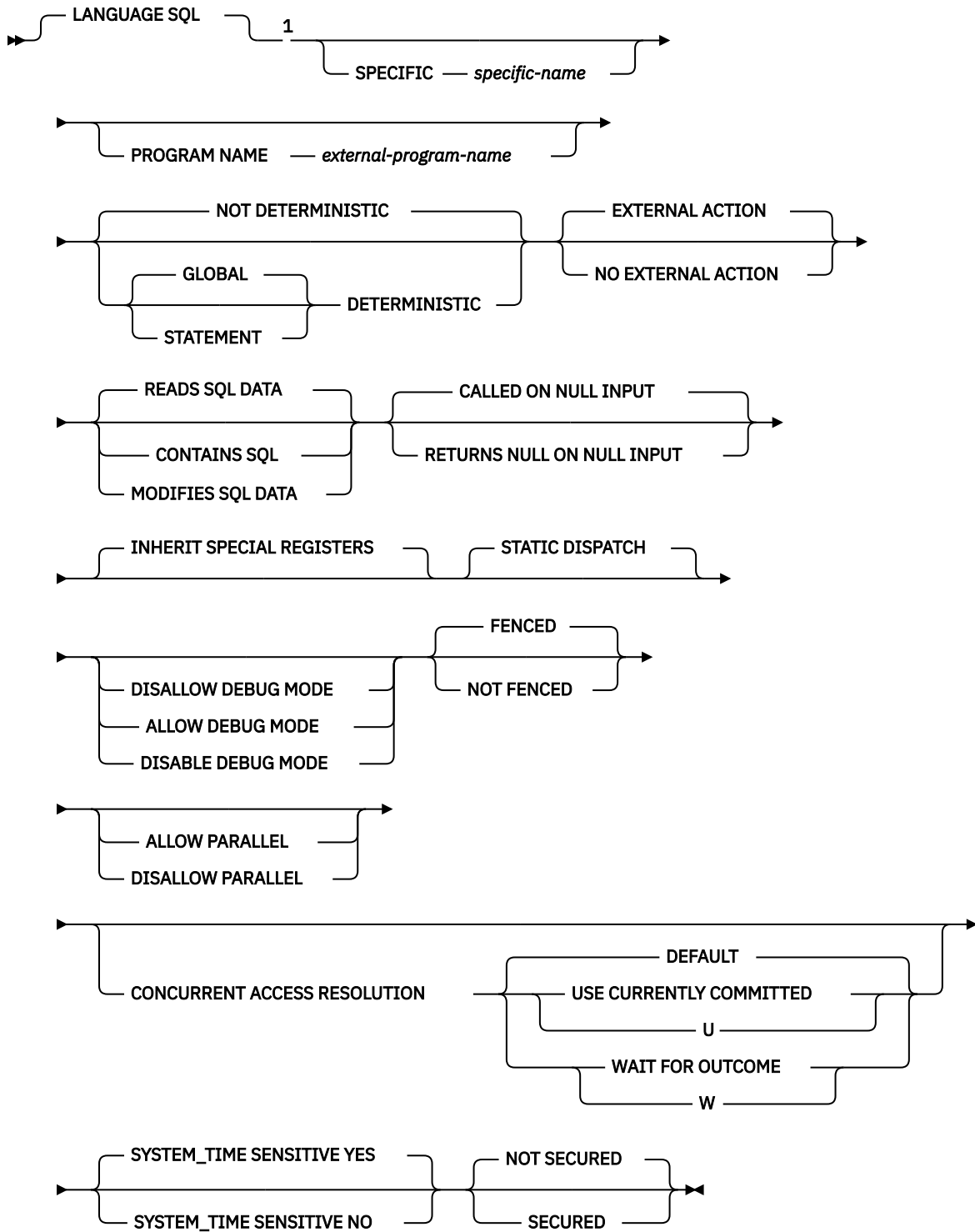

Notes:

¹ This clause and the clauses that follow in the option-list can be specified in any order. Each clause can be specified at most once.

SQL-routine-body

➤ *SQL-control-statement* ➤

Description

OR REPLACE

Specifies to replace the definition for the function if one exists at the current server. The existing definition is effectively dropped before the new definition is replaced in the catalog with the exception that privileges that were granted on the function are not affected. This option is ignored if a definition for the function does not exist at the current server. To replace an existing function, the *specific-name* and *function-name* of the new definition must be the same as the *specific-name* and *function-name* of the old definition, or the signature of the new definition must match the signature of the old definition. Otherwise, a new function is created.

function-name

Names the user-defined function. The combination of name, schema name, the number of parameters, and the data type of each parameter (without regard for any length, precision, scale, or CCSID attributes of the data type) must not identify a user-defined function that exists at the current server unless OR REPLACE is specified.

For SQL naming, the function will be created in the schema specified by the implicit or explicit qualifier.

For system naming, the function will be created in the schema that is specified by the qualifier. If no qualifier is specified:

- If the value of the CURRENT SCHEMA special register is *LIBL, the function will be created in the current library (*CURLIB).
- Otherwise, the function will be created in the current schema.

In general, more than one function can have the same name if the function signature of each function is unique.

Certain function names are reserved for system use. For more information see Choosing the schema and function name in [“CREATE FUNCTION”](#) on page 965.

(parameter-declaration,...)

Specifies the number of input parameters of the function and the data type of each parameter. Each *parameter-declaration* specifies an input parameter for the function. A maximum of 2000 parameters can be specified. A function can have zero or more input parameters. There must be one entry in the list for each parameter that the function expects to receive. All the parameters for a function are input parameters and are nullable. For more information, see Defining the parameters in [“CREATE FUNCTION”](#) on page 965.

parameter-name

Names the parameter. The name is used to refer to the parameter within the body of the function. The name cannot be the same as any other *parameter-name* in the parameter list.

data-type1

Specifies the data type of the input parameter. The data type can be a built-in data type or a distinct data type.

built-in-type

Specifies a built-in data type. For a more complete description of each built-in data type, see [“CREATE TABLE”](#) on page 1105.

distinct-type-name

Specifies a distinct type. The length, precision, or scale attributes for the parameter are those of the source type of the distinct type (those specified on CREATE TYPE). For more information about creating a distinct type, see [“CREATE TYPE \(distinct\)”](#) on page 1184.

If the name of the distinct type is unqualified, the database manager resolves the schema name by searching the schemas in the SQL path.

array-type-name

Specifies an array type.

If the name of the array type is unqualified, the database manager resolves the schema name by searching the schemas in the SQL path.

If a CCSID is specified, the parameter is converted to that CCSID prior to passing it to the function. If a CCSID is not specified, the CCSID is determined by the default CCSID at the current server at the time the function is invoked.

A parameter that is an array of XML or LOB type is read only.

default-clause

Specifies a default value for the parameter. The default can be a constant, a special register, a global variable, an expression, or the keyword NULL. The expression is any expression defined in “Expressions” on page 159, that does not include an aggregate function or column name. If a default value is not specified, the parameter has no default and cannot be omitted on invocation. The maximum length of the expression string is 64K.

The default expression must be assignment compatible to the parameter data type.

Any comma in the default expression that is intended as a separator of numeric constants in a list must be followed by a space.

All objects referenced in a default expression must exist when the function is created.

A default cannot be specified for a parameter of type array.

RETURNS

Specifies the result of the function.

data-type2

Specifies the expression that is to be returned for the function. The result data type of the expression must be assignable (using storage assignment rules) to the data type that is defined in the RETURNS clause. For more information, see “Assignments and comparisons” on page 91.

You can specify any built-in data type (except LONG VARCHAR, or LONG VARGRAPHIC), a distinct type, or an array type.

If a CCSID is specified and the CCSID of the return data is encoded in a different CCSID, the data is converted to the specified CCSID.

If a CCSID is not specified, the return data is converted to the CCSID of the job (or associated graphic CCSID of the job for graphic string return values), if the CCSID of the return data is encoded in a different CCSID. To avoid any potential loss of characters during the conversion, consider explicitly specifying a CCSID that can represent any characters that will be returned from the function. This is especially important if the data type is graphic string data. In this case, consider using CCSID 1200 or 13488 (Unicode graphic string data).

LANGUAGE SQL

Specifies that this is an SQL function.

SPECIFIC specific-name

Specifies a unique name for the function. For more information on specific names, see Specifying a specific name for a function in “CREATE FUNCTION” on page 965.

PROGRAM NAME *external-program-name*

Specifies the unqualified name of the service program to be created for the function. *external-program-name* must be a valid system name.

GLOBAL DETERMINISTIC or STATEMENT DETERMINISTIC or NOT DETERMINISTIC

Specifies whether the function returns the same results each time that the function is invoked with the same input arguments. The default is NOT DETERMINISTIC.

NOT DETERMINISTIC

Specifies that the function might not return the same result each time that the function is invoked with the same input arguments. The function depends on some state values that affect the results. The database manager uses this information during optimization of SQL statements. An example of a function that is not deterministic is one that generates random numbers.

A function that is not deterministic might return incorrect results if the function is executed by parallel tasks. Specify the `DISALLOW PARALLEL` clause for these functions.

`NOT DETERMINISTIC` should be specified if the function contains a reference to a special register, a non-deterministic function, or a sequence.

GLOBAL DETERMINISTIC

Specifies that the function always returns the same result each time that the function is invoked with the same input arguments. The database manager uses this information during optimization of SQL statements. The query optimizer may choose to cache global deterministic scalar function results.⁹³ An example of a global deterministic function is a function that calculates the square root of the input argument.

STATEMENT DETERMINISTIC

Specifies that the function might not return the same result each time that the function is invoked with the same input arguments, but multiple invocations of the function within a single SQL statement are considered deterministic. The query optimizer will not cache statement deterministic scalar function results.⁹⁴ An example of a statement deterministic function is a function that performs currency conversion.

EXTERNAL ACTION or NO EXTERNAL ACTION

Specifies whether the function takes an action that changes the state of an object that the database manager does not manage. An example of an external action is sending a message or writing a record to a stream file. The default is `EXTERNAL ACTION`.

EXTERNAL ACTION

Specifies that the function can take an action that changes the state of an object that the database manager does not manage. Thus, the function must be invoked with each successive function invocation. `EXTERNAL ACTION` should be specified if the function contains a reference to another function that has an external action.

NO EXTERNAL ACTION

The function does not perform an external action. It need not be called with each successive function invocation.

`NO EXTERNAL ACTION` functions might perform better than `EXTERNAL ACTION` functions because they might not be invoked for each successive function invocation.

CONTAINS SQL, READS SQL DATA, or MODIFIES SQL DATA

Specifies the classification of SQL statements and nested routines that the function can execute. The database manager verifies that the SQL statements issued by the function, and all routines locally invoked by the function, are consistent with this specification. The verification is not performed when nested remote routines are invoked. For the classification of each statement, see [Appendix B, "Characteristics of SQL statements,"](#) on page 1643. The default is `READS SQL DATA`. This option applies to any parameter default expressions.

READS SQL DATA

Specifies that the function can execute statements with a data access classification of `READS SQL DATA`, `CONTAINS SQL`, or `NO SQL`. The function cannot execute SQL statements that modify data.

CONTAINS SQL

Specifies that the function can execute only SQL statements with a data access classification of `CONTAINS SQL` or `NO SQL`. The function cannot execute any SQL statements that read or modify data.

⁹³ If the result of the function contains sensitive data, consider using `STATEMENT DETERMINISTIC` or the `DETERMINISTIC_UDF_SCOPE QAQQINI` option or create the function `NOT DETERMINISTIC` to prevent inadvertent access to the result. For more information, see the [Database Performance and Query Optimization](#) topic collection.

⁹⁴ The `DETERMINISTIC_UDF_SCOPE QAQQINI` option can be used to get this same behavior for a `GLOBAL DETERMINISTIC` function. For more information, see the [Database Performance and Query Optimization](#) topic collection.

MODIFIES SQL DATA

The function can execute any SQL statement except those statements that are not supported in any function.

RETURNS NULL ON NULL INPUT or CALLED ON NULL INPUT

Specifies whether the function is called if any of the input arguments is null at execution time.

RETURNS NULL ON INPUT

Specifies that the function is not invoked if any of the input arguments is null. The result is the null value.

CALLED ON NULL INPUT

Specifies that the function is to be invoked if any or all argument values are null. This specification means that the function must be coded to test for null argument values. The function can return a null or nonnull value.

INHERIT SPECIAL REGISTERS

Specifies that existing values of special registers are inherited upon entry to the function.

STATIC DISPATCH

Specifies that the function is dispatched statically. All functions are statically dispatched.

DISALLOW DEBUG MODE, ALLOW DEBUG MODE, or DISABLE DEBUG MODE

Indicates whether the function is created so it can be debugged by the Unified Debugger. If DEBUG MODE is specified, a DBGVIEW option in the SET OPTION statement must not be specified.

DISALLOW DEBUG MODE

The function cannot be debugged by the Unified Debugger. When the DEBUG MODE attribute of the function is DISALLOW, the function can be subsequently altered to change the debug mode attribute.

ALLOW DEBUG MODE

The function can be debugged by the Unified Debugger. When the DEBUG MODE attribute of the function is ALLOW, the function can be subsequently altered to change the debug mode attribute.

DISABLE DEBUG MODE

The function cannot be debugged by the Unified Debugger. When the DEBUG MODE attribute of the function is DISABLE, the function cannot be subsequently altered to change the debug mode attribute.

If FENCED or ALLOW PARALLEL is specified for the function, the DEBUG MODE option will be ignored. DISALLOW DEBUG MODE will be used.

If DEBUG MODE is not specified, but a DBGVIEW option in the SET OPTION statement is specified, the function cannot be debugged by the Unified Debugger, but may be debugged by the system debug facilities. If neither DEBUG MODE nor a DBGVIEW option is specified, the debug mode used is from the CURRENT DEBUG MODE special register.

FENCED or NOT FENCED

Specifies whether the SQL function runs in an environment that is isolated from the database manager environment. FENCED is the default.

FENCED

The function will run in a separate thread.

FENCED functions cannot keep SQL cursors open across individual calls to the function. However, the cursors in one thread are independent of the cursors in any other threads which reduces the possibility of cursor name conflicts.

NOT FENCED

The function may run in the same thread as the invoking SQL statement.

NOT FENCED functions can keep SQL cursors open across individual calls to the function. Since cursors can be kept open, the cursor position will also be preserved between calls to the function. However, cursor names may conflict since the UDF is now running in the same thread as the invoking SQL statement and other NOT FENCED UDFs.

NOT FENCED functions usually perform better than FENCED functions.

ALLOW PARALLEL or DISALLOW PARALLEL

Specifies whether the function can be run in parallel.

The default is DISALLOW PARALLEL if one or more of the following clauses are specified: NOT DETERMINISTIC, EXTERNAL ACTION, or MODIFIES SQL DATA. Otherwise, ALLOW PARALLEL is the default.

ALLOW PARALLEL

Specifies that the database manager can consider parallelism for the function. The database manager is not required to use parallelism on the SQL statement that invokes the function or on any SQL statement issued from within the function.

See the descriptions of NOT DETERMINISTIC, EXTERNAL ACTION, and MODIFIES SQL DATA for considerations that apply to specification of ALLOW PARALLEL.

DISALLOW PARALLEL

Specifies that the database manager must not use parallelism for the function.

CONCURRENT ACCESS RESOLUTION

Specifies whether the database manager should wait for data that is in the process of being updated. DEFAULT is the default.

DEFAULT

Specifies that the concurrent access resolution is not explicitly set for this function. The value that is in effect when the function is invoked will be used.

WAIT FOR OUTCOME

Specifies that the database manager is to wait for the commit or rollback of data in the process of being updated.

USE CURRENTLY COMMITTED

Specifies that the database manager is to use the currently committed version of the data when encountering data that is in the process of being updated.

When the lock contention is between a read transaction and a delete or update transaction, the clause is applicable to scans with isolation level CS (but not for CS KEEP LOCKS).

SYSTEM_TIME SENSITIVE

Determines whether references to system-period temporal tables in both static and dynamic SQL statements are affected by the value of the CURRENT TEMPORAL SYSTEM_TIME special register. YES is the default.

YES

References to system-period temporal tables are affected by the value of the CURRENT TEMPORAL SYSTEM_TIME special register.

NO

References to system-period temporal tables are not affected by the value of the CURRENT TEMPORAL SYSTEM_TIME special register.

NOT SECURED or SECURED

Specifies whether the function is considered secure for row access control and column access control.

NOT SECURED

Specifies that the function is considered not secure for row access control and column access control. This is the default.

When the function is invoked, the arguments of the function must not reference a column for which a column mask is enabled when the table is using active column access control.

SECURED

Specifies that the function is considered secure for row access control and column access control.

A function must be defined as secure when it is referenced in a row permission or a column mask.

WRAPPED *obfuscated-statement-text*

Specifies the encoded definition of the function. A CREATE FUNCTION statement can be encoded using the WRAP scalar function.

SET OPTION-statement

Specifies the options that will be used to create the function. These options also apply to any default value expressions. For example, to create a debuggable function, the following statement could be included:

```
SET OPTION DBGVIEW = *SOURCE
```

The default values for the options depend on the options in effect at create time. For information about the , see [“SET OPTION” on page 1505](#).

The options CNULRQD, CNULIGN, COMPILEOPT, NAMING, and SQLCA are not allowed in the CREATE FUNCTION statement. The following options are used when processing default value expressions: ALWCOPYDTA, CONACC, DATFMT, DATSEP, DECFLTRND, DECMPT, DECRESULT, DFTRDBCOL, LANGID, SQLCURRULE, SQLPATH, SRTSEQ, TGTRLS, TIMFMT, and TIMSEP.

SQL-routine-body

Specifies a single *SQL-procedure-statement*, including a compound statement. See [“SQL control statements” on page 1569](#) for more information about defining SQL functions.

A call to a procedure that issues a CONNECT, SET CONNECTION, RELEASE, DISCONNECT, COMMIT, ROLLBACK, and SET TRANSACTION statement is not allowed in a function.

If the *SQL-routine-body* is a compound statement, it must contain at least one RETURN statement and a RETURN statement must be executed when the function is called.

ALTER PROCEDURE (SQL), ALTER FUNCTION (SQL scalar), and ALTER FUNCTION (SQL table) with a REPLACE keyword are not allowed in an *SQL-routine-body*.

Notes

General considerations for defining user-defined functions: For general information about defining user-defined functions, see [“CREATE FUNCTION” on page 965](#).

SQL path and function resolution: Resolution of function invocations inside the function body is done according to the SQL path that is in effect for the CREATE FUNCTION statement and does not change after the function is created.

Function ownership: If SQL names were specified:

- If a user profile with the same name as the schema into which the function is created exists, the *owner* of the function is that user profile.
- Otherwise, the *owner* of the function is the user profile or group user profile of the thread executing the statement.

If system names were specified, the *owner* of the function is the user profile or group user profile of the thread executing the statement.

Function authority: If SQL names are used, functions are created with the system authority of *EXCLUDE on *PUBLIC. If system names are used, functions are created with the authority to *PUBLIC as determined by the create authority (CRTAUT) parameter of the schema.

If the owner of the function is a member of a group profile (GRPPRF keyword) and group authority is specified (GRPAUT keyword), that group profile will also have authority to the function.

REPLACE rules: When a function is recreated by REPLACE:

- Any existing comment or label is discarded.
- Authorized users are maintained. The object owner could change.
- Current journal auditing is preserved.

If the function is replaced and the function signature or result data type is altered, the results from any function, materialized query table, procedure, trigger, or view that references the function may be unpredictable. Any referenced objects should be recreated.

Creating the function: When an SQL function is created, the database manager creates a temporary source file that will contain C source code with embedded SQL statements. A *SRVPGM object is then created using the CRTSRVPGM command. The SQL options used to create the service program are the options that are in effect at the time the CREATE FUNCTION statement is executed. The service program is created with ACTGRP(*CALLER).

When an SQL function is created, the function's attributes are stored in the created service program object. If the *SRVPGM object is saved and then restored to this or another system, the attributes are used to update the catalogs.

If the PROGRAM NAME clause is provided, its name is used for the creation of the service program object. Otherwise, the specific name is used to determine the name of the source file member and *SRVPGM object. If the specific name is a valid system name, it will be used as the name of member and program. If the member already exists, it will be overlaid. If a program already exists in the specified library, a unique name is generated using the rules for generating system table names. If the specific name is not a valid system name, a unique name is generated using the rules for generating system table names.

Invoking the function: When an SQL function is invoked, it runs in the activation group of the calling program.

If a function is specified in the *select-list* of a *select-statement* and if the function specifies EXTERNAL ACTION or MODIFIES SQL DATA, the function will only be invoked for each row returned. Otherwise, the UDF may be invoked for rows that are not selected.

Inline functions: When an SQL scalar function is inlined, instead of invoking the function as part of a query, the *expression* in the RETURN statement of the function may be copied (inlined) into the query itself. Such a function is called an *inline function*. A scalar function is an *inline function* if:

- The SQL function is global deterministic.
- The *SQL-routine-body* contains only a RETURN statement.
- No input parameter is an array type.
- The data type of the result is not XML or an array type.
- All objects referenced in the function exist when the function is created.
- The *SQL-routine-body* does not contain a common table expression that references an input parameter.
- The *SQL-routine-body* does not contain a nested table expression without a preceding LATERAL keyword that references an input parameter.

An *inline function* is only copied (inlined) into a query if:

- The query is eligible for the SQL Query Engine (SQE).
- The function references an object and the authority attributes of the function and the query are compatible based on one of the following conditions:
 - The function is defined to run under the user's authority (*USER).
 - The query is running under the owner's authority (*OWNER) and the owner of the query is the same as the owner of the function.
 - The query is running under the user's authority (*USER), and the user or the user's group profile is the same as the owner of the function.

Note: If the function is defined as FENCED, the query must not use adopted authority. If the query runs under the owner's authority (*OWNER) and the function runs under the user's authority (*USER), the owner of the query must be the same as the user or the user's group profile.

When a function is inlined, some of the options specified when the function was created are ignored:

- PARALLEL or NOT PARALLEL
- MODIFIES SQL DATA

- Commitment control level
- CONCURRENT ACCESS RESOLUTION
- ALWCPYDTA
- ATOMIC or NOT ATOMIC

If a function is inlined and it contains a reference to a special register, the value of the special register will be the same as other references to the same special register in the query.

Returning an array from a function: If the return type of a function is an array type, the function can only be invoked from within an SQL function or SQL procedure routine body in one of the following contexts:

- the *select-list* of a SELECT INTO
- the *select-list* of a DECLARE CURSOR
- the *select-list* of a scalar subselect on the right side of a SET statement

A *select-list* that contains a function that returns an array type cannot use the DISTINCT keyword. A query that contains this select list cannot use UNION, EXCEPT, or INTERSECT.

Obfuscated statements: A CREATE FUNCTION statement can be executed in obfuscated form. In an obfuscated statement, only the function name and parameters are readable followed by the WRAPPED keyword. The rest of the statement is encoded in such a way that it is not readable but can be decoded by a database server that supports obfuscated statements. Obfuscated statements can be produced by invoking the WRAP scalar function. Any debug options that are specified when the function is created from an obfuscated statement are ignored. A function that is created from an obfuscated statement cannot be restored to a release where obfuscation is not supported.

Setting of the default value: Parameters of a function that are defined with a default value are set to their default value when the function is invoked, but only if a value is not supplied for the corresponding argument, or the argument is specified as DEFAULT.

Dependent objects: An SQL routine is dependent on objects that are referenced in the *SQL-routine-body*. The names of the dependent objects are stored in catalog view SYSROUTINEDEP. If the object reference in the *SQL-routine-body* is a fully qualified name or, in SQL naming, if an unqualified name is qualified by the current schema, then the schema name of the object in SYSROUTINEDEP will be set to the specified name or the value of the current schema. Otherwise, the schema name is not set to a specific schema name. Unqualified function names, variable names, and type names will have a schema name of CURRENT PATH. If the name is not set to an actual schema name, then DROP and ALTER statements will not be able to determine whether the routine is dependent on the object being altered or dropped.

Syntax alternatives: The following keywords are synonyms supported for compatibility to prior releases. These keywords are non-standard and should not be used:

- The keywords VARIANT and NOT VARIANT can be used as synonyms for NOT DETERMINISTIC and DETERMINISTIC.
- The keywords NULL CALL and NOT NULL CALL can be used as synonyms for CALLED ON NULL INPUT and RETURNS NULL ON NULL INPUT.
- The keywords IS DETERMINISTIC may be used as a synonym for DETERMINISTIC.

Example

Example 1: Define a scalar function that returns the tangent of a value using the existing SIN and COS built-in functions.

```
CREATE FUNCTION TAN
  (X DOUBLE)
  RETURNS DOUBLE
  LANGUAGE SQL
  CONTAINS SQL
  NO EXTERNAL ACTION
  DETERMINISTIC
  RETURN SIN(X)/COS(X)
```

Notice that a parameter name (X) is specified for the input parameter to function TAN. The parameter name is used within the body of the function to refer to the input parameter. The invocations of the SIN and COS functions, within the body of the TAN user-defined function, pass the parameter X as input.

Example 2: Define a scalar function that returns a date formatted as *mm/dd/yyyy* followed by a string of up to 3 characters:

```
CREATE FUNCTION BADPARG
  (INP1 DATE,
   USA VARCHAR(3))
RETURNS VARCHAR(20)
LANGUAGE SQL
CONTAINS SQL
NO EXTERNAL ACTION
DETERMINISTIC
RETURN CHAR(INP1, USA) CONCAT USA
```

Assume that the function is invoked as in the following statement:

```
SELECT BADPARG(BIRTHDATE, 'ISO')
FROM EMPLOYEE WHERE EMPNO='000010'
```

The result is '08/24/1933ISO'. Notice that parameter names (INP1 and USA) are specified for the input parameters to function BADPARG. Although there is an input parameter named USA, the instance of USA in the parameter list for the CHAR function is taken as the keyword parameter for the built-in CHAR function and not the parameter named USA.

CREATE FUNCTION (SQL table)

This CREATE FUNCTION (SQL table) statement creates an SQL table function at the current server. The function returns a single result table.

Invocation

This statement can be embedded in an application program or issued interactively. It is an executable statement that can be dynamically prepared.

Authorization

The privileges held by the authorization ID of the statement must include at least one of the following:

- The privilege to create in the schema. For more information, see [Privileges necessary to create in a schema](#).
- Database administrator authority

The privileges held by the authorization id of the statement must include at least one of the following:

- For the SYSFUNCS catalog view and SYSPARMS catalog table:
 - The INSERT privilege on the table, and
 - The USAGE privilege on schema QSYS2
- Database administrator authority

The privileges held by the authorization ID of the statement must also include at least one of the following:

- The following system authorities:
 - *USE to the Create Service Program (CRTSRVPGM) command or
- Database administrator authority

If a distinct type is referenced, the privileges held by the authorization ID of the statement must include at least one of the following:

- For each distinct type identified in the statement:
 - The USAGE privilege on the distinct type, and
 - The USAGE privilege on the schema containing the distinct type
- Database administrator authority

If the SECURED attribute is specified, or the function is secure and OR REPLACE is specified:

- The authorization ID of the statement must have security administrator authority. See [“Administrative authority”](#) on page 15.

To replace an existing function, the privileges held by the authorization ID of the statement must include at least one of the following:

- The following system authorities:
 - The system authority of *OBJMGT on the service program object associated with the function
 - All authorities needed to DROP the function
 - The system authority *READ to the SYSFUNCS catalog view and SYSPARMS catalog table
- Database administrator authority

For information about the system authorities corresponding to SQL privileges, see [Corresponding System Authorities When Checking Privileges to a Table or View](#) and [Corresponding System Authorities When Checking Privileges to a Distinct Type](#).

Syntax

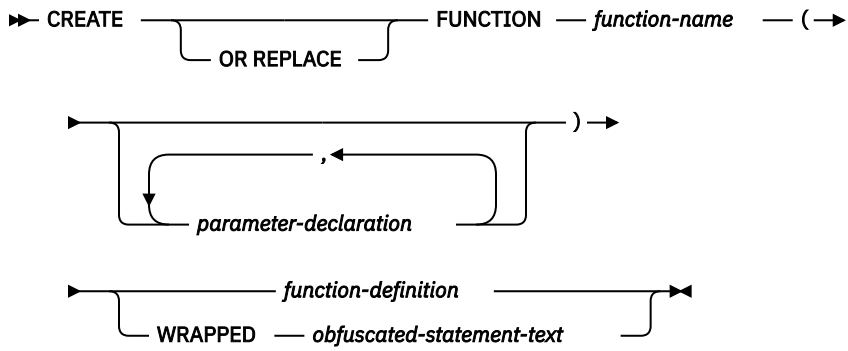

function-definition

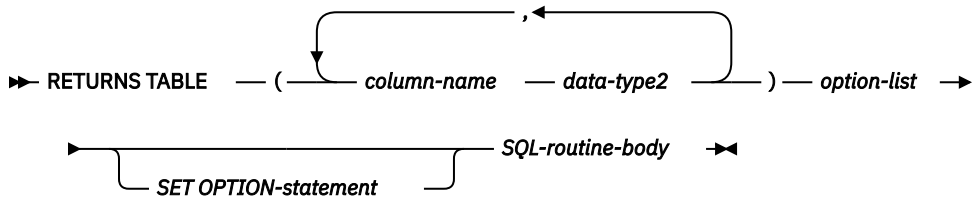

parameter-declaration

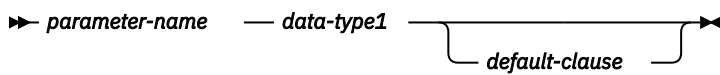

data-type1, data-type2

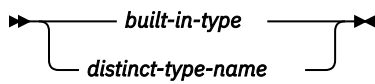

built-in-type

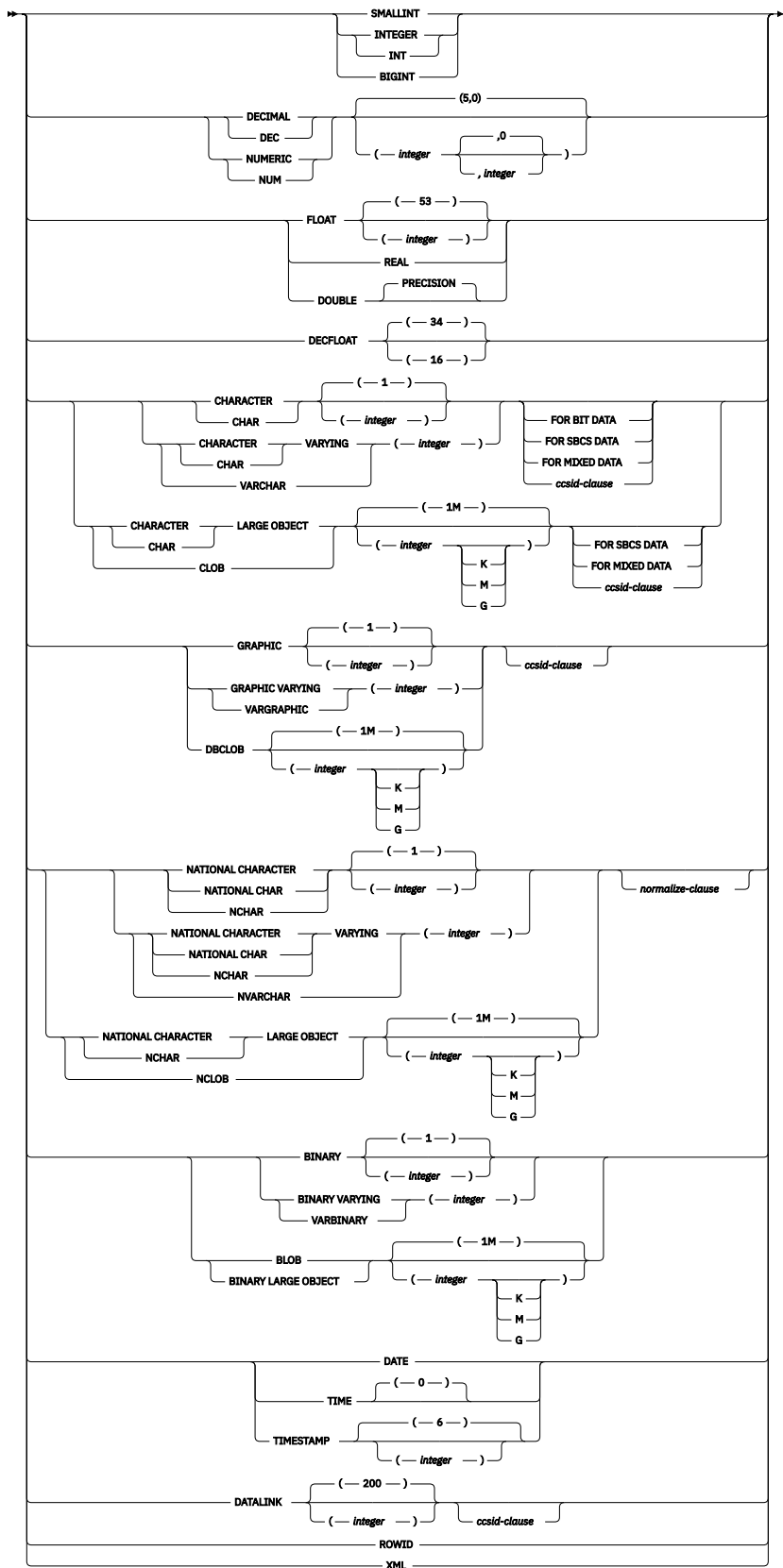

ccsid-clause

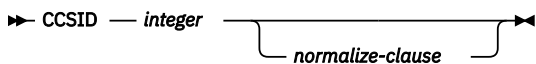

normalize-clause



default-clause

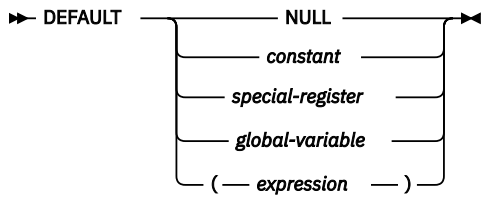

option-list

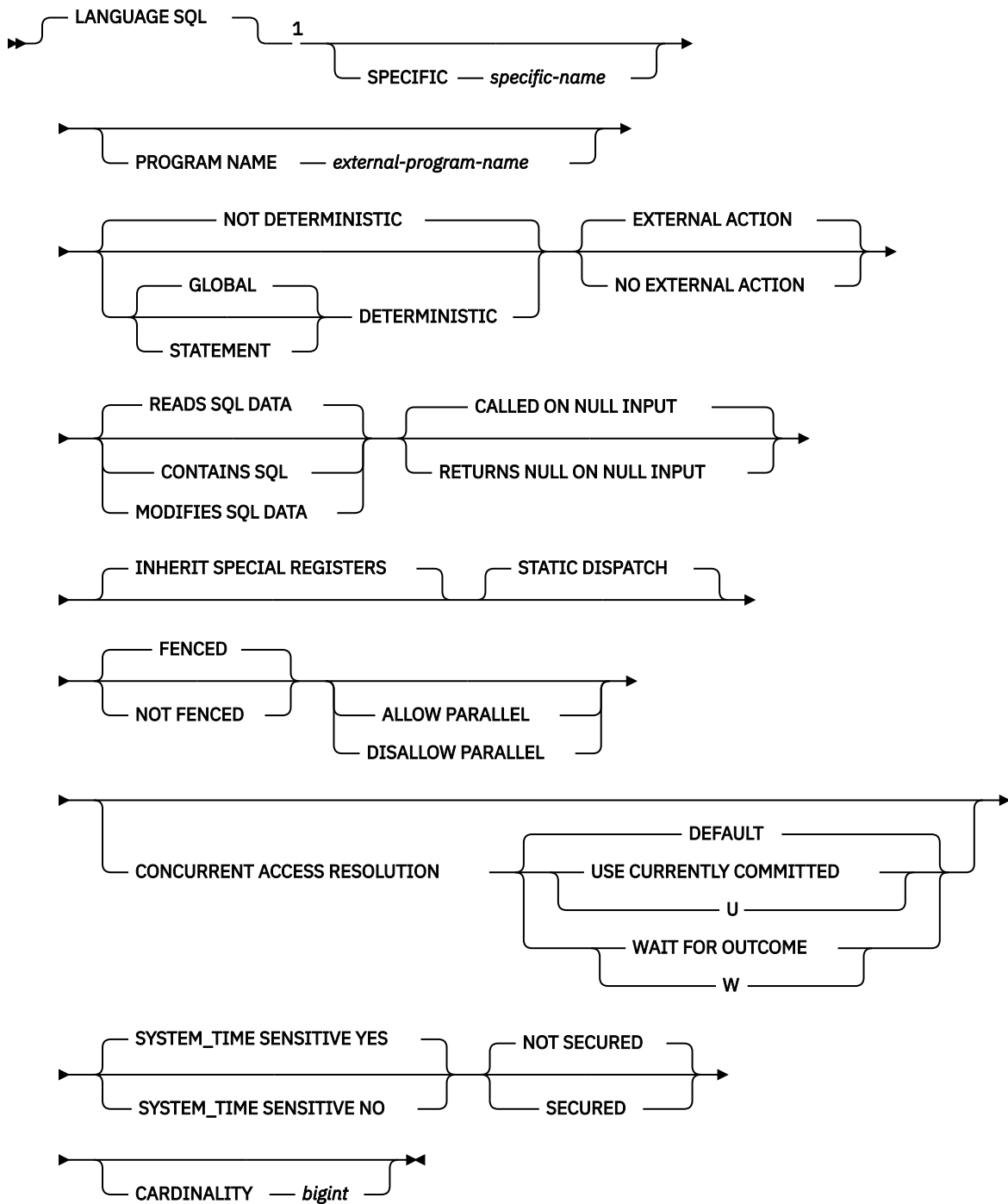

Notes:

¹ This clause and the clauses that follow in the option-list can be specified in any order. Each clause can be specified at most once.

SQL-routine-body

➤ SQL-control-statement ➤

Description

OR REPLACE

Specifies to replace the definition for the function if one exists at the current server. The existing definition is effectively dropped before the new definition is replaced in the catalog with the exception

that privileges that were granted on the function are not affected. This option is ignored if a definition for the function does not exist at the current server. To replace an existing function, the *specific-name* and *function-name* of the new definition must be the same as the *specific-name* and *function-name* of the old definition, or the signature of the new definition must match the signature of the old definition. Otherwise, a new function is created.

function-name

Names the user-defined function. The combination of name, schema name, the number of parameters, and the data type of each parameter (without regard for any length, precision, scale, or CCSID attributes of the data type) must not identify a user-defined function that exists at the current server unless OR REPLACE is specified.

For SQL naming, the function will be created in the schema specified by the implicit or explicit qualifier.

For system naming, the function will be created in the schema that is specified by the qualifier. If no qualifier is specified:

- If the value of the CURRENT SCHEMA special register is *LIBL, the function will be created in the current library (*CURLIB).
- Otherwise, the function will be created in the current schema.

In general, more than one function can have the same name if the function signature of each function is unique.

Certain function names are reserved for system use. For more information see Choosing the schema and function name in [“CREATE FUNCTION” on page 965](#).

(parameter-declaration,...)

Specifies the number of input parameters of the function and the data type of each parameter. Each *parameter-declaration* specifies an input parameter for the function. A maximum of 2000 parameters can be specified. A function can have zero or more input parameters. There must be one entry in the list for each parameter that the function expects to receive. All the parameters for a function are input parameters and are nullable. For more information, see Defining the parameters in [“CREATE FUNCTION” on page 965](#).

parameter-name

Names the parameter. The name is used to refer to the parameter within the body of the function. The name cannot be the same as any other *parameter-name* in the parameter list.

data-type1

Specifies the data type of the input parameter. The data type can be a built-in data type or a distinct data type.

built-in-type

Specifies a built-in data type. For a more complete description of each built-in data type, see [“CREATE TABLE” on page 1105](#).

distinct-type-name

Specifies a distinct type. The length, precision, or scale attributes for the parameter are those of the source type of the distinct type (those specified on CREATE TYPE). For more information about creating a distinct type, see [“CREATE TYPE \(distinct\)” on page 1184](#).

If the name of the distinct type is unqualified, the database manager resolves the schema name by searching the schemas in the SQL path.

If a CCSID is specified, the parameter will be converted to that CCSID prior to passing it to the function. If a CCSID is not specified, the CCSID is determined by the default CCSID at the current server at the time the function is invoked.

default-clause

Specifies a default value for the parameter. The default can be a constant, a special register, a global variable, an expression, or the keyword NULL. The expression is any expression defined in [“Expressions” on page 159](#), that does not include an aggregate function or column name. If a

default value is not specified, the parameter has no default and cannot be omitted on invocation. The maximum length of the expression string is 64K.

The default expression must be assignment compatible to the parameter data type.

Any comma in the default expression that is intended as a separator of numeric constants in a list must be followed by a space.

All objects referenced in a default expression must exist when the function is created.

RETURNS TABLE

Specifies the output table of the function.

Assume the number of parameters is N . There must be no more than $8000-N$ columns.

column-name

Specifies the name of a column of the output table. Do not specify the same name more than once.

data-type2

Specifies the data type and attributes of the output.

You can specify any built-in data type (except LONG VARCHAR, or LONG VARGRAPHIC) or a distinct type. When the function is invoked the results are assigned to these data types (using storage assignment rules).

If a CCSID is specified and the CCSID of the return data is encoded in a different CCSID, the data is converted to the specified CCSID.

If a CCSID is not specified and the function is not referenced in a view, the return data is converted to the CCSID of the job (or associated graphic CCSID of the job for graphic string return values), if the CCSID of the return data is encoded in a different CCSID. To avoid any potential loss of characters during the conversion, consider explicitly specifying a CCSID that can represent any characters that will be returned from the function. This is especially important if the data type is graphic string data. In this case, consider using CCSID 1200 or 13488 (Unicode graphic string data).

If a CCSID is not specified and the function is referenced in a view, the return data is converted to the CCSID of the associated view column. To avoid any potential loss of characters during the conversion, consider explicitly specifying a CCSID that can represent any characters that will be returned from the function. This is especially important if the data type is graphic string data. In this case, consider using CCSID 1200 or 13488 (Unicode graphic string data).

LANGUAGE SQL

Specifies that this is an SQL function.

SPECIFIC *specific-name*

Specifies a unique name for the function. For more information on specific names, see [Specifying a specific name for a function in "CREATE FUNCTION" on page 965](#).

PROGRAM NAME *external-program-name*

Specifies the unqualified name of the service program to be created for the function. *external-program-name* must be a valid system name.

GLOBAL DETERMINISTIC or STATEMENT DETERMINISTIC or NOT DETERMINISTIC

Specifies whether the function returns the same results each time that the function is invoked with the same input arguments. The default is NOT DETERMINISTIC.

NOT DETERMINISTIC

Specifies that the function might not return the same result each time that the function is invoked with the same input arguments. The function depends on some state values that affect the results. The database manager uses this information during optimization of SQL statements. An example of a table function that is not deterministic is one that references special registers, non-deterministic functions, or a sequence in a way that affects the table function result table.

GLOBAL DETERMINISTIC

Specifies that the function always returns the same result table each time that the function is invoked with the same input arguments. The database manager uses this information during optimization of SQL statements. The query optimizer may choose to cache global deterministic function results.

STATEMENT DETERMINISTIC

Specifies that the function might not return the same result each time that the function is invoked with the same input arguments, but multiple invocations of the function within a single SQL statement are considered deterministic. The query optimizer will not cache statement deterministic function results.⁹⁵

EXTERNAL ACTION or NO EXTERNAL ACTION

Specifies whether the function takes an action that changes the state of an object that the database manager does not manage. An example of an external action is sending a message or writing a record to a stream file. The default is EXTERNAL ACTION.

EXTERNAL ACTION

Specifies that the function can take an action that changes the state of an object that the database manager does not manage. Thus, the function must be invoked with each successive function invocation. EXTERNAL ACTION should be specified if the function contains a reference to another function that has an external action.

NO EXTERNAL ACTION

The function does not perform an external action. It need not be called with each successive function invocation.

NO EXTERNAL ACTION functions might perform better than EXTERNAL ACTION functions because they might not be invoked for each successive function invocation.

CONTAINS SQL, READS SQL DATA, or MODIFIES SQL DATA

Specifies the classification of SQL statements and nested routines that the function can execute. The database manager verifies that the SQL statements issued by the function, and all routines locally invoked by the function, are consistent with this specification. The verification is not performed when nested remote routines are invoked. For the classification of each statement, see [Appendix B, “Characteristics of SQL statements,”](#) on page 1643. The default is READS SQL DATA. This option applies to any parameter default expressions.

READS SQL DATA

Specifies that the function can execute statements with a data access classification of READS SQL DATA, CONTAINS SQL, or NO SQL. The function cannot execute SQL statements that modify data.

CONTAINS SQL

Specifies that the function can execute only SQL statements with a data access classification of CONTAINS SQL or NO SQL. The function cannot execute any SQL statements that read or modify data.

MODIFIES SQL DATA

The function can execute any SQL statement except those statements that are not supported in any function.

RETURNS NULL ON NULL INPUT or CALLED ON NULL INPUT

Specifies whether the function is called if any of the input arguments is null at execution time.

RETURNS NULL ON NULL INPUT

Specifies that the function is not called if any of the input arguments is null. The result is an empty table, which is a table with no rows. RETURNS NULL ON NULL INPUT is the default.

⁹⁵ The DETERMINISTIC_UDF_SCOPE QAQQINI option can be used to get this same behavior for a GLOBAL DETERMINISTIC function. For more information, see the [Database Performance and Query Optimization](#) topic collection.

CALLED ON NULL INPUT

Specifies that the function is to be invoked if any argument values are null. This specification means that the function must be coded to test for null argument values. The function can return an empty table, depending on its logic.

INHERIT SPECIAL REGISTERS

Specifies that existing values of special registers are inherited upon entry to the function.

STATIC DISPATCH

Specifies that the function is dispatched statically. All functions are statically dispatched.

FENCED or NOT FENCED

Specifies whether the SQL function runs in an environment that is isolated from the database manager environment. FENCED is the default.

FENCED

The function will run in a separate thread.

FENCED functions cannot keep SQL cursors open across individual calls to the function. However, the cursors in one thread are independent of the cursors in any other threads which reduces the possibility of cursor name conflicts.

NOT FENCED

The function may run in the same thread as the invoking SQL statement.

NOT FENCED functions can keep SQL cursors open across individual calls to the function. Since cursors can be kept open, the cursor position will also be preserved between calls to the function. However, cursor names may conflict since the UDF is now running in the same thread as the invoking SQL statement and other NOT FENCED UDFs.

NOT FENCED functions usually perform better than FENCED functions.

ALLOW PARALLEL or DISALLOW PARALLEL

Specifies whether the function can be run in parallel.

The default is DISALLOW PARALLEL if one or more of the following clauses are specified: NOT DETERMINISTIC, EXTERNAL ACTION, or MODIFIES SQL DATA, or if this is a pipelined table function. Otherwise, ALLOW PARALLEL is the default.

ALLOW PARALLEL

Specifies that the database manager can consider parallelism for the function. The database manager is not required to use parallelism on the SQL statement that invokes the function or on any SQL statement issued from within the function.

See the descriptions of NOT DETERMINISTIC, EXTERNAL ACTION, and MODIFIES SQL DATA for considerations that apply to specification of ALLOW PARALLEL.

DISALLOW PARALLEL

Specifies that the database manager must not use parallelism for the function.

CONCURRENT ACCESS RESOLUTION

Specifies whether the database manager should wait for data that is in the process of being updated. DEFAULT is the default.

DEFAULT

Specifies that the concurrent access resolution is not explicitly set for this function. The value that is in effect when the function is invoked will be used.

WAIT FOR OUTCOME

Specifies that the database manager is to wait for the commit or rollback of data in the process of being updated.

USE CURRENTLY COMMITTED

Specifies that the database manager is to use the currently committed version of the data when encountering data that is in the process of being updated.

When the lock contention is between a read transaction and a delete or update transaction, the clause is applicable to scans with isolation level CS (but not for CS KEEP LOCKS).

SYSTEM_TIME SENSITIVE

Determines whether references to system-period temporal tables in both static and dynamic SQL statements are affected by the value of the CURRENT TEMPORAL SYSTEM_TIME special register. YES is the default.

YES

References to system-period temporal tables are affected by the value of the CURRENT TEMPORAL SYSTEM_TIME special register.

NO

References to system-period temporal tables are not affected by the value of the CURRENT TEMPORAL SYSTEM_TIME special register.

NOT SECURED or SECURED

Specifies whether the function is considered secure for row access control and column access control.

NOT SECURED

Specifies that the function is considered not secure for row access control and column access control. This is the default.

When the function is invoked, the arguments of the function must not reference a column for which a column mask is enabled when the table is using active column access control.

SECURED

Specifies that the function is considered secure for row access control and column access control.

A function must be defined as secure when it is referenced in a row permission or a column mask.

WRAPPED *obfuscated-statement-text*

Specifies the encoded definition of the function. A CREATE FUNCTION statement can be encoded using the WRAP scalar function.

CARDINALITY *bigint*

This optional clause provides an estimate of the expected number of rows to be returned by the function for optimization purposes. Valid values for integer range from 0 to 9 223 372 036 854 775 807 inclusive.

If the CARDINALITY clause is not specified for a table function, the database manager will assume a finite value as a default.

A table function that returns a row every time it is called and never returns the end-of-table condition has infinite cardinality. A query that invokes such a function and requires an eventual end-of-table condition before it can return any data will not return unless interrupted.

SET OPTION-statement

Specifies the options that will be used to create the function. These options also apply to any default value expressions. For example, to create a debuggable function, the following statement could be included:

```
SET OPTION DBGVIEW = *SOURCE
```

The default values for the options depend on the options in effect at create time. For more information, see [“SET OPTION” on page 1505](#).

The options CNULRQD, CNULIGN, COMPILEOPT, NAMING, and SQLCA are not allowed in the CREATE FUNCTION statement. CLOSQLCSR(*ENDACTGRP) is always used for SQL table functions. The following options are used when processing default value expressions: ALWCPYDTA, CONACC, DATFMT, DATSEP, DECFLTRND, DECMPT, DECRESULT, DFTRDBCOL, LANGID, SQLCURRULE, SQLPATH, SRTSEQ, TGTRLS, TIMFMT, and TIMSEP.

SQL-routine-body

Specifies a single SQL statement, including a compound statement. See [“SQL control statements” on page 1569](#) for more information about defining SQL functions.

A non-pipelined table function must contain exactly one RETURN statement. A pipelined table function must contain at least one RETURN statement. The RETURN statement must be executed when the function is invoked.

A call to a procedure that issues a CONNECT, SET CONNECTION, RELEASE, DISCONNECT, COMMIT, ROLLBACK and SET TRANSACTION statement is not allowed in a function.

ALTER PROCEDURE (SQL), ALTER FUNCTION (SQL scalar), and ALTER FUNCTION (SQL table) with a REPLACE keyword are not allowed in an *SQL-routine-body*.

Notes

General considerations for defining user-defined functions: See [“SQL control statements”](#) on page 1569 for general information about defining user-defined functions.

Function ownership: If SQL names were specified:

- If a user profile with the same name as the schema into which the function is created exists, the *owner* of the function is that user profile.
- Otherwise, the *owner* of the function is the user profile or group user profile of the thread executing the statement.

If system names were specified, the *owner* of the function is the user profile or group user profile of the thread executing the statement.

Function authority: If SQL names are used, functions are created with the system authority of *EXCLUDE on *PUBLIC. If system names are used, functions are created with the authority to *PUBLIC as determined by the create authority (CRTAUT) parameter of the schema.

If the owner of the function is a member of a group profile (GRPPRF keyword) and group authority is specified (GRPAUT keyword), that group profile will also have authority to the function.

Pipelined and non-pipelined functions: There are two types of SQL table functions. A table function which does not contain any PIPE statements within the *SQL-routine-body* is a non-pipelined table function. It contains one RETURN statement which returns a table. A pipelined table function is a table function which contains one or more RETURN statements with no return values and zero or more PIPE statements within the *SQL-routine-body*. It returns a table a row at a time. The two types of table functions are invoked in exactly the same way.

A PIPE statement returns a result row from the table function. To get the next row, control returns in the *SQL-routine-body* to the statement following the PIPE statement.

REPLACE rules: When a function is recreated by REPLACE:

- Any existing comment or label is discarded.
- Authorized users are maintained. The object owner could change.
- Current journal auditing is preserved.

If the function is replaced and the function signature or result data types are altered, the results from any function, materialized query table, procedure, trigger, or view that references the function may be unpredictable. Any referenced objects should be recreated.

Creating the function: When an SQL function is created, the database manager creates a temporary source file that will contain C source code with embedded SQL statements. A *SRVPGM object is then created using the CRTSRVPGM command. The SQL options used to create the service program are the options that are in effect at the time the CREATE FUNCTION statement is executed. The service program is created with ACTGRP(*CALLER).

When an SQL function is created, the function's attributes are stored in the created service program object. If the *SRVPGM object is saved and then restored to this or another system, the attributes are used to update the catalogs.

If the PROGRAM NAME clause is provided, its name is used for the creation of the service program object. Otherwise, the specific name is used to determine the name of the source file member and *SRVPGM object. If the specific name is a valid system name, it will be used as the name of member and program. If the member already exists, it will be overlaid. If a program already exists in the specified library, a unique name is generated using the rules for generating system table names. If the specific name is not a valid system name, a unique name is generated using the rules for generating system table names.

Invoking the function: When an SQL function is invoked, it runs in the activation group of the calling program.

Inline functions: When an SQL table function is inlined, instead of invoking the function as part of a query, the *fullselect* in the RETURN statement of the function may be copied (inlined) into the query itself. Such a function is called an *inline function*. A table function is an *inline function* if:

- The SQL function is defined as NO EXTERNAL ACTION.
- The *SQL-routine-body* contains only a RETURN statement.
- No column in the result table is the XML data type.
- All objects referenced in the function exist when the function is created.
- The *SQL-routine-body* does not contain a common table expression that references an input parameter.

An *inline function* is only copied (inlined) into a query if:

- The query is eligible for the SQL Query Engine (SQE).
- The function does not reference a table on a different server.
- The function references an object and the authority attributes of the function and the query are compatible based on one of the following conditions:
 - The function is defined to run under the user's authority (*USER).
 - The query is running under the owner's authority (*OWNER) and the owner of the query is the same as the owner of the function.
 - The query is running under the user's authority (*USER), and the user or the user's group profile is the same as the owner of the function.

Note: If the function is defined as FENCED, the query must not use adopted authority. If the query runs under the owner's authority (*OWNER) and the function runs under the user's authority (*USER), the owner of the query must be the same as the user or the user's group profile.

When a function is inlined, some of the options specified when the function was created are ignored:

- PARALLEL or NOT PARALLEL
- MODIFIES SQL DATA
- Commitment control level
- CONCURRENT ACCESS RESOLUTION
- ALWCPYDTA
- ATOMIC or NOT ATOMIC

If a function is inlined and it contains a reference to a special register, the value of the special register will be the same as other references to the same special register in the query.

Obfuscated statements: A CREATE FUNCTION statement can be executed in obfuscated form. In an obfuscated statement, only the function name and parameters are readable followed by the WRAPPED keyword. The rest of the statement is encoded in such a way that it is not readable but can be decoded by a database server that supports obfuscated statements. Obfuscated statements can be produced by invoking the WRAP scalar function. Any debug options that are specified when the function is created from an obfuscated statement are ignored. A function that is created from an obfuscated statement cannot be restored to a release where obfuscation is not supported.

Dependent objects: An SQL routine is dependent on objects that are referenced in the *SQL-routine-body*. The names of the dependent objects are stored in catalog view SYSROUTINEDEP. If the object reference in the *SQL-routine-body* is a fully qualified name or, in SQL naming, if an unqualified name is qualified by the current schema, then the schema name of the object in SYSROUTINEDEP will be set to the specified name or the value of the current schema. Otherwise, the schema name is not set to a specific schema name. Unqualified function names, variable names, and type names will have a schema name of CURRENT PATH. If the name is not set to an actual schema name, then DROP and ALTER statements will not be able to determine whether the routine is dependent on the object being altered or dropped.

Syntax alternatives: The following keywords are synonyms supported for compatibility to prior releases. These keywords are non-standard and should not be used:

- The keywords VARIANT and NOT VARIANT can be used as synonyms for NOT DETERMINISTIC and DETERMINISTIC.
- The keywords NULL CALL and NOT NULL CALL can be used as synonyms for CALLED ON NULL INPUT and RETURNS NULL ON NULL INPUT.
- The keywords IS DETERMINISTIC may be used as a synonym for DETERMINISTIC.

Example

Define a table function that returns the employees in a specified department number.

```
CREATE FUNCTION DEPEMPL0YEEES (DEPTNO CHAR(3))
  RETURNS TABLE (EMPNO CHAR(6),
                 LASTNAME VARCHAR(15),
                 FIRSTNAME VARCHAR(12))
LANGUAGE SQL
READS SQL DATA
NO EXTERNAL ACTION
DETERMINISTIC
DISALLOW PARALLEL
RETURN
  SELECT EMPNO, LASTNAME, FIRSTNAME
  FROM EMPLOYEE
  WHERE EMPLOYEE.WORKDEPT =DEPEMPL0YEEES.DEPTNO
```

CREATE INDEX

The CREATE INDEX statement creates an index on a table at the current server.

Invocation

This statement can be embedded in an application program or issued interactively. It is an executable statement that can be dynamically prepared.

Authorization

The privileges held by the authorization ID of the statement must include at least one of the following:

- The privilege to create in the schema. For more information, see [Privileges necessary to create in a schema](#).
- Database administrator authority

The privileges held by the authorization ID of the statement must include at least one of the following:

- The following system authorities:
 - *USE to the Create Logical File (CRTLF) command
 - *CHANGE to the data dictionary if the library into which the index is created is an SQL schema with a data dictionary
- Database administrator authority

The privileges held by the authorization ID of the statement must also include at least one of the following:

- For the referenced table:
 - The INDEX privilege on the table
 - The USAGE privilege on the schema containing the table
- Database administrator authority

If SQL names are specified and a user profile exists that has the same name as the library into which the table is created, and that name is different from the authorization ID of the statement, then the privileges held by the authorization ID of the statement must include at least one of the following:

- The system authority *ADD to the user profile with that name
- Database administrator authority

If a distinct type is referenced, the privileges held by the authorization ID of the statement must include at least one of the following:

- For each distinct type identified in the statement:
 - The USAGE privilege on the distinct type, and
 - The USAGE privilege on the schema containing the distinct type
- Database administrator authority

For information about the system authorities corresponding to SQL privileges, see [Corresponding System Authorities When Checking Privileges to a Table or View](#).

Syntax

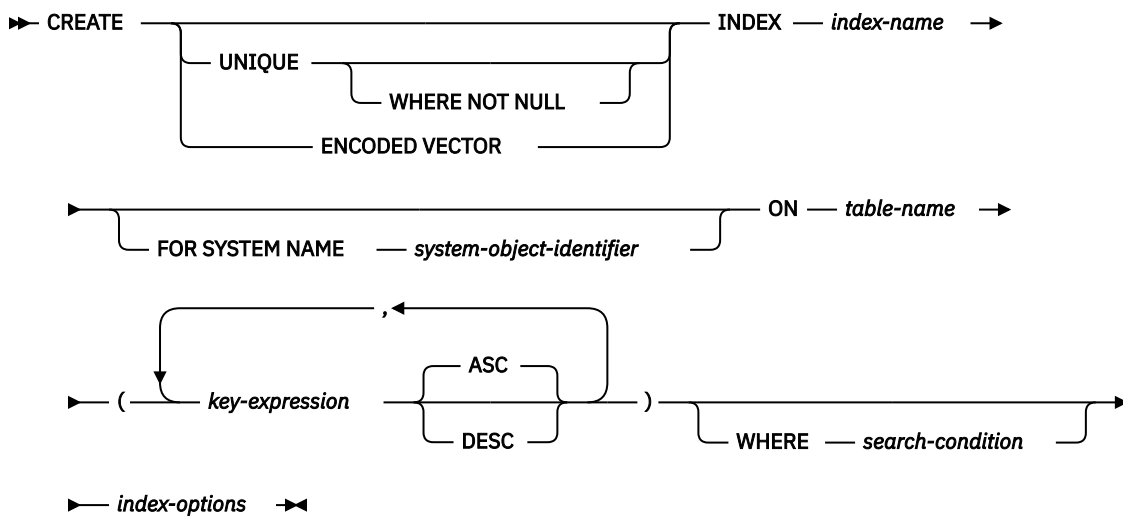

key-expression

► `expression` ►

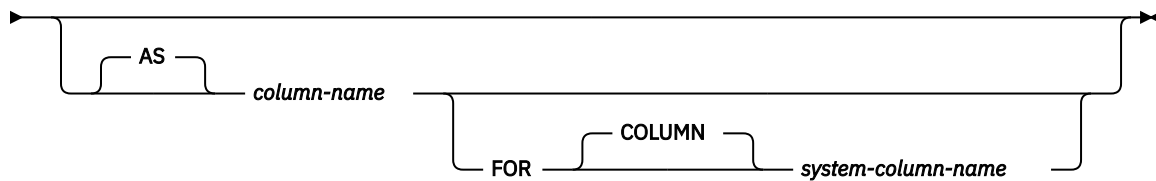

index-options

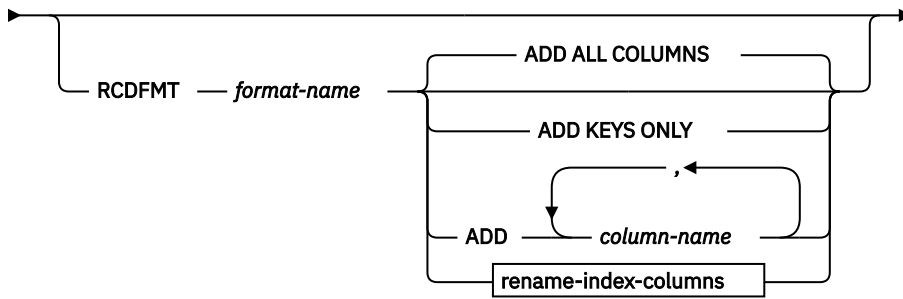
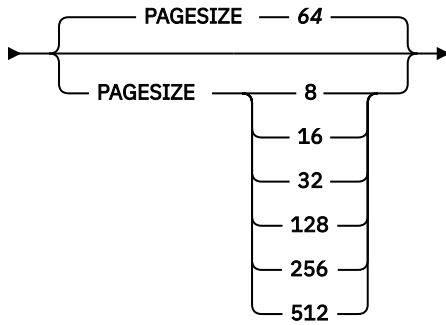
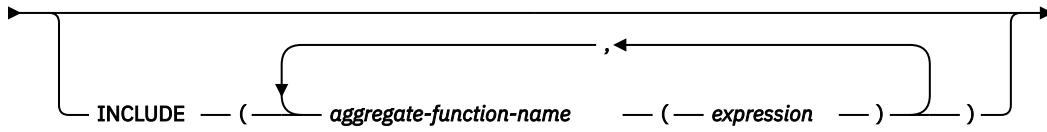
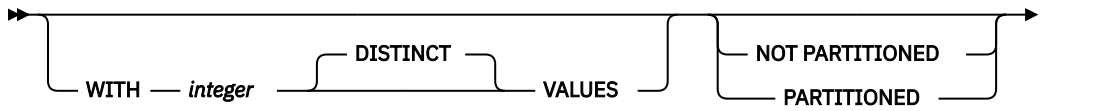

rename-index-columns

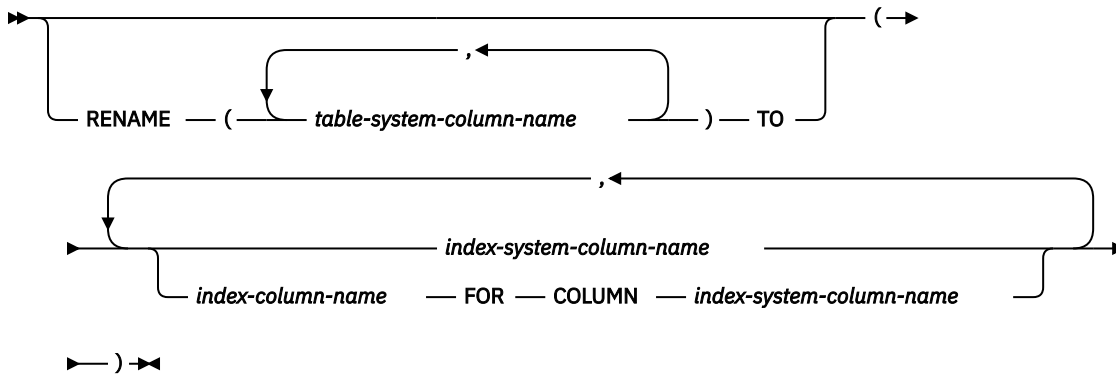

media-preference

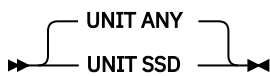

memory-preference

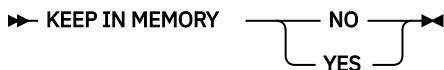

Notes:

¹ The *index-options* may be specified in any order.

Description

UNIQUE

Prevents the table from containing two or more rows with the same value of the index key. When UNIQUE is used, all null values for a column are considered equal. For example, if the key is a single column that can contain null values, that column can contain only one null value. The constraint is enforced when rows of the table are updated or new rows are inserted.

The constraint is also checked during the execution of the CREATE INDEX statement. If the table already contains rows with duplicate key values, the index is not created.

UNIQUE WHERE NOT NULL

Prevents the table from containing two or more rows with the same value of the index key, where all null values for a column are not considered equal. Multiple null values in a column are allowed.

Otherwise, this is identical to UNIQUE.

ENCODED VECTOR

Specifies that the resulting index will be an encoded vector index (EVI).

An encoded vector index cannot be used to ensure an ordering of rows. It is used by the database manager to improve the performance of queries. For more information, see the [Database Performance and Query Optimization](#) topic collection.

index-name

Names the index. The name, including the implicit or explicit qualifier, must not be the same as an index, table, view, alias, or file that already exists at the current server.

If SQL names were specified, the index will be created in the schema specified by the implicit or explicit qualifier.

If system names were specified, the index name will be created in the schema that is specified by the qualifier. If not qualified, the index name will be created in the same schema as the table over which the index is created.

If the index name is not a valid system name and the FOR SYSTEM NAME clause is not used, Db2 for i will generate a system name. For information about the rules for generating a name, see [“Rules for Table Name Generation”](#) on page 1157.

FOR SYSTEM NAME *system-object-identifier*

Identifies the *system-object-identifier* of the index. *system-object-identifier* must not be the same as a table, view, alias, or index that already exists at the current server. The *system-object-identifier* must be an unqualified system identifier.

When *system-object-identifier* is specified, *index-name* must not be a valid system object name.

ON *table-name*

Identifies the table on which the index is to be created. The *table-name* must identify a base table (not a view) that exists at the current server.

If the table is a partitioned table, an alias may be specified which identifies a single partition. The created index will then only be created over the specified partition.

key-expression

Identifies a column or expression that will be part of the index key.

The number of keys defined for the index must not exceed 120, and the sum of their byte lengths must not exceed $32766-n$, where n is the number of keys specified that allow nulls.

expression

If *expression* contains only a *column-name*, it must be an unqualified name that identifies a column of the table. *expression* must contain a column reference. The same *column-name* cannot be specified more than once if:

- a WHERE clause, INCLUDE clause, or RCDFMT clause is specified,

- an expression is defined as part of an index key, or
- a column is renamed using the AS clause.

If the *expression* is not a column name, the *expression* must not reference a column that contains a field procedure.

A *column-name* must not identify a LOB, XML, or DATALINK column, or a distinct type based on a LOB, XML, or DATALINK column. If the *expression* is not a column name, any intermediate result expression and the final result expression must not be a DATALINK, LOB, or XML data type. It must not contain any of the following:

- Subqueries
- Aggregate functions
- Variables
- Global variables
- Parameter markers
- Special registers
- Sequence references
- OLAP specifications
- ROW CHANGE expressions
- REGEXP_LIKE predicate
- User-defined functions other than functions that were implicitly generated with the creation of a strongly typed distinct type
- Any function that is not deterministic
- The following built-in scalar functions:

ATAN2	DLURLSCHEME	JSON_QUERY	REPLACE
BSON_TO_JSON	DLURLSERVER	JSON_TO_BSON	ROUND_TIMESTAMP
CARDINALITY	DLVALUE	JSON_VALUE	RPAD
CONTAINS	ENCRYPT_AES	LOCATE_IN_STRING	SCORE
CURDATE	ENCRYPT_RC2	LPAD	SOUNDEX
CURTIME	ENCRYPT_TDES	MAX_CARDINALITY	TABLE_NAME
DATAPARTITIONNAME	GENERATE_UNIQUE	MONTHNAME	TABLE_SCHEMA
DATAPARTITIONNUM	GETHINT	MONTHS_BETWEEN	TIMESTAMP_FORMAT
DAYNAME	HASH	NEXT_DAY	TIMESTAMPDIFF
DBPARTITIONNAME	HASH_MD5	NOW	TRUNC_TIMESTAMP
DECRYPT_BINARY	HASH_SHA1	OVERLAY	VARCHAR_FORMAT
DECRYPT_BIT	HASH_SHA256	RAISE_ERROR	VERIFY_GROUP_FOR_USER
DECRYPT_CHAR	HASH_SHA512	RAND	WEEK_ISO
DECRYPT_DB	IDENTITY_VAL_LOCAL	REGEXP_COUNT	WRAP
DIFFERENCE	INSERT	REGEXP_INSTR	XMLPARSE
DLURLCOMPLETE ¹	INTERPRET	REGEXP_REPLACE	XMLVALIDATE
DLURLPATH	JSON_ARRAY	REGEXP_SUBSTR	XSLTRANSFORM
DLURLPATHONLY	JSON_OBJECT	REPEAT	

¹ For DataLinks with an attribute of FILE LINK CONTROL and READ PERMISSION DB.

column-name

Names a column of the index. Do not use the same name for more than one column of the index or for a *system-column-name* of the index.

If the *expression* is not a column name and is not named, a name will be generated for the index key column. The name will be SQLIXxxxxx, where xxxxx is a number that makes the column name unique for the index.

FOR COLUMN *system-column-name*

Provides an IBM i name for the column. Do not use the same name for more than one column of the index or for a column-name of the index.

If the *system-column-name* is not specified, and the *column-name* is not a valid *system-column-name*, a system column name is generated. The name will be SQLIXxxxxx, where xxxxx is a number that makes the column name unique for the index.

ASC

Specifies that the index entries are to be kept in ascending order of the column values. ASC is the default.

DESC

Specifies that the index entries are to be kept in descending order of the column values.

Ordering is performed in accordance with the comparison rules described in [“Assignments and comparisons”](#) on page 91. The null value is higher than all other values.

WHERE *search-condition*

Specifies the condition to apply for a row to be included in the index. The *search-condition* cannot contain a predicate with a subquery. It must not contain any of the items listed as restrictions for *key-expression*.

WITH *integer* DISTINCT VALUES

Specifies the estimated number of distinct key values. This clause may be specified for any type of index.

For encoded vector indexes this is used to determine the initial size of the codes assigned to each distinct key value. Only 1, 2, and 4 byte codes are used. If the INCLUDE clause is not specified, the default value is 255 (a 1-byte code). Otherwise, a 4-byte code is used. During the create or rebuild of the index if the number of distinct values exceeds the maximum supported by the size of the code, the size of the code is increased.

For non-encoded vector indexes, this clause is ignored.

PARTITIONED

Specifies that an index partition should be created for each data partition defined for the table using the specified columns. The *table-name* must identify a partitioned table. If the index is unique, the columns of the index must be the same or a superset of the columns of the data partition key. PARTITIONED is the default if the index is not unique and the table is partitioned.

NOT PARTITIONED

Specifies that a single index should be created that spans all of the data partitions defined for the table. The *table-name* must identify a partitioned table. NOT PARTITIONED is the default if the index is unique and the table is partitioned. An index on a table that is not partitioned is also by default not partitioned.

If an encoded vector index is specified, NOT PARTITIONED is not allowed.

PAGESIZE

Specifies the logical page used for the index in kilobytes. Indexes with larger logical page sizes are typically more efficient when scanned during query processing. Indexes with smaller logical page sizes are typically more efficient for simple index probes and individual key look ups.

The default value for PAGESIZE is determined by the length of the key and has a minimum value of 64.

If an encoded vector index is specified, PAGESIZE is not allowed.

INCLUDE

Specifies aggregate function expressions to be included in the index. These aggregates make it possible for the index to be used directly to return aggregate results for a query. INCLUDE is only allowed for an encoded vector index.

aggregate-function-name (expression)

The aggregate function name must be one of the built-in functions AVG, COUNT, COUNT_BIG, SUM, STDDEV, STDDEV_SAMP, VARIANCE, or VARIANCE_SAMP. The DISTINCT keyword must not be specified. The *expression* argument of the aggregate function must not contain any of the items listed as restrictions for *key-expression*.

RCDFMT format-name

An unqualified name that designates the IBM i record format name of the index. A *format-name* is a system identifier.

If the INCLUDE keyword is specified, RCDFMT is not allowed.

ADD ALL COLUMNS

Specifies that all non-hidden columns of *table-name* will be added to the format for the index. All the columns will be defined in the same order as they appear in the format of *table-name* and will precede any expressions defined as index keys.

ADD KEYS ONLY

Specifies that only the columns specified as index key columns will be added to the format for the index. Other columns from *table-name* will not be added.

ADD column-name

Specifies that the listed columns will be added to the format for the index. The index key columns will be first, followed by the added columns.

RENAME

Specifies the columns from *table-name* that will be included in the format for the index. The order of the columns in the index format will be the same as the order of the columns in the list. The columns in the index can also be renamed.

table-system-column-name

Identifies the system column name of a column in *table-name*.

index-system-column-name

Provides the system column name for the corresponding column in the index.

index-column-name

Provides the column name for the corresponding column in the index.

When this clause is used, the following rules apply:

- Each *key-expression* must contain only a *column-name*. It can be either the column name or the system column name of a column in *table-name*. The *key-expression* cannot include an AS clause to rename the column.
- If a list of *table-system-column-names* is specified, it must contain the same number of names as are provided in the index column name list.
- If a list of *table-system-column-names* is not specified, every *index-system-column-name* must be the system column name for a column in *table-name*.
- Each *index-column-name* and *index-system-column-name* must be unique and unqualified.
- Every column in *key-expression* must be included in the RENAME clause.

media-preference

Specifies the preferred storage media for the index.

UNIT ANY

No storage media is preferred. Storage for the index will be allocated from any available storage media.

UNIT SSD

Solid state disk storage media is preferred. Storage for the index may be allocated from solid state disk storage media, if available.

memory-preference

KEEP IN MEMORY

Specifies whether the data for the index should be brought into a main storage pool when the data is used for a query.

NO

The data will not be brought into a main storage pool.

YES

The data will be brought into a main storage pool.

Notes

Effects of the statement: CREATE INDEX creates a description of the index. If the named table already contains data, CREATE INDEX creates the index entries for it. If the table does not yet contain data, the index entries are created when data is inserted into the table.

Collating sequence: Any index created over columns containing SBCS or mixed data is created with the collating sequence in effect at the time the statement is executed. For collating sequences other than *HEX, the key for SBCS data or mixed data is the weighted value of the key based on the collating sequence.

Index attributes: An index is created as a keyed logical file. When an index is created, the file wait time and record wait time attributes are set to the default that is specified on the WAITFILE and WAITRCD keywords of the Create Logical File (CRTLF) command.

The date and time format used for date and time result columns is ISO.

An index created over a distributed table is created on all of the servers across which the table is distributed. For more information about distributed tables, see [DB2 Multisystem](#).

Index ownership: If SQL names were specified:

- If a user profile with the same name as the schema into which the index is created exists, the *owner* of the index is that user profile.
- Otherwise, the *owner* of the index is the user profile or group user profile of the thread executing the statement.

If system names were specified, the *owner* of the index is the user profile or group user profile of the thread executing the statement.

Index authority: If SQL names are used, indexes are created with the system authority of *EXCLUDE on *PUBLIC. If system names are used, indexes are created with the authority to *PUBLIC as determined by the create authority (CRTAUT) parameter of the schema.

If the owner of the index is a member of a group profile (GRPPRF keyword) and group authority is specified (GRPAUT keyword), that group profile will also have authority to the index.

Record format sharing: An index that defines a key column as an expression or that specifies the RCD_FMT, WHERE, INCLUDE, or AS clauses does not share the format of *table-name*. Otherwise, the index will share the format of *table-name* and its *format-name* will be the same as the *system-object-name* of the index.

Examples

Example 1: Create an index named UNIQUE_NAM on the PROJECT table. The purpose of the index is to ensure that there are not two entries in the table with the same value for project name (PROJNAME). The index entries are to be in ascending order.

```
CREATE UNIQUE INDEX UNIQUE_NAM
ON PROJECT (PROJNAME)
```

Example 2: Create an index named JOB_BY_DPT on the EMPLOYEE table. Arrange the index entries in ascending order by job title (JOB) within each department (WORKDEPT).

```
CREATE INDEX JOB_BY_DPT  
ON EMPLOYEE (WORKDEPT, JOB)
```

Example 3: Create an index named DEPT_TYPE on the DEPARTMENT table. Arrange the index entries in ascending order by type of department, which is determined by the second and third characters of the department number (DEPTNO).

```
CREATE INDEX DEPT_TYPE  
ON DEPARTMENT (SUBSTR(DEPTNO,2,2))
```

CREATE MASK

The CREATE MASK statement creates a column mask for column access control at the current server. A column mask specifies what value should be returned for the specified column.

Invocation

This statement can be embedded in an application program or issued interactively. It is an executable statement that can be dynamically prepared.

Authorization

The authorization ID of the statement must have security administrator authority. See [“Administrative authority”](#) on page 15.

Syntax

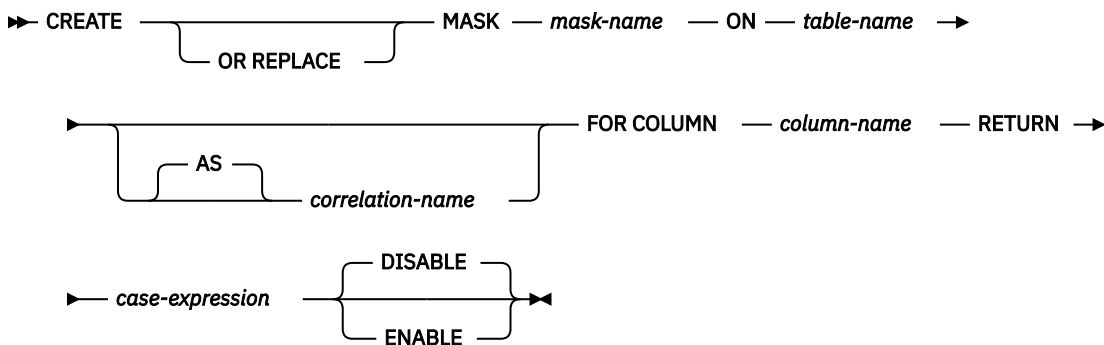

Description

OR REPLACE

Specifies to replace the definition for the column mask if one exists at the current server. The existing definition is effectively dropped before the new definition is replaced in the catalog.

mask-name

Names the column mask for column access control. The name, including the implicit or explicit qualifier, must not be the same as a column mask or a row permission that already exists at the current server. The *mask-name* cannot start with QIBM.

If SQL names were specified, the mask will be created in the schema specified by the implicit or explicit qualifier.

If system names were specified, the mask will be created in the schema that is specified by the qualifier. If not qualified and there is no default schema, the mask will be created in the same schema as the *table-name*.

The schema name for the *mask-name* must be the same as the schema name for *table-name*.

table-name

Identifies the table on which the column mask is created. The name must identify a table that exists at the current server. It must not identify a declared temporary table, table in QTEMP, distributed table, view, logical file, member alias, file with read triggers, or catalog table.

correlation-name

Specifies a correlation name that can be used within *case-expression* to designate the table.

FOR COLUMN *column-name*

Identifies the column to which the mask applies. It must be an unqualified name that identifies a column of the table. A mask must not already exist for the column.

RETURN *case-expression*

Specifies a CASE expression to be evaluated to determine the value to return for the column. The result of the CASE expression is returned in place of the column value in a row. The result data type, length, null attribute, and CCSID of the CASE expression must be compatible with the data type of the column. If the column does not allow the null value, the result of the CASE expression cannot be the NULL value. For more information about the compatibility of data types see “[Assignments and comparisons](#)” on page 91. If the data type of *column-name* is a user defined data type, the result data type of the CASE expression must be the same user defined type. Any objects referenced in the case expression must exist at the current server. The case expression must not reference any of the following:

- The table for which the column mask is being defined
- A declared global temporary table
- A variable (host variable, SQL variable, SQL parameter, or trigger transition variable)
- A parameter marker
- A user-defined function that is defined as NOT SECURED
- A function that is not deterministic⁹⁶ or has an external action
- An RRN, RID, HASHED_VALUE, DATAPARTITIONNAME, DATAPARTITIONNUM, DBPARTITIONNAME, or DBPARTITIONNUM function that references the table for which the column mask is being defined
- An OLAP specification
- A ROW CHANGE expression
- A sequence reference
- A * or *name.** in a select clause
- A table in QTEMP
- A member alias
- A distributed table
- A file with read triggers
- A multi-format logical file
- A remote object
- A view that contains any of the above

ENABLE or DISABLE

Specifies that the column mask is to be initially enabled or disabled for column access control.

DISABLE

Specifies that the column mask is to be disabled for column access control. The column mask will remain ineffective regardless of whether column access control is activated for the table or not. This is the default.

ENABLE

Specifies that the column mask is to be enabled for column access control. If column access control is not currently activated for this table, the column mask will become effective when column access control is activated for the table. If column access control is currently activated for the table, the column mask becomes effective immediately.

Notes

Prerequisites: In order to create a mask, IBM Advanced Data Security must be installed.

How column masks affect queries: The application of enabled column masks does not interfere with the operations of other clauses within the statement such as WHERE, GROUP BY, HAVING, SELECT DISTINCT, or ORDER BY. The rows that are returned in the final result table remain the same, except that the values in the resulting rows might have been masked by the column masks. As such, if the masked column also

⁹⁶ STATEMENT DETERMINISTIC functions are allowed but are not recommended.

appears in an ORDER BY clause with a sort-key expression, the order is based on the original values of the column and the masked values in the final result table might not reflect that order. Similarly, the masked values might not reflect the uniqueness enforced by a SELECT DISTINCT statement. If the masked column is embedded in an expression, the result of the expression might become different because the column mask is applied on the column before the expression evaluation can take place. For example, a column mask on column SSN might change the result of the aggregate function COUNT(DISTINCT SSN) because the DISTINCT operation is performed on the masked values. However, if the expression in the query is the same as the expression that is used to mask the column value in the definition of the column mask, the result of the expression might remain unchanged. For example, the expression in the query is 'XXX-XX-' || SUBSTR(SSN, 8, 4) and the same expression appears in the definition of the column mask. In this particular example, you can remove the expression from the query to avoid the same expression being evaluated twice.

Conflicts between the definition of a column mask and SQL: A column mask is created as a standalone object, without knowing all of the contexts in which it might be used. To mask the value of a column in the final result table, the definition of the column mask is merged into a query by Db2. When the definition of the column mask is brought into the context of the statement, it might conflict with certain SQL semantics in the statement. Therefore, in some situations, the combination of the statement and the application of the column mask can return an error. When this happens, either the statement needs to be modified or the column mask must be dropped or recreated with a different definition.

Column masks and null columns: If the column is not nullable, the definition of its column mask will not, most likely, consider a null value for the column. After the column access control is activated for the table, if the table is the null-padded table in an outer join, the value of the column in the final result table might be a null. To ensure that the column mask can mask a null value, if the table is the null-padded table in an outer join, Db2 will add "WHEN target-column IS NULL THEN NULL" as the first WHEN clause to the column mask definition. This forces a null value to always be masked as a null value. For a nullable column, this removes the ability to mask a null value as something else. Example 4 shows this added WHEN clause.

Column mask values for SQL data change statements: For INSERT, UPDATE, and MERGE, when a column is referenced while deriving the values of a new row, if that column has an enabled column mask, the masked value is used to derive the new values. If the object table also has column access control activated, the column mask that is applied to derive the new values must return the column itself, not a constant or an expression. If the column mask does not mask the column to itself, the new value cannot be used for insert or update and an error is returned. The rules that are used to apply column masks in order to derive the new values follow the same rules for the final result table of a query. See the data change statements for how the column masks are used to affect the insertability and updatability.

Column masks and trigger transition variables: Values for OLD ROW and OLD TABLE transition variables will never contain masked values.

A SET *transition-variable* assignment statement can assign masked data to the variable. If a violation check constraint does not exist for the column, the masked data will be inserted or updated in the table's column and no error will be issued.

Column masks that are created before column access control is activated: The CREATE MASK statement is an independent statement that can be used to create a column access control mask before column access control is activated for a table. The only requirement is that the table and the columns exist before the mask is created. Multiple column masks can be created for a table but a column can have only one mask. The definition of a mask is stored in the Db2 catalog. Dependency on the table for which the mask is being created and dependencies on other objects referenced in the definition are recorded. A column mask can be created as enabled or disabled for column access control. An enabled column mask does not take effect until the ALTER TABLE statement with the ACTIVATE COLUMN ACCESS CONTROL clause is used to activate column access control for the table. A disabled column mask remains ineffective even when column access control is activated for the table. The ALTER MASK statement can be used to alter between ENABLE and DISABLE. After column access control is activated for a table, when the table is referenced in a data manipulation statement, all enabled column masks that have been created for the table are implicitly applied by Db2 to mask the values returned for the columns referenced in the final result table of the queries or to determine the new values used in the data change statements.

Column masks that are created after column access control is activated: The enabled column masks become effective as soon as they are committed. Thereafter, when the table is referenced in a data manipulation statement, all enabled column masks are implicitly applied by Db2 to the statement. Any disabled column mask remains ineffective even when column access control is activated for the table.

No cascaded effect when column or row access control enforced tables are referenced in column mask definitions: A column mask definition may reference tables and columns that are currently enforced by row or column access control. Access control from those tables and columns is ignored when the table for which the column mask is being created is referenced in a data manipulation statement.

Examples

Example 1: After column access control is activated for table EMPLOYEE, Paul from the payroll department can see the social security number of the employee whose employee number is 123456. Mary, who is a manager, can see only the last four characters of the social security number. Peter who is neither cannot see the social security number.

```
CREATE MASK SSN_MASK ON EMPLOYEE
FOR COLUMN SSN RETURN
CASE
  WHEN (VERIFY_GROUP_FOR_USER(SESSION_USER, 'PAYROLL') = 1)
    THEN SSN
  WHEN (VERIFY_GROUP_FOR_USER(SESSION_USER, 'MGR') = 1)
    THEN 'XXX-XX-' || SUBSTR(SSN,8,4)
  ELSE NULL
END
ENABLE;

COMMIT;

ALTER TABLE EMPLOYEE
ACTIVATE COLUMN ACCESS CONTROL;

COMMIT;

SELECT SSN FROM EMPLOYEE
WHERE EMPNO = 123456;
```

Example 2: In the SELECT statement, column SSN is embedded in an expression that is the same as the expression used in the column mask SSN_MASK. After column access control is activated for table EMPLOYEE, the column mask SSN_MASK is applied to column SSN in the SELECT statement. For this particular expression, the SELECT statement produces the same result as before column access control is activated for all users. The user can replace the expression in the SELECT statement with column SSN to avoid the same expression getting evaluated twice.

```
CREATE MASK SSN_MASK ON EMPLOYEE
FOR COLUMN SSN RETURN
CASE
  WHEN (1 = 1)
    THEN 'XXX-XX-' || SUBSTR(SSN,8,4)
  ELSE NULL
END
ENABLE;

COMMIT;

ALTER TABLE EMPLOYEE
ACTIVATE COLUMN ACCESS CONTROL;

COMMIT;

SELECT 'XXX-XX-' || SUBSTR(SSN,8,4) FROM EMPLOYEE
WHERE EMPNO = 123456;
```

Example 3: Employee with EMPNO 123456 earns bonus \$8000 and salary \$80000 in May. When the manager retrieves his salary, the manager receives his salary, not the null value. This is because of no

cascaded effect when column mask SALARY_MASK references column BONUS for which column mask BONUS_MASK is defined.

```
CREATE MASK SALARY_MASK ON EMPLOYEE
FOR COLUMN SALARY RETURN
CASE
  WHEN (BONUS < 10000)
  THEN SALARY
  ELSE NULL
END
ENABLE;

COMMIT;

CREATE MASK BONUS_MASK ON EMPLOYEE
FOR COLUMN BONUS RETURN
CASE
  WHEN (BONUS > 5000)
  THEN NULL
  ELSE BONUS
END
ENABLE;

COMMIT;

ALTER TABLE EMPLOYEE
ACTIVATE COLUMN ACCESS CONTROL;

COMMIT;

SELECT SALARY FROM EMPLOYEE
WHERE EMPNO = 123456;
```

Example 4: This example shows Db2 adds "WHEN target-column IS NULL THEN NULL" as the first WHEN clause to the column mask definition then merges the column mask definition into the statement.

```
CREATE TABLE EMPLOYEE (EMPID INT,
                        DEPTID CHAR(8),
                        SALARY DEC(9,2) NOT NULL,
                        BONUS DEC(9,2));

CREATE MASK SALARY_MASK ON EMPLOYEE
FOR COLUMN SALARY RETURN
CASE
  WHEN SALARY < 10000
  THEN CAST(SALARY*2 AS DEC(9,2))
  ELSE COALESCE(CAST(SALARY/2 AS DEC(9,2)), BONUS)
END
ENABLE;

COMMIT;

CREATE MASK BONUS_MASK ON EMPLOYEE
FOR COLUMN BONUS RETURN
CASE
  WHEN BONUS > 1000
  THEN BONUS
  ELSE NULL
END
ENABLE;

COMMIT;

ALTER TABLE EMPLOYEE
ACTIVATE COLUMN ACCESS CONTROL;

COMMIT;

SELECT SALARY FROM DEPT
LEFT JOIN EMPLOYEE ON DEPTNO = DEPTID;

/* When SALARY_MASK is effectively merged into the above statement,
* 'WHEN SALARY IS NULL THEN NULL' is added by Db2 as the
* first WHEN clause, as follows:
*/

SELECT CASE WHEN SALARY IS NULL THEN NULL
           WHEN SALARY < 10000 THEN CAST(SALARY*2 AS DEC(9,2))
           ELSE COALESCE(CAST(SALARY/2 AS DEC(9,2)), BONUS)
```



```
END SALARY  
FROM DEPT  
LEFT JOIN EMPLOYEE ON DEPTNO = DEPTID;
```

CREATE PERMISSION

The CREATE PERMISSION statement creates a row permission for row access control at the current server. It determines the rows within a table that are available based on the result of the *search-condition*.

Invocation

This statement can be embedded in an application program or issued interactively. It is an executable statement that can be dynamically prepared.

Authorization

The authorization ID of the statement must have security administrator authority. See [“Administrative authority”](#) on page 15.

Syntax

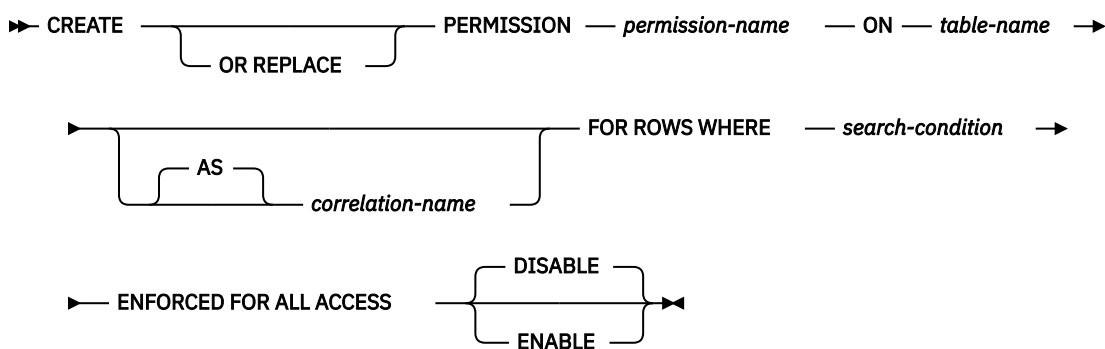

Description

OR REPLACE

Specifies to replace the definition for the row permission if one exists at the current server. The existing definition is effectively dropped before the new definition is replaced in the catalog.

permission-name

Names the row permission for row access control. The name, including the implicit or explicit qualifier, must not be the same as a column mask or a row permission that already exists at the current server. The *permission-name* cannot start with QIBM.

If SQL names were specified, the permission will be created in the schema specified by the implicit or explicit qualifier.

If system names were specified, the permission will be created in the schema that is specified by the qualifier. If not qualified and there is no default schema, the permission will be created in the same schema as the *table-name*.

The schema name for the *permission-name* must be the same as the schema name for *table-name*.

table-name

Identifies the table on which the column permission is created. The name must identify a table that exists at the current server. It must not identify a declared temporary table, table in QTEMP, distributed table, view, logical file, member alias, file with read triggers, or catalog table.

correlation-name

Specifies a correlation name that can be used within *search-condition* to designate the table.

FOR ROWS WHERE

Indicates that a row permission is created. A row permission specifies a search condition under which rows of the table can be accessed.

search-condition

Specifies a condition that can be true, false, or unknown for a row of the table.

The *search-condition* follows the same rules used by the search condition in a WHERE clause. In addition, it must not reference any of the following:

- The table for which the row permission is being defined
- A declared global temporary table
- A variable (host variable, SQL variable, SQL parameter, or trigger transition variable)
- A parameter marker
- A user-defined function that is defined as NOT SECURED
- A function that is not deterministic⁹⁷ or has an external action
- An RRN, RID, HASHED_VALUE, DATAPARTITIONNAME, DATAPARTITIONNUM, DBPARTITIONNAME, or DBPARTITIONNUM function that references the table for which the row permission is being defined
- An OLAP specification
- A ROW CHANGE expression
- A sequence reference
- A * or *name.** in a select clause
- A table in QTEMP
- A member alias
- A distributed table
- A file with read triggers
- A multi-format logical file
- A remote object
- A view that contains any of the above

ENFORCED FOR ALL ACCESS

Specifies that the row permission applies to all references of the table. If row access control is activated for the table, when the table is referenced in a data manipulation statement, Db2 implicitly applies the row permission to control the access of the table. If the reference of the table is for a fetch operation such as SELECT, the application of the row permission determines what set of rows can be retrieved by the user who requested the fetch operation. If the reference of the table is for a data change operation such as INSERT, the application of the row permission determines whether all rows to be changed are insertable or updatable by the user who requested the data change operation.

ENABLE or DISABLE

Specifies that the row permission is to be initially enabled or disabled for row access control.

DISABLE

Specifies that the row permission is to be disabled for row access control. The row permission will remain ineffective regardless of whether row access control is activated for the table or not. This is the default.

ENABLE

Specifies that the row permission is to be enabled for row access control. If row access control is not currently activated for this table, the row permission will become effective when row access control is activated for the table. If row access control is currently activated for the table, the row permission becomes effective immediately.

Notes

Prerequisites: In order to create a permission, IBM Advanced Data Security must be installed.

⁹⁷ STATEMENT DETERMINISTIC functions are allowed but are not recommended.

How row permissions are applied and how they affect certain statements: See the ALTER TABLE statement with the ACTIVATE ROW ACCESS CONTROL clause for information on how to activate row access control and how row permissions are applied. See the description of subselect for information on how the application of row permissions affects the fetch operation. See the data change statements for information on how the application of row permissions affects the data change operation.

Row permissions that are created before row access control is activated for a table: The CREATE PERMISSION statement is an independent statement that can be used to create a row permission before row access control is activated for a table. The only requirement is that the table and the columns exist before the permission is created. Multiple row permissions can be created for a table.

The definition of the row permission is stored in the Db2 catalog. Dependency on the table for which the permission is being created and dependencies on other objects referenced in the definition are recorded. A row permission can be created as enabled or disabled for row access control. An enabled row permission does not take effect until the ALTER TABLE statement with the ACTIVATE ROW ACCESS CONTROL clause is used to activate row access control for the table. A disabled row permission remains ineffective even when row access control is activated for the table. The ALTER PERMISSION statement can be used to alter between ENABLE and DISABLE.

After row access control is activated for a table, when the table is referenced in a data manipulation statement, all enabled row permissions that are defined for the table are implicitly applied by Db2 to control access to the table.

Row permissions that are created after row access control is activated for a table: An enabled row permission becomes effective as soon as it is committed. Thereafter, when the table is referenced in a data manipulation statement, all enabled row permissions are implicitly applied to the statement. Any disabled row permission remains ineffective even when row access control is activated for the table.

No cascaded effect when row or column access control enforced tables are referenced in row permission definitions: A row permission definition may reference tables and columns that are currently enforced by row or column access control. Access control from those tables is ignored when the table for which the row permission is being created is referenced in a data manipulation statement.

DECRESULT option for permissions: The DECRESULT option for permissions will always use maximum precision of 63, maximum scale of 63, and minimum divide scale of 0.

Examples

Example 1: Secure user-defined function ACCOUNTING_UDF in row permission SALARY_ROW_ACCESS processes the sensitive data in column SALARY. After row access control is activated for table EMPLOYEE, Accountant Paul retrieves the salary of employee with EMPNO 123456 who is making \$100,000 a year. Paul may or may not see the row depending on the output value from user-defined function ACCOUNTING_UDF.

```
CREATE PERMISSION SALARY_ROW_ACCESS ON EMPLOYEE
  FOR ROWS WHERE VERIFY_GROUP_FOR_USER(SESSION_USER, 'MGR', 'ACCOUNTING') = 1
  AND
  ACCOUNTING_UDF(SALARY) < 120000
  ENFORCED FOR ALL ACCESS
  ENABLE;

COMMIT;

ALTER TABLE EMPLOYEE
  ACTIVATE ROW ACCESS CONTROL;

COMMIT;

SELECT SALARY FROM EMPLOYEE
  WHERE EMPNO = 123456;
```

Example 2: The tellers in a bank can only access customers from their branch. All tellers have secondary authorization ID TELLER. The customer service representatives are allowed to access all customers of the bank. All customer service representatives have secondary authorization ID CSR. A row permission is created for each group of personnel in the bank according to the access rules defined by someone with

security administrator authority. After row access control is activated for table CUSTOMER, in a SELECT statement the search conditions of both row permissions are merged into the statement and they are combined with the logical OR operator to control the set of rows accessible by each group.

```
CREATE PERMISSION TELLER_ROW_ACCESS ON CUSTOMER
FOR ROWS WHERE VERIFY_GROUP_FOR_USER(SESSION_USER, 'TELLER') = 1
AND
    BRANCH = (SELECT HOME_BRANCH FROM INTERNAL_INFO
              WHERE EMP_ID = SESSION_USER)
ENFORCED FOR ALL ACCESS
ENABLE;

COMMIT;

CREATE PERMISSION CSR_ROW_ACCESS ON CUSTOMER
FOR ROWS WHERE VERIFY_GROUP_FOR_USER(SESSION_USER, 'CSR') = 1
ENFORCED FOR ALL ACCESS
ENABLE;

COMMIT;

ALTER TABLE CUSTOMER
ACTIVATE ROW ACCESS CONTROL;

COMMIT;

SELECT * FROM CUSTOMER;
```

CREATE PROCEDURE

The CREATE PROCEDURE statement defines a procedure at the current server.

The following types of procedures can be defined:

- External

The procedure program or service program is written in a programming language such as C, COBOL, or Java. The external executable is referenced by a procedure defined at the current server along with various attributes of the procedure. See [“CREATE PROCEDURE \(external\)” on page 1065](#).

- SQL

The procedure is written exclusively in SQL. The body of an SQL procedure is written in the SQL procedural language, SQL PL. The procedure body is defined at the current server along with various attributes of the procedure. See [“CREATE PROCEDURE \(SQL\)” on page 1080](#).

Notes

Choosing data types for parameters: For portability of procedures across platforms that are not Db2 for i, do not use the following data types, which might have different representations on different platforms:

- FLOAT. Use DOUBLE or REAL instead.
- NUMERIC. Use DECIMAL instead.

Specifying AS LOCATOR for a parameter: Passing a locator instead of a value can result in fewer bytes being passed in or out of the procedure. This can be useful when the value of the parameter is very large. The AS LOCATOR clause specifies that a locator to the value of the parameter is passed instead of the actual value. Specify AS LOCATOR only for parameters with a LOB or XML data type or a distinct type based on a LOB or XML data type.

AS LOCATOR cannot be specified for SQL procedures.

Determining the uniqueness of procedures in a schema: At the current server, each procedure signature must be unique. The signature of a procedure is the qualified procedure name combined with the number of the parameters (the data types of the parameters are not part of a procedure's signature). This means that two different schemas can each contain a procedure with the same name that have the same number of parameters. However, a schema must not contain two procedures with the same name that have the same number of parameters.

The specific name for a procedure: When defining multiple procedures with the same name and schema (with different number of parameters), it is recommended that a specific name also be specified. The specific name can be used to uniquely identify the procedure when dropping, granting to, revoking from, or commenting on the procedure.

If *specific-name* is not specified, it is the same as the procedure name. If a function or procedure with that specific name already exists, a unique name is generated similar to the rules used to generate unique table names.

Special registers in procedures: The settings of the special registers of the caller are inherited by the procedure when called and restored upon return to the caller. Special registers may be changed within a procedure, but these changes do not affect the caller.

CREATE PROCEDURE (external)

The CREATE PROCEDURE (external) statement defines an external procedure at the current server.

Invocation

This statement can be embedded in an application program or issued interactively. It is an executable statement that can be dynamically prepared.

Authorization

The privileges held by the authorization ID of the statement must include at least one of the following:

- For the SYSPROCS catalog view and SYSPARMS catalog table:
 - The INSERT privilege on the table, and
 - The USAGE privilege on schema QSYS2
- Database administrator authority

If the external program or service program exists, the privileges held by the authorization ID of the statement must include at least one of the following:

- For the external program or service program that is referenced in the SQL statement:
 - The USAGE privilege on the schema that contains the external program or service program.
 - The system authority *EXECUTE on the external program or service program, and
 - The system authority *CHANGE on the program or service program. The system needs this authority to update the program or service program object to contain the information necessary to save/restore the procedure to another system. If user does not have this authority, the procedure is still created, but the program or service program object is not updated.
- Database administrator authority

If a distinct type or array type is referenced, the privileges held by the authorization ID of the statement must include at least one of the following:

- For each distinct type or array type identified in the statement:
 - The USAGE privilege on the type, and
 - The USAGE privilege on the schema containing the distinct type or array type
- Database administrator authority

To replace an existing procedure, the privileges held by the authorization ID of the statement must include at least one of the following:

- The following system authorities:
 - The system authority of *OBJMGT on the program object associated with the procedure
 - All authorities needed to DROP the procedure
 - The system authority *READ to the SYSPROCS catalog view and SYSPARMS catalog table
- Database administrator authority

For information about the system authorities corresponding to SQL privileges, see [Corresponding System Authorities When Checking Privileges to a Function or Procedure](#) and [Corresponding System Authorities When Checking Privileges to a Distinct Type](#).

Syntax

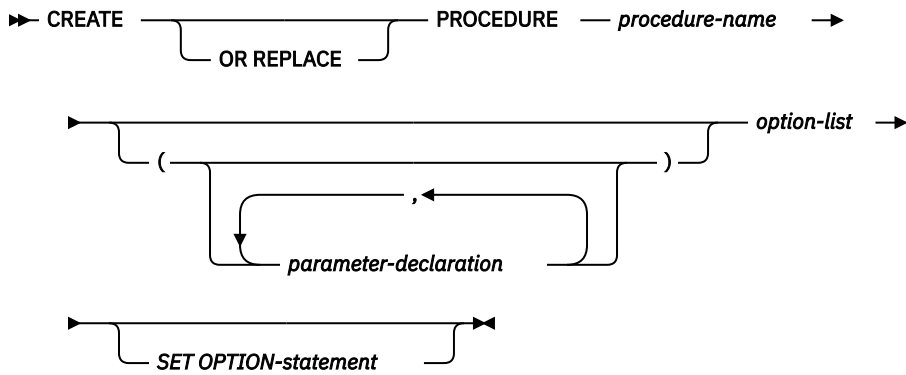

parameter-declaration

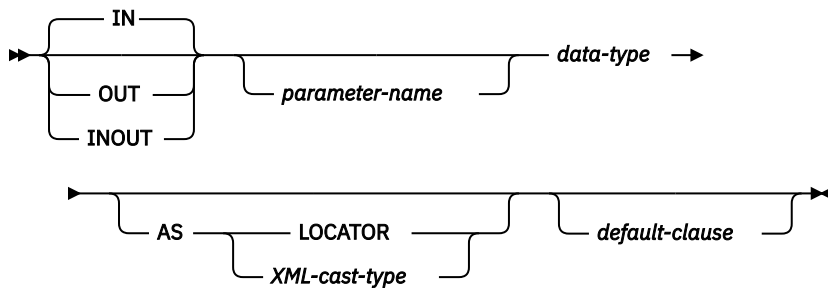

data-type

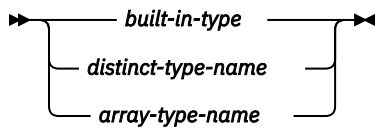

default-clause

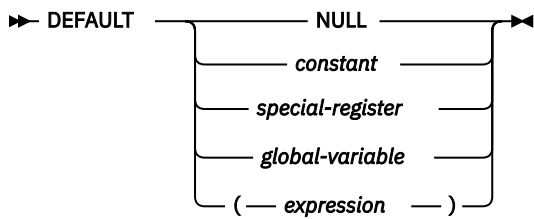

XML-cast-type

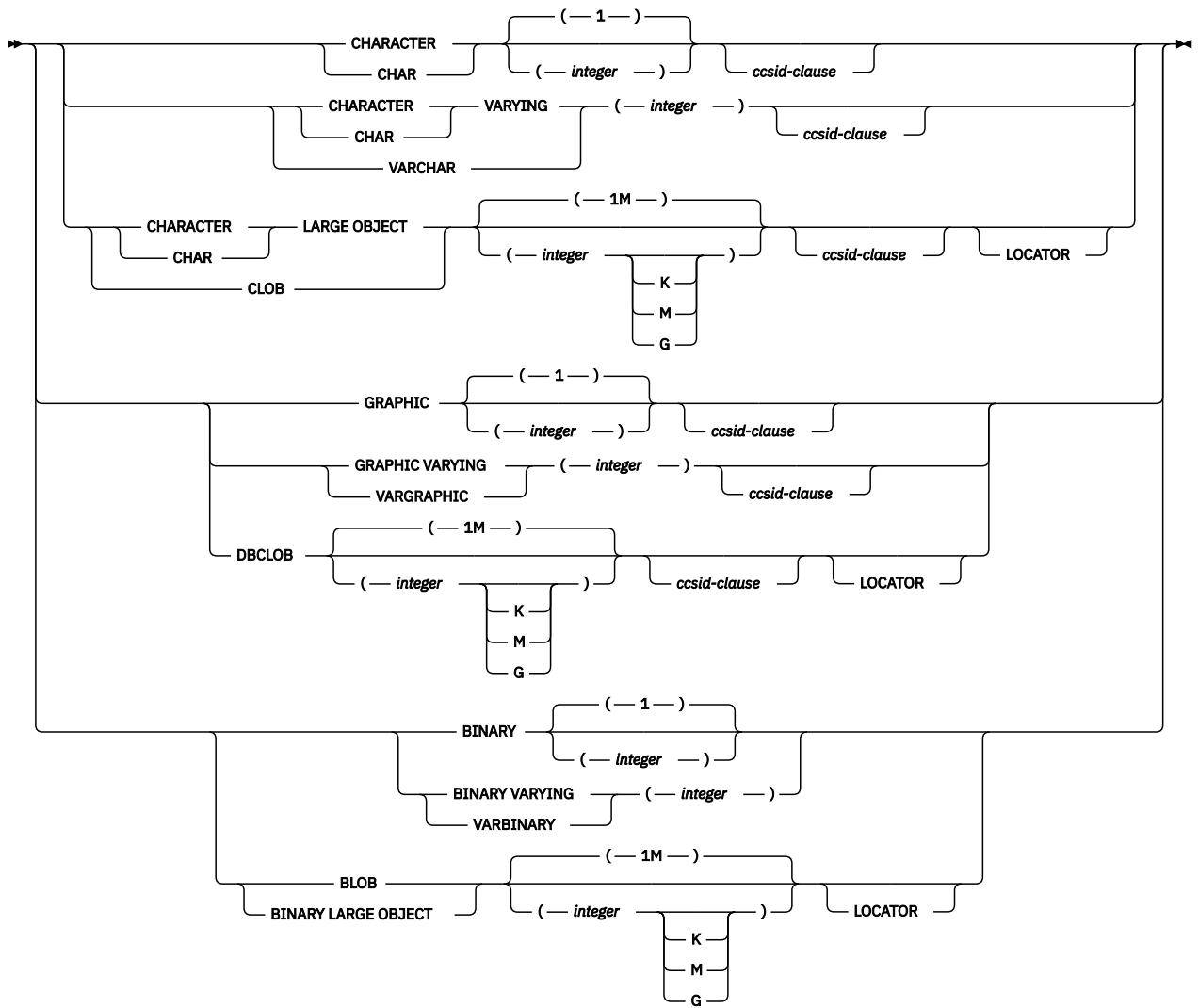

option-list

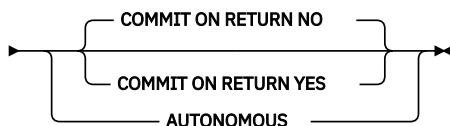
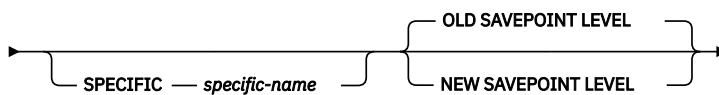
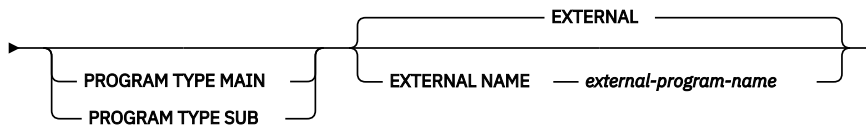
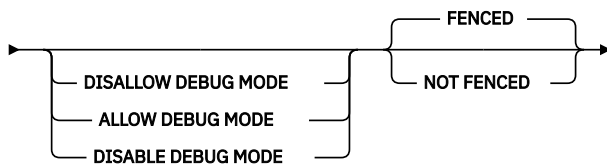
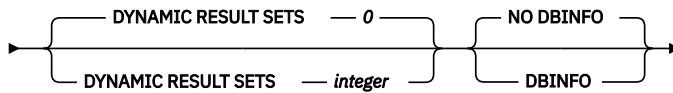
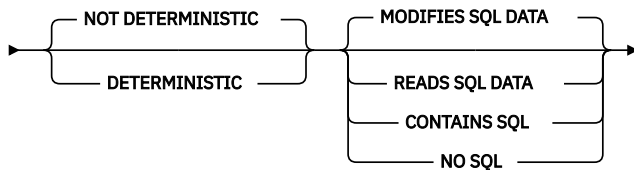
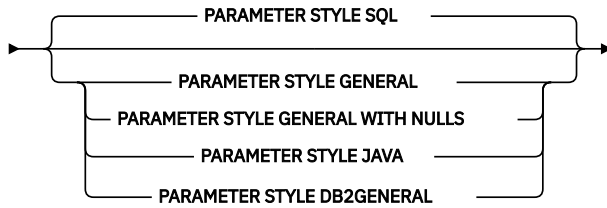
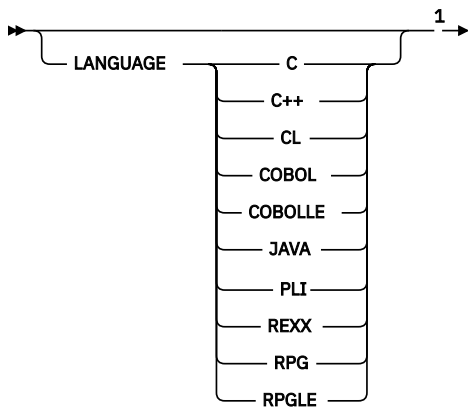

Notes:

¹ The optional clauses can be specified in a different order.

built-in-type

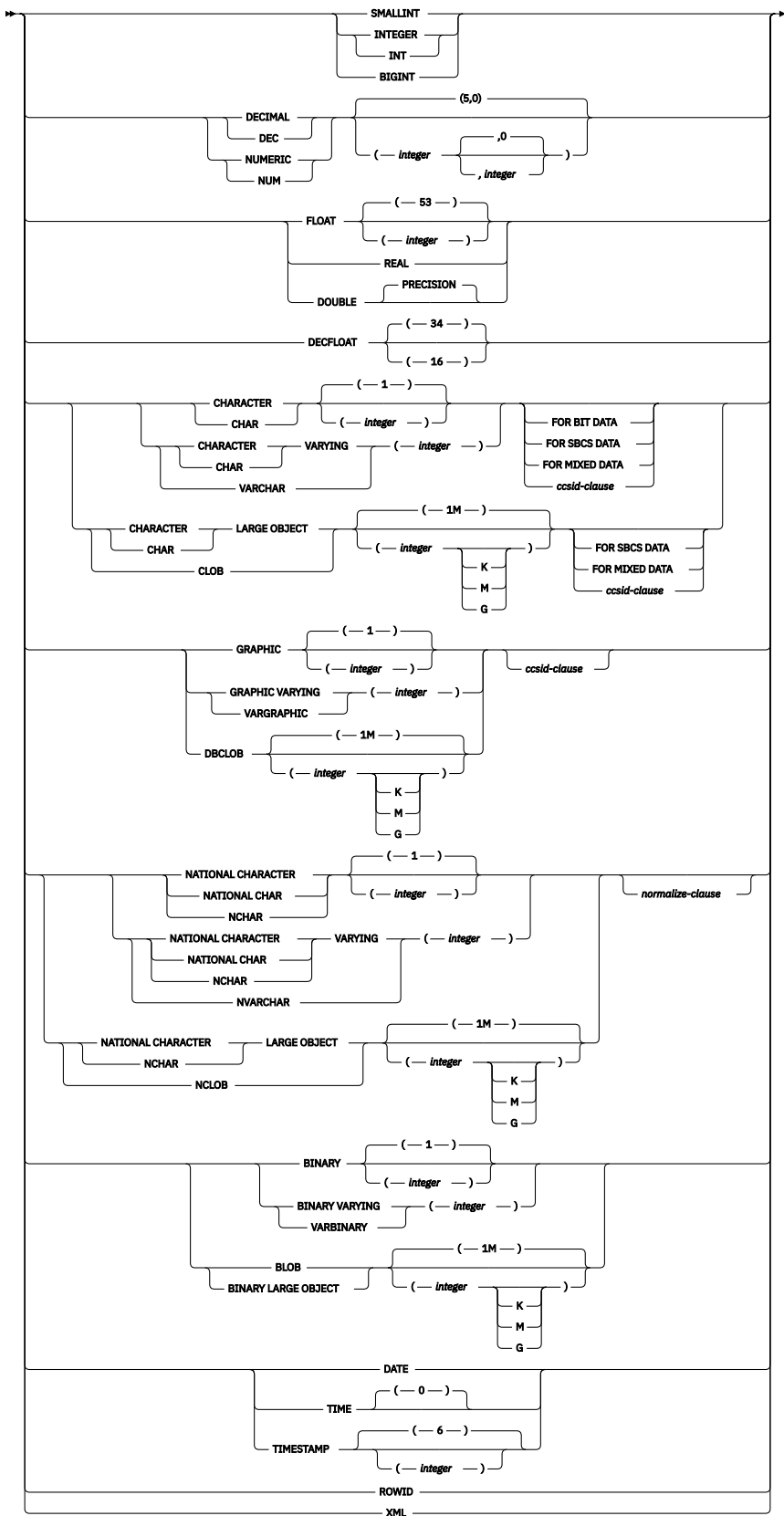

ccsid-clause

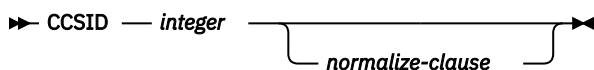

normalize-clause



Description

OR REPLACE

Specifies to replace the definition for the procedure if one exists at the current server. The existing definition is effectively dropped before the new definition is replaced in the catalog with the exception that privileges that were granted on the procedure are not affected. This option is ignored if a definition for the procedure does not exist at the current server. To replace an existing procedure, the *specific-name* and *procedure-name* of the new definition must be the same as the *specific-name* and *procedure-name* of the old definition, or the signature of the new definition must match the signature of the old definition. Otherwise, a new procedure is created.

procedure-name

Names the procedure. The combination of name, schema name, and the number of parameters must not identify a procedure that exists at the current server unless OR REPLACE is specified.

For SQL naming, the procedure will be created in the schema specified by the implicit or explicit qualifier.

For system naming, the procedure will be created in the schema specified by the qualifier. If no qualifier is specified:

- If the value of the CURRENT SCHEMA special register is *LIBL, the procedure will be created in the current library (*CURLIB).
- Otherwise, the procedure will be created in the current schema.

(parameter-declaration,...)

Specifies the number of parameters of the procedure and the data type of each parameter. A parameter for a procedure can be used only for input, only for output, or for both input and output. All parameters are nullable. Although not required, you can give each parameter a name.

The maximum number of parameters allowed in CREATE PROCEDURE depends on the type of language and the parameter style:

- For JAVA and ILE programs and service programs, the maximum is 2000.
- For OPM programs and REXX,
 - If PARAMETER STYLE GENERAL is specified the maximum is 255.
 - If PARAMETER STYLE GENERAL WITH NULLS is specified the maximum is 254.
 - If PARAMETER STYLE SQL is specified the maximum is 254.

The maximum number of parameters can be further limited by the maximum number of parameters allowed by the language.

IN

Identifies the parameter as an input parameter to the procedure. Any changes made to the parameter within the procedure are not available to the calling SQL application when control is returned.⁹⁸ The default is IN.

OUT

Identifies the parameter as an output parameter that is returned by the procedure.

A DataLink or a distinct type based on a DataLink cannot be specified as an output parameter.

⁹⁸ When the language type is REXX, all parameters must be input parameters.

INOUT

Identifies the parameter as both an input and output parameter for the procedure. If an INOUT parameter is defined with a default and the default is used when calling the procedure, no value for the parameter is returned.

A DataLink or a distinct type based on a DataLink cannot be specified as an input and output parameter.

parameter-name

Names the parameter. The name cannot be the same as any other *parameter-name* for the procedure.

data-type

Specifies the data type of the parameter.

built-in-type

Specifies a built-in data type. For a more complete description of each built-in data type, see [“CREATE TABLE” on page 1105](#).

distinct-type-name

Specifies a distinct type. Any length, precision, scale, or encoding scheme attributes for the parameter are those of the source type of the distinct type as specified using [“CREATE TYPE \(distinct\)” on page 1184](#).

If the name of the distinct type is unqualified, the database manager resolves the schema name by searching the schemas in the SQL path.

array-type-name

Specifies an array type. Array types are only supported for LANGUAGE JAVA. To use an array type as a parameter for a Java stored procedure, the parameter style must be JAVA.

If the name of the array type is unqualified, the database manager resolves the schema name by searching the schemas in the SQL path.

If a CCSID is specified, the parameter will be converted to that CCSID before passing it to the procedure. If a CCSID is not specified, the CCSID is determined by the default CCSID at the current server at the time the procedure is invoked.

Date, time, and timestamp parameters are passed to the procedure as character strings in ISO format.

Some data types are not supported in all languages. For details on the mapping between the SQL data types and host language data types, see [Embedded SQL Programming](#) topic collection. Built-in data type specifications can be specified if they correspond to the language that is used to write the procedure.

Any parameter that has an XML type must specify either the *XML-cast-type* clause or the AS LOCATOR clause.

AS LOCATOR

Specifies that the parameter is a locator to the value rather than the actual value. You can specify AS LOCATOR only if the parameter has a LOB or XML data type or a distinct type based on a LOB or XML data type. If AS LOCATOR is specified, FOR SBCS DATA or FOR MIXED DATA must not be specified.

AS XML-cast-type

Specifies the data type passed to the procedure for a parameter that is XML type or a distinct type based on XML type. If LOCATOR is specified, the parameter is a locator to the value rather than the actual value.

If a CCSID value is specified, only Unicode CCSID values can be specified for graphic data types. If a CCSID value is not specified, the CCSID is established at the time the procedure is created according to the SQL_XML_DATA_CCSID QAQQINI option setting. The default CCSID is 1208. See [“XML Values” on page 80](#) for a description of this option.

default

Specifies a default value for the parameter. The default can be a constant, a special register, a global variable, an expression, or the keyword NULL. The expression is any expression defined in “Expressions” on page 159, that does not include an aggregate function or column name. If a default value is not specified, the parameter has no default and cannot be omitted on invocation of the procedure. The maximum length of the expression string is 64K.

The default expression must not modify SQL data. The expression must be assignment compatible to the parameter data type. All objects referenced in a default expression must exist when the procedure is created. When the procedure is called, the default will be evaluated using the authority of the invoker.

Any comma in the default expression that is intended as a separator of numeric constants in a list must be followed by a space.

A default cannot be specified:

- for an OUT parameter.
- for a parameter of type array.

LANGUAGE

Specifies the language that the external program or service program is written in. The language clause is required if the external program is a REXX procedure.

If LANGUAGE is not specified, the LANGUAGE is determined from the attribute information associated with the external program or service program at the time the procedure is created. If the attribute information associated with the program or service program does not identify a recognizable language or the program or service program cannot be found, then the language is assumed to be C.

C

The external program is written in C.

C++

The external program is written in C++.

CL

The external program is written in CL.

COBOL

The external program is written in COBOL.

COBOLLE

The external program is written in ILE COBOL.

JAVA

The external program is written in JAVA.

PLI

The external program is written in PL/I.

REXX

The external program is a REXX procedure.

RPG

The external program is written in RPG.

RPGLE

The external program is written in ILE RPG.

PARAMETER STYLE

Specifies the conventions used to pass parameters to and returning the values from procedures:

SQL

Specifies that in addition to the parameters on the CALL statement, several additional parameters are passed to the procedure. The parameters are defined to be in the following order:

- The first *n* parameters are the parameters that are specified on the CREATE PROCEDURE statement.

- n parameters for indicator variables for the parameters.
- A CHAR(5) output parameter for SQLSTATE. The SQLSTATE returned indicates the success or failure of the procedure. The SQLSTATE returned is assigned by the external program.
The user may set the SQLSTATE to any valid value in the external program to return an error or warning from the procedure.

- A VARCHAR(517) input parameter for the fully qualified procedure name.
- A VARCHAR(128) input parameter for the specific name.
- A VARCHAR(1000) output parameter for the message text.

The following additional parameter may be passed as the last parameter:

- A parameter for the dbinfo structure, if DBINFO was specified on the CREATE PROCEDURE statement.

These parameters are passed according to the specified LANGUAGE. For example, if the language is C or C++, the VARCHAR parameters are passed as NUL-terminated strings. For more information about the parameters passed, see the include sqludf in the appropriate source file in library QSYSINC. For example, for C, sqludf can be found in QSYSINC/H.

PARAMETER STYLE SQL cannot be used with LANGUAGE JAVA.

DB2GENERAL

Specifies that the procedure will use a parameter passing convention that is defined for use with Java methods.

PARAMETER STYLE DB2GENERAL can only be specified with LANGUAGE JAVA. For details on passing parameters in JAVA, see the [IBM Developer Kit for Java](#).

GENERAL

Specifies that the procedure will use a parameter passing mechanism where the procedure receives the parameters specified on the CALL. Additional arguments are not passed for indicator variables.

PARAMETER STYLE GENERAL cannot be used with LANGUAGE JAVA.

GENERAL WITH NULLS

Specifies that in addition to the parameters on the CALL statement as specified in GENERAL, another argument is passed to the procedure. This additional argument contains an indicator array with an element for each of the parameters of the CALL statement. In C, this would be an array of short INTs. For more information about how the indicators are handled, see the [SQL Programming](#) topic collection.

PARAMETER STYLE GENERAL WITH NULLS cannot be used with LANGUAGE JAVA.

JAVA

Specifies that the procedure will use a parameter passing convention that conforms to the Java language and ISO/IEC FCD 9075-13:2003, *Information technology - Database languages - SQL - Part 13: Java Routines and Types (SQL/JRT)* specification. INOUT and OUT parameters will be passed as single entry arrays to facilitate returning values.

PARAMETER STYLE JAVA can only be specified with LANGUAGE JAVA. For increased portability, you should write Java procedures that use the PARAMETER STYLE JAVA conventions. For details on passing parameters in JAVA, see the [IBM Developer Kit for Java](#) topic collection.

Note that the language of the external procedure determines how the parameters are passed. For example, in C, any VARCHAR or CHAR parameters are passed as NUL-terminated strings. For more information, see the [SQL Programming](#) topic collection. For Java routines, see the [IBM Developer Kit for Java](#) topic collection.

DETERMINISTIC or NOT DETERMINISTIC

Specifies whether the procedure returns the same results each time the procedure is called with the same IN and INOUT arguments. The default is NOT DETERMINISTIC.

NOT DETERMINISTIC

The procedure may not return the same result each time the procedure is called with the same IN and INOUT arguments, even when the referenced data in the database has not changed.

DETERMINISTIC

The procedure always returns the same results each time the procedure is called with the same IN and INOUT arguments, provided the referenced data in the database has not changed.

MODIFIES SQL DATA, READS SQL DATA, CONTAINS SQL, or NO SQL

Specifies the classification of SQL statements and nested routines that this procedure can execute. The database manager verifies that the SQL statements issued by the procedure, and all routines locally invoked by the procedure, are consistent with this specification. The verification is not performed when nested remote routines are invoked. For the classification of each statement, see [Appendix B, “Characteristics of SQL statements,” on page 1643](#). The default is MODIFIES SQL DATA. This option is ignored for parameter default expressions.

MODIFIES SQL DATA

Specifies that the procedure can execute any SQL statement except statements that are not supported in procedures.

READS SQL DATA

Specifies that the procedure can execute statements with a data access classification of READS SQL DATA, CONTAINS SQL, or NO SQL.

CONTAINS SQL

Specifies that the procedure can only execute statements with a data access classification of CONTAINS SQL or NO SQL.

NO SQL

Specifies that the procedure can execute only SQL statements with a data access classification of NO SQL.

CALLED ON NULL INPUT

Specifies that the procedure is to be called if any or all argument values are null. This specification means that the procedure must be coded to test for null argument values.

INHERIT SPECIAL REGISTERS

Specifies that existing values of special registers are inherited upon entry to the procedure.

FENCED or NOT FENCED

This parameter is allowed for compatibility with other products and is not used by Db2 for i.

DYNAMIC RESULT SETS *integer*

Specifies the maximum number of result sets that can be returned from the procedure. The minimum value for *integer* is zero and the maximum value is 32767.

If no DYNAMIC RESULT SETS clause is specified, result sets are returned for all cursors that remain open when the procedure ends.

Result sets are returned in the order in which the corresponding cursors are opened, unless a SET RESULT SETS statement is executed in the procedure. If the number of cursors that are still open for result sets when the procedure ends exceeds the maximum number specified on the DYNAMIC RESULT SETS clause, a warning is returned on the CALL statement and the number of result sets specified on the DYNAMIC RESULT SETS clause is returned.

If the SET RESULT SETS statement is issued, the number of results returned is the minimum of the number of result sets specified on this keyword and the SET RESULT SETS statement. If the SET RESULT SETS statement specifies a number larger than the maximum number of result sets, a warning is returned. Note that any result sets from cursors that have a RETURN TO CLIENT attribute are included in the number of result sets of the outermost procedure.

The result sets are scrollable if a cursor is used to return a result set and the cursor is scrollable. If a cursor is used to return a result set, the result set starts with the current position. Thus, if 5 FETCH NEXT operations have been performed before returning from the procedure, the result set starts with the 6th row of the result set.

Cursor result sets are only returned if the external program does not have an attribute of ACTGRP(*NEW).

For more information about result sets, see [“SET RESULT SETS” on page 1527](#).

DISALLOW DEBUG MODE, ALLOW DEBUG MODE, or DISABLE DEBUG MODE

Indicates whether the procedure is created so it can be debugged by the Unified Debugger. If DEBUG MODE is not specified, the procedure will be created with the debug mode specified by the CURRENT DEBUG MODE special register.

DEBUG MODE can only be specified with LANGUAGE JAVA.

DISALLOW DEBUG MODE

The procedure cannot be debugged by the Unified Debugger. When the DEBUG MODE attribute of the procedure is DISALLOW, the procedure can be subsequently altered to change the debug mode attribute.

ALLOW DEBUG MODE

The procedure can be debugged by the Unified Debugger. When the DEBUG MODE attribute of the procedure is ALLOW, the procedure can be subsequently altered to change the debug mode attribute.

DISABLE DEBUG MODE

The procedure cannot be debugged by the Unified Debugger. When the DEBUG MODE attribute of the procedure is DISABLE, the procedure cannot be subsequently altered to change the debug mode attribute.

PROGRAM TYPE

This parameter is allowed for compatibility with other products. It indicates whether the routine's external program is a program (*PGM) or a procedure in a service program (*SRVPGM).

SUB

Specifies that the procedure executes as a procedure in a service program. The external program must be a *SRVPGM object.

MAIN

Specifies that the routine executes as the main entry point in a program. The external program must be a *PGM object.

DBINFO

Specifies whether additional status information is passed to the procedure when it is called. The default is NO DBINFO.

NO DBINFO

Additional information is not passed.

DBINFO

An additional argument is passed when the procedure is called.

The argument is a structure that contains information such as the name of the current server, the application run-time authorization ID, and identification of the version and release of the database manager that called the procedure. See [Table 84 on page 1075](#) for further details. Detailed information about the DBINFO structure can be found in include sqludf in the appropriate source file in library QSYSINC. For example, for C, sqludf can be found in QSYSINC/H.

DBINFO is only allowed with PARAMETER STYLE SQL.

Field	Data Type	Description
Relational database	VARCHAR(128)	The name of the current server.
Authorization ID	VARCHAR(128)	The run-time authorization ID.

Table 84. DBINFO fields (continued)

Field	Data Type	Description
CCSID information	INTEGER INTEGER INTEGER INTEGER INTEGER INTEGER INTEGER INTEGER INTEGER INTEGER CHAR(8)	The CCSID information of the job. Three sets of three CCSIDs are returned. The following information identifies the three CCSIDs in each set: <ul style="list-style-type: none"> • SBCS CCSID • DBCS CCSID • Mixed CCSID Following the three sets of CCSIDs is an integer that indicates which set of three sets of CCSIDs is applicable and 8 bytes of reserved space. Each set of CCSIDs is for a different encoding scheme (EBCDIC, ASCII, and Unicode). If a CCSID is not explicitly specified for a parameter on the CREATE PROCEDURE statement, the input string is assumed to be encoded in the CCSID of the job at the time the procedure is executed. If the CCSID of the input string is not the same as the CCSID of the parameter, the input string passed to the external procedure will be converted before calling the external program.
Target column	VARCHAR(128) VARCHAR(128) VARCHAR(128)	Not applicable for a call to a procedure.
Version and release	CHAR(8)	The version, release, and modification level of the database manager.
Platform	INTEGER	The server's platform type.

EXTERNAL

Specifies that the CREATE PROCEDURE statement is being used to define a new procedure based on code written in an external programming language.

If NAME clause is not specified, "NAME *procedure-name*" is assumed. In this case, *procedure-name* must not be longer than 8 characters. The NAME clause is required for a LANGUAGE JAVA procedure since the default name is not valid for a Java procedure.

NAME external-program-name

Specifies the program or service program that will be executed when the procedure is called by the CALL statement. The program name must identify a program or service program that exists at the application server at the time the procedure is called. If the naming option is *SYS and the name is not qualified:

- The current path will be used to search for the program at the time the procedure is called.
- *LIBL will be used to search for the program or service program at the time COMMENT, GRANT, LABEL, or REVOKE operations are performed on the procedure.

The validity of the name is checked at the application server. If the format of the name is not correct, an error is returned.

The external program or service program need not exist at the time the procedure is created, but it must exist at the time the procedure is called.

CONNECT, SET CONNECTION, RELEASE, DISCONNECT, and SET TRANSACTION statements are not allowed in a procedure that is running on a remote application server. COMMIT and ROLLBACK statements are not allowed in an ATOMIC SQL procedure or in a procedure that is running on a connection to a remote application server.

SPECIFIC *specific-name*

Specifies a unique name for the function. For more information on specific names, see [Specifying a specific name for a procedure in “CREATE PROCEDURE” on page 1064.](#)

OLD SAVEPOINT LEVEL or NEW SAVEPOINT LEVEL

Specifies whether a new savepoint level is to be created on entry to the procedure.

OLD SAVEPOINT LEVEL

A new savepoint level is not created. Any SAVEPOINT statements issued within the procedure with OLD SAVEPOINT LEVEL implicitly or explicitly specified on the SAVEPOINT statement are created at the same savepoint level as the caller of the procedure. This is the default.

NEW SAVEPOINT LEVEL

A new savepoint level is created on entry to the procedure. Any savepoints set within the procedure are created at a savepoint level that is nested deeper than the level at which this procedure was invoked. Therefore, the name of any new savepoint set within the procedure will not conflict with any existing savepoints set in higher savepoint levels (such as the savepoint level of the calling program or service program) with the same name.

COMMIT ON RETURN

Specifies whether the database manager commits the transaction immediately on return from the procedure.

NO

The database manager does not issue a commit when the procedure returns. NO is the default.

YES

The database manager issues a commit if the procedure returns successfully. If the procedure returns with an error, a commit is not issued.

The commit operation includes the work that is performed by the calling application process and the procedure.⁹⁹

If the procedure returns result sets, the cursors that are associated with the result sets must have been defined as WITH HOLD to be usable after the commit.

AUTONOMOUS

Specifies that the procedure is executed in a unit of work that is independent from the calling application. When this option is specified the database always commits or rolls back the autonomous procedure's transactional work based on the SQLSTATE that is returned from the procedure. A SQLSTATE indication of unqualified success or warning will cause the transaction to be committed. All other SQLSTATES will cause the autonomous procedure's unit of work to be rolled back.

The invocation of any trigger, function, or procedure from within the autonomous procedure will be part of the autonomous procedure's unit of work unless the trigger, function, or procedure was explicitly created to run under a different activation group.

An autonomous procedure cannot be called directly or indirectly from another autonomous procedure.

If AUTONOMOUS is specified, DYNAMIC RESULT SETS 0 must be specified.

SET OPTION-statement

Specifies the options that will be used for parameter defaults. The default values for the options depend on the options in effect at create time. For more information, see [“SET OPTION” on page 1505.](#)

⁹⁹ If the external program or service program was created with ACTGRP(*NEW) and the job commitment definition is not used, the work that is performed in the procedure will be committed or rolled back as a result of the activation group ending.

The following options are used when processing default value expressions: ALWCPYDTA, CONACC, DATFMT, DATSEP, DECFLTRND, DECMPT, DECRESULT, DFTRDBCOL, LANGID, SQLCURRULE, SQLPATH, SRTSEQ, TGTRLS, TIMFMT, and TIMSEP. The options CNULRQD, CNULIGN, COMPILEOPT, EXTIND, NAMING, and SQLCA are not allowed in the CREATE PROCEDURE statement. Other options are accepted but will be ignored.

Notes

General considerations for defining procedures: See [“CREATE PROCEDURE”](#) on page 1064 for general information about defining procedures.

Language considerations: For information needed to create the programs for a procedure, see [Embedded SQL Programming](#).

REPLACE rules: When an external procedure is recreated by REPLACE:

- Any existing comment or label is discarded.
- If a different external program is specified:
 - Authorized users are not copied to the new program.
 - Journal auditing is not changed.
- Otherwise:
 - Authorized users are maintained. The object owner will not change.
 - Current journal auditing is not changed.

Error handling considerations: Values of arguments passed to a procedure which correspond to OUT parameters are undefined and those which correspond to INOUT parameters are unchanged when an error is returned by the procedure.

Creating the procedure: When an external procedure associated with an ILE external program or service program is created, an attempt is made to save the procedure's attributes in the associated program or service program object. If the *PGM or *SRVPGM object is saved and then restored to this or another system, the attributes are used to update the catalogs.

The attributes can be saved for external procedures subject to the following restrictions:

- The external program library must not be QSYS.
- The external program must exist when the CREATE PROCEDURE statement is issued.

If system naming is specified and the external program name is not qualified, the external program must be found in the library list.

- The external program must be an ILE *PGM or *SRVPGM object.

If the object cannot be updated, the procedure will still be created.

Calling the procedure: If a DECLARE PROCEDURE statement defines a procedure with the same name as a created procedure, and a static CALL statement where the procedure name is not identified by a variable is executed from the same source program, the attributes from the DECLARE PROCEDURE statement will be used rather than the attributes from the CREATE PROCEDURE statement.

The CREATE PROCEDURE statement applies to static and dynamic CALL statements as well as to a CALL statement where the procedure name is identified by a variable.

When an external procedure is invoked, it runs in whatever activation group was specified when the external program or service program was created. However, ACTGRP(*CALLER) should normally be used so that the procedure runs in the same activation group as the calling program.

The external program or service program for a procedure with the AUTONOMOUS attribute must be defined to run in activation group QSQAUTOAG. When an autonomous procedure is invoked in a job, every procedure that runs in the QSQAUTOAG activation group must have been created with the same storage model. They must all be *TERASPACE or all be *SNGLVL.

Setting of the default value: Parameters of a procedure that are defined with a default value are set to their default value when the procedure is invoked, but only if a value is not supplied for the corresponding argument, or the argument is specified as DEFAULT.

Notes for Java procedures: To be able to run Java procedures, you must have the [IBM Developer Kit for Java](#) installed on your system. Otherwise, an SQLCODE of -443 will be returned and a CPDB521 message will be placed in the job log.

If an error occurs while running a Java procedure, an SQLCODE of -443 will be returned. Depending on the error, other messages may exist in the job log of the job where the procedure was run.

Syntax alternatives: The following keywords are synonyms supported for compatibility to prior releases. These keywords are non-standard and should not be used:

- The keywords VARIANT and NOT VARIANT can be used as synonyms for NOT DETERMINISTIC and DETERMINISTIC.
- The keywords NULL CALL can be used as synonyms for CALLED ON NULL INPUT.
- The keywords SIMPLE CALL can be used as a synonym for GENERAL.
- The value DB2GENRL may be used as a synonym for DB2GENERAL.
- DYNAMIC RESULT SET, RESULT SETS, and RESULT SET may be used as synonyms for DYNAMIC RESULT SETS.
- The keywords PARAMETER STYLE in the PARAMETER STYLE clause are optional.
- The keywords PARAMETER STYLE DB2SQL can be used as a synonym for PARAMETER STYLE SQL.

Example

Example 1: Create the procedure definition for a procedure, written in Java, that is passed a part number and returns the cost of the part and the quantity that are currently available.

```
CREATE PROCEDURE PARTS_ON_HAND (IN PARTNUM INTEGER,
                                OUT COST DECIMAL(7,2),
                                OUT QUANTITY INTEGER)
LANGUAGE JAVA
PARAMETER STYLE JAVA
EXTERNAL NAME 'parts.onhand'
```

Example 2: Create the procedure definition for a procedure, written in C, that is passed an assembly number and returns the number of parts that make up the assembly, total part cost and a result set that lists the part numbers, quantity and unit cost of each part.

```
CREATE PROCEDURE ASSEMBLY_PARTS (IN ASSEMBLY_NUM INTEGER,
                                  OUT NUM_PARTS INTEGER,
                                  OUT COST DOUBLE)
LANGUAGE C
PARAMETER STYLE GENERAL
DYNAMIC RESULT SETS 1
FENCED
EXTERNAL NAME ASSEMBLY
```

CREATE PROCEDURE (SQL)

The CREATE PROCEDURE (SQL) statement creates an SQL procedure at the current server.

Invocation

This statement can be embedded in an application program or issued interactively. It is an executable statement that can be dynamically prepared.

Authorization

The privileges held by the authorization ID of the statement must include at least one of the following:

- The privilege to create in the schema. For more information, see [Privileges necessary to create in a schema](#).
- Database administrator authority

The privileges held by the authorization ID of the statement must include at least one of the following:

- For the SYSPROCS catalog view and SYSPARMS catalog table:
 - The INSERT privilege on the table, and
 - The USAGE privilege on schema QSYS2
- Database administrator authority

The privileges held by the authorization ID of the statement must include at least one of the following:

- The following system authorities:
 - *USE on the Create Program (CRTPGM) command, and
- Database administrator authority

If SQL names are specified and a user profile exists that has the same name as the library into which the procedure is created, and that name is different from the authorization ID of the statement, then the privileges held by the authorization ID of the statement must include at least one of the following:

- The system authority *ADD to the user profile with that name
- Database administrator authority

If a distinct type or array type is referenced, the privileges held by the authorization ID of the statement must include at least one of the following:

- For each distinct type or array type identified in the statement:
 - The USAGE privilege on the type, and
 - The USAGE privilege on the schema containing the distinct type or array type
- Database administrator authority

To replace an existing procedure, the privileges held by the authorization ID of the statement must include at least one of the following:

- The following system authorities:
 - The system authority of *OBJMGT on the program or service program object associated with the procedure
 - All authorities needed to DROP the procedure
 - The system authority *READ to the SYSPROCS catalog view and SYSPARMS catalog table
- Database administrator authority

For information on the system authorities corresponding to SQL privileges, see [Corresponding System Authorities When Checking Privileges to a Function or Procedure](#) and [Corresponding System Authorities When Checking Privileges to a Distinct Type](#).

Syntax

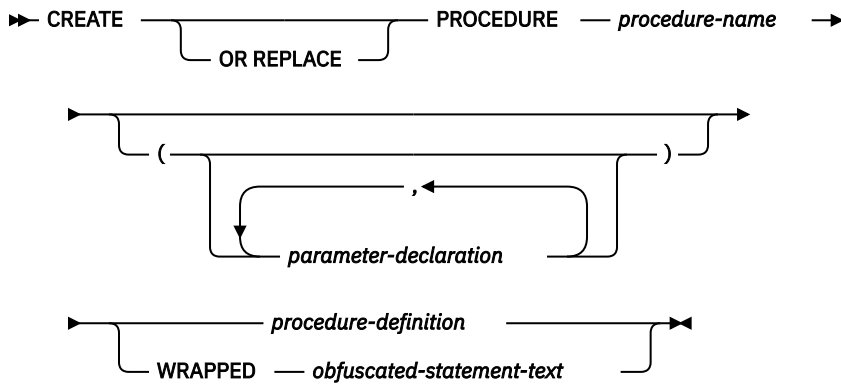

procedure-definition



parameter-declaration

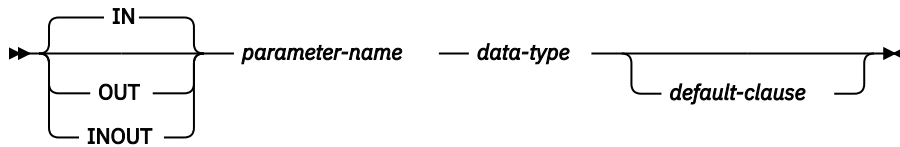

data-type

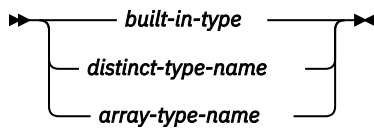

default-clause

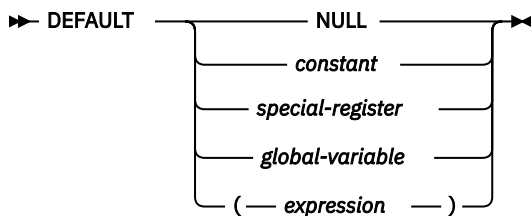

option-list

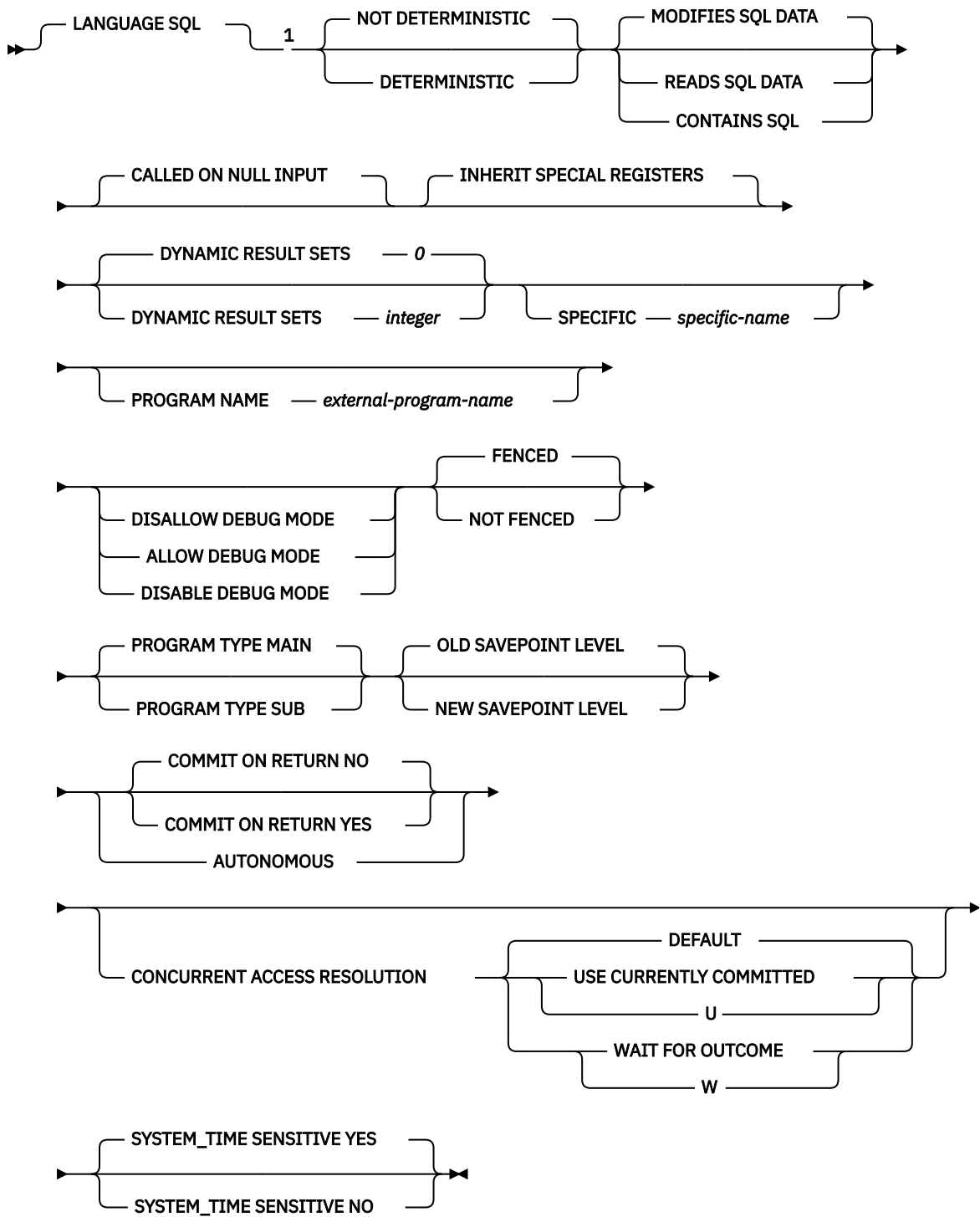

Notes:

¹ The optional clauses can be specified in a different order.

SQL-routine-body

<i>SQL-control-statement</i>
<i>ALLOCATE CURSOR-statement</i>
<i>ALLOCATE DESCRIPTOR-statement</i>
<i>ALTER FUNCTION-statement</i>
<i>ALTER MASK-statement</i>
<i>ALTER PERMISSION-statement</i>
<i>ALTER PROCEDURE-statement</i>
<i>ALTER SEQUENCE-statement</i>
<i>ALTER TABLE-statement</i>
<i>ALTER TRIGGER-statement</i>
<i>ASSOCIATE LOCATORS-statement</i>
<i>COMMENT-statement</i>
<i>COMMIT-statement</i>
<i>CONNECT-statement</i>
<i>CREATE ALIAS-statement</i>
<i>CREATE FUNCTION (external scalar)-statement</i>
<i>CREATE FUNCTION (external table)-statement</i>
<i>CREATE FUNCTION (sourced)-statement</i>
<i>CREATE INDEX-statement</i>
<i>CREATE MASK-statement</i>
<i>CREATE PERMISSION-statement</i>
<i>CREATE PROCEDURE (external)-statement</i>
<i>CREATE SCHEMA-statement</i>
<i>CREATE SEQUENCE-statement</i>
<i>CREATE TABLE-statement</i>
<i>CREATE TYPE-statement</i>
<i>CREATE VIEW-statement</i>
<i>DEALLOCATE DESCRIPTOR-statement</i>
<i>DECLARE GLOBAL TEMPORARY TABLE-statement</i>
<i>DELETE-statement</i>
<i>DESCRIBE-statement</i>
<i>DESCRIBE CURSOR-statement</i>
<i>DESCRIBE INPUT-statement</i>
<i>DESCRIBE PROCEDURE-statement</i>
<i>DESCRIBE TABLE-statement</i>
<i>DISCONNECT-statement</i>

SQL-routine-body (continued)

<i>DROP-statement</i>
<i>EXECUTE IMMEDIATE-statement</i>
<i>GET DESCRIPTOR-statement</i>
<i>GRANT-statement</i>
<i>INSERT-statement</i>
<i>LABEL-statement</i>
<i>LOCK TABLE-statement</i>
<i>MERGE-statement</i>
<i>REFRESH TABLE-statement</i>
<i>RELEASE-statement</i>
<i>RELEASE SAVEPOINT-statement</i>
<i>RENAME-statement</i>
<i>REVOKE-statement</i>
<i>ROLLBACK-statement</i>
<i>SAVEPOINT-statement</i>
<i>SELECT INTO-statement</i>
<i>SET CONNECTION-statement</i>
<i>SET CURRENT DEBUG MODE-statement</i>
<i>SET CURRENT DECFLOAT ROUNDING MODE-statement</i>
<i>SET CURRENT DEGREE-statement</i>
<i>SET CURRENT IMPLICIT XMLPARSE OPTION-statement</i>
<i>SET CURRENT TEMPORAL SYSTEM_TIME-statement</i>
<i>SET DESCRIPTOR-statement</i>
<i>SET ENCRYPTION PASSWORD-statement</i>
<i>SET PATH-statement</i>
<i>SET RESULT SETS-statement</i>
<i>SET SCHEMA-statement</i>
<i>SET TRANSACTION-statement</i>
<i>TRANSFER OWNERSHIP-statement</i>
<i>TRUNCATE-statement</i>
<i>UPDATE-statement</i>
<i>VALUES INTO-statement</i>

built-in-type

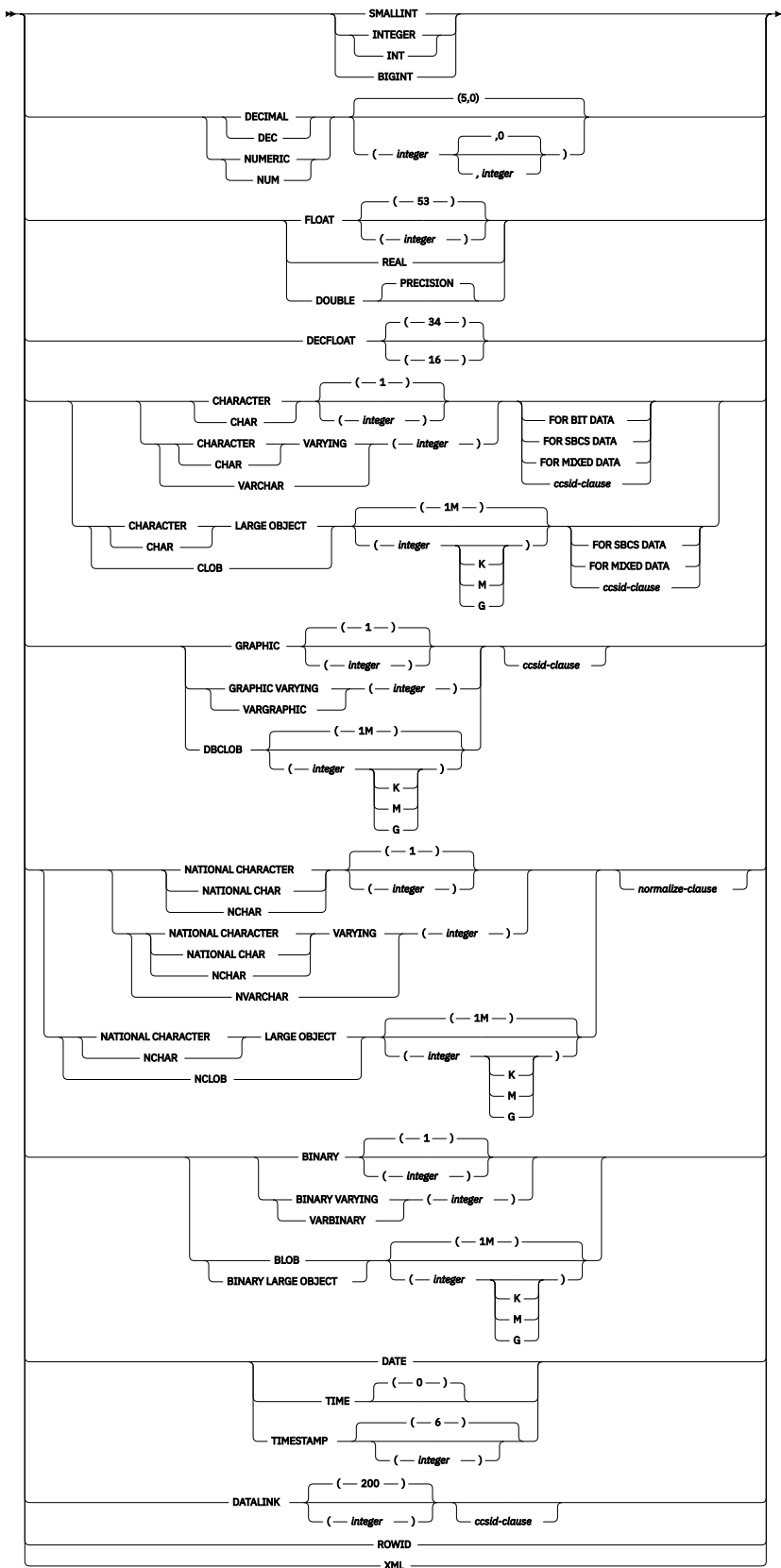

ccsid-clause

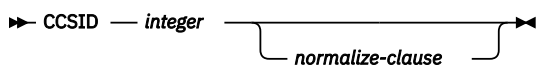

normalize-clause



Description

OR REPLACE

Specifies to replace the definition for the procedure if one exists at the current server. The existing definition is effectively dropped before the new definition is replaced in the catalog with the exception that privileges that were granted on the procedure are not affected. This option is ignored if a definition for the procedure does not exist at the current server. To replace an existing procedure, the *specific-name* and *procedure-name* of the new definition must be the same as the *specific-name* and *procedure-name* of the old definition, or the signature of the new definition must match the signature of the old definition. Otherwise, a new procedure is created.

procedure-name

Names the procedure. The combination of name, schema name, and the number of parameters must not identify a procedure that exists at the current server unless OR REPLACE is specified.

For SQL naming, the procedure will be created in the schema specified by the implicit or explicit qualifier.

For system naming, the procedure will be created in the schema specified by the qualifier. If no qualifier is specified:

- If the value of the CURRENT SCHEMA special register is *LIBL, the procedure will be created in the current library (*CURLIB).
- Otherwise, the procedure will be created in the current schema.

The *schema-name* cannot be QSYS2, QSYS, QTEMP, or SYSIBM.

(parameter-declaration,...)

Specifies the number of parameters of the procedure and the data type of each parameter. A parameter for a procedure can be used only for input, only for output, or for both input and output. All parameters are nullable.

The maximum number of parameters allowed in an SQL procedure is 2000.

IN

Identifies the parameter as an input parameter to the procedure. Any changes made to the parameter within the procedure are not available to the calling SQL application when control is returned. The default is IN.

A parameter that is an array of XML or LOB type is read only.

OUT

Identifies the parameter as an output parameter that is returned by the procedure. If the parameter is not set within the procedure, the null value is returned.

INOUT

Identifies the parameter as both an input and output parameter for the procedure. If the parameter is not set within the procedure, its input value is returned. If an INOUT parameter is defined with a default and the default is used when calling the procedure, no value for the parameter is returned.

parameter-name

Names the parameter. The name cannot be the same as any other *parameter-name* for the procedure.

data-type

Specifies the data type of the parameter. The data type can be a built-in data type or a distinct data type.

built-in-type

Specifies a built-in data type. For a more complete description of each built-in data type, see [“CREATE TABLE” on page 1105](#).

distinct-type-name

Specifies a distinct type. The length, precision, or scale attributes for the parameter are those of the source type of the distinct type (those specified on CREATE TYPE). For more information on creating a distinct type, see [“CREATE TYPE \(distinct\)” on page 1184](#).

If the name of the distinct type is unqualified, the database manager resolves the schema name by searching the schemas in the SQL path.

array-type-name

Specifies an array type.

If the name of the array type is unqualified, the database manager resolves the schema name by searching the schemas in the SQL path.

If a CCSID is specified, the parameter will be converted to that CCSID prior to passing it to the procedure. If a CCSID is not specified, the CCSID is determined by the default CCSID at the current server at the time the procedure is called.

default

Specifies a default value for the parameter. The default can be a constant, a special register, a global variable, an expression, or the keyword NULL. The expression is any expression defined in [“Expressions” on page 159](#), that does not include an aggregate function or column name. If a default value is not specified, the parameter has no default and cannot be omitted on invocation of the procedure. The maximum length of the expression string is 64K.

The default expression must not modify SQL data. The expression must be assignment compatible to the parameter data type. All objects referenced in a default expression must exist when the procedure is created.

Any comma in the default expression that is intended as a separator of numeric constants in a list must be followed by a space.

A default cannot be specified:

- for an OUT parameter.
- for a parameter of type array.

LANGUAGE SQL

Specifies that this procedure is written exclusively in SQL.

SPECIFIC *specific-name*

Specifies a unique name for the procedure. For more information on specific names, see [Specifying a specific name for a procedure in “CREATE PROCEDURE” on page 1064](#).

PROGRAM NAME *external-program-name*

Specifies the unqualified name of the program or service program to be created for the procedure. *external-program-name* must be a valid system name.

DETERMINISTIC or NOT DETERMINISTIC

Specifies whether the procedure returns the same results each time the procedure is called with the same IN and INOUT arguments. The default is NOT DETERMINISTIC.

NOT DETERMINISTIC

The procedure may not return the same result each time the procedure is called with the same IN and INOUT arguments, even when the referenced data in the database has not changed.

DETERMINISTIC

The procedure always returns the same results each time the procedure is called with the same IN and INOUT arguments, provided the referenced data in the database has not changed.

MODIFIES SQL DATA, READS SQL DATA, or CONTAINS SQL

Specifies the classification of SQL statements and nested routines that this procedure can execute. The database manager verifies that the SQL statements issued by the procedure, and all routines

locally invoked by the procedure, are consistent with this specification. The verification is not performed when nested remote routines are invoked. For the classification of each statement, see [Appendix B, “Characteristics of SQL statements,” on page 1643](#). The default is MODIFIES SQL DATA. This option applies to any parameter default expressions.

MODIFIES SQL DATA

Specifies that the procedure can execute any SQL statement except statements that are not supported in procedures.

READS SQL DATA

Specifies that the procedure can execute statements with a data access classification of READS SQL DATA, CONTAINS SQL, or NO SQL.

CONTAINS SQL

Specifies that the procedure can only execute statements with a data access classification of CONTAINS SQL or NO SQL.

CALLED ON NULL INPUT

Specifies that the procedure is to be called if any or all argument values are null. This specification means that the procedure must be coded to test for null argument values.

INHERIT SPECIAL REGISTERS

Specifies that existing values of special registers are inherited upon entry to the procedure.

DYNAMIC RESULT SETS *integer*

Specifies the maximum number of result sets that can be returned from the procedure. The minimum value for *integer* is zero and the maximum value is 32767. The default is DYNAMIC RESULT SETS 0.

Result sets are returned in the order in which the corresponding cursors are opened, unless a SET RESULT SETS statement is executed in the procedure. If the number of cursors still open for result sets when the procedure ends exceeds the maximum number specified on the DYNAMIC RESULT SETS clause, a warning is returned on the CALL statement and the number of result sets specified on the DYNAMIC RESULT SETS clause is returned.

If the SET RESULT SETS statement is issued, the number of results returned is the minimum of the number of result sets specified on this keyword and the SET RESULT SETS statement. If the SET RESULT SETS statement specifies a number larger than the maximum number of result sets, a warning is returned. Note that any result sets from cursors that have a RETURN TO CLIENT attribute are included in the number of result sets of the outermost procedure.

The result sets are scrollable if the cursor is used to return a result set and the cursor is scrollable. If a cursor is used to return a result set, the result set starts with the current position. Thus, if 5 FETCH NEXT operations have been performed prior to returning from the procedure, the result set will start with the 6th row of the result set.

For more information about result sets, see [“SET RESULT SETS” on page 1527](#).

DISALLOW DEBUG MODE, ALLOW DEBUG MODE, or DISABLE DEBUG MODE

Indicates whether the procedure is created so it can be debugged by the Unified Debugger. If DEBUG MODE is specified, a DBGVIEW option in the SET OPTION statement must not be specified.

DISALLOW DEBUG MODE

The procedure cannot be debugged by the Unified Debugger. When the DEBUG MODE attribute of the procedure is DISALLOW, the procedure can be subsequently altered to change the debug mode attribute.

ALLOW DEBUG MODE

The procedure can be debugged by the Unified Debugger. When the DEBUG MODE attribute of the procedure is ALLOW, the procedure can be subsequently altered to change the debug mode attribute.

DISABLE DEBUG MODE

The procedure cannot be debugged by the Unified Debugger. When the DEBUG MODE attribute of the procedure is DISABLE, the procedure cannot be subsequently altered to change the debug mode attribute.

If DEBUG MODE is not specified, but a DBGVIEW option in the SET OPTION statement is specified, the procedure cannot be debugged by the Unified Debugger, but may be debugged by the system debug facilities. If neither DEBUG MODE nor a DBGVIEW option is specified, the debug mode used is from the CURRENT DEBUG MODE special register.

FENCED or NOT FENCED

This parameter is allowed for compatibility with other products and is not used by Db2 for i.

PROGRAM TYPE MAIN or PROGRAM TYPE SUB

Specifies whether the procedure is created as a program (*PGM) or a procedure in a service program (*SRVPGM).

PROGRAM TYPE MAIN

Specifies that the procedure is created as a program (*PGM).

PROGRAM TYPE SUB

Specifies that the procedure is created as a procedure in a service program (*SRVPGM).

PROGRAM TYPE SUB procedures usually perform slightly better than PROGRAM TYPE MAIN procedures.

OLD SAVEPOINT LEVEL or NEW SAVEPOINT LEVEL

Specifies whether a new savepoint level is to be created on entry to the procedure.

OLD SAVEPOINT LEVEL

A new savepoint level is not created. Any SAVEPOINT statements issued within the procedure with OLD SAVEPOINT LEVEL implicitly or explicitly specified on the SAVEPOINT statement are created at the same savepoint level as the caller of the procedure. This is the default.

NEW SAVEPOINT LEVEL

A new savepoint level is created on entry to the procedure. Any savepoints set within the procedure are created at a savepoint level that is nested deeper than the level at which this procedure was invoked. Therefore, the name of any new savepoint set within the procedure will not conflict with any existing savepoints set in higher savepoint levels (such as the savepoint level of the calling program) with the same name.

COMMIT ON RETURN

Specifies whether the database manager commits the transaction immediately on return from the procedure.

NO

The database manager does not issue a commit when the procedure returns. NO is the default.

YES

The database manager issues a commit if the procedure returns successfully. If the procedure returns with an error, a commit is not issued.

The commit operation includes the work that is performed by the calling application process and the procedure.

If the procedure returns result sets, the cursors that are associated with the result sets must have been defined as WITH HOLD to be usable after the commit.

AUTONOMOUS

Specifies that the procedure is executed in a unit of work that is independent from the calling application. When this option is specified the database always commits or rolls back the autonomous procedure's transactional work based on the SQLSTATE that is returned from the procedure. A SQLSTATE indication of unqualified success or warning will cause the transaction to be committed. All other SQLSTATEs will cause the autonomous procedure's unit of work to be rolled back.

The invocation of any trigger, function, or procedure from within the autonomous procedure will be part of the autonomous procedure's unit of work unless the trigger, function, or procedure was explicitly created to run under a different activation group.

An autonomous procedure cannot be called directly or indirectly from another autonomous procedure.

If AUTONOMOUS is specified, DYNAMIC RESULT SETS 0 must be specified.

CONCURRENT ACCESS RESOLUTION

Specifies whether the database manager should wait for data that is in the process of being updated. DEFAULT is the default.

DEFAULT

Specifies that the concurrent access resolution is not explicitly set for this procedure. The value that is in effect when the procedure is called will be used.

WAIT FOR OUTCOME

Specifies that the database manager is to wait for the commit or rollback of data in the process of being updated.

USE CURRENTLY COMMITTED

Specifies that the database manager is to use the currently committed version of the data when encountering data that is in the process of being updated.

When the lock contention is between a read transaction and a delete or update transaction, the clause is applicable to scans with isolation level CS (but not for CS KEEP LOCKS).

SYSTEM_TIME SENSITIVE

Determines whether references to system-period temporal tables in both static and dynamic SQL statements are affected by the value of the CURRENT TEMPORAL SYSTEM_TIME special register. YES is the default.

YES

References to system-period temporal tables are affected by the value of the CURRENT TEMPORAL SYSTEM_TIME special register.

NO

References to system-period temporal tables are not affected by the value of the CURRENT TEMPORAL SYSTEM_TIME special register.

WRAPPED *obfuscated-statement-text*

Specifies the encoded definition of the procedure. A CREATE PROCEDURE statement can be encoded using the WRAP scalar function.

SET OPTION-statement

Specifies the options that will be used to create the procedure. These options also apply to any default value expressions. For example, to create a debuggable procedure, the following statement could be included:

```
SET OPTION DBGVIEW = *SOURCE
```

The default values for the options depend on the options in effect at create time. For more information, see [“SET OPTION” on page 1505](#).

The options CLOSQLCSR, CNULRQD, CNULIGN, COMPILEOPT, NAMING, and SQLCA are not allowed in the CREATE PROCEDURE statement. The following options are used when processing default value expressions: ALWCOPYDTA, CONACC, DATFMT, DATSEP, DECFLTRND, DECMPT, DECRESULT, DFTRDBCOL, LANGID, SQLCURRULE, SQLPATH, SRTSEQ, TGTRLS, TIMFMT, and TIMSEP.

SQL-routine-body

Specifies a single *SQL-procedure-statement*, including a compound statement. See [“SQL control statements” on page 1569](#) for more information about defining SQL procedures.

CONNECT, SET CONNECTION, RELEASE, DISCONNECT, and SET TRANSACTION statements are not allowed in a procedure that is running on a remote application server. COMMIT and ROLLBACK statements are not allowed in an ATOMIC SQL procedure or in a procedure that is running on a connection to a remote application server.

ALTER PROCEDURE (SQL), ALTER FUNCTION (SQL scalar), and ALTER FUNCTION (SQL Table) with a REPLACE keyword are not allowed in an *SQL-routine-body*.

Notes

General considerations for defining procedures: See [“CREATE PROCEDURE” on page 1064](#) for general information on defining procedures.

Procedure ownership: If SQL names were specified:

- If a user profile with the same name as the schema into which the procedure is created exists, the *owner* of the procedure is that user profile.
- Otherwise, the *owner* of the procedure is the user profile or group user profile of the thread executing the statement.

If system names were specified, the *owner* of the procedure is the user profile or group user profile of the thread executing the statement.

Procedure authority: If SQL names are used, procedures are created with the system authority of *EXCLUDE on *PUBLIC. If system names are used, procedures are created with the authority to *PUBLIC as determined by the create authority (CRTAUT) parameter of the schema.

If the owner of the procedure is a member of a group profile (GRPPRF keyword) and group authority is specified (GRPAUT keyword), that group profile will also have authority to the procedure.

REPLACE rules: When a procedure is recreated by REPLACE:

- Any existing comment or label is discarded.
- Authorized users are maintained. The object owner could change.
- Current journal auditing is preserved.

Error handling in procedures: Consideration should be given to possible exceptions that can occur for each SQL statement in the body of a procedure. Any exception SQLSTATE that is not handled within the procedure using a handler within a compound statement results in the exception SQLSTATE being returned to the caller of the procedure. Values of arguments passed to a procedure that correspond to OUT parameters are undefined and those that correspond to INOUT parameters are unchanged when an error is returned by the procedure.

Creating the procedure: When an SQL procedure is created, SQL creates a temporary source file that will contain C source code with embedded SQL statements. A program or service program object is then created using the CRTPGM or CRTSRVPGM command. The SQL options used to create the program are the options that are in effect at the time the CREATE PROCEDURE statement is executed. If AUTONOMOUS is specified, the program or service program is created with ACTGRP(QSQAUTOAG). Otherwise, the program is created with ACTGRP(*CALLER).

When an SQL procedure is created, the procedure's attributes are stored in the created program or service program object. If the *PGM or *SRVPGM object is saved and then restored to this or another system, the attributes are used to update the catalogs.

If the PROGRAM NAME clause is provided, its name is used for the creation of the program object. Otherwise, the specific procedure name is used as the name of the member in the source file and the name of the program object, if it is a valid system name. If the procedure name is not a valid system name, a unique name is generated. If a source file member with the same name already exists, the member is overlaid. If a module or a program with the same name already exists, the objects are not overlaid, and a unique name is generated. The unique names are generated according to the rules for generating system table names.

Invoking the procedure: If a DECLARE PROCEDURE statement defines a procedure with the same name as a created procedure, and a static CALL statement where the procedure name is not identified by a variable is executed from the same source program, the attributes from the DECLARE PROCEDURE statement will be used rather than the attributes from the CREATE PROCEDURE statement.

The CREATE PROCEDURE statement applies to static and dynamic CALL statements as well as to a CALL statement where the procedure name is identified by a variable.

SQL procedures must be called using the SQL CALL statement. When called, the SQL procedure runs in the activation group of the calling program.

SQL procedures are built with the *TERASPACE storage model. When an autonomous SQL procedure is invoked in a job, every procedure that runs in the QSQAUTOAG activation group must use the *TERASPACE storage model.

Obfuscated statements: A CREATE PROCEDURE statement can be executed in obfuscated form. In an obfuscated statement, only the procedure name and parameters are readable followed by the WRAPPED keyword. The rest of the statement is encoded in such a way that it is not readable but can be decoded by a database server that supports obfuscated statements. Obfuscated statements can be produced by invoking the WRAP scalar function. Any debug options that are specified when the procedure is created from an obfuscated statement are ignored. A procedure that is created from an obfuscated statement cannot be restored to a release where obfuscation is not supported.

Setting of the default value: Parameters of a procedure that are defined with a default value are set to their default value when the procedure is invoked, but only if a value is not supplied for the corresponding argument, or the argument is specified as DEFAULT.

Dependent objects: An SQL routine is dependent on objects that are referenced in the *SQL-routine-body*. The names of the dependent objects are stored in catalog view SYSROUTINEDEP. If the object reference in the *SQL-routine-body* is a fully qualified name or, in SQL naming, if an unqualified name is qualified by the current schema, then the schema name of the object in SYSROUTINEDEP will be set to the specified name or the value of the current schema. Otherwise, the schema name is not set to a specific schema name. Unqualified function names, variable names, and type names will have a schema name of CURRENT PATH. If the name is not set to an actual schema name, then DROP and ALTER statements will not be able to determine whether the routine is dependent on the object being altered or dropped.

Syntax alternatives: The following keywords are synonyms supported for compatibility to prior releases. These keywords are non-standard and should not be used:

- The keywords VARIANT and NOT VARIANT can be used as synonyms for NOT DETERMINISTIC and DETERMINISTIC.
- The keywords NULL CALL can be used as synonyms for CALLED ON NULL INPUT.
- DYNAMIC RESULT SET, RESULT SETS, and RESULT SET may be used as synonyms for DYNAMIC RESULT SETS.

Example

Create an SQL procedure that returns the median staff salary. Return a result set containing the name, position, and salary of all employees who earn more than the median salary.

```
CREATE PROCEDURE MEDIAN_RESULT_SET (OUT medianSalary DECIMAL(7,2))
LANGUAGE SQL
DYNAMIC RESULT SETS 1
BEGIN
  DECLARE v_numRecords INTEGER DEFAULT 1;
  DECLARE v_counter INTEGER DEFAULT 0;
  DECLARE c1 CURSOR FOR
    SELECT salary
      FROM staff
     ORDER BY salary;
  DECLARE c2 CURSOR WITH RETURN FOR
    SELECT name, job, salary
      FROM staff
     WHERE salary > medianSalary
     ORDER BY salary;
  DECLARE EXIT HANDLER FOR NOT FOUND
    SET medianSalary = 6666;
  SET medianSalary = 0;
  SELECT COUNT(*) INTO v_numRecords FROM STAFF;
  OPEN c1;
  WHILE v_counter < (v_numRecords / 2 + 1)
    DO FETCH c1 INTO medianSalary;
     SET v_counter = v_counter + 1;
  END WHILE;
  CLOSE c1;
  OPEN c2;
END
```

CREATE SCHEMA

The CREATE SCHEMA statement defines a schema at the current server and optionally creates tables, views, aliases, indexes, sequences, and distinct types. Comments and labels may be added in the catalog description of these objects, and privileges can be granted to users.

Invocation

This statement can be embedded in an application program or issued interactively. It is an executable statement that can be dynamically prepared.

Authorization

The privileges held by the authorization ID of the statement must include at least one of the following:

- The *USE system authority to the following CL commands:
 - Create Library (CRTLIB)
 - If WITH DATA DICTIONARY is specified, Create Data Dictionary (CRTDTADCT)
- Database administrator authority

The privileges held by the authorization ID of the statement must include at least one of the following:

- The privileges defined for each SQL statement included in the CREATE SCHEMA statement
- Database administrator authority

If the AUTHORIZATION clause is specified, the privileges held by the authorization ID of the statement must also include at least one of the following:

- The system authority *ADD to the user profile identified by authorization-name
- Database administrator authority

Syntax

► CREATE SCHEMA ►

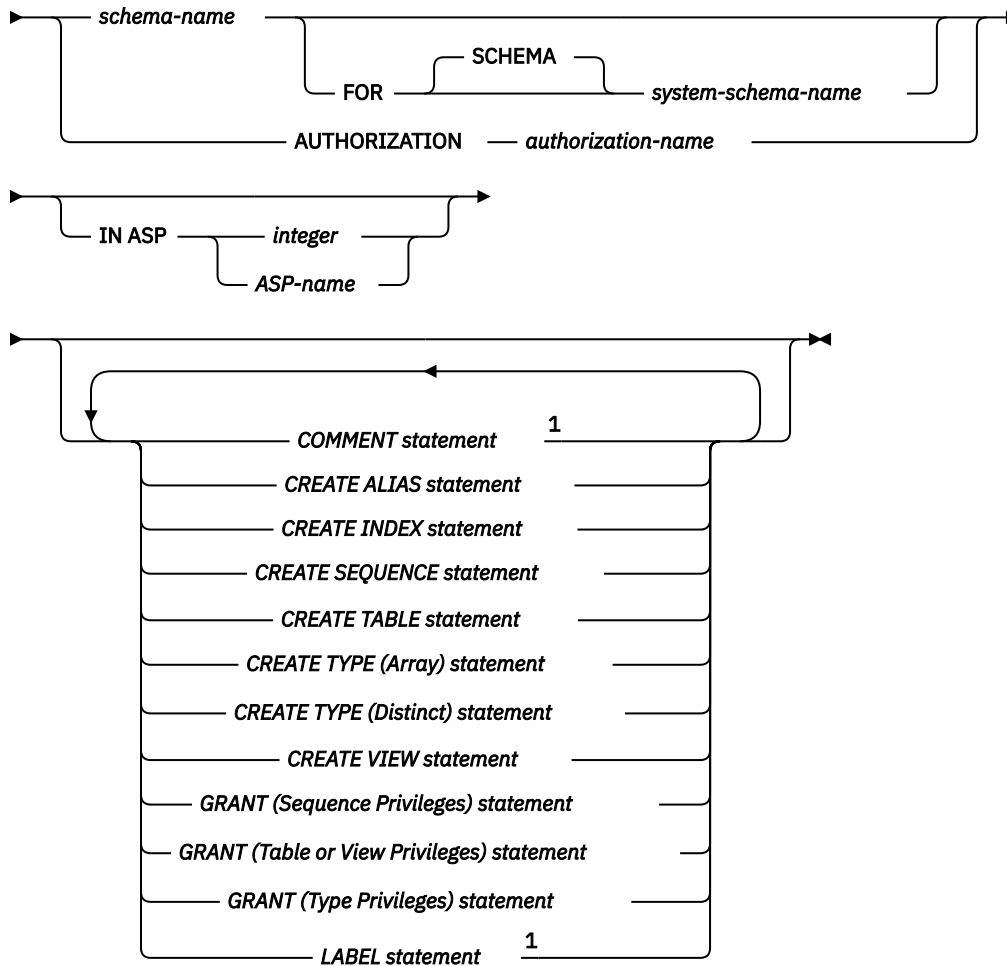

Notes:

¹ Only labels and comments on object types created in the schema are supported in the CREATE SCHEMA statement.

Description

schema-name

Names the schema. A schema is created using this name. If *schema-name* is specified, the authorization ID of the statement is the run-time authorization ID. The name must not be the same as the name of an existing schema at the current server. The name should not begin with 'SYS' or 'Q'. Such schema names indicate that the schema is a *system schema*.

If the *schema-name* is not a valid system name and a *system-schema-name* is not specified, SQL will generate a system name. For information about the rules for generating the name, see [“Rules for Schema Name Generation”](#) on page 1096.

FOR SCHEMA *system-schema-name*

Identifies the system name of the schema. *system-schema-name* must not be the same as a schema that already exists at the current server. The *system-schema-name* must be an unqualified system identifier that is a valid system name.

If both *schema-name* and *system-schema-name* are specified, they cannot both be valid system names.

authorization-name

Identifies the authorization ID of the statement. This authorization name is also the schema-name. The name must not be the same as the name of an existing schema at the current server.

IN ASP

Specifies the auxiliary storage pool (ASP) in which to create the schema.

integer

The integer must be between 1 and 32. If 1 is specified, the schema is created on the system ASP.

ASP-name

The name must identify an auxiliary storage pool that exists at the current server.

If this clause is omitted,

- If the name space of the invoking thread is set to an independent auxiliary storage pool (IASP), the schema will be created in the IASP name space.
- Otherwise, an ASP of 1 is assumed.

COMMENT statement

Adds or replaces comments in the catalog descriptions of an object created in the schema. Only comments on objects created in the schema are allowed. See the COMMENT statement [“COMMENT” on page 930](#).

CREATE ALIAS statement

Creates an alias into the schema. See the CREATE ALIAS statement [“CREATE ALIAS” on page 961](#).

CREATE INDEX statement

Creates an index into the schema. See the CREATE INDEX statement [“CREATE INDEX” on page 1045](#).

CREATE SEQUENCE statement

Creates a sequence into the schema. See the CREATE SEQUENCE statement [“CREATE SEQUENCE” on page 1098](#).

CREATE TABLE statement

Creates a table into the schema. See the CREATE TABLE statement [“CREATE TABLE” on page 1105](#).

CREATE TYPE (Array) statement

Creates an array type into the schema. See the CREATE TYPE (Array) statement [“CREATE TYPE \(array\)” on page 1179](#).

CREATE TYPE (Distinct) statement

Creates a user-defined distinct type into the schema. See the CREATE TYPE (Distinct) statement [“CREATE TYPE \(distinct\)” on page 1184](#).

CREATE VIEW statement

Creates a view into the schema. See the CREATE VIEW statement [“CREATE VIEW” on page 1198](#).

GRANT (Sequence Privileges) statement

Grants privileges for sequences in the schema. See the GRANT statement [“GRANT \(sequence privileges\)” on page 1363](#).

GRANT (Table or View Privileges) statement

Grants privileges for tables and views in the schema. See the GRANT statement [“GRANT \(table or view privileges\)” on page 1366](#).

GRANT (Type Privileges) statement

Grants privileges for types in the schema. See the GRANT statement [“GRANT \(type privileges\)” on page 1374](#).

LABEL statement

Adds or replaces labels in the catalog descriptions of an object created in the schema. Only labels on objects created in the schema are allowed. See the LABEL statement [“LABEL” on page 1399](#).

Notes

Schema attributes: A schema is created as:

- A library: A library groups related objects, and allows you to find objects by name.

- A catalog: A catalog contains descriptions of the tables, views, indexes, and other objects in the schema. A catalog consists of a set of views. For more information, see [SQL Programming](#).
- A journal and journal receiver: A journal QSQJRN and journal receiver QSQJRN0001 is created in the schema, and is used to record changes to all tables subsequently created in the schema. For more information, see [Journal Management](#).

An index created over a distributed table is created on all of the servers across which the table is distributed. For more information about distributed tables, see [DB2 Multisystem](#).

Object ownership: The owner of the schema and created objects is determined as follows:

- If an AUTHORIZATION clause is specified, the specified authorization ID owns the schema and all objects created by the statement.
- Otherwise, the *owner* of the schema and all objects created by the statement is the user profile or the group user profile of the thread executing the statement.

Object authority: If SQL names are used, the schema and any other objects are created with the system authority of *EXCLUDE on *PUBLIC and the library is created with the create authority parameter CRTAUT(*EXCLUDE). The owner is the only user having any authority to the schema. If other users require authority to the schema, the owner can grant authority to the objects created; using the CL command Grant Object Authority (GRTOBJAUT).

If system names are used, the schema and any other objects are created with the system authority given to *PUBLIC is determined by the system value QCRTAUT, and the library is created with CRTAUT(*SYSVAL). For more information about system security, see [Security Reference](#), and [SQL Programming](#).

If the owner of the schema is a member of a group profile (GRPPRF keyword) and group authority is specified (GRPAUT keyword), that group profile will also have authority to the schema.

Object names: If a CREATE TABLE, CREATE INDEX, CREATE ALIAS, CREATE TYPE, CREATE SEQUENCE, or CREATE VIEW statement contains a qualified name for the table, index, alias, distinct type, sequence, or view being created, the schema name specified in that qualified name must be the same as the name of the schema being created. Any other object names referenced within the schema definition may be qualified by any schema name. Unqualified table, index, alias, distinct type, sequence, or view names in any SQL statement are implicitly qualified with the name of the created schema.

Delimiters are not used between the SQL statements.

SQL statement length: If the CREATE SCHEMA statement is executed via the RUNSQLSTM command, the maximum length of any individual CREATE TABLE, CREATE INDEX, CREATE TYPE, CREATE ALIAS, CREATE SEQUENCE, CREATE VIEW, COMMENT, LABEL, or GRANT statements within the CREATE SCHEMA statement is 2 097 152. Otherwise, the entire CREATE SCHEMA statement is limited to 2 097 152.

Name resolution performance: The name of the schema can affect the performance of statements that reference objects in the schema. If the length of a schema name is greater than 30, the performance of finding objects in the schema will be worse than schemas whose name length is less than or equal to 30. To minimize the performance impact, ensure that the first 5 characters of the system name and the schema name are the same.

Syntax alternatives: The COLLECTION keyword can be used as a synonym for SCHEMA for compatibility to prior releases. This keyword is non-standard and should not be used.

Deprecated features: The WITH DATA DICTIONARY clause causes an IDDU data dictionary to be created in the schema. While the clause can still be specified at the end of the CREATE SCHEMA statement and is still supported; it is not recommended.

A schema created with a data dictionary cannot contain tables with LOB, XML, or DATALINK columns. The clause has no effect on the creation of catalog views.

Rules for Schema Name Generation

A system name will be generated if a schema is created with a name that is longer than 10 characters.

The SQL name or its corresponding system name may both be used in SQL statements to access the schema once it is created. However, the SQL name is only recognized by Db2 for i and the system name must be used in other environments.

If the *schema-name* is an ordinary identifier and longer than 10 characters, a 10-character *system-schema-name* will be generated as:

- The first 5 characters of the name
- A 5 digit unique number

For example:

```
The system-schema-name for LONGSCHEMANAME would be LONGS00001
```

If the *schema-name* is a delimited identifier and longer than 10 characters, a 10-character *system-schema-name* will be generated as:

- The first 4 characters from within the delimiters will be used as the first characters of the *system-schema-name*.
- If the first 4 characters are all uppercase letters, digits, or underscores, an underscore and a 5 digit unique number is appended.
- Otherwise, a 4 digit unique number is appended.

For example:

```
The system name for "longschemaname" would be "long0001"  
The system name for "LONGSchemaName" would be LONG_00001
```

Examples

Example 1: Create a schema that has an inventory part table and an index over the part number. Give authority to the schema to the user profile JONES.

```
CREATE SCHEMA INVENTORY  
  
CREATE TABLE PART (PARTNO SMALLINT NOT NULL,  
DESCR VARCHAR(24),  
QUANTITY INT)  
  
CREATE INDEX PARTIND ON PART (PARTNO)  
  
GRANT ALL ON PART TO JONES
```

Example 2: Create a schema using the authorization ID of SMITH. Create a student table that has a comment on the student number column.

```
CREATE SCHEMA AUTHORIZATION SMITH  
  
CREATE TABLE SMITH.STUDENT (STUDNBR SMALLINT NOT NULL UNIQUE,  
LASTNAME CHAR(20),  
FIRSTNAME CHAR(20),  
ADDRESS CHAR(50))  
  
COMMENT ON STUDENT (STUDNBR IS 'THIS IS A UNIQUE ID#')
```

CREATE SEQUENCE

The CREATE SEQUENCE statement creates a sequence at the application server.

Invocation

This statement can be embedded in an application program or issued interactively. It is an executable statement that can be dynamically prepared.

Authorization

The privileges held by the authorization ID of the statement must include at least one of the following:

- The privilege to create in the schema. For more information, see [Privileges necessary to create in a schema](#).
- Database administrator authority

The privileges held by the authorization ID of the statement must include at least one of the following:

- The following system authorities:
 - *USE to the Create Data Area (CRTDTAARA) command
- Database administrator authority

The privileges held by the authorization ID of the statement must include at least one of the following:

- For the SYSSEQOBJECTS catalog table:
 - The INSERT privilege on the table, and
 - The USAGE privilege on schema QSYS2
- Database administrator authority

If a distinct type is referenced, the privileges held by the authorization ID of the statement must include at least one of the following:

- For the distinct type identified in the statement:
 - The USAGE privilege on the distinct type, and
 - The USAGE privilege on the schema containing the distinct type
- Database administrator authority

To replace an existing sequence, the privileges held by the authorization ID of the statement must include at least one of the following:

- The following system authorities:
 - The system authority of *OBJMGT on the data area associated with the sequence
 - All authorities needed to DROP the sequence
 - The system authority *READ to the SYSSEQOBJECTS catalog table
- Database administrator authority

For information about the system authorities corresponding to SQL privileges, see [Corresponding System Authorities When Checking Privileges to a Sequence](#) and [Corresponding System Authorities When Checking Privileges to a Distinct Type](#).

Syntax

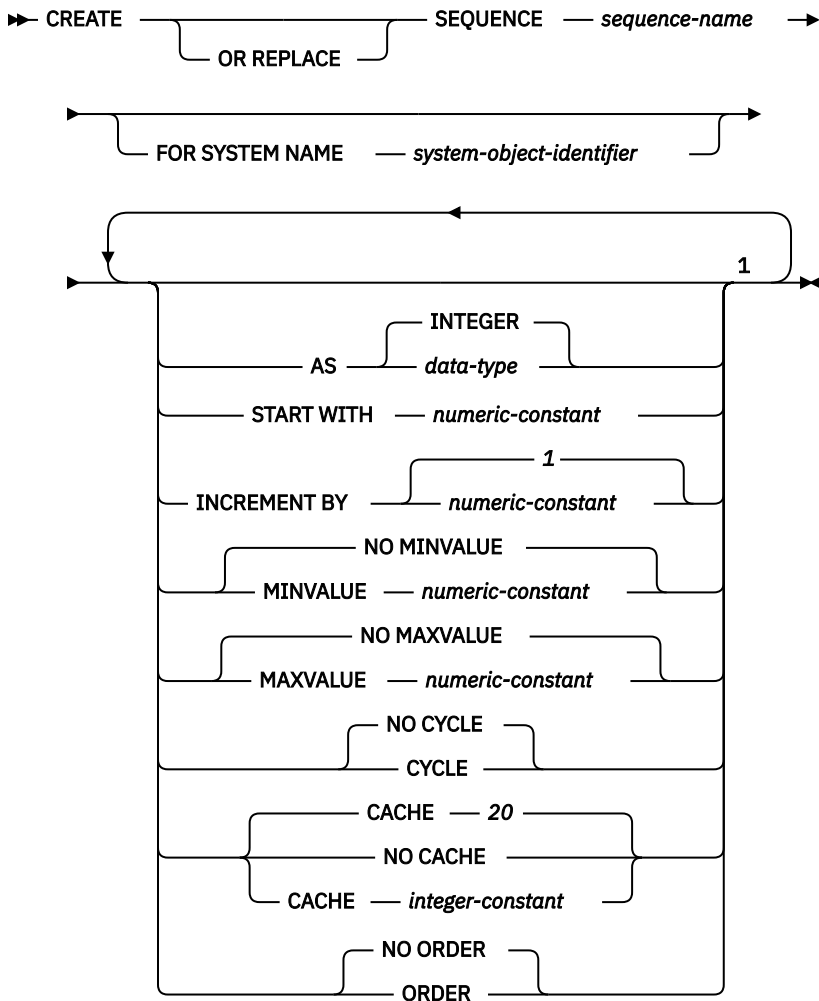

Notes:

¹ The same clause must not be specified more than once.

data-type

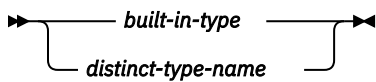

built-in-type

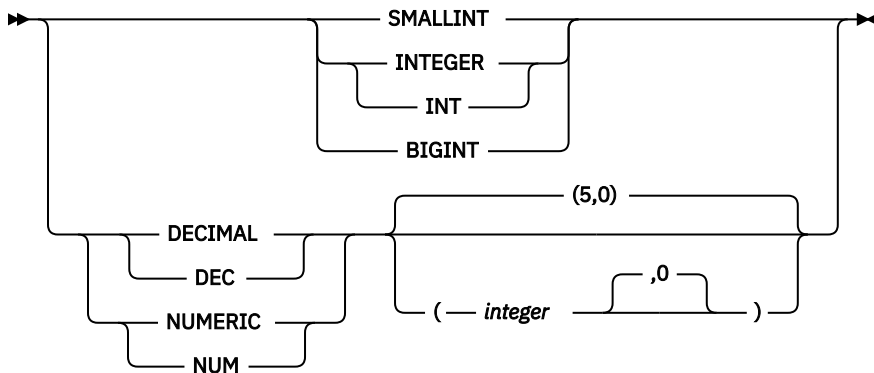

Description

OR REPLACE

Specifies to replace the definition for the sequence if one exists at the current server. The existing definition is effectively dropped before the new definition is replaced in the catalog with the exception that privileges that were granted on the sequence are not affected. This option is ignored if a definition for the sequence does not exist at the current server.

sequence-name

Names the sequence. The name, including the implicit or explicit qualifier, must not identify a sequence or data area that already exists at the current server. If a qualified sequence name is specified, the *schema-name* cannot be QSYS2, QSYS, or SYSIBM.

If SQL names were specified, the sequence will be created in the schema specified by the implicit or explicit qualifier.

If system names were specified, the sequence will be created in the schema that is specified by the qualifier. If not qualified:

- If the value of the CURRENT SCHEMA special register is *LIBL, the sequence will be created in the current library (*CURLIB).
- Otherwise, the sequence will be created in the current schema.

FOR SYSTEM NAME *system-object-identifier*

Identifies the *system-object-identifier* of the sequence. *system-object-identifier* must not be the same as a sequence or data area that already exists at the current server. The *system-object-identifier* must be an unqualified system identifier.

When *system-object-identifier* is specified, *sequence-name* must not be a valid system object name.

AS *data-type*

Specifies the data type to be used for the sequence value. The data type can be any exact numeric type (SMALLINT, INTEGER, BIGINT, DECIMAL, or NUMERIC) with a scale of zero, or a user-defined distinct type for which the source type is an exact numeric type with a scale of zero. The default is INTEGER.

built-in-type

Specifies the built-in data type used as the basis for the internal representation of the sequence. If the data type is DECIMAL or NUMERIC, the precision must be less than or equal to 63 and the scale must be 0. See [“CREATE TABLE” on page 1105](#) for a more complete description of each built-in data type.

For portability of applications across platforms, use DECIMAL instead of a NUMERIC data type.

distinct-type-name

Specifies that the data type of the sequence is a distinct type (a user-defined data type). If the source type is DECIMAL or NUMERIC, the precision of the sequence is the precision of the source type of the distinct type. The precision of the source type must be less than or equal to 63 and the scale must be 0. If a distinct type name is specified without a schema name, the distinct type name is resolved by searching the schemas on the SQL path.

START WITH *numeric-constant*

Specifies the first value that is generated for the sequence. The value can be any positive or negative value that could be assigned to a column of the data type associated with the sequence, without non-zero digits to the right of the decimal point.

If a value is not explicitly specified when the sequence is defined, the default is the MINVALUE for an ascending sequence and the MAXVALUE for a descending sequence.

This value is not necessarily the value that a sequence would cycle to after reaching the maximum or minimum value of the sequence. The START WITH clause can be used to start a sequence outside the range that is used for cycles. The range used for cycles is defined by MINVALUE and MAXVALUE.

INCREMENT BY *numeric-constant*

Specifies the interval between consecutive values of the sequence. The value can be any positive or negative value that could be assigned to a column of the data type associated with the sequence, and

does not exceed the value of a large integer constant, without nonzero digits existing to the right of the decimal point.

If the value is 0 or positive, this is an ascending sequence. If the value is negative, this is a descending sequence. The default is 1.

NO MINVALUE or MINVALUE

Specifies the minimum value at which a descending sequence either cycles or stops generating values, or an ascending sequence cycles to after reaching the maximum value. The default is NO MINVALUE.

NO MINVALUE

For an ascending sequence, the value is the START WITH value, or 1 if START WITH is not specified. For a descending sequence, the value is the minimum value of the data type (and precision, if DECIMAL or NUMERIC) associated with the sequence.

MINVALUE *numeric-constant*

Specifies the numeric constant that is the minimum value. This value can be any positive or negative value that could be assigned to a column of the data type associated with the sequence and without non-zero digits to the right of the decimal point. The value must be less than or equal to the maximum value.

NO MAXVALUE or MAXVALUE

Specifies the maximum value at which an ascending sequence either cycles or stops generating values, or a descending sequence cycles to after reaching the minimum value. The default is NO MAXVALUE.

NO MAXVALUE

For an ascending sequence, the value is the maximum value of the data type (and precision, if DECIMAL or NUMERIC) associated with the sequence. For a descending sequence, the value is the START WITH value, or -1 if START WITH is not specified.

MAXVALUE *numeric-constant*

Specifies the numeric constant that is the maximum value. This value can be any positive or negative value that could be assigned to a column of the data type associated with the sequence and without non-zero digits to the right of the decimal point. The value must be greater than or equal to the minimum value.

NO CYCLE or CYCLE

Specifies whether this sequence should continue to generate values once the maximum or minimum value of the sequence has been reached. The default is NO CYCLE.

NO CYCLE

Specifies that values will not be generated for the sequence once the maximum or minimum value for the sequence has been reached.

CYCLE

Specifies that values continue to be generated for this sequence after the maximum or minimum value has been reached. If this option is used, after an ascending sequence reaches the maximum value of the sequence, it generates its minimum value. After a descending sequence reaches its minimum value of the sequence, it generates its maximum value. The maximum and minimum values for the column determine the range that is used for cycling.

When CYCLE is in effect, then duplicate values can be generated for the sequence.

CACHE or NO CACHE

Specifies whether to keep some preallocated values in memory. Preallocating and storing values in the cache improves the performance of the NEXT VALUE sequence expression. The default is CACHE 20.

CACHE *integer-constant*

Specifies the maximum number of sequence values that are preallocated and kept in memory. Preallocating and storing values in the cache improves performance.

In certain situations, such as system failure, all cached sequence values that have not been used in committed statements are lost, and thus, will never be used. The value specified for the CACHE option is the maximum number of sequence values that could be lost in these situations.

The minimum value that can be specified is 2.

NO CACHE

Specifies that values for the sequence are not preallocated. If NO CACHE is specified, the performance of the NEXT VALUE sequence expression will be worse than if CACHE is specified.

ORDER or NO ORDER

Specifies whether the sequence values must be generated in order of request. The default is NO ORDER.

NO ORDER

Specifies that the sequence numbers do not need to be generated in order of request.

ORDER

Specifies that the sequence numbers are generated in order of request. If ORDER is specified, the performance of the NEXT VALUE sequence expression will be worse than if NO ORDER is specified.

Notes

Sequence attributes: A sequence is created as a *DTAARA object. The *DTAARA objects should not be changed with the Change Data Area (*CHGDTAARA) or any other similar interface because doing so may cause unexpected failures or unexpected results when attempting to use the SQL sequence through SQL.

Sequence ownership: The *owner* of the sequence is the user profile or group user profile of the thread executing the statement.

Sequence authority: If SQL names are used, sequences are created with the system authority of *EXCLUDE on *PUBLIC. If system names are used, sequences are created with the authority to *PUBLIC as determined by the create authority (CRTAUT) parameter of the schema.

If the owner of the sequence is a member of a group profile (GRPPRF keyword) and group authority is specified (GRPAUT keyword), that group profile will also have authority to the sequence.

REPLACE rules: When a sequence is recreated by REPLACE:

- Any existing comment or label is discarded.
- Authorized users are maintained. The object owner could change.
- Current journal auditing is preserved.

Relationship of MINVALUE and MAXVALUE: Typically, MINVALUE will be less than MAXVALUE, but this is not required. MINVALUE could be equal to MAXVALUE. If START WITH was the same value as MINVALUE and MAXVALUE, and CYCLE is implicitly or explicitly specified, this would be a constant sequence. In this case a request for the next value appears to have no effect because all the values generated by the sequence are in fact the same.

MINVALUE must not be greater than MAXVALUE

Defining constant sequences: It is possible to define a sequence that would always return a constant value. This could be done by specifying an INCREMENT value of zero and a START WITH value that does not exceed MAXVALUE, or by specifying the same value for START WITH, MINVALUE and MAXVALUE. For a constant sequence, each time a NEXT VALUE expression is processed the same value is returned. A constant sequence can be used as a numeric global variable. ALTER SEQUENCE can be used to adjust the values that will be generated for a constant sequence.

Defining sequences that cycle: A sequence can be cycled manually by using the ALTER SEQUENCE statement. If NO CYCLE is implicitly or explicitly specified, the sequence can be restarted or extended using the ALTER SEQUENCE statement to cause values to continue to be generated once the maximum or minimum value for the sequence has been reached.

A sequence can be explicitly defined to cycle by specifying the CYCLE keyword. Use the CYCLE option when defining a sequence to indicate that the generated values should cycle once the boundary is reached. When a sequence is defined to automatically cycle (for example CYCLE was explicitly specified), then the maximum or minimum value generated for a sequence may not be the actual MAXVALUE or MINVALUE specified, if the increment is a value other than 1 or -1. For example, the sequence defined with START WITH=1, INCREMENT=2, MAXVALUE=10 will generate a maximum value of 9, and will not generate the value 10.

When defining a sequence with CYCLE, then any application conversion tools (for converting applications from other vendor platforms to Db2) should also explicitly specify MINVALUE, MAXVALUE and START WITH.

Caching sequence numbers: A range of sequence numbers can be kept in memory for fast access. When an application accesses a sequence that can allocate the next sequence number from the cache, the sequence number allocation can happen quickly. However, if an application accesses a sequence that cannot allocate the next sequence number from the cache, the sequence number allocation will require an update to the *DTAARA object.

Choosing a high value for CACHE allows faster access to more successive sequence numbers. However, in the event of a failure, all sequence values in the cache are lost. If the NO CACHE option is used, the values of the sequence are not stored in the sequence cache. In this case every access to the sequence requires an update to the *DTAARA object. The choice of the value for CACHE should be made keeping the trade-off between performance and application requirements in mind.

Persistence of the most recently generated sequence value: The database manager remembers the most recently generated value for a sequence within the SQL-session, and returns this value for a PREVIOUS VALUE expression specifying the sequence name. The value persists until either the next value is generated for the sequence, the sequence is dropped, altered, or replaced, or until the end of the application session. The value is unaffected by COMMIT and ROLLBACK statements.

PREVIOUS VALUE is defined to have a linear scope within the application session. Therefore, in a nested application:

- on entry to a nested function, procedure, or trigger, the nested application inherits the most recently generated value for a sequence. That is, specifying an invocation of a PREVIOUS VALUE expression in a nested application will reflect sequence activity done in the invoking application, routine, or trigger before entering the nested application. An invocation of PREVIOUS VALUE expression in a nested application results in an error if a NEXT VALUE expression for the specified sequence had not yet been done in the invoking application, routine, or trigger.
- on return from a function, procedure, or trigger, the invoking application, routine or trigger will be affected by any sequence activity in the function, procedure, or trigger. That is, an invocation of PREVIOUS VALUE in the invoking application, routine, or trigger after returning from the nested application will reflect any sequence activity that occurred in the lower level applications.

Sequence journaling: When a sequence is created, journaling may be automatically started if the sequence is created into a schema that has specified (using the STRJRNLIB command) that journaling should implicitly be started.

Syntax alternatives: The following keywords are synonyms supported for compatibility to prior releases of other Db2 products. These keywords are non-standard and should not be used:

- The keywords NOMINVALUE, NOMAXVALUE, NOCYCLE, NOCACHE, and NOORDER can be used as synonyms for NO MINVALUE, NO MAXVALUE, NO CYCLE, NO CACHE, and NO ORDER.
- A comma can be used to separate multiple sequence options.

Examples

Create a sequence called ORG_SEQ that starts at 1, increments by 1, does not cycle, and caches 24 values at a time:

```
CREATE SEQUENCE ORG_SEQ  
START WITH 1
```

```
INCREMENT BY 1  
NO MAXVALUE  
NO CYCLE  
CACHE 24
```

The options START WITH 1, INCREMENT 1, NO MAXVALUE, and NO CYCLE are the values that would have been used if they had not been explicitly specified.

CREATE TABLE

The CREATE TABLE statement defines a table at the current server. The definition must include its name and the names and attributes of its columns. The definition may include other attributes of the table such as primary key.

Invocation

This statement can be embedded in an application program or issued interactively. It is an executable statement that can be dynamically prepared.

Authorization

The privileges held by the authorization ID of the statement must include at least one of the following:

- The privilege to create in the schema. For more information, see [Privileges necessary to create in a schema](#).
- Database administrator authority

The privileges held by the authorization ID of the statement must include at least one of the following:

- The following system authorities:
 - *USE to the Create Physical File (CRTPF) command
 - *CHANGE to the data dictionary if the library into which the table is created is an SQL schema with a data dictionary
- Database administrator authority

If SQL names are specified and a user profile exists that has the same name as the library into which the table is created, and that name is different from the authorization ID of the statement, then the privileges held by the authorization ID of the statement must include at least one of the following:

- The system authority *ADD to the user profile with that name
- Database administrator authority

To define a foreign key, the privileges held by the authorization ID of the statement must include at least one of the following on the parent table:

- The REFERENCES privilege or object management authority for the table
- The REFERENCES privilege on each column of the specified parent key
- Ownership of the table
- Database administrator authority

If a field procedure is defined, the privileges held by the authorization ID of the statement must include at least one of the following:

- The following system authorities:
 - The system authority *EXECUTE on the program, and
 - The USAGE privilege on the schema containing the program
- Database administrator authority

If the LIKE clause or *select-statement* is specified, the privileges held by the authorization ID of the statement must include at least one of the following on the tables or views specified in these clauses:

- The SELECT privilege for the table or view
- Ownership of the table or view
- Database administrator authority

If a distinct type is referenced, the privileges held by the authorization ID of the statement must include at least one of the following:

- For each distinct type identified in the statement:
 - The USAGE privilege on the distinct type, and
 - The USAGE privilege on the schema containing the distinct type
- Database administrator authority

To replace an existing table, the privileges held by the authorization ID of the statement must include at least one of the following:

- The following system authorities:
 - The system authority of *OBJMGT on the table
 - All authorities needed to DROP the table
- Database administrator authority

For information about the system authorities corresponding to SQL privileges, see [Corresponding System Authorities When Checking Privileges to a Table or View](#) and [Corresponding System Authorities When Checking Privileges to a Distinct Type](#).

Syntax

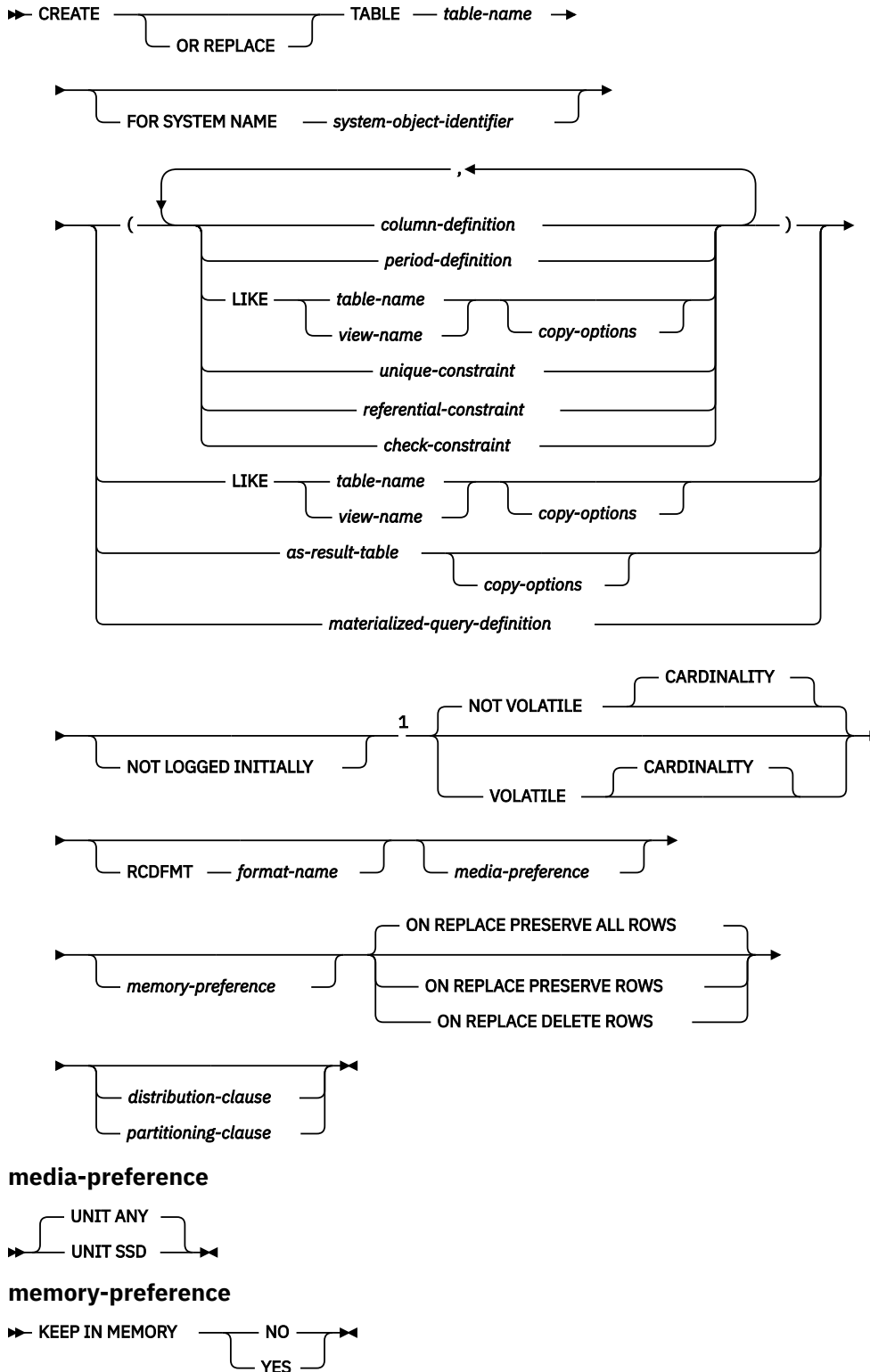

Notes:

¹ The optional clauses can be specified in any order.

column-definition

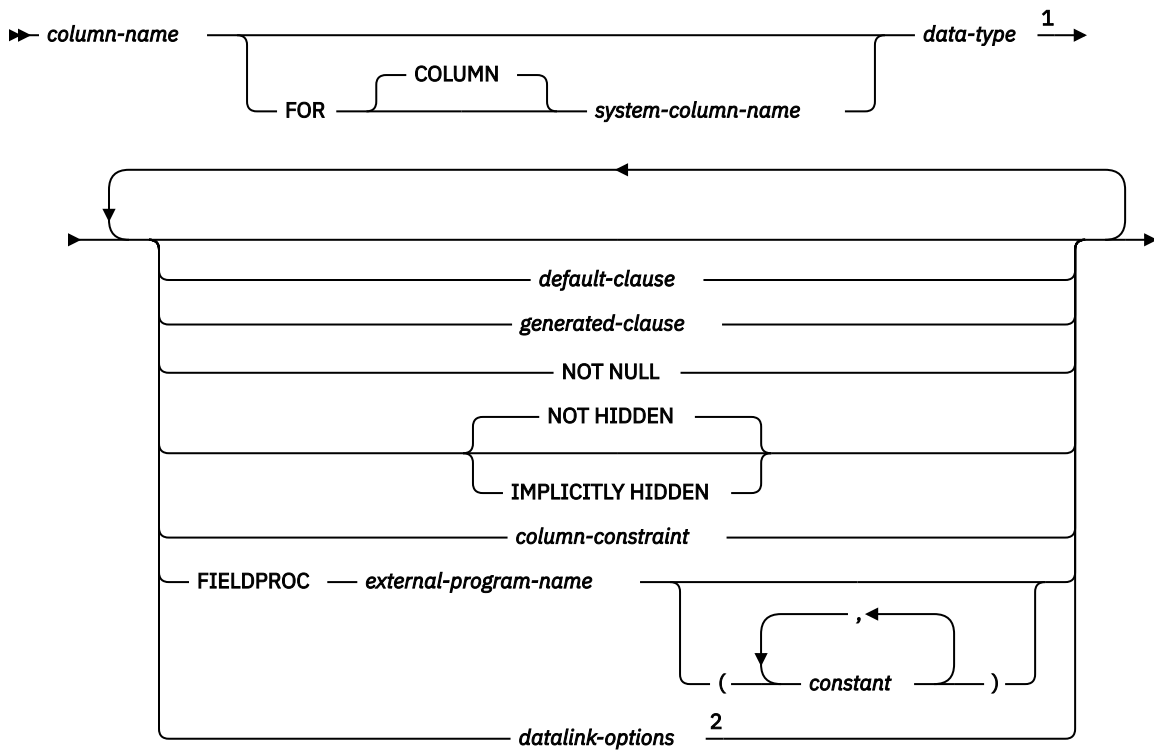

data-type

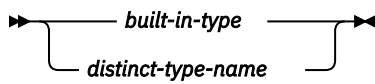

Notes:

¹ *data-type* is optional for row change timestamp columns, row-begin and row-end timestamp columns, and transaction-start-ID timestamp columns.

² The *datalink-options* can only be specified for DATALINKs and distinct types sourced on DATALINKs.

³ The same clause must not be specified more than once.

built-in-type

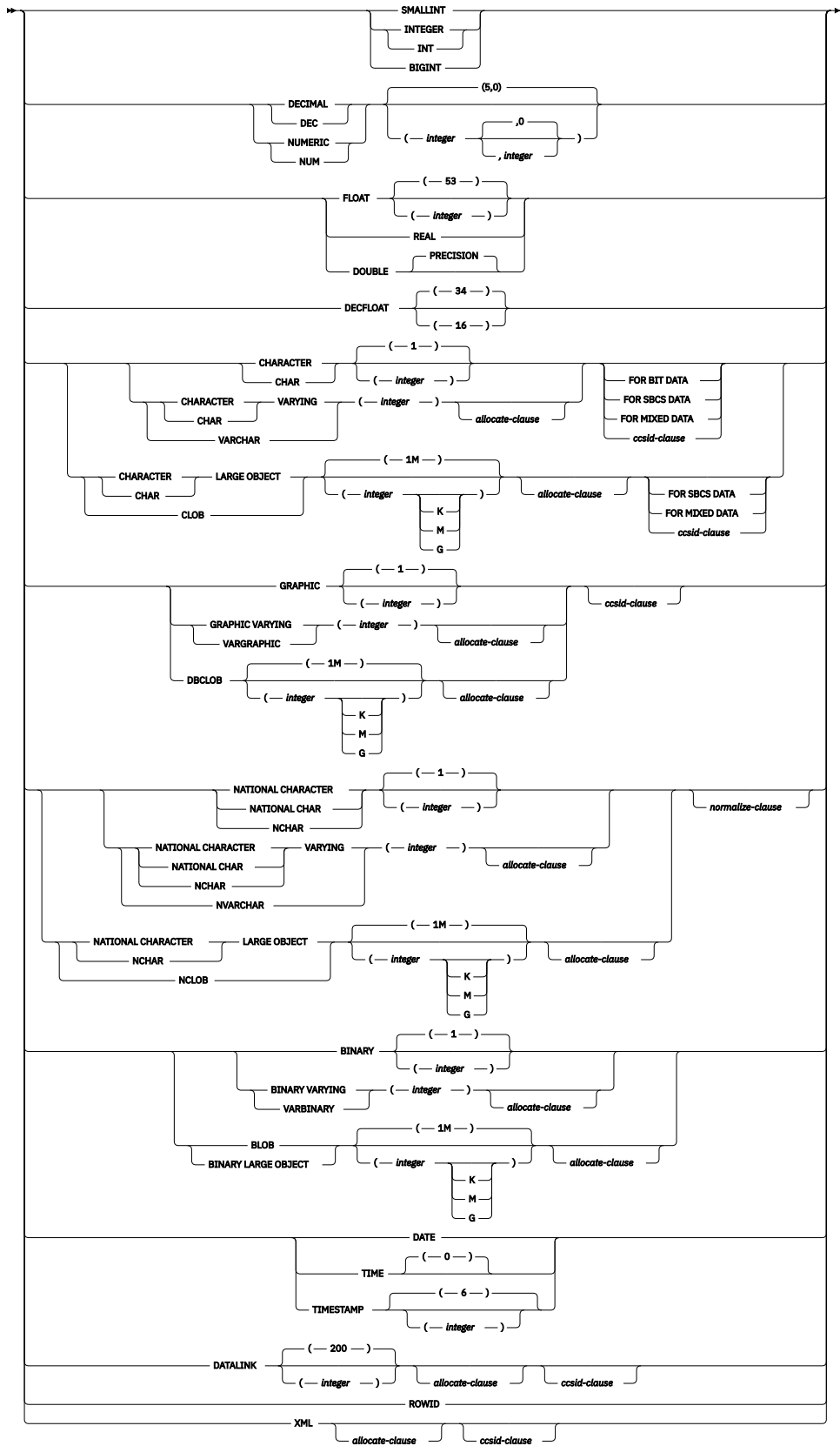

allocate-clause

➤ ALLOCATE — (— *integer* —) ➤

ccsid-clause

➤ CCSID — *integer* — *normalize-clause* ➤

normalize-clause

➤ NOT NORMALIZED — NORMALIZED ➤

default-clause

➤ WITH — DEFAULT ➤

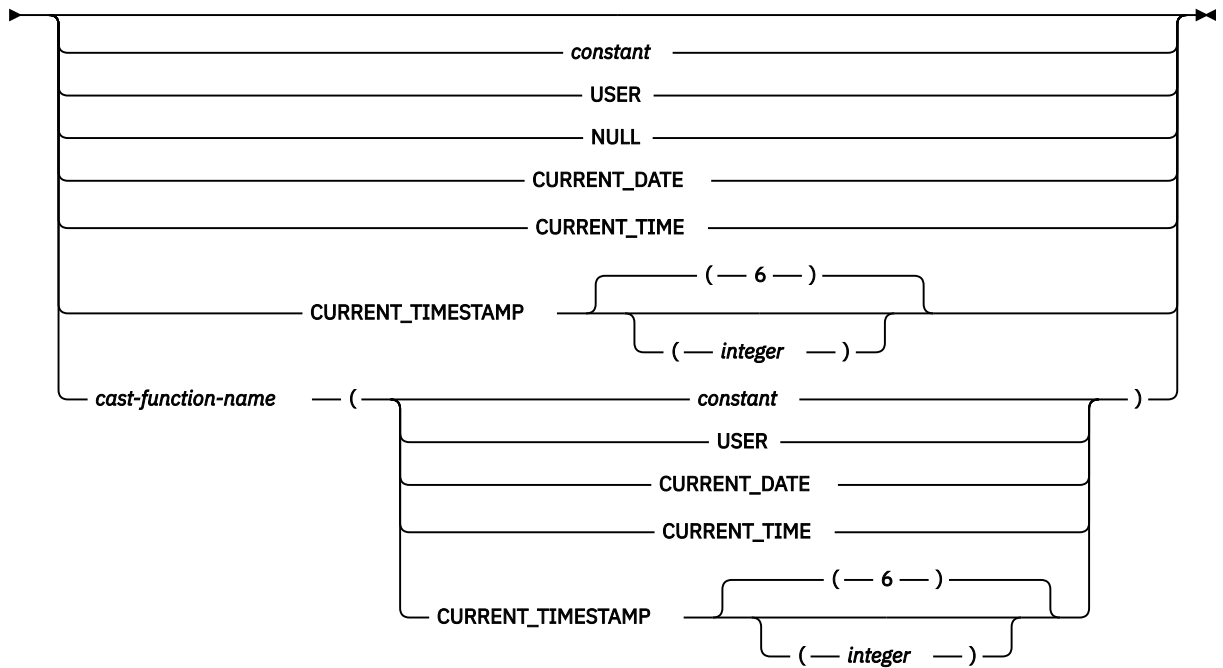

generated-clause

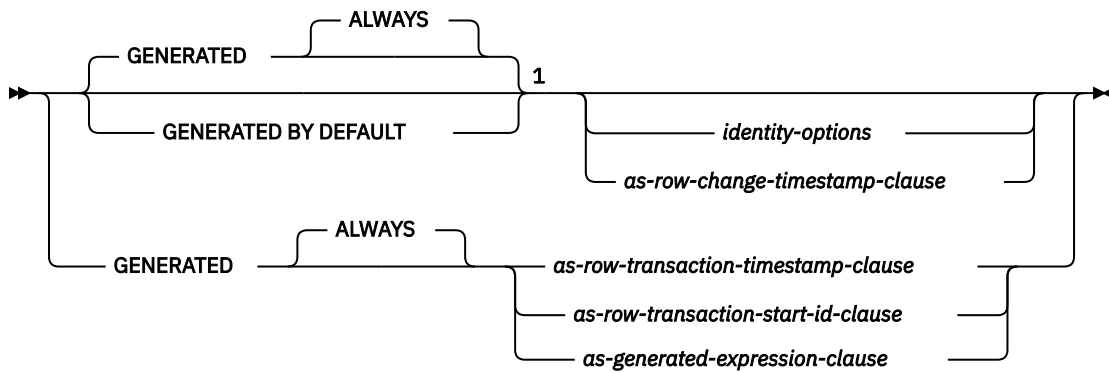

identity-options

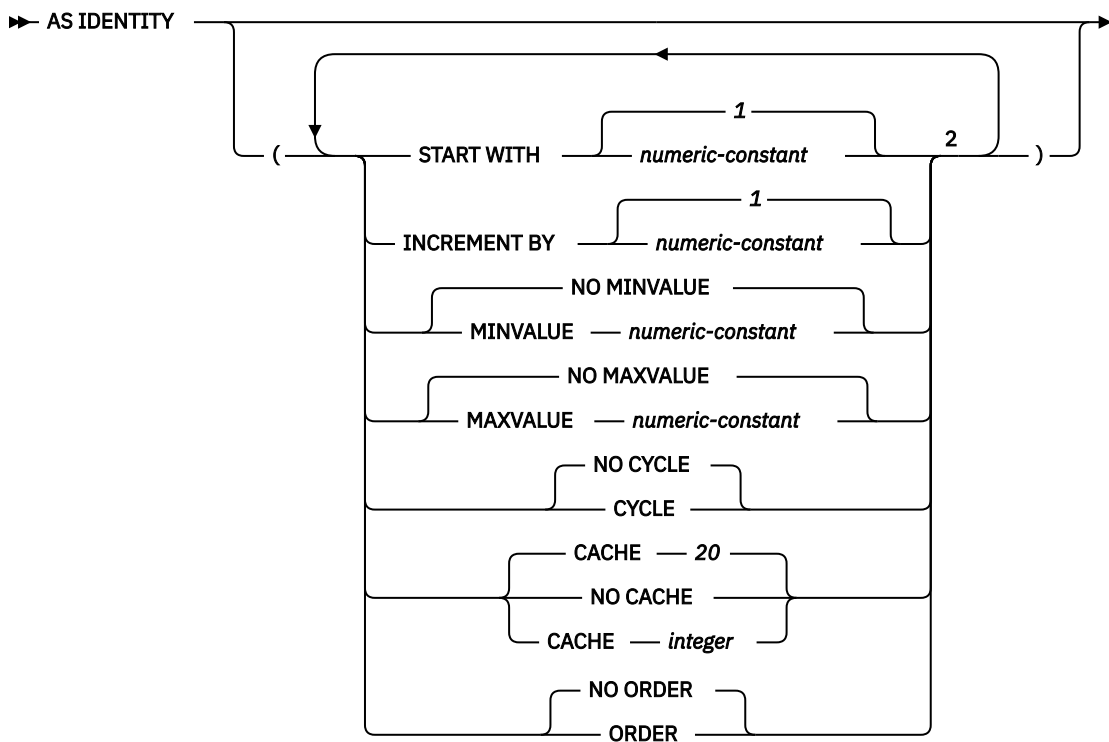

as-row-change-timestamp-clause

➤ FOR EACH ROW ON UPDATE AS ROW CHANGE TIMESTAMP ➤

as-row-transaction-timestamp-clause

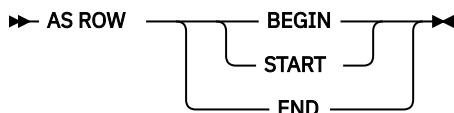

as-row-transaction-start-id-clause

➤ AS TRANSACTION START ID ➤

Notes:

¹ GENERATED can be specified only if the column has a ROWID data type (or a distinct type that is based on a ROWID data type), or the column is an identity column, or the column is a row change timestamp.

² The same clause must not be specified more than once.

as-generated-expression-clause

➤ AS (— *non-deterministic-expression* —) ➤

non-deterministic-expression

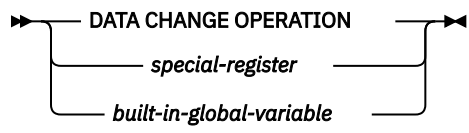

special-register

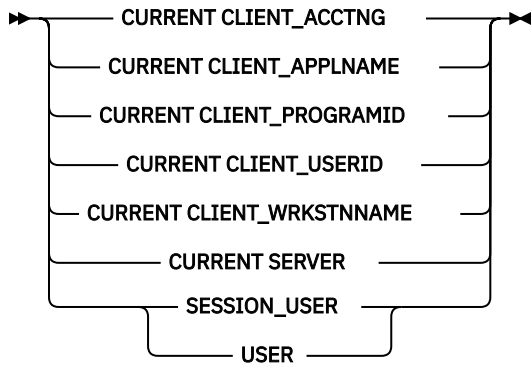

built-in-global-variable

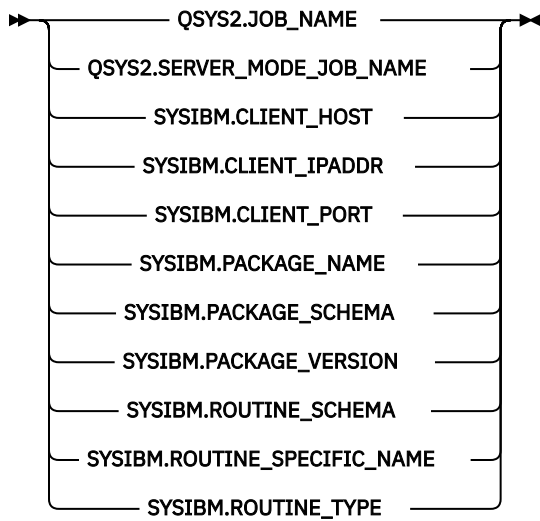

period-definition

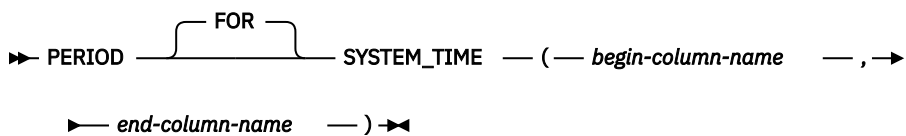

column-constraint

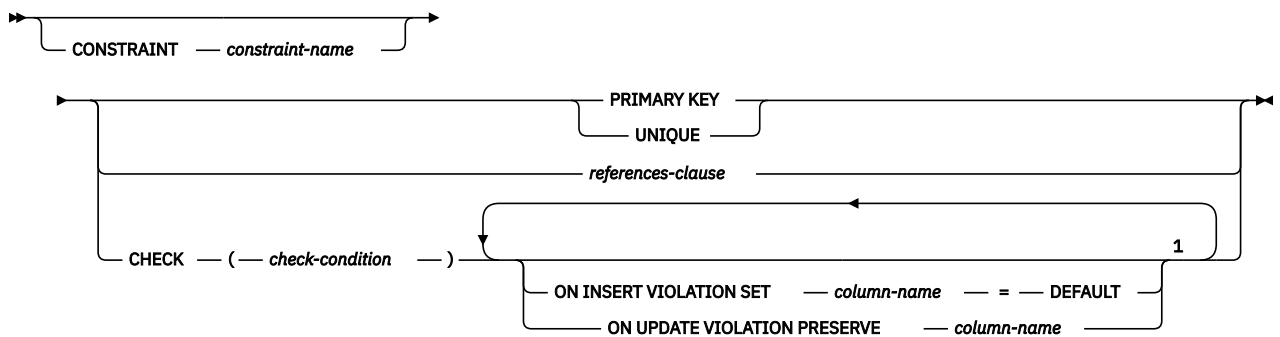

Notes:

¹ The same clause must not be specified more than once.

datalink-options

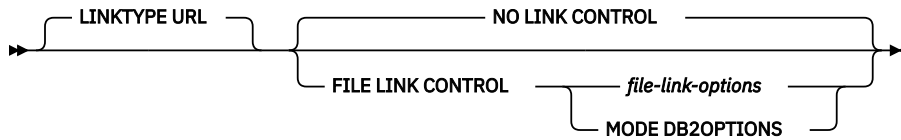

file-link-options

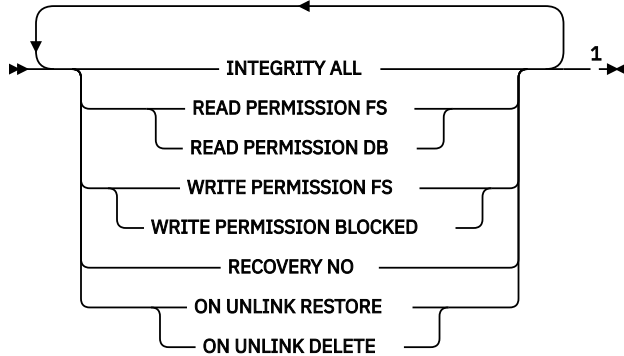

as-result-table

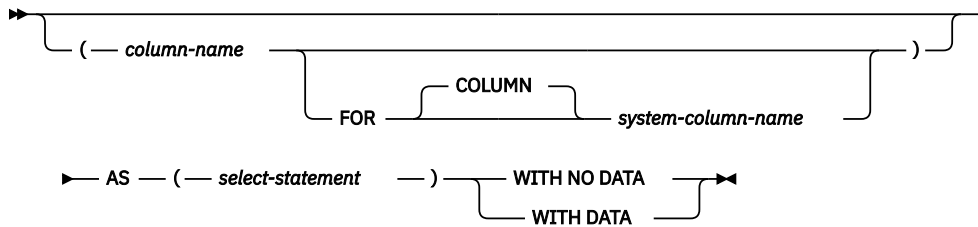

copy-options

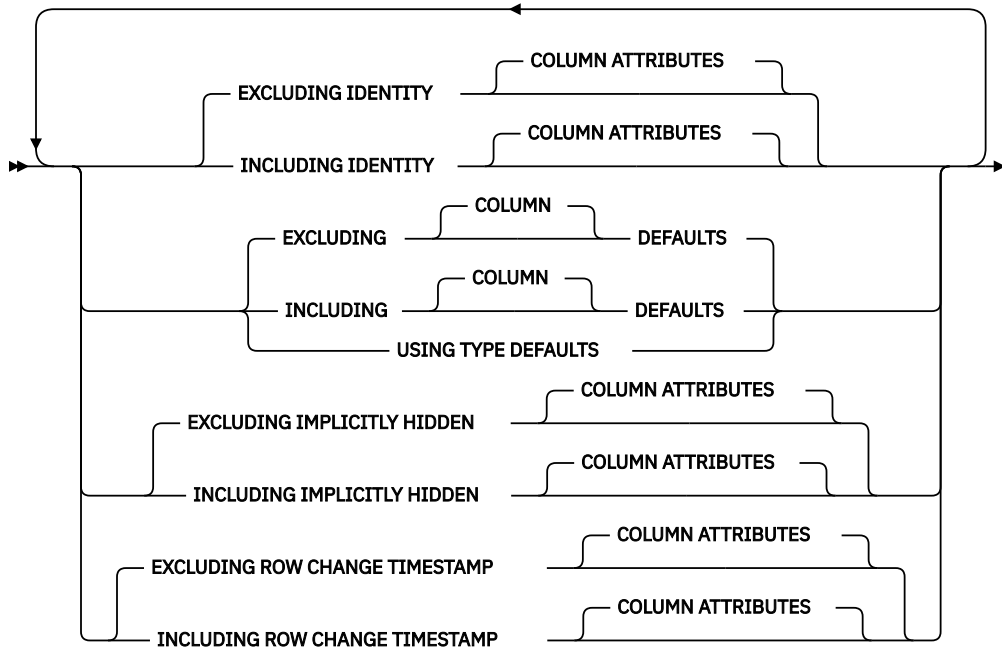

Notes:

¹ All five *file-link-options* must be specified, but they can be specified in any order.

unique-constraint

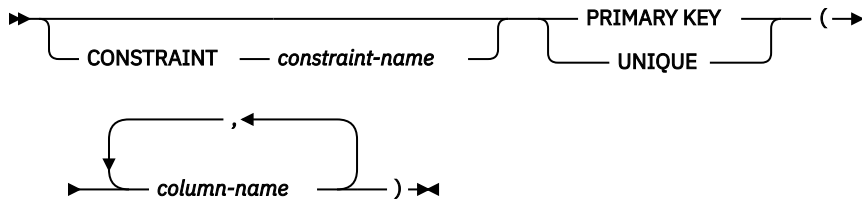

referential-constraint

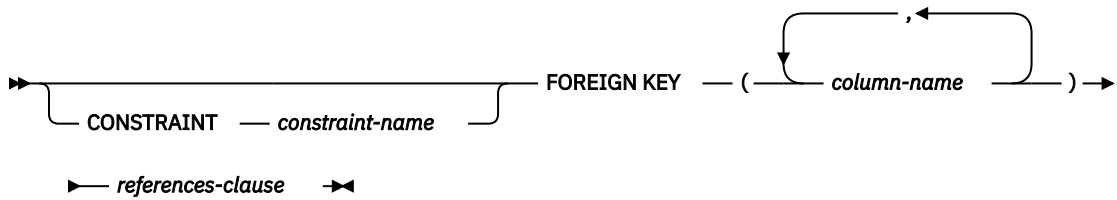

references-clause

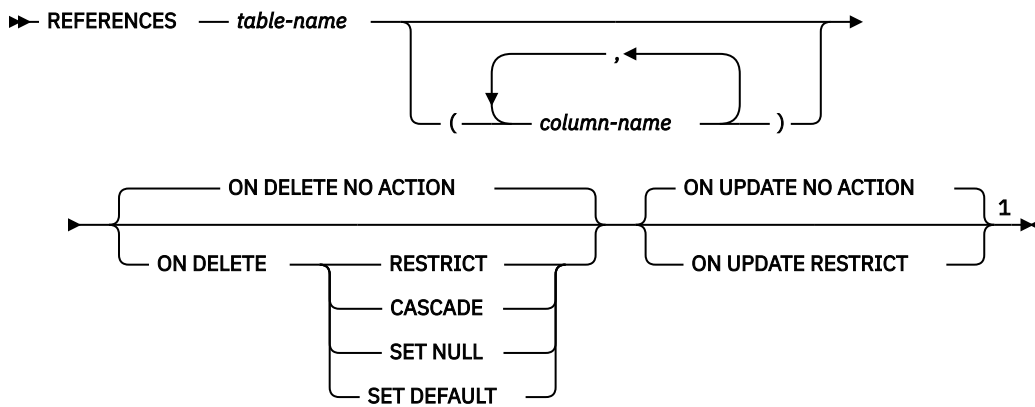

check-constraint

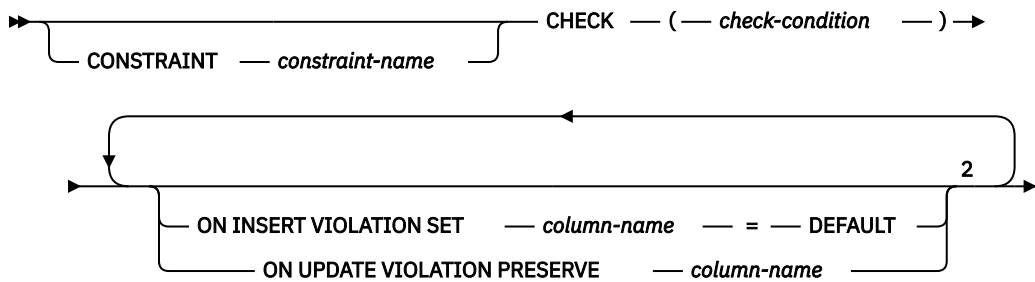

distribution-clause

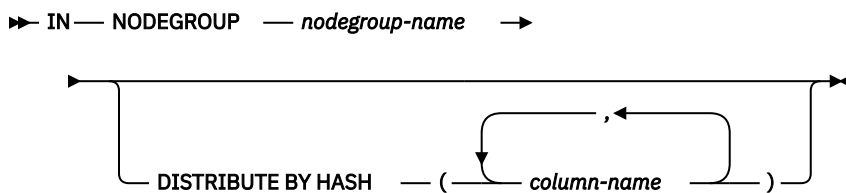

Notes:

- ¹ The ON DELETE and ON UPDATE clauses may be specified in either order.
- ² The same clause must not be specified more than once.

partitioning-clause

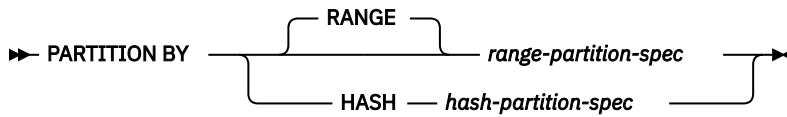

range-partition-spec

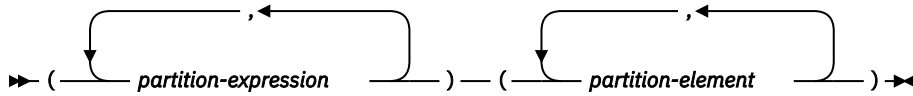

partition-expression

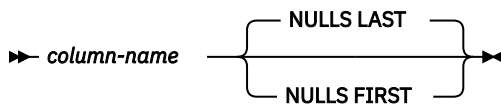

partition-element

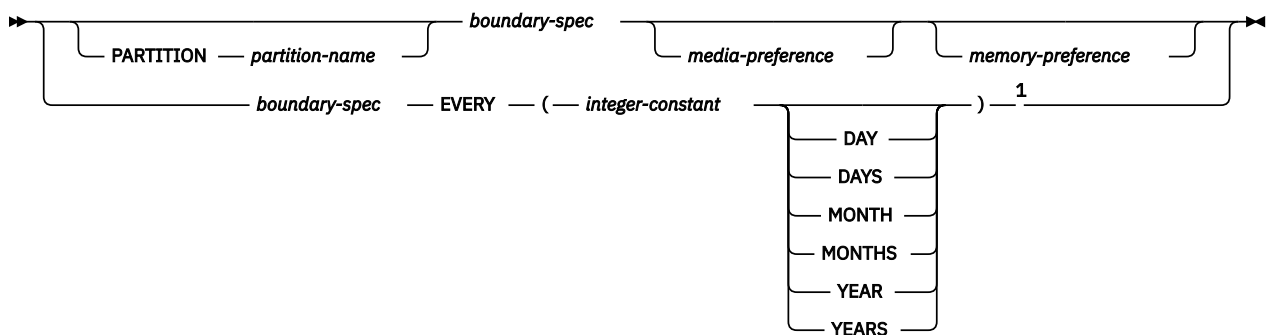

boundary-spec



starting-clause

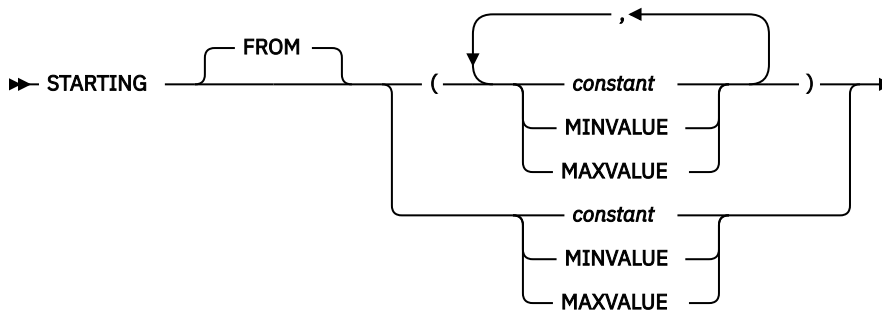

Notes:

¹ This syntax for a *partition-element* is valid if there is only one *partition-expression* with a numeric or datetime data type.

ending-clause

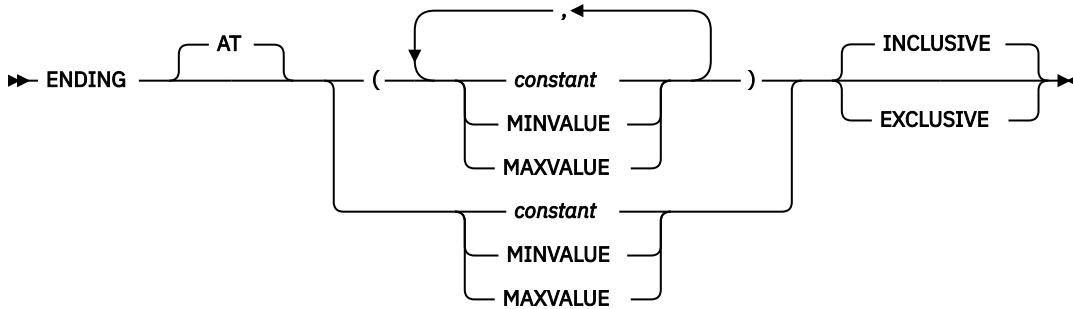

hash-partition-spec

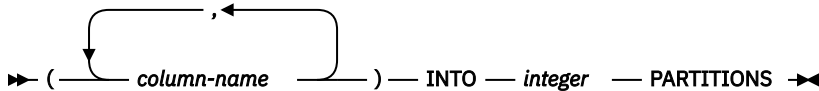

materialized-query-definition

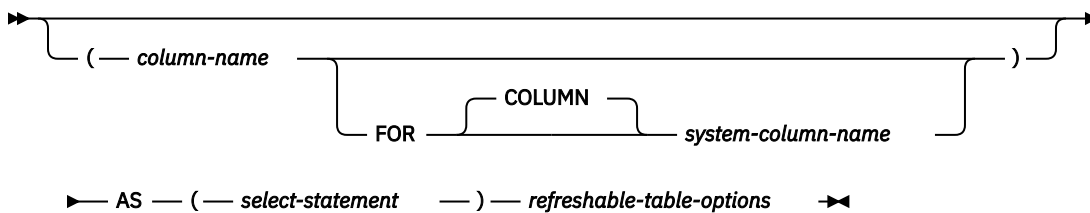

refreshable-table-options

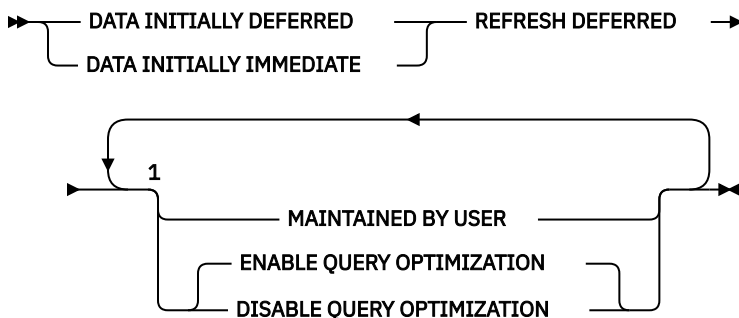

Notes:

¹ The same clause must not be specified more than once. MAINTAINED BY USER must be specified.

Description

OR REPLACE

Specifies to replace the definition for the table if one exists at the current server. The existing definition is effectively altered before the new definition is replaced in the catalog.

A definition for the table exists if:

- FOR SYSTEM NAME is specified and the *system-object-identifier* matches the *system-object-identifier* of an existing table.
- FOR SYSTEM NAME is not specified and *table-name* is a system object name that matches the *system-object-identifier* of an existing table.

If a definition for the table exists and *table-name* is not a system object name, *table-name* can be changed to provide a new name for the table.

This option is ignored if a definition for the table does not exist at the current server.

table-name

Names the table. The name, including the implicit or explicit qualifier, must not identify an alias, file, index, table, or view that already exists at the current server.

If SQL names were specified, the table will be created in the schema specified by the implicit or explicit qualifier.

If system names were specified, the table will be created in the schema that is specified by the qualifier. If not qualified:

- If the value of the CURRENT SCHEMA special register is *LIBL, the table will be created in the current library (*CURLIB).
- Otherwise, the table will be created in the current schema.

FOR SYSTEM NAME *system-object-identifier*

Identifies the *system-object-identifier* of the table. *system-object-identifier* must not be the same as a table, view, alias, or index that already exists at the current server. The *system-object-identifier* must be an unqualified system identifier.

When *system-object-identifier* is specified, *table-name* must not be a valid system object name.

column-definition

Defines the attributes of a column. There must be at least one column definition and no more than 8000 column definitions.

The sum of the row buffer byte counts of the columns must not be greater than 32766 or, if a VARCHAR, VARGRAPHIC, or VARBINARY column is specified, 32740. Additionally, if a LOB or XML column is specified, the sum of the row data byte counts of the columns must not be greater than 3 758 096 383 at the time of insert or update. For information about the byte counts of columns according to data type, see [“Maximum row sizes” on page 1154](#).

column-name

Names a column of the table. Do not qualify *column-name* and do not use the same name for more than one column of the table or for a *system-column-name* of the table.

FOR COLUMN *system-column-name*

Provides an IBM i name for the column. Do not use the same name for more than one column of the table or for a *column-name* of the table.

If the *system-column-name* is not specified, and the *column-name* is not a valid *system-column-name*, a *system column name* is generated. For more information about how *system column names* are generated, see [“Rules for Column Name Generation” on page 1156](#).

data-type

Specifies the data type of the column.

built-in-type

For *built-in-types*, use:

SMALLINT

For a small integer.

INTEGER or INT

For a large integer.

BIGINT

For a big integer.

DECIMAL(*integer,integer*) or DEC(*integer,integer*)**DECIMAL(*integer*) or DEC(*integer*)****DECIMAL or DEC**

For a packed decimal number. The first integer is the precision of the number; that is, the total number of digits; it can range from 1 to 63. The second integer is the scale of the number (the number of digits to the right of the decimal point). It can range from 0 to the precision of the number.

You can use DECIMAL(*p*) for DECIMAL(*p*,0), and DECIMAL for DECIMAL(5,0).

NUMERIC(*integer*,*integer*) or NUM(*integer*,*integer*)

NUMERIC(*integer*) or NUM(*integer*)

NUMERIC or NUM

For a zoned decimal number. The first integer is the precision of the number, that is, the total number of digits; it may range from 1 to 63. The second integer is the scale of the number, (the number of digits to the right of the decimal point). It may range from 0 to the precision of the number.

You can use NUMERIC(*p*) for NUMERIC(*p*,0), and NUMERIC for NUMERIC(5,0).

FLOAT

For a double-precision floating-point number.

FLOAT(*integer*)

For a single- or double-precision floating-point number, depending on the value of integer. The value of integer must be in the range 1 through 53. The values 1 through 24 indicate single-precision, the values 25 through 53 indicate double-precision. The default is 53.

REAL

For single-precision floating point.

DOUBLE PRECISION or DOUBLE

For double-precision floating point.

DECFLOAT(*integer*)

DECFLOAT

For a IEEE decimal floating-point number. The value of *integer* must be either 16 or 34 and represents the number of significant digits that can be stored. If *integer* is omitted, then the DECFLOAT column will be capable of representing 34 significant digits.

CHARACTER(*integer*) or CHAR(*integer*)

CHARACTER or CHAR

For a fixed-length character string of length *integer* bytes. The integer can range from 1 through 32766 (32765 if null capable). If FOR MIXED DATA or a mixed data CCSID is specified, the range is 4 through 32766 (32765 if null capable). If the length specification is omitted, a length of 1 is assumed.

CHARACTER VARYING (*integer*) or CHAR VARYING (*integer*) or VARCHAR (*integer*)

For a varying-length character string of maximum length *integer* bytes, which can range from 1 through 32740 (32739 if null capable). If FOR MIXED DATA or a mixed data CCSID is specified, the range is 4 through 32740 (32739 if null capable).

CHARACTER LARGE OBJECT (*integer*[K|M|G]) or CHAR LARGE OBJECT (*integer*[K|M|G]) or CLOB (*integer*[K|M|G])

CHARACTER LARGE OBJECT or CHAR LARGE OBJECT or CLOB

For a character large object string of the specified maximum length in bytes. The maximum length must be in the range of 1 through 2 147 483 647. If FOR MIXED DATA or a mixed data CCSID is specified, the range is 4 through 2 147 483 647. If the length specification is omitted, a length of 1 megabyte is assumed. A CLOB is not allowed in a distributed table.

integer

The maximum value for integer is 2 147 483 647. The maximum length of the string is *integer*.

integer K

The maximum value for integer is 2 097 152. The maximum length of the string is 1024 times *integer*.

integer M

The maximum value for integer is 2 048. The maximum length of the string is 1 048 576 times *integer*.

integer G

The maximum value for integer is 2. The maximum length of the string is 1 073 741 824 times *integer*.

GRAPHIC(*integer*)**GRAPHIC**

For a fixed-length graphic string of length *integer*, which can range from 1 through 16383 (16382 if null capable). If the length specification is omitted, a length of 1 is assumed.

VARGRAPHIC(*integer*) or GRAPHIC VARYING(*integer*)

For a varying-length graphic string of maximum length *integer*, which can range from 1 through 16370 (16369 if null capable).

DBCLOB(*integer*[K|M|G])**DBCLOB**

For a double-byte character large object string of the specified maximum length.

The maximum length must be in the range of 1 through 1 073 741 823. If the length specification is omitted, a length of 1 megabyte is assumed. A DBCLOB is not allowed in a distributed table.

integer

The maximum value for *integer* is 1 073 741 823. The maximum length of the string is *integer*.

***integer* K**

The maximum value for *integer* is 1 028 576. The maximum length of the string is 1024 times *integer*.

***integer* M**

The maximum value for *integer* is 1 024. The maximum length of the string is 1 048 576 times *integer*.

***integer* G**

The maximum value for *integer* is 1. The maximum length of the string is 1 073 741 824 times *integer*.

NATIONAL CHARACTER (*integer*) or NATIONAL CHAR (*integer*) or NCHAR (*integer*)**NATIONAL CHARACTER or NATIONAL CHAR or NCHAR**

For a fixed-length Unicode graphic string of length *integer*, which can range from 1 through 16383 (16382 if null capable). If the length specification is omitted, a length of 1 is assumed. The CCSID is 1200.

NATIONAL CHARACTER VARYING (*integer*) or NATIONAL CHAR VARYING (*integer*) or NCHAR VARYING (*integer*) or NVARCHAR (*integer*)

For a varying-length Unicode graphic string of maximum length *integer*, which can range from 1 through 16370 (16369 if null capable). The CCSID is 1200.

NATIONAL CHARACTER LARGE OBJECT (*integer*[K|M|G]) or NCHAR LARGE OBJECT (*integer*[K|M|G]) or NCLOB(*integer*[K|M|G])**NATIONAL CHARACTER LARGE OBJECT or NCHAR LARGE OBJECT or NCLOB**

For a Unicode double-byte character large object string of the specified maximum length.

The maximum length must be in the range of 1 through 1 073 741 823. If the length specification is omitted, a length of 1 megabyte is assumed. The CCSID is 1200. An NCLOB is not allowed in a distributed table.

integer

The maximum value for *integer* is 1 073 741 823. The maximum length of the string is *integer*.

***integer* K**

The maximum value for *integer* is 1 028 576. The maximum length of the string is 1024 times *integer*.

***integer* M**

The maximum value for *integer* is 1 024. The maximum length of the string is 1 048 576 times *integer*.

***integer* G**

The maximum value for *integer* is 1. The maximum length of the string is 1 073 741 824 times *integer*.

BINARY(*integer*)**BINARY**

For a fixed-length binary string of length *integer*. The integer can range from 1 through 32766 (32765 if null capable). If the length specification is omitted, a length of 1 is assumed.

BINARY VARYING (*integer*) or VARBINARY(*integer*)

For a varying-length binary string of maximum length *integer*, which can range from 1 through 32740 (32739 if null capable).

BLOB(*integer*[K|M|G]) or BINARY LARGE OBJECT(*integer*[K|M|G])**BLOB or BINARY LARGE OBJECT**

For a binary large object string of the specified maximum length. The maximum length must be in the range of 1 through 2 147 483 647. If the length specification is omitted, a length of 1 megabyte is assumed. A BLOB is not allowed in a distributed table.

integer

The maximum value for *integer* is 2 147 483 647. The maximum length of the string is *integer*.

integer K

The maximum value for *integer* is 2 097 152. The maximum length of the string is 1024 times *integer*.

integer M

The maximum value for *integer* is 2 048. The maximum length of the string is 1 048 576 times *integer*.

integer G

The maximum value for *integer* is 2. The maximum length of the string is 1 073 741 824 times *integer*.

DATE

For a date.

TIME

For a time.

TIMESTAMP(*integer*) or TIMESTAMP

For a timestamp. The integer must be between 0 and 12 and specifies the precision of fractional seconds from 0 (seconds) to 12 (picoseconds). The default is 6 (microseconds).

DATALINK(*integer*) or DATALINK

For a DataLink of the specified maximum length. The maximum length must be in the range of 1 through 32717. If FOR MIXED DATA or a mixed data CCSID is specified, the range is 4 through 32717. The specified length must be sufficient to contain both the largest expected URL and any DataLink comment. If the length specification is omitted, a length of 200 is assumed. A DATALINK is not allowed in a distributed table.

A DATALINK value is an encapsulated value with a set of built-in scalar functions. The DLVALUE function creates a DATALINK value. The following functions can be used to extract attributes from a DATALINK value.

- DLCOMMENT
- DLLINKTYPE
- DLURLCOMPLETE
- DLURLPATH
- DLURLPATHONLY
- DLURLSCHEME
- DLURLSERVER

A DataLink cannot be part of any index. Therefore, it cannot be included as a column of a primary key, foreign key, or unique constraint.

ROWID

For a row ID. Only one ROWID column is allowed in a table. A ROWID is not allowed in a partitioned table.

XML

For an XML document. Only well-formed documents can be inserted into an XML column. The CCSID for the column cannot be 65535. The maximum length of the column is always 2 147 483 647 bytes.

An XML column has the following restrictions:

- The column cannot be part of any index.
- The column cannot be part of a primary, unique, or foreign key.
- The column cannot be used in a check constraint.
- A default value (WITH DEFAULT) cannot be specified for the column. If the column is nullable, the default for the column is the null value.
- The column cannot be specified in the distribution clause of a distributed table.
- The column cannot be specified in the partitioning clause of a partitioned table.

distinct-type-name

Specifies that the data type of the column is a distinct type (a user-defined data type). The length, precision, and scale of the column are respectively the length, precision, and scale of the source type of the distinct type. If a distinct type name is specified without a schema name, the distinct type name is resolved by searching the schemas on the SQL path.

ALLOCATE(*integer*)

Specifies for VARCHAR, VARGRAPHIC, VARBINARY, XML, and LOB types the space to be reserved for the column in each row. Column values with lengths less than or equal to the allocated value are stored in the fixed-length portion of the row. Column values with lengths greater than the allocated value are stored in the variable-length portion of the row and require additional input/output operations to retrieve. The allocated value may range from 1 to maximum length of the string, subject to the maximum row buffer size limit. For information about the maximum row buffer size, see [“Maximum row sizes”](#) on page 1154. If FOR MIXED DATA or a mixed data CCSID is specified, the range is 4 to the maximum length of the string. If the allocated length specification is omitted, an allocated length of 0 is assumed. For VARGRAPHIC, the integer is the number of DBCS or Unicode graphic characters. If a constant is specified for the default value and the ALLOCATE length is less than the length of the default value, the ALLOCATE length is assumed to be the length of the default value.

FOR BIT DATA

Specifies that the values of the column are not associated with a coded character set and are never converted. FOR BIT DATA is only valid for CHARACTER or VARCHAR columns. The CCSID of a FOR BIT DATA column is 65535. FOR BIT DATA is not allowed for CLOB columns.

FOR SBCS DATA

Specifies that the values of the column contain SBCS (single-byte character set) data. FOR SBCS DATA is the default for CHAR, VARCHAR, and CLOB columns if the default CCSID at the current server at the time the table is created is not DBCS-capable or if the length of the column is less than 4. FOR SBCS DATA is only valid for CHARACTER, VARCHAR, or CLOB columns. The CCSID of FOR SBCS DATA is determined by the default CCSID at the current server at the time the table is created.

FOR MIXED DATA

Specifies that the values of the column contain both SBCS data and DBCS data. FOR MIXED DATA is the default for CHAR, VARCHAR, and CLOB columns if the default CCSID at the current server at the time the table is created is DBCS-capable and the length of the column is greater than 3. Every FOR MIXED DATA column is a DBCS-open application server field. FOR MIXED DATA is only valid for CHARACTER, VARCHAR, or CLOB columns. The CCSID of FOR MIXED DATA is determined by the default CCSID at the current server at the time the table is created.

CCSID integer

Specifies that the values of the column contain data of CCSID integer. If the integer is an SBCS CCSID, the column is SBCS data. If the integer is a mixed data CCSID, the column is mixed data and the length of the column must be greater than 3. For character columns, the CCSID must be an SBCS CCSID or a mixed data CCSID. For graphic columns, the CCSID must be a DBCS, UTF-16, or UCS-2 CCSID. If a CCSID is not specified for a graphic column, the CCSID is determined by the default CCSID at the current server at the time the table is created. For XML columns, the CCSID must not be 65535. If a CCSID is not specified for an XML column, the CCSID is established at the time the CREATE TABLE is executed according to the SQL_XML_DATA_CCSID QAQQINI option setting. The default CCSID is 1208. See “XML Values” on page 80 for a description of this option. For a list of valid CCSIDs, see Appendix E, “CCSID values,” on page 1687.

CCSID 1208 (UTF-8) or 1200 (UTF-16) data can contain *combining characters*. Combining character support allows a resulting character to be comprised of more than one character. After the first character, up to 300 different non-spacing accent characters (umlauts, accent, etc.) can follow in the data string. If the resulting character is one that is already defined in the character set, that character has more than one representation. *Normalization* replaces the string of combining characters with the hex value of the defined character. This ensures that the same character is represented in a single consistent way. If normalization is not performed, two strings that look identical will not compare equal.

NOT NORMALIZED

The data should not be normalized when passed from the application.

NORMALIZED

The data should be normalized when passed from the application.

DEFAULT

Specifies a default value for the column. This clause cannot be specified more than once in a *column-definition*. DEFAULT cannot be specified for the following types of columns because Db2 generates default values:

- a ROWID column
- an identity column (a column that is defined AS IDENTITY)
- a row change timestamp column
- a row-begin column
- a row-end column
- a transaction-start-ID column
- a generated expression column

For an XML column, the default is NULL unless NOT NULL is specified; in that case there is no default.

If a value is not specified following the DEFAULT keyword, then:

- if the column is nullable, the default value is the null value.
- if the column is not nullable, the default depends on the data type of the column:

Data type	Default value
Numeric	0
Fixed-length character or graphic string	Blanks
Fixed-length binary string	Hexadecimal zeros
Varying-length string	A string length of 0
Date	The current date at the time of INSERT
Time	The current time at the time of INSERT
Timestamp	The current timestamp at the time of INSERT

Data type	Default value
Datalink	A value corresponding to DLVALUE('','URL','')
<i>distinct-type</i>	The default value of the corresponding source type of the distinct type.

Omission of NOT NULL and DEFAULT from a *column-definition* is an implicit specification of DEFAULT NULL.

constant

Specifies the constant as the default for the column. The specified constant must represent a value that could be assigned to the column in accordance with the rules of assignment as described in “Assignments and comparisons” on page 91. A floating-point constant or decimal floating-point constant must not be used for a SMALLINT, INTEGER, DECIMAL, or NUMERIC column. A decimal constant must not contain more digits to the right of the decimal point than the specified scale of the column.

USER

Specifies the value of the USER special register at the time of INSERT or UPDATE as the default value of the column. The data type of the column must be CHAR or VARCHAR with a length attribute that is greater than or equal to the length attribute of the USER special register. The value of the USER special register is not converted to the CCSID of the column.

NULL

Specifies null as the default for the column. If NOT NULL is specified, DEFAULT NULL must not be specified within the same *column-definition*.

NULL is the only default value allowed for a datalink column.

CURRENT_DATE

Specifies the current date as the default for the column. If CURRENT_DATE is specified, the data type of the column must be DATE or a distinct type based on a DATE.

CURRENT_TIME

Specifies the current time as the default for the column. If CURRENT_TIME is specified, the data type of the column must be TIME or a distinct type based on a TIME.

CURRENT_TIMESTAMP or CURRENT_TIMESTAMP(integer)

Specifies the current timestamp as the default for the column. If CURRENT_TIMESTAMP is specified, the data type of the column must be TIMESTAMP or a distinct type based on a TIMESTAMP. The timestamp precision of the CURRENT_TIMESTAMP special register used as the default will always match the timestamp precision of the column, regardless of the precision specified for the special register.

cast-function-name

This form of a default value can only be used with columns defined as a strongly typed distinct type, BINARY, VARBINARY, BLOB, CLOB, DBCLOB, DATE, TIME or TIMESTAMP data types. The following table describes the allowed uses of these *cast-functions*.

Data Type	Cast Function Name
Strongly typed distinct type N based on a BINARY, VARBINARY, BLOB, CLOB, or DBCLOB	BINARY, VARBINARY, BLOB, CLOB, or DBCLOB *
Strongly typed distinct type N based on a DATE, TIME, or TIMESTAMP	N (the user-defined cast function that was generated when N was created) ** or DATE, TIME, or TIMESTAMP *
Strongly typed distinct type N based on other data types	N (the user-defined cast function that was generated when N was created) **

Data Type	Cast Function Name
BINARY, VARBINARY, BLOB, CLOB, or DBCLOB	BINARY, VARBINARY, BLOB, CLOB, or DBCLOB *
DATE, TIME, or TIMESTAMP	DATE, TIME, or TIMESTAMP *
<p>Notes:</p> <p>* The name of the function must match the name of the data type (or the source type of the distinct type) with an implicit or explicit schema name of QSYS2.</p> <p>** The name of the function must match the name of the distinct type for the column. If qualified with a schema name, it must be the same as the schema name for the distinct type. If not qualified, the schema name from function resolution must be the same as the schema name for the distinct type.</p>	

constant

Specifies a constant as the argument. The constant must conform to the rules of a constant for the source type of the distinct type or for the data type if not a distinct type. For BINARY, VARBINARY, BLOB, CLOB, DBCLOB, DATE, TIME, and TIMESTAMP functions, the constant must be a string constant.

USER

Specifies the value of the USER special register at the time of INSERT or UPDATE as the default value for the column. The data type of the source type of the distinct type of the column must be CHAR or VARCHAR with a length attribute greater than or equal to the length attribute of the USER special register. The value of the USER special register is not converted to the CCSID of the column.

CURRENT_DATE

Specifies the current date as the default for the column. If CURRENT_DATE is specified, the data type of the source type of the distinct type of the column must be DATE.

CURRENT_TIME

Specifies the current time as the default for the column. If CURRENT_TIME is specified, the data type of the source type of the distinct type of the column must be TIME.

CURRENT_TIMESTAMP or CURRENT_TIMESTAMP(*integer*)

Specifies the current timestamp as the default for the column. If CURRENT_TIMESTAMP is specified, the data type of the source type of the distinct type of the column must be TIMESTAMP. The timestamp precision of the CURRENT_TIMESTAMP special register used as the default will always match the timestamp precision of the column, regardless of the precision specified for the special register.

If the value specified is not valid, an error is returned.

GENERATED

Specifies that the database manager generates values for the column. GENERATED may be specified if the column is to be considered one of the following types of columns:

- an identity column
- a row change timestamp column

GENERATED must be specified if the column is to be considered one of the following types of columns:

- a row-begin column
- a row-end column
- a transaction-start-ID column
- a generated expression column

It may also be specified if the data type of the column is a ROWID (or a distinct type that is based on a ROWID). Otherwise, it must not be specified. GENERATED must not be specified with *default-clause* in a column definition.

ALWAYS

Specifies that the database manager will always generate a value for the column when a row is inserted or updated and a default value must be generated. ALWAYS is the recommended value.

BY DEFAULT

Specifies that the database manager will generate a value for the column when a row is inserted or updated and a default value must be generated, unless an explicit value is specified.

For a ROWID column, the database manager uses a specified value, but it must be a valid unique row ID value that was previously generated by the database manager or Db2 for i.

For an identity column or row change timestamp column, the database manager inserts or updates a specified value but does not verify that it is a unique value for the column unless the identity column or row change timestamp column has a unique constraint or a unique index that solely specifies the identity column or row change timestamp column.

AS IDENTITY

Specifies that the column is an identity column for the table. A table can have only one identity column. An identity column is not allowed in a distributed table. AS IDENTITY can be specified only if the data type for the column is an exact numeric type with a scale of zero (SMALLINT, INTEGER, BIGINT, DECIMAL, or NUMERIC with a scale of zero, or a distinct type based on one of these data types). If a DECIMAL or NUMERIC data type is specified, the precision must not be greater than 31.

An identity column is implicitly NOT NULL.

START WITH *numeric-constant*

Specifies the first value that is generated for the identity column. The value can be any positive or negative value that could be assigned to the column without non-zero digits existing to the right of the decimal point.

If a value is not explicitly specified when the identity column is defined, the default is the MINVALUE for an ascending sequence and the MAXVALUE for a descending sequence. This value is not necessarily the value that a sequence would cycle to after reaching the maximum or minimum value of the sequence. The START WITH clause can be used to start a sequence outside the range that is used for cycles. The range used for cycles is defined by MINVALUE and MAXVALUE.

INCREMENT BY *numeric-constant*

Specifies the interval between consecutive values of the identity column. The value must not exceed the value of a large integer constant without any non-zero digits existing to the right of the decimal point. The value must be assignable to the column. The default is 1.

If the value is zero or positive, the sequence of values for the identity column ascends. If the value is negative, the sequence of values descends.

MAXVALUE or MINVALUE

Specifies the maximum value at which an ascending identity column either cycles or stops generating values, or a descending identity column cycles to after reaching the minimum value.

MAXVALUE *numeric-constant*

Specifies the numeric constant that is the maximum value that is generated for this identity column. This value can be any positive or negative value that could be assigned to this column, but the value must be greater than the minimum value.

If a value is not explicitly specified when the identity column is defined, this is the maximum value of the data type for an ascending sequence; or the START WITH value, or -1 if START WITH was not specified, for a descending sequence.

MINVALUE *numeric-constant*

Specifies the numeric constant that is the minimum value that is generated for this identity column. This value can be any positive or negative value that could be assigned to this column, but the value must be less than the maximum value.

If a value is not explicitly specified when the identity column is defined, this is the START WITH value, or 1 if START WITH was not specified, for an ascending sequence; or the minimum value of the data type (and precision, if DECIMAL) for a descending sequence.

CACHE or NO CACHE

Specifies whether to keep some preallocated values in memory. Preallocating and storing values in the cache improves the performance of inserting rows into a table.

CACHE *integer*

Specifies the number of values of the identity column sequence that the database manager preallocates and keeps in memory. The minimum value that can be specified is 2, and the maximum is the largest value that can be represented as an integer. The default is 20.

In certain situations, such as system failure, all cached identity column values that have not been used in committed statements are lost, and thus, will never be used. The value specified for the CACHE option is the maximum number of identity column values that could be lost in these situations.

NO CACHE

Specifies that values for the identity column are not preallocated.

CYCLE or NO CYCLE

Specifies whether this identity column should continue to generate values after reaching either the maximum or minimum value of the sequence.

CYCLE

Specifies that values continue to be generated for this column after the maximum or minimum value has been reached. If this option is used, after an ascending sequence reaches the maximum value of the sequence, it generates its minimum value. After a descending sequence reaches its minimum value of the sequence, it generates its maximum value. The maximum and minimum values for the column determine the range that is used for cycling.

When CYCLE is in effect, duplicate values can be generated by the database manager for an identity column. If a unique constraint or unique index exists on the identity column, and a non-unique value is generated for it, an error occurs.

NO CYCLE

Specifies that values will not be generated for the identity column once the maximum or minimum value for the sequence has been reached. This is the default.

ORDER or NO ORDER

Specifies whether the identity values must be generated in order of request.

ORDER

Specifies that the values are generated in order of request.

NO ORDER

Specifies that the values do not need to be generated in order of request. This is the default.

FOR EACH ROW ON UPDATE AS ROW CHANGE TIMESTAMP

Specifies that the column is a timestamp and the values will be generated by the database manager. The database manager generates a value for the column for each row as a row is inserted, and for every row in which any column is updated. The value generated for a row change timestamp column is a timestamp corresponding to the time of the insert or update of the row. If multiple rows are inserted with a single SQL statement, the value for the row change timestamp column may be different for each row to reflect when each row was inserted. The generated value is not guaranteed to be unique.

A table can have only one row change timestamp column. If *data-type* is specified, it must be a TIMESTAMP with a precision of 6 or a distinct type based on a TIMESTAMP with a precision of 6. A row change timestamp column cannot have a DEFAULT clause and must be NOT NULL.

AS ROW BEGIN

Specifies that the column contains timestamp data and that the values are generated by the database manager. The database manager generates a value for the column for each row as the row is inserted, and for every row in which any column is updated. The generated value is a timestamp that corresponds to the start time that is associated with the most recent transaction. If multiple rows are inserted with a single SQL statement, the values for the transaction start timestamp column are the same for each row.

For a system-period temporal table, the database manager ensures uniqueness of the generated values for a row-begin column across transactions. The timestamp value might be adjusted to ensure that rows inserted into an associated history table have the end timestamp value greater than the begin timestamp value. This can happen when a conflicting transaction is updating the same row in the system-period temporal table. The `SYSTIME_PERIOD_ADJ QAQQINI` option must be set to `*ADJUST` for this adjustment to the timestamp value to occur. If multiple rows are inserted or updated within a single SQL transaction and an adjustment is not needed, the values for the row-begin column are the same for all the rows and are unique from the values generated for the column for another transaction.

A row-begin column is intended to be used for a system-period temporal table and is required as the first column of a `SYSTEM_TIME` period. A table can have only one row-begin column. If *data-type* is not specified, the column is defined as `TIMESTAMP(12)`. If *data-type* is specified, it must be `TIMESTAMP(12)`. It cannot be a distinct type. The column cannot have a `DEFAULT` clause and must be defined as `NOT NULL`. A row-begin column is not updatable.

AS ROW END

Specifies that a value for the data type of the column is assigned by the database manager whenever a row is inserted or any column in the row is updated. The assigned value is `TIMESTAMP '9999-12-30-0.00.00.000000000000'`. For a system-period temporal table, when a row is deleted, the value of the row-end column in the historical row reflects when the row was deleted. If multiple rows are deleted with a single SQL statement, the values for the column in the historical rows are the same.

A row-end column is intended to be used for a system-period temporal table and is required as the second column of a `SYSTEM_TIME` period. A table can have only one row-end column. If *data-type* is not specified, the column is defined as `TIMESTAMP(12)`. If *data-type* is specified, it must be `TIMESTAMP(12)`. It cannot be a distinct type. The column cannot have a `DEFAULT` clause and must be defined as `NOT NULL`. A row-end column is not updatable.

AS TRANSACTION START ID

Specifies that the value is assigned by the database manager whenever a row is inserted into the table or any column in the row is updated. The database manager assigns a unique timestamp value per transaction or the null value. The null value is assigned to the transaction-start-ID column if the column is nullable and if there is a row-begin column in the table for which the value did not need to be adjusted. Otherwise the value is generated using a reading of the time-of-day clock during execution of the first data change statement in the transaction that requires a value to be assigned to a row-begin column or transaction-start-ID column in the table, or a row in a system-period temporal table is deleted. If multiple rows are inserted or updated within a single SQL transaction, the values for the transaction-start-ID column are the same for all the rows and are unique from the values generated for the column for another transaction.

A transaction-start-ID column is intended to be used for a system-period temporal table and is required for a system-period temporal table. A table can have only one transaction-start-ID column. If *data-type* is not specified, the column is defined as `TIMESTAMP(12)`. If *data-type* is specified it must be `TIMESTAMP(12)`. It cannot be a distinct type. A transaction-start-ID column cannot have a `DEFAULT` clause. A transaction-start-ID column is not updatable.

DATA CHANGE OPERATION

Specifies that the database manager generates a value for each row that is inserted, for every row in which any column is updated, and for all rows deleted from a system-period temporal table when the history table is defined with `ON DELETE ADD EXTRA ROW`. The column will contain one of the following values:

- I** insert operation
- U** update operation
- D** delete operation

If *data-type* is not specified, the column is defined as CHAR(1). If *data-type* is specified it must be CHAR(1). It cannot be a distinct type. The column cannot have a DEFAULT clause or a field procedure.

special-register

Specifies that the value of a special register is assigned by the database manager for each row that is inserted, for every row in which any column is updated, and for all rows deleted from a system-period temporal table when the history table is defined with ON DELETE ADD EXTRA ROW. The value of the special register at the time of the data change statement is used. If multiple rows are changed with a single SQL statement, the value for the column will be the same for all of the rows.

data-type must be defined according to the following table. It cannot be a distinct type.

Special register	Data type for the column
CURRENT CLIENT_ACCTNG	VARCHAR(255)
CURRENT CLIENT_APPLNAME	VARCHAR(255)
CURRENT CLIENT_PROGRAMID	VARCHAR(255)
CURRENT CLIENT_USERID	VARCHAR(255)
CURRENT CLIENT_WRKSTNNAME	VARCHAR(255)
CURRENT SERVER	VARCHAR(18)
SESSION_USER	VARCHAR(128)
USER	VARCHAR(18)

The column cannot have a DEFAULT clause or a field procedure.

built-in-global-variable

Specifies that the value of a built-in global variable is assigned by the database manager for each row that is inserted, for every row in which any column is updated, and for all rows deleted from a system-period temporal table when the history table is defined with ON DELETE ADD EXTRA ROW. The value of the built-in global variable at the time of the data change statement is used. If multiple rows are changed with a single SQL statement, the value for the column will be the same for all of the rows.

data-type must be defined according to the following table. It cannot be a distinct type.

Built-in global variable	Data type for the column
QSYS2.JOB_NAME	VARCHAR(28)
QSYS2.SERVER_MODE_JOB_NAME	VARCHAR(28)
SYSIBM.CLIENT_HOST	VARCHAR(255)
SYSIBM.CLIENT_IPADDR	VARCHAR(128)
SYSIBM.CLIENT_PORT	INTEGER
SYSIBM.PACKAGE_NAME	VARCHAR(128)
SYSIBM.PACKAGE_SCHEMA	VARCHAR(128)
SYSIBM.PACKAGE_VERSION	VARCHAR(64)
SYSIBM.ROUTINE_SCHEMA	VARCHAR(128)

Built-in global variable	Data type for the column
SYSIBM.ROUTINE_SPECIFIC_NAME	VARCHAR(128)
SYSIBM.ROUTINE_TYPE	CHAR(1)

The column cannot have a DEFAULT clause or a field procedure.

NOT NULL

Prevents the column from containing null values. Omission of NOT NULL implies that the column can be null. NOT NULL is required for a row change timestamp column, a row-begin column, and a row-end column.

NOT HIDDEN

Indicates the column is included in implicit references to the table in SQL statements. This is the default.

IMPLICITLY HIDDEN

Indicates the column is not visible in SQL statements unless it is referred to explicitly by name. For example, SELECT * does not include any hidden columns in the result. A table must contain at least one column that is not IMPLICITLY HIDDEN.

period-definition

PERIOD FOR

Defines a period for the table.

SYSTEM_TIME (*begin-column-name, end-column-name*)

Defines a system period with the name SYSTEM_TIME. There must not be a column in the table with the name SYSTEM_TIME. A table can have only one SYSTEM_TIME period.

begin-column-name

Identifies the column that records the beginning of the period of time in which a row is valid. The name must identify a column that exists in the table. *begin-column-name* must not be the same as *end-column-name*. *begin-column-name* must be defined as AS ROW BEGIN.

end-column-name

Identifies the column that records the end of the period of time in which a row is valid. In the history table that is associated with a system-period temporal table, the history table column that corresponds to *end-column-name* in the system-period temporal table is set to reflect the deletion of the row. The name must identify a column that exists in the table. *end-column-name* must be defined as AS ROW END.

column-constraint

CONSTRAINT *constraint-name*

Names the constraint. A *constraint-name* must not identify a constraint that was previously specified in the CREATE TABLE statement and must not identify a constraint that already exists at the current server.

If the clause is not specified, a unique constraint name is generated by the database manager.

PRIMARY KEY

Provides a shorthand method of defining a primary key composed of a single column. Thus, if PRIMARY KEY is specified in the definition of column C, the effect is the same as if the PRIMARY KEY(C) clause is specified as a separate clause.

This clause must not be specified in more than one column definition and must not be specified at all if the UNIQUE clause is specified in the column definition. The column must not be a LOB, DATALINK, or XML column. If a sort sequence is specified, the column must not contain a field procedure.

When a primary key is added, a CHECK constraint is implicitly added to enforce the rule that the NULL value is not allowed in the column that makes up the primary key.

UNIQUE

Provides a shorthand method of defining a unique constraint composed of a single column. Thus, if UNIQUE is specified in the definition of column C, the effect is the same as if the UNIQUE (C) clause is specified as a separate clause.

This clause cannot be specified more than once in a column definition and must not be specified if PRIMARY KEY is specified in the column definition. The column must not be a LOB, DATALINK, or XML column. If a sort sequence is specified, the column must not contain a field procedure.

references-clause

The *references-clause* of a *column-definition* provides a shorthand method of defining a foreign key composed of a single column. Thus, if a references-clause is specified in the definition of column C, the effect is the same as if that references-clause were specified as part of a FOREIGN KEY clause in which C is the only identified column. The *references-clause* is not allowed if the table is a declared global temporary table, a distributed table, or a history table. The column cannot be a row change timestamp column.

CHECK(*check-condition*)

The CHECK(*check-condition*) of a *column-definition* provides a shorthand method of defining a check constraint whose *check-condition* only references a single column. Thus, if CHECK is specified in the column definition of column C, no columns other than C can be referenced in the *check-condition* of the check constraint. The effect is the same as if the check constraint were specified as a separate clause.

If ON INSERT VIOLATION or ON UPDATE VIOLATION is specified, column C must be referenced in these clauses.

ROWID, XML, and DATALINK with FILE LINK CONTROL columns cannot be referenced in a CHECK constraint. For additional restrictions, see [“check-constraint” on page 1141](#).

FIELDPROC

Designates an *external-program-name* as the field procedure exit routine for the column. It must be an ILE program that does not contain SQL. It cannot be a service program.

The field procedure encodes and decodes column values. Before a value is inserted in the column, it is passed to the field procedure for encoding. Before a value from the column is used, it is passed to the field procedure for decoding.

The field procedure is also invoked during the processing of the CREATE TABLE statement. When so invoked, the procedure provides Db2 with the column's field description. The field description defines the data characteristics of the encoded values. By contrast, the information supplied for the column in the CREATE TABLE statement defines the data characteristics of the decoded values.

constant

Specifies a parameter that is passed to the field procedure when it is invoked. A parameter list is optional.

A field procedure cannot be defined for a column that is a ROWID or DATALINK or a distinct type based on a ROWID or DATALINK. The column must not be an identity column, a row change timestamp column, a row-begin column, a row-end column, a transaction-start-ID column, or a generated expression column. The column must not have a default value of CURRENT DATE, CURRENT TIME, CURRENT TIMESTAMP, or USER. The nullability attribute of the encoded and decoded form of the field must match. The column cannot be referenced in a check condition, unless it is referenced in a NULL predicate. If it is part of a foreign key, the corresponding parent key column must use the same field procedure. See [SQL Programming](#) for more details on how to create a field procedure.

datalink-options

Specifies the options associated with a DATALINK data type.

LINKTYPE URL

Defines the type of link as a Uniform Resource Locator (URL).

NO LINK CONTROL

Specifies that there will not be any check made to determine that the linked files exist. Only the syntax of the URL will be checked. There is no database manager control over the linked files.

FILE LINK CONTROL

Specifies that a check should be made for the existence of the linked files. Additional options may be used to give the database manager further control over the linked files.

If FILE LINK CONTROL is specified, each file can only be linked once. That is, its URL can only be specified in a single FILE LINK CONTROL column in a single table.

file-link-options

Additional options to define the level of database manager control of the linked files.

INTEGRITY

Specifies the level of integrity of the link between a DATALINK value and the actual file.

ALL

Any file specified as a DATALINK value is under the control of the database manager and may NOT be deleted or renamed using standard file system programming interfaces.

READ PERMISSION

Specifies how permission to read the file specified in a DATALINK value is determined.

FS

The read access permission is determined by the file system permissions. Such files can be accessed without retrieving the file name from the column.

DB

The read access permission is determined by the database. Access to the file will only be allowed by passing a valid file access token, returned on retrieval of the DATALINK value from the table, in the open operation. If READ PERMISSION DB is specified, WRITE PERMISSION BLOCKED must be specified.

WRITE PERMISSION

Specifies how permission to write to the file specified in a DATALINK value is determined.

FS

The write access permission is determined by the file system permissions. Such files can be accessed without retrieving the file name from the column.

BLOCKED

Write access is blocked. The file cannot be directly updated through any interface. An alternative mechanism must be used to perform updates to the information. For example, the file is copied, the copy updated, and then the DATALINK value updated to point to the new copy of the file.

RECOVERY

Specifies whether the database manager will support point in time recovery of files referenced by values in this column.

NO

Specifies that point in time recovery will not be supported.

ON UNLINK

Specifies the action taken on a file when a DATALINK value is changed or deleted (unlinked). Note that this is not applicable when WRITE PERMISSION FS is used.

RESTORE

Specifies that when a file is unlinked, the DataLink File Manager will attempt to return the file to the owner with the permissions that existed at the time the file was linked. In the case where the user is no longer registered with the file server, the result depends on the file system that contains the files. If the files are in the AIX® file system, the owner is "dfmunknown". If the files are in IFS, the owner is QDLFM. This can only be specified when INTEGRITY ALL and WRITE PERMISSION BLOCKED are also specified.

DELETE

Specifies that the file will be deleted when it is unlinked. This can only be specified when READ PERMISSION DB and WRITE PERMISSION BLOCKED are also specified.

MODE DB2OPTIONS

This mode defines a set of default file link options. The defaults defined by DB2OPTIONS are:

- INTEGRITY ALL
- READ PERMISSION FS
- WRITE PERMISSION FS
- RECOVERY NO

LIKE

table-name* or *view-name

Specifies that the columns of the table have exactly the same name and description as the columns of the identified table (*table-name*) or view (*view-name*). The name must identify a table or view that exists at the current server.

The use of LIKE is an implicit definition of *n* columns, where *n* is the number of columns in the identified table or view. The implicit definition includes the following attributes of the *n* columns (if applicable to the data type):

- Column name (and system column name)
- Data type, length, precision, and scale
- CCSID
- FIELDPROC (only copied for *table-name*)

If the LIKE clause is specified immediately following the *table-name* and not enclosed in parenthesis, the following column attributes are also included, otherwise they are not included (the default value, identity, row change timestamp, and hidden attributes can also be controlled by using the *copy-options*):

- Default value, if a *table-name* is specified (*view-name* is not specified)
- Nullability
- Hidden attributes
- Column heading and text (see [“LABEL” on page 1399](#))

Any REFFLD information for the column will be copied to the new column definition.

If *table-name* contains a row change timestamp column, row-begin column, row-end column, transaction-start-ID column, or a generated expression column, the corresponding column of the new table inherits only the data type of the source column. The new column is not considered a generated column.

The implicit definition does not include any other optional attributes of the identified table or view. For example, the new table does not automatically include primary keys, foreign keys, triggers, or a period. The new table has these and other optional attributes only if the optional clauses are explicitly specified.

If the specified table or view is a non-SQL created physical file or logical file, any non-SQL attributes are removed. For example, the date and time format will be changed to ISO.

copy-options

INCLUDING IDENTITY COLUMN ATTRIBUTES or EXCLUDING IDENTITY COLUMN ATTRIBUTES

Specifies whether identity column attributes are inherited.

INCLUDING IDENTITY COLUMN ATTRIBUTES

Specifies that the table inherits the identity attribute, if any, of the columns resulting from *select-statement*, *table-name*, or *view-name*. In general, the identity attribute is copied if the element of the corresponding column in the table, view, or *select-statement* is the name of a table column or the name of a view column that directly or indirectly maps to the name of a base table column with the identity attribute. If the INCLUDING IDENTITY COLUMN ATTRIBUTES clause is specified with the AS *select-statement* clause, the columns of the new table do not inherit the identity attribute in the following cases:

- The select list of the *select-statement* includes multiple instances of an identity column name (that is, selecting the same column more than once).
- The select list of the *select-statement* includes multiple identity columns (that is, a join returned more than one identity column).

- The identity column is included in an expression in the select list.
- The *select-statement* includes a set operation (UNION or INTERSECT).

If INCLUDING IDENTITY is not specified, the table will not have an identity column.

EXCLUDING IDENTITY COLUMN ATTRIBUTES

Specifies that the table does not inherit the identity attribute, if any, of the columns resulting from the *fullselect*, *table-name*, or *view-name*.

EXCLUDING COLUMN DEFAULTS or INCLUDING COLUMN DEFAULTS or USING TYPE DEFAULTS

Specifies whether column defaults are inherited.

EXCLUDING COLUMN DEFAULTS

Specifies that the column defaults are not inherited from the definition of the source table. The default values of the column of the new table are either null or there are no default values. If the column can be null, the default is the null value. If the column cannot be null, there is no default value, and an error occurs if a value is not provided for a column on INSERT for the new table.

INCLUDING COLUMN DEFAULTS

Specifies that the table inherits the default values of the columns resulting from the *select-statement*, *table-name*, or *view-name*. In general, the default values are copied if the element of the corresponding column in the table, view, or *select-statement* is the name of a table column or the name of a view column that directly or indirectly maps to the name of a base table column with a default value. A default value is the value assigned to a column when a value is not specified on an INSERT.

Do not specify INCLUDING COLUMN DEFAULTS, if you specify USING TYPE DEFAULTS.

If INCLUDING COLUMN DEFAULTS is not specified, the default values are not inherited.

USING TYPE DEFAULTS

Specifies that the default values for the table depend on the data type of the columns that result from the *select-statement*, *table-name*, or *view-name*. If the column is nullable, then the default value is the null value. Otherwise, the default value is as follows:

Data type	Default value
Numeric	0
Fixed-length character or graphic string	Blanks
Fixed-length binary string	Hexadecimal zeros
Varying-length string	A string length of 0
Date	The current date at the time of INSERT
Time	The current time at the time of INSERT
Timestamp	The current timestamp at the time of INSERT
Datalink	A value corresponding to DLVALUE('','URL;')
XML	There is no default value
<i>distinct-type</i>	The default value of the corresponding source type of the distinct type.

Do not specify USING TYPE DEFAULTS if INCLUDING COLUMN DEFAULTS is specified.

INCLUDING IMPLICITLY HIDDEN COLUMN ATTRIBUTES or EXCLUDING IMPLICITLY HIDDEN COLUMN ATTRIBUTES

Specifies whether implicitly hidden columns are inherited.

INCLUDING IMPLICITLY HIDDEN COLUMN ATTRIBUTES

Specifies that the table inherits implicitly hidden columns from *select-statement*, *table-name*, or *view-name* and those columns will be defined with the implicitly hidden attribute in the new table.

If INCLUDING IMPLICITLY HIDDEN COLUMN ATTRIBUTES is not specified, the table will not have any implicitly hidden columns.

EXCLUDING IMPLICITLY HIDDEN COLUMN ATTRIBUTES

Specifies that the table does not inherit implicitly hidden columns from the *fullselect*, *table-name*, or *view-name*.

INCLUDING ROW CHANGE TIMESTAMP COLUMN ATTRIBUTES or EXCLUDING ROW CHANGE TIMESTAMP COLUMN ATTRIBUTES

Specifies whether the row change timestamp attribute is inherited.

INCLUDING ROW CHANGE TIMESTAMP COLUMN ATTRIBUTES

Specifies that the table inherits the row change timestamp attribute, if any, of the columns resulting from *select-statement*, *table-name*, or *view-name*. In general, the row change timestamp attribute is copied if the element of the corresponding column in the table, view, or *select-statement* is the name of a table column or the name of a view column that directly or indirectly maps to the name of a base table column with the row change timestamp attribute. If the INCLUDING ROW CHANGE TIMESTAMP COLUMN ATTRIBUTES clause is specified with the AS *select-statement* clause, the columns of the new table do not inherit the row change timestamp in the following cases:

- The select list of the *select-statement* includes multiple instances of a row change timestamp column name (that is, selecting the same column more than once).
- The select list of the *select-statement* includes multiple row change timestamp columns (that is, a join returned more than one row change timestamp column).
- The row change timestamp column is included in an expression in the select list.
- The *select-statement* includes a set operation (UNION or INTERSECT).

If INCLUDING ROW CHANGE TIMESTAMP COLUMN ATTRIBUTES is not specified, the table will not have a row change timestamp column.

EXCLUDING ROW CHANGE TIMESTAMP COLUMN ATTRIBUTES

Specifies that the table does not inherit the row change timestamp attribute, if any, of the columns resulting from the *fullselect*, *table-name*, or *view-name*.

as-result-table

column-name

Names a column in the table. If a list of column names is specified, it must consist of as many names as there are columns in the result table of the *select-statement*. Each *column-name* must be unique and unqualified. If a list of column names is not specified, the columns of the table inherit the names of the columns of the result table of the *select-statement*.

A list of column names must be specified if the result table of the *select-statement* has duplicate column names or an unnamed column. An unnamed column is a column derived from a constant, function, expression, or set operation (UNION or INTERSECT) that is not named using the AS clause of the select list.

FOR COLUMN system-column-name

Provides an IBM i name for the column. Do not use the same name for more than one column of the table or for a column-name of the table.

If the *system-column-name* is not specified, and the *column-name* is not a valid *system-column-name*, a system column name is generated. For more information about how system column names are generated, see [“Rules for Table Name Generation”](#) on page 1157.

select-statement

Specifies that the columns of the table have the same name and description as the columns that would appear in the derived result table of the *select-statement* if the *select-statement* were to be executed. The use of AS (*select-statement*) is an implicit definition of *n* columns for the table, where *n* is the number of columns that would result from the *select-statement*.

The implicit definition includes the following attributes of the *n* columns (if applicable to the data type):

- Column name (and system column name)
- Data type, length, precision, and scale
- CCSID
- Nullability
- FIELDPROC
- Column heading and text (see [“LABEL”](#) on page 1399)

The following attributes are not included (some attributes can be included by using the *copy-options*):

- Default value
- Hidden attribute
- Identity attributes
- Row change timestamp attribute
- Row-begin, row-end, and transaction-start-ID
- Generated expression

The implicit definition does not include any other optional attributes of the identified table or view. For example, the new table does not automatically include a primary key or foreign key from a table. The new table has these and other optional attributes only if the optional clauses are explicitly specified.

Any column in the *select-clause* that is either a direct reference to a column in another table or view or uses only a CAST to change the result attributes will have REFFLD information generated for the definition in the file object.

The *select-statement* must not reference variables, but may reference global variables.

The *select-statement* must not contain a PREVIOUS VALUE or a NEXT VALUE expression. The UPDATE, SKIP LOCKED DATA, and USE AND KEEP EXCLUSIVE LOCKS clauses may not be specified.

If the *select-statement* contains an *isolation-clause* the isolation level specified in the *isolation-clause* applies to the entire SQL statement.

WITH DATA

Specifies that the *select-statement* is executed. After the table is created, the result table rows of the *select-statement* are automatically inserted into the table.

WITH NO DATA

Specifies that the *select-statement* is used only to define the attributes of the new table. The table is not populated using the results of the *select-statement*.

unique-constraint

CONSTRAINT *constraint-name*

Names the constraint. A *constraint-name* must not identify a constraint that was previously specified in the CREATE TABLE statement and must not identify a constraint that already exists at the current server.

If the clause is not specified, a unique constraint name is generated by the database manager.

PRIMARY KEY(*column-name*,...)

Defines a primary key composed of the identified columns. A table can only have one primary key. Thus, this clause cannot be specified more than once and cannot be specified at all if the shorthand form has been used to define a primary key for the table. The identified columns cannot be the same as the columns specified in another UNIQUE constraint specified earlier in the CREATE TABLE statement. For example, PRIMARY KEY(A,B) would not be allowed if UNIQUE (B,A) had already been specified.

Each *column-name* must be an unqualified name that identifies a column of the table. The same column must not be identified more than once. The column must not be a LOB, DATALINK, or XML column. If a sort sequence is specified, the column must not contain a field procedure. The number of identified columns must not exceed 120, and the sum of their byte counts must not exceed 32766-*n*, where *n* is the number of columns specified that allow nulls. For information about byte-counts see [Table 85 on page 1154](#).

The unique index is created as part of the system physical file, not a separate system logical file. When a primary key is added, a CHECK constraint is implicitly added to enforce the rule that the NULL value is not allowed in any of the columns that make up the primary key.

UNIQUE (*column-name*,...)

Defines a unique constraint composed of the identified columns. The UNIQUE clause can be specified more than once. The identified columns cannot be the same as the columns specified in another UNIQUE constraint or PRIMARY KEY that was specified earlier in the CREATE TABLE statement. For determining if a unique constraint is the same as another constraint specification, the column lists are compared. For example, UNIQUE (A,B) is the same as UNIQUE (B,A).

Each *column-name* must be an unqualified name that identifies a column of the table. The same column must not be identified more than once. The column must not be a LOB, DATALINK, or XML column. If a sort sequence is specified, the column must not contain a field procedure. The number of identified columns must not exceed 120, and the sum of their byte counts must not exceed 32766-*n*, where *n* is the number of columns specified that allows nulls. For information about byte-counts see [Table 85 on page 1154](#).

A unique index on the identified column is created during the execution of the CREATE TABLE statement. The unique index is created as part of the system physical file, not as a separate system logical file.

referential-constraint

CONSTRAINT *constraint-name*

Names the constraint. A *constraint-name* must not identify a constraint that was previously specified in the CREATE TABLE statement and must not identify a constraint that already exists at the current server.

If the clause is not specified, a unique constraint name is generated by the database manager.

FOREIGN KEY

Each specification of the FOREIGN KEY clause defines a referential constraint. FOREIGN KEY is not allowed if the table is a declared global temporary table or a distributed table.

(*column-name*,...)

The foreign key of the referential constraint is composed of the identified columns. Each *column-name* must be an unqualified name that identifies a column of the table. The same column must

not be identified more than once. The column must not be a LOB, DATALINK, or XML column and must not be a row change timestamp column. If a sort sequence is specified, the column must not contain a field procedure. The number of identified columns must not exceed 120, and the sum of their lengths must not exceed $32766-n$, where n is the number of columns specified that allow nulls.

REFERENCES *table-name*

The *table-name* specified in a REFERENCES clause must identify the table being created or a base table that already exists at the application server, but it must not identify a catalog table, a declared temporary table, a distributed table, or a history table. If the parent is a partitioned table, the unique index that enforces the parent unique constraint must be non-partitioned.

A referential constraint is a *duplicate* if its foreign key, parent key, and parent table are the same as the foreign key, parent key, and parent table of a previously specified referential constraint. Duplicate referential constraints are allowed, but not recommended.

Let T2 denote the identified parent table and let T1 denote the table being created.

The specified foreign key must have the same number of columns as the parent key of T2. The description of the n th column of the foreign key and the description of the n th column of that parent key must have identical data types, lengths, CCSIDs, and FIELDPROCs.

(*column-name*,...)

The parent key of the referential constraint is composed of the identified columns. Each *column-name* must be an unqualified name that identifies a column of T2. The same column must not be identified more than once. The column must not be a LOB, DATALINK, or XML column and must not be a row change timestamp column. If a sort sequence is specified, the column must not contain a field procedure. The number of identified columns must not exceed 120, and the sum of their byte counts must not exceed $32766-n$, where n is the number of columns specified that allow nulls. For information about byte-counts see [Table 85 on page 1154](#).

The list of column names must be identical to the list of column names in the primary key of T2 or a UNIQUE constraint that exists on T2. The names need not be specified in the same order as in the primary key; however, they must be specified in corresponding order to the list of columns in the *foreign key* clause. If a column name list is not specified, then T2 must have a primary key. Omission of the column name list is an implicit specification of the columns of that primary key.

The referential constraint specified by a FOREIGN KEY clause defines a relationship in which T2 is the parent and T1 is the dependent.

ON DELETE

Specifies what action is to take place on the dependent tables when a row of the parent table is deleted. There are five possible actions:

- NO ACTION (default)
- RESTRICT
- CASCADE
- SET NULL
- SET DEFAULT

SET NULL must not be specified unless some column of the foreign key allows null values.

CASCADE must not be specified if T1 contains a DataLink column with FILE LINK CONTROL.

The delete rule applies when a row of T2 is the object of a DELETE or propagated delete operation and that row has dependents in T1. Let p denote such a row of T2.

- If RESTRICT or NO ACTION is specified, an error occurs and no rows are deleted.
- If CASCADE is specified, the delete operation is propagated to the dependents of p in T1.

- If SET NULL is specified, each nullable column of the foreign key of each dependent of *p* in T1 is set to null. SET NULL is not allowed if the dependent table is a partitioned table and a foreign key column is also a partitioning key.
- If SET DEFAULT is specified, each column of the foreign key of each dependent of *p* in T1 is set to its default value. SET DEFAULT is not allowed if the dependent table is a partitioned table and a foreign key column is also a partitioning key unless the default keeps the row in the same partition.

ON UPDATE

Specifies what action is to take place on the dependent tables when a row of the parent table is updated.

The update rule applies when a row of T2 is the object of an UPDATE or propagated update operation and that row has dependents in T1. Let *p* denote such a row of T2.

- If RESTRICT or NO ACTION is specified, an error occurs and no rows are updated.

check-constraint

CONSTRAINT *constraint-name*

Names the check constraint. A *constraint-name* must not identify a constraint that was previously specified in the CREATE TABLE statement and must not identify a constraint that already exists at the current server.

If the clause is not specified, a unique constraint name is generated by the database manager.

CHECK (*check-condition*)

Defines a check constraint. At any time, the *check-condition* must be true or unknown for every row of the table.

The *check-condition* is a *search-condition* except:

- It can only refer to columns of the table
- The result of any expression in the *check-condition* cannot be a ROWID, XML, or DATALINK with FILE LINK CONTROL data type.
- It must not contain any of the following:
 - Subqueries
 - Aggregate functions
 - Variables
 - Global variables
 - Parameter markers
 - *Sequence-references*
 - Complex expressions that contain LOBs (such as concatenation)
 - OLAP specifications
 - ROW CHANGE expressions
 - IS JSON, JSON_EXISTS, or REGEXP_LIKE predicates
 - Special registers
 - User-defined functions other than functions that were implicitly generated with the creation of a strongly typed distinct type
 - The following built-in scalar functions:

ATAN2	DLURLSCHEME	JSON_QUERY	REPLACE
BSON_TO_JSON	DLURLSERVER	JSON_TO_BSON	ROUND_TIMESTAMP
CARDINALITY	DLVALUE	JSON_VALUE	RPAD
CONTAINS	ENCRYPT_AES	LOCATE_IN_STRING	SCORE

CURDATE	ENCRYPT_RC2	LPAD	SOUNDEX
CURTIME	ENCRYPT_TDES	MAX_CARDINALITY	TABLE_NAME
DATAPARTITIONNAME	GENERATE_UNIQUE	MONTHNAME	TABLE_SCHEMA
DATAPARTITIONNUM	GETHINT	MONTHS_BETWEEN	TIMESTAMP_FORMAT
DAYNAME	HASH	NEXT_DAY	TIMESTAMPDIFF
DBPARTITIONNAME	HASH_MD5	NOW	TRUNC_TIMESTAMP
DECRYPT_BINARY	HASH_SHA1	OVERLAY	VARCHAR_FORMAT
DECRYPT_BIT	HASH_SHA256	RAISE_ERROR	VERIFY_GROUP_FOR_USER
DECRYPT_CHAR	HASH_SHA512	RAND	WEEK_ISO
DECRYPT_DB	IDENTITY_VAL_LOCAL	REGEXP_COUNT	WRAP
DIFFERENCE	INSERT	REGEXP_INSTR	XMLPARSE
DLURLCOMPLETE ¹	INTERPRET	REGEXP_REPLACE	XMLVALIDATE
DLURLPATH	JSON_ARRAY	REGEXP_SUBSTR	XSLTRANSFORM
DLURLPATHONLY	JSON_OBJECT	REPEAT	

¹ For DataLinks with an attribute of FILE LINK CONTROL and READ PERMISSION DB.

ON INSERT VIOLATION

Specifies the action to take if the *check-condition* is false for a row being inserted. If this clause is not specified, an error will occur if the *check-condition* is false for an insert.

SET *column-name* = DEFAULT

The default value for *column-name* is inserted into the table instead of the value provided by the insert operation.

column-name must be referenced in the *check-condition*.

ON UPDATE VIOLATION

Specifies the action to take if the *check-condition* is false for a row being updated. If this clause is not specified, an error will occur if the *check-condition* is false for an update.

PRESERVE *column-name*

The current value for *column-name* remains in the table rather than being replaced by the value provided by the update operation.

column-name must be referenced in the *check-condition*.

For more information about search-condition, see “Search conditions” on page 228. For more information about check constraints involving LOB data types and expressions, see the [Database Programming](#) topic collection.

NOT LOGGED INITIALLY

Any changes made to the table by INSERT, DELETE, or UPDATE statements in the same unit of work after the table is created by this statement are not logged (journalled).

At the completion of the current unit of work, the NOT LOGGED INITIALLY attribute is deactivated and all operations that are done on the table in subsequent units of work are logged (journalled).

The NOT LOGGED INITIALLY option is useful for situations where a large result set needs to be created with data from an alternate source (another table or a file) and recovery of the table is not necessary. Using this option will save the overhead of logging (journaling) the data.

ACTIVATE NOT LOGGED INITIALLY is ignored if the table has a DATALINK column with FILE LINK CONTROL.

VOLATILE or NOT VOLATILE

Indicates to the optimizer whether the cardinality of table *table-name* can vary significantly at run time. Volatility applies to the number of rows in the table, not to the table itself. The default is NOT VOLATILE.

VOLATILE

Specifies that the cardinality of *table-name* can vary significantly at run time, from empty to large. To access the table, the optimizer will typically use an index, if possible.

NOT VOLATILE

Specifies that the cardinality of *table-name* is not volatile. Access plans that reference this table will be based on the cardinality of the table at the time the access plan is built. NOT VOLATILE is the default.

RCDFMT

Indicates the record format name of the table.

RCDFMT *format-name*

An unqualified name that designates the IBM i record format name of the table. A *format-name* is a system identifier.

If a record format name is not specified, the *format-name* is the same as the *system-object-name* of the table.

media-preference

Specifies the preferred storage media for the table or partition.

UNIT ANY

No storage media is preferred. Storage for the table or partition will be allocated from any available storage media. If UNIT ANY is specified on the table, any *media-preference* that is specified on a partition is used.

UNIT SSD

Solid state disk storage media is preferred. Storage for the table or partition may be allocated from solid state disk storage media, if available. If UNIT SSD is specified on the table, any *media-preference* specified on a partition is ignored.

memory-preference

KEEP IN MEMORY

Specifies whether the data for the table should be brought into a main storage pool when the data is used in a query.

NO

The data will not be brought into a main storage pool.

YES

The data will be brought into a main storage pool.

ON REPLACE

Specifies the action to take when replacing a table that exists at the current server. This option is ignored if an existing table is not being replaced.

PRESERVE ALL ROWS

Current rows of the specified table will be preserved. PRESERVE ALL ROWS is not allowed if WITH DATA is specified with *result-table-as*.

All rows of all partitions in a partitioned table are preserved. If the new table definition is a range partitioned table, the defined ranges must be able to contain all the rows from the existing partitions.

If a column is dropped, the column values will not be preserved. If a column is altered, the column values may be modified.

If the table is not a partitioned table or is a hash partitioned table, PRESERVE ALL ROWS and PRESERVE ROWS are equivalent.

PRESERVE ROWS

Current rows of the specified table will be preserved. PRESERVE ROWS is not allowed if WITH DATA is specified with *result-table-as*.

If a partition of a range partitioned table is dropped, the rows of that partition will be deleted without processing any delete triggers. To determine if a partition of a range partitioned table is dropped, the range definitions and the partition names (if any) of the partitions in the new table definition are compared to the partitions in the existing table definition. If either the specified range or the name of a partition matches, it is preserved. If a partition does not have a *partition-name*, its *boundary-spec* must match an existing partition.

If a partition of a hash partition table is dropped, the rows of that partition will be preserved.

If a column is dropped, the column values will not be preserved. If a column is altered, the column values may be modified.

DELETE ROWS

Current rows of the specified table will be deleted. Any existing DELETE triggers are not fired.

DELETE ROWS is not allowed if the table is a system-period temporal table or a history table.

distribution-clause

IN NODEGROUP *nodegroup-name*

Specifies the nodegroup across which the data in the table will be distributed. The name must identify a nodegroup that exists at the current server. If this clause is specified, the table is created as a distributed table across all the systems in the nodegroup.

A LOB, DATALINK, XML, or IDENTITY column is not allowed in a distributed table.

The Db2 Multisystem product must be installed to create a distributed table. For more information about distributed tables, see the [Db2 Multisystem](#) topic collection.

DISTRIBUTE BY HASH (*column-name,...*)

Specifies the partitioning key. The partitioning key is used to determine on which node in the nodegroup a row will be placed. Each *column-name* must be an unqualified name that identifies a column of the table. The same column must not be identified more than once. If the DISTRIBUTE BY clause is not specified, the first column of the primary key is used as the partitioning key. If there is no primary key, the first column of the table that is not floating point, date, time, or timestamp is used as the partitioning key.

The columns that make up the partitioning key must be a subset of the columns that make up any unique constraints over the table. Floating point, date, time, timestamp, LOB, XML, DataLink, ROWID, and columns that have a field procedure cannot be used in a partitioning key.

partitioning-clause

PARTITION BY RANGE

Specifies that ranges of column values are used to determine the target data partition when inserting a row into the table. The number of partitions must not exceed 256.

partition-expression

Specifies the key data over which the range is defined to determine the target data partition of the data.

column-name

Identifies a column in the data partitioning key. The partitioning key is used to determine into which partition in the table a row will be placed. The *column-name* must be an unqualified name that identifies a column of the table. The same column must not be identified more than once.

LOB, XML, DataLink, ROWID, row change timestamp columns, identity columns, and any column with a field procedure cannot be used in a partitioning key.

The number of identified columns must not exceed 120. The sum of length attributes of the columns must not be greater than 2000.

NULLS LAST

Indicates that null values compare high.

NULLS FIRST

Indicates that null values compare low.

partition-element

Specifies ranges for a data partitioning key.

PARTITION *partition-name*

Names the data partition. The name must not be the same as any other data partition for the table.

If the clause is not specified, a unique partition name is generated by the database manager.

boundary-spec

Specifies the boundaries of a range partition. If more than one partition key is specified, the boundaries must be specified in ascending sequence. The ranges must not overlap.

starting-clause

Specifies the low end of the range for a data partition. The number of specified starting values must be the same as the number of columns in the partitioning key. If a *starting-clause* is not specified for the first *boundary-spec*, the default is MINVALUE INCLUSIVE for each column of the partitioning key. If a *starting-clause* is not specified for a subsequent *boundary-spec*, the previous adjacent *boundary-spec* must contain an *ending-clause*. The default is the same as that *ending-clause* except that the INCLUSIVE or EXCLUSIVE attribute is reversed.

STARTING FROM

Introduces the *starting-clause*.

constant

Specifies a constant that must conform to the rules of a constant for the data type of the corresponding column of the partition key. If the corresponding column of the partition key is a distinct type, the constant must conform to the rules of the source type of the distinct type. The value must not be in the range of any other *boundary-spec* for the table.

MINVALUE

Specifies a value that is lower than the lowest possible value for the data type of the *column-name* to which it corresponds. If MINVALUE is specified, all subsequent values in the *starting-clause* must also be MINVALUE.

MAXVALUE

Specifies a value that is greater than the greatest possible value for the data type of the *column-name* to which it corresponds. If MAXVALUE is specified, all subsequent values in the *ending-clause* must also be MAXVALUE.

INCLUSIVE

Indicates that the specified range values are included in the data partition.

EXCLUSIVE

Indicates that the specified range values are excluded from the data partition. This specification is ignored when MINVALUE or MAXVALUE is specified.

ending-clause

Specifies the high end of the range for a data partition. The number of specified ending values must be the same as the number of columns in the data partitioning key. An *ending-clause* must be specified for the last *boundary-spec*. If an *ending-clause* is not specified for a previous *boundary-spec*, the next adjacent *boundary-spec* must contain a *starting-clause*. The default is the same as that *starting-clause* except that the INCLUSIVE or EXCLUSIVE attribute is reversed.

ENDING AT

Introduces the *ending-clause*.

constant

Specifies a constant that must conform to the rules of a constant for the data type of the corresponding column of the partition key. If the corresponding column of the partition key is a distinct type, the constant must conform to the rules of the source type of the distinct type. The value must not be in the range of any other *boundary-spec* for the table.

MINVALUE

Specifies a value that is lower than the lowest possible value for the data type of the *column-name* to which it corresponds. If MINVALUE is specified, all subsequent values in the *starting-clause* must also be MINVALUE.

MAXVALUE

Specifies a value that is greater than the greatest possible value for the data type of the *column-name* to which it corresponds. If MAXVALUE is specified, all subsequent values in the *ending-clause* must also be MAXVALUE.

INCLUSIVE

Indicates that the specified range values are included in the data partition.

EXCLUSIVE

Indicates that the specified range values are excluded from the data partition. This specification is ignored when MINVALUE or MAXVALUE is specified.

EVERY *integer-constant*

Specifies that multiple data partitions will be added where *integer-constant* specifies the width of each data partition range. If EVERY is specified, only a single SMALLINT, INTEGER, BIGINT, DECIMAL, NUMERIC, DATE, or TIMESTAMP column can be specified for the partition key.

The starting value of the first data partition is the specified STARTING value. The starting value of each subsequent partition is the starting value of the previous partition + *integer-constant*. If the *starting-clause* specified EXCLUSIVE, the starting value of every partition is EXCLUSIVE. Otherwise, the starting value of every partition is INCLUSIVE.

The ending value of every partition of the range is (the partition's start value + *integer-constant*). If the *ending-clause* specified EXCLUSIVE, the ending value of the last partition is EXCLUSIVE. Otherwise, the ending value of the last partition is INCLUSIVE. The ending values of the other partitions is EXCLUSIVE if the starting value is INCLUSIVE. Otherwise, the ending values of the other partitions is INCLUSIVE.

The number of partitions added is determined by adding *integer-constant* repeatedly to the STARTING value until the ENDING value is reached. For example:

```
CREATE TABLE F00
(A INT)
PARTITION BY RANGE(A)
(STARTING(1) ENDING(10) EVERY(2))
```

is equivalent to the following CREATE TABLE statement:

```
CREATE TABLE F00
(A INT)
PARTITION BY RANGE(A)
(STARTING(1) ENDING(2),
STARTING(3) ENDING(4),
STARTING(5) ENDING(6),
STARTING(7) ENDING(8),
STARTING(9) ENDING(10))
```

In the case of dates and timestamps, the EVERY value must be a labeled duration. For example:

```
CREATE TABLE F00
(A DATE)
PARTITION BY RANGE(A)
(STARTING('2001-01-01') ENDING('2010-01-01') EVERY(3 MONTHS))
```

PARTITION BY HASH

Specifies that the hash function is used to determine the target data partition when inserting a row into the table.

(*column-name*,...)

Specifies the partitioning key. The partitioning key is used to determine into which partition in the table a row will be placed. Each *column-name* must be an unqualified name that identifies a column of the table. The same column must not be identified more than once.

Floating point, LOB, XML, date, time, timestamp, DataLink, ROWID, identity columns, and columns with a field procedure cannot be used in a partitioning key.

INTO *integer* PARTITIONS

Specifies the number of partitions. The number of partitions must not exceed 256.

materialized-query-definition

column-name

Names a column in the table. If a list of column names is specified, it must consist of as many names as there are columns in the result table of the *select-statement*. Each *column-name* must be unique and unqualified. If a list of column names is not specified, the columns of the table inherit the names of the columns of the result table of the *select-statement*.

A list of column names must be specified if the result table of the *select-statement* has duplicate column names or an unnamed column. An unnamed column is a column derived from a constant, function, expression, or set operation (UNION or INTERSECT) that is not named using the AS clause of the select list.

FOR COLUMN system-column-name

Provides an IBM i name for the column. Do not use the same name for more than one column of the table or for a column-name of the table.

If the *system-column-name* is not specified, and the *column-name* is not a valid *system-column-name*, a system column name is generated. For more information about how system column names are generated, see [“Rules for Table Name Generation” on page 1157](#).

select-statement

Specifies that the columns of the table have the same name and description as the columns that would appear in the derived result table of the *select-statement* if the *select-statement* were to be executed. The use of AS (*select-statement*) is an implicit definition of *n* columns for the table, where *n* is the number of columns that would result from the *select-statement*.

The implicit definition includes the following attributes of the *n* columns (if applicable to the data type):

- Column name (and system column name)
- Data type, length, precision, and scale
- CCSID
- Nullability
- FIELDPROC
- Column heading and text (see [“LABEL” on page 1399](#))

The following attributes are not included:

- Default value
- Hidden attribute
- Identity attributes
- Row change timestamp attribute
- Row-begin, row-end, and transaction-start-ID
- Generated expression

The implicit definition does not include any other optional attributes of the identified table or view. For example, the new table does not automatically include a primary key or foreign key from a table. The new table has these and other optional attributes only if the optional clauses are explicitly specified.

The *select-statement* must not refer to variables or global variables, or include parameter markers. If an expression in the SELECT clause of the *select-statement* is not a column name, then the expression must not reference a column with a field procedure.

The *select-statement* must not contain a PREVIOUS VALUE or a NEXT VALUE expression. The UPDATE, SKIP LOCKED DATA, and USE AND KEEP EXCLUSIVE LOCKS clauses may not be specified.

refreshable-table-options

Specifies that the table is a *materialized query table* and the REFRESH TABLE statement can be used to populate the table with the results of the *select-statement*.

A materialized query table whose *select-statement* contains a GROUP BY clause is summarizing data from the tables referenced in the *select-statement*. Such a materialized query table is also known as a *summary table*. A summary table is a specialized type of materialized query table.

When a materialized query table is defined, the following *select-statement* restrictions apply:

- The *select-statement* cannot contain a reference to another materialized query table or to a view that refers to a materialized query table.
- The *select-statement* cannot contain a reference to a declared temporary table, a table in QTEMP, a program-described file, or a non-SQL logical file in the FROM clause.
- The *select-statement* cannot contain a *data-change-file-reference*.
- The *select-statement* cannot contain a reference to a view that references another materialized query table or a declared temporary table. When a materialized query table is defined with ENABLE QUERY OPTIMIZATION, the *select-statement* cannot contain a reference to a view that contains one of the restrictions from the following paragraph.
- The *select-statement* cannot contain an expression with a DataLink or a distinct type based on a DataLink where the DataLink is FILE LINK CONTROL.
- The *select-statement* cannot contain a result column that is not an SQL data type, such as binary with precision, DBCS-ONLY, or DBCS-EITHER.

When a materialized query table is defined with ENABLE QUERY OPTIMIZATION, the following additional *select-statement* restrictions apply:

- Must not include any special registers.
- Must not include any non-deterministic functions.
- The ORDER BY clause is allowed, but is only used by REFRESH. It may improve locality of reference of data in the materialized query table.
- If the subselect references a view, the *select-statement* in the view definition must satisfy the preceding restrictions.

DATA INITIALLY DEFERRED

Specifies that the data is not inserted into the materialized query table when it is created. Use the REFRESH TABLE statement to populate the materialized query table, or use the INSERT statement to insert data into a materialized query table.

DATA INITIALLY IMMEDIATE

Specifies that the data is inserted into the materialized query table when it is created.

REFRESH DEFERRED

Specifies that the data in the table can be refreshed at any time using the REFRESH TABLE statement. The data in the table only reflects the result of the query as a snapshot at the time when the REFRESH TABLE statement is processed or when it was last updated.

MAINTAINED BY USER

Specifies that the materialized query table is maintained by the user. The user can use INSERT, DELETE, UPDATE, or REFRESH TABLE statements on the table.

ENABLE QUERY OPTIMIZATION or DISABLE QUERY OPTIMIZATION

Specifies whether this materialized query table can be used for optimization. The default is ENABLE QUERY OPTIMIZATION.

ENABLE QUERY OPTIMIZATION

Specifies that the materialized query table can be used for query optimization. If the *select-statement* specified does not satisfy the restrictions for query optimization, an error is returned.

DISABLE QUERY OPTIMIZATION

Specifies that the materialized query table cannot be used for query optimization. The table can still be queried directly.

If row level or column level access control is activated for any table that is directly or indirectly referenced in the *select-statement*, row access control is implicitly activated for the table being created. This restricts direct access to the contents of the materialized query table. A query that explicitly references the table will return a warning that there is no data in the table. To provide access to the materialized query table, an appropriate row permission can be created or an ALTER TABLE DEACTIVATE ROW ACCESS CONTROL on the materialized query table can be issued to remove the row level protection if that is appropriate.

Notes

Table attributes: Tables are created as physical files. When a table is created, the file wait time and record wait time attributes are set to the default that is specified on the WAITFILE and WAITRCD keywords of the Create Physical File (CRTPF) command.

SQL tables are created so that space used by deleted rows will be reclaimed by future insert requests. This attribute can be changed via the command *CHGPF* and specifying the *REUSEDLT(*NO)* parameter. For more information about the *CHGPF* command, see [CL Reference](#).

A distributed table is created on all of the servers across which the table is distributed. For more information about distributed tables, see [Db2 Multisystem](#).

Table journaling: When a table is created, journaling may be automatically started.

- If the table is created into a schema that has specified (using the STRJRNLIB command) that journaling should implicitly be started.
- If the schema has not specified that journaling should be started, journaling will be started to a journal called QSQJRN if it exists in the same schema that the table is created into.

Table ownership: If SQL names were specified:

- If a user profile with the same name as the schema into which the table is created exists, the *owner* of the table is that user profile.
- Otherwise, the *owner* of the table is the user profile or group user profile of the thread executing the statement.

If system names were specified, the *owner* of the table is the user profile or group user profile of the thread executing the statement.

Table authority: If SQL names are used, tables are created with the system authority of *EXCLUDE to *PUBLIC. If system names are used, tables are created with the authority to *PUBLIC as determined by the create authority (CRTAUT) parameter of the schema.

If the owner of the table is a member of a group profile (GRPPRF keyword) and group authority is specified (GRPAUT keyword), that group profile will also have authority to the table.

REPLACE rules: When a table is recreated by REPLACE using PRESERVE ROWS, the new definition of the table is compared to the old definition and logically, for each difference between the two, a corresponding ALTER operation is performed. When the DELETE ROWS option is used, the table is logically dropped and recreated; as long as objects dependent on the table remain valid, any modification is allowed. For more information see [Table 80 on page 902 in ALTER TABLE](#). For columns, constraints, and partitions, the comparisons are performed based on their names and attributes.

Column names and system column names can be changed by modifying either the column name or the system column name, leaving the other name unchanged. If neither name matches an existing column, a new column is created. The existence of another object dependent on a column name may prevent the name change.

New definition vs existing definition	Equivalent ALTER TABLE action
Column	

New definition vs existing definition	Equivalent ALTER TABLE action
Column exists in both and the attributes are the same	No change
Column exists in both and the attributes are different	ALTER COLUMN
Column exists only in new table definition	ADD COLUMN
Column exists only in existing table definition	DROP COLUMN RESTRICT
Constraint	
Constraint exists in both and is the same	No change
Constraint exists in both and is different	DROP <i>constraint</i> RESTRICT and ADD <i>constraint</i>
Constraint exists only in new table definition	ADD <i>constraint</i>
Constraint exists only in existing table definition	DROP <i>constraint</i> RESTRICT
<i>materialized-query-definition</i>	
<i>materialized-query-definition</i> exists in both and is the same	No change
<i>materialized-query-definition</i> exists in both and is different	ALTER MATERIALIZED QUERY
<i>materialized-query-definition</i> exists only in new table definition	ADD MATERIALIZED QUERY
<i>materialized-query-definition</i> exists only in existing table definition	DROP MATERIALIZED QUERY
<i>partitioning-clause</i>	
<i>partitioning-clause</i> exists in both and is the same	No change
<i>partitioning-clause</i> exists in both and is different	ADD PARTITION, DROP PARTITION, and ALTER PARTITION
<i>partitioning-clause</i> exists only in new table definition	ADD <i>partitioning-clause</i>
<i>partitioning-clause</i> exists only in existing table definition	DROP PARTITIONING
PERIOD	
PERIOD exists in both and is the same	No change
PERIOD exists only in new table definition	ALTER ADD PERIOD
PERIOD exists only in existing table definition	ALTER DROP PERIOD A period cannot be dropped if the table is a system-period temporal table
NOT LOGGED INITIALLY	
NOT LOGGED INITIALLY exists in both	No change
NOT LOGGED INITIALLY exists only in new table definition	NOT LOGGED INITIALLY

New definition vs existing definition	Equivalent ALTER TABLE action
NOT LOGGED INITIALLY exists only in existing table definition	Logged initially
<i>VOLATILE</i>	
VOLATILE attribute exists in both and is the same	No change
VOLATILE attribute exists only in new table definition	VOLATILE
VOLATILE attribute exists only in existing table definition	NOT VOLATILE
<i>media-preference</i>	
<i>media-preference</i> exists in both and is the same	No change
<i>media-preference</i> exists only in new table definition	ALTER <i>media-preference</i>
<i>media-preference</i> exists only in existing table definition	UNIT ANY
<i>memory-preference</i>	
<i>memory-preference</i> exists in both and is the same	No change
<i>memory-preference</i> exists only in new table definition	ALTER <i>memory-preference</i>
<i>memory-preference</i> exists only in existing table definition	KEEP IN MEMORY NO

Any attributes that cannot be specified in the CREATE TABLE statement are preserved:

- Authorized users are maintained. The object owner could change.
- Current journal auditing is preserved. However, unlike other objects, REPLACE of a table will generate a ZC (change object) journal audit entry.
- Current data journaling is preserved.
- Comments and labels and column headings are preserved unless the REPLACE uses the AS clause.
- Triggers are preserved, if possible. If it is not possible to preserve a trigger, an error is returned.
- Masks and permissions are preserved, if possible. If it is not possible to preserve a mask or permission, an error is returned.
- Temporal table VERSIONING and the history table are preserved.
- Any views, materialized query tables, and indexes dependent on the table will be preserved or recreated, if possible. If it is not possible to preserve a dependent view, materialized query table, or index, an error is returned.

Using an identity column: When a table has an identity column, the database manager can automatically generate sequential numeric values for the column as rows are inserted into the table. Thus, identity columns are ideal for primary keys.

Identity columns and ROWID columns are similar in that both types of columns contain values that the database manager generates. ROWID columns can be useful in direct-row access. ROWID columns contain values of the ROWID data type, which returns a 40-byte VARCHAR value that is not regularly ascending or descending. ROWID data values are therefore not well suited to many application uses, such as generating employee numbers or product numbers. For data that does not require direct-row access, identity columns are usually a better approach, because identity columns contain existing numeric data types and can be used in a wide variety of uses for which ROWID values would not be suitable.

When a table is recovered to a point-in-time (using RMVJRNCHG), it is possible that a large gap in the sequence of generated values for the identity column might result. For example, assume a table has an identity column that has an incremental value of 1 and that the last generated value at time T1 was 100 and the database manager subsequently generates values up to 1000. Now, assume that the table is recovered back to time T1. The generated value of the identity column for the next row that is inserted after the recovery completes will be 1001, leaving a gap from 100 to 1001 in the values of the identity column.

When CYCLE is specified duplicate values for a column may be generated even when the column is GENERATED ALWAYS, unless a unique constraint or unique index is defined on the column.

Creating materialized query tables: To ensure that the materialized query table has data before being used by a query:

- DATA INITIALLY IMMEDIATE should be used to create materialized query tables, or
- the materialized query table should be created with query optimization disabled and then enable the table for query optimization after it is refreshed.

The isolation level at the time when the CREATE TABLE statement is executed is the isolation level for the materialized query table. The *isolation-clause* can be used to explicitly specify the isolation level.

Considerations for implicitly hidden columns: A column that is defined as implicitly hidden is not part of the result table of a query that specifies * in a SELECT list. However, an implicitly hidden column can be explicitly referenced in a query. For example, an implicitly hidden column can be referenced in the SELECT list or in a predicate in a query. Additionally, an implicitly hidden column can be explicitly referenced in a COMMENT statement, CREATE INDEX statement, ALTER TABLE statement, INSERT statement, MERGE statement, or UPDATE statement. An implicitly hidden column can be referenced in a referential constraint. A REFERENCES clause that does not contain a column list refers implicitly to the primary key of the parent table. It is possible that the primary key of the parent table includes a column defined as implicitly hidden. Such a referential constraint is allowed.

If the SELECT list of the fullselect of a materialized query definition explicitly refers to an implicitly hidden column, that column will be part of the materialized query table.

If the SELECT list of the fullselect of a view definition (CREATE VIEW statement) explicitly refers to an implicitly hidden column, that column will be part of the view, however the view column is not considered 'hidden'.

Considerations for transaction-start-ID columns: A transaction-start-ID column contains a null value if the column allows null values and there is a row-begin column and the value of the row-begin column is unique from values for row-begin columns generated for other transactions. Given that the column may contain null values, it is recommended that one of the following methods be used when retrieving a value from the column:

```
COALESCE (transaction_start_id_col, row_begin_col)

CASE WHEN transaction_start_id_col IS NOT NULL
      THEN transaction_start_id_col
      ELSE row_begin_col END
```

Defining a system-period temporal table: A system-period temporal table definition includes the following:

- A system period named SYSTEM_TIME, which is defined using a row-begin column and a row-end column. See the descriptions of AS ROW BEGIN, AS ROW END, and period-definition.
- A transaction-start-ID column. See the description of AS TRANSACTION START ID.
- A system-period data versioning definition specified on a subsequent ALTER TABLE statement that specifies the ADD VERSIONING action, which includes the name of the associated history table. See [“ADD VERSIONING USE HISTORY TABLE history-table-name” on page 892.](#)

Partitioned table performance: The larger the number of partitions in a partitioned table, the greater the overhead in SQL data change and SQL data statements. You should create a partitioned table with the

minimum number of partitions that are required to minimize this overhead. It is also highly recommended that a parallelism degree greater than one be considered when accessing a partitioned table.

Creating a table using a remote select-statement: The *select-statement* for an *as-result-table* can refer to tables on a different server than where the table is being created. This can be done by using a three-part object name or an alias that is defined to reference a three-part name of a table or view. The *select-statement* cannot be for a materialized query table and the result cannot contain a column that has a field procedure defined. If the remote server is Db2 for LUW or Db2 for z/OS, *copy-options* are not allowed. If the remote server is Db2 for LUW, a column list should be explicitly specified before the AS keyword.

Syntax alternatives: The following keywords are synonyms supported for compatibility to prior releases. These keywords are non-standard and should not be used:

- INLINE LENGTH is a synonym for ALLOCATE.
- *constraint-name* (without the CONSTRAINT keyword) may be specified following the FOREIGN KEY keywords in a *referential-constraint*
- DEFINITION ONLY is a synonym for WITH NO DATA
- PARTITIONING KEY is a synonym for DISTRIBUTE BY HASH.
- PART is a synonym for PARTITION.
- PARTITION *partition-number* may be specified instead of PARTITION *partition-name*. A *partition-number* must not identify a partition that was previously specified in the CREATE TABLE statement.

If a *partition-number* is not specified, a unique partition number is generated by the database manager.

- VALUES is a synonym for ENDING AT.
- SUMMARY between CREATE and TABLE when creating a materialized query table.

Maximum row sizes

There are two maximum row size restrictions referred to in the description of *column-definition*.

- The maximum row buffer size is 32766 or, if a VARCHAR, VARGRAPHIC, VARBINARY, LOB, or XML column is specified, 32740.
- The maximum row data size is 3 758 096 383 if a LOB or XML column is specified; this size is determined when a row is inserted or updated. If a LOB or XML column is not specified, then the maximum row data size is 32766 or, if a VARCHAR, VARGRAPHIC, or VARBINARY column is specified, 32740.

To determine the length of a row buffer and row data or both, add the corresponding length of each column of that row based on the byte counts of the data type.

The follow table gives the byte counts of columns by data type for columns that do not allow null values. If any column allows null values, one byte is required for every eight columns. A column that has a field procedure could have a different count based on the result of the field procedure.

<i>Table 85. Byte Counts of Columns by Data Type</i>		
Data Type	Row Buffer Byte Count	Row Data Byte Count
SMALLINT	2	2
INTEGER	4	4
BIGINT	8	8
DECIMAL(<i>p</i> , <i>s</i>)	The integral part of (<i>p</i> /2) + 1	The integral part of (<i>p</i> /2) + 1
NUMERIC(<i>p</i> , <i>s</i>)	<i>p</i>	<i>p</i>
FLOAT (single precision)	4	4
FLOAT (double precision)	8	8

Table 85. Byte Counts of Columns by Data Type (continued)

Data Type	Row Buffer Byte Count	Row Data Byte Count
DECFLOAT(16)	8	8
DECFLOAT(34)	16	16
CHAR(<i>n</i>)	<i>n</i>	<i>n</i>
VARCHAR(<i>n</i>)	<i>n</i> +2	<i>n</i> +2
CLOB(<i>n</i>)	29+ <i>pad</i>	<i>n</i> +29
GRAPHIC(<i>n</i>)	<i>n</i> *2	<i>n</i> *2
VARGRAPHIC(<i>n</i>)	<i>n</i> *2+2	<i>n</i> *2+2
DBCLOB(<i>n</i>)	29+ <i>pad</i>	<i>n</i> *2+29
BINARY(<i>n</i>)	<i>n</i>	<i>n</i>
VARBINARY(<i>n</i>)	<i>n</i> +2	<i>n</i> +2
BLOB(<i>n</i>)	29+ <i>pad</i>	<i>n</i> +29
DATE	10	4
TIME	8	3
TIMESTAMP(<i>p</i>)	when <i>p</i> is 0, 19; otherwise 20+ <i>p</i>	The integral part of $((p+1)/2) + 7$
DATALINK(<i>n</i>)	<i>n</i> +24	<i>n</i> +24
ROWID	42	28
XML	29+ <i>pad</i>	2 147 483 647
<i>distinct-type</i>	The byte count for the source type.	The byte count for the source type.

Notes:

pad is a value from 1 to 15 necessary for boundary alignment.

Precision as described to the database:

- Floating-point fields are defined in the Db2 for i database with a decimal precision, not a bit precision. The algorithm used to convert the number of bits to decimal is *decimal precision* = *CEILING*(*n*/3.31), where *n* is the number of bits to convert. The decimal precision is used to determine how many digits to display using interactive SQL.
- SMALLINT fields are stored with a decimal precision of 4,0.
- INTEGER fields are stored with a decimal precision of 9,0.
- BIGINT fields are stored with a decimal precision of 19,0.

LONG VARCHAR, LONG VARGRAPHIC, and LONG VARBINARY

The non-standard syntax of LONG VARCHAR, LONG VARGRAPHIC, and LONG VARBINARY is supported, but deprecated. The alternative standard syntax of VARCHAR(integer), VARGRAPHIC(integer), and VARBINARY(integer) is preferred. VARCHAR(integer), VARGRAPHIC(integer), and VARBINARY(integer) are recommended. After the CREATE TABLE statement is processed, the database manager considers a LONG VARCHAR column to be VARCHAR, a LONG VARGRAPHIC column to be VARGRAPHIC, and a LONG VARBINARY column to be VARBINARY. The maximum length is calculated in a product-specific fashion that is not portable.

LONG VARCHAR¹⁰⁰

For a varying length character string whose maximum length is determined by the amount of space available in the row.

LONG VARGRAPHIC¹⁰⁰

For a varying length graphic string whose maximum length is determined by the amount of space available in the row.

LONG VARBINARY¹⁰⁰

For a varying length binary string whose maximum length is determined by the amount of space available in the row.

The maximum length of a LONG column is determined as follows. Let:

- *i* be the sum of the row buffer byte counts of all columns in the table that are not LONG VARCHAR, LONG VARGRAPHIC, or LONG VARBINARY
- *j* be the number of LONG VARCHAR, LONG VARGRAPHIC, and LONG VARBINARY columns in the table
- *k* be the number of columns in the row that allow nulls.

The length of each LONG VARCHAR and LONG VARBINARY column is $\text{INTEGER}((32716 - i - ((k+7)/8))/j)$.

The length of each LONG VARGRAPHIC column is determined by taking the length calculated for a LONG VARCHAR column and dividing it by 2. The integer portion of the result is the length.

Rules for System Name Generation

There are specific instances when the system generates a system table, view, index, or column name. These instances and the name generation rules are described in the following sections.

Rules for Column Name Generation

A system-column-name is generated if the system-column-name is not specified when a table or view is created and the column-name is not a valid system-column-name.

If the column-name does not contain special characters and is longer than 10 characters, a 10-character system-column-name will be generated as:

- The first 5 characters of the name
- A 5 digit unique number

For example:

```
The system-column-name for LONGCOLUMNNAME would be LONGC00001
```

If the column name is delimited:

- The first 5 characters from within the delimiters will be used as the first 5 characters of the system-column-name. If there are fewer than 5 characters within the delimiters, the name will be padded on the right with underscore () characters. Lower case characters are folded to upper case characters. The only valid characters in a system-column-name are: A-Z, 0-9, @, #, \$, and _ . Any other characters will be changed to the underscore () character. If the first character ends up as an underscore, it will be changed to the letter Q.
- A 5 digit unique number is appended to the 5 characters.

For example:

```
The system-column-name for "abc" would be ABC__00001
The system-column-name for "COL2.NAME" would be COL2_00001
The system-column-name for "C 3" would be C_3__00001
```

¹⁰⁰ This option is provided for compatibility with other products. It is recommended that VARCHAR(integer), VARGRAPHIC(integer), or VARBINARY(integer) be specified instead.

```
The system-column-name for "??" would be Q____00001
The system-column-name for "*column1" would be QCOLU00001
```

Rules for Table Name Generation

A system name will be generated if a table, view, alias, or index is created without using the FOR SYSTEM NAME clause and has either:

- A name longer than 10 characters
- A name that contains characters not valid in a system name

The SQL name or its corresponding system name may both be used in SQL statements to access the file once it is created. However, the SQL name is only recognized by Db2 for i and the system name must be used in other environments.

There are two separate methods for generating the system name:

- If a data area with the name QGENOBJNAM exists in the same schema that the table is created into, the user can influence the generated name.

The data area is subject to the following restrictions:

- The user must be authorized to read the data area.
- The data area must have an attribute of CHAR(10).
- The first 5 characters of the data area value must be '?????'.
- The next 5 characters of the data area value must contain 5 numeric digits.

If any of the above conditions are not satisfied or any error occurs while accessing the starting value in the data area, the default name generation rules will be used as if the data area did not exist at all.

If the data area meets all of the restrictions above, the generated name will be the same as if the default name generation rules below except that after the first 5 (or 4) characters of the name, the unique number will initially contain the 5 digits specified in the data area (instead of '00001' or '0001').

For example, if the value of the data area was '?????00999':

```
The system name for "??" would be "__00999"
The system name for "longtablename" would be "lon00999"
The system name for "LONGTableName" would be LONG00999
The system name for "A b" would be "A_b00999"
```

- Otherwise, the default name generation rules are used:

If the name does not contain special characters and is longer than 10 characters, a 10-character system name will be generated as:

- The first 5 characters of the name
- A 5 digit unique number

For example:

```
The system name for LONGTABLENAME would be LONGT00001
```

If the SQL name contains special characters, the system name is generated as:

- The first 4 characters of the name
- A 4 digit unique number

In addition:

- All special characters are replaced by the underscore (_)
- Any trailing blanks are removed from the name
- The name is delimited by double quotes (") if the delimiters are required for the name to be a valid system name.

For example:

```
The system name for "??" would be "__0001"
The system name for "longtablename" would be "long0001"
The system name for "LONGTableName" would be LONG0001
The system name for "A b " would be "A_b0001"
```

SQL ensures the system name is unique by searching the cross reference file. If the name already exists in the cross reference file, the number is incremented until the name is no longer a duplicate.

If a unique name cannot be determined using the above rules, an additional character is added to the counter in the name, and the number is incremented until a unique name can be found or the range is exhausted. For example, if creating "longtablename" and names "long0001" through "long9999" already exist, the name would become "lon00001".

Examples

Example 1: Given database administrator authority, create a table named 'ROSSITER.INVENTORY' with the following columns:

Part number

Small integer, must not be null

Description

Character of length 0 to 24, allows nulls

Quantity on hand,

Integer allows nulls

```
CREATE TABLE ROSSITER.INVENTORY
(PARTNO          SMALLINT      NOT NULL,
DESCR           VARCHAR(24),
QONHAND         INT)
```

Example 2: Create a table named DEPARTMENT with the following columns:

Department number

Character of length 3, must not be null

Department name

Character of length 0 through 36, must not be null

Manager number

Character of length 6

Administrative dept.

Character of length 3, must not be null

Location name

Character of length 16, allows nulls

The primary key is column DEPTNO.

```
CREATE TABLE DEPARTMENT
(DEPTNO          CHAR(3)      NOT NULL,
DEPTNAME        VARCHAR(36)  NOT NULL,
MGRNO           CHAR(6),
ADMRDEPT        CHAR(3)      NOT NULL,
LOCATION          CHAR(16),
PRIMARY KEY(DEPTNO))
```

Example 3: Create a table named REORG_PROJECTS which has the same column definitions as the columns in the view PRJ_LEADER.

```
CREATE TABLE REORG_PROJECTS
LIKE PRJ_LEADER
```

Example 4: Create an EMPLOYEE2 table with an identity column named EMP_NO. Define the identity column so that Db2 for i will always generate the values for the column. Use the default value, which is 1,

for the first value that should be assigned and for the incremental difference between the subsequently generated consecutive numbers.

```
CREATE TABLE EMPLOYEE2
( EMPNO INTEGER GENERATED ALWAYS AS IDENTITY,
  ID SMALLINT,
  NAME CHAR(30),
  SALARY DECIMAL(5,2),
  DEPTNO SMALLINT)
```

Example 5: Assume a very large transaction table named TRANS contains one row for each transaction processed by a company. The table is defined with many columns. Create a materialized query table for the TRANS table that contains daily summary data for the date and amount of a transaction.

```
CREATE TABLE STRANS
AS (SELECT YEAR AS SYEAR, MONTH AS SMONTH, DAY AS SDAY, SUM(AMOUNT) AS SSUM
    FROM TRANS
    GROUP BY YEAR, MONTH, DAY )
DATA INITIALLY DEFERRED
REFRESH DEFERRED
MAINTAINED BY USER
```

Example 6: Create a table, *policy_info*, that uses a SYSTEM_TIME period and create a history table, *hist_policy_info*. Then issue an ALTER TABLE statement to associate the *policy_info* table with the *hist_policy_info* table.

```
CREATE TABLE policy_info
(policy_id CHAR(10) NOT NULL,
 coverage INT NOT NULL,
 sys_start TIMESTAMP(12) NOT NULL GENERATED ALWAYS AS ROW BEGIN,
 sys_end TIMESTAMP(12) NOT NULL GENERATED ALWAYS AS ROW END,
 create_id TIMESTAMP(12) GENERATED ALWAYS AS TRANSACTION START ID,
 PERIOD SYSTEM_TIME(sys_start,sys_end));

CREATE TABLE hist_policy_info
(policy_id CHAR(10) NOT NULL,
 coverage INT NOT NULL,
 sys_start TIMESTAMP(12) NOT NULL,
 sys_end TIMESTAMP(12) NOT NULL,
 create_id TIMESTAMP(12));

ALTER TABLE policy_info
ADD VERSIONING USE HISTORY TABLE hist_policy_info;
```

The history table can also be created in the following way since the generated attributes are not copied for LIKE:

```
CREATE TABLE hist_policy_info
LIKE policy_info;
```

CREATE TRIGGER

The CREATE TRIGGER statement defines a trigger at the current server.

Invocation

This statement can be embedded in an application program or issued interactively. It is an executable statement that can be dynamically prepared.

Authorization

The privileges held by the authorization ID of the statement must include at least one of the following:

- The privilege to create in the schema. For more information, see [Privileges necessary to create in a schema](#).
- Database administrator authority

The privileges held by the authorization ID of the statement must include at least one of the following:

- Each of the following:
 - The ALTER privilege on the table or view on which the trigger is defined,
 - The SELECT privilege on the table or view on which the trigger is defined,
 - The SELECT privilege on any table or view referenced in the *search-condition* in the *trigger-action*,
 - The UPDATE privilege on the table on which the trigger is defined, if the BEFORE UPDATE trigger contains a SET statement that modifies the NEW correlation variable,
 - The privileges required to execute each *triggered-SQL-statement*, and
 - The USAGE privilege on the schema containing the table or view on which the trigger is defined.
- Database administrator authority

If an INSTEAD OF trigger is added to a view that is not inherently updatable, the *OBJMGT system authority is also required on the view.

In addition, the privileges held by the authorization ID of the statement must include at least one of the following:

- The following system authorities:
 - *USE on the Add Physical File Trigger (ADDPFTRG) command,
 - *USE on the Create Program (CRTPGM) command
- Database administrator authority

If the SECURED attribute is specified, or the trigger is secured and OR REPLACE is specified :

- The authorization ID of the statement must have security administrator authority. See [“Administrative authority”](#) on page 15.

If SQL names are specified, and a user profile exists that has the same name as the library into which the trigger is created, and the name is different from the authorization ID of the statement, then the privileges held by the authorization ID of the statement must include at least one of the following:

- *ALLOBJ and *SECADM special authority
- Database administrator authority

To replace an existing trigger, the privileges held by the authorization ID of the statement must include at least one of the following:

- The following system authorities:
 - The system authority of *OBJMGT on the trigger program object

- All authorities needed to DROP the trigger
- Database administrator authority

For information about the system authorities corresponding to SQL privileges, see [Corresponding System Authorities When Checking Privileges to a Table or View](#).

Syntax

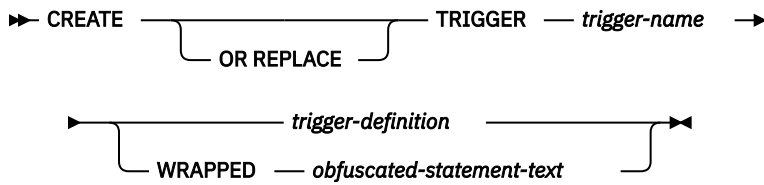

trigger-definition

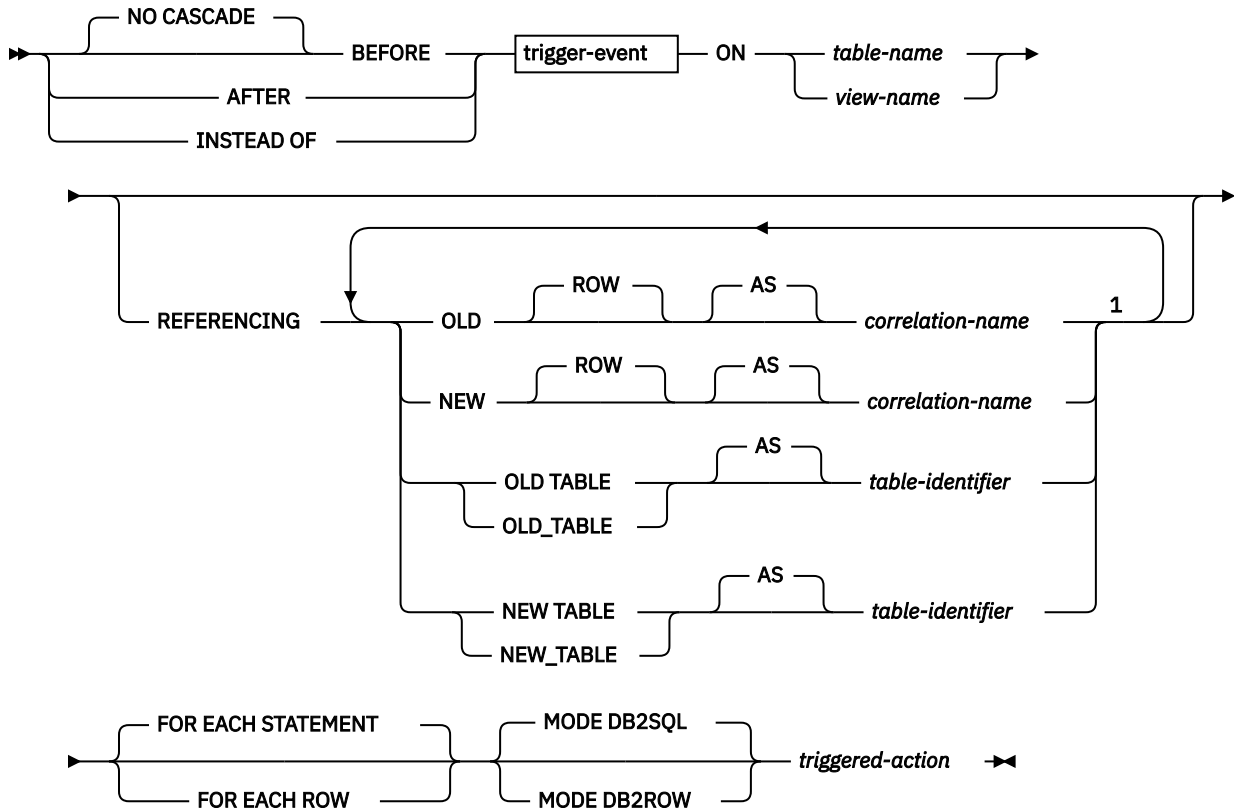

Notes:

¹ The same clause must not be specified more than once.

trigger-event

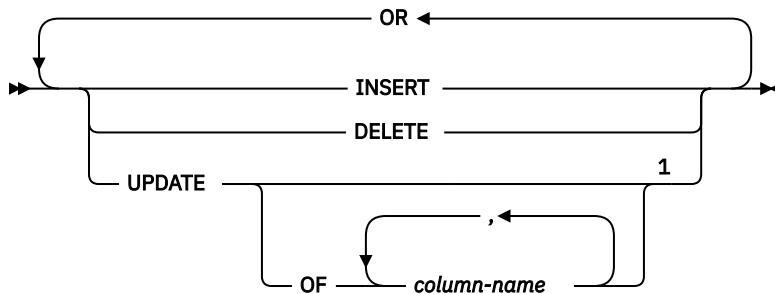

Notes:

¹ Each *trigger-event* option can be specified only one time.

triggered-action

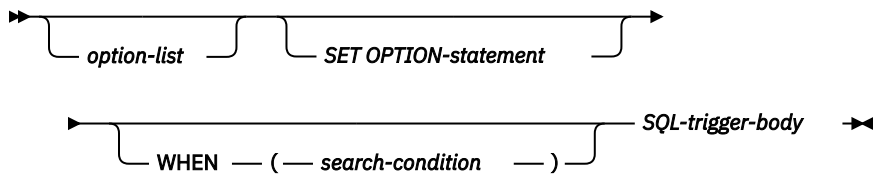

option-list

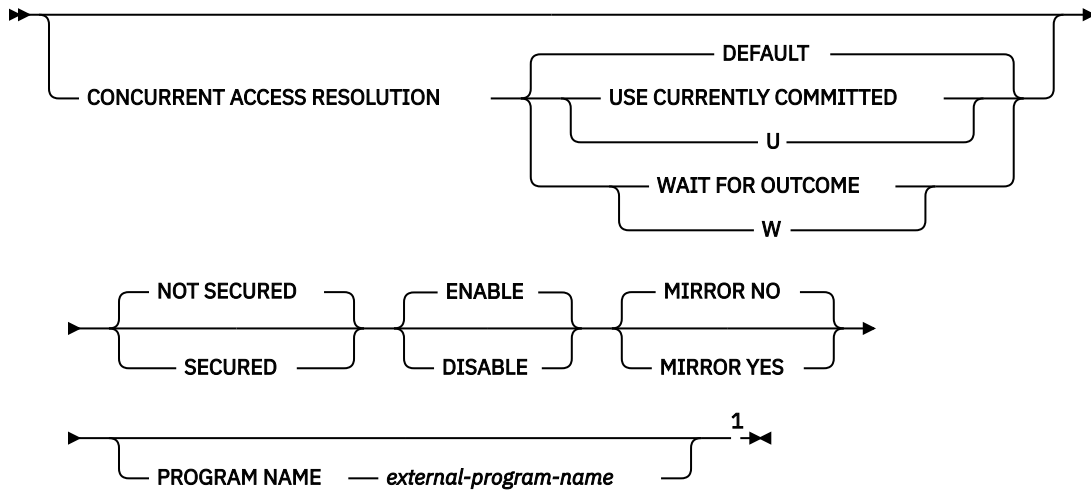

Notes:

¹ The options can be specified in any order. The same clause must not be specified more than once.

SQL-trigger-body

<i>SQL-control-statement</i>	
<i>fullselect</i>	
<i>ALLOCATE CURSOR-statement</i>	
<i>ALLOCATE DESCRIPTOR-statement</i>	
<i>ALTER FUNCTION-statement</i>	
<i>ALTER MASK-statement</i>	
<i>ALTER PERMISSION-statement</i>	
<i>ALTER PROCEDURE-statement</i>	
<i>ALTER SEQUENCE-statement</i>	
<i>ALTER TABLE-statement</i>	
<i>ASSOCIATE LOCATORS-statement</i>	
<i>COMMENT statement</i>	
<i>CREATE ALIAS-statement</i>	
<i>CREATE FUNCTION (external scalar)-statement</i>	
<i>CREATE FUNCTION (external table)-statement</i>	
<i>CREATE INDEX-statement</i>	
<i>CREATE MASK-statement</i>	
<i>CREATE PERMISSION-statement</i>	
<i>CREATE PROCEDURE (external)-statement</i>	
<i>CREATE SCHEMA-statement</i>	
<i>CREATE SEQUENCE-statement</i>	
<i>CREATE TABLE-statement</i>	
<i>CREATE TYPE-statement</i>	
<i>CREATE VIEW-statement</i>	
<i>DEALLOCATE DESCRIPTOR-statement</i>	
<i>DECLARE declared temporary table-statement</i>	
<i>DELETE-statement</i>	
<i>DESCRIBE-statement</i>	
<i>DESCRIBE CURSOR-statement</i>	
<i>DESCRIBE INPUT-statement</i>	
<i>DESCRIBE PROCEDURE-statement</i>	
<i>DESCRIBE TABLE-statement</i>	

Syntax (continued)

<i>DROP-statement</i>
<i>EXECUTE IMMEDIATE-statement</i>
<i>GET DESCRIPTOR-statement</i>
<i>GRANT-statement</i>
<i>INSERT-statement</i>
<i>LABEL-statement</i>
<i>LOCK TABLE-statement</i>
<i>MERGE-statement</i>
<i>REFRESH TABLE-statement</i>
<i>RELEASE-statement</i>
<i>RELEASE SAVEPOINT-statement</i>
<i>RENAME-statement</i>
<i>REVOKE-statement</i>
<i>SAVEPOINT-statement</i>
<i>SELECT INTO-statement</i>
<i>SET CURRENT DEBUG MODE-statement</i>
<i>SET CURRENT DECFLOAT ROUNDING MODE-statement</i>
<i>SET CURRENT DEGREE-statement</i>
<i>SET CURRENT IMPLICIT XMLPARSE OPTION-statement</i>
<i>SET CURRENT TEMPORAL SYSTEM_TIME-statement</i>
<i>SET DESCRIPTOR-statement</i>
<i>SET ENCRYPTION PASSWORD-statement</i>
<i>SET PATH-statement</i>
<i>SET SCHEMA-statement</i>
<i>SET TRANSACTION-statement</i>
<i>SET transition-variable-statement</i>
<i>TRANSFER OWNERSHIP-statement</i>
<i>TRUNCATE-statement</i>
<i>UPDATE-statement</i>
<i>VALUES INTO-statement</i>

Description

OR REPLACE

Specifies to replace the definition for the trigger if one exists at the current server. The existing definition is effectively dropped before the new definition is replaced in the catalog with the exception that privileges that were granted on the trigger are not affected. This option is ignored if a definition for the trigger does not exist at the current server.

trigger-name

Names the trigger. The name, including the implicit or explicit qualifier, must not be the same as a trigger that already exists at the current server. QTEMP cannot be used as the *trigger-name* schema qualifier.

If SQL names were specified, the trigger will be created in the schema specified by the implicit or explicit qualifier.

If system names were specified, the trigger will be created in the schema that is specified by the qualifier. If not qualified, the trigger will be created in the same schema as the subject table.

If the trigger name is not a valid system name, or if a program with the same name already exists, the database manager will generate a system name. For information about the rules for generating a name, see “[Rules for Table Name Generation](#)” on page 1157.

NO CASCADE

NO CASCADE is allowed for compatibility with other products and is ignored by Db2 for i.

BEFORE

Specifies that the trigger is a *before* trigger. The database manager executes the *triggered-action* before it applies any changes caused by an insert, delete, or update operation on the subject table. It also specifies that the *triggered-action* does not activate other triggers because the *triggered-action* of a before trigger cannot contain any updates.

BEFORE must not be specified when a *view-name* is specified. FOR EACH STATEMENT must not be specified for a BEFORE trigger.

AFTER

Specifies that the trigger is an *after* trigger. The database manager executes the *triggered-action* after it applies any changes caused by an insert, delete, or update operation on the subject table. AFTER must not be specified when *view-name* is also specified.

INSTEAD OF

Specifies that the trigger is an *instead of* trigger. The associated triggered action replaces the action against the subject view. Only one INSTEAD OF trigger is allowed for each kind of operation on a given subject view. The database manager executes the *triggered-action* instead of the insert, delete, or update operation on the subject view.

INSTEAD OF must not be specified when *table-name* is specified. The WHEN clause must not be specified for an INSTEAD OF trigger. FOR EACH STATEMENT must not be specified for an INSTEAD OF trigger.

trigger-event

Specifies that the triggered action associated with the trigger is to be executed whenever one of the events is applied to the subject table or view. Any combination of the events can be specified, but each event (INSERT, DELETE, UPDATE) can only be specified once.

INSERT

Specifies that the *triggered-action* associated with the trigger is to be executed whenever there is an insert operation on the subject table.

A BEFORE INSERT trigger cannot be added to a history table.

DELETE

Specifies that the *triggered-action* associated with the trigger is to be executed whenever there is a delete operation on the subject table.

A DELETE trigger cannot be added to a table with a referential constraint of ON DELETE CASCADE.

UPDATE

Specifies that the *triggered-action* associated with the trigger is to be executed whenever there is an update operation on the subject table.

An UPDATE trigger event cannot be added to a table with a referential constraint of ON DELETE SET NULL or ON DELETE SET DEFAULT.

A BEFORE UPDATE trigger cannot be added to a history table.

If an explicit *column-name* list is not specified, an update operation on any column of the subject table, including columns that are subsequently added with the ALTER TABLE statement, activates the *triggered-action*.

OF *column-name*, ...

Each *column-name* specified must be a column of the subject table, and must appear in the list only once. An update operation on any of the listed columns activates the *triggered-action*. This clause cannot be specified for an INSTEAD OF trigger.

ON *table-name*

Identifies the subject table of a BEFORE or AFTER trigger definition. The name must identify a base table that exists at the current server, but must not identify a catalog table, a table in QTEMP, or a declared temporary table.

ON *view-name*

Identifies the subject view of an INSTEAD OF trigger definition. The name must identify a view that exists at the current server, but must not identify a catalog view, or a view in QTEMP. The name must not specify a view that is defined using WITH CHECK OPTION, or a view on which a WITH CHECK OPTION view has been defined, directly or indirectly

REFERENCING

Specifies the correlation names for the transition tables and the table names for the transition tables. *Correlation-names* identify a specific row in the set of rows affected by the triggering SQL operation. *Table-identifiers* identify the complete set of affected rows.

Each row affected by the triggering SQL operation is available to the *triggered-action* by qualifying columns with *correlation-names* specified as follows:

OLD ROW AS *correlation-name*

Specifies a correlation name that identifies the values in the row prior to the triggering SQL operation. If the trigger event is insert, the value for every column in OLD ROW is the NULL value.

NEW ROW AS *correlation-name*

Specifies a correlation name which identifies the values in the row as modified by the triggering SQL operation and any SET statement in a before trigger that has already executed. If the trigger event is delete, the value for every column in NEW ROW is the NULL value.

The complete set of rows affected by the triggering SQL operation is available to the *triggered-action* by using a temporary table name specified as follows:

OLD TABLE AS *table-identifier*

Specifies the name of a temporary table that identifies the values in the complete set of affected rows prior to the triggering SQL operation. The OLD TABLE includes the rows that were affected by the trigger if the current activation of the trigger was caused by statements in the *SQL-trigger-body* of a trigger. If the trigger event is insert, the temporary table is empty.

NEW TABLE AS *table-identifier*

Specifies the name of a temporary table that identifies the state of the complete set of affected rows as modified by the triggering SQL operation and by any SET statement in a before trigger that has already been executed. If the trigger event is delete, the temporary table is empty.

Only one OLD and one NEW *correlation-name* may be specified for a trigger. Only one OLD_TABLE and one NEW_TABLE *table-identifier* may be specified for a trigger. All of the *correlation-names* and *table-identifiers* must be unique from one another.

The OLD *correlation-name* and the OLD_TABLE *table-identifier* are populated only if the triggering event is either a delete operation or an update operation. For a delete operation, the OLD *correlation-name* captures the values of the columns in the deleted row, and the OLD_TABLE *table-identifier* captures the values in the set of deleted rows. For an update operation, OLD *correlation-name* captures the values of the columns of a row before the update operation, and the OLD_TABLE *table-identifier* captures the values in the set of updated rows.

The NEW ROW *correlation-name* and the NEW TABLE *table-identifier* are populated only if the triggering event is either an INSERT operation or an UPDATE operation. For both operations, the NEW ROW *correlation-name* captures the values of the columns in the inserted or updated row, and the NEW TABLE *table-identifier* captures the values in the set of inserted or updated rows. For before triggers, the values of the updated rows include the changes from any SET statements in the *triggered-action* of before triggers.

The OLD ROW and NEW ROW *correlation-name* variables cannot be modified in an AFTER trigger or INSTEAD OF trigger.

The tables below summarize the allowable combinations of correlation variables and transition tables.

Granularity: **FOR EACH ROW**

MODE	Activation Time	Triggering Operation	Correlation Variables Allowed	Transition Tables Allowed	
DB2ROW	BEFORE	DELETE	OLD	NONE	
		INSERT	NEW		
		UPDATE	OLD, NEW		
	AFTER or INSTEAD OF	DELETE	OLD		
		INSERT	NEW		
		UPDATE	OLD, NEW		
DB2SQL	BEFORE	DELETE	OLD	NONE	
		INSERT	NEW		
		UPDATE	OLD, NEW		
	AFTER or INSTEAD OF	DELETE	OLD		OLD TABLE
		INSERT	NEW		NEW TABLE
		UPDATE	OLD, NEW		OLD TABLE, NEW TABLE

Granularity: **FOR EACH STATEMENT**

MODE	Activation Time	Triggering Operation	Correlation Variables Allowed	Transition Tables Allowed
DB2SQL	AFTER or INSTEAD OF	DELETE	NONE	OLD TABLE
		INSERT		NEW TABLE
		UPDATE		OLD TABLE, NEW TABLE

A transition variable that has a character data type inherits the CCSID of the column of the subject table. During the execution of the *triggered-action*, the transition variables are treated like variables. Therefore, character conversion might occur.

The temporary transition tables are read-only. They cannot be modified.

The scope of each *correlation-name* and each *table-identifier* is the entire trigger definition.

FOR EACH ROW

Specifies that the database manager executes the *triggered-action* for each row of the subject table that the triggering operation modifies. If the triggering operation does not modify any rows, the *triggered-action* is not executed.

FOR EACH STATEMENT

Specifies that the database manager executes the *triggered-action* only once for the triggering operation. Even if the triggering operation does not modify or delete any rows, the triggered action is still executed once.

FOR EACH STATEMENT cannot be specified for a BEFORE trigger.

FOR EACH STATEMENT cannot be specified for a MODE DB2ROW trigger.

MODE DB2SQL

MODE DB2SQL is valid for AFTER triggers. MODE DB2SQL AFTER triggers are activated after all of the row operations have occurred.

MODE DB2SQL is only valid for BEFORE triggers if a REFERENCING clause is not specified and the trigger table is not referenced in the *SQL-trigger-body*. MODE DB2SQL BEFORE triggers are activated on each row operation.

MODE DB2ROW

MODE DB2ROW triggers are activated on each row operation.

MODE DB2ROW is valid for both the BEFORE and AFTER activation time.

CONCURRENT ACCESS RESOLUTION

Specifies whether the database manager should wait for data that is in the process of being updated. DEFAULT is the default.

DEFAULT

Specifies that the concurrent access resolution is not explicitly set for this trigger. The value that is in effect when the trigger program is invoked will be used.

WAIT FOR OUTCOME

Specifies that the database manager is to wait for the commit or rollback of data in the process of being updated.

USE CURRENTLY COMMITTED

Specifies that the database manager is to use the currently committed version of the data when encountering data that is in the process of being updated.

When the lock contention is between a read transaction and a delete or update transaction, the clause is applicable to scans with isolation level CS (but not for CS KEEP LOCKS).

SECURED or NOT SECURED

Specifies whether the trigger is considered secure for row access control and column access control. NOT SECURED is the default.

SECURED

Specifies that the trigger is considered secure for row access control and column access control.

SECURED must be specified for a trigger whose subject table is using row access control or column access control. SECURED must also be specified for a trigger that is created for a view and one or more of the underlying tables in the view definition is using row access control or column access control.

NOT SECURED

Specifies that the trigger is considered not secure for row access control and column access control.

NOT SECURED must not be specified explicitly or implicitly for a trigger whose subject table is using row access control or column access control. NOT SECURED must also not be specified for a trigger that is created for a view and one or more of the underlying tables in the view definition is using row access control or column access control.

ENABLE or DISABLE

Specifies the state for the trigger. ENABLE is the default.

ENABLE

The trigger will be fired during the appropriate data change operations.

DISABLE

The trigger will not be fired during the appropriate data change operations.

MIRROR NO or MIRROR YES

Specifies where the trigger will be fired in a mirrored environment. This option is ignored if the table on which the trigger is defined is not replicated. MIRROR NO is the default.

MIRROR NO

In a mirrored environment, the trigger will be fired only on the source node.

MIRROR YES

In a mirrored environment, the trigger will be fired on both nodes in the mirrored pair when the replication state is ACTIVE. If the replication state is TRACKING, the trigger will fire on the primary node. It will never be fired on the secondary node for any changes made while in TRACKING state.

MIRROR YES is not allowed for an INSTEAD OF trigger or any trigger that is defined as MODE DB2SQL.

WRAPPED *obfuscated-statement-text*

Specifies the encoded definition of the trigger. A CREATE TRIGGER statement can be encoded using the WRAP scalar function.

PROGRAM NAME *external-program-name*

Specifies the unqualified name of the program to be created for the trigger. *external-program-name* must be in the form of a program name. It must not be a service program name.

triggered-action

Specifies the action to be performed when a trigger is activated. The *triggered-action* is composed of one or more SQL statements and by an optional condition that controls whether the statements are executed.

SET OPTION-statement

Specifies the options that will be used to create the trigger. For example, to create a debuggable trigger, the following statement could be included:

```
SET OPTION DBGVIEW = *SOURCE
```

The default values for the options depend on the options in effect at create time. For more information, see [“SET OPTION” on page 1505](#).

The options CNULIGN, CNULRQD, COMPILEOPT, NAMING, and SQLCA are not allowed in the CREATE TRIGGER statement. The COMMIT option is allowed, but ignored.

The options DATFMT, DATSEP, TIMFMT, and TIMSEP cannot be used if OLD ROW or NEW ROW is specified.

WHEN (*search-condition*)

Specifies a condition that evaluates to true, false, or unknown. The triggered SQL statements are executed only if the *search-condition* evaluates to true. If the WHEN clause is omitted, the associated SQL statements are always executed.

A WHEN clause must not be specified with an INSTEAD OF trigger.

SQL-trigger-body

Specifies a single *SQL-procedure-statement*, including a compound statement. See [“SQL control statements” on page 1569](#) for more information about defining SQL triggers using the SQL Procedural Language (SQL PL).

A call to a procedure that issues a CONNECT, SET CONNECTION, RELEASE, DISCONNECT, COMMIT, ROLLBACK, SET TRANSACTION, and SET RESULT SETS statement is not allowed in the *triggered-action* of a trigger.

An UNDO handler is not allowed in a trigger.

All tables, views, aliases, distinct types, global variables, user-defined functions, and procedures referenced in the *triggered-action* must exist at the current server when the trigger is created. The table or view that an alias refers to must also exist when the trigger is created. This includes objects in library QTEMP. While objects in QTEMP can be referenced in the *triggered-action*, dropping those objects in QTEMP will not cause the trigger to be dropped.

All transition variable names are column names of the subject table. System column names of the subject table cannot be used as transition variable names.

The triggered action of a BEFORE trigger on a column of type XML can invoke the XMLVALIDATE function through a SET statement, leave values of type XML unchanged, or assign them to NULL using a SET statement.

A dynamic statement in the *triggered-action* can use 3-part names to access a remote server. A library with the same name as the trigger program's library must exist on the remote server. Static statements in the *triggered-action* cannot use 3-part names.

Static and dynamic statements in the *triggered-action* can invoke a procedure or a user-defined function that can access a server other than the current server if the procedure or user-defined function runs in a different activation group.

Notes

Trigger ownership: If SQL names were specified:

- If a user profile with the same name as the schema into which the trigger is created exists, the *owner* of the trigger is that user profile.
- Otherwise, the *owner* of the trigger is the user profile or group user profile of the thread executing the statement.

If system names were specified, the *owner* of the trigger is the user profile or group user profile of the thread executing the statement.

Trigger authority: The trigger program object authorities are:

- When SQL naming is in effect, the trigger program will be created with the public authority of *EXCLUDE, and adopt authority from the schema qualifier of the trigger-name if a user profile with that name exists. If a user profile for the schema qualifier does exist, then the owner of the trigger program will be the user profile for the schema qualifier. Note that the special authorities *ALLOBJ and *SECADM are required to create the trigger program object in the schema qualifier library if a user profile exists that has the same name as the schema qualifier, and the name is different from the authorization ID of the statement. If a user profile for the schema qualifier does not exist, then the owner of the trigger program will be the user profile or group user profile of the thread executing the SQL CREATE TRIGGER statement. The group user profile will be the owner of the trigger program object, only if OWNER(*GRPPRF) was specified on the user's profile who is executing the statement. If the owner of the trigger program is a member of a group profile, and if OWNER(*GRPPRF) was specified on the user's profile, the program will run with the adopted authority of the group profile.
 - For an INSTEAD OF TRIGGER, the privilege associated with the trigger event will be granted to the owner of the view and to the user profile or group user profile of the thread executing the CREATE TRIGGER statement.
- When System naming is in effect, the trigger program will be created with public authority of *EXCLUDE, and adopt authority from the user or group user profile of the thread executing the SQL CREATE TRIGGER statement.

Execution authorization: The user executing the triggering SQL operation does not need authority to execute a static *triggered-SQL-statement*. A static *triggered-SQL-statement* will execute using the authority of the *owner* of the trigger.

REPLACE rules: When a trigger is recreated by REPLACE:

- Any existing comment or label is discarded.
- Authorized users are maintained. The object owner could change.
- Current journal auditing is preserved.
- The firing order of the trigger is not maintained.

Activating a trigger: Only insert, delete, or update operations can activate a trigger. A delete operation that occurs as a result of a referential constraint will not activate a trigger. Hence,

- A trigger with a DELETE trigger event cannot be added to a table with a referential constraint of ON DELETE CASCADE.

- A trigger with an UPDATE trigger event cannot be added to a table with a referential constraint of ON DELETE SET NULL or ON DELETE SET DEFAULT.

The activation of a trigger may cause *trigger cascading*. This is the result of the activation of one trigger that executes SQL statements that cause the activation of other triggers or even the same trigger again. The triggered actions may also cause updates as a result of the original modification, which may result in the activation of additional triggers. With trigger cascading, a significant chain of triggers may be activated causing significant change to the database as a result of a single delete, insert or update statement. The number of levels of cascading is limited to 200 or the maximum amount of storage allowed in the job or process, whichever comes first.

Adding triggers to enforce constraints: Adding a trigger to a table that already has rows in it will not cause the triggered actions to be executed. Thus, if the trigger is designed to enforce constraints on the data in the table, the data in the existing rows might not satisfy those constraints.

Considerations for implicitly hidden columns: In the body of a trigger, a trigger transition variable that corresponds to an implicitly hidden column can be referenced. A trigger transition table, that corresponds to a table with an implicitly hidden column, includes that column as part of the transition table.

Likewise, a trigger transition variable will exist for the column that is defined as implicitly hidden. A trigger transition variable that corresponds to an implicitly hidden column can be referenced in the body of a trigger.

Read-only views: The addition of an INSTEAD OF trigger for a view affects the read-only characteristic of the view. If a read-only view has a dependency relationship with an INSTEAD OF trigger, the type of operation that is defined for the INSTEAD OF trigger defines whether the view is deletable, insertable, or updatable.

Transition variable values and INSTEAD OF triggers: All trigger transition variables in an INSTEAD OF trigger are nullable.

The initial values for new transition variables or new transition table columns visible in an INSTEAD OF INSERT trigger are set as follows:

- If a value is explicitly specified for a column in the INSERT statement, the corresponding new transition variable or new transition table column is that explicitly specified value.
- If a value is not explicitly specified for a column in the INSERT statement or the DEFAULT keyword is specified, the corresponding new transition variable or new transition table column is:
 - the default value of the underlying table column if the view column is updatable (without the INSTEAD OF trigger) and not based on a generated column or ROWID,
 - otherwise, the null value.

The initial values for new transition variables or new transition table columns visible in an INSTEAD OF UPDATE trigger are set as follows:

- If a value is explicitly specified for a column in the UPDATE statement, the corresponding new transition variable or new transition table column is that explicitly specified value.
- If the DEFAULT keyword is explicitly specified for a column in the UPDATE statement, the corresponding new transition variable or new transition table column is:
 - the default value of the underlying table column if the view column is updatable (without the INSTEAD OF trigger) and not based on a generated column or ROWID,
 - otherwise, the null value.
- Otherwise, the corresponding new transition variable or new transition table column is the existing value of the column in the row.

Obfuscated statements: A CREATE TRIGGER statement can be executed in obfuscated form. In an obfuscated statement, only the trigger name is readable followed by the WRAPPED keyword. The rest of the statement is encoded in such a way that it is not readable but can be decoded by a database server that supports obfuscated statements. Obfuscated statements can be produced by invoking the WRAP

scalar function. Any debug options that are specified when the trigger is created from an obfuscated statement are ignored.

A trigger that is created from an obfuscated statement cannot be restored to a release where obfuscation is not supported. Consequently, a table with a trigger created from an obfuscated statement cannot be restored to a release where obfuscation is not supported.

Creating a trigger with the SECURED option: The trigger is considered secure after the CREATE TRIGGER statement is executed. Db2 treats the SECURED attribute as an assertion that declares that the user has established an audit procedure for all activities in the trigger body. If a secure trigger references user-defined functions, Db2 assumes those functions are secure without validation. If those functions can access sensitive data, a user that has security administrator authority needs to ensure that those functions are allowed to access that data and that an audit procedure is in place for those functions, and that all subsequent ALTER FUNCTION statements are being reviewed through this audit process.

A trigger must be secure if its subject table is using row access control or column access control. SECURED must also be specified for a trigger that is created for a view and one or more of the underlying tables in the view definition is using row access control or column access control activated.

Creating a trigger with the NOT SECURED option: The CREATE TRIGGER statement returns an error if the subject table of the trigger is using row access control or column access control, or if its subject table is a view and one or more of the underlying tables in the view is using row access control or column access control.

Transition variable values and row and column access control: Row and column access control is not enforced for transition variables and transition tables. If row or column access control is enforced for the triggering table, row permissions and column masks are not applied to the initial values of transition variables and transition tables. Row and column access control enforced for the triggering table is also ignored for transition variables and transition tables that are referenced in the trigger body or are passed as arguments to user-defined functions invoked within the trigger body. To ensure there are no security concerns for SQL statements accessing sensitive data in transition variables and transition tables, the trigger must be created with the SECURED option. If the trigger is not secure, row access control and column access control cannot be enforced for the triggering table and the CREATE TRIGGER statement returns an error.

Multiple triggers: Multiple triggers that have the same triggering SQL operation and activation time can be defined on a table. The triggers are activated based on the mode and the order in which they were created:

- MODE DB2ROW triggers (and native triggers created via the ADDPFTRG CL command) are fired first in the order in which they were created
- MODE DB2SQL triggers are fired next in the order in which they were created

For example, a MODE DB2ROW trigger that was created first is executed first, the MODE DB2ROW trigger that was created second is executed second.

A maximum of 300 triggers can be added to any given source table.

When a trigger is recreated using REPLACE, its position in the activation order is not maintained. It behaves as if the trigger were dropped and created again.

Adding columns to a subject table or a table referenced in the triggered action: If a column is added to the subject table after triggers have been defined, the following rules apply:

- If the trigger is an UPDATE trigger that was defined without an explicit column list, then an update to the new column will cause the activation of the trigger.
- If the SQL statements in the *triggered-action* refer to the triggering table, the new column is not accessible to the SQL statements until the trigger is recreated.
- The OLD_TABLE and NEW_TABLE transition tables will contain the new column, but the column cannot be referenced unless the trigger is recreated.

If a column is added to any table referenced by the SQL statements in the triggered-action, the new column is not accessible to the SQL statements until the trigger is recreated.

Dropping or revoking privileges on a table referenced in the triggered action: If an object such as a table, view or alias, referenced in the *triggered-action* is dropped, the access plans of the statements that reference the object will be rebuilt when the trigger is fired. If the object does not exist at that time, the corresponding INSERT, UPDATE or DELETE operation on the subject table will fail.

If a privilege that the creator of the trigger is required to have for the trigger to execute is revoked, the access plans of the statements that reference the object will be rebuilt when the trigger is fired. If the appropriate privilege does not exist at that time, the corresponding INSERT, UPDATE or DELETE operation on the subject table will fail.

Errors executing triggers: If a SIGNAL statement is executed in the *SQL-trigger-body*, an SQLCODE -438 and the SQLSTATE specified in the SIGNAL statement will be returned.

Other errors that occur during the execution of *SQL-trigger-body* statements are returned using SQLSTATE 09000 and SQLCODE -723.

Special registers in triggers: The values of the special registers are saved before a trigger is activated and are restored on return from the trigger. The values of the special registers are inherited from the triggering SQL operation.

Transaction isolation: All triggers, when they are activated, perform a SET TRANSACTION statement unless the isolation level of the application program invoking the trigger is the same as the default isolation level of the trigger program. This is necessary so that all of the operations by the trigger are performed with the same isolation level as the application program that caused the trigger to be run. The user may put their own SET TRANSACTION statements in an *SQL-control-statement* in the *SQL-trigger-body* of the trigger. If the user places a SET TRANSACTION statement within the *SQL-trigger-body* of the trigger, then the trigger will run with the isolation level specified in the SET TRANSACTION statement, instead of the isolation level of the application program that caused the trigger to be run.

If the application program that caused a trigger to be activated, is running with an isolation level other than No Commit (COMMIT(*NONE) or COMMIT(*NC)), the operations within the trigger will be run under commitment control and will not be committed or rolled back until the application commits its current unit of work. If ATOMIC is specified in the *SQL-trigger-body* of the trigger, and the application program that caused the ATOMIC trigger to be activated is running with an isolation level of No Commit (COMMIT(*NONE) or COMMIT(*NC)), the operations within the trigger will not be run under commitment control. If the application that caused the trigger to be activated is running with an isolation level of No Commit (COMMIT(*NONE) or COMMIT(*NC)), then the operations of a trigger are written to the database immediately, and cannot be rolled back.

If both system triggers defined by the Add Physical File Trigger (ADDPFTRG) CL command and SQL triggers defined by the CREATE TRIGGER statement are defined for a table, it is recommended that the system triggers perform a SET TRANSACTION statement so that they are run with the same isolation level as the original application that caused the triggers to be activated. It is also recommended that the system triggers run in the Activation Group of the calling application. If system triggers run in a separate Activation Group (ACTGRP(*NEW)), then those system triggers will not participate in the unit of the work for the calling application, nor in the unit of work for any SQL triggers. System triggers that run in a separate Activation Group are responsible for committing or rolling back any database operations they perform under commitment control. Note that SQL triggers defined by the CREATE TRIGGER statement always run in the caller's Activation Group.

If the triggering application is running with commitment control, the operations of an SQL trigger, and any cascaded SQL triggers, will be captured into a sub-unit of work. If the operations of the trigger and any cascaded triggers are successful, the operations captured in the sub-unit of work will be committed or rolled back when the triggering application commits or rolls back its current unit of work. Any system triggers that run in the same Activation Group as the caller, and perform a SET TRANSACTION to the isolation level of the caller, will also participate in the sub-unit of work. If the triggering application is running without commit control, then the operations of the SQL triggers will also be run without commitment control.

If an application that causes a trigger to be activated is running with an isolation level of No Commit (COMMIT(*NONE) or COMMIT(*NC)), and it issues an INSERT, UPDATE, or DELETE statement that encounters an error during the execution of the statement, no other system or SQL triggers will be

activated following the error for that operation. However, some number of changes will already have been performed. If the triggering application is running with commitment control, the operations of any triggers that are captured in a sub-unit of work will be rolled back when the first error is encountered, and no additional triggers will be activated for the current INSERT, UPDATE, or DELETE statement.

Performance considerations: Create the trigger under the isolation level that will most often be used by the application programs that cause the trigger to fire. The SET OPTION statement can be used to explicitly choose the isolation level.

ROW triggers (especially MODE DB2ROW triggers) perform much better than TABLE level triggers.

Considerations for implicitly hidden columns: A transition variable will exist for any column defined as implicitly hidden. In the body of a trigger, a transition variable that corresponds to an implicitly hidden column can be referenced.

Triggered actions in the catalog: At the time the trigger is created, the *triggered-action* is modified as a result of the CREATE TRIGGER statement:

- Naming mode is switched to SQL naming.
- All unqualified object references are explicitly qualified
- All implicit column lists (for example, SELECT *, INSERT with no column list, UPDATE SET ROW) are expanded to be the list of actual column names.

The modified *triggered-action* is stored in the catalog.

Renaming or moving a table referenced in the triggered action: Any table (including the subject table) referenced in a *triggered-action* can be moved or renamed. However, the *triggered-action* will continue to reference the old name or schema. An error will occur if the referenced table is not found when the *triggered-action* is executed. Hence, you should drop the trigger and then re-create the trigger so that it refers to the renamed or moved table.

Datetime considerations: If OLD ROW or NEW ROW is specified, the date or time constants and the string representation of dates and times in variables that are used in SQL statements in the *triggered-action* must have a format of ISO, EUR, JIS, USA, or must match the date and time formats specified when the table was created if it was created using DDS and the CRTPF CL command. If the DDS specifications contain multiple different date or time formats, the trigger cannot be created.

Operations that invalidate triggers: An *inoperative trigger* is a trigger that is no longer available to be activated. If a trigger becomes invalid, no INSERT, UPDATE, or DELETE operations will be allowed on the subject table or view. A trigger becomes invalid if:

- The SQL statements in the *triggered-action* reference the subject table or view, the trigger is a self-referencing trigger, and the table or view is duplicated using the system CRTDUPOBJ CL command, or
- The SQL statements in the *triggered-action* reference tables or views in the from library and the objects are not found in the new library when the table or view is duplicated using the system CRTDUPOBJ CL command, or
- The table or view is restored to a new library using the system RSTOBJ or RSTLIB CL commands, and the *triggered-action* references the subject table or subject view, the trigger is a self-referencing trigger.

An invalid trigger must first be dropped before it can be recreated by issuing a CREATE TRIGGER statement. Note that dropping and recreating a trigger will affect the activation order of a trigger if multiple triggers for the same triggering operation and activation time are defined for the subject table.

Trigger program object: When a trigger is created, SQL creates a temporary source file that will contain C source code with embedded SQL statements. A program object is then created using the CRTPGM command. The SQL options used to create the program are the options that are in effect at the time the CREATE TRIGGER statement is executed. The program is created with ACTGRP(*CALLER).

The program is created with STGMDL(*SNGLV). If the trigger runs on behalf of an application that uses STGMDL(*TERASPACE) and also uses commitment control, the entire application will need to run under a job scoped commitment definition (STRCMTCTL CMTSCOPE(*JOB)).

The trigger will execute with the adopted authority of the *owner* of the trigger.

Examples

Example 1: Create two triggers that track the number of employees that a company manages. The triggering table is the EMPLOYEE table, and the triggers increment and decrement a column with the total number of employees in the COMPANY_STATS table. The COMPANY_STATS table has the following properties:

```
CREATE TABLE COMPANY_STATS  
(NBEMP INTEGER,  
  NBPRODUCT INTEGER,  
  REVENUE DECIMAL(15,0))
```

This example uses row triggers to maintain summary data in another table.

Create the first trigger, NEW_HIRE, so that it increments the number of employees each time a new person is hired; that is, each time a new row is inserted into the EMPLOYEE table, increase the value of column NBEMP in table COMPANY_STATS by 1.

```
CREATE TRIGGER NEW_HIRE  
AFTER INSERT ON EMPLOYEE  
FOR EACH ROW MODE DB2SQL  
  UPDATE COMPANY_STATS SET NBEMP = NBEMP + 1
```

Create the second trigger, FORM_EMP, so that it decrements the number of employees each time an employee leaves the company; that is, each time a row is deleted from the table EMPLOYEE, decrease the value of column NBEMP in table COMPANY_STATS by 1.

```
CREATE TRIGGER FORM_EMP  
AFTER DELETE ON EMPLOYEE  
FOR EACH ROW MODE DB2SQL  
  BEGIN ATOMIC  
    UPDATE COMPANY_STATS SET NBEMP = NBEMP - 1;  
  END
```

Example 2: Create a trigger, REORDER, that invokes user-defined function ISSUE_SHIP_REQUEST to issue a shipping request whenever a parts record is updated and the on-hand quantity for the affected part is less than 10% of its maximum stocked quantity. User-defined function ISSUE_SHIP_REQUEST orders a quantity of the part that is equal to the part's maximum stocked quantity minus its on-hand quantity. The function eliminates any duplicate requests to order the same PARTNO and sends the unique order to the appropriate supplier.

This example also shows how to define the trigger as a statement trigger instead of a row trigger. For each row in the transition table that evaluates to true for the WHERE clause, a shipping request is issued for the part.

```
CREATE TRIGGER REORDER  
AFTER UPDATE OF ON_HAND, MAX_STOCKED ON PARTS  
REFERENCING NEW TABLE AS NTABLE  
FOR EACH STATEMENT MODE DB2SQL  
  BEGIN ATOMIC  
    DECLARE REQUEST_VAR INT;  
    SELECT ISSUE_SHIP_REQUEST(MAX_STOCKED - ON_HAND, PARTNO)  
    INTO REQUEST_VAR  
    FROM NTABLE  
    WHERE ON_HAND < 0.10 * MAX_STOCKED;  
  END
```

Example 3: Assume that table EMPLOYEE contains column SALARY. Create a trigger, SAL_ADJ, that prevents an update to an employee's salary that exceeds 20% and signals such an error. Have the error that is returned with an SQLSTATE of 75001 and a description. This example shows that the SIGNAL SQLSTATE statement is useful for restricting changes that violate business rules.

```
CREATE TRIGGER SAL_ADJ  
AFTER UPDATE OF SALARY ON EMPLOYEE  
REFERENCING OLD AS OLD_EMP  
  NEW AS NEW_EMP  
FOR EACH ROW MODE DB2SQL  
  WHEN (NEW_EMP.SALARY > (OLD_EMP.SALARY *1.20))
```

```
BEGIN ATOMIC  
  SIGNAL SQLSTATE '75001'('Invalid Salary Increase - Exceeds 20%');  
END
```

CREATE TYPE

The CREATE TYPE statement defines a user-defined data type at the current server.

The following types of user-defined data types can be defined:

- Array

A user-defined data type that is an ordinary array. The elements of an array type are based on one of the built-in data types. See [“CREATE TYPE \(array\)” on page 1179](#).

- Distinct

A user-defined data type that shares a common representation with one of the built-in data types. It can be defined to use strong type rules or weak type rules. Functions that cast between the user-defined distinct type and the source built-in data type are generated when a strongly typed distinct type is created. See [“CREATE TYPE \(distinct\)” on page 1184](#).

CREATE TYPE (array)

The CREATE TYPE (array) statement defines an array type at the current server.

Invocation

This statement can be embedded in an application program or issued interactively. It is an executable statement that can be dynamically prepared.

Authorization

The privileges held by the authorization ID of the statement must include at least one of the following:

- The privilege to create in the schema. For more information, see [Privileges necessary to create in a schema](#).
- Database administrator authority

The privileges held by the authorization ID of the statement must include at least one of the following:

- For the SYSTYPES catalog table:
 - The INSERT privilege on the table, and
 - The USAGE privilege on schema QSYS2
- Database administrator authority

If SQL names are specified and a user profile exists that has the same name as the library into which the array type is created, and that name is different from the authorization ID of the statement, then the privileges held by the authorization ID of the statement must include at least one of the following:

- The system authority *ADD to the user profile with that name
- Database administrator authority

For information about the system authorities corresponding to SQL privileges, see [Corresponding System Authorities When Checking Privileges to a Table or View](#).

Syntax

►► CREATE — TYPE — *array-type-name* — AS — *built-in-type* —►

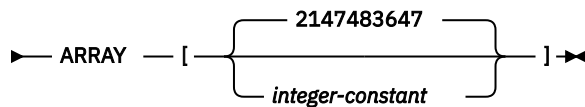

built-in-type

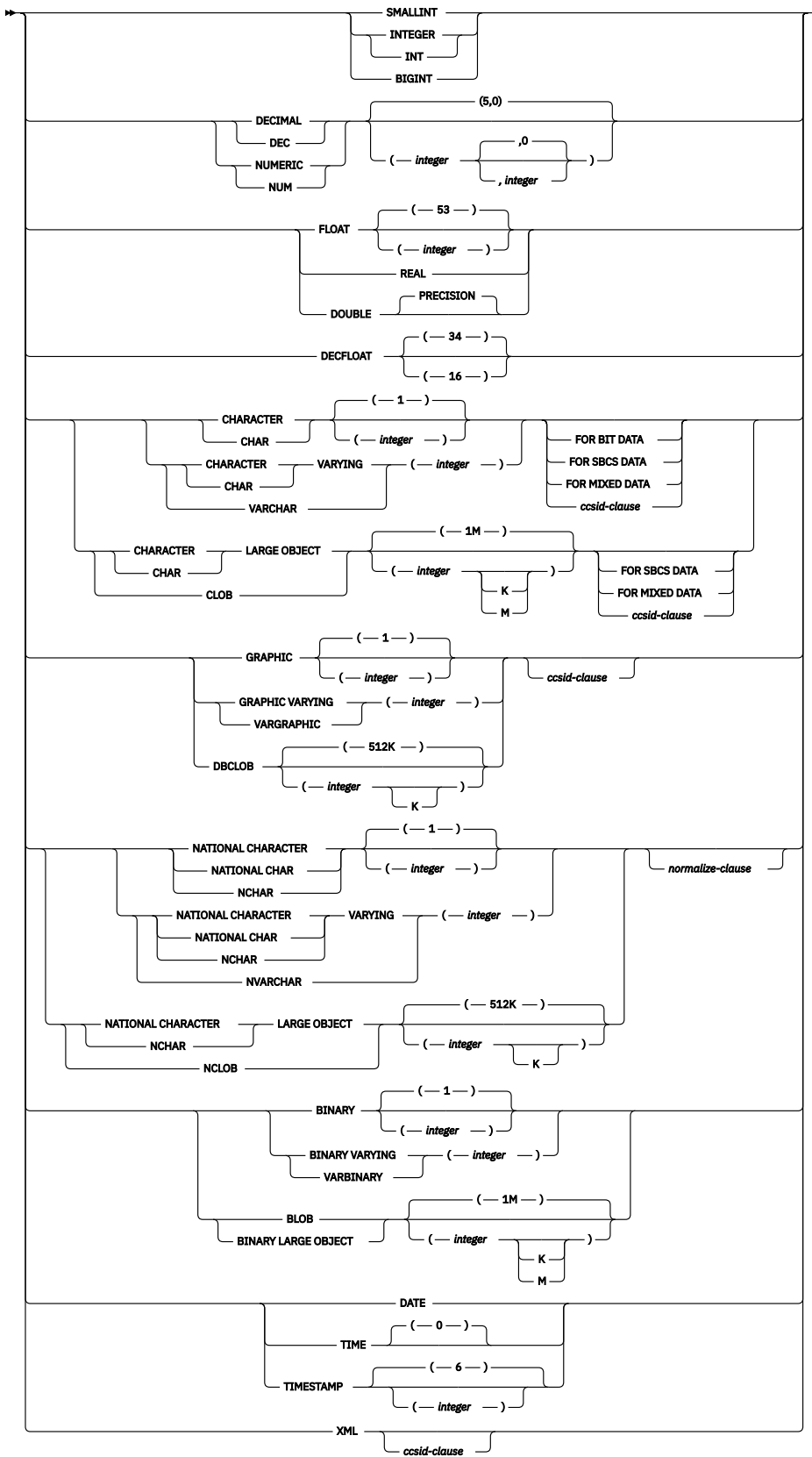

ccsid-clause

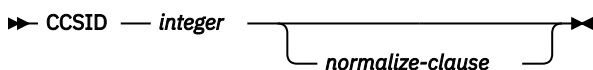

normalize-clause

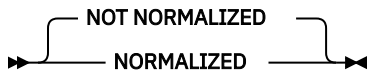

Description

array-type-name

Names the array. The name, including the implicit or explicit qualifier, must not be the same as a distinct type or array type that already exists at the current server.

If SQL names were specified, the array type will be created in the schema specified by the implicit or explicit qualifier.

If system names were specified, the array type will be created in the schema that is specified by the qualifier. If not qualified:

- If the value of the CURRENT SCHEMA special register is *LIBL, the array type will be created in the current library (*CURLIB).
- Otherwise, the array type will be created in the current schema.

If the array type name is not a valid system name, Db2 for i will generate a system name. For information about the rules for generating a name, see [“Rules for Table Name Generation”](#) on page 1157.

array-type-name must not be the name of a built-in data type, or any of the following system-reserved keywords even if you specify them as delimited identifiers.

=	<	>	>=
<=	<>	¬=	¬<
¬<	!=	!<	!>
ALL	FALSE	POSITION	XMLAGG
AND	FOR	RID	XMLATTRIBUTES
ANY	FROM	RRN	XMLCOMMENT
ARRAY_AGG	HASHED_VALUE	SELECT	XMLCONCAT
BETWEEN	IN	SIMILAR	XMLDOCUMENT
BOOLEAN	INTERVAL	SOME	XMLELEMENT
CASE	IS	STRIP	XMLFOREST
CAST	LIKE	SUBSTRING	XMLGROUP
CHECK	MATCH	TABLE	XMLNAMESPACES
DATAPARTITIONNAME	NODENAME	THEN	XMLPARSE
DATAPARTITIONNUM	NODENUMBER	TRIM	XMLPI
DBPARTITIONNAME	NOT	TRUE	XMLROW
DBPARTITIONNUM	NULL	TYPE	XMLSERIALIZE
DISTINCT	ONLY	UNIQUE	XMLTEXT
EXCEPT	OR	UNKNOWN	XMLVALIDATE
EXISTS	OVERLAPS	WHEN	XSLTRANSFORM
EXTRACT	PARTITION		

If a qualified *array-type-name* is specified, the schema name cannot be QSYS, QSYS2, QTEMP, or SYSIBM.

built-in-type

Specifies the built-in data type used as the data type for all the elements of the array. See [“CREATE TABLE” on page 1105](#) for a more complete description of each built-in data type.

If a specific value is not specified for the data types that have length, precision, or scale attributes, the default attributes of the data type as shown in the syntax diagram are implied.

If the array type is for a string data type, a CCSID is associated with the array type at the time the array type is created. For more information about data types, see [“CREATE TABLE” on page 1105](#).

ARRAY [*integer-constant*]

Specifies that the array has a maximum cardinality of *integer-constant*. The value must be a positive number greater than 0. If no value is specified, the maximum integer value of 2147483647 is used. The maximum number of array elements that can be assigned in the array is the number of elements that fit in 4 gigabytes. Each varying length, LOB, and XML array element is allocated as its maximum length.

Notes

Additional generated functions: Functions are created to convert to and from the array type, but service programs are not created, so you cannot grant or revoke privileges to these functions.

Names of the generated cast functions: The unqualified name of one of the cast functions ARRAY. The name of the cast function that converts to the array type is the name of the array type. The input parameter of the cast function has the same data type as the ARRAY.

For example, assume that an array type named T_SHOESIZES is created with the following statement:

```
CREATE TYPE CLAIRES.T_SHOESIZES AS INT ARRAY[]
```

When the statement is executed, the database manager also generates the following cast functions. ARRAY converts from the array type to an array, and T_SHOESIZES converts from an array to the array type.

A generated cast function cannot be explicitly dropped. The cast functions that are generated for an array type are implicitly dropped when the array type is dropped with the DROP statement.

Array type attributes: An array type is created as a *SQLUDT object.

Array type ownership: If SQL names were specified:

- If a user profile with the same name as the schema into which the array type is created exists, the *owner* of the array type is that user profile.
- Otherwise, the *owner* of the array type is the user profile or group user profile of the thread executing the statement.

If system names were specified, the *owner* of the array type is the user profile or group user profile of the thread executing the statement.

Array type authority: If SQL names are used, array types are created with the system authority of *EXCLUDE on *PUBLIC. If system names are used, array types are created with the authority to *PUBLIC as determined by the create authority (CRTAUT) parameter of the schema.

If the owner of the array type is a member of a group profile (GRPPRF keyword) and group authority is specified (GRPAUT keyword), that group profile will also have authority to the array type.

Examples

Example 1: Create an array type named PHONENUMBERS with a maximum of 5 elements that are of the DECIMAL(10,0) data type.

```
CREATE TYPE PHONENUMBERS AS DECIMAL(10,0) ARRAY[5]
```

Example 2: Create an array type named NUMBERS in the schema GENERIC for which the maximum number of elements is not known.

```
CREATE TYPE GENERIC.NUMBERS  
AS BIGINT ARRAY[]
```

CREATE TYPE (distinct)

The CREATE TYPE (distinct) statement defines a distinct type at the current server. A distinct type is always sourced on one of the built-in data types and can be defined to use strong type or weak type rules.

Successful execution of the statement for strong type rules also generates:

- A function to cast from the distinct type to its source type
- A function to cast from the source type to its distinct type
- As appropriate, support for the use of comparison operators with the distinct type.

Invocation

This statement can be embedded in an application program or issued interactively. It is an executable statement that can be dynamically prepared.

Authorization

The privileges held by the authorization ID of the statement must include at least one of the following:

- The privilege to create in the schema. For more information, see [Privileges necessary to create in a schema](#).
- Database administrator authority

The privileges held by the authorization ID of the statement must include at least one of the following:

- For the SYSTYPES catalog table:
 - The INSERT privilege on the table, and
 - The USAGE privilege on schema QSYS2
- Database administrator authority

If SQL names are specified and a user profile exists that has the same name as the library into which the distinct type is created, and that name is different from the authorization ID of the statement, then the privileges held by the authorization ID of the statement must include at least one of the following:

- The system authority *ADD to the user profile with that name
- Database administrator authority

For information about the system authorities corresponding to SQL privileges, see [Corresponding System Authorities When Checking Privileges to a Table or View](#).

Syntax

►► CREATE — TYPE — *distinct-type-name* — AS — *built-in-type* —►

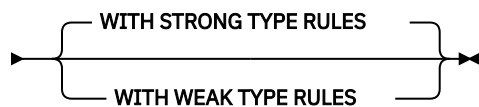

built-in-type

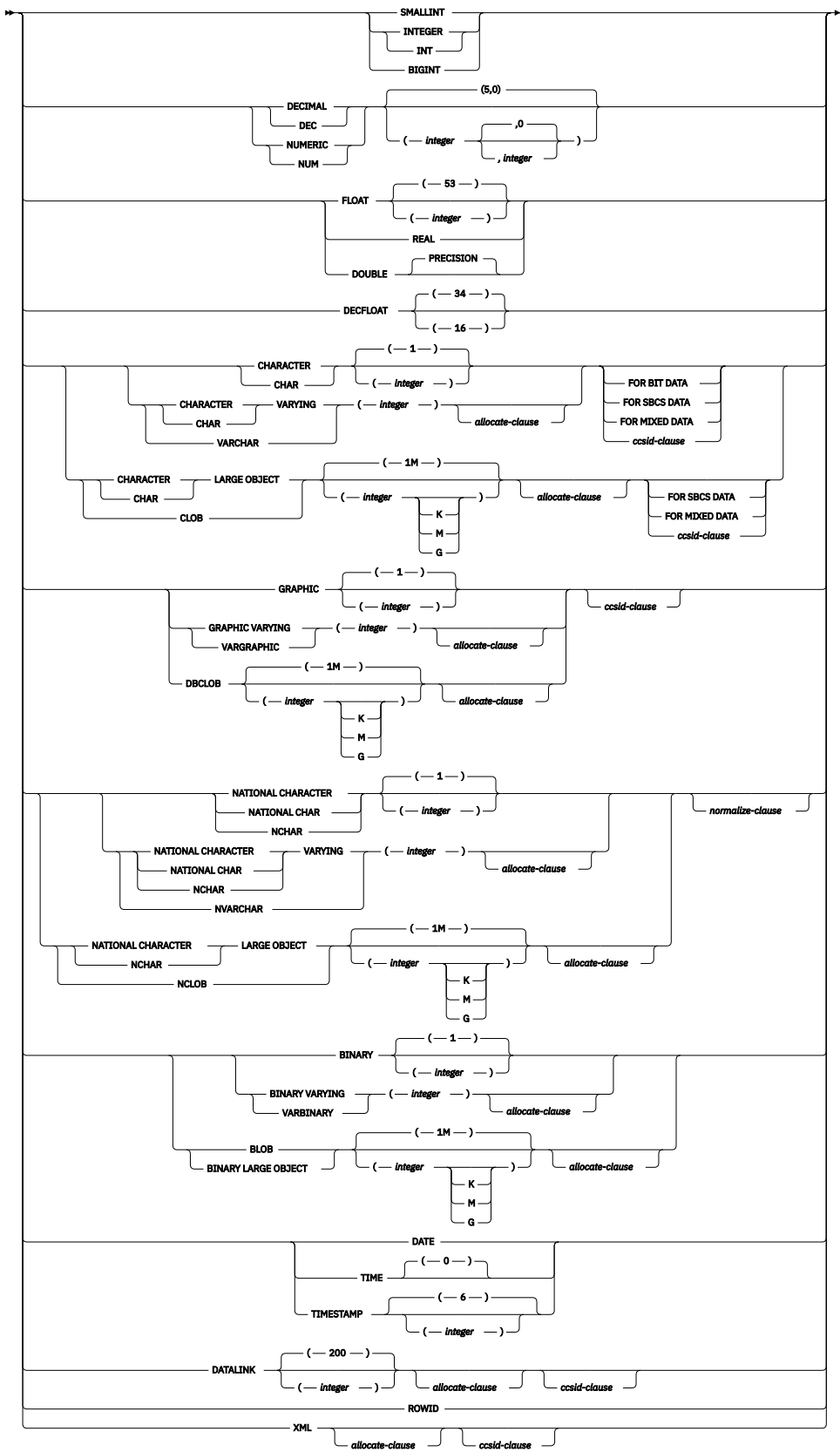

ccsid-clause



normalize-clause

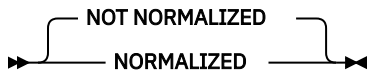

Description

distinct-type-name

Names the distinct type. The name, including the implicit or explicit qualifier, must not be the same as a distinct type or array type that already exists at the current server.

If SQL names were specified, the distinct type will be created in the schema specified by the implicit or explicit qualifier.

If system names were specified, the distinct type will be created in the schema that is specified by the qualifier. If not qualified:

- If the value of the CURRENT SCHEMA special register is *LIBL, the distinct type will be created in the current library (*CURLIB).
- Otherwise, the distinct type will be created in the current schema.

If the distinct type name is not a valid system name, Db2 for i will generate a system name. For information about the rules for generating a name, see [“Rules for Table Name Generation”](#) on page 1157.

distinct-type-name must not be the name of a built-in data type, or any of the following system-reserved keywords even if you specify them as delimited identifiers.

=	<	>	>=
<=	<>	¬=	¬<
¬<	!=	!<	!>
ALL	FALSE	POSITION	XMLAGG
AND	FOR	RID	XMLATTRIBUTES
ANY	FROM	RRN	XMLCOMMENT
ARRAY_AGG	HASHED_VALUE	SELECT	XMLCONCAT
BETWEEN	IN	SIMILAR	XMLDOCUMENT
BOOLEAN	INTERVAL	SOME	XMLELEMENT
CASE	IS	STRIP	XMLFOREST
CAST	LIKE	SUBSTRING	XMLGROUP
CHECK	MATCH	TABLE	XMLNAMESPACES
DATAPARTITIONNAME	NODENAME	THEN	XMLPARSE
DATAPARTITIONNUM	NODENUMBER	TRIM	XMLPI
DBPARTITIONNAME	NOT	TRUE	XMLROW
DBPARTITIONNUM	NULL	TYPE	XMLSERIALIZE
DISTINCT	ONLY	UNIQUE	XMLTEXT
EXCEPT	OR	UNKNOWN	XMLVALIDATE
EXISTS	OVERLAPS	WHEN	XSLTRANSFORM
EXTRACT	PARTITION		

If a qualified *distinct-type-name* is specified, the schema name cannot be QSYS, QSYS2, QTEMP, or SYSIBM.

built-in-type

Specifies the built-in data type used as the basis for the internal representation of the distinct type. See [“CREATE TABLE” on page 1105](#) for a more complete description of each built-in data type.

For portability of applications across platforms, use the following recommended data type names:

- DOUBLE or REAL instead of FLOAT.
- DECIMAL instead of NUMERIC.

If a specific value is not specified for the data types that have length, precision, or scale attributes, the default attributes of the data type as shown in the syntax diagram are implied.

If the distinct type is sourced on a string data type, a CCSID is associated with the distinct data type at the time the distinct type is created. For more information about data types, see [“CREATE TABLE” on page 1105](#).

WITH STRONG TYPE RULES

Specifies that strong typing rules are used for operations where this data type is an operand including assignments and comparisons. This is the default.

WITH WEAK TYPE RULES

Specifies that weak typing rules are used for operations where this data type is an operand including assignments, comparisons, and function resolution. When values of a weakly typed distinct type are used, the data type is effectively treated as the specified *built-in-type* when processing the operation.

Notes

Additional generated functions: When a strongly typed distinct type is created, the following functions are generated to convert to and from the source type:

- The distinct type to the source type
- The source type to the distinct type
- INTEGER to the distinct type if the source type is SMALLINT
- DOUBLE to the distinct type if the source type is REAL
- VARCHAR to the distinct type if the source type is CHAR
- VARGRAPHIC to the distinct type if the source type is GRAPHIC

These functions are created as if the following statements were executed (except that the service programs are not created, so you cannot grant or revoke privileges to these functions):

```
CREATE FUNCTION source-type-name (distinct-type-name)  
RETURNS source-type-name
```

```
CREATE FUNCTION distinct-type-name (source-type-name)  
RETURNS distinct-type-name
```

Names of the generated cast functions: [Table 86 on page 1188](#) contains details about the generated cast functions for strongly typed distinct types. The unqualified name of the cast function that converts from the distinct type to the source type is the name of the source data type.

In cases in which a length, precision, or scale is specified for the source data type in the CREATE TYPE statement, the unqualified name of the cast function that converts from the distinct type to the source type is simply the name of the source data type. The data type of the value that the cast function returns includes any length, precision, or scale values that were specified for the source data type on the CREATE TYPE statement.

The name of the cast function that converts from the source type to the distinct type is the name of the distinct type. The input parameter of the cast function has the same data type as the source data type, including the length, precision, and scale.

The cast functions that are generated are created in the same schema as that of the distinct type. A function with the same name and same function signature must not already exist in the current server.

For example, assume that a distinct type named T_SHOESIZE is created with the following statement:

```
CREATE TYPE CLAIRES.T_SHOESIZE AS VARCHAR(2) WITH COMPARISONS
```

When the statement is executed, the database manager also generates the following cast functions. VARCHAR converts from the distinct type to the source type, and T_SHOESIZE converts from the source type to the distinct type.

```
FUNCTION CLAIRES.VARCHAR (CLAIRES.T_SHOESIZE) RETURNS VARCHAR(2)
```

```
FUNCTION CLAIRES.T_SHOESIZE (VARCHAR(2)) RETURNS CLAIRES.T_SHOESIZE
```

Notice that function VARCHAR returns a value with a data type of VARCHAR(2) and that function T_SHOESIZE has an input parameter with a data type of VARCHAR(2).

A generated cast function cannot be explicitly dropped. The cast functions that are generated for a distinct type are implicitly dropped when the distinct type is dropped with the DROP statement.

For each built-in data type that can be the source data type for a strongly typed distinct type, the following table gives the names of the generated cast functions, the data types of the input parameters, and the data types of the values that the functions returns.

<i>Table 86. CAST Functions on Strongly Typed Distinct Types</i>			
Source Type Name	Function Name	Parameter Type	Return Type
SMALLINT	<i>distinct-type-name</i>	SMALLINT	<i>distinct-type-name</i>
	<i>distinct-type-name</i>	INTEGER	<i>distinct-type-name</i>
INTEGER	SMALLINT	<i>distinct-type-name</i>	SMALLINT
	<i>distinct-type-name</i>	INTEGER	<i>distinct-type-name</i>
BIGINT	INTEGER	<i>distinct-type-name</i>	INTEGER
	<i>distinct-type-name</i>	INTEGER	INTEGER
DECIMAL	<i>distinct-type-name</i>	BIGINT	<i>distinct-type-name</i>
	<i>distinct-type-name</i>	BIGINT	BIGINT
NUMERIC	<i>distinct-type-name</i>	DECIMAL(p,s)	<i>distinct-type-name</i>
	<i>distinct-type-name</i>	DECIMAL	DECIMAL(p,s)
REAL or FLOAT(n) where n <= 24	<i>distinct-type-name</i>	NUMERIC(p,s)	<i>distinct-type-name</i>
	<i>distinct-type-name</i>	NUMERIC	NUMERIC(p,s)
DOUBLE or DOUBLE PRECISION or FLOAT(n) where n > 24	<i>distinct-type-name</i>	REAL	<i>distinct-type-name</i>
	<i>distinct-type-name</i>	DOUBLE	<i>distinct-type-name</i>
	REAL	<i>distinct-type-name</i>	REAL
DECFLOAT	DOUBLE	<i>distinct-type-name</i>	DOUBLE
	<i>distinct-type-name</i>	DOUBLE	<i>distinct-type-name</i>
CHAR	<i>distinct-type-name</i>	DECFLOAT(n)	<i>distinct-type-name</i>
	<i>distinct-type-name</i>	DECFLOAT	DECFLOAT(n)
CHAR	<i>distinct-type-name</i>	CHAR(n)	<i>distinct-type-name</i>
	<i>distinct-type-name</i>	CHAR	CHAR(n)

Table 86. CAST Functions on Strongly Typed Distinct Types (continued)

Source Type Name	Function Name	Parameter Type	Return Type
	<i>distinct-type-name</i>	VARCHAR(n)	<i>distinct-type-name</i>
VARCHAR	<i>distinct-type-name</i>	VARCHAR(n)	<i>distinct-type-name</i>
	VARCHAR	<i>distinct-type-name</i>	VARCHAR(n)
CLOB	<i>distinct-type-name</i>	CLOB(n)	<i>distinct-type-name</i>
	CLOB	<i>distinct-type-name</i>	CLOB(n)
GRAPHIC	<i>distinct-type-name</i>	GRAPHIC(n)	<i>distinct-type-name</i>
	GRAPHIC	<i>distinct-type-name</i>	GRAPHIC(n)
	<i>distinct-type-name</i>	VARGRAPHIC(n)	<i>distinct-type-name</i>
VARGRAPHIC	<i>distinct-type-name</i>	VARGRAPHIC(n)	<i>distinct-type-name</i>
	VARGRAPHIC	<i>distinct-type-name</i>	VARGRAPHIC(n)
DBCLOB	<i>distinct-type-name</i>	DBCLOB(n)	<i>distinct-type-name</i>
	DBCLOB	<i>distinct-type-name</i>	DBCLOB(n)
BINARY	<i>distinct-type-name</i>	BINARY(n)	<i>distinct-type-name</i>
	BINARY	<i>distinct-type-name</i>	BINARY(n)
	<i>distinct-type-name</i>	VARBINARY(n)	<i>distinct-type-name</i>
VARBINARY	<i>distinct-type-name</i>	VARBINARY(n)	<i>distinct-type-name</i>
	VARBINARY	<i>distinct-type-name</i>	VARBINARY(n)
BLOB	<i>distinct-type-name</i>	BLOB(n)	<i>distinct-type-name</i>
	BLOB	<i>distinct-type-name</i>	BLOB(n)
DATE	<i>distinct-type-name</i>	DATE	<i>distinct-type-name</i>
	DATE	<i>distinct-type-name</i>	DATE
TIME	<i>distinct-type-name</i>	TIME	<i>distinct-type-name</i>
	TIME	<i>distinct-type-name</i>	TIME
TIMESTAMP	<i>distinct-type-name</i>	TIMESTAMP(p)	<i>distinct-type-name</i>
	TIMESTAMP	<i>distinct-type-name</i>	TIMESTAMP(p)
DATALINK	<i>distinct-type-name</i>	DATALINK	<i>distinct-type-name</i>
	DATALINK	<i>distinct-type-name</i>	DATALINK
ROWID	<i>distinct-type-name</i>	ROWID	<i>distinct-type-name</i>
	ROWID	<i>distinct-type-name</i>	ROWID

NUMERIC and FLOAT are not recommended when creating a distinct type for a portable application. DECIMAL and DOUBLE should be used instead.

Built-in functions: The functions described in the above table are the only functions that are generated automatically when a strongly typed distinct type is defined. Consequently, none of the built-in functions (AVG, MAX, LENGTH, and so on) are automatically supported for the strongly typed distinct type. A built-in function can be used on a strongly typed distinct type only after a sourced user-defined function, which is

based on the built-in function, has been created for the distinct type. See [“Extending or overriding a built-in function:”](#) on page 968.

The schema name of the distinct type must be included in the distinct type for successful use of these operators and cast functions in SQL statements.

Distinct type attributes: A distinct type is created as a *SQLUDT object.

Distinct type ownership: If SQL names were specified:

- If a user profile with the same name as the schema into which the distinct type is created exists, the *owner* of the distinct type is that user profile.
- Otherwise, the *owner* of the distinct type is the user profile or group user profile of the thread executing the statement.

If system names were specified, the *owner* of the distinct type is the user profile or group user profile of the thread executing the statement.

Distinct type authority: If SQL names are used, distinct types are created with the system authority of *EXCLUDE on *PUBLIC. If system names are used, distinct types are created with the authority to *PUBLIC as determined by the create authority (CRTAUT) parameter of the schema.

If the owner of the distinct type is a member of a group profile (GRPPRF keyword) and group authority is specified (GRPAUT keyword), that group profile will also have authority to the distinct type.

Syntax alternatives: The WITH COMPARISONS clause, which specifies that system-generated comparison operators are to be created for comparing two instances of the distinct type, can be specified as the last clause of the statement if WITH WEAK TYPE RULES is not specified. Use WITH COMPARISONS only if it is required for compatibility with other products in the Db2 family.

For compatibility with previous versions of Db2:

- CREATE DISTINCT TYPE can be specified in place of CREATE TYPE.

Examples

Example 1: Create a strongly typed distinct type named SHOESIZE that is sourced on the built-in INTEGER data type.

```
CREATE TYPE SHOESIZE AS INTEGER WITH COMPARISONS
```

The successful execution of this statement also generates two cast functions. Function INTEGER(SHOESIZE) returns a value with data type INTEGER, and function SHOESIZE(INTEGER) returns a value with distinct type SHOESIZE.

Example 2: Create a strongly typed distinct type named MILES that is sourced on the built-in DOUBLE data type.

```
CREATE TYPE MILES  
AS DOUBLE
```

The successful execution of this statement also generates two cast functions. Function DOUBLE(MILES) returns a value with data type DOUBLE, and function MILES(DOUBLE) returns a value with distinct type MILES.

Example 3: Create a strongly typed distinct type T_DEPARTMENT that is sourced on the built-in CHAR data type.

```
CREATE TYPE CLAIRES.T_DEPARTMENT AS CHAR(3)
```

The successful execution of this statement also generates three cast functions:

- Function CLAIRE.CHAR takes a T_DEPARTMENT as input and returns a value with data type CHAR(3).
- Function CLAIRE.T_DEPARTMENT takes a CHAR(3) as input and returns a value with distinct type T_DEPARTMENT.

- Function CLAIRES.T_DEPARTMENT takes a VARCHAR(3) as input and returns a value with distinct type T_DEPARTMENT.

Example 4: Create a weakly typed distinct type named BONUS that is based on an INTEGER data type.

```
CREATE TYPE BONUS AS INTEGER WITH WEAK TYPE RULES
```

Because it is defined with weak type rules, cast functions are not generated for the weakly typed distinct type called BONUS.

CREATE VARIABLE

The CREATE VARIABLE statement defines a global variable at the application server.

Invocation

This statement can be embedded in an application program or issued interactively. It is an executable statement that can be dynamically prepared.

Authorization

The privileges held by the authorization ID of the statement must include at least one of the following:

- The privilege to create in the schema. For more information, see [Privileges necessary to create in a schema](#).
- Database administrator authority

The privileges held by the authorization ID of the statement must include at least one of the following:

- For the SYSVARIABLES catalog table:
 - The INSERT privilege on the table, and
 - The USAGE privilege on schema QSYS2
- Database administrator authority

If a distinct type or sequence is referenced, the privileges held by the authorization ID of the statement must include at least one of the following:

- For the distinct type or sequence identified in the statement:
 - The USAGE privilege on the distinct type or sequence, and
 - The USAGE privilege on the schema containing the distinct type or sequence
- Database administrator authority

If a function is referenced, the privileges held by the authorization ID of the statement must include at least one of the following:

- For the function identified in the statement:
 - The EXECUTE privilege on the function, and
 - The USAGE privilege on the schema containing the function
- Database administrator authority

If a global variable is referenced, the privileges held by the authorization ID of the statement must include at least one of the following:

- For the global variable identified in the statement:
 - The READ privilege on the global variable, and
 - The USAGE privilege on the schema containing the global variable
- Database administrator authority

If a table or view is referenced directly or indirectly, the privileges held by the authorization ID of the statement must include at least one of the following:

- For each table and view referenced directly or indirectly:
 - The SELECT privilege on the table or view, and
 - The USAGE privilege on the schema containing the table or view
- Database administrator authority

To replace an existing variable, the privileges held by the authorization ID of the statement must include at least one of the following:

- The following system authorities:
 - The system authority of *OBJMGT on the service program for the variable
 - All authorities needed to DROP the variable
 - The system authority *READ to the SYSVARIABLES catalog table
- Database administrator authority

For information about the system authorities corresponding to SQL privileges, see [Corresponding System Authorities When Checking Privileges to a Sequence](#) and [Corresponding System Authorities When Checking Privileges to a Distinct Type](#).

Syntax

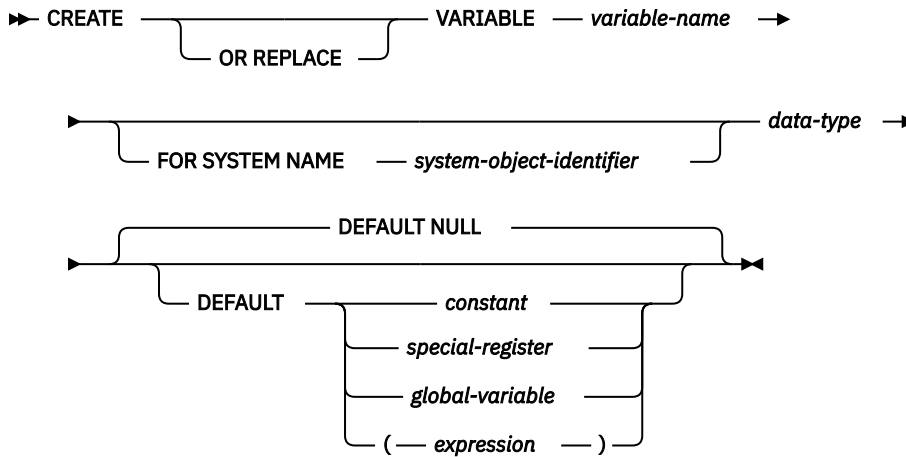

data-type

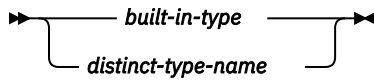

built-in-type

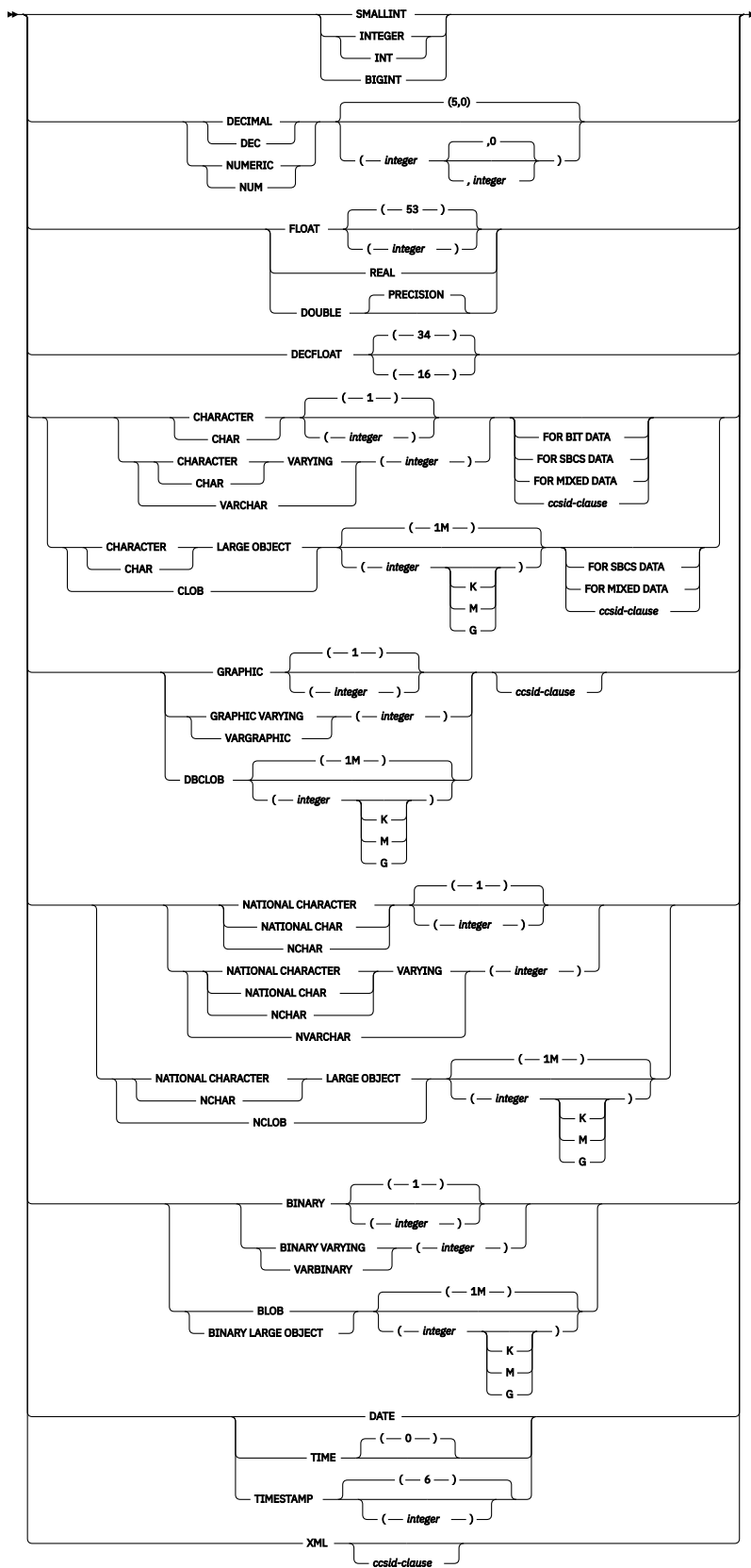

ccsid-clause

➤ CCSID — *integer* ➤

Description

OR REPLACE

Specifies to replace the definition for the variable if one exists at the current server. The existing definition is effectively dropped before the new definition is replaced in the catalog with the exception that privileges that were granted on the variable are not affected. This option is ignored if a definition for the variable does not exist at the current server.

variable-name

Names the global variable. The name, including the implicit or explicit qualifier, must not identify a global variable that already exists at the current server. If a qualified variable name is specified, the *schema-name* cannot be QSYS2, QSYS, QTEMP, or SYSIBM.

If SQL names were specified, the variable will be created in the schema specified by the implicit or explicit qualifier.

If system names were specified, the variable will be created in the schema that is specified by the qualifier. If not qualified:

- If the value of the CURRENT SCHEMA special register is *LIBL, the variable will be created in the current library (*CURLIB).
- Otherwise, the variable will be created in the current schema.

FOR SYSTEM NAME *system-object-identifier*

Identifies the *system-object-identifier* of the global variable. *system-object-identifier* must not be the same as a global variable that already exists at the current server. The *system-object-identifier* must be an unqualified system identifier.

When *system-object-identifier* is specified, *variable-name* must not be a valid system object name.

data-type

Specifies the data type of the global variable.

built-in-type

Specifies a built-in data type. See [“CREATE TABLE” on page 1105](#) for a more complete description of each built-in data type.

distinct-type-name

Specifies a distinct type. The length, precision, and scale of the global variable are, respectively, and length, precision, and scale of the distinct type. If a distinct type name is specified without a schema name, the distinct type name is resolved by searching the schemas on the SQL path. The same limitations that apply to built-in types apply to the source type of the distinct type.

DEFAULT

Specifies a default value for the global variable. The value can be a constant, a special register, a global variable, an expression, or the keyword NULL. The default value is determined on its first reference if a value is not explicitly specified. If a default value is not specified, the variable is initialized to the null value.

The default expression must not modify SQL data or perform an external action. The expression must be assignment compatible with the data type of the variable.

All tables, views, aliases, distinct types, sequences, global variables, and user-defined functions referenced in the default expression must exist at the current server when the global variable is created. The table or view that an alias refers to must also exist when the variable is created. This includes objects in library QTEMP. While objects in QTEMP can be referenced in the default expression, dropping those objects in QTEMP will not cause the global variable to be dropped.

Notes

Session scope: Global variables have a session scope. This means that although they are available to all sessions that are active on the database, their value is private for each session.

Modifications to the value of a global variable: Modifications to the value of a global variable are not under transaction control. The value of the global variable is preserved when a transaction ends with either a COMMIT or a ROLLBACK statement.

Privileges to use a global variable: An attempt to read from or to write to a global variable created by this statement requires that the authorization ID attempting this action hold the appropriate privilege on the global variable. The definer of the variable is implicitly granted all privileges on the variable.

Setting of the default value: A created global variable is instantiated to its default value when it is first referenced within its given scope. Note that if a global variable is referenced in a statement, it is instantiated independently of the control flow for that statement.

Using a newly created session global variable: If a global variable is created within a session, it cannot be used by other sessions until the unit of work has been committed. However, the new global variable can be used within the session that created the variable before the unit of work commits.

Once a global variable is instantiated for a session, changes to the global variable in another session (such as DROP or GRANT) might not affect the variable that has been instantiated.

Creating the global variable: A global variable is created as a *SRVPGM object. If the variable name is a valid system name but a *SRVPGM already exists with that name, an error is issued. If the variable name is not a valid system name, a unique name is generated using the rules for generating system table names. For information about the rules for generating a name, see [“Rules for Table Name Generation” on page 1157](#).

The global variable's definition is saved in the associated service program object. If the *SRVPGM object is saved and then restored to this or another system, the catalogs are automatically updated with the definition.

During restore of the global variable:

- If a *SRVPGM object with the same system name exists, the *SRVPGM will be replaced.

If a global variable and an SQL routine have the same name, naming conflicts can be avoided by creating the global variable first.

Variable ownership: The *owner* of the variable is the user profile or group user profile of the thread executing the statement.

Variable authority: If SQL names are used, variables are created with the system authority of *EXCLUDE on *PUBLIC. If system names are used, variables are created with the authority to *PUBLIC as determined by the create authority (CRTAUT) parameter of the schema.

If the owner of the variable is a member of a group profile (GRPPRF keyword) and group authority is specified (GRPAUT keyword), that group profile will also have authority to the variable.

Variable instantiation authorization: When a global variable is instantiated, the DEFAULT clause is evaluated using the authority of the owner of the global variable.

REPLACE rules: When a variable is recreated by REPLACE:

- Any existing comment or label is discarded.
- Authorized users are maintained. The object owner could change.
- Current journal auditing is preserved.

Examples

Example 1: Create a global variable to indicate what printer to use for the session.

```
CREATE VARIABLE MYSCHEMA.MYJOB_PRINTER VARCHAR(30)
  DEFAULT 'Default printer'
```

Example 2: Create a global variable to indicate the department where an employee works.

```
CREATE VARIABLE SCHEMA1.GV_DEPTNO INTEGER  
DEFAULT ((SELECT DEPTNO FROM HR.EMPLOYEES  
          WHERE EMPUSER = SESSION_USER))
```

Example 3: Create a global variable to indicate the security level of the current user.

```
CREATE VARIABLE SCHEMA2.GV_SECURITY_LEVEL INTEGER  
DEFAULT ( GET_SECURITY_LEVEL ( SESSION_USER))
```

CREATE VIEW

The CREATE VIEW statement creates a view on one or more tables or views at the current server.

Invocation

This statement can be embedded in an application program or issued interactively. It is an executable statement that can be dynamically prepared.

Authorization

The privileges held by the authorization ID of the statement must include at least one of the following:

- The privilege to create in the schema. For more information, see [Privileges necessary to create in a schema](#).
- Database administrator authority

The privileges held by the authorization ID of the statement must include at least one of the following:

- The following system authorities:
 - *USE to the Create Logical File (CRTLF) CL command
 - *CHANGE to the data dictionary if the library into which the view is created is an SQL schema with a data dictionary
- Database administrator authority

The privileges held by the authorization ID of the statement must also include at least one of the following:

- For each table and view referenced directly through the fullselect, or indirectly through views referenced in the fullselect:
 - The SELECT privilege on the table or view, and
 - The USAGE privilege on the schema containing the table or view
- Database administrator authority

To replace an existing view, the privileges held by the authorization ID of the statement must include at least one of the following:

- The following system authorities:
 - The system authority of *OBJMGT on the view
 - All authorities needed to DROP the view
- Database administrator authority

For information about the system authorities corresponding to SQL privileges, see [Corresponding System Authorities When Checking Privileges to a Table or View](#) and [Corresponding System Authorities When Checking Privileges to a Distinct Type](#).

Syntax

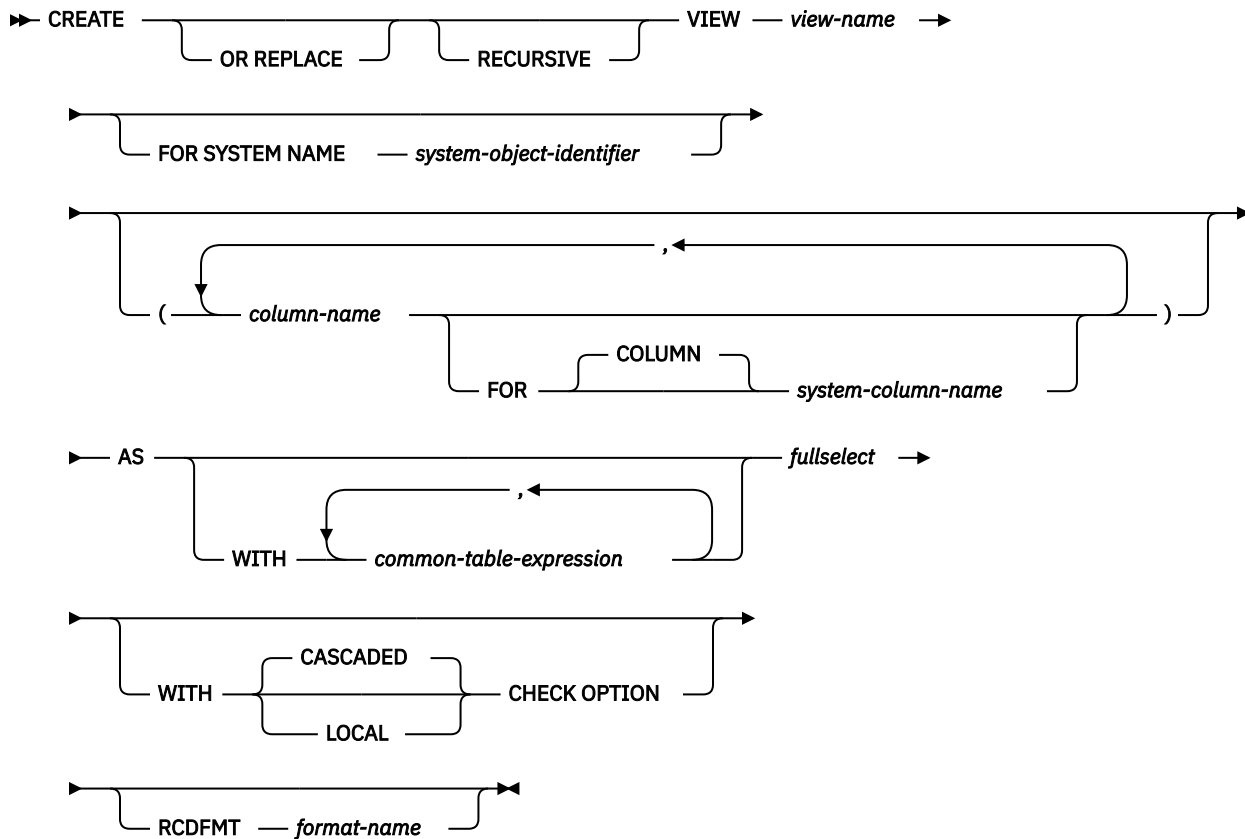

Description

OR REPLACE

Specifies to replace the definition for the view if one exists at the current server. The existing definition is effectively dropped before the new definition is replaced in the catalog with the exception that privileges that were granted on the view are not affected. The existing object cannot be a logical file. This option is ignored if a definition for the view does not exist at the current server.

RECURSIVE

Indicates that the view is potentially recursive.

If a *fullselect* of the view contains a reference to the view itself in a FROM clause, the view is a *recursive view*. Views using recursion are useful in supporting applications such as bill of materials (BOM), reservation systems, and network planning.

The restrictions that apply to a recursive *view* are similar to those for a recursive common table expression:

- A list of *column-names* must be specified following the *view-name* unless the result columns of the *fullselect* are already named.
- The UNION ALL set operator must be specified.
- The first *fullselect* of the first union (the initialization *fullselect*) must not include a reference to the *view* itself in any FROM clause.
- Each *fullselect* that is part of the recursion cycle must not include any aggregate functions, GROUP BY clauses, or HAVING clauses.
- The FROM clauses of each *fullselect* can include at most one reference to the view that is part of a recursion cycle.

- The table being defined in the *common-table-expression* cannot be referenced in a subquery of a fullselect that defines the *common-table-expression*.
- LEFT OUTER JOIN and FULL OUTER JOIN are not allowed if the *common-table-expression* is the right operand. RIGHT OUTER JOIN and FULL OUTER JOIN are not allowed if the *common-table-expression* is the left operand.

If a column name of the view is referred to in the iterative fullselect, the attributes of the result columns are determined using the rules for result columns. For more information see [“Rules for result data types” on page 107](#).

Recursive views are not allowed if the query specifies:

- a distributed table,
- a table with a read trigger,
- a table referenced directly or indirectly in the fullselect must not be a DDS-created logical file, or
- a logical file built over multiple physical file members.

view-name

Names the view. The name, including the implicit or explicit qualifier, must not be the same as an alias, file, index, table, or view that already exists at the current server.

If SQL names were specified, the view will be created in the schema specified by the implicit or explicit qualifier.

If system names were specified, the view will be created in the schema that is specified by the qualifier. If not qualified and there is no default schema, the view name will be created in the same schema as the first table specified on the first FROM clause (including FROM clauses in any common table expressions or nested table expression). If no tables are referenced in the fullselect, the view will be created in the same schema as the first user defined table function. If no table or user defined table function is referenced in the fullselect, the current library (*CURLIB) will be used.

If a view name is not a valid system name and the FOR SYSTEM NAME clause is not used, Db2 for i will generate a system name. For information about the rules for generating the name, see [“Rules for Table Name Generation” on page 1157](#).

FOR SYSTEM NAME system-object-identifier

Identifies the *system-object-identifier* of the view. *system-object-identifier* must not be the same as a table, view, alias, or index that already exists at the current server. The *system-object-identifier* must be an unqualified system identifier.

When *system-object-identifier* is specified, *view-name* must not be a valid system object name.

(column-name, ...)

Names the columns in the view. If a list of column names is specified, it must consist of as many names as there are columns in the result table of the fullselect. Each *column-name* and *system-column-name* must be unique and unqualified. If a list of column names is not specified, the columns of the view inherit the names of the columns and system names of the columns of the result table of the *fullselect*.

A list of column names (and system column names) must be specified if the result table of the subselect has duplicate column names, duplicate system column names, or an unnamed column. For more information about unnamed columns, see [“Names of result columns” on page 728](#).

FOR COLUMN system-column-name

Provides an IBM i name for the column. Do not use the same name for more than one column of the view or for a column-name of the view.

If the system-column-name is not specified, and the column-name is not a valid system-column-name, a system column name is generated. For more information about how system column names are generated, see [“Rules for Column Name Generation” on page 1156](#).

AS

Defines the view.

WITH common-table-expression

Defines a common table expression for use with the fullselect that follows. For an explanation of common table expression, see [“common-table-expression” on page 778](#).

fullselect

Defines the view. At any time, the view consists of the rows that would result if the fullselect were executed.

fullselect must not reference variables, but may reference global variables.

The maximum number of columns allowed in a view is 8000. The column name lengths and the length of the WHERE clause also reduce this number. The maximum number of base tables allowed in the view is 256.

For an explanation of *fullselect*, see [“fullselect” on page 771](#).

common-table-expression defines a common table expression for use with the *fullselect* that follows. For more information see [“common-table-expression” on page 778](#).

A declared temporary table must not be referenced in the *fullselect* unless the view is created in schema QTEMP.

The ORDER BY, FETCH, and OFFSET clauses may not be specified in the outer *fullselect* of the view.

WITH CASCADED CHECK OPTION or WITH LOCAL CHECK OPTION

Specifies that every row that is inserted or updated through the view must conform to the definition of the view. A row that does not conform to the definition of the view is a row that cannot be retrieved using that view.

CHECK OPTION must not be specified if:

- the view is read-only
- the definition of the view includes a subquery other than a scalar fullselect in the outer select list of the view
- the definition of the view contains a non-deterministic, MODIFIES SQL DATA, or EXTERNAL ACTION function in other than the outer select list of the view
- the definition of the view contains a special register in other than the outer select list of the view
- the view references another view and that view has an INSTEAD OF trigger
- the view is recursive

If CHECK OPTION is specified for an updatable view that does not allow inserts, then the check option applies to updates only.

If CHECK OPTION is omitted, the definition of the view is not used in the checking of any insert or update operations that use the view. Some checking might still occur during insert or update operations if the view is directly or indirectly dependent on another view that includes a CHECK OPTION. Because the definition of the view is not used, rows that do not conform to the definition of the view might be inserted or updated through the view.

The difference between the two forms of the CHECK OPTION clause, CASCADED and LOCAL, is meaningful only when a view is dependent on another view. The default is CASCADED. The view upon which another view is directly or indirectly defined is an *underlying view*.

CASCADED

The WITH CASCADED CHECK OPTION on a view V is inherited by any updatable view that is directly or indirectly dependent on V. Thus, if an updatable view is defined on V, the check option on V also applies to that view, even if WITH CHECK OPTION is not specified on that view. For example, consider the following updatable views:

```
CREATE VIEW V1 AS SELECT COL1 FROM T1 WHERE COL1 > 10
CREATE VIEW V2 AS SELECT COL1 FROM V1 WITH CHECK OPTION
CREATE VIEW V3 AS SELECT COL1 FROM V2 WHERE COL1 < 100
```

SQL statement	Description of result
INSERT INTO V1 VALUES(5)	Succeeds because V1 does not have a CHECK OPTION clause and it is not dependent on any other view that has a CHECK OPTION clause.
INSERT INTO V2 VALUES(5)	Results in an error because the inserted row does not conform to the search condition of V1 which is implicitly part of the definition of V2.
INSERT INTO V3 VALUES(5)	Results in an error because V3 is dependent on V2 which has a CHECK OPTION clause and the inserted row does not conform to the definition of V2.
INSERT INTO V3 VALUES(200)	Succeeds even though it does not conform to the definition of V3 (V3 does not have the view CHECK OPTION clause specified); it does conform to the definition of V2 (which does have the view CHECK OPTION clause specified).

LOCAL

WITH LOCAL CHECK OPTION is identical to WITH CASCADED CHECK OPTION except that it is still possible to update a row so that it no longer conforms to the definition of the view when the view is defined with the WITH LOCAL CHECK OPTION. This can only happen when the view is directly or indirectly dependent on a view that was defined without either WITH CASCADED CHECK OPTION or WITH LOCAL CHECK OPTION clauses.

WITH LOCAL CHECK OPTION specifies that the search conditions of the following underlying views are checked when a row is inserted or updated:

- views that specify WITH LOCAL CHECK OPTION
- views that specify WITH CASCADED CHECK OPTION
- all underlying views of a view that specifies WITH CASCADED CHECK OPTION

In contrast, WITH CASCADED CHECK OPTION specifies that the search conditions of all underlying views are checked when a row is inserted or updated.

The difference between CASCADED and LOCAL is best shown by example. Consider the following updatable views where x and y represent either LOCAL or CASCADED:

```
V1 defined on table T0
V2 defined on V1 WITH x CHECK OPTION
V3 defined on V2
V4 defined on V3 WITH y CHECK OPTION
V5 defined on V4
```

The following table describes which views search conditions are checked during an INSERT or UPDATE operation:

View used in INSERT or UPDATE	x = LOCAL y = LOCAL	x = CASCADED y = CASCADED	x = LOCAL y = CASCADED	x = CASCADED y = LOCAL
V1	none	none	none	none
V2	V2	V2 V1	V2	V2 V1
V3	V2	V2 V1	V2	V2 V1
V4	V4 V2	V4 V3 V2 V1	V4 V3 V2 V1	V4 V2 V1
V5	V4 V2	V4 V3 V2 V1	V4 V3 V2 V1	V4 V2 V1

RCDFMT *format-name*

An unqualified name that designates the IBM i record format name of the view. A *format-name* is a system identifier.

If a record format name is not specified, the *format-name* is the same as the *system-object-name* of the view.

Notes

View ownership: If SQL names were specified:

- If a user profile with the same name as the schema into which the view is created exists, the *owner* of the view is that user profile.
- Otherwise, the *owner* of the view is the user profile or group user profile of the thread executing the statement.

If system names were specified, the *owner* of the view is the user profile or group user profile of the thread executing the statement.

View authority: If SQL names are used, views are created with the system authority of *EXCLUDE on *PUBLIC. If system names are used, views are created with the authority to *PUBLIC as determined by the create authority (CRTAUT) parameter of the schema.

If the owner of the view is a member of a group profile (GRPPRF keyword) and group authority is specified (GRPAUT keyword), that group profile will also have authority to the view.

The owner always acquires the SELECT privilege WITH GRANT OPTION on the view and the authorization to drop the view.

The owner can also acquire the INSERT, UPDATE, and DELETE privileges on the view. If the view is not read-only, then the same privileges will be acquired on the new view as the owner has on the table or view identified in the first FROM clause of the fullselect. These privileges can be granted only if the privileges from which they are derived can also be granted.

REPLACE rules: When a view is recreated by REPLACE:

- Any existing comment or label is discarded.
- Authorized users are maintained. The object owner could change.
- Current journal auditing is preserved. However, unlike other objects, REPLACE of a view will generate a ZC (change object) journal audit entry.
- Any INSTEAD OF triggers defined for the view are dropped (any triggers that reference the view are not dropped).
- Any views and materialized query tables dependent on the view will be recreated, if possible. If it is not possible to recreate a dependent view or materialized query table, an error is returned.

Deletable views: A view is *deletable* if an INSTEAD OF trigger for the delete operation has been defined for the view, or if all of the following are true:

- The outer fullselect identifies only one base table or deletable view that is not a catalog table or view. It cannot be a nested table expression, table function, or a table with a FOR SYSTEM_TIME clause.
- The outer fullselect does not include a VALUES clause.
- The outer fullselect does not include a GROUP BY clause or HAVING clause.
- The outer fullselect does not include aggregate functions in the select list.
- The outer fullselect does not include a UNION, UNION ALL, EXCEPT, or INTERSECT operator.
- The outer fullselect does not include the DISTINCT clause.

Updatable views: A view is *updatable* if an INSTEAD OF trigger for the update operation has been defined for the view, or if all of the following are true:

- independent of an INSTEAD OF trigger for delete, the view is deletable

- at least one column of the view is updatable.

A column of a view is *updatable* if an INSTEAD OF trigger for the update operation has been defined for the view, or if the corresponding result column of the *subselect* is derived solely from a column of a table or an updatable column of another view (that is, it is not derived from an expression that contains an operator, scalar function, constant, or a column that itself is derived from such expressions).

Insertable views: A view is *insertable* if an INSTEAD OF trigger has been defined for the view, or if at least one column of the view is updatable.

Read-only views: A view is *read-only* if it is not deletable.

A read-only view cannot be the object of an INSERT, UPDATE, or DELETE statement.

Special registers for temporal support: The value of the CURRENT TEMPORAL SYSTEM_TIME special register has no impact on the query expression that defines a view while it is being defined. When a view is used in an SQL statement, the value of the CURRENT TEMPORAL SYSTEM_TIME special register for the session processing the SQL statement is applied to the view if the value of the SYSTIME option is YES.

Unqualified table names: If the CREATE VIEW statement refers to an unqualified table name, the following rules are applied to determine which table is actually being referenced:

- If the unqualified name corresponds to one or more common table expression *table-identifiers* that are specified in the *fullselect*, the name identifies the common table expression that is in the innermost scope.
- Otherwise, the name identifies a persistent table, a temporary table, or a view that is present in the default schema.

Considerations for implicitly hidden columns: It is possible that the result table of the fullselect will include a column of the base table that is defined as implicitly hidden. This can occur when the implicitly hidden column is explicitly referenced in the fullselect of the view definition. However, the corresponding column of the view does not inherit the implicitly hidden attribute. Columns of a view cannot be defined as hidden.

Collating sequence: The view is created with the collating sequence in effect at the time the CREATE VIEW statement is executed. The collating sequence of the view applies to all comparisons involving SBCS data and mixed data in the view fullselect. When the view is included in a query, an intermediate result table is generated from the view fullselect. The collating sequence in effect when the query is executed applies to any selection specified in the query.

View attributes: Views are created as nonkeyed logical files. When a view is created, the file wait time and record wait time attributes are set to the default that is specified on the WAITFILE and WAITRCD keywords of the Create Logical File (CRTLF) command.

The date and time format used for date and time result columns is ISO.

A view created over a distributed table is created on all of the systems across which the table is distributed. If a view is created over more than one distributed table, and those tables are not distributed using the same nodegroup, then the view is created only on the system that performs the CREATE VIEW statement. For more information about distributed tables, see the [DB2 Multisystem](#) topic collection.

Identity and row change timestamp columns: A column of a view is considered an identity or row change timestamp column if the element of the corresponding column in the fullselect of the view definition is the name of an identity or row change timestamp column of a table, or the name of a column of a view which directly or indirectly maps to the name of an identity or row change timestamp column of a base table. In all other cases, the columns of a view will not get the identity or row change timestamp property. For example:

- the select-list of the view definition includes multiple instances of the name of an identity column (that is, selecting the same column more than once)
- the view definition involves a join
- a column in the view definition includes an expression that refers to an identity column
- the view definition includes a UNION or INTERSECT

Examples

Example 1: Create a view named MA_PROJ over the PROJECT table that contains only those rows with a project number (PROJNO) starting with the letters 'MA'.

```
CREATE VIEW MA_PROJ
AS SELECT * FROM PROJECT
WHERE SUBSTR(PROJNO, 1, 2) = 'MA'
```

Example 2: Create a view as in example 1, but select only the columns for project number (PROJNO), project name (PROJNAME) and employee in charge of the project (RESPEMP).

```
CREATE VIEW MA_PROJ
AS SELECT PROJNO, PROJNAME, RESPEMP FROM PROJECT
WHERE SUBSTR(PROJNO, 1, 2) = 'MA'
```

Example 3: Create a view as in example 2, but, in the view, call the column for the employee in charge of the project IN_CHARGE.

```
CREATE VIEW MA_PROJ (PROJNO, PROJNAME, IN_CHARGE)
AS SELECT PROJNO, PROJNAME, RESPEMP FROM PROJECT
WHERE SUBSTR(PROJNO, 1, 2) = 'MA'
```

Note: Even though you are changing only one of the column names, the names of all three columns in the view must be listed in the parentheses that follow MA_PROJ.

Example 4: Create a view named PRJ_LEADER that contains the first four columns (PROJNO, PROJNAME, DEPTNO, RESPEMP) from the PROJECT table together with the last name (LASTNAME) of the person who is responsible for the project (RESPEMP). Obtain the name from the EMPLOYEE table by matching EMPNO in EMPLOYEE to RESEMP in PROJECT.

```
CREATE VIEW PRJ_LEADER
AS SELECT PROJNO, PROJNAME, DEPTNO, RESPEMP, LASTNAME
FROM PROJECT, EMPLOYEE
WHERE RESPEMP = EMPNO
```

Example 5: Create a view as in example 4, but in addition to the columns PROJNO, PROJNAME, DEPTNO, RESEMP and LASTNAME, show the total pay (SALARY + BONUS + COMM) of the employee who is responsible. Also select only those projects with mean staffing (PRSTAFF) greater than one.

```
CREATE VIEW PRJ_LEADER (PROJNO, PROJNAME, DEPTNO, RESPEMP, LASTNAME, TOTAL_PAY)
AS SELECT PROJNO, PROJNAME, DEPTNO, RESPEMP, LASTNAME, SALARY+BONUS+COMM
FROM PROJECT, EMPLOYEE
WHERE RESPEMP = EMPNO AND PRSTAFF > 1
```

Example 6: Create a recursive view that returns a similar result as a common table expression, see “Example 1: Single level explosion” on page 781.

```
CREATE RECURSIVE VIEW RPL (PART, SUBPART, QUANTITY) AS
SELECT ROOT.PART, ROOT.SUBPART, ROOT.QUANTITY
FROM PARTLIST ROOT
WHERE ROOT.PART = '01'
UNION ALL
SELECT CHILD.PART, CHILD.SUBPART, CHILD.QUANTITY
FROM RPL PARENT, PARTLIST CHILD
WHERE PARENT.SUBPART = CHILD.PART

SELECT DISTINCT *
FROM RPL
ORDER BY PART, SUBPART, QUANTITY
```

DEALLOCATE DESCRIPTOR

The DEALLOCATE DESCRIPTOR statement deallocates an SQL descriptor.

Invocation

This statement can only be embedded in an application program, SQL function, SQL procedure, or trigger. It cannot be issued interactively. It is an executable statement that cannot be dynamically prepared. It must not be specified in REXX.

Authorization

None required.

Syntax

➔ DEALLOCATE SQL DESCRIPTOR LOCAL GLOBAL *SQL-descriptor-name* ➔

Description

LOCAL

Specifies the scope of the name of the descriptor to be local to program invocation. The descriptor known in this local scope is deallocated.

GLOBAL

Specifies the scope of the name of the descriptor to be global to the SQL session. The descriptor known to any program that executes using the same database connection is deallocated.

SQL-descriptor-name

Names the descriptor to deallocate. The name must identify a descriptor that already exists with the specified scope.

Notes

Descriptor persistence: Local and global descriptors are also implicitly deallocated. For more information, see [Descriptor persistence](#)

Examples

Deallocate a descriptor called 'NEWDA'.

```
EXEC SQL DEALLOCATE DESCRIPTOR 'NEWDA'
```

DECLARE CURSOR

The DECLARE CURSOR statement defines a cursor.

Invocation

This statement can only be embedded in an application program. It is not an executable statement. It must not be specified in Java.

Authorization

No authorization is required to use this statement. However to use OPEN or FETCH for the cursor, the privileges held by the authorization ID of the statement must include at least one of the following:

- For each table or view identified in the SELECT statement of the cursor:
 - The SELECT privilege on the table or view, and
 - The USAGE privilege on the schema containing the table or view
- Database administrator authority

The SELECT statement of the cursor is one of the following:

- The prepared *select-statement* identified by the *statement-name*.
- The specified *select-statement*.

If ***statement-name*** is specified:

- The authorization ID of the statement is the run-time authorization ID unless USRPRF(*OWNER) and DYNUSRPRF(*OWNER) were specified on the CRTSQLxxx command when the program was created. For more information, see [“Authorization IDs and authorization names”](#) on page 61.
- The authorization check is performed when the *select-statement* is prepared unless DLYPRP(*YES) is specified on the CRTSQLxxx command.
- The authorization check is performed when the cursor is opened for programs compiled with the DLYPRP(*YES) parameter.

If the ***select-statement*** is specified:

- If USRPRF(*OWNER) or USRPRF(*NAMING) with SQL naming was specified on the CRTSQLxxx command, the authorization ID of the statement is the owner of the SQL program or package.
- If USRPRF(*USER) or USRPRF(*NAMING) with system naming was specified on the CRTSQLxxx command, the authorization ID of the statement is the run-time authorization ID.
- In REXX, the authorization ID of the statement is the run-time authorization ID.
- The authorization check is performed when the cursor is opened.

For information about the system authorities corresponding to SQL privileges, see [Corresponding System Authorities When Checking Privileges to a Table or View](#).

Syntax

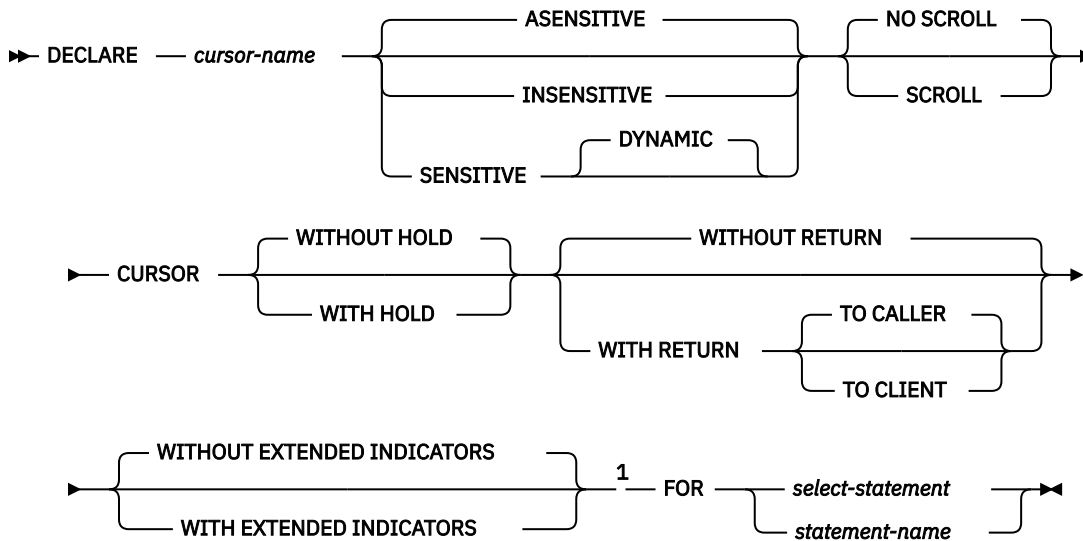

Notes:

¹ The HOLD, RETURN, and EXTENDED INDICATORS clauses can be specified in any order.

Description

cursor-name

Names a cursor. The name must not be the same as the name of another cursor declared in your source program.

ASENSITIVE, SENSITIVE, or INSENSITIVE

Specifies whether the cursor is asensitive, sensitive, or insensitive to changes. If *statement-name* is specified, the default is the corresponding prepare attribute of the statement. Otherwise, **ASENSITIVE** is the default.

ASENSITIVE

Specifies that the cursor may behave as **SENSITIVE** or **INSENSITIVE** depending on how the *select-statement* is optimized.

SENSITIVE

Specifies that changes made to the database after the cursor is opened are visible in the result table. The cursor has some level of sensitivity to any updates or deletes made to the rows underlying its result table after the cursor is opened. The cursor is always sensitive to positioned updates or deletes using the same cursor. Additionally, the cursor can have sensitivity to changes made outside this cursor. If the database manager cannot make changes visible to the cursor, then an error is returned. The database manager cannot make changes visible to the cursor when the cursor implicitly becomes read-only. (See [Result table of a cursor.](#)) If **SENSITIVE** is specified, the **SELECT** statement cannot contain a *data-change-table-reference*.

INSENSITIVE

Specifies that once the cursor is opened, it does not have sensitivity to inserts, updates, or deletes performed by this or any other activation group. If **INSENSITIVE** is specified, the cursor is read-only and a temporary result is created when the cursor is opened. In addition, the **SELECT** statement cannot contain a **UPDATE** clause and the application must allow a copy of the data (`ALWCPYDTA(*OPTIMIZE)` or `ALWCPYDTA(*YES)`).

NO SCROLL or SCROLL

Specifies whether the cursor is scrollable or not scrollable. If *statement-name* is specified, the default is the corresponding prepare attribute of the statement. Otherwise, **NO SCROLL** is the default.

NO SCROLL

Specifies that the cursor is not scrollable.

SCROLL

Specifies that the cursor is scrollable. The cursor may or may not have immediate sensitivity to inserts, updates, and deletes done by other activation groups.

WITHOUT HOLD or WITH HOLD

Specifies whether the cursor should be prevented from being closed as a consequence of a commit operation. If *statement-name* is specified, the default is the corresponding prepare attribute of the statement. Otherwise, WITHOUT HOLD is the default.

WITHOUT HOLD

Does not prevent the cursor from being closed as a consequence of a commit operation.

WITH HOLD

Prevents the cursor from being closed as a consequence of a commit operation. A cursor declared using the WITH HOLD clause is implicitly closed at commit time only if the connection associated with the cursor is ended during the commit operation.

When WITH HOLD is specified, a commit operation commits all the changes in the current unit of work, and releases all locks except those that are required to maintain the cursor position. Afterward, a FETCH statement is required before a Positioned UPDATE or DELETE statement can be executed.

All cursors are implicitly closed by a CONNECT (Type 1) or rollback operation. All cursors associated with a connection are implicitly closed by a disconnect of the connection. A cursor is also implicitly closed by a commit operation if WITH HOLD is not specified, or if the connection associated with the cursor is in the release-pending state.

If a cursor is closed before the commit operation, the effect is the same as if the cursor was declared without the WITH HOLD option.

WITHOUT RETURN or WITH RETURN

Specifies that the result table of the cursor is intended to be used as a procedure result set. If *statement-name* is specified, the default is the corresponding prepare attribute of the statement. Otherwise, WITHOUT RETURN is the default.

WITHOUT RETURN

Specifies that the result table of the cursor is not intended to be used as a procedure result set.

WITH RETURN

Specifies that the result table of the cursor is intended to be used as a procedure result set. If the DECLARE CURSOR statement is not contained within the source code for a procedure, the clause is ignored.

For SQL procedures, result sets are only returned if a DYNAMIC RESULT SETS clause with a nonzero maximum number of result sets is specified on the procedure definition.

- Cursors defined by using the WITH RETURN clause that are still open when the procedure ends define the result sets for the procedure. All other open cursors are closed when the procedure ends, provided the procedure was not created with CLOSQLCSR(*ENDACTGRP).
- If no cursors in the stored procedure are defined by using the WITH RETURN or WITHOUT RETURN clause, then any cursor that is open when the stored procedure ends potentially becomes a result set cursor.
- See the DYNAMIC RESULT SETS clause in [“CREATE PROCEDURE \(SQL\)”](#) on page 1080 for further considerations that determine a procedure's result sets.

For external procedures:

- Any cursors that are defined by using the WITH RETURN clause (or identified as a result set cursor in a SET RESULT SETS statement) and that are still open when the procedure ends define the potential result sets for the procedure, provided the procedure was not created with CLOSQLCSR(*ENDACTGRP). All other open cursors remain open.

- If no cursors in the stored procedure are defined by using the WITH RETURN or WITHOUT RETURN clause, and no cursors are identified as a result set cursor in a SET RESULT SETS statement, then any cursor that is open when the stored procedure ends potentially becomes a result set cursor.
- See the DYNAMIC RESULT SETS clause in [“CREATE PROCEDURE \(external\)”](#) on page 1065 for further considerations that determine a procedure's result sets.

For non-scrollable cursors, the result set consists of all rows from the current cursor position to the end of the result table. For scrollable cursors, the result set consists of all rows of the result table.

TO CALLER

Specifies that the cursor can return a result set to the caller of the procedure. For example, if the caller is a client application, the result set is returned to the client application.

TO CLIENT

Specifies that the cursor can return a result set to the client application. This cursor is invisible to any intermediate nested procedures. If a function or trigger called the procedure either directly or indirectly, result sets cannot be returned to the client and the cursor will be closed after the procedure finishes.

TO CLIENT may be necessary if the result set is returned from an ILE program with multiple modules.

WITHOUT EXTENDED INDICATORS or WITH EXTENDED INDICATORS

Specifies whether extended indicators are enabled. If *statement-name* is specified, the default is the corresponding prepare attribute of the statement. Otherwise, the default is the attribute specified on the containing program or service program.

WITHOUT EXTENDED INDICATORS

Specifies that extended indicator variables are not enabled, and only updatable columns are allowed in the implicit or explicit UPDATE clause or the *select-statement*.

WITH EXTENDED INDICATORS

Specifies that extended indicator variables are enabled, and non-updatable columns are allowed in the implicit or explicit UPDATE clause of the *select-statement*.

select-statement

Specifies the SELECT statement of the cursor. See [“select-statement”](#) on page 777 for more information.

The *select-statement* must not include parameter markers (except for REXX), but can include references to variables. In host languages, other than REXX, the declarations of the host variables must precede the DECLARE CURSOR statement in the source program. In REXX, parameter markers must be used in place of variables and the statement must be prepared.

statement-name

The SELECT statement of the cursor is the prepared *select-statement* identified by the *statement-name* when the cursor is opened. The *statement-name* must not be identical to a *statement-name* specified in another DECLARE CURSOR statement of the source program. See [“PREPARE”](#) on page 1427 for an explanation of prepared statements.

Notes

Placement of DECLARE CURSOR: The DECLARE CURSOR statement must precede all statements that explicitly reference the cursor by name, except in C and PL/I.

Result table of a cursor: A cursor in the open state designates a *result table* and a position relative to the rows of that table. The table is the result table specified by the SELECT statement of the cursor.

A cursor is *deletable* if all of the following are true:

- The outer fullselect identifies only one base table or deletable view that is not a catalog table or view and is not in a nested table expression.

- The outer fullselect does not include a VALUES clause.
- The outer fullselect does not include a GROUP BY clause or HAVING clause.
- The outer fullselect does not include aggregate functions in the select list.
- The outer fullselect does not include a UNION, UNION ALL, EXCEPT, or INTERSECT operator.
- The *select-clause* of the outer fullselect does not include the DISTINCT clause.
- The outer fullselect does not contain a FOR SYSTEM_TIME period specification.
- The outer fullselect does not include a *data-change-table-reference* in the FROM clause
- The *select-statement* does not contain an ORDER BY clause and does not contain the UPDATE clause and SENSITIVE is not specified in the DECLARE CURSOR statement
- The *select-statement* does not include a FOR READ ONLY clause.
- The result of the outer fullselect does not make use of a temporary table.
- The *select-statement* does not include the SCROLL keyword, or the SENSITIVE keyword or UPDATE clause is also specified.
- The select list does not include a DATALINK column unless a UPDATE clause is specified.

A result column in the select list of the outer fullselect associated with a cursor is *updatable* if all of the following are true:

- The cursor is deletable.
- The result column is derived solely from a column of a table or an updatable column of a view. That is, at least one result column must not be derived from an expression that contains an operator, scalar function, constant, or a column that itself is derived from such expressions.

A cursor is *read-only* if it is not deletable.

If the UPDATE clause is omitted, only the columns in the SELECT clause of the subselect that can be updated can be changed.

If UPDATE is specified without a list of column names, then the list of columns that can appear as targets in the assignment clause of subsequent positioned UPDATE statements identifying this cursor is determined as follows:

- If WITH EXTENDED INDICATORS is specified, all the columns of the table or view identified in the first FROM clause of the fullselect.
- Otherwise, only the updatable columns of the table or view identified in the first FROM clause of the fullselect.

If UPDATE is specified with a list of column names, only the columns specified in the list of column names can appear as targets in the assignment clause in subsequent positioned UPDATE statements identifying this cursor.

Scope of a cursor: The scope of *cursor-name* is the source program in which it is defined; that is, the program submitted to the precompiler. Thus, a cursor can only be referenced by statements that are precompiled with the cursor declaration. For example, a program called from another separately compiled program cannot use a cursor that was opened by the calling program.

The scope of *cursor-name* is also limited to the thread in which the program that contains the cursor is running. For example, if the same program is running in two separate threads in the same job, the second thread cannot use a cursor that was opened by the first thread.

A cursor can only be referred to in the same instance of the program in the program stack unless CLOSQLCSR(*ENDJOB), CLOSQLCSR(*ENDSQL), or CLOSQLCSR(*ENDACTGRP) is specified on the CRTSQLxxx commands.

- If CLOSQLCSR(*ENDJOB) is specified, the cursor can be referred to by any instance of the program on the program stack.
- If CLOSQLCSR(*ENDSQL) is specified, the cursor can be referred to by any instance of the program on the program stack until the last SQL program on the program stack ends.

- If CLOSQLCSR(*ENDACTGRP) is specified, the cursor can be referred to by all instances of the module in the activation group until the activation group ends.

Although the scope of a cursor is the program in which it is declared, each package created from the program includes a separate instance of the cursor and more than one cursor can exist at run time. For example, assume a program using CONNECT (Type 2) statements connects to location X and location Y in the following sequence:

```
EXEC SQL DECLARE C CURSOR FOR...
EXEC SQL CONNECT TO X;
EXEC SQL OPEN C;
EXEC SQL FETCH C INTO...
EXEC SQL CONNECT TO Y;
EXEC SQL OPEN C;
EXEC SQL FETCH C INTO...
```

The second OPEN C statement does not cause an error because it refers to a different instance of cursor C.

A SELECT statement is evaluated at the time the cursor is opened. If the same cursor is opened, closed, and then opened again, the results may be different. If the SELECT statement of a cursor contains CURRENT DATE, CURRENT TIME, or CURRENT TIMESTAMP, all references to these special registers will yield the same respective datetime value on each FETCH. The value is determined when the cursor is opened. Multiple cursors using the same SELECT statement can be opened concurrently. They are each considered independent activities.

Using sequence expressions: For information regarding using NEXT VALUE and PREVIOUS VALUE expressions with a cursor, see [Using sequence expressions with a cursor](#).

Blocking of data: For more efficient processing of data, the database manager can block data for read-only cursors. If a cursor is not going to be used in a Positioned UPDATE or DELETE statement, it should be declared as FOR READ ONLY.

Usage in REXX: If variables are used on the DECLARE CURSOR statement within a REXX procedure, then the DECLARE CURSOR must be the object of a PREPARE and EXECUTE.

Temporary results: Certain *select-statements* may be implemented as temporary result tables.

- A temporary result table is created when:
 - INSENSITIVE is specified
 - The ORDER BY and GROUP BY clauses specify different columns or columns in a different order.
 - The ORDER BY and GROUP BY clauses include a user-defined function or one of the following scalar functions: DLVALUE, DLURLPATH, DLURLPATHONLY, DLURLSERVER, DLURLSCHEME, or DLURLCOMPLETE for DataLinks with an attribute of FILE LINK CONTROL and READ PERMISSION DB.
 - The UNION, EXCEPT, INTERSECT, or DISTINCT clauses are specified.
 - The ORDER BY or GROUP BY clauses specify columns which are not all from the same table.
 - A logical file defined by the JOINDFT data definition specifications (DDS) keyword is joined to another file.
 - A logical file that is based on multiple database file members is specified.
 - The CURRENT or RELATIVE scroll options are specified on the FETCH statement when the select statement of the DECLARE CURSOR contains a GROUP BY clause.
 - The FETCH FIRST n ROWS ONLY clause is specified.
- Queries that include a subquery where:
 - The outermost query does not provide correlated values to any inner subselects.
 - No IN, = ANY, = SOME, or <> ALL subqueries are referenced by the outermost query.

Cursor sensitivity: The ALWCPYDTA precompile option is ignored for DYNAMIC SCROLL cursors. If sensitivity to inserts, updates, and deletes must be maintained, a temporary copy of the data is never made unless a temporary result is required to implement the query.

Scrollable, sensitive cursors with an OFFSET and/or FETCH FIRST clause may return rows either before the specified offset or after the specified number of rows if:

- update, delete, or insert operations occur against the underlying tables of the cursor while fetching data through the cursor, and
- the fetch operations against the cursor attempt to return the same rows that were previously fetched by the cursor.

Syntax alternatives: The following keywords are synonyms supported for compatibility to prior releases. These keywords are non-standard and should not be used:

- DYNAMIC SCROLL is a synonym for SENSITIVE DYNAMIC SCROLL

Examples

Example 1: Declare C1 as the cursor of a query to retrieve data from the table DEPARTMENT. The query itself appears in the DECLARE CURSOR statement.

```
EXEC SQL DECLARE C1 CURSOR FOR
      SELECT DEPTNO, DEPTNAME, MGRNO
      FROM DEPARTMENT
      WHERE ADMRDEPT = 'A00';
```

Example 2: Declare C1 as the cursor of a query to retrieve data from the table DEPARTMENT. Assume that the data will be updated later with a searched update and should be locked when the query executes. The query itself appears in the DECLARE CURSOR statement.

```
EXEC SQL DECLARE C1 CURSOR FOR
      SELECT DEPTNO, DEPTNAME, MGRNO
      FROM DEPARTMENT
      WHERE ADMRDEPT = 'A00'
      FOR READ ONLY WITH RS USE AND KEEP EXCLUSIVE LOCKS;
```

Example 3: Declare C2 as the cursor for a statement named STMT2.

```
EXEC SQL DECLARE C2 CURSOR FOR STMT2;
```

Example 4: Declare C3 as the cursor for a query to be used in positioned updates of the table EMPLOYEE. Allow the completed updates to be committed from time to time without closing the cursor.

```
EXEC SQL DECLARE C3 CURSOR WITH HOLD FOR
      SELECT *
      FROM EMPLOYEE
      FOR UPDATE OF WORKDEPT, PHONENO, JOB, EDLEVEL, SALARY;
```

Instead of explicitly specifying the columns to be updated, an UPDATE clause could have been used without naming the columns. This would allow all the updatable columns of the table to be updated. Since this cursor is updatable, it can also be used to delete rows from the table.

Example 5: In a C program, use the cursor C1 to fetch the values for a given project (PROJNO) from the first four columns of the EMPPROJECT table a row at a time and put them into the following host variables: EMP(CHAR(6)), PRJ(CHAR(6)), ACT(SMALLINT) and TIM(DECIMAL(5,2)). Obtain the value of the project to search for from the host variable SEARCH_PRJ (CHAR(6)). Dynamically prepare the *select-statement* to allow the project to search by to be specified when the program is executed.

```
void main ()
{
  EXEC SQL BEGIN DECLARE SECTION;
  char      EMP[7];
  char      PRJ[7];
  char      SEARCH_PRJ[7];
  short     ACT;
  double    TIM;
  char      SELECT_STMT[201];
  EXEC SQL END DECLARE SECTION;
  EXEC SQL INCLUDE SQLCA;
```

```

strcpy(SELECT_STMT, "SELECT EMPNO, PROJNO, ACTNO, EMPTIME \
                    FROM EMPPROJECT \
                    WHERE PROJNO = ?");
.
.
EXEC SQL PREPARE SELECT_PRJ FROM :SELECT_STMT;
EXEC SQL DECLARE C1 CURSOR FOR SELECT_PRJ;
/* Obtain the value for SEARCH_PRJ from the user.      */
.
.
EXEC SQL OPEN C1 USING :SEARCH_PRJ;
EXEC SQL FETCH C1 INTO :EMP, :PRJ, :ACT, :TIM;
if (strcmp(SQLSTATE, "02000", 5) )
{
    data_not_found();
}
else
{
    while (strcmp(SQLSTATE, "00", 2) || strcmp(SQLSTATE, "01", 2) )
    {
        EXEC SQL FETCH C1 INTO :EMP, :PRJ, :ACT, :TIM;
    }
}
EXEC SQL CLOSE C1;
.
.
}

```

Example 6: The DECLARE CURSOR statement associates the cursor name C1 with the results of the SELECT. C1 is an updatable, scrollable cursor.

```

EXEC SQL DECLARE C1 SENSITIVE SCROLL CURSOR FOR
SELECT DEPTNO, DEPTNAME, MGRNO
FROM TDEPT
WHERE ADMRDEPT = 'A00';

```

Example 7: Declare a cursor in order to fetch values from four columns and assign the values to variables using the Serializable (RR) isolation level:

```

DECLARE CURSOR1 CURSOR FOR
SELECT COL1, COL2, COL3, COL4
FROM TBLNAME WHERE COL1 = :varname
WITH RR

```

Example 8: Assume that the EMPLOYEE table has been altered to add a generated column, WEEKLYPAY, that calculates the weekly pay based on the yearly salary. Declare a cursor to retrieve the system generated column value from a row to be inserted.

```

DECLARE C2 CURSOR FOR
SELECT E.WEEKLYPAY
FROM FINAL TABLE
(INSERT INTO EMPLOYEE
    (EMPNO, FIRSTNAME, MIDINIT, LASTNAME, EDLEVEL, SALARY)
    VALUES ('000420', 'Peter', 'U', 'Bender', 16, 31842)) AS E;

```

DECLARE GLOBAL TEMPORARY TABLE

The DECLARE GLOBAL TEMPORARY TABLE statement defines a declared temporary table for the current application process. The declared temporary table description does not appear in the system catalog. It is not persistent and cannot be shared with other application processes. Each application process that defines a declared temporary table of the same name has its own unique description of the temporary table. When the application process ends, the temporary table is dropped.

Invocation

This statement can be embedded in an application program or issued interactively. It is an executable statement that can be dynamically prepared.

Authorization

If the LIKE or AS *select-statement* clause is specified, the privileges held by the authorization ID of the statement must include at least one of the following on any table or view specified in the LIKE clause or *as-result-table* clause:

- The SELECT privilege for the table or view
- Ownership of the table or view
- Database administrator authority

If a distinct type is referenced, the privileges held by the authorization ID of the statement must include at least one of the following:

- For each distinct type identified in the statement:
 - The USAGE privilege on the distinct type, and
 - The USAGE privilege on the schema containing the distinct type
- Database administrator authority

For information about the system authorities corresponding to SQL privileges, see [Corresponding System Authorities When Checking Privileges to a Table or View](#) and [Corresponding System Authorities When Checking Privileges to a Distinct Type](#).

Syntax

► DECLARE GLOBAL TEMPORARY TABLE — *table-name* →

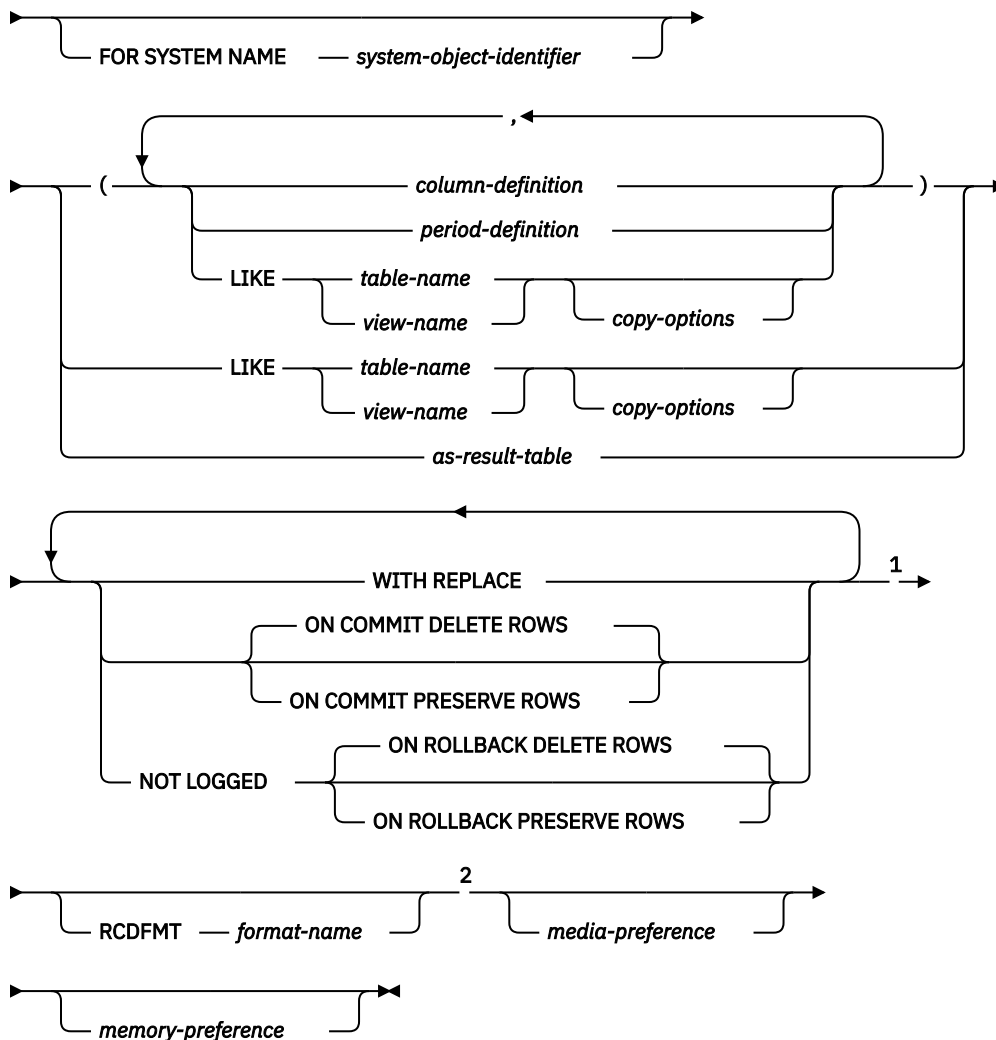

media-preference

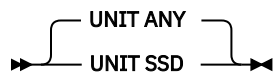

memory-preference

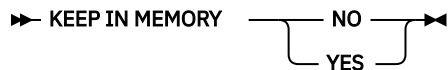

column-definition

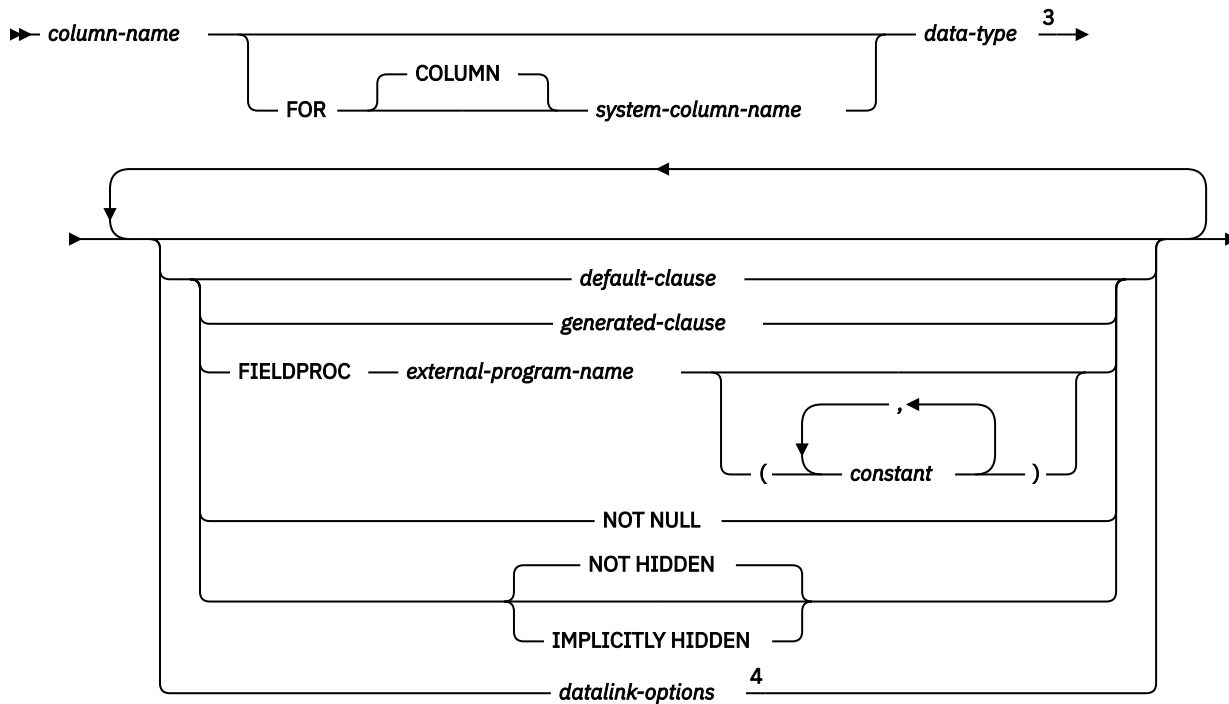

data-type

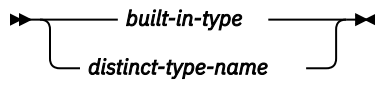

Notes:

- 1 The same clause must not be specified more than once.
- 2 The optional clauses can be specified in any order.
- 3 *data-type* is optional for row change timestamp columns, row-begin and row-end columns, and transaction-start-ID columns.
- 4 The datalink-options can only be specified for DATALINKS and distinct-types sourced on DATALINKS.

built-in-type

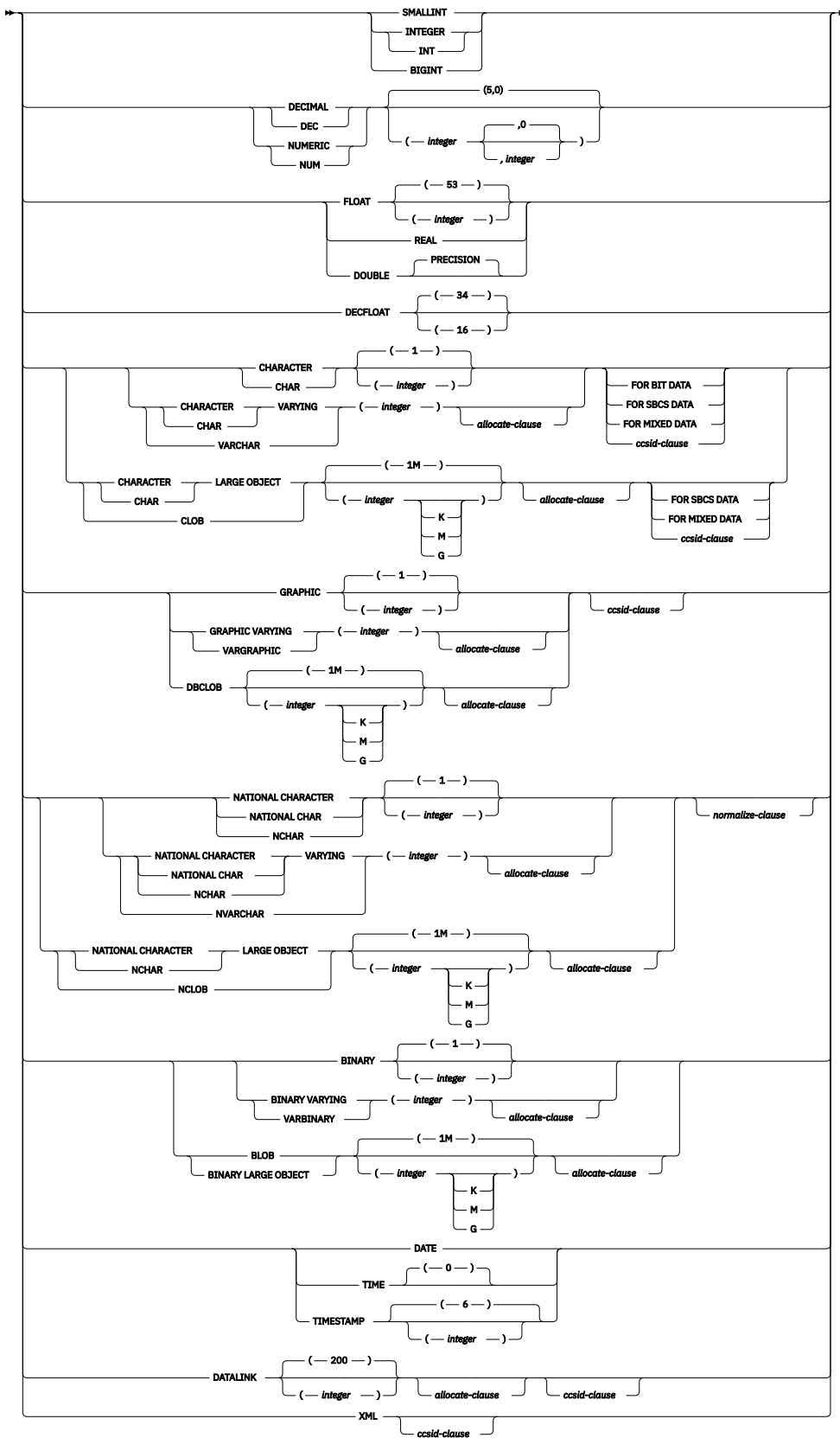

ccsid-clause

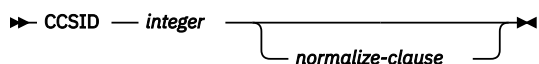

normalize-clause

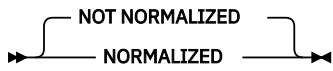

allocate-clause

▶ ALLOCATE — (*integer*) ◀

default-clause

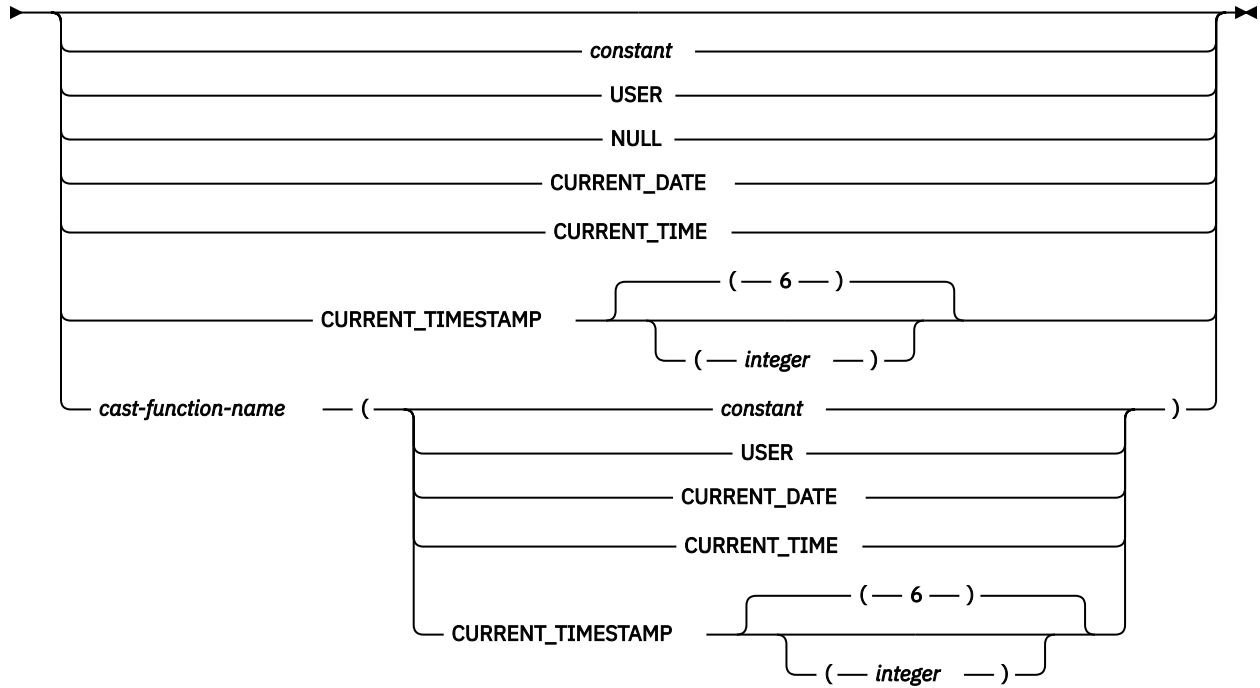

generated-clause

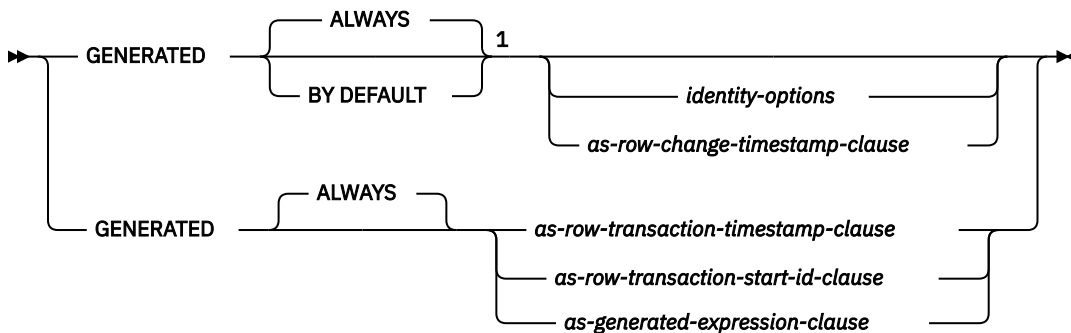

Notes:

¹ GENERATED can be specified only if the column has a ROWID data type (or a distinct type that is based on a ROWID data type), or the column is an identity column, or the column is a row change timestamp.

identity-options

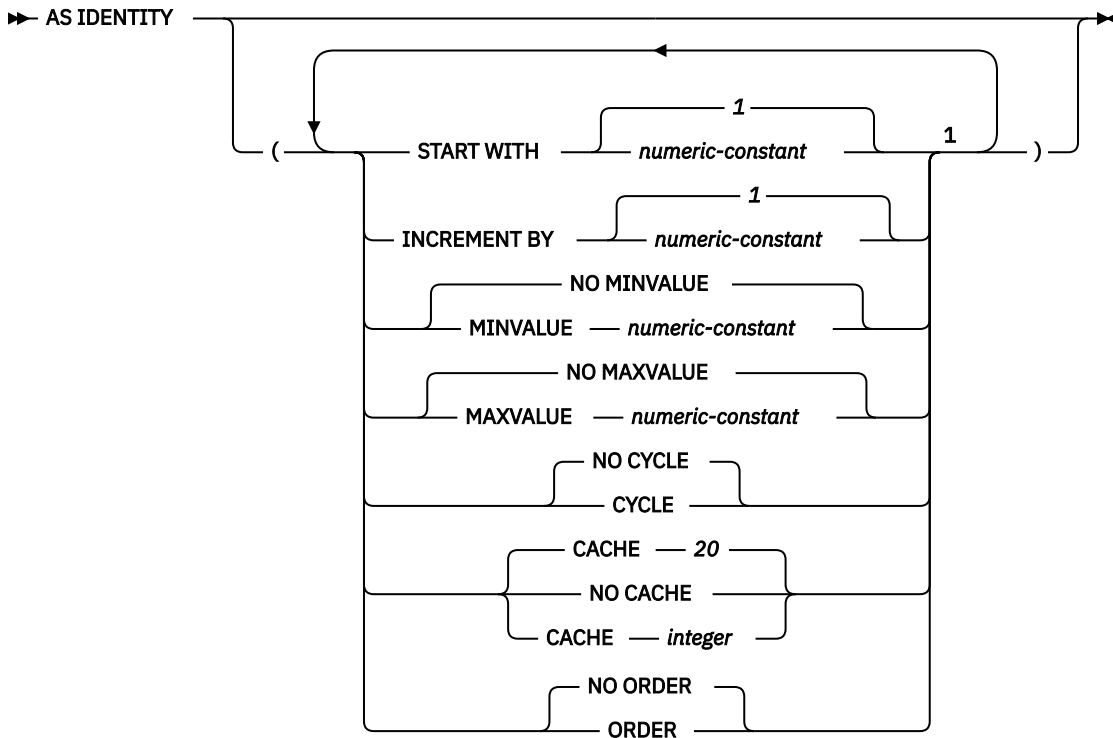

Notes:

¹ The same clause must not be specified more than once.

as-row-change-timestamp-clause

➤ FOR EACH ROW ON UPDATE AS ROW CHANGE TIMESTAMP ➤

as-row-transaction-timestamp-clause

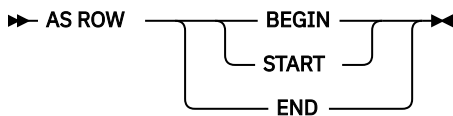

as-row-transaction-start-id-clause

➤ AS TRANSACTION START ID ➤

as-generated-expression-clause

➤ AS (— *non-deterministic-expression* —) ➤

non-deterministic-expression

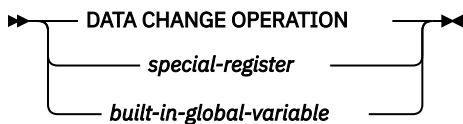

special-register

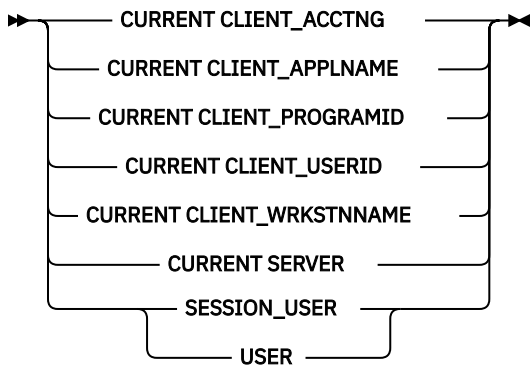

built-in-global-variable

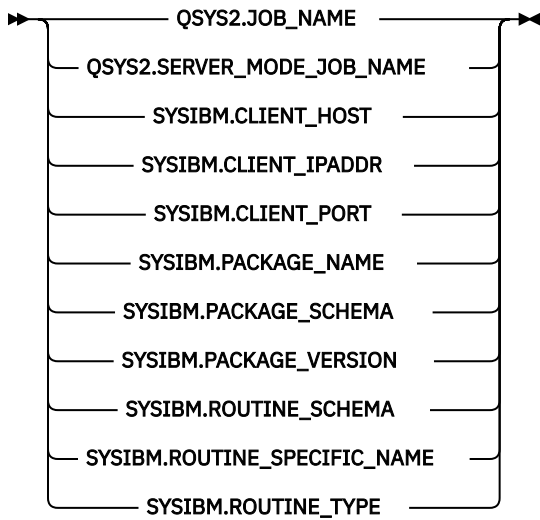

period-definition



datalink-options



copy-options

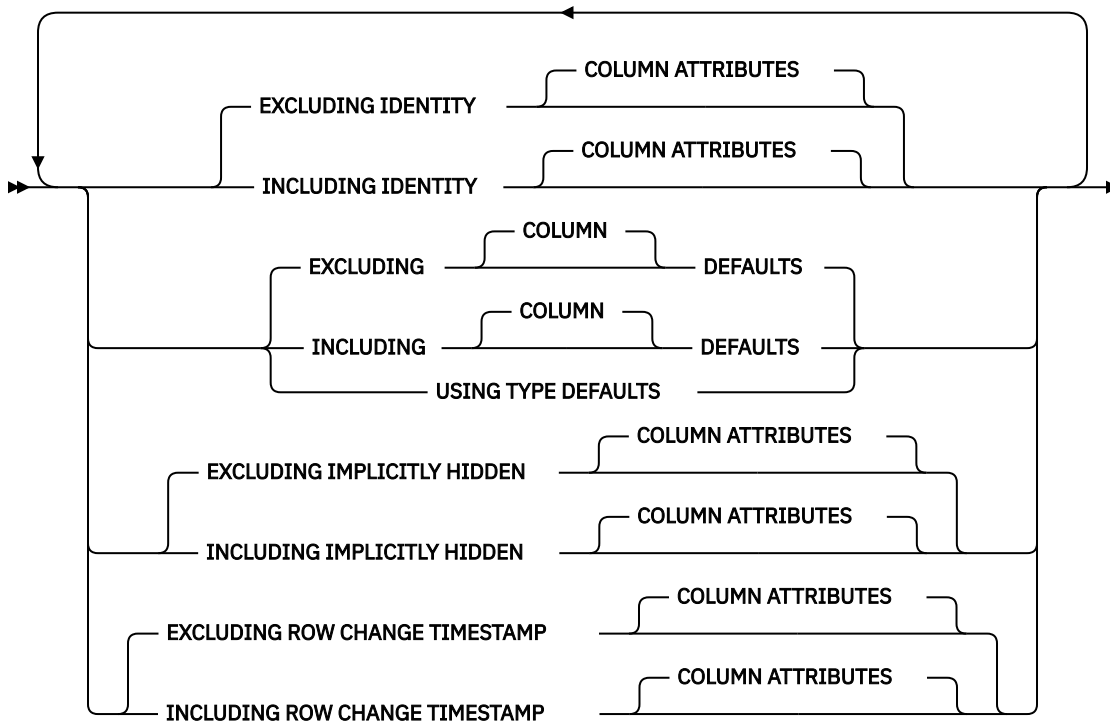

¹

as-result-table

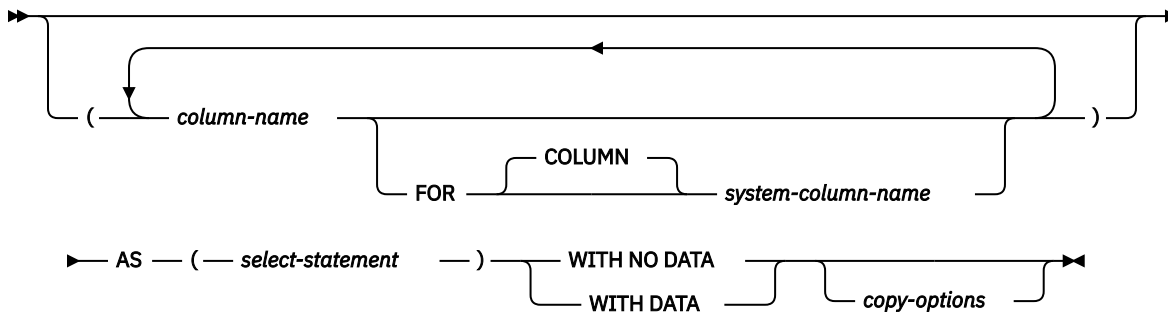

Notes:

¹ The clauses can be specified in any order.

Description

table-name

Names the temporary table. The qualifier, if specified explicitly, must be `SESSION`, otherwise an error is returned. If the qualifier is not specified, it is implicitly defined to be `SESSION`. If a declared temporary table, or an index or view that is dependent on a declared temporary table already exists with the same name, an error is returned.

If a persistent table, view, index, or alias already exists with the same name and the schema name `SESSION`:

- The declared temporary table is still defined with `SESSION.table-name`. An error is not issued because the resolution of a declared temporary table name does not include a permanent library.
- Any references to `SESSION.table-name` will resolve to the declared temporary table rather than to a permanent table, view, index, or alias with a name of `SESSION.table-name`.

The table will be created in library `QTEMP`.

FOR SYSTEM NAME *system-object-identifier*

Identifies the *system-object-identifier* of the table. *system-object-identifier* must not be the same as a table, view, alias, or index that already exists at the current server. The *system-object-identifier* must be an unqualified system identifier.

When *system-object-identifier* is specified, *table-name* must not be a valid system object name.

column-definition

Defines the attributes of a column. There must be at least one column definition and no more than 8000 column definitions.

The sum of the row buffer byte counts of the columns must not be greater than 32766 or, if a VARCHAR, VARGRAPHIC, or VARBINARY column is specified, 32740. Additionally, if a LOB or XML column is specified, the sum of the row data byte counts of the columns must not be greater than 3.5 gigabytes. For information about the byte counts of columns according to data type, see [“Maximum row sizes” on page 1154](#).

column-name

Names a column of the table. Do not qualify *column-name* and do not use the same name for more than one column of the table or for a system-column-name of the table.

FOR COLUMN *system-column-name*

Provides an IBM i name for the column. Do not use the same name for more than one column of the table or for a column-name of the table.

If the system-column-name is not specified, and the column-name is not a valid system-column-name, a system column name is generated. For more information about how system column names are generated, see [“Rules for Column Name Generation” on page 1156](#).

data-type

Specifies the data type of the column.

built-in-type

Specifies a built-in data type. See [“CREATE TABLE” on page 1105](#) for a description of *built-in-type*.

A ROWID column or a DATALINK column with FILE LINK CONTROL cannot be specified for a declared temporary table.

distinct-type-name

Specifies that the data type of the column is a distinct type (a user-defined data type). The length, precision, and scale of the column are respectively the length, precision, and scale of the source type of the distinct type. If a distinct type name is specified without a schema name, the distinct type name is resolved by searching the schemas on the SQL path.

DEFAULT

Specifies a default value for the column. This clause cannot be specified more than once in a *column-definition*. DEFAULT cannot be specified for the following types of columns because Db2 generates default values:

- an identity column (a column that is defined AS IDENTITY)
- a row change timestamp column
- a row-begin column
- a row-end column
- a transaction-start-ID column
- a generated expression column

For an XML column, the default is NULL unless NOT NULL is specified; in that case there is no default.

If a value is not specified following the DEFAULT keyword, then:

- if the column is nullable, the default value is the null value.
- if the column is not nullable, the default depends on the data type of the column:

Data type	Default value
Numeric	0
Fixed-length character or graphic string	Blanks
Fixed-length binary string	Hexadecimal zeros
Varying-length string	A string length of 0
Date	The current date at the time of INSERT
Time	The current time at the time of INSERT
Timestamp	The current timestamp at the time of INSERT
Datalink	A value corresponding to DLVALUE(';URL;')
<i>distinct-type</i>	The default value of the corresponding source type of the distinct type.

Omission of NOT NULL and DEFAULT from a *column-definition* is an implicit specification of DEFAULT NULL.

constant

Specifies the constant as the default for the column. The specified constant must represent a value that could be assigned to the column in accordance with the rules of assignment as described in “Assignments and comparisons” on page 91. A floating-point constant or decimal floating-point constant must not be used for a SMALLINT, INTEGER, DECIMAL, or NUMERIC column. A decimal constant must not contain more digits to the right of the decimal point than the specified scale of the column.

USER

Specifies the value of the USER special register at the time of INSERT or UPDATE as the default value of the column. The data type of the column must be CHAR or VARCHAR with a length attribute greater than or equal to the length attribute of the USER special register.

NULL

Specifies null as the default for the column. If NOT NULL is specified, DEFAULT NULL must not be specified within the same *column-definition*.

CURRENT_DATE

Specifies the current date as the default for the column. If CURRENT_DATE is specified, the data type of the column must be DATE or a distinct type based on a DATE.

CURRENT_TIME

Specifies the current time as the default for the column. If CURRENT_TIME is specified, the data type of the column must be TIME or a distinct type based on a TIME.

CURRENT_TIMESTAMP or CURRENT_TIMESTAMP(*integer*)

Specifies the current timestamp as the default for the column. If CURRENT_TIMESTAMP is specified, the data type of the column must be TIMESTAMP or a distinct type based on a TIMESTAMP. The timestamp precision of the CURRENT_TIMESTAMP special register used as the default will always match the timestamp precision of the column, regardless of the precision specified for the special register.

cast-function-name

This form of a default value can only be used with columns defined as a strongly typed distinct type, BINARY, VARBINARY, BLOB, CLOB, DBCLOB, DATE, TIME or TIMESTAMP data types. The following table describes the allowed uses of these *cast-functions*.

Data Type	Cast Function Name
Strongly typed distinct type N based on a BINARY, VARBINARY, BLOB, CLOB, or DBCLOB	BINARY, VARBINARY, BLOB, CLOB, or DBCLOB *
Strongly typed distinct type N based on a DATE, TIME, or TIMESTAMP	N (the user-defined cast function that was generated when N was created) ** or DATE, TIME, or TIMESTAMP *
Strongly typed distinct type N based on other data types	N (the user-defined cast function that was generated when N was created) **
BINARY, VARBINARY, BLOB, CLOB, or DBCLOB	BINARY, VARBINARY, BLOB, CLOB, or DBCLOB *
DATE, TIME, or TIMESTAMP	DATE, TIME, or TIMESTAMP *
<p>Notes:</p> <p>* The name of the function must match the name of the data type (or the source type of the distinct type) with an implicit or explicit schema name of QSYS2.</p> <p>** The name of the function must match the name of the distinct type for the column. If qualified with a schema name, it must be the same as the schema name for the distinct type. If not qualified, the schema name from function resolution must be the same as the schema name for the distinct type.</p>	

constant

Specifies a constant as the argument. The constant must conform to the rules of a constant for the source type of the distinct type or for the data type if not a distinct type. For BINARY, VARBINARY, BLOB, CLOB, DBCLOB, DATE, TIME, and TIMESTAMP functions, the constant must be a string constant.

USER

Specifies the value of the USER special register at the time of INSERT or UPDATE as the default value for the column. The data type of the source type of the distinct type of the column must be CHAR or VARCHAR with a length attribute greater than or equal to the length attribute of the USER special register.

CURRENT_DATE

Specifies the current date as the default for the column. If CURRENT_DATE is specified, the data type of the source type of the distinct type of the column must be DATE.

CURRENT_TIME

Specifies the current time as the default for the column. If CURRENT_TIME is specified, the data type of the source type of the distinct type of the column must be TIME.

CURRENT_TIMESTAMP or CURRENT_TIMESTAMP(*integer*)

Specifies the current timestamp as the default for the column. If CURRENT_TIMESTAMP is specified, the data type of the source type of the distinct type of the column must be TIMESTAMP. The timestamp precision of the CURRENT_TIMESTAMP special register used as the default will always match the timestamp precision of the column, regardless of the precision specified for the special register.

If the value specified is not valid, an error is returned.

GENERATED

Specifies that the database manager generates values for the column. GENERATED may be specified if the column is to be considered one of the following types of columns:

- an identity column

- a row change timestamp column

GENERATED must be specified if the column is to be considered one of the following types of columns:

- a row-begin column
- a row-end column
- a transaction-start-ID column
- a generated expression column

It may also be specified if the data type of the column is a ROWID (or a distinct type that is based on a ROWID). Otherwise, it must not be specified. GENERATED must not be specified with *default-clause* in a column definition.

ALWAYS

Specifies that the database manager will always generate a value for the column when a row is inserted or updated and a default value must be generated. ALWAYS is the recommended value.

BY DEFAULT

Specifies that the database manager will generate a value for the column when a row is inserted or updated and a default value must be generated, unless an explicit value is specified.

For an identity column or row change timestamp column, the database manager inserts or updates a specified value but does not verify that it is a unique value for the column unless the identity column or row change timestamp column has a unique constraint or a unique index that solely specifies the identity column or row change timestamp column.

AS IDENTITY

Specifies that the column is an identity column for the table. A table can have only one identity column. AS IDENTITY can be specified only if the data type for the column is an exact numeric type with a scale of zero (SMALLINT, INTEGER, BIGINT, DECIMAL or NUMERIC with a scale of zero, or a distinct type based on one of these data types). If a DECIMAL or NUMERIC data type is specified, the precision must not be greater than 31.

An identity column is implicitly NOT NULL. An identity column cannot have a DEFAULT clause. See the AS IDENTITY clause in [“CREATE TABLE” on page 1105](#) for the descriptions of the identity attributes.

FOR EACH ROW ON UPDATE AS ROW CHANGE TIMESTAMP

Specifies that the column is a timestamp and the values will be generated by the database manager. The database manager generates a value for the column for each row as a row is inserted, and for every row in which any column is updated. The value generated for a row change timestamp column is a timestamp corresponding to the time of the insert or update of the row. If multiple rows are inserted with a single SQL statement, the value for the row change timestamp column may be different for each row to reflect when each row was inserted. The generated value is not guaranteed to be unique.

A table can have only one row change timestamp column. If *data-type* is specified, it must be a TIMESTAMP with a precision of 6 or a distinct type based on a TIMESTAMP with a precision of 6. A row change timestamp column cannot have a DEFAULT clause and must be NOT NULL.

AS ROW BEGIN

Specifies that the column contains timestamp data and that the values are generated by the database manager. The database manager generates a value for the column for each row as the row is inserted, and for every row in which any column is updated. The generated value is a timestamp that corresponds to the start time that is associated with the most recent transaction. If multiple rows are inserted with a single SQL statement, the values for the transaction start timestamp column are the same for each row.

For a system-period temporal table, the database manager ensures uniqueness of the generated values for a row-begin column across transactions. The timestamp value might be adjusted to ensure that rows inserted into an associated history table have the end timestamp value greater than the begin timestamp value. This can happen when a conflicting transaction is updating the same row in the system-period temporal table. The SYSTIME_PERIOD_ADJ QAQQINI option must be set to *ADJUST for this adjustment to the timestamp value to occur. If multiple rows are inserted or updated

within a single SQL transaction and an adjustment is not needed, the values for the row-begin column are the same for all the rows and are unique from the values generated for the column for another transaction. A row-begin column is required as the begin column of a SYSTEM_TIME period.

A table can have only one row-begin column. If *data-type* is not specified, the column is defined as a TIMESTAMP(12). If *data-type* is specified, it must be TIMESTAMP(12). The column cannot have a DEFAULT clause and must be defined as NOT NULL. A row-begin column is not updatable.

AS ROW END

Specifies that a value for the data type of the column is assigned by the database manager whenever a row is inserted or any column in the row is updated. The assigned value is `TIMESTAMP '9999-12-30-00.00.00.000000000000'`.

A row-end column is required as the second column of a SYSTEM_TIME period

A table can have only one row-end column. If *data-type* is not specified, the column is defined as TIMESTAMP(12). If *data-type* is specified, it must be TIMESTAMP(12). The column cannot have a DEFAULT clause and must be defined as NOT NULL. A row-end column is not updatable.

AS TRANSACTION START ID

Specifies that the value is assigned by the database manager whenever a row is inserted into the table or any column in the row is updated. The database manager assigns a unique timestamp value per transaction or the null value. The null value is assigned to the transaction-start-ID column if the column is nullable and if there is a row-begin column in the table for which the value did not need to be adjusted. Otherwise the value is generated using a reading of the time-of-day clock during execution of the first data change statement in the transaction that requires a value to be assigned to a row-begin column or transaction-start-ID column in the table, or a row in a system-period temporal table is deleted. If multiple rows are inserted or updated within a single SQL transaction, the values for the transaction-start-ID column are the same for all the rows and are unique from the values generated for the column for another transaction.

A transaction-start-ID column is required for a system-period temporal table.

A table can have only one transaction-start-ID column. If *data-type* is not specified, the column is defined as TIMESTAMP(12). If *data-type* is specified it must be TIMESTAMP(12). A transaction-start-ID column cannot have a DEFAULT clause. A transaction-start-ID column is not updatable.

DATA CHANGE OPERATION

Specifies that the database manager generates a value for each row that is inserted, for every row in which any column is updated, and for all rows deleted from a system-period temporal table when the history table is defined with ON DELETE ADD EXTRA ROW. The column will contain one of the following values:

- I** insert operation
- U** update operation
- D** delete operation

If *data-type* is not specified, the column is defined as CHAR(1). If *data-type* is specified it must be CHAR(1). The column cannot have a DEFAULT clause or a field procedure.

special-register

Specifies that the value of a special register is assigned by the database manager for each row that is inserted, for every row in which any column is updated, and for all rows deleted from a system-period temporal table when the history table is defined with ON DELETE ADD EXTRA ROW. The value of the special register at the time of the data change statement is used. If multiple rows are changed with a single SQL statement, the value for the column will be the same for all of the rows.

data-type must be defined according to the following table:

Special register	Data type for the column
CURRENT CLIENT_ACCTNG	VARCHAR(255)

Special register	Data type for the column
CURRENT CLIENT_APPLNAME	VARCHAR(255)
CURRENT CLIENT_PROGRAMID	VARCHAR(255)
CURRENT CLIENT_USERID	VARCHAR(255)
CURRENT CLIENT_WRKSTNNAME	VARCHAR(255)
CURRENT SERVER	VARCHAR(18)
SESSION_USER	VARCHAR(128)
USER	VARCHAR(18)

The column cannot have a DEFAULT clause or a field procedure.

built-in-global-variable

Specifies that the value of a built-in global variable is assigned by the database manager for each row that is inserted, for every row in which any column is updated, and for all rows deleted from a system-period temporal table when the history table is defined with ON DELETE ADD EXTRA ROW. The value of the built-in global variable at the time of the data change statement is used. If multiple rows are changed with a single SQL statement, the value for the column will be the same for all of the rows.

data-type must be defined according to the following table:

Built-in global variable	Data type for the column
QSYS2.JOB_NAME	VARCHAR(28)
QSYS2.SERVER_MODE_JOB_NAME	VARCHAR(28)
SYSIBM.CLIENT_HOST	VARCHAR(255)
SYSIBM.CLIENT_IPADDR	VARCHAR(128)
SYSIBM.CLIENT_PORT	INTEGER
SYSIBM.PACKAGE_NAME	VARCHAR(128)
SYSIBM.PACKAGE_SCHEMA	VARCHAR(128)
SYSIBM.PACKAGE_VERSION	VARCHAR(64)
SYSIBM.ROUTINE_SCHEMA	VARCHAR(128)
SYSIBM.ROUTINE_SPECIFIC_NAME	VARCHAR(128)
SYSIBM.ROUTINE_TYPE	CHAR(1)

The column cannot have a DEFAULT clause or a field procedure.

FIELDPROC

Designates an *external-program-name* as the field procedure exit routine for the column. It must be an ILE program that does not contain SQL. It cannot be a service program.

The field procedure encodes and decodes column values. Before a value is inserted in the column, it is passed to the field procedure for encoding. Before a value from the column is used, it is passed to the field procedure for decoding.

The field procedure is also invoked during the processing of the CREATE TABLE statement. When so invoked, the procedure provides Db2 with the column's field description. The field description defines the data characteristics of the encoded values. By contrast, the information supplied for the column in the CREATE TABLE statement defines the data characteristics of the decoded values.

constant

Specifies a parameter that is passed to the field procedure when it is invoked. A parameter list is optional.

A field procedure cannot be defined for a column that is a ROWID or DATALINK or a distinct type based on a ROWID or DATALINK. The column must not be an identity column, a row change timestamp column, a row-begin column, a row-end column, a transaction-start-ID column, or a generated expression column. The column must not have a default value of CURRENT DATE, CURRENT TIME, CURRENT TIMESTAMP, or USER. The column cannot be referenced in a check condition. If it is part of a foreign key, the corresponding parent key column must use the same field procedure. See [Embedded SQL programming](#) topic collection for an example of a field procedure.

NOT NULL

Prevents the column from containing null values. Omission of NOT NULL implies that the column can be null. NOT NULL is required for a row change timestamp column, a row-begin column, and a row-end column.

NOT HIDDEN

Indicates the column is included in implicit references to the table in SQL statements. This is the default.

IMPLICITLY HIDDEN

Indicates the column is not visible in SQL statements unless it is referred to explicitly by name. For example, SELECT * does not include any hidden columns in the result. A table must contain at least one column that is not IMPLICITLY HIDDEN.

datalink-options

Specifies the options associated with a DATALINK data type.

LINKTYPE URL

Defines the type of link as a Uniform Resource Locator (URL).

NO LINK CONTROL

Specifies that there will not be any check made to determine that the linked files exist. Only the syntax of the URL will be checked. There is no database manager control over the linked files.

period-definition

PERIOD FOR

Defines a period for the table.

SYSTEM_TIME (*begin-column-name*, *end-column-name*)

Defines a system period with the name SYSTEM_TIME. There must not be a column in the table with the name SYSTEM_TIME. A table can have only one SYSTEM_TIME period.

begin-column-name

Identifies the column that records the beginning of the period of time in which a row is valid. The name must identify a column that exists in the table. *begin-column-name* must not be the same as *end-column-name*. *begin-column-name* must be defined as AS ROW BEGIN.

end-column-name

Identifies the column that records the end of the period of time in which a row is valid. In the history table that is associated with a system-period temporal table, the history table column that corresponds to *end-column-name* in the system-period temporal table is set to reflect the deletion of the row. The name must identify a column that exists in the table. *end-column-name* must be defined as AS ROW END.

LIKE

table-name* or *view-name

Specifies that the columns defined in the specified table or view are included in this table. The *table-name* or *view-name* specified in a LIKE clause must identify the table or view that already exists at the application server.

The use of LIKE is an implicit definition of n columns, where n is the number of columns in the identified table or view. The implicit definition includes the following attributes of the n columns (if applicable to the data type):

- Column name (and system column name)

- Data type, length, precision, and scale
- CCSID

If the LIKE clause is specified immediately following the *table-name* and not enclosed in parenthesis, the following column attributes are also included, otherwise they are not included (the default value, identity, row change timestamp, and hidden attributes can also be controlled by using the *copy-options*):

- Default value, if a *table-name* is specified (*view-name* is not specified)
- Identity attributes
- Nullability
- Hidden attributes
- Row change timestamp attribute
- Column heading and text (see [“LABEL” on page 1399](#))

If *table-name* contains a row change timestamp column, row-begin column, row-end column, transaction-start-ID column, or generated expression column, the corresponding column of the new table inherits only the data type of the source column. The new column is not considered a generated column.

If the specified table or view is a non-SQL created physical file or logical file, any non-SQL attributes are removed. For example, the date and time format will be changed to ISO.

The implicit definition does not include any other optional attributes of the identified table or view. For example, the new table does not automatically include a primary key or foreign key from a table. The new table has these and other optional attributes only if the optional clauses are explicitly specified.

as-result-table

column-name

Names a column of the table. Do not qualify *column-name* and do not use the same name for more than one column of the table or for a system-column-name of the table.

FOR COLUMN *system-column-name*

Provides an IBM i name for the column. Do not use the same name for more than one column of the table or for a column-name of the table.

If the system-column-name is not specified, and the column-name is not a valid system-column-name, a system column name is generated. For more information about how system column names are generated, see [“Rules for Column Name Generation” on page 1156](#).

select-statement

Specifies that the columns of the table are to have the same name and description as the columns that would appear in the derived result table of the *select-statement* if the *select-statement* were to be executed. The use of AS *select-statement* is an implicit definition of *n* columns for the table, where *n* is the number of columns that would result from the *select-statement*. The implicit definition includes the following attributes of the *n* columns (if applicable to the data type):

- Column name (and system column name)
- Data type, length, precision, and scale
- CCSID
- Nullability
- Column heading and text (see [“LABEL” on page 1399](#))

The following attributes are not included (some attributes can be included by using the *copy-options*):

- Default value
- Hidden attribute
- Identity attributes

- Row change timestamp attribute
- Row-begin, row-end, and transaction-start-ID attribute
- Generated expression attribute

The implicit definition does not include any other optional attributes of the tables or views referenced in the *select-statement*.

The implicitly defined columns of the table inherit the names of the columns from the result table of the *select-statement*. Therefore, a column name must be specified in the *select-statement* or in the column name list for all result columns. For result columns that are derived from expressions, constants, and functions, the *select-statement* must include the AS column-name clause immediately after the result column or a name must be specified in the column list preceding the *select-statement*.

The *select-statement* must not refer to variables or include parameter markers (question marks). The *select-statement* must not contain a PREVIOUS VALUE or a NEXT VALUE expression. The UPDATE, SKIP LOCKED DATA, and USE AND KEEP EXCLUSIVE LOCKS clauses may not be specified.

If the *select-statement* contains an *isolation-clause* the isolation level specified in the *isolation-clause* applies to the entire SQL statement.

WITH DATA

Specifies that the *select-statement* is executed. After the table is created, the result table rows of the *select-statement* are automatically inserted into the table.

WITH NO DATA

Specifies that the *select-statement* is not executed. Therefore, there is no result table with a set of rows with which to automatically populate the table.

copy-options

INCLUDING IDENTITY COLUMN ATTRIBUTES or EXCLUDING IDENTITY COLUMN ATTRIBUTES

Specifies whether identity column attributes are inherited.

INCLUDING IDENTITY COLUMN ATTRIBUTES

Specifies that the table inherits the identity attribute, if any, of the columns resulting from *select-statement*, *table-name*, or *view-name*. In general, the identity attribute is copied if the element of the corresponding column in the table, view, or *select-statement* is the name of a table column or the name of a view column that directly or indirectly maps to the name of a base table column with the identity attribute. If the INCLUDING IDENTITY COLUMN ATTRIBUTES clause is specified with the AS *select-statement* clause, the columns of the new table do not inherit the identity attribute in the following cases:

- The select list of the *select-statement* includes multiple instances of an identity column name (that is, selecting the same column more than once).
- The select list of the *select-statement* includes multiple identity columns (that is, a join returned more than one identity column).
- The identity column is included in an expression in the select list.
- The *select-statement* includes a set operation (UNION or INTERSECT).

If INCLUDING IDENTITY is not specified, the table will not have an identity column.

EXCLUDING IDENTITY COLUMN ATTRIBUTES

Specifies that the table does not inherit the identity attribute, if any, of the columns resulting from the *fullselect*, *table-name*, or *view-name*.

EXCLUDING COLUMN DEFAULTS or INCLUDING COLUMN DEFAULTS or USING TYPE DEFAULTS

Specifies whether column defaults are inherited.

EXCLUDING COLUMN DEFAULTS

Specifies that the column defaults are not inherited from the definition of the source table. The default values of the column of the new table are either null or there are no default values. If the

column can be null, the default is the null value. If the column cannot be null, there is no default value, and an error occurs if a value is not provided for a column on INSERT for the new table.

INCLUDING COLUMN DEFAULTS

Specifies that the table inherits the default values of the columns resulting from the *select-statement*, *table-name*, or *view-name*. A default value is the value assigned to a column when a value is not specified on an INSERT.

Do not specify INCLUDING COLUMN DEFAULTS, if you specify USING TYPE DEFAULTS.

If INCLUDING COLUMN DEFAULTS is not specified, the default values are not inherited.

USING TYPE DEFAULTS

Specifies that the default values for the table depend on the data type of the columns that result from the *select-statement*, *table-name*, or *view-name*. If the column is nullable, then the default value is the null value. Otherwise, the default value is as follows:

Data type	Default value
Numeric	0
Fixed-length character or graphic string	Blanks
Fixed-length binary string	Hexadecimal zeros
Varying-length string	A string length of 0
Date	The current date at the time of INSERT
Time	The current time at the time of INSERT
Timestamp	The current timestamp at the time of INSERT
Datalink	A value corresponding to DLVALUE('','URL')
<i>distinct-type</i>	The default value of the corresponding source type of the distinct type.

Do not specify USING TYPE DEFAULTS if INCLUDING COLUMN DEFAULTS is specified.

INCLUDING IMPLICITLY HIDDEN COLUMN ATTRIBUTES or EXCLUDING IMPLICITLY HIDDEN COLUMN ATTRIBUTES

Specifies whether implicitly hidden columns are inherited.

INCLUDING IMPLICITLY HIDDEN COLUMN ATTRIBUTES

Specifies that the table inherits implicitly hidden columns from *select-statement*, *table-name*, or *view-name* and those columns will be defined with the implicitly hidden attribute in the new table.

If INCLUDING IMPLICITLY HIDDEN COLUMN ATTRIBUTES is not specified, the table will not have any implicitly hidden columns.

EXCLUDING IMPLICITLY HIDDEN COLUMN ATTRIBUTES

Specifies that the table does not inherit implicitly hidden columns from the *fullselect*, *table-name*, or *view-name*.

INCLUDING ROW CHANGE TIMESTAMP COLUMN ATTRIBUTES or EXCLUDING ROW CHANGE TIMESTAMP COLUMN ATTRIBUTES

Specifies whether the row change timestamp attribute is inherited.

INCLUDING ROW CHANGE TIMESTAMP COLUMN ATTRIBUTES

Specifies that the table inherits the row change timestamp attribute, if any, of the columns resulting from *select-statement*, *table-name*, or *view-name*. In general, the row change timestamp attribute is copied if the element of the corresponding column in the table, view, or *select-statement* is the name of a table column or the name of a view column that directly or indirectly maps to the name of a base table column with the row change timestamp attribute. If the INCLUDING ROW CHANGE TIMESTAMP COLUMN ATTRIBUTES clause is specified with the AS

select-statement clause, the columns of the new table do not inherit the row change timestamp in the following cases:

- The select list of the *select-statement* includes multiple instances of a row change timestamp column name (that is, selecting the same column more than once).
- The select list of the *select-statement* includes multiple row change timestamp columns (that is, a join returned more than one row change timestamp column).
- The row change timestamp column is included in an expression in the select list.
- The *select-statement* includes a set operation (UNION or INTERSECT).

If INCLUDING ROW CHANGE TIMESTAMP COLUMN ATTRIBUTES is not specified, the table will not have a row change timestamp column.

EXCLUDING ROW CHANGE TIMESTAMP COLUMN ATTRIBUTES

Specifies that the table does not inherit the row change timestamp attribute, if any, of the columns resulting from the *fullselect*, *table-name*, or *view-name*.

WITH REPLACE

Specifies that, in the case that a declared temporary table already exists with the specified name, the existing table is replaced with the temporary table defined by this statement (and all rows of the existing table are deleted).

When WITH REPLACE is not specified, then the name specified must not identify a declared temporary table that already exists in the current session.

ON COMMIT

Specifies the action taken on the declared temporary table when a COMMIT operation is performed. The default is DELETE ROWS.

The ON COMMIT clause does not apply if the declared temporary table is opened under isolation level No Commit (NC) or if a COMMIT HOLD operation is performed.

DELETE ROWS

All rows of the table will be deleted if no WITH HOLD cursor is open on the table.

PRESERVE ROWS

Rows of the table will be preserved.

NOT LOGGED

Changes to the table are not logged, including creation of the table. When a ROLLBACK (or ROLLBACK TO SAVEPOINT) operation is performed and the table was changed in the unit of work (or savepoint), the changes are not rolled back. If the table was created in the unit of work (or savepoint), then that table will be dropped. If the table was dropped in the unit of work (or savepoint) then the table will be restored, but with no rows.

ON ROLLBACK

Specifies the action taken on the declared temporary table when a ROLLBACK operation is performed.

The ON ROLLBACK clause does not apply if the declared temporary table was opened under isolation level No Commit (NC) or if a ROLLBACK HOLD operation is performed.

DELETE ROWS

All rows of the table will be deleted. This is the default.

PRESERVE ROWS

Rows of the table will be preserved.

RCDFMT *format-name*

An unqualified name that designates the IBM i record format name of the table. A *format-name* is a system identifier.

If a record format name is not specified, the *format-name* is the same as the *system-object-name* of the table.

media-preference

Specifies the preferred storage media for the table.

UNIT ANY

No storage media is preferred. Storage for the table will be allocated from any available storage media.

UNIT SSD

Solid state disk storage media is preferred. Storage for the table may be allocated from solid state disk storage media, if available.

KEEP IN MEMORY

Specifies whether the data for the table should be brought into a main storage pool when the data is used in a query.

NO

The data will not be brought into a main storage pool.

YES

The data will be brought into a main storage pool.

Notes

Instantiation, scope, and termination: Let P denote an application process and let T be a declared temporary table in an application program in P:

- When a program in P issues a DECLARE GLOBAL TEMPORARY TABLE statement, an empty instance of T is created.
- Any program in P can reference T, and any of those references is a reference to that same instance of T. (If a DECLARE GLOBAL TEMPORARY statement is specified within a compound statement of an SQL function, SQL procedure, or trigger; the scope of the declared temporary table is the application process and not the compound statement.)

If T was declared at a remote server, the reference to T must use the same connection that was used to declare T and that connection must not have been terminated after T was declared. When the connection to the database server at which T was declared terminates, T is dropped.

- If T is defined with the ON COMMIT DELETE ROWS clause, when a commit operation terminates a unit of work in P and no program in P has a WITH HOLD cursor open that is dependent on T, all rows are deleted.
- If T is defined with the ON ROLLBACK DELETE ROWS clause, when a rollback operation terminates a unit of work in P, all rows are deleted.
- When the application process that declared T terminates, T is dropped.

Temporary table ownership: The *owner* of the table is the user profile of the thread executing the statement.

Temporary table authority: When a declared temporary table is defined, PUBLIC implicitly is granted all table privileges on the table and authority to drop the table.

Referring to a declared temporary table in other SQL statements: Many SQL statements support declared temporary tables. To refer to a declared temporary table in an SQL statement other than DECLARE GLOBAL TEMPORARY TABLE, the table must be implicitly or explicitly qualified with SESSION.

If you use SESSION as the qualifier for a table name but the application process does not include a DECLARE GLOBAL TEMPORARY TABLE statement for the table name, the database manager assumes that you are not referring to a declared temporary table. The database manager resolves such table references to a permanent table.

Restrictions on the use of declared temporary tables:

- Declared temporary tables cannot be specified in an ALTER TABLE, COMMENT, CREATE ALIAS, GRANT, LABEL, LOCK, RENAME, or REVOKE statement.
- Declared temporary tables cannot be specified as the parent table in referential constraints

- If a declared temporary table is referenced in a CREATE INDEX or CREATE VIEW statement, the index or view must be created in SESSION (or library QTEMP).

Creating a table using a remote select-statement: The *select-statement* for an *as-result-table* can refer to tables on a different server than where the table is being created. This can be done by using a three-part object name or an alias that is defined to reference a three-part name of a table or view. The result of the *select-statement* cannot contain a column that has a field procedure defined. If the remote server is Db2 for LUW or Db2 for z/OS, *copy-options* are not allowed. If the remote server is Db2 for LUW, a column list should be explicitly specified before the AS keyword.

Syntax alternatives: The following keywords are synonyms supported for compatibility to prior releases. These keywords are non-standard and should not be used:

- INLINE LENGTH is a synonym for ALLOCATE.
- DEFINITION ONLY is a synonym for WITH NO DATA

Examples

Example 1: Define a declared temporary table with column definitions for an employee number, salary, commission, and bonus.

```
DECLARE GLOBAL TEMPORARY TABLE SESSION.TEMP_EMP
(EMPNO CHAR(6) NOT NULL,
 SALARY DECIMAL(9, 2),
 BONUS DECIMAL(9, 2),
 COMM DECIMAL(9, 2))
ON COMMIT PRESERVE ROWS
```

Example 2: Assume that base table USER1.EMPTAB exists and that it contains three columns, one of which is an identity column. Declare a temporary table that has the same column names and attributes (including identity attributes) as the base table.

```
DECLARE GLOBAL TEMPORARY TABLE TEMPTAB1
LIKE USER1.EMPTAB
INCLUDING IDENTITY
ON COMMIT PRESERVE ROWS
```

In the above example, the database manager uses SESSION as the implicit qualifier for TEMPTAB1.

DECLARE PROCEDURE

The DECLARE PROCEDURE statement defines an external procedure.

Invocation

This statement can only be embedded in an application program. It is not an executable statement. It must not be specified in REXX.

Authorization

None.

Syntax

➤ DECLARE — *procedure-name* — PROCEDURE ➤

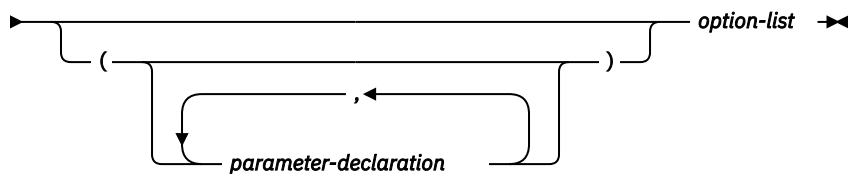

parameter-declaration

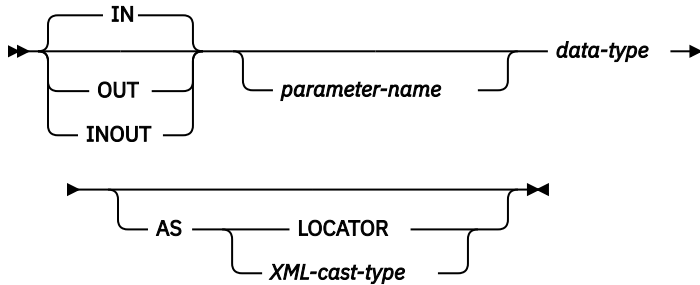

data-type

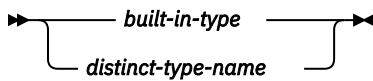

XML-cast-type

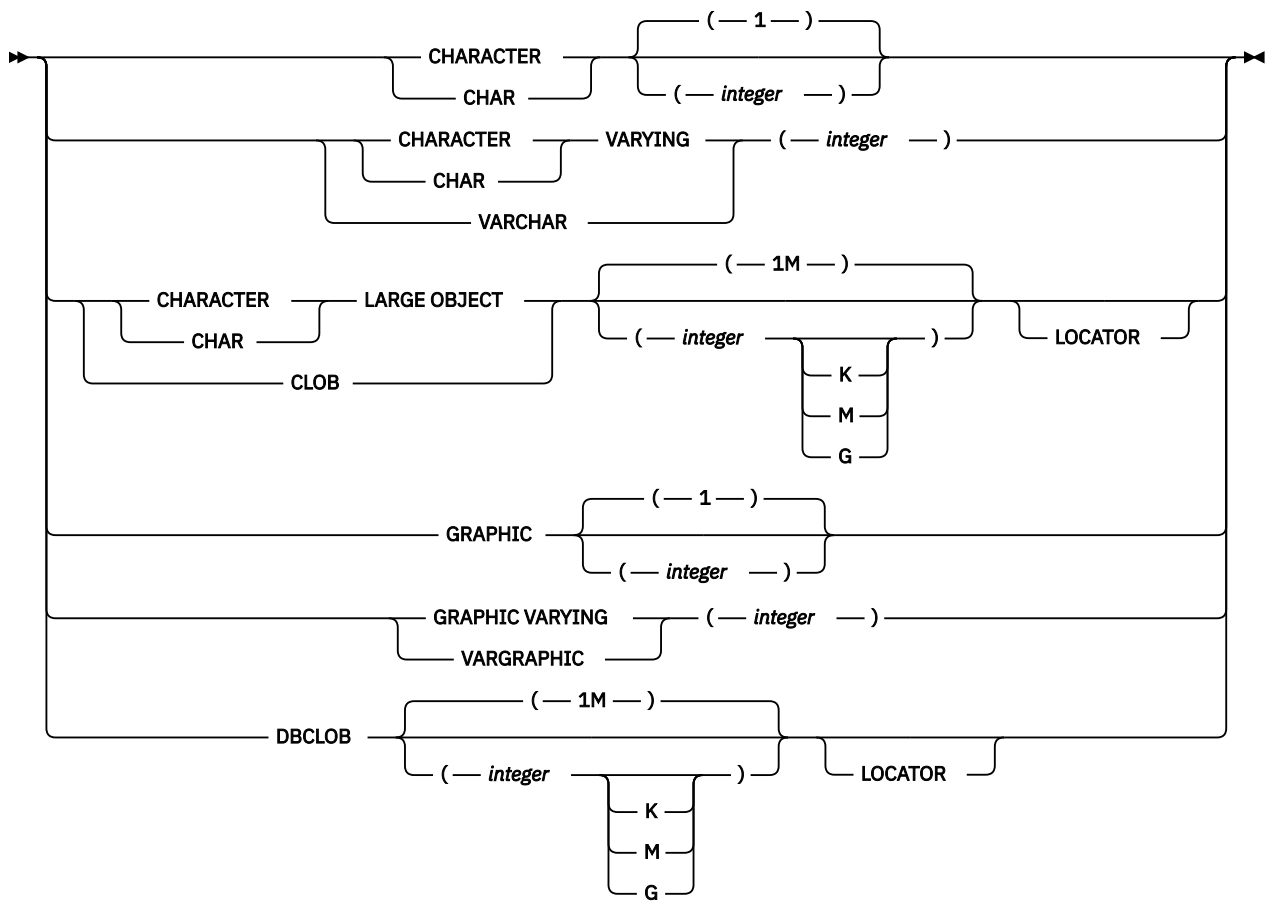

option-list

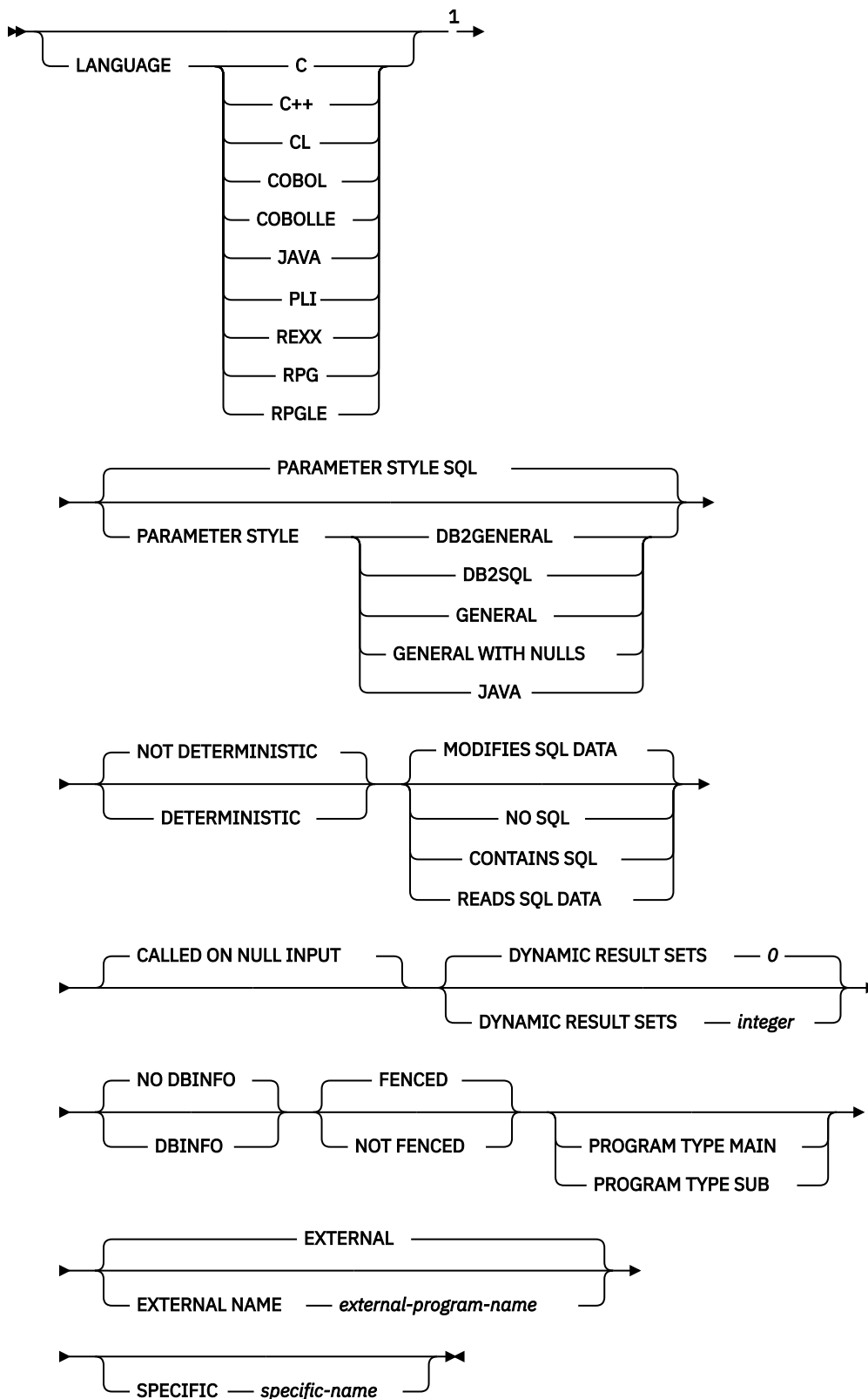

Notes:

¹ The optional clauses can be specified in a different order.

built-in-type

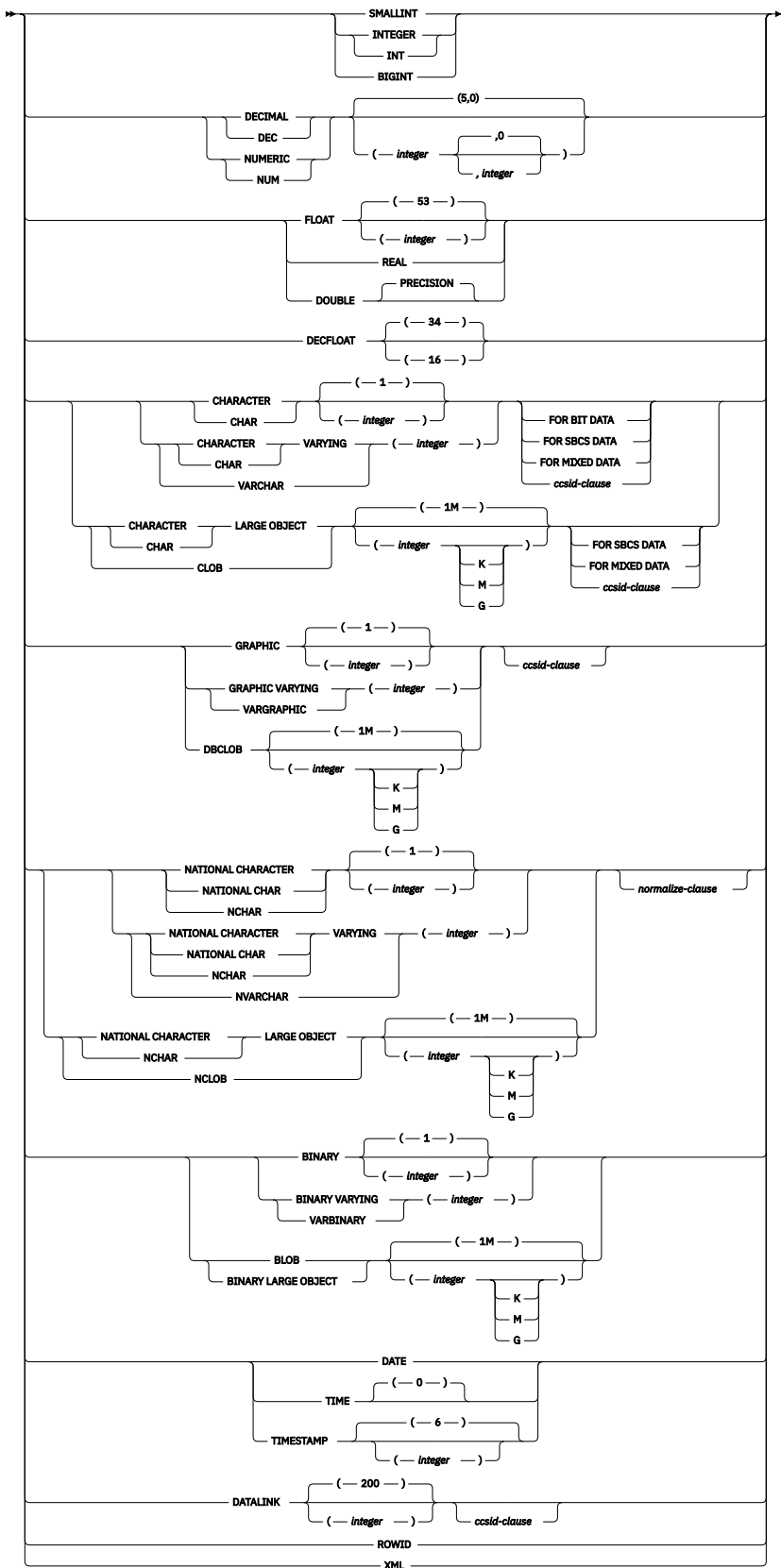

ccsid-clause

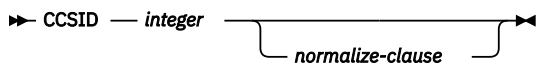

normalize-clause



Description

procedure-name

Names the procedure. The name must not be the same as the name of another procedure declared in your source program.

(parameter-declaration,...)

Specifies the number of parameters of the procedure and the data type of each parameter. A parameter for a procedure can be used only for input, only for output, or for both input and output. Although not required, you can give each parameter a name.

The maximum number of parameters allowed in CREATE PROCEDURE depends on the type of language and the parameter style:

- For JAVA and ILE programs and service programs, the maximum is 2000.
- For OPM programs and REXX,
 - If PARAMETER STYLE GENERAL is specified the maximum is 255.
 - If PARAMETER STYLE GENERAL WITH NULLS is specified the maximum is 254.
 - If PARAMETER STYLE SQL is specified the maximum is 254.

The maximum number of parameters can be further limited by the maximum number of parameters allowed by the language.

IN

Identifies the parameter as an input parameter to the procedure. Any changes made to the parameter within the procedure are not available to the calling SQL application when control is returned.¹⁰¹

OUT

Identifies the parameter as an output parameter that is returned by the procedure.

A DataLink or a distinct type based on a DataLink may not be specified as an output parameter.

INOUT

Identifies the parameter as both an input and output parameter for the procedure.

A DataLink or a distinct type based on a DataLink may not be specified as an input and output parameter.

parameter-name

Names the parameter. The name cannot be the same as any other *parameter-name* for the procedure.

data-type

Specifies the data type of the parameter.

The data type must be valid for the language specified in the language clause. All data types are valid for SQL procedures. DataLinks are not valid for external procedures. For more information about data types, see [“CREATE TABLE”](#) on page 1105, and the [SQL Programming](#) topic collection.

If a CCSID is specified, the parameter will be converted to that CCSID prior to passing it to the procedure. If a CCSID is not specified, the CCSID is determined by the default CCSID at the current server at the time the procedure is called.

Any parameter that has an XML type must specify the *XML-cast-type* clause.

¹⁰¹ When the language type is REXX, all parameters must be input parameters.

AS LOCATOR

Specifies that the parameter is a locator to the value rather than the actual value. You can specify AS LOCATOR only if the parameter has a LOB or XML data type or a distinct type based on a LOB or XML data type. If AS LOCATOR is specified, FOR SBCS DATA or FOR MIXED DATA must not be specified.

AS XML-cast-type

Specifies the data type passed to the procedure for a parameter that is XML type or a distinct type based on XML type. If LOCATOR is specified, the parameter is a locator to the value rather than the actual value.

If a CCSID value is specified, only Unicode CCSID values can be specified for graphic data types. If a CCSID value is not specified, the CCSID is established at the time the containing program, module, or service program is created according to the SQL_XML_DATA_CCSID QAQQINI option setting. The default CCSID is 1208. See [“XML Values” on page 80](#) for a description of this option.

DYNAMIC RESULT SETS *integer*

Specifies the maximum number of result sets that can be returned from the procedure. *integer* must be greater than or equal to zero and less than 32768. If zero is specified, no result sets are returned. If the SET RESULT SETS statement is issued, the number of results returned is the minimum of the number of result sets specified on this keyword and the SET RESULT SETS statement.

For more information about result sets, see [“SET RESULT SETS” on page 1527](#).

LANGUAGE

Specifies the language that the external program is written in. The language clause is required if the external program is a REXX procedure.

If LANGUAGE is not specified, the LANGUAGE is determined from the program attribute information associated with the external program. If the program attribute information associated with the program does not identify a recognizable language, then the language is assumed to be C.

C

The external program is written in C.

C++

The external program is written in C++.

CL

The external program is written in CL.

COBOL

The external program is written in COBOL.

COBOLLE

The external program is written in ILE COBOL.

JAVA

The external program is written in JAVA.

PLI

The external program is written in PL/I.

REXX

The external program is a REXX procedure.

RPG

The external program is written in RPG.

RPGLE

The external program is written in ILE RPG.

PARAMETER STYLE

Specifies the conventions used for passing parameters to and returning the values from procedures:

SQL

Specifies that in addition to the parameters on the CALL statement, several additional parameters are passed to the procedure. The parameters are defined to be in the following order:

- The first N parameters are the parameters that are specified on the DECLARE PROCEDURE statement.
- N parameters for indicator variables for the parameters.
- A CHAR(5) output parameter for SQLSTATE. The SQLSTATE returned indicates the success or failure of the procedure. The SQLSTATE returned is assigned by the external program.

The user may set the SQLSTATE to any valid value in the external program to return an error or warning from the function.

- A VARCHAR(517) input parameter for the fully qualified procedure name.
- A VARCHAR(128) input parameter for the specific name.
- A VARCHAR(1000) output parameter for the message text.

The following additional parameter may be passed as the last parameter:

- A parameter for the dbinfo structure, if DBINFO was specified on the CREATE PROCEDURE statement.

These parameters are passed according to the specified LANGUAGE. For example, if the language is C or C++, the VARCHAR parameters are passed as NUL-terminated strings. For more information about the parameters passed, see the include sqludf in the appropriate source file in library QSYSINC. For example, for C, sqludf can be found in QSYSINC/H.

PARAMETER STYLE SQL cannot be used with LANGUAGE JAVA.

DB2GENERAL

Specifies that the procedure will use a parameter passing convention that is defined for use with Java methods.

PARAMETER STYLE DB2GENERAL can only be specified with LANGUAGE JAVA. For details on passing parameters in JAVA, see the [IBM Developer Kit for Java](#) topic collection.

GENERAL

Specifies that the procedure will use a parameter passing mechanism where the procedure receives the parameters specified on the CALL. Additional arguments are not passed for indicator variables.

PARAMETER STYLE GENERAL cannot be used with LANGUAGE JAVA.

GENERAL WITH NULLS

Specifies that in addition to the parameters on the CALL statement as specified in GENERAL, another argument is passed to the procedure. This additional argument contains an indicator array with an element for each of the parameters of the CALL statement. In C, this would be an array of short INTs. For more information about how the indicators are handled, see the [SQL Programming](#) topic collection.

PARAMETER STYLE GENERAL WITH NULLS cannot be used with LANGUAGE JAVA.

JAVA

Specifies that the procedure will use a parameter passing convention that conforms to the Java language and SQLJ Routines specification. INOUT and OUT parameters will be passed as single entry arrays to facilitate returning values. For increased portability, you should write Java procedures that use the PARAMETER STYLE JAVA conventions.

PARAMETER STYLE JAVA can only be specified with LANGUAGE JAVA. For details on passing parameters in JAVA, see the [IBM Developer Kit for Java](#) topic collection.

Note that the language of the external function determines how the parameters are passed. For example, in C, any VARCHAR or CHAR parameters are passed as NUL-terminated strings. For more information, see [SQL Programming](#). For Java routines, see [IBM Developer Kit for Java](#).

SPECIFIC *specific-name*

Specifies a qualified or unqualified name that uniquely identifies the procedure. The *specific-name*, including the implicit or explicit qualifier, must be the same as the *procedure-name*.

If no qualifier is specified, the implicit or explicit qualifier of the *procedure-name* is used. If a qualifier is specified, the qualifier must be the same as the explicit or implicit qualifier of the *procedure-name*.

If *specific-name* is not specified, it is the same as the procedure name.

DETERMINISTIC or NOT DETERMINISTIC

Specifies whether the procedure returns the same results each time the procedure is called with the same IN and INOUT arguments.

NOT DETERMINISTIC

The procedure may not return the same result each time the procedure is called with the same IN and INOUT arguments, even when the referenced data in the database has not changed.

DETERMINISTIC

The procedure always returns the same results each time the procedure is called with the same IN and INOUT arguments, provided the referenced data in the database has not changed.

MODIFIES SQL DATA, READS SQL DATA, CONTAINS SQL, or NO SQL

Specifies which SQL statements, if any, may be executed in the procedure or any routine called from this procedure. The default is MODIFIES SQL DATA. See [Appendix B, “Characteristics of SQL statements,”](#) on page 1643 for a detailed list of the SQL statements that can be executed under each data access indication.

MODIFIES SQL DATA

Specifies that the procedure can execute any SQL statement except statements that are not supported in procedures.

READS SQL DATA

Specifies that SQL statements that do not modify SQL data can be included in the procedure.

CONTAINS SQL

Specifies that SQL statements that neither read nor modify SQL data can be executed by the procedure.

NO SQL

Specifies that the procedure cannot execute any SQL statements.

CALLED ON NULL INPUT

Specifies that the function is to be invoked, if any, or all, argument values are null, making the function responsible for testing for null argument values. The function can return a null or nonnull value.

FENCED or NOT FENCED

This parameter is allowed for compatibility with other products and is not used by Db2 for i.

PROGRAM TYPE MAIN or PROGRAM TYPE SUB

This parameter is allowed for compatibility with other products. It indicates whether the routine's external program is a program (*PGM) or a procedure in a service program (*SRVPGM).

PROGRAM TYPE MAIN

Specifies that the routine executes as the main entry point in a program. The external program must be a *PGM object.

PROGRAM TYPE SUB

Specifies that the procedure executes as a procedure in a service program. The external program must be a *SRVPGM object.

DBINFO

Specifies that the database manager should pass a structure containing status information to the procedure. [Table 88 on page 1244](#) contains a description of the DBINFO structure. Detailed information about the DBINFO structure can be found in include sqludf in the appropriate source file in library QSYSINC. For example, for C, sqludf can be found in QSYSINC/H.

DBINFO is only allowed with PARAMETER STYLE DB2SQL.

Table 88. DBINFO fields		
Field	Data Type	Description
Relational database	VARCHAR(128)	The name of the current server.
Authorization ID	VARCHAR(128)	The run-time authorization ID.
CCSID Information	INTEGER INTEGER INTEGER INTEGER INTEGER INTEGER INTEGER INTEGER INTEGER INTEGER CHAR(8)	<p>The CCSID information of the job. Three sets of three CCSIDs are returned. The following information identifies the three CCSIDs in each set:</p> <ul style="list-style-type: none"> • SBCS CCSID • DBCS CCSID • Mixed CCSID <p>Following the three sets of CCSIDs is an integer that indicates which set of three sets of CCSIDs is applicable and eight bytes of reserved space.</p> <p>Each set of CCSIDs is for a different encoding scheme (EBCDIC, ASCII, and Unicode).</p> <p>If a CCSID is not explicitly specified for a parameter on the CREATE PROCEDURE statement, the input string is assumed to be encoded in the CCSID of the job at the time the procedure is executed. If the CCSID of the input string is not the same as the CCSID of the parameter, the input string passed to the external procedure will be converted before calling the external program.</p>
Target Column	VARCHAR(128) VARCHAR(128) VARCHAR(128)	Not applicable for a call to a procedure.
Version and release	CHAR(8)	The version, release, and modification level of the database manager.
Platform	INTEGER	The server's platform type.

EXTERNAL NAME *external-program-name*

Specifies the program that will be executed when the procedure is called by the CALL statement. The program name must identify a program that exists at the application server. The program cannot be an ILE service program.

The validity of the name is checked at the application server. If the format of the name is not correct, an error is returned.

If *external-program-name* is not specified, the external program name is assumed to be the same as the procedure name.

Notes

DECLARE PROCEDURE scope: The scope of the *procedure-name* is the source program in which it is defined; that is, the program submitted to the precompiler. Thus, a program called from another separately compiled program or module will not use the attributes from a DECLARE PROCEDURE statement in the calling program.

DECLARE PROCEDURE rules: The DECLARE PROCEDURE statement should precede all CALL statements that reference that procedure.

The DECLARE PROCEDURE statement only applies to static CALL statements. It does not apply to any dynamically prepared CALL statements or a CALL statement where the procedure name is identified by a variable.

Syntax alternatives: The following keywords are synonyms supported for compatibility to prior releases. These keywords are non-standard and should not be used:

- The keywords VARIANT and NOT VARIANT can be used as synonyms for NOT DETERMINISTIC and DETERMINISTIC.
- The keywords NULL CALL can be used as synonyms for CALLED ON NULL INPUT.
- The keywords SIMPLE CALL can be used as a synonym for GENERAL.
- The value DB2GENRL may be used as a synonym for DB2GENERAL.
- The keywords PARAMETER STYLE in the PARAMETER STYLE clause are optional.
- The keywords PARAMETER STYLE DB2SQL can be used as a synonym for PARAMETER STYLE SQL.

Example

Declare an external procedure PROC1 in a C program. When the procedure is called using the CALL statement, a COBOL program named PGM1 in library LIB1 will be called.

```
EXEC SQL
DECLARE PROC1 PROCEDURE
           (CHAR(10), CHAR(10))
           EXTERNAL NAME LIB1.PGM1
           LANGUAGE COBOL GENERAL;

EXEC SQL
CALL PROC1 ('FIRSTNAME ', 'LASTNAME ');
```

DECLARE STATEMENT

The DECLARE STATEMENT statement is used for program documentation. It declares names that are used to identify prepared SQL statements.

Invocation

This statement can only be embedded in an application program. It is not an executable statement. This statement is not allowed in Java or REXX.

Authorization

None required.

Syntax

→ DECLARE *statement-name* STATEMENT →

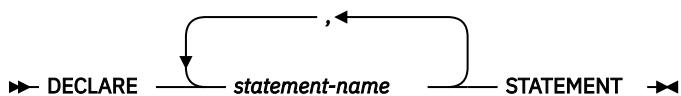

Description

statement-name

Lists one or more names that are used in your program to identify prepared SQL statements.

Example

This example shows the use of the DECLARE STATEMENT statement in a C program.

```
EXEC SQL INCLUDE SQLDA;
void main ()
{
  EXEC SQL BEGIN DECLARE SECTION ;
  char src_stmt[32000];
  char sqllda[32000]
  EXEC SQL END DECLARE SECTION ;
  EXEC SQL INCLUDE SQLCA ;

  strcpy(src_stmt,"SELECT DEPTNO, DEPTNAME, MGRNO \
  FROM DEPARTMENT \
  WHERE ADMRDEPT = 'A00'");

  EXEC SQL DECLARE OBJ_STMT STATEMENT;

  (Allocate storage from SQLDA)

  EXEC SQL DECLARE C1 CURSOR FOR OBJ_STMT;

  EXEC SQL PREPARE OBJ_STMT FROM :src_stmt;
  EXEC SQL DESCRIBE OBJ_STMT INTO :sqllda;

  (Examine SQLDA) (Set SQLDATA pointer addresses)

  EXEC SQL OPEN C1;

  while (strcmp(SQLSTATE, "00000", 5) )
  {
    EXEC SQL FETCH C1 USING DESCRIPTOR :sqllda;

    (Print results)

  }

  EXEC SQL CLOSE C1;
  return;
}
```

DECLARE VARIABLE

The DECLARE VARIABLE statement is used to assign a subtype or CCSID other than the default to a host variable.

Invocation

This statement can only be embedded in an application program. It is not an executable statement. It must not be specified in Java or REXX.

Authorization

None required.

Syntax

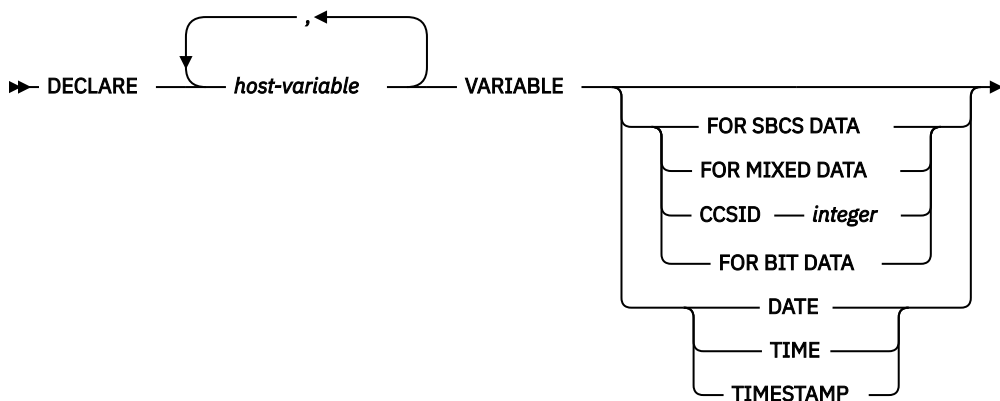

Description

host-variable

Names a character, graphic, or XML string host variable defined in the program. An indicator variable cannot be specified for the host-variable. The host-variable definition may either precede or follow a DECLARE VARIABLE statement that refers to that variable.

FOR BIT DATA

Specifies that the values of the host-variable are not associated with a coded character set and, therefore, are never converted. The CCSID of a FOR BIT DATA host variable is 65535. FOR BIT DATA cannot be specified for graphic or XML host-variables.

FOR SBCS DATA

Specifies that the values of the host variable contain SBCS (single-byte character set) data. FOR SBCS DATA is the default if the CCSID attribute of the job at the application requester is not DBCS-capable or if the length of the host variable is less than 4. The CCSID of FOR SBCS DATA is determined by the CCSID attribute of the job at the application requester. FOR SBCS DATA cannot be specified for graphic or XML host-variables.

FOR MIXED DATA

Specifies that the values of the host variable contain both SBCS data and DBCS data. FOR MIXED DATA is the default if the CCSID attribute of the job at the application requester is DBCS-capable and the length of the host variable is greater than 3. The CCSID of FOR DBCS DATA is determined by the CCSID attribute of the job at the application requester. FOR MIXED DATA cannot be specified for graphic or XML host-variables.

CCSID integer

Specifies that the values of the host variable contain data of CCSID integer. If the integer is an SBCS CCSID, the host variable is SBCS data. If the integer is a mixed data CCSID, the host variable is mixed data. For character host variables, the CCSID specified must be an SBCS or mixed CCSID.

If the variable has a graphic string data type, the CCSID specified must be a DBCS, UTF-16, or UCS-2 CCSID. For a list of valid CCSIDs, see [Appendix E, “CCSID values,” on page 1687](#). Consider specifying CCSID 1200 or 13488 to indicate UTF-16 or UCS-2 data. If a CCSID is not specified, the CCSID of the graphic string variable will be the associated DBCS CCSID for the job.

If the variable has an XML data type, the CCSID specified must be an SBCS, mixed, or Unicode CCSID. The CCSID must be compatible with the XML AS datatype. If a CCSID is not specified, the CCSID value as specified by the SQL_XML_DATA_CCSID QAQQINI setting is used. See [“XML Values” on page 80](#) for more information.

For file reference variables, the CCSID specifies the CCSID of the path and file name, not the data within the file.

DATE

Specifies that the values of the host variable contain data that is a date.

TIME

Specifies that the values of the host variable contain data that is a time.

TIMESTAMP

Specifies that the values of the host variable contain data that is a timestamp.

Notes

Placement restrictions: The DECLARE VARIABLE statement can be specified anywhere in an application program that SQL statements are valid with the following exceptions:

- If the host language is COBOL or RPG, the DECLARE VARIABLE statement must occur before an SQL statement that refers to a host variable specified in the DECLARE VARIABLE statement.
- If DATE, TIME, or TIMESTAMP is specified for a NUL-terminated character string in C, the length of the C declaration will be reduced by one.

Precompiler rules: The following situations result in an error message during precompile:

- A reference is made to a variable that does not exist.
- A reference is made to a numeric variable.
- A reference is made to a variable that has been referred to already.
- A reference is made to a variable that is not unique.
- A reference is made to an ILE RPG variable that is defined as UCS-2.
- A reference is made to an ILE COBOL variable that is defined as NATIONAL.
- The DECLARE VARIABLE statement occurs after an SQL statement where the SQL statement and the DECLARE VARIABLE statement refer to the same variable.
- The FOR BIT DATA, FOR SBCS DATA, or FOR MIXED DATA clause is specified for a graphic or XML host variable.
- A SBCS or mixed CCSID is specified for a graphic host variable.
- A DBCS, UTF-16, or UCS-2 CCSID is specified for a character host variable.
- A DBCS CCSID is specified for an XML host variable.
- DATE, TIME, or TIMESTAMP is specified for a host variable that is not character.
- The length of a host variable used for DATE, TIME, or TIMESTAMP is not long enough for the minimum date, time, or timestamp value.

Example

In this example, declare C program variables *fred* and *pete* as mixed data, and *jean* and *dave* as SBCS data with CCSID 37.

```
void main ()
{
    EXEC SQL BEGIN DECLARE SECTION;
    char fred[10];
    EXEC SQL DECLARE :fred VARIABLE FOR MIXED DATA;

    decimal(6,0) mary;
    char pete[4];
    EXEC SQL DECLARE :pete VARIABLE FOR MIXED DATA;

    char jean[30];
    char dave[9];
    EXEC SQL DECLARE :jean, :dave VARIABLE CCSID 37;
    EXEC SQL END DECLARE SECTION;
    EXEC SQL INCLUDE SQLCA;
    ...
}
```

DELETE

The DELETE statement deletes rows from a table or view. Deleting a row from a view deletes the row from the table on which the view is based if no INSTEAD OF DELETE trigger is defined for this view. If such a trigger is defined, the trigger will be activated instead.

There are two forms of this statement:

- The *Searched* DELETE form is used to delete one or more rows (optionally determined by a search condition).
- The *Positioned* DELETE form is used to delete exactly one row (as determined by the current position of a cursor).

Invocation

A Searched DELETE statement can be embedded in an application program or issued interactively. A Positioned DELETE must be embedded in an application program. Both forms are executable statements that can be dynamically prepared.

Authorization

The privileges held by the authorization ID of the statement must include at least one of the following:

- For the table or view identified in the statement:
 - The DELETE privilege on the table or view, and
 - The USAGE privilege on the schema containing the table or view
- Database administrator authority

If the *search-condition* in a Searched DELETE contains a reference to a column of the table or view, then the privileges held by the authorization ID of the statement must also include one of the following:

- The SELECT privilege on the table or view
- Database administrator authority

If *search-condition* includes a subquery, the privileges held by the authorization ID of the statement must also include at least one of the following:

- For each table or view identified in the subquery:
 - The SELECT privilege on the table or view, and
 - The USAGE privilege on the schema containing the table or view
- Database administrator authority

For information about the system authorities corresponding to SQL privileges, see [Corresponding System Authorities When Checking Privileges to a Table or View](#).

Syntax

Searched DELETE:

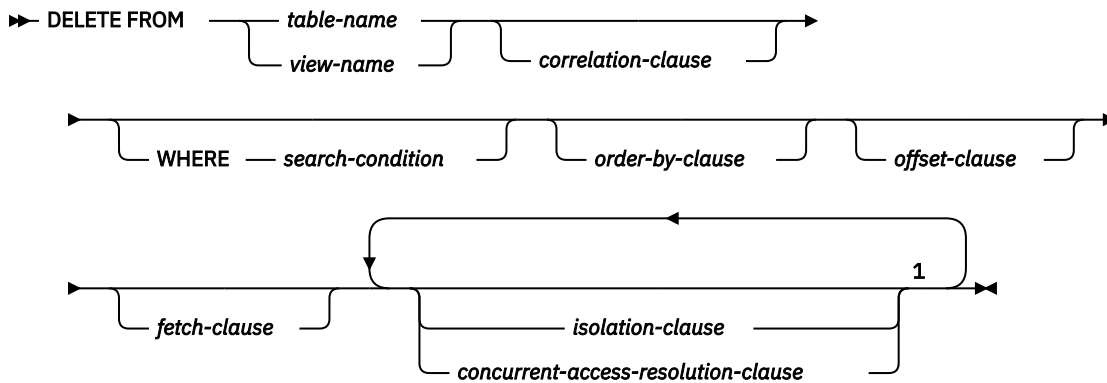

Notes:

¹ The same clause must not be specified more than once.

Positioned DELETE:

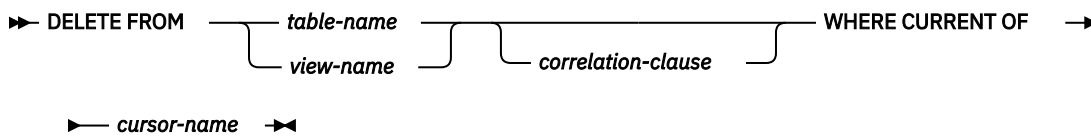

order-by-clause

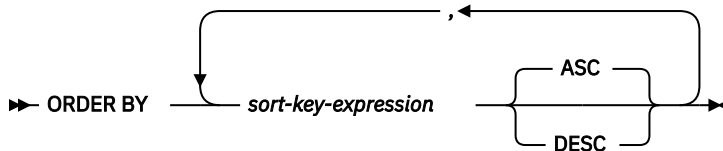

isolation-clause

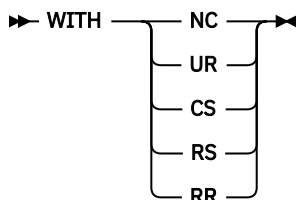

Description

FROM *table-name* or *view-name*

Identifies the table or view from which rows are to be deleted. The name must identify a table or view that exists at the current server, but it must not identify a catalog table, a view of a catalog table, or a view that is not deletable. For an explanation of deletable views, see [“CREATE VIEW”](#) on page 1198.

correlation-clause

Specifies an alternate name that can be used within the *search-condition* to designate the table or view. For an explanation of *correlation-clause*, see [Chapter 6, “Queries,”](#) on page 723. For an explanation of *correlation-name*, see [“Correlation names”](#) on page 133.

WHERE

Specifies the rows to be deleted. The clause can be omitted, or a *search-condition* or *cursor-name* can be specified. If the clause is omitted, all rows of the table or view are deleted.

search-condition

Is any search condition as described in [“Search conditions”](#) on page 228. Each *column-name* in the *search-condition*, other than in a subquery, must identify a column of the table or view.

The *search-condition* is applied to each row of the table or view and the deleted rows are those for which the result of the *search-condition* is true.

If the *search-condition* contains a subquery, the subquery can be thought of as being executed each time the *search condition* is applied to a row, and the results used in applying the *search condition*. In actuality, a subquery with no correlated references may be executed only once, whereas a subquery with a correlated reference may have to be executed once for each row.

If a subquery refers to the object table of the DELETE statement or a dependent table with a delete rule of CASCADE, SET NULL, or SET DEFAULT, the subquery is completely evaluated before any rows are deleted.

CURRENT OF *cursor-name*

Identifies the cursor to be used in the delete operation. The *cursor-name* must identify a declared cursor as explained in the Notes for the DECLARE CURSOR statement.

The table or view identified must also be specified in the FROM clause of the *select-statement* of the cursor and the cursor must be deletable. For an explanation of deletable cursors, see [“DECLARE CURSOR” on page 1207](#).

The DECLARE CURSOR statement must not have a period-specification for the table or view used by the delete statement.

When the DELETE statement is executed, the cursor must be positioned on a row; that row is the one deleted. After the deletion, the cursor is positioned before the next row of its result table. If there is no next row, the cursor is positioned after the last row.

order-by-clause

Specifies the order of the rows for application of the *offset-clause* and *fetch-clause*. An *order-by-clause* should be specified to ensure a predictable order for determining the set of rows to be deleted based on the *offset-clause* and *fetch-clause*.

sort-key-expression

An expression that specifies the value that is to be used to order the rows that qualify for the delete operation. If a single *sort-key-expression* is identified, the rows are ordered by the values of that *sort-key-expression*. If more than one *sort-key-expression* is identified, the rows are ordered by the values of the first *sort-key-expression*, then by the values of the second *sort-key-expression*, and so on.

The result of the *sort-key-expression* must not be DATALINK or XML.

ASC

Uses the values of the *sort-key-expression* in ascending order. This is the default.

DESC

Uses the values of the *sort-key-expression* in descending order.

Ordering is performed in accordance with the comparison rules described in [Chapter 2, “Language elements,” on page 43](#). The null value is higher than all other values. If your ordering specification does not determine a complete ordering, rows with duplicate values of the last identified *sort-key-expression* have an arbitrary order. If you do not specify ORDER BY, the rows to be deleted have an arbitrary order.

offset-clause

Limits the effect of the delete by skipping a subset of the qualifying rows. For more information on the *offset-clause*, see [“offset-clause” on page 767](#).

fetch-clause

Limits the effect of the delete to a subset of the qualifying rows. For more information on the *fetch-clause*, see [“fetch-clause” on page 768](#).

isolation-clause

Specifies the isolation level to be used for this statement.

WITH

Introduces the isolation level, which may be one of:

- *RR* Repeatable read
- *RS* Read stability
- *CS* Cursor stability
- *UR* Uncommitted read
- *NC* No commit

If *isolation-clause* is not specified the default isolation is used. For more information on the default isolation, see [“isolation-clause” on page 787](#).

concurrent-access-resolution-clause

Specifies the concurrent access resolution to use for the select statement. For more information, see [“concurrent-access-resolution-clause” on page 789](#).

DELETE Rules

Triggers: If the identified table or the base table of the identified view has a delete trigger, the trigger is activated. A trigger might cause other statements to be executed or return error conditions based on the deleted values.

Referential Integrity: If the identified table or the base table of the identified table is a parent table, the rows selected must not have any dependents in a relationship with a delete rule of RESTRICT or NO ACTION, and the DELETE must not cascade to descendent rows that have dependents in a relationship with a delete rule of RESTRICT or NO ACTION.

If the delete operation is not prevented by a RESTRICT or NO ACTION delete rule, the selected rows are deleted. Any rows that are dependents of the selected rows are also affected:

- The nullable columns of the foreign keys of any rows that are their dependents in a relationship with a delete rule of SET NULL are set to the null value.
- Any rows that are their dependents in a relationship with a delete rule of CASCADE are also deleted, and the above rules apply, in turn to those rows.
- The columns of the foreign keys of any rows that are their dependents in a relationship with a delete rule of SET DEFAULT are set to the corresponding default value.

The referential constraints (other than a referential constraint with a RESTRICT delete rule), are effectively checked at the end of the statement. In the case of a multiple-row delete, this would occur after all rows were deleted and any associated triggers were activated.

Check Constraints: A check constraint can prevent the deletion of a row in a parent table when there are dependents in a relationship with a delete rule of SET NULL or SET DEFAULT. If deleting a row in the parent table would cause a column in a dependent table to be set to null or a default value and the null or default value would cause a search condition of a check constraint to evaluate to false, the row is not deleted.

Notes

Delete operation errors: If an error occurs while executing any delete operation, changes from this statement, referential constraints, and any triggered SQL statements are rolled back (unless the isolation level is NC for this statement or any other triggered SQL statements).

Locking: Unless appropriate locks already exist, one or more exclusive locks are acquired during the execution of a successful DELETE statement. Until the locks are released by a commit or rollback operation, the effect of the DELETE operation can only be perceived by:

- The application process that performed the deletion
- Another application process using isolation level UR or NC

The locks can prevent other application processes from performing operations on the table. For further information about locking, see the description of the COMMIT, ROLLBACK, and LOCK TABLE statements, and [“Isolation level” on page 23](#).

If an application process deletes a row on which any of its non-updatable cursors are positioned, those cursors are positioned before the next row of their result table. Let C be a cursor that is positioned before the next row R (as the result of an OPEN, a DELETE through C, a DELETE through some other cursor, or a Searched DELETE). In the presence of INSERT, UPDATE, and DELETE operations that affect the base table from which R is derived, the next FETCH operation referencing C does not necessarily position C on R. For example, the operation can position C on R' where R' is a new row that is now the next row of the result table.

A maximum of 4000000 rows can be deleted or changed in any single DELETE statement when COMMIT(*RR), COMMIT(*ALL), COMMIT(*CS), or COMMIT(*CHG) was specified. The number of rows changed includes any rows inserted, updated, or deleted under the same commitment definition as a result of a trigger, a CASCADE, SET NULL, or SET DEFAULT referential integrity delete rule.

Position of cursor: If an application process deletes a row on which any of its cursors are positioned, those cursors are positioned before the next row of their result table. Let C be a cursor that is positioned before row R (as a result of an OPEN, a DELETE through C, a DELETE through some other cursor, or a Searched DELETE). In the presence of INSERT, UPDATE, and DELETE operations that affect the base table from which R is derived, the next FETCH operation referencing C does not necessarily position C on R. For example, the operation can position C on R', where R' is a new row that is now the next row of the result table.

Number of rows deleted: When a DELETE statement is completed, the number of rows deleted is returned in the ROW_COUNT condition area item in the SQL Diagnostics Area (or SQLERRD(3) in the SQLCA). The value in the ROW_COUNT item does not include the number of rows that were deleted as a result of a CASCADE delete rule or a trigger.

For a description of the SQLCA, see [Appendix C, “SQLCA \(SQL communication area\),” on page 1657](#).

DELETE Performance: An SQL DELETE statement that does not contain a WHERE clause, *offset-clause*, or *fetch-clause* will delete all rows of a table. In this case, the rows may be deleted using either a clear operation (if not running under commitment control) or a change file operation (if running under commitment control). If running under commitment control, the deletes can still be committed or rolled back. This implementation will be much faster than individually deleting each row, but individual journal entries for each row will not be recorded in the journal. This technique will only be used if all the following are true:

- The target table is not a view.
- The target table is not a system-period temporal table.
- A significant number of rows are being deleted.
- The job issuing the DELETE statement does not have an open cursor on the file (not including pseudo-closed SQL cursors).
- No other job has a lock on the table.
- The table does not have an active delete trigger.
- The table is not the parent in a referential constraint with a CASCADE, SET NULL, or SET DEFAULT delete rule.
- The user issuing the DELETE statement has *OBJMGT or *OBJALTER system authority on the table in addition to the DELETE privilege.
- The SQL_FAST_DELETE_ROW_COUNT QAQQINI option allows fast delete.

If this technique is successful, the number of increments (see the SIZE keyword on the CHGPF CL command) is set to zero.

The TRUNCATE statement can be used to delete all rows from a table.

Referential integrity considerations: The DB2_ROW_COUNT_SECONDARY condition information item in the SQL Diagnostics Area (or SQLERRD(5) in the SQLCA) shows the number of rows affected by referential

constraints. It includes rows that were deleted as the result of a CASCADE delete rule and rows in which foreign keys were set to NULL or the default value as the result of a SET NULL or SET DEFAULT delete rule.

For a description of DB2_ROW_COUNT_SECONDARY, see [“GET DIAGNOSTICS” on page 1324](#). For a description of the SQLCA, see [Appendix C, “SQLCA \(SQL communication area\),” on page 1657](#).

Deleting rows in a table for which row access control is enforced: When a DELETE statement is issued for a table for which row access control is enforced, the rules specified in the enabled row permissions determine whether the row can be deleted. Typically those rules are based on the authorization ID of the statement. The following describes how enabled row permissions and column masks are used during DELETE:

- Row permissions are used to identify the set of rows to be deleted.

When multiple enabled row permissions are defined for a table, a row access control search condition is derived by application of the logical OR operator to the search condition in each enabled permission.

This row access control search condition is applied to the table to determine which rows are accessible to the authorization ID of the DELETE statement. If the WHERE clause is specified in the DELETE statement, the user-specified predicates are applied on the accessible rows to determine the rows to be deleted. If there is no WHERE clause, all the accessible rows are the rows to be deleted.

Considerations for a system-period temporal table: If the DELETE statement has a search condition that contains a correlated subquery that references the history table (explicitly referencing the name of the history table or implicitly referenced through the use of a period specification in the FROM clause), the deleted rows that are stored as historical rows are potentially visible for delete operations for the rows that are subsequently processed for the statement.

If the CURRENT TEMPORAL SYSTEM_TIME special register is set to a non-null value and the value of the SYSTIME option is YES, the underlying target of the DELETE statement must not be a system-period temporal table. This restriction applies regardless of whether the system-period temporal table is directly or indirectly referenced.

Considerations for a history table: When a row of a system-period temporal table is deleted, a historical copy of the row is inserted into the corresponding history table and the end timestamp of the historical row is captured in the form of a system determined value that corresponds to the time of the data change operation. The database manager assigns the value that is generated using a reading of the time-of-day clock during execution of the first data change statement in the transaction that requires a value to be assigned to the row begin or transaction start-ID column in a table, or a row in a system-period temporal table is deleted. The database manager ensures uniqueness of the generated values for an end column in a history table across transactions. The timestamp value might be adjusted to ensure that rows inserted into the history table have the end timestamp value greater than the begin timestamp value which can happen when a conflicting transaction is updating the same row in the system-period temporal table. The SYSTIME_PERIOD_ADJ QAQQINI option must be set to *ADJUST for this adjustment to the timestamp value to occur. Otherwise an error is returned.

For a delete operation, the adjustment only affects the value for the end column in the history table that corresponds to the row-end column in the associated system-period temporal table. Take these adjustments into consideration on subsequent references to the table when there is a search for the transaction start time in the row-begin column and row-end column for the SYSTEM_TIME period of the associated system-period temporal table.

When the history table is defined with ON DELETE ADD EXTRA ROW, the version of the row prior to the delete is added to the history table. Values for the row begin, row end, and any generated expression columns are generated when this row is added. This information represents when the row was deleted.

REXX: Variables cannot be used in the DELETE statement within a REXX procedure. Instead, the DELETE must be the object of a PREPARE and EXECUTE using parameter markers.

Syntax alternatives: The following keywords are synonyms supported for compatibility to prior releases. These keywords are non-standard and should not be used:

- The keyword NONE can be used as a synonym for NC.
- The keyword CHG can be used as a synonym for UR.

- The keyword ALL can be used as a synonym for RS.
- The FROM keyword is optional.

Examples

Example 1: Delete department (DEPTNO) 'D11' from the DEPARTMENT table.

```
DELETE FROM DEPARTMENT
WHERE DEPTNO = 'D11'
```

Example 2: Delete all the departments from the DEPARTMENT table (that is, empty the table).

```
DELETE FROM DEPARTMENT
```

Example 3: Use a Java program statement to delete all the subprojects (MAJPROJ is NULL) from the PROJECT table on the connection context 'ctx', for a department (DEPTNO) equal to that in the host variable HOSTDEPT (java.lang.String).

```
#sql [ctx] { DELETE FROM PROJECT
WHERE DEPTNO = :HOSTDEPT
AND MAJPROJ IS NULL };
```

Example 4: Code a portion of a Java program that will be used to display retired employees (JOB) and then, if requested to do so, remove certain employees from the EMPLOYEE table on the connection context 'ctx'.

```
#sql iterator empIterator implements sqlj.runtime.ForUpdate
( ... );
empIterator C1;

#sql [ctx] C1 = { SELECT * FROM EMPLOYEE
WHERE JOB = 'RETIRED' };

#sql { FETCH C1 INTO ... };
while ( !C1.endFetch() ) {
    System.out.println( ... );
    if ( condition for deleting row ) {
        #sql [ctx] { DELETE FROM EMPLOYEE
WHERE CURRENT OF C1 };
    }
    #sql { FETCH C1 INTO ... };
}
C1.close();
```

DESCRIBE

The DESCRIBE statement obtains information about a prepared statement.

For an explanation of prepared statements, see [“PREPARE” on page 1427](#).

Invocation

This statement can only be embedded in an application program, SQL function, SQL procedure, or trigger. It is an executable statement that cannot be dynamically prepared. It must not be specified in Java.

Authorization

None required. See [“PREPARE” on page 1427](#) for the authorization required to create a prepared statement.

Syntax

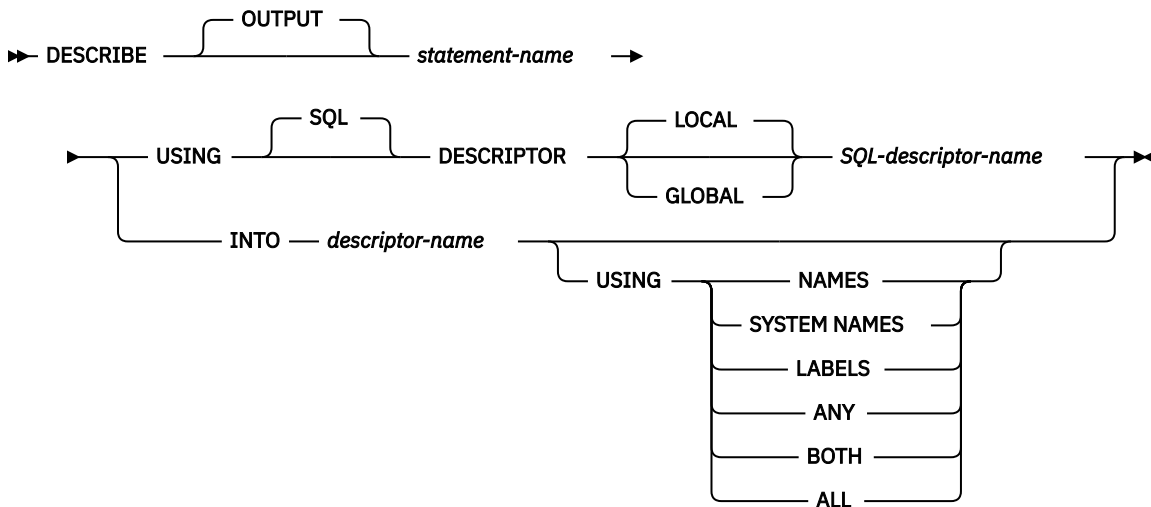

Description

statement-name

Identifies the prepared statement. When the DESCRIBE statement is executed, the name must identify a prepared statement at the application server.

If the prepared statement is a fullselect or VALUES INTO statement, the information returned describes the columns in its result table. If the prepared statement is a CALL statement, the information returned describes the OUT and INOUT parameters of the procedure.

USING

Identifies an SQL descriptor.

LOCAL

Specifies the scope of the name of the descriptor to be local to program invocation.

GLOBAL

Specifies the scope of the name of the descriptor to be global to the SQL session.

SQL-descriptor-name

Names the SQL descriptor. The name must identify a descriptor that already exists with the specified scope.

See [“GET DESCRIPTOR” on page 1311](#) for an explanation of the information that is placed in the SQL descriptor.

INTO descriptor-name

Identifies an SQL descriptor area (SQLDA), which is described in Appendix D, “[SQLDA \(SQL descriptor area\)](#),” on page 1667. Before the DESCRIBE statement is executed, the following variable in the SQLDA must be set.

SQLN

Indicates the number of SQLVAR entries provided in the SQLDA. SQLN must be set to a value greater than or equal to zero before the DESCRIBE statement is executed. For information about techniques to determine the number of occurrences requires, see “[Determining how many SQLVAR occurrences are needed](#)” on page 1670.

The rules for REXX are different. For more information, see the [Embedded SQL Programming](#) topic collection.

When the DESCRIBE statement is executed, the database manager assigns values to the variables of the SQLDA as follows:

SQLDAID

The first 6 bytes are set to 'SQLDA ' (that is, 5 letters followed by the space character).

The seventh byte is set based on the result columns described:

- If the SQLDA contains two, three, or four SQLVAR entries for every select list item (or, column of the result table), the seventh byte is set to '2', '3', or '4'. This technique is used in order to accommodate LOB or distinct type result columns, labels, and system names.
- Otherwise, the seventh byte is set to the space character.

The seventh byte is set to the space character if there is not enough room in the SQLDA to contain the description of all result columns.

The eighth byte is set to the space character.

SQLDABC

Length of the SQLDA in bytes.

SQLD

If the prepared statement is a SELECT, SQLD is set to the number of columns in its result table plus the number of extended SQLVAR entries. For information about extended SQLVAR entries see, “[Field descriptions in an occurrence of SQLVAR](#)” on page 1673. If the prepared statement is a CALL statement, SQLD is set to the number of OUT and INOUT parameters of the procedure. If the prepared statement is a VALUES INTO, SQLD is set to the number of expressions in the VALUES clause plus the number of extended SQLVAR entries. Otherwise, SQLD is set to 0.

SQLVAR

If the value of SQLD is 0, or greater than the value of SQLN, no values are assigned to occurrences of SQLVAR.

If the value of SQLD is n , where n is greater than 0 but less than or equal to the value of SQLN, values are assigned to the first n occurrences of SQLVAR so that the first occurrence of SQLVAR contains a description of the first column of the result table (or parameter or expression in the VALUES clause), the second occurrence of SQLVAR contains a description of the second column of the result table (or parameter or expression in the VALUES clause), and so on. For information about the values assigned to SQLVAR occurrences, see “[Field descriptions in an occurrence of SQLVAR](#)” on page 1673.

USING

Specifies what value to assign to each SQLNAME variable in the SQLDA. If the requested value does not exist or if the length of a name is greater than 30, SQLNAME is set to a length of 0.

NAMES

Assigns the name of the column (or parameter). This is the default. For the DESCRIBE of a prepared statement where the name is explicitly listed in the select-list, the name specified is returned. The column name returned is case sensitive and without delimiters.

SYSTEM NAMES

Assigns the system column name of the column.

LABELS

Assigns the label of the column. (Column labels are defined by the LABEL statement.) Only the first 20 bytes of the label are returned.

ANY

Assigns the column label. If the column has no label, the column name is used instead.

BOTH

Assigns both the label and name of the column. In this case, two or three occurrences of SQLVAR per column, depending on whether the result set contains distinct types, are needed to accommodate the additional information. To specify this expansion of the SQLVAR array, set SQLN to $2*n$ or $3*n$ (where n is the number of columns in the table or view). The first n occurrences of SQLVAR contain the column names. Either the second or third n occurrences contain the column labels. If there are no distinct types, the labels are returned in the second set of SQLVAR entries. Otherwise, the labels are returned in the third set of SQLVAR entries.

ALL

Assigns the label, column name, and system column name. In this case three or four occurrences of SQLVAR per column, depending on whether the result set contains distinct types, are needed to accommodate the additional information. To specify this expansion of the SQLVAR array, set SQLN to $3*n$ or $4*n$ (where n is the number of columns in the result table). The first n occurrences of SQLVAR contain the system column names. The second or third n occurrences contain the column labels. The third or fourth n occurrences contain the column names if they are different from the system column name. Otherwise the SQLNAME field is set to a length of zero. If there are no distinct types, the labels are returned in the second set of SQLVAR entries and the column names are returned in the third set of SQLVAR entries. Otherwise, the labels are returned in the third set of SQLVAR entries and the column names are returned in the fourth set of SQLVAR entries.

Notes

PREPARE INTO: Information about a prepared statement can also be obtained by using the INTO clause of the PREPARE statement.

Allocating the SQL descriptor: Before the DESCRIBE statement is executed, the SQL descriptor must be allocated using the ALLOCATE DESCRIPTOR statement. If the number of descriptor items allocated is less than the number of result columns, a warning (SQLSTATE 01005) is returned.

Allocating the SQLDA: In C, COBOL, PL/I, and RPG, before the DESCRIBE or PREPARE INTO statement is executed, enough storage must be allocated for some number of SQLVAR occurrences. SQLN must then be set to the number of SQLVAR occurrences that were allocated. To obtain the description of the columns of the result table of a prepared SELECT statement, the number of occurrences of SQLVAR entries must not be less than the number of columns. Furthermore, if the columns include LOBs or distinct types, the number of occurrences of SQLVAR entries should be two times the number of columns. See [“Determining how many SQLVAR occurrences are needed” on page 1670](#) for more information. Among the possible ways to allocate the SQLDA are the three described below:

First technique

Allocate an SQLDA with enough occurrences of SQLVAR entries to accommodate any select list that the application will have to process. At the extreme, the number of SQLVARs could equal two times the maximum number of columns allowed in a result table. Having done the allocation, the application can use this SQLDA repeatedly.

This technique uses a large amount of storage that is never deallocated, even when most of this storage is not used for a particular select list.

Second technique

Repeat the following three steps for every processed select list:

1. Execute a DESCRIBE statement with an SQLDA that has no occurrences of SQLVAR entries; that is, an SQLDA for which SQLN is zero. The value returned for SQLD is either the required number of occurrences of SQLVAR entries or the number of result columns. Because there were no SQLVAR entries, a warning will be issued.¹⁰²

2. If the seventh byte of SQLDAID field is not a blank, then allocate an SQLDA with (the value in the seventh byte of SQLDAID) * SQLD occurrences and set SQLN in the new SQLDA to (the value in the seventh byte of SQLDAID) * SQLD. Otherwise, allocate an SQLDA with SQLD occurrences and set SQLN in the new SQLDA to the value of SQLD.
3. Execute the DESCRIBE statement again, using this new SQLDA.

This technique allows better storage management than the first technique, but it doubles the number of DESCRIBE statements.

Third technique

Allocate an SQLDA that is large enough to handle most, and perhaps all, select lists but is also reasonably small. If an execution of DESCRIBE fails because the SQLDA is too small, allocate a larger SQLDA and execute DESCRIBE again. For the new SQLDA, use the value of SQLD (or double the value of SQLD) returned from the first execution of DESCRIBE for the number of occurrences of SQLVAR entries.

This technique is a compromise between the first two techniques. Its effectiveness depends on a good choice of size for the original SQLDA.

Considerations for implicitly hidden columns: A DESCRIBE OUTPUT statement only returns information about implicitly hidden columns if the column (of a base table that is defined as implicitly hidden) is explicitly specified as part of the SELECT list of the final result table of the query described. If implicitly hidden columns are not part of the result table of a query, a DESCRIBE OUTPUT statement that returns information about that query will not contain information about any implicitly hidden columns.

Example

In a C program, execute a DESCRIBE statement with an SQLDA that has no occurrences of SQLVAR entries. If SQLD is greater than zero, use the value to allocate an SQLDA with the necessary number of occurrences of SQLVAR entries and then execute a DESCRIBE statement using that SQLDA.

```
EXEC SQL BEGIN DECLARE SECTION;
char stmt1_str [200];
EXEC SQL END DECLARE SECTION;
EXEC SQL INCLUDE SQLDA;
struct sqlda initialsqlda;
struct sqlda *sqldaPtr;

EXEC SQL DECLARE DYN_CURSOR CURSOR FOR STMT1_NAME;

... /* code to prompt user for a query, then to generate */
/* a select-statement in the stmt1_str */
EXEC SQL PREPARE STMT1_NAME FROM :stmt1_str;

... /* code to set SQLN to zero and to allocate the SQLDA */
EXEC SQL DESCRIBE STMT1_NAME INTO :initialsqlda;

if (initialsqlda.sqld == 0); /* statement is a select-statement */
{
... /* Code to allocate correct size SQLDA (sets sqldaPtr) */

if (strcmp(SQLSTATE,"01005") == 0)
{
sqldaPtr->sqln = 2*initialsqlda.sqld;
SETSQLDOUBLED(sqldaPtr, SQLDOUBLED);
}
else
{
sqldaPtr->sqln = initialsqlda.sqld;
SETSQLDOUBLED(sqldaPtr, QLSINGLED);
}
EXEC SQL DESCRIBE STMT1_NAME INTO :*sqldaPtr;

... /* code to prepare for the use of the SQLDA */
EXEC SQL OPEN DYN_CURSOR;
```

¹⁰² If LOBs or UDTs are not in the result set, the warning is only returned if the standards option is specified. For information about the standards option, see [“Standards compliance” on page xix](#).

```
... /* loop to fetch rows from result table */
EXEC SQL FETCH DYN_CURSOR USING DESCRIPTOR :*sqldaPtr;

...
}
...

```

DESCRIBE CURSOR

The DESCRIBE CURSOR statement gets information about a cursor. The information, such as column information, is put into a descriptor.

Invocation

This statement can only be embedded in an application program, SQL function, SQL procedure, or trigger. It is an executable statement that cannot be dynamically prepared. It must not be specified in Java or REXX.

Authorization

None required.

Syntax

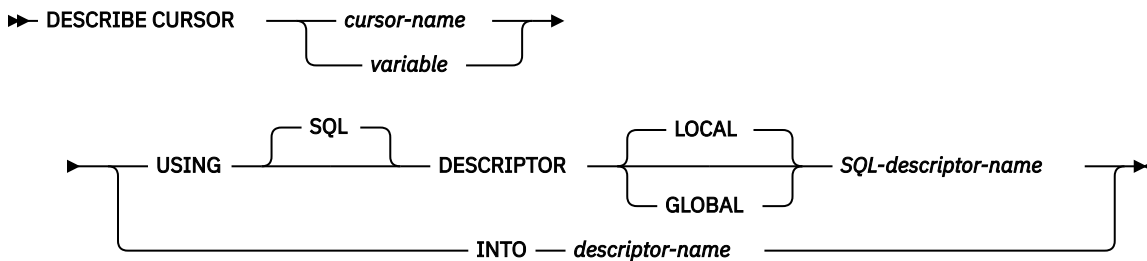

Description

cursor-name or variable

Identifies a cursor that has already been open or allocated in the source program.

If a *variable* is specified:

- It must be a character-string variable or Unicode graphic-string. It cannot be a global variable.
- It must not be followed by an indicator variable.
- The cursor name that is contained within the variable must be left-justified and must be padded on the right with blanks if its length is less than that of the variable.
- The name of the cursor must be in uppercase unless the cursor name is a delimited name.

USING

Identifies an SQL descriptor.

LOCAL

Specifies the scope of the name of the descriptor to be local to program invocation.

GLOBAL

Specifies the scope of the name of the descriptor to be global to the SQL session.

SQL-descriptor-name

Names the SQL descriptor. The name must identify a descriptor that already exists with the specified scope.

The information returned in the descriptor area describes the columns in the result set associated with the named cursor. After the DESCRIBE CURSOR is executed, the contents of the descriptor area are the same as after a DESCRIBE of a SELECT with the following addition.

- DB2_CURSOR_HOLD can be returned from the GET DESCRIPTOR statement to indicate whether the cursor was declared WITH HOLD in the procedure.

See [“GET DESCRIPTOR” on page 1311](#) for an explanation of the information that is placed in the SQL descriptor.

INTO descriptor-name

Identifies an SQL descriptor area (SQLDA), which is described in [Appendix D, “SQLDA \(SQL descriptor area\),” on page 1667](#). Before the DESCRIBE CURSOR statement is executed, the following variable in the SQLDA must be set.

SQLN

Specifies the number of SQLVAR occurrences provided in the SQLDA. SQLN must be set to a value greater than or equal to zero before the DESCRIBE CURSOR statement is executed. For information about techniques to determine the number of occurrences required, see [“Determining how many SQLVAR occurrences are needed” on page 1670](#).

When the DESCRIBE statement is executed, the database manager assigns values to the variables of the SQLDA as follows:

SQLDAID

The first 5 bytes are set to 'SQLRS'. Bytes 6 to 8 are reserved. If the cursor is declared WITH HOLD in the procedure, the high-order bit of the 8th byte is set to 1.

SQLDABC

Length of the SQLDA in bytes.

SQLD

The number of columns in the result table plus the number of extended SQLVAR entries. For information about extended SQLVAR entries see, [“Field descriptions in an occurrence of SQLVAR” on page 1673](#).

SQLVAR

If the value of SQLD is 0, or greater than the value of SQLN, no values are assigned to occurrences of SQLVAR.

If the value of SQLD is n , where n is greater than 0 but less than or equal to the value of SQLN, values are assigned to the first n occurrences of SQLVAR so that the first occurrence of SQLVAR contains a description of the first column of the result table, the second occurrence of SQLVAR contains a description of the second column of the result table, and so on. For information about the values assigned to SQLVAR occurrences, see [“Field descriptions in an occurrence of SQLVAR” on page 1673](#).

Notes

Allocating the SQL descriptor: Before the DESCRIBE CURSOR statement is executed, the SQL descriptor must be allocated using the ALLOCATE DESCRIPTOR statement. If the number of descriptor items allocated is less than the number of columns in the cursor result set, a warning (SQLSTATE 01005) is returned.

Allocating the SQLDA: Before the DESCRIBE CURSOR statement is executed, the value of SQLN must be set to a value greater than or equal to zero to indicate how many occurrences of SQLVAR are provided in the SQLDA and enough storage must be allocated to contain SQLN occurrences. To obtain the description of the columns of the cursor result set, the number of occurrences of SQLVAR must not be less than the number of columns.

For a description of techniques that can be used to allocate the SQLDA, see [Appendix D, “SQLDA \(SQL descriptor area\),” on page 1667](#).

Example

Place information about the result set associated with cursor C1 into an SQL descriptor.

```
EXEC SQL ALLOCATE DESCRIPTOR 'DESCR1';  
EXEC SQL DESCRIBE CURSOR C1 USING SQL DESCRIPTOR 'DESCR1';
```

DESCRIBE INPUT

The DESCRIBE INPUT statement obtains information about the IN and INOUT parameter markers of a prepared statement.

For an explanation of prepared statements, see [“PREPARE” on page 1427](#).

Invocation

This statement can only be embedded in an application program, SQL function, SQL procedure, or trigger. It is an executable statement that cannot be dynamically prepared. It must not be specified in Java or REXX.

Authorization

None required. See [“PREPARE” on page 1427](#) for the authorization required to create a prepared statement.

Syntax

►► DESCRIBE INPUT — *statement-name* —►

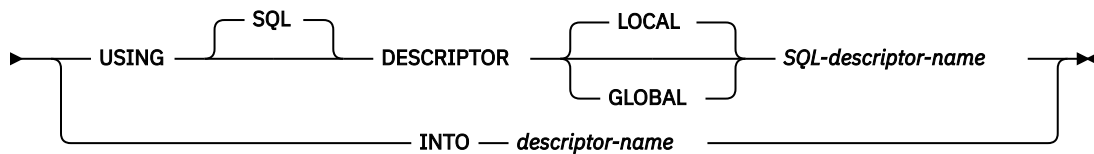

Description

statement-name

Identifies the prepared statement. When the DESCRIBE INPUT statement is executed, the name must identify a prepared statement at the current server.

USING

Identifies an SQL descriptor.

LOCAL

Specifies the scope of the name of the descriptor to be local to program invocation.

GLOBAL

Specifies the scope of the name of the descriptor to be global to the SQL session.

SQL-descriptor-name

Names the SQL descriptor. The name must identify a descriptor that already exists with the specified scope.

See [“GET DESCRIPTOR” on page 1311](#) for an explanation of the information that is placed in the SQL descriptor.

INTO *descriptor-name*

Identifies an SQL descriptor area (SQLDA), which is described in Appendix D, [“SQLDA \(SQL descriptor area\),” on page 1667](#). Before the DESCRIBE INPUT statement is executed, the following variable in the SQLDA must be set.

SQLN

Specifies the number of SQLVAR occurrences provided in the SQLDA. SQLN must be set to a value greater than or equal to zero before the DESCRIBE INPUT statement is executed. For information about techniques to determine the number of occurrences requires, see [“Determining how many SQLVAR occurrences are needed” on page 1670](#).

When the DESCRIBE INPUT statement is executed, the database manager assigns values to the variables of the SQLDA as follows:

SQLDAID

The first 6 bytes are set to 'SQLDA ' (that is, 5 letters followed by the space character).

The seventh byte is set based on the parameter markers described:

- If the SQLDA contains two SQLVAR entries for every input parameter marker, the seventh byte is set to '2'. This technique is used in order to accommodate LOB input parameters.
- Otherwise, the seventh byte is set to the space character.

The seventh byte is set to the space character if there is not enough room in the SQLDA to contain the description of all input parameter markers.

The eighth byte is set to the space character.

SQLDABC

Length of the SQLDA in bytes.

SQLD

The number of input parameter markers in the prepared statement.

SQLVAR

If the value of SQLD is 0, or greater than the value of SQLN, no values are assigned to occurrences of SQLVAR.

If the value of SQLD is n , where n is greater than 0 but less than or equal to the value of SQLN, values are assigned to the first n occurrences of SQLVAR so that the first occurrence of SQLVAR contains a description of the first input parameter marker, the second occurrence of SQLVAR contains a description of the second input parameter marker, and so on. For information about the values assigned to SQLVAR occurrences, see [“Field descriptions in an occurrence of SQLVAR” on page 1673](#).

Notes

Allocating the SQL descriptor: Before the DESCRIBE INPUT statement is executed, the SQL descriptor must be allocated using the ALLOCATE DESCRIPTOR statement. The number of descriptor items allocated must not be less than the number of input parameter markers or an error is returned.

Allocating the SQLDA: Before the DESCRIBE INPUT statement is executed, enough storage must be allocated for some number of SQLVAR occurrences. SQLN must then be set to the number of SQLVAR occurrences that were allocated. To obtain the description of the input parameter markers in the prepared statement, the number of occurrences of SQLVAR must not be less than the number of input parameter markers. Furthermore, if the input parameter markers include LOBs or distinct types, the number of occurrences of SQLVAR should be two times the number of input parameter markers. See [“Determining how many SQLVAR occurrences are needed” on page 1670](#) for more information.

If not enough occurrences are provided to return all sets of occurrences, SQLN is set to the total number of occurrences necessary to return all information. Otherwise, SQLN is set to the number of input parameter markers.

Among the possible ways to allocate the SQLDA are the three described below:

First technique

Allocate an SQLDA with enough occurrences of SQLVAR entries to accommodate any number of input parameter markers that the application will have to process. At the extreme, the number of SQLVARs could equal two times the maximum number of parameter markers allowed in a prepared statement. Having done the allocation, the application can use this SQLDA repeatedly.

This technique uses a large amount of storage that is never deallocated, even when most of this storage is not used for a particular prepared statement.

Second technique

Repeat the following three steps for every processed prepared statement:

1. Execute a DESCRIBE INPUT statement with an SQLDA that has no occurrences of SQLVAR entries, that is, an SQLDA for which SQLN is zero. The value returned for SQLD is the number of input parameter markers in the prepared statement. This value is either the required number of occurrences of SQLVAR entries or half the required number. Because there were no SQLVAR entries, a warning will be issued.¹⁰³
2. If the SQLSTATE accompanying that warning is equal to 01005, allocate an SQLDA with 2 * SQLD occurrences and set SQLN in the new SQLDA to 2 * SQLD. Otherwise, allocate an SQLDA with SQLD occurrences and set SQLN in the new SQLDA to the value of SQLD.
3. Execute the DESCRIBE INPUT statement again, using this new SQLDA.

This technique allows better storage management than the first technique, but it doubles the number of DESCRIBE INPUT statements.

Third technique

Allocate an SQLDA that is large enough to handle most, and perhaps all, parameter markers in prepared statements but is also reasonably small. If an execution of DESCRIBE INPUT fails because the SQLDA is too small, allocate a larger SQLDA and execute DESCRIBE INPUT again. For the new SQLDA, use the value of SQLD (or double the value of SQLD) returned from the first execution of DESCRIBE INPUT for the number of occurrences of SQLVAR entries.

This technique is a compromise between the first two techniques. Its effectiveness depends on a good choice of size for the original SQLDA.

Examples

Example 1: In a C program, execute a DESCRIBE INPUT statement with an SQLDA that has enough to describe any number of input parameter markers a prepared statement might have. Assume that five parameter markers at most will need to be described and that the input data does not contain LOBs.

```
EXEC SQL BEGIN DECLARE SECTION;
      char stmt1_str [200];
EXEC SQL END DECLARE SECTION;
EXEC SQL INCLUDE SQLDA;
struct sqlda initialsqlda;
struct sqlda *sqldaPtr;

... /* stmt1_str contains INSERT statement with VALUES      */
      /* clause                                             */
EXEC SQL PREPARE STMT1_NAME FROM :stmt1_str;

... /* code to set SQLN to five and to allocate the SQLDA */
EXEC SQL DESCRIBE INPUT STMT1_NAME INTO :SQLDA;

...
```

Example 2: Allocate a descriptor called 'NEWDA' large enough to hold 20 item descriptor areas and use it on DESCRIBE INPUT.

```
EXEC SQL ALLOCATE DESCRIPTOR 'NEWDA'
      WITH MAX 20;

EXEC SQL DESCRIBE INPUT STMT1
      USING SQL DESCRIPTOR 'NEWDA';
```

¹⁰³ If LOBs or UDTs are not in the result set, the warning is only returned if the standards option is specified. For information about the standards option, see [“Standards compliance” on page xix](#).

DESCRIBE PROCEDURE

The DESCRIBE PROCEDURE statement gets information about the result sets returned by a procedure. The information, such as the number of result sets, is put into a descriptor.

Invocation

This statement can only be embedded in an application program, SQL function, SQL procedure, or trigger. It is an executable statement that cannot be dynamically prepared. It must not be specified in Java or REXX.

Authorization

None required.

Syntax

➤ DESCRIBE ➔

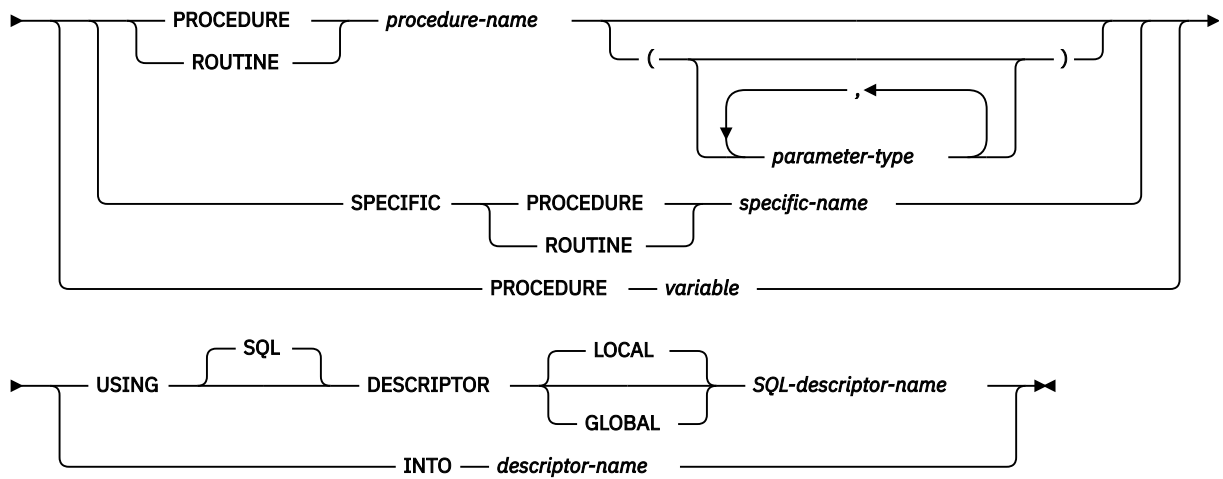

parameter-type

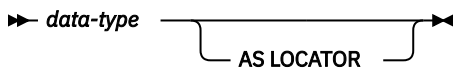

data-type

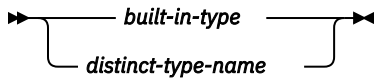

built-in-type

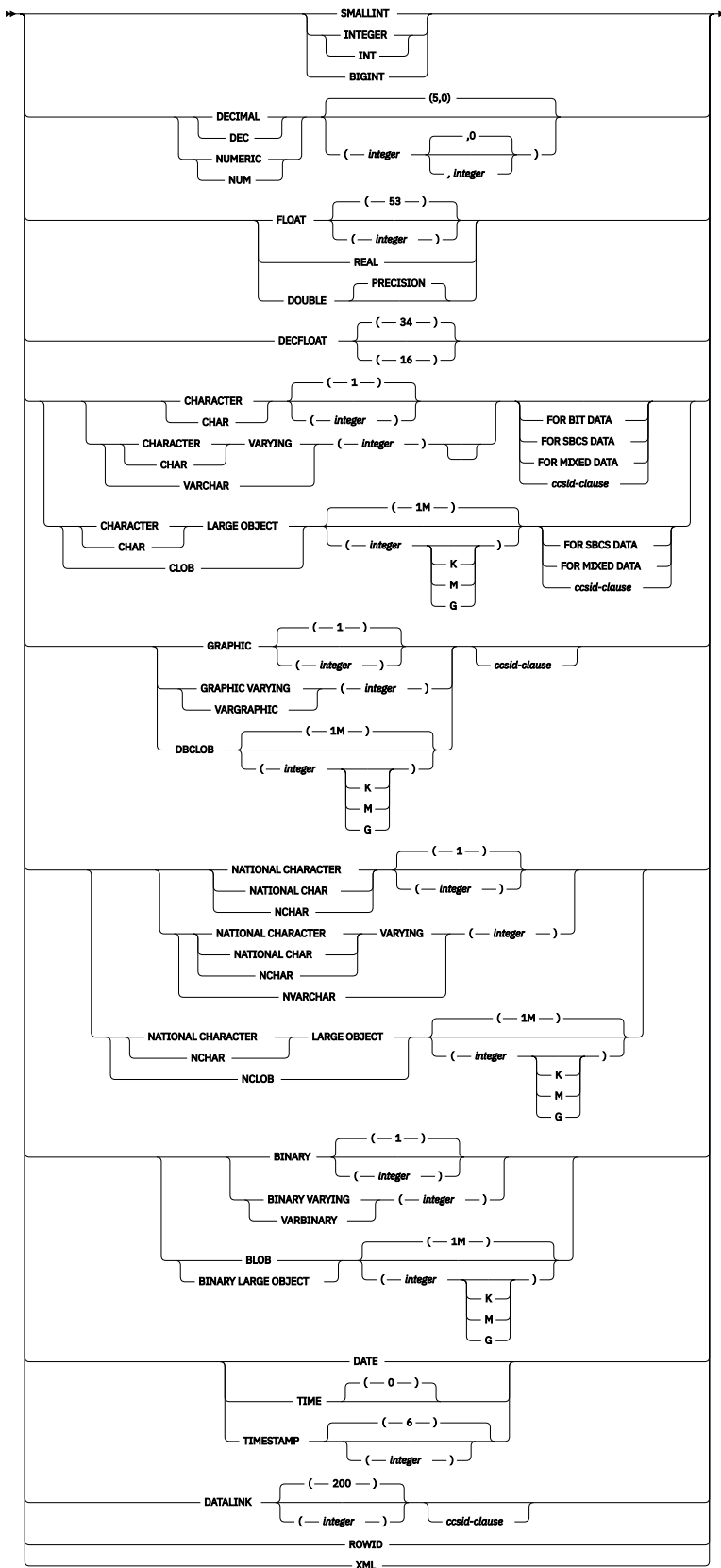

ccsid-clause

➤ **CCSID** — *integer* ➤

Description

procedure-name or specific-name or variable

Identifies the procedure that returned one or more result sets. When the DESCRIBE PROCEDURE statement is executed, the procedure name must identify a procedure that the requester has already invoked using the SQL CALL statement.

PROCEDURE or SPECIFIC PROCEDURE

Identifies the procedure to be described. The *procedure-name* must identify a procedure that exists at the current server.

PROCEDURE *procedure-name*

Identifies the procedure by its name. The *procedure-name* must identify exactly one procedure. The procedure may have any number of parameters defined for it. If there is more than one procedure of the specified name in the specified or implicit schema, an error is returned.

PROCEDURE *procedure-name (parameter-type, ...)*

Identifies the procedure by its procedure signature, which uniquely identifies the procedure. The *procedure-name (parameter-type, ...)* must identify a procedure with the specified procedure signature. The specified parameters must match the data types in the corresponding position that were specified when the procedure was created. The number of data types, and the logical concatenation of the data types is used to identify the specific procedure instance which is to be labeled on. Synonyms for data types are considered a match. Parameters that have defaults must be included in this signature.

If *procedure-name ()* is specified, the procedure identified must have zero parameters.

procedure-name

Identifies the name of the procedure.

(parameter-type, ...)

Identifies the parameters of the procedure.

If an unqualified distinct type or array type name is specified, the database manager searches the SQL path to resolve the schema name for the distinct type or array type.

For data types that have a length, precision, or scale attribute, use one of the following:

- Empty parentheses indicate that the database manager ignores the attribute when determining whether the data types match. For example, DEC() will be considered a match for a parameter of a procedure defined with a data type of DEC(7,2). However, FLOAT cannot be specified with empty parenthesis because its parameter value indicates a specific data type (REAL or DOUBLE).
- If a specific value for a length, precision, or scale attribute is specified, the value must exactly match the value that was specified (implicitly or explicitly) in the CREATE PROCEDURE statement. If the data type is FLOAT, the precision does not have to exactly match the value that was specified because matching is based on the data type (REAL or DOUBLE).
- If length, precision, or scale is not explicitly specified, and empty parentheses are not specified, the default attributes of the data type are implied. The implicit length must exactly match the value that was specified (implicitly or explicitly) in the CREATE PROCEDURE statement.

Specifying the FOR DATA clause or CCSID clause is optional. Omission of either clause indicates that the database manager ignores the attribute when determining whether the data types match. If either clause is specified, it must match the value that was implicitly or explicitly specified in the CREATE PROCEDURE statement.

AS LOCATOR

Specifies that the procedure is defined to receive a locator for this parameter. If AS LOCATOR is specified, the data type must be a LOB or XML or a distinct type based on a

LOB or XML. If AS LOCATOR is specified, FOR SBCS DATA or FOR MIXED DATA must not be specified.

SPECIFIC PROCEDURE *specific-name*

Identifies the procedure by its specific name. The *specific-name* must identify a specific procedure that exists at the current server.

variable

Specifies a variable that contains a procedure or specific name. If *variable* is specified:

- It must be a character-string variable or Unicode graphic-string variable. It cannot be a global variable.
- It must not be followed by an indicator variable.
- The name that is contained within the variable must be left-justified and must be padded on the right with blanks if its length is less than that of the variable.
- The name must be in uppercase unless it is a delimited name.

If only one procedure with this name has been invoked using the CALL statement, the variable is used as a procedure name. If multiple procedures with this name have been invoked, the variable is used as a specific name.

USING

Identifies an SQL descriptor.

LOCAL

Specifies the scope of the name of the descriptor to be local to program invocation.

GLOBAL

Specifies the scope of the name of the descriptor to be global to the SQL session.

SQL-descriptor-name

Names the SQL descriptor. The name must identify a descriptor that already exists with the specified scope.

After the DESCRIBE PROCEDURE is executed, the following values can be retrieved with the GET DESCRIPTOR statement:

- DB2_RESULT_SETS_COUNT contains the total number of result sets. A value of 0 indicates there are no result sets.

There is one descriptor area item for each result set:

- DB2_RESULT_SET_LOCATOR contains the result set locator value associated with the result set.
- DB2_CURSOR_NAME contains the name of the cursor used by the procedure to return the result set.
- DB2_RESULT_SET_ROWS contains the estimated number of rows in the result set. This is set to -1 if the number is unknown.

See [“GET DESCRIPTOR” on page 1311](#) for an explanation of the information that is placed in the SQL descriptor.

INTO *descriptor-name*

Identifies an SQL descriptor area (SQLDA), which is described in Appendix D, [“SQLDA \(SQL descriptor area\),” on page 1667](#). Before the DESCRIBE PROCEDURE statement is executed, the following variable in the SQLDA must be set.

SQLN

Specifies the number of SQLVAR occurrences provided in the SQLDA. SQLN must be set to a value greater than or equal to zero before the DESCRIBE PROCEDURE statement is executed.

When the DESCRIBE statement is executed, the database manager assigns values to the variables of the SQLDA as follows:

SQLDAID

The first 5 bytes are set to 'SQLPR'. Bytes 6 to 8 are reserved.

SQLDABC

Length of the SQLDA in bytes.

SQLD

The total number of result sets. A value of 0 indicates there are no result sets.

SQLVAR

If the value of SQLD is 0, or greater than the value of SQLN, no values are assigned to occurrences of SQLVAR.

If the value of SQLD is n , where n is greater than 0 but less than or equal to the value of SQLN, values are assigned to the first n occurrences of SQLVAR so that the first occurrence of SQLVAR contains a description of the first result set, the second occurrence of SQLVAR contains a description of the second result set, and so on. For each SQLVAR entry:

- The SQLDATA field is set to the result set locator value associated with the result set.
- The SQLIND field is set to the estimated number of rows in the result set. This is set to -1 if the number is unknown.
- The SQLNAME field is set to the name of the cursor used by the stored procedure to return the result set. The cursor name is truncated to 30 characters if it is longer than 30 characters.

Notes

DESCRIBE PROCEDURE does not return information about the parameters expected by the procedure.

The CALL to the procedure must precede the DESCRIBE PROCEDURE statement.

Allocating the SQL descriptor: Before the DESCRIBE PROCEDURE statement is executed, the SQL descriptor must be allocated using the ALLOCATE DESCRIPTOR statement. If the number of descriptor items allocated is less than the number of result sets for the procedure, a warning (SQLSTATE 01005) is returned.

Allocating the SQLDA: Before the DESCRIBE PROCEDURE statement is executed, the value of SQLN must be set to a value greater than or equal to zero to indicate how many occurrences of SQLVAR are provided in the SQLDA and enough storage must be allocated to contain SQLN occurrences. To obtain the description of the result sets for the procedure, the number of occurrences of SQLVAR must not be less than the number result sets.

If not enough occurrences are provided to return all sets of occurrences, SQLN is set to the total number of occurrences necessary to return all information. Otherwise, SQLN is set to the number of result sets.

Assignment of locator values: If a SET RESULT SETS statement was executed in the procedure, the SET RESULT SETS statement identifies the result sets. The locator values are assigned to the items in the descriptor area or the SQLVAR entries in the SQLDA in the order specified on the SET RESULT SETS statement. If a SET RESULT SETS statement was not executed in the procedure, locator values are assigned to the items in the descriptor area or to the SQLVAR entries in the SQLDA in the order that the associated cursors are opened at run time. Locator values are not provided for cursors that are closed when control is returned to the invoking application. If a cursor was closed and later re-opened before returning to the invoking application, the most recently executed OPEN CURSOR statement for the cursor is used to determine the order in which the locator values are returned for the procedure result sets. For example, assume procedure P1 opens three cursors A, B, and C, closes cursor B, and then issues another OPEN CURSOR statement for cursor B before returning to the invoking application. The locator values are assigned in the order A, C, B.

Alternatively, an ASSOCIATE LOCATORS statement can be used to copy the locator values to result set locator variables.

Example

Place information about the result sets returned by procedure P1 into an SQL descriptor:

```
EXEC SQL CALL P1;  
EXEC SQL ALLOCATE DESCRIPTOR 'DESC1';  
EXEC SQL DESCRIBE PROCEDURE P1 USING SQL DESCRIPTOR 'DESC1';
```

DESCRIBE TABLE

The DESCRIBE TABLE statement obtains information about a table or view.

Invocation

This statement can only be embedded in an application program, SQL function, SQL procedure, or trigger. It is an executable statement that cannot be dynamically prepared. It must not be specified in Java.

Authorization

The privileges held by the authorization ID of the statement must include at least one of the following:

- For the table or view identified in the statement:
 - The system authority of *OBJOPR on the table or view
 - The USAGE privilege on the schema containing the table or view
- Database administrator authority

Syntax

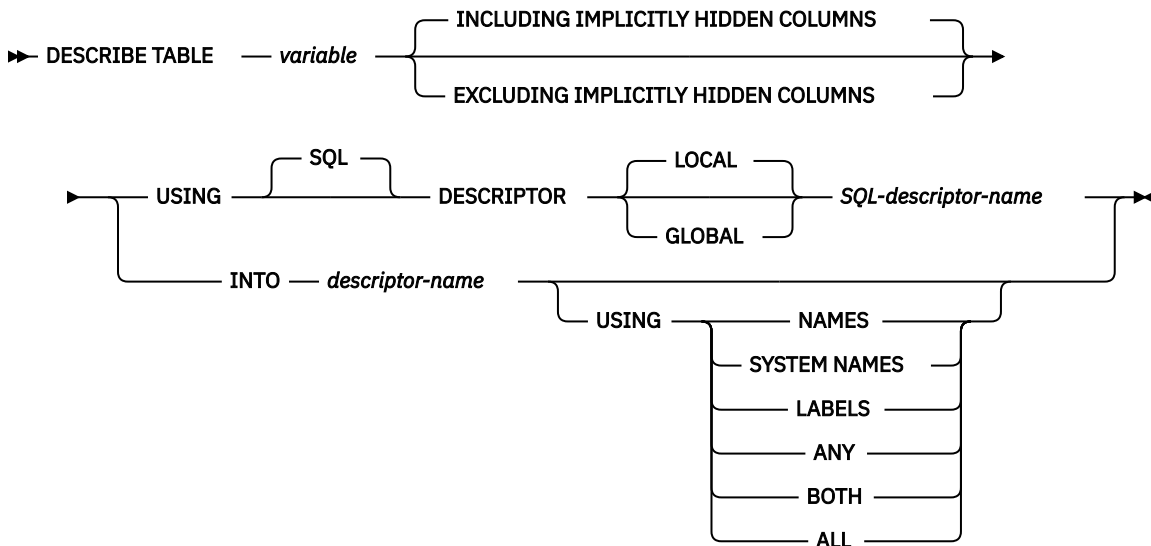

Description

variable

Identifies the table or view to describe. When the DESCRIBE TABLE statement is executed:

- The name must identify a table or view that exists at the application server.
- The *variable* must be a character-string or Unicode graphic-string variable and must not include an indicator variable. It cannot be a global variable.
- The table name that is contained within the *variable* must be left-justified and must be padded on the right with blanks if its length is less than that of the *variable*.
- The name of the table must be in uppercase unless it is a delimited name.

INCLUDING IMPLICITLY HIDDEN COLUMNS or **EXCLUDING IMPLICITLY HIDDEN COLUMNS**

Specifies whether information should be returned for implicitly hidden column in a table.

INCLUDING IMPLICITLY HIDDEN COLUMNS

Specifies that information is returned for columns defined as implicitly hidden. This is the default.

EXCLUDING IMPLICITLY HIDDEN COLUMNS

Specifies that information is not returned for columns defined as implicitly hidden.

When the DESCRIBE TABLE statement is executed, the database manager assigns values to the variables of the SQL descriptor or SQLDA as follows:

USING

Identifies an SQL descriptor.

LOCAL

Specifies the scope of the name of the descriptor to be local to program invocation.

GLOBAL

Specifies the scope of the name of the descriptor to be global to the SQL session.

SQL-descriptor-name

Names the SQL descriptor. The name must identify a descriptor that already exists with the specified scope.

See [“GET DESCRIPTOR” on page 1311](#) for an explanation of the information that is placed in the SQL descriptor.

INTO descriptor-name

Identifies an SQL descriptor area (SQLDA), which is described in Appendix D, [“SQLDA \(SQL descriptor area\),” on page 1667](#). Before the DESCRIBE TABLE statement is executed, the following variable in the SQLDA must be set.

SQLN

Specifies the number of SQLVAR occurrences provided in the SQLDA. SQLN must be set to a value greater than or equal to zero before the DESCRIBE TABLE statement is executed. For information about techniques to determine the number of occurrences requires, see [“Determining how many SQLVAR occurrences are needed” on page 1670](#).

The rules for REXX are different. For more information, see the [Embedded SQL Programming](#) topic collection.

When the DESCRIBE statement is executed, the database manager assigns values to the variables of the SQLDA as follows:

SQLDAID

The first 6 bytes are set to 'SQLDA ' (that is, 5 letters followed by the space character).

The seventh byte is set based on the column described:

- If the SQLDA contains two, three, or four SQLVAR entries for every column of the table, the seventh byte is set to '2', '3', or '4'. This technique is used in order to accommodate LOB or distinct type result columns, labels, and system names.
- Otherwise, the seventh byte is set to the space character.

The seventh byte is set to the space character if there is not enough room in the SQLDA to contain the description of all columns.

The eighth byte is set to the space character.

SQLDABC

Length of the SQLDA in bytes.

SQLD

The number of columns in the table plus the number of extended SQLVAR entries. For information about extended SQLVAR entries see, [“Field descriptions in an occurrence of SQLVAR” on page 1673](#).

SQLVAR

If the value of SQLD is 0, or greater than the value of SQLN, no values are assigned to occurrences of SQLVAR.

If the value of SQLD is n , where n is greater than 0 but less than or equal to the value of SQLN, values are assigned to the first n occurrences of SQLVAR so that the first occurrence of SQLVAR

contains a description of the first column of the table, the second occurrence of SQLVAR contains a description of the second column of the table, and so on. For information about the values assigned to SQLVAR occurrences, see [“Field descriptions in an occurrence of SQLVAR” on page 1673](#).

USING

Specifies what value to assign to each SQLNAME variable in the SQLDA. If the requested value does not exist or if the length of a name is greater than 30, SQLNAME is set to a length of 0.

NAMES

Assigns the name of the column. The column name returned is case sensitive and without delimiters. This is the default.

SYSTEM NAMES

Assigns the system column name of the column.

LABELS

Assigns the label of the column. (Column labels are defined by the LABEL statement.) Only the first 20 bytes of the label are returned.

ANY

Assigns the column label. If the column has no label, the column name is used instead.

BOTH

Assigns both the label and name of the column. In this case, two or three occurrences of SQLVAR per column, depending on whether the table contains distinct types, are needed to accommodate the additional information. To specify this expansion of the SQLVAR array, set SQLN to $2*n$ or $3*n$ (where n is the number of columns in the table or view). The first n occurrences of SQLVAR contain the column names if they are different from the system column name. Either the second or third n occurrences contain the column labels. If there are no distinct types, the labels are returned in the second set of SQLVAR entries. Otherwise, the labels are returned in the third set of SQLVAR entries.

ALL

Assigns the label, column name, and system column name. In this case three or four occurrences of SQLVAR per column, depending on whether the table contains distinct types, are needed to accommodate the additional information. To specify this expansion of the SQLVAR array, set SQLN to $3*n$ or $4*n$ (where n is the number of columns in the table). The first n occurrences of SQLVAR contain the system column names. The second or third n occurrences contain the column labels. The third or fourth n occurrences contain the column names. If there are no distinct types, the labels are returned in the second set of SQLVAR entries and the column names are returned in the third set of SQLVAR entries. Otherwise, the labels are returned in the third set of SQLVAR entries and the column names are returned in the fourth set of SQLVAR entries.

Notes

Allocating the SQL descriptor: Before the DESCRIBE TABLE statement is executed, the SQL descriptor must be allocated using the ALLOCATE DESCRIPTOR statement. If the number of descriptor items allocated is less than the number of columns in the table or view, a warning (SQLSTATE 01005) is returned.

Allocating the SQLDA: Before the DESCRIBE TABLE statement is executed, the value of SQLN must be set to a value greater than or equal to zero to indicate how many occurrences of SQLVAR are provided in the SQLDA and enough storage must be allocated to contain SQLN occurrences. To obtain the description of the columns of the table or view, the number of occurrences of SQLVAR must not be less than the number of columns. Furthermore, if USING BOTH or USING ALL is specified, or if the columns include LOBs or distinct types, the number of occurrences of SQLVAR should be two, three, or four times the number of columns. See [“Determining how many SQLVAR occurrences are needed” on page 1670](#) for more information.

If not enough occurrences are provided to return all sets of occurrences, SQLN is set to the total number of occurrences necessary to return all information. Otherwise, SQLN is set to the number of columns.

For a description of techniques that can be used to allocate the SQLDA, see [Appendix D, “SQLDA \(SQL descriptor area\),”](#) on page 1667.

Example

In a C program, execute a DESCRIBE statement with an SQLDA that has no occurrences of SQLVAR. If SQLD is greater than zero, use the value to allocate an SQLDA with the necessary number of occurrences of SQLVAR and then execute a DESCRIBE statement using that SQLDA.

```
EXEC SQL BEGIN DECLARE SECTION;
      char table_name[201];
EXEC SQL END DECLARE SECTION;
EXEC SQL INCLUDE SQLDA;
EXEC SQL DECLARE DYN_CURSOR CURSOR FOR STMT1_NAME;

.../*code to prompt user for a table or view */
.../*code to set SQLN to zero and to allocate the SQLDA */
EXEC SQL DESCRIBE TABLE :table_name INTO :sqlda;

... /* code to check that SQLD is greater than zero, to set */
      /* SQLN to SQLD, then to re-allocate the SQLDA */
EXEC SQL DESCRIBE TABLE :table_name INTO :sqlda;

.
.
.
```

DISCONNECT

The DISCONNECT statement ends one or more connections for unprotected conversations.

Invocation

This statement can only be embedded in an application program or issued interactively. It is an executable statement that cannot be dynamically prepared. It must not be specified in Java or REXX.

DISCONNECT is not allowed in a trigger or function.

Authorization

If a global variable is referenced in a statement, the privileges held by the authorization ID of the statement must include at least one of the following:

- For the global variable identified in the statement,
 - The READ privilege on the global variable, and
 - The USAGE privilege on the schema containing the global variable
- Database administrator authority

Syntax

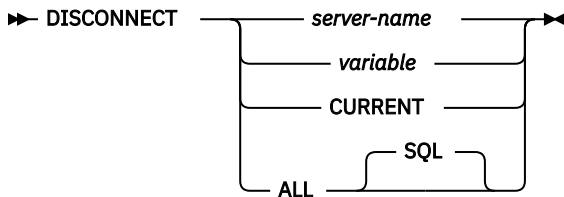

Description

server-name or *variable*

Identifies the application server by the specified server name or the server name contained in the variable. It can be a global variable if it is qualified with schema name. If a variable is specified:

- It must be a character-string variable.
- It must not be followed by an indicator variable.
- The server name must be left-justified within the variable and must conform to the rules for forming an ordinary identifier.
- If the length of the server name is less than the length of the variable, it must be padded on the right with blanks.

When the DISCONNECT statement is executed, the specified server name or server name contained in the variable must identify an existing dormant or current connection of the activation group. The identified connection cannot use a protected conversation.

CURRENT

Identifies the current connection of the activation group. The activation group must be in the connected state. The current connection must not use a protected conversation.

ALL or **ALL SQL**

Identifies all existing connections of the activation group (local as well as remote connections). An error or warning does not occur if no connections exist when the statement is executed. None of the connections can use protected conversations.

Notes

DISCONNECT and CONNECT (Type 1): Using CONNECT (Type 1) semantics does not prevent using DISCONNECT.

Connection restrictions: An identified connection must not be a connection that was used to execute SQL statements during the current unit of work and must not be a connection for a protected conversation. To end connections on protected conversations, use the RELEASE statement. Local connections are never considered to be protected conversations.

The DISCONNECT statement should be executed immediately after a commit operation. If DISCONNECT is used to end the current connection, the next executed SQL statement must be CONNECT or SET CONNECTION.

ROLLBACK does not reconnect a connection that has been ended by DISCONNECT.

Successful disconnect: If the DISCONNECT statement is successful, each identified connection is ended. If the current connection is destroyed, the activation group is placed in the unconnected state.

DISCONNECT closes cursors, releases resources, and prevents further use of the connection.

DISCONNECT ALL ends the connection to the local application server. A connection is ended even though it has an open cursor defined with the WITH HOLD clause.

Unsuccessful disconnect: If the DISCONNECT statement is unsuccessful, the connection state of the activation group and the states of its connections are unchanged.

Resource considerations for remote connections: Resources are required to create and maintain remote connections. Thus, a remote connection that is not going to be reused should be ended as soon as possible and a remote connection that is going to be reused should not be destroyed.

Examples

Example 1: The connection to TOROLAB1 is no longer needed. The following statement is executed after a commit operation.

```
EXEC SQL DISCONNECT TOROLAB1;
```

Example 2: The current connection is no longer needed. The following statement is executed after a commit operation.

```
EXEC SQL DISCONNECT CURRENT;
```

Example 3: The existing connections are no longer needed. The following statement is executed after a commit operation.

```
EXEC SQL DISCONNECT ALL;
```

DROP

The DROP statement drops an object. Objects that are directly or indirectly dependent on that object may also be dropped.

Invocation

This statement can be embedded in an application program or issued interactively. It is an executable statement that can be dynamically prepared.

Authorization

To drop a table, view, index, alias, or package, the privileges held by the authorization ID of the statement must include at least one of the following:

- The following system authorities:
 - The system authorities of *OBJOPR and *OBJEXIST on the object to be dropped
 - If the object is a table or view, the system authorities of *OBJOPR and *OBJEXIST on any views, indexes, and logical files that are dependent on that table or view
 - If the object is a system-period temporal table, the system authorities of *OBJOPR and *OBJEXIST on the associated history table
 - The USAGE privilege on the schema that contains the object to be dropped
- Database administrator authority

To drop a schema, the privileges held by the authorization ID of the statement must include at least one of the following:

- The following system authorities:
 - The system authorities of *OBJEXIST, *OBJOPR, *EXECUTE, and *READ on the library to be dropped.
 - The system authorities of *OBJOPR and *OBJEXIST on all objects in the schema and *OBJOPR and *OBJEXIST on any views, indexes and logical files that are dependent on tables and views in the schema.
 - Any additional authorities required to delete other object types that exist in the schema. For example, *OBJMGT to the data dictionary if the schema contains a data dictionary, and some system data authority to the journal receiver. For more information, see [Security Reference](#).
- Database administrator authority

To drop a user-defined type, the privileges held by the authorization ID of the statement must include at least one of the following:

- The following system authorities:
 - The system authorities of *OBJOPR and *OBJEXIST on the type to be dropped
 - The USAGE privilege on the schema that contains the type to be dropped
 - The DELETE privilege on the SYSTYPES, SYSPARMS, and SYSROUTINES catalog tables, and
 - The USAGE privilege on schema QSYS2
- Database administrator authority

To drop a global variable, the privileges held by the authorization ID of the statement must include at least one of the following:

- The following system authorities:
 - The system authority of *OBJEXIST on the *SRVPGM object for the global variable to be dropped
 - The USAGE privilege on the schema that contains the global variable to be dropped
 - The DELETE privilege on the SYSVARIABLES catalog table, and

- The USAGE privilege on schema QSYS2
- Database administrator authority

To drop an XSR object, the privileges held by the authorization ID of the statement must include at least one of the following:

- The following system authorities:
 - The system authorities of *OBJOPR and *OBJEXIST on the *SQLXSR object for the XSR object to be dropped
 - The USAGE privilege on the schema that contains the XSR object to be dropped
 - The DELETE privilege on the XSROBJECTS, XSROBJECTCOMPONENTS, and XSRANNOTATIONINFO catalog tables, and
 - The USAGE privilege on schema QSYS2
- Database administrator authority

To drop a function, the privileges held by the authorization ID of the statement must include at least one of the following:

- The following system authorities:
 - For SQL functions, the system authority *OBJEXIST on the service program object associated with the function, and
 - The DELETE privilege on the SYSFUNCS, SYSPARMS, and SYSROUTINEDEP catalog tables, and
 - The USAGE privilege on schema QSYS2
- Database administrator authority

To drop a procedure, the privileges held by the authorization ID of the statement must include at least one of the following:

- The following system authorities:
 - For SQL procedures, the system authority *OBJEXIST on the program object associated with the procedure, and
 - The DELETE privilege on the SYSPROCS, SYSPARMS, and SYSROUTINEDEP catalog tables, and
 - The USAGE privilege on schema QSYS2
- Database administrator authority

To drop a sequence, the privileges held by the authorization ID of the statement must include at least one of the following:

- The following system authorities:
 - The system authority *OBJEXIST on the data area associated with the sequence, and
 - The USAGE privilege on the schema that contains the sequence to be dropped
 - The DELETE privilege on the SYSSEQOBJECTS catalog table, and
 - The USAGE privilege on schema QSYS2, and
 - *USE to the Delete Data Area (DLTDTAARA) command
- Database administrator authority

To drop a trigger, the privileges held by the authorization ID of the statement must include at least one of the following:

- The following privileges:
 - The system authority *USE to the Remove Physical File Trigger (RMVPFTRG) command, and
 - For the subject table or view of the trigger:
 - The ALTER privilege to the subject table or view, and
 - The USAGE privilege on the schema containing the subject table or view,

- If the trigger being dropped is an SQL trigger:
 - The system authority *OBJEXIST on the trigger program object, and
 - The USAGE privilege on the schema containing the trigger.
- Database administrator authority

To drop a mask or permission:

- The authorization ID of the statement must have security administrator authority. See [“Administrative authority” on page 15](#).

To drop an object used by a mask or permission:

- The authorization ID of the statement must have security administrator authority. See [“Administrative authority” on page 15](#).

For information about the system authorities corresponding to SQL privileges, see [Corresponding System Authorities When Checking Privileges to a Table or View](#).

Syntax

➔ DROP ➔

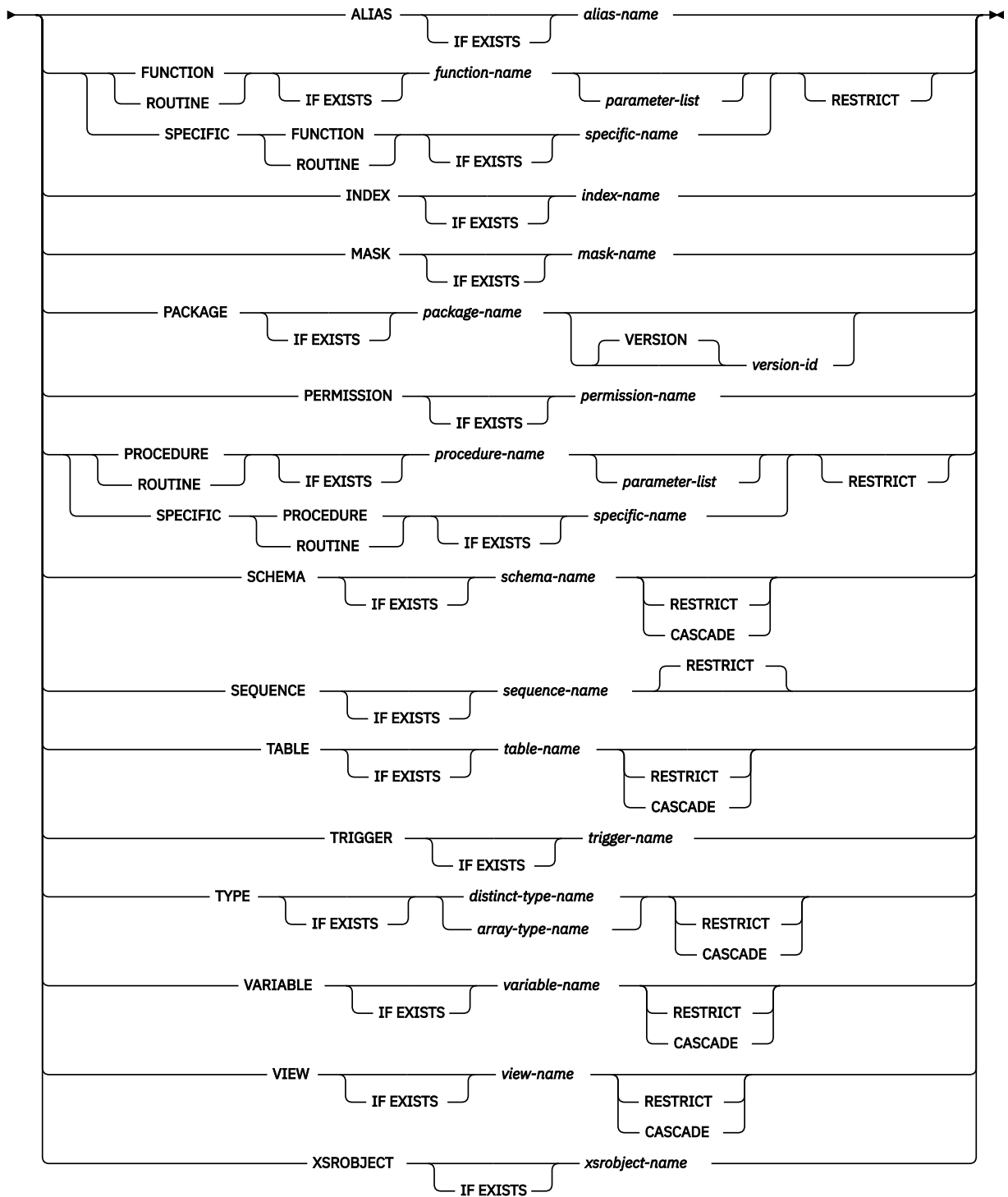

parameter-list

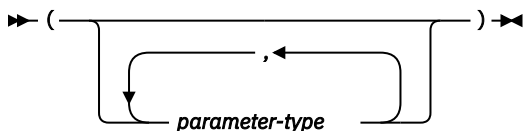

parameter-type

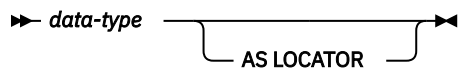

data-type

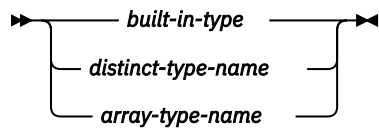

built-in-type

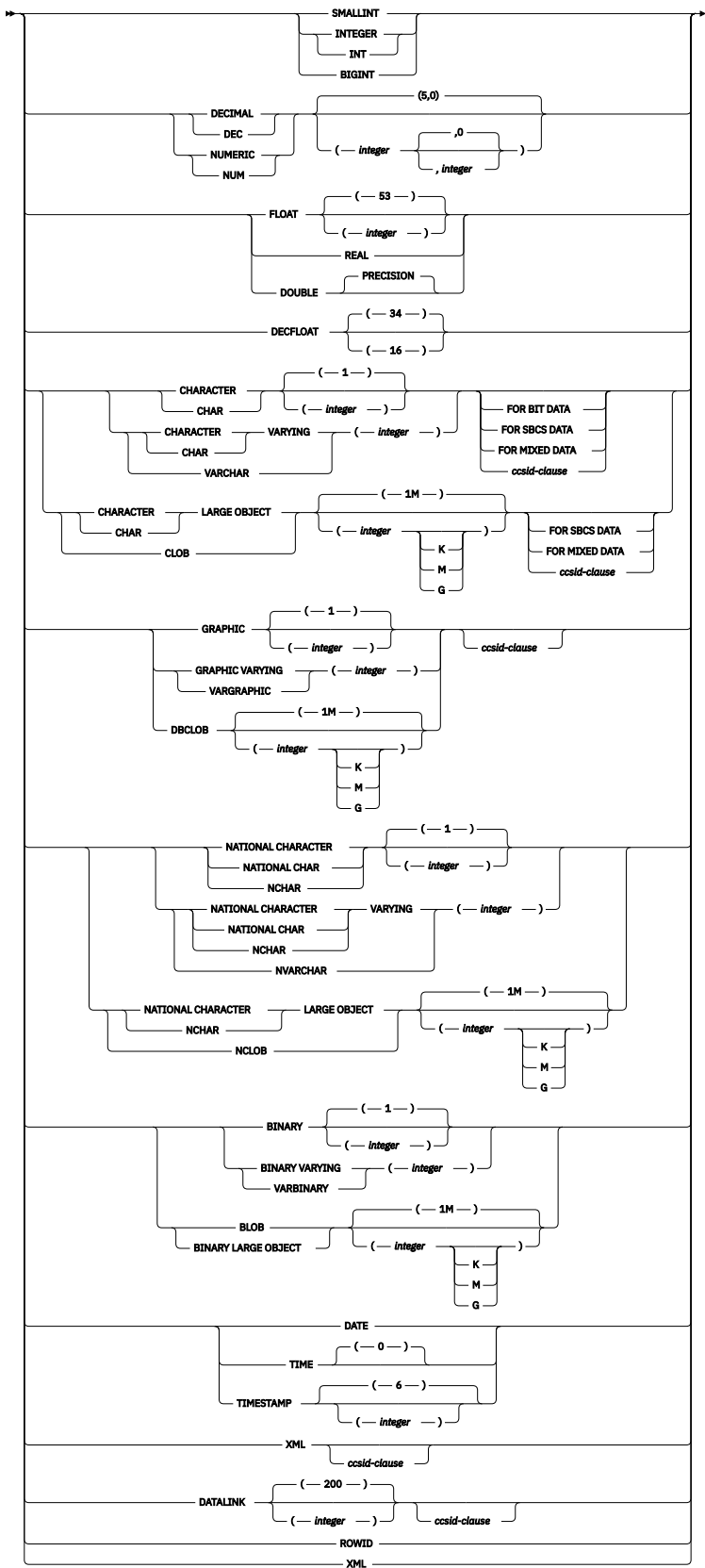

ccsid-clause

➤ CCSID — *integer* ➤

Description

IF EXISTS

Specifies that no error is issued if the specified object does not exist. Unless other conditions or dependencies prevent the drop operation, a successful SQLSTATE is returned even if no object is dropped.

ALIAS *alias-name*

Identifies the alias that is to be dropped. The *alias-name* must identify an alias that exists at the current server.

The specified alias is deleted from the schema. Dropping an alias has no effect on any constraint, view, or materialized query that was defined using the alias. An alias can be dropped whether it is referenced in a function, package, procedure, program, trigger, or variable.

FUNCTION or SPECIFIC FUNCTION

Identifies the function that is to be dropped. The function must exist at the current server and it must be a function that was defined with the CREATE FUNCTION statement. The particular function can be identified by its name, function signature, or specific name.

Functions implicitly generated by the CREATE TYPE statement cannot be dropped using the DROP statement. They are implicitly dropped when the distinct type is dropped.

The function cannot be dropped if another function is dependent on it. A function is dependent on another function if it was identified in the SOURCE clause of the CREATE FUNCTION statement. A function can be dropped whether it is referenced in a function, package, procedure, program, trigger, variable, or view unless RESTRICT is specified. A function cannot be dropped if it is referenced in a mask or permission even if RESTRICT is not specified.

The specified function is dropped from the schema. All privileges on the user-defined function are also dropped. If this is an SQL function or sourced function, the service program (*SRVPGM) associated with the function is also dropped. If this is an external function, the information that was saved in the program or service program specified on the CREATE FUNCTION statement is removed from the object.

FUNCTION *function-name*

Identifies the function by its name. The *function-name* must identify exactly one function. The function may have any number of parameters defined for it. If there is more than one function of the specified name in the specified or implicit schema, an error is returned.

FUNCTION *function-name (parameter-type, ...)*

Identifies the function by its function signature, which uniquely identifies the function. The *function-name (parameter-type, ...)* must identify a function with the specified function signature. The specified parameters must match the data types in the corresponding position that were specified when the function was created. The number of data types, and the logical concatenation of the data types is used to identify the specific function instance which is to be dropped. Synonyms for data types are considered a match. Parameters that have defaults must be included in this signature.

If *function-name ()* is specified, the function identified must have zero parameters.

function-name

Identifies the name of the function.

(parameter-type, ...)

Identifies the parameters of the function.

If an unqualified distinct type name is specified, the database manager searches the SQL path to resolve the schema name for the distinct type.

For data types that have a length, precision, or scale attribute, use one of the following:

- Empty parentheses indicate that the database manager ignores the attribute when determining whether the data types match. For example, DEC() will be considered a match for a parameter of a function defined with a data type of DEC(7,2). However, FLOAT cannot

be specified with empty parenthesis because its parameter value indicates a specific data type (REAL or DOUBLE).

- If a specific value for a length, precision, or scale attribute is specified, the value must exactly match the value that was specified (implicitly or explicitly) in the CREATE FUNCTION statement. If the data type is FLOAT, the precision does not have to exactly match the value that was specified because matching is based on the data type (REAL or DOUBLE).
- If length, precision, or scale is not explicitly specified, and empty parentheses are not specified, the default attributes of the data type are implied. The implicit length must exactly match the value that was specified (implicitly or explicitly) in the CREATE FUNCTION statement.

Specifying the FOR DATA clause or CCSID clause is optional. Omission of either clause indicates that the database manager ignores the attribute when determining whether the data types match. If either clause is specified, it must match the value that was implicitly or explicitly specified in the CREATE FUNCTION statement.

AS LOCATOR

Specifies that the function is defined to receive a locator for this parameter. If AS LOCATOR is specified, the data type must be a LOB or XML or a distinct type based on a LOB or XML.

SPECIFIC FUNCTION *specific-name*

Identifies the function by its specific name. The *specific-name* must identify a specific function that exists at the current server.

RESTRICT

Specifies that the function cannot be dropped if it is referenced in an SQL function, SQL procedure, table, mask, permission, SQL trigger, variable, or view.

RESTRICT not specified

If the function is referenced in a mask or permission, the drop will fail unless the authorization ID of the statement has security administrator authority.

INDEX *index-name*

Identifies the index that is to be dropped. The *index-name* must identify an index that exists at the current server.

The specified index is dropped from the schema. An index can be dropped whether it is referenced in a function, package, procedure, program, or trigger.

MASK *mask-name*

Identifies the mask that is to be dropped. The *mask-name* must identify a mask that exists at the current server.

The specified mask is dropped from the schema. A mask can be dropped whether it is referenced in a function, package, procedure, program, or trigger.

PACKAGE *package-name*

Identifies the package that is to be dropped. The *package-name* must identify a package that exists at the current server.

The specified package is dropped from the schema. All privileges on the package are also dropped.

A package can be dropped whether it is referenced in a function, package, procedure, program, or trigger.

VERSION *version-id*

version-id is the version identifier that was assigned to the package when it was created. If *version-id* is not specified, a null string is used as the version identifier.

PERMISSION *permission-name*

Identifies the permission that is to be dropped. The *permission-name* must identify a permission that exists at the current server.

The specified permission is dropped from the schema. A permission can be dropped whether it is referenced in a function, package, procedure, program, or trigger.

PROCEDURE or SPECIFIC PROCEDURE

Identifies the procedure that is to be dropped. The *procedure-name* must identify a procedure that exists at the current server.

The specified procedure is dropped from the schema. All privileges on the procedure are also dropped. If this is an SQL procedure, the program (*PGM) or service program (*SRVPGM) associated with the procedure is also dropped. If this is an external procedure, the information that was saved in the program specified on the CREATE PROCEDURE statement is removed from the object.

A procedure can be dropped whether it is referenced in a function, package, procedure, program, or trigger.

PROCEDURE *procedure-name*

Identifies the procedure by its name. The *procedure-name* must identify exactly one procedure. The procedure may have any number of parameters defined for it. If there is more than one procedure of the specified name in the specified or implicit schema, an error is returned.

PROCEDURE *procedure-name (parameter-type, ...)*

Identifies the procedure by its procedure signature, which uniquely identifies the procedure. The *procedure-name (parameter-type, ...)* must identify a procedure with the specified procedure signature. The specified parameters must match the data types in the corresponding position that were specified when the procedure was created. The number of data types, and the logical concatenation of the data types is used to identify the specific procedure instance which is to be dropped. Synonyms for data types are considered a match. Parameters that have defaults must be included in this signature.

If *procedure-name ()* is specified, the procedure identified must have zero parameters.

procedure-name

Identifies the name of the procedure.

(parameter-type, ...)

Identifies the parameters of the procedure.

If an unqualified distinct type or array type name is specified, the database manager searches the SQL path to resolve the schema name for the distinct type or array type.

For data types that have a length, precision, or scale attribute, use one of the following:

- Empty parentheses indicate that the database manager ignores the attribute when determining whether the data types match. For example, DEC() will be considered a match for a parameter of a procedure defined with a data type of DEC(7,2). However, FLOAT cannot be specified with empty parenthesis because its parameter value indicates a specific data type (REAL or DOUBLE).
- If a specific value for a length, precision, or scale attribute is specified, the value must exactly match the value that was specified (implicitly or explicitly) in the CREATE PROCEDURE statement. If the data type is FLOAT, the precision does not have to exactly match the value that was specified because matching is based on the data type (REAL or DOUBLE).
- If length, precision, or scale is not explicitly specified, and empty parentheses are not specified, the default attributes of the data type are implied. The implicit length must exactly match the value that was specified (implicitly or explicitly) in the CREATE PROCEDURE statement.

Specifying the FOR DATA clause or CCSID clause is optional. Omission of either clause indicates that the database manager ignores the attribute when determining whether the data types match. If either clause is specified, it must match the value that was implicitly or explicitly specified in the CREATE PROCEDURE statement.

AS LOCATOR

Specifies that the procedure is defined to receive a locator for this parameter. If AS LOCATOR is specified, the data type must be a LOB or XML or a distinct type based on a LOB or XML.

SPECIFIC PROCEDURE *specific-name*

Identifies the procedure by its specific name. The *specific-name* must identify a specific procedure that exists at the current server.

RESTRICT

Specifies that the procedure cannot be dropped if it is referenced in an SQL function, SQL procedure, or SQL trigger.

SCHEMA *schema-name*

Identifies the schema that is to be dropped. The *schema-name* must identify a schema that exists at the current server.

The specified schema is dropped. Each object in the schema is dropped as if the appropriate DROP statement was executed with the specified drop option (CASCADE, RESTRICT, or neither). See the DROP description of these object types for information about the handling of objects dependent on these objects.

DROP SCHEMA is only valid when the commit level is *NONE.

Neither CASCADE nor RESTRICT

Specifies that the schema will be dropped even if it is referenced in a function, package, procedure, program, table, mask, permission, trigger, or variable in another schema.

CASCADE

Specifies that any objects in the schema and any triggers that reference the schema will be dropped. Any masks and permissions in a different schema that reference the schema are dropped if the authorization ID of the statement has security administrator authority.

RESTRICT

Specifies that the schema cannot be dropped if it is referenced in an SQL trigger, mask, or permission in another schema or if the schema contains any SQL objects other than catalog views, the journal, and journal receiver.

SEQUENCE *sequence-name*

Identifies the sequence that is to be dropped. The *sequence-name* must identify a sequence that exists at the current server.

RESTRICT

Specifies that the sequence cannot be dropped if it is referenced in an SQL trigger, function, procedure, or variable.

TABLE *table-name*

Identifies the table that is to be dropped. The *table-name* must identify a base table that exists at the current server, but must not identify a catalog table or a history table for a system-period temporal table.

The specified table is dropped from the schema. All privileges, constraints, indexes, masks, permissions, and triggers on the table are also dropped.

Any aliases that reference the specified table are not dropped.

Neither CASCADE nor RESTRICT

Specifies that the table will be dropped even if it is referenced in a constraint, index, trigger, mask, permission, view, or materialized query table. All indexes, views, and materialized query tables that reference the table are dropped even if the authorization ID of the statement does not explicitly have privileges to those objects. If the table is a system-period temporal table, the history table is also dropped. If the table is referenced in a mask or permission, the drop will fail unless the authorization ID of the statement has security administrator authority.

CASCADE

Specifies that the table will be dropped even if it is referenced in a constraint, index, trigger, variable, mask, permission, view, XSR object, or materialized query table. All constraints, indexes, triggers, variables, views, XSR objects and materialized query tables that reference the table are dropped even if the authorization ID of the statement does not explicitly have privileges to those objects. If the table is a system-period temporal table, the history table is also dropped. All masks

and permissions that reference the table are dropped if the authorization ID of the statement has security administrator authority.

RESTRICT

Specifies that the table cannot be dropped if it is referenced in a constraint, index, mask, permission, trigger, variable, view, XSR object, or materialized query table, or if it is a system-period temporal table.

TRIGGER *trigger-name*

Identifies the trigger that is to be dropped. The *trigger-name* must identify a trigger that exists at the current server.

The specified trigger is dropped from the schema. If the trigger is an SQL trigger, the program object associated with the trigger is also deleted from the schema.

If *trigger-name* specifies an INSTEAD OF trigger on a view, another trigger may depend on that trigger through an update against the view.

TYPE *distinct-type-name* or *array-type-name*

Identifies the type that is to be dropped. The *distinct-type-name* or *array-type-name* must identify a distinct type or array type that exists at the current server. The specified type is deleted from the schema.

Neither CASCADE nor RESTRICT

Specifies that the type cannot be dropped if any constraints, indexes, masks, permissions, sequences, tables, variables, and views reference the type.

For every procedure or function R that has parameters or a return value of the type being dropped, the following DROP statement is effectively executed:

```
DROP ROUTINE R
```

For every trigger T that references the type being dropped, the following DROP statement is effectively executed:

```
DROP TRIGGER T
```

It is possible that this statement would cascade to drop dependent functions or procedures. If all of these functions or procedures are in the list to be dropped because of a dependency on the type, the drop of the type will succeed.

CASCADE

Specifies that the type will be dropped even if it is referenced in a constraint, function, index, procedure, sequence, table, trigger, variable, or view. All constraints, functions, indexes, procedures, sequences, tables, triggers, variables, and views that reference the type are dropped. The cascade processing is limited to cases where the type is used to define the routine parameter type, sequence type, variable type and column type. All masks and permissions that reference the type are dropped if the authorization ID of the statement has security administrator authority.

RESTRICT

Specifies that the type cannot be dropped if it is referenced in a constraint, function (other than a function that was created when the type was created), index, procedure, sequence, table, mask, permission, trigger, variable, or view. The restrict checking is limited to cases where the type is used to define the routine parameter type, sequence type, variable type and column type.

VARIABLE *variable-name*

Identifies the variable that is to be dropped. The *variable-name* must identify a variable that exists at the current server. The specified variable is dropped from the schema.

Neither CASCADE nor RESTRICT

Specifies that the variable will be dropped even if it is referenced in a trigger, procedure, function, mask, permission, view, or another variable. All tables and views that reference the variable are dropped. If the variable is referenced in a mask or permissions, the drop will fail unless the authorization ID of the statement has security administrator authority.

CASCADE

Specifies that the variable will be dropped even if it is referenced in a table, trigger, procedure, function, view, or another variable. All tables, triggers, procedures, functions, views, and variables that reference the variable are dropped. All masks and permissions that reference the variable are dropped if the authorization ID of the statement has security administrator authority.

RESTRICT

Specifies that the variable cannot be dropped if it is referenced in a table, trigger, procedure, function, mask, permission, view, or another variable.

VIEW *view-name*

Identifies the view that is to be dropped. The *view-name* must identify a view that exists at the current server, but must not identify a catalog view.

The specified view is dropped from the schema. When a view is dropped, all privileges and triggers on that view are dropped.

Neither CASCADE nor RESTRICT

Specifies that the view will be dropped even if it is referenced in a trigger, materialized query table, mask, permission, or another view. All views and materialized query tables that reference the view are dropped. If the view is referenced in a mask or permissions, the drop will fail unless the authorization ID of the statement has security administrator authority.

CASCADE

Specifies that the view will be dropped even if it is referenced in a trigger, variable, materialized query table, or another view. All triggers, variables, materialized query tables, and views that reference the view are dropped. All masks and permissions that reference the view are dropped if the authorization ID of the statement has security administrator authority.

RESTRICT

Specifies that the view cannot be dropped if it is referenced in a trigger, variable, mask, permission, materialized query table, or another view.

XSROBJECT *xsobject-name*

Identifies the XSR object that is to be dropped. The *xsobject-name* must identify an XSR object that exists at the current server. The specified XSR object is dropped.

Notes

Drop effects: Whenever an object is dropped, its description is dropped from the catalog. If the object is referenced in a function, package, procedure, program, trigger, or variable; any access plans that reference the object are implicitly prepared again when the access plan is next used. If the object does not exist at that time, an error is returned.

Dependencies: Whenever an object is directly or indirectly dropped, other objects that depend on the dropped object might also be dropped. The following semantics determine what happens to a dependent object when the object that it depends on (the underlying object) is dropped:

Three different types of dependencies are shown:

D

Dependent object is dropped.

A

Automatic revalidation is required. The database manager will attempt to revalidate the object when it is referenced.

R

DROP statement fails.

Table 89. Effect of dropping objects that have dependencies

Drop Statement	ALIAS	CONSTRAINT	FUNCTION	INDEX	MASK	PERMISSION	PROCEDURE	SCHEMA	SEQUENCE	TABLE	TRIGGER	TYPE	VARIABLE	VIEW
DROP ALIAS														
DROP FUNCTION			R ¹		A	A	A			A	A		A	A
DROP FUNCTION RESTRICT			R		R	R	R			R	R		R	R
DROP INDEX														
DROP MASK														
DROP PACKAGE														
DROP PERMISSION														
DROP PROCEDURE			A				A				A			
DROP PROCEDURE RESTRICT			R				R				R			
DROP SCHEMA ²			A		A	A	A			A	A		A	A
DROP SCHEMA CASCADE ³			A		D	D	A			A	D		A	A
DROP SCHEMA RESTRICT ⁴			A		R	R	A			A	R		A	A
DROP SEQUENCE			A				A				A		A	
DROP SEQUENCE RESTRICT			R				R				R		R	
DROP TABLE		D	A	D	A	A	A			D	A		A	D
DROP TABLE CASCADE		D	A	D	D	D	A			D	D		D	D
DROP TABLE RESTRICT		R	A	R	R	R	A			R	R		R	R
DROP TRIGGER														
DROP TYPE		R	D ⁵	R	R	R	D		R	R	D		R	R
DROP TYPE CASCADE		D	D	D	D	D	D		D	D	D		D	D
DROP TYPE RESTRICT		R	R	R	R	R	R		R	R	R		R	R
DROP VARIABLE			A		A	A	A			D	A		A	D
DROP VARIABLE CASCADE			D		D	D	D			D	D		D	D
DROP VARIABLE RESTRICT			R		R	R	R			R	R		R	R
DROP VIEW			A		A	A				D	A		A	D
DROP VIEW CASCADE			A		D	D	A			D	D		D	D
DROP VIEW RESTRICT			A		R	R	A			R	R		R	R
DROP XSROBJ			A		A	A	A				A		A	A

Table 89. Effect of dropping objects that have dependencies (continued)

Drop Statement	ALIAS	CONSTRAINT	FUNCTION	INDEX	MASK	PERMISSION	PROCEDURE	SCHEMA	SEQUENCE	TABLE	TRIGGER	TYPE	VARIABLE	VIEW
Notes:														
1. If other user-defined functions are sourced on the function being dropped, the function cannot be dropped.														
2. DROP SCHEMA will drop all objects in the schema. Any objects in other schemas that reference the schema will not be changed and will require automatic revalidation.														
3. DROP SCHEMA CASCADE will drop all objects in the schema. Triggers in other schemas that reference the schema will be dropped. Other objects in other schemas that reference the schema will not be changed and will require automatic revalidation.														
4. DROP SCHEMA RESTRICT will fail if any object other than SQL catalog views, journals, and journal receivers exist in the schema. Objects other than triggers in other schemas that reference the schema will not be changed and will require automatic revalidation.														
5. Any function or procedure that has a parameter or returns value defined as the type will be dropped.														

Syntax alternatives: The following keywords are synonyms supported for compatibility to prior releases. These keywords are non-standard and should not be used:

- The keyword SYNONYM can be used as a synonym for ALIAS.
- The keywords DATA TYPE or DISTINCT TYPE can be used as a synonym for TYPE.
- The keyword PROGRAM can be used as a synonym for PACKAGE.
- The keyword COLLECTION can be used as a synonym for SCHEMA.

For compatibility with other database products, the IF EXISTS clause can be specified following *table-name* for DROP TABLE.

Examples

Example 1: Drop your table named MY_IN_TRAY. Do not allow the drop if any views or indexes are created over this table.

```
DROP TABLE MY_IN_TRAY RESTRICT
```

Example 2: Drop your view named MA_PROJ.

```
DROP VIEW MA_PROJ
```

Example 3: Drop the package named PERS.PACKA.

```
DROP PACKAGE PERS.PACKA
```

Example 4: Drop the distinct type DOCUMENT, if it is not currently in use:

```
DROP DISTINCT TYPE DOCUMENT RESTRICT
```

Example 5: Assume that you are SMITH and that ATOMIC_WEIGHT is the only function with that name in schema CHEM. Drop ATOMIC_WEIGHT.

```
DROP FUNCTION CHEM.ATOMIC_WEIGHT RESTRICT
```

Example 6: Drop the function named CENTER, using the function signature to identify the function instance to be dropped.

```
DROP FUNCTION CENTER (INTEGER, FLOAT) RESTRICT
```

Example 7: Drop CENTER, using the specific name to identify the function instance to be dropped.

```
DROP SPECIFIC FUNCTION JOHNSON.FOCUS97
```

Example 8: Assume that procedure OSMOSIS is in schema BIOLOGY. Drop OSMOSIS.

```
DROP PROCEDURE BIOLOGY.OSMOSIS
```

Example 9: Assume that trigger BONUS exists in the default schema. Drop BONUS.

```
DROP TRIGGER BONUS
```

END DECLARE SECTION

The END DECLARE SECTION statement marks the end of an SQL declare section.

Invocation

This statement can only be embedded in an application program. It is not an executable statement. It must not be specified in RPG, Java, or REXX.

Authorization

None required.

Syntax

➤ END DECLARE SECTION ➤

Description

The END DECLARE SECTION statement can be coded in the application program wherever declarations can appear in accordance with the rules of the host language. It is used to indicate the end of an SQL declare section. An SQL declare section starts with a BEGIN DECLARE SECTION statement. For more information about the BEGIN DECLARE SECTION statement, see [“BEGIN DECLARE SECTION”](#) on page 918.

The BEGIN DECLARE SECTION and the END DECLARE SECTION statements must be paired and cannot be nested.

Examples

See [“BEGIN DECLARE SECTION”](#) on page 918 for examples using the END DECLARE SECTION statement.

EXECUTE

The EXECUTE statement executes a prepared SQL statement.

Invocation

This statement can only be embedded in an application program, SQL function, SQL procedure, or trigger. It is an executable statement that cannot be dynamically prepared. It must not be specified in Java.

Authorization

If a global variable is referenced in a statement, the privileges held by the authorization ID of the statement must include at least one of the following:

- For the global variable identified in the statement,
 - The READ privilege on the global variable, and
 - The USAGE privilege on the schema containing the global variable
- Database administrator authority

The authorization rules are those defined for the SQL statement specified by EXECUTE. For example, see the description of INSERT for the authorization rules that apply when an INSERT statement is executed using EXECUTE.

The authorization ID of the statement is the run-time authorization ID unless DYNUSRPRF(*OWNER) was specified on the CRTSQLxxx command when the program was created. For more information, see [“Authorization IDs and authorization names”](#) on page 61.

Syntax

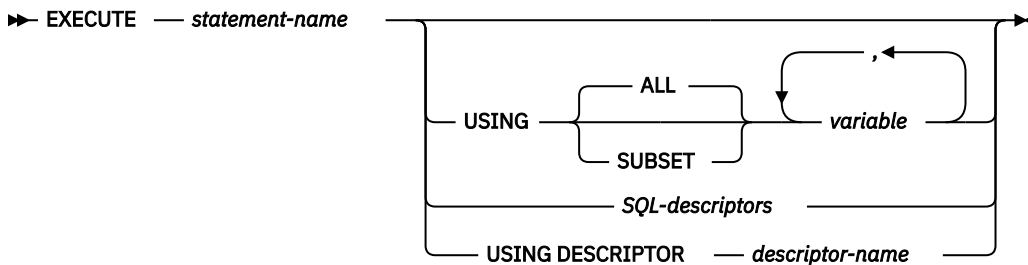

SQL-descriptors

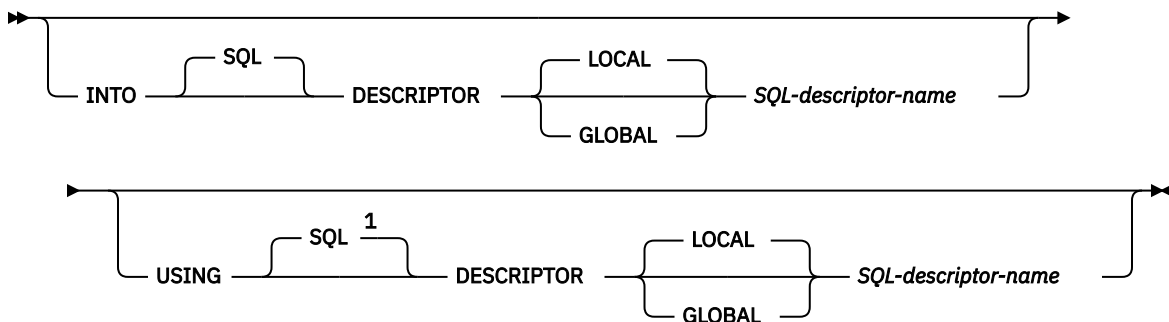

Notes:

¹ If an SQL descriptor is specified in the USING clause and the INTO clause is not specified, USING DESCRIPTOR is not allowed and USING SQL DESCRIPTOR must be specified.

Description

statement-name

Identifies the prepared statement to be executed. When the EXECUTE statement is executed, the name must identify a prepared statement at the current server. The prepared statement cannot be a SELECT statement.

USING

Introduces a list of variables whose values are substituted for the parameter markers (question marks) in the prepared statement. For an explanation of parameter markers, see [“PREPARE” on page 1427](#). If the prepared statement includes parameter markers, the USING clause must be used. USING is ignored if there are no parameter markers.

USING ALL or USING SUBSET

Identifies host structures or variables.

USING ALL

All the variables in the list are used for substitution of parameter markers in the prepared statement.

USING SUBSET

Some or all of the variables in the list are used for substitution of parameter markers in the prepared statement.

- Any host variable with an extended indicator value of UNASSIGNED will be removed from the list. The result is as if the host variable was not specified in the statement.
- All other indicator values have no special meaning to the EXECUTE statement.

When using this clause, a variable with an indicator value of UNASSIGNED cannot be used for substitution of parameter markers in the prepared statement.

variable,...

Identifies one or more host structures or variables that must be declared in the program in accordance with the rules for declaring host structures and variables. A reference to a host structure is replaced by a reference to each of its variables. The number of variables must be the same as the number of parameter markers in the prepared statement. The *n*th variable corresponds to the *n*th parameter marker in the prepared statement.

A global variable may only be used if the current connection is a local connection (not a DRDA connection).

SQL-descriptors

INTO

Identifies an SQL descriptor which contains valid descriptions of the output variables to be used with the EXECUTE statement. This clause is only valid for a CALL or VALUES INTO statement. Before the EXECUTE statement is executed, a descriptor must be allocated using the ALLOCATE DESCRIPTOR statement.

LOCAL

Specifies the scope of the name of the descriptor to be local to program invocation.

GLOBAL

Specifies the scope of the name of the descriptor to be global to the SQL session.

SQL-descriptor-name

Names the SQL descriptor. The name must identify a descriptor that already exists with the specified scope.

See [“GET DESCRIPTOR” on page 1311](#) for an explanation of the information that is placed in the SQL descriptor.

USING

Identifies an SQL descriptor which contains valid descriptions of the input variables to be used with the EXECUTE statement. Before the EXECUTE statement is executed, a descriptor must be allocated using the ALLOCATE DESCRIPTOR statement.

LOCAL

Specifies the scope of the name of the descriptor to be local to program invocation. The information is returned from the descriptor known in this local scope.

GLOBAL

Specifies the scope of the name of the descriptor to be global to the SQL session. The information is returned from the descriptor known to any program that executes using the same database connection.

SQL-descriptor-name

Names the SQL descriptor. The name must identify a descriptor that already exists with the specified scope.

See “[SET DESCRIPTOR](#)” on page 1498 for an explanation of the information in the SQL descriptor.

DESCRIPTOR descriptor-name

Identifies an SQLDA that must contain a valid description of variables.

Before the EXECUTE statement is processed, the user must set the following fields in the SQLDA. (The rules for REXX are different. For more information, see the [Embedded SQL Programming](#) topic collection.)

- SQLN to indicate the number of SQLVAR occurrences provided in the SQLDA.
- SQLDABC to indicate the number of bytes of storage allocated for the SQLDA.
- SQLD to indicate the number of variables used in the SQLDA when processing the statement.
- SQLVAR occurrences to indicate the attributes of the variables.

The SQLDA must have enough storage to contain all SQLVAR occurrences. If LOBs or distinct types are present in the results, there must be additional SQLVAR entries for each parameter. For more information about the SQLDA, which includes a description of the SQLVAR and an explanation on how to determine the number of SQLVAR occurrences, see “[Determining how many SQLVAR occurrences are needed](#)” on page 1670.

SQLD must be set to a value greater than or equal to zero and less than or equal to SQLN. It must be the same as the number of parameter markers in the prepared statement. The *n*th variable described by the SQLDA corresponds to the *n*th parameter marker in the prepared statement.

Note that RPG/400 does not provide the function for setting pointers. Because the SQLDA uses pointers to locate the appropriate variables, you have to set these pointers outside your RPG/400 application.

Notes

Parameter marker replacement: Before the prepared statement is executed, each parameter marker in the statement is effectively replaced by its corresponding variable. The replacement of a parameter marker is an assignment operation in which the source is the value of the variable, and the target is a variable within the database manager. For a typed parameter marker, the attributes of the target variable are those specified by the CAST specification. For an untyped parameter marker, the attributes of the target variable are determined according to the context of the parameter marker. For the rules that affect parameter markers, see [Table 115 on page 1434](#).

Let V denote a variable that corresponds to parameter marker P. The value of V is assigned to the target variable for P using storage assignment rules as described in “[Assignments and comparisons](#)” on page 91. Thus:

- V must be compatible with the target.
- If V is a number, the absolute value of its integral part must not be greater than the maximum absolute value of the integral part of the target.
- If the attributes of V are not identical to the attributes of the target, the value is converted to conform to the attributes of the target.

- If the target cannot contain nulls, the value of V must not be null.

However, unlike the storage assignment rules:

- If V is a string, the value will be truncated (without an error), if its length is greater than the length attribute of the target.

When the prepared statement is executed, the value used in place of P is the value of the target variable for P. For example, if V is CHAR(6) and the target is CHAR(8), the value used in place of P is the value of V padded with two blanks.

Examples

Example 1: This example of portions of a COBOL program shows how an INSERT statement with parameter markers is prepared and executed.

```
EXEC SQL BEGIN DECLARE SECTION END-EXEC.
  77 EMP          PIC X(6).
  77 PRJ          PIC X(6).
  77 ACT          PIC S9(4) COMP-4.
  77 TIM          PIC S9(3)V9(2).
  01 HOLDER.
    49 HOLDER-LENGTH PIC S9(4) COMP-4.
    49 HOLDER-VALUE  PIC X(80).
EXEC SQL END DECLARE SECTION END-EXEC.
.
.
.
MOVE 70 TO HOLDER-LENGTH.
MOVE "INSERT INTO EMPPROJACT (EMPNO, PROJNO, ACTNO, EMPTIME)
-   "VALUES (?, ?, ?, ?)" TO HOLDER-VALUE.
EXEC SQL PREPARE MYINSERT FROM :HOLDER END-EXEC.

IF SQLCODE = 0
  PERFORM DO-INSERT THRU END-DO-INSERT
ELSE
  PERFORM ERROR-CONDITION.

DO-INSERT.
  MOVE "000010" TO EMP.
  MOVE "AD3100" TO PRJ.
  MOVE 160     TO ACT.
  MOVE .50    TO TIM.
  EXEC SQL EXECUTE MYINSERT USING :EMP, :PRJ, :ACT, :TIM END-EXEC.
END-DO-INSERT.
.
.
.
```

Example 2: Code an update statement from optional pieces of text, then execute it using the host variables that apply to the generated statement.

Suppose there are two host variables with corresponding indicators:

```
PRED1HV and PRED1IND, a VARCHAR(50) variable
PRED2HV and PRED2IND, a DECIMAL(10,2) variable
```

Build the statement based on selection conditions set by the application. This is pseudocode.

```
stmt = 'UPDATE MYTABLE SET STATUS = 'COMPLETE' WHERE DATECOL = CURRENT DATE ';

IF BUILD_PRED1 THEN
  stmt = stmt CONCAT ' AND COL1 = ?';
  PRED1HV = <specified value>;
  PRED1IND = 0;
ELSE
  PRED1IND = -7;

IF BUILD_PRED2 THEN
  stmt = stmt CONCAT ' AND COL2 = ?';
  PRED2HV = <specified value>;
  PRED2IND = 0;
ELSE
```

```
PRED2IND = -7;  
EXEC SQL PREPARE S1 FROM stmt;
```

The following EXECUTE statement can be used for any combination of generated predicates and will omit any host variables that have an indicator value of -7.

```
EXEC SQL EXECUTE S1 USING SUBSET :PRED1:PRED1IND, PRED2:PRED2IND;
```

If PREDIND1 has a value of -7, the EXECUTE statement is logically equivalent to:

```
EXEC SQL EXECUTE S1 USING PRED2:PRED2IND;
```

EXECUTE IMMEDIATE

EXECUTE IMMEDIATE combines the basic functions of the PREPARE and EXECUTE statements. It can be used to prepare and execute SQL statements that contain neither variables nor parameter markers.

The EXECUTE IMMEDIATE statement:

- Prepares an executable form of an SQL statement from a character string form of the statement
- Executes the SQL statement

Invocation

This statement can only be embedded in an application program, SQL function, SQL procedure, or trigger. It is an executable statement that cannot be dynamically prepared. It must not be specified in Java.

Authorization

If a global variable is referenced in a statement, the privileges held by the authorization ID of the statement must include at least one of the following:

- For the global variable identified in the statement,
 - The READ privilege on the global variable, and
 - The USAGE privilege on the schema containing the global variable
- Database administrator authority

The authorization rules are those defined for the SQL statement specified by EXECUTE IMMEDIATE. For example, see [“INSERT” on page 1387](#) for the authorization rules that apply when an INSERT statement is executed using EXECUTE IMMEDIATE.

The authorization ID of the statement is the run-time authorization ID unless DYNUSRPRF(*OWNER) was specified on the CRTSQLxxx command when the program was created. For more information, see [“Authorization IDs and authorization names” on page 61](#).

Syntax

➤ EXECUTE IMMEDIATE 

Description

variable

Identifies a variable that must be declared in accordance with the rules for declaring character-string or Unicode graphic variables. An indicator variable must not be specified.

expression

An *expression* of the type described in [“Expressions” on page 159](#), that does not include an aggregate function or column name. It must return a value that is a character string or a Unicode graphic string. If a variable is specified in the *expression* it must not have a CCSID of 65535.¹⁰⁴

The value of the identified variable or expression is called a *statement string*.

The statement string must be one of the following SQL statements:¹⁰⁶

¹⁰⁴ In a PL/I program, a PL/I string expression can also be specified.

¹⁰⁵ The target of the SET variable statement must be a global variable.

¹⁰⁶ A *select-statement* is not allowed. To dynamically process a *select-statement*, use the PREPARE, DECLARE CURSOR, and OPEN statements.

ALTER	LOCK TABLE	SET CURRENT IMPLICIT XMLPARSE OPTION
CALL	MERGE	SET CURRENT TEMPORAL SYSTEM_TIME
COMMENT	REFRESH TABLE	SET ENCRYPTION PASSWORD
COMMIT	RELEASE SAVEPOINT	SET PATH
Compound (dynamic)	RENAME	SET SCHEMA
CREATE	REVOKE	SET SESSION AUTHORIZATION
DECLARE GLOBAL TEMPORARY TABLE	ROLLBACK	SET TRANSACTION
DELETE	SAVEPOINT	SET variable ¹⁰⁵
DROP	SET CURRENT DEBUG MODE	TRANSFER OWNERSHIP
GRANT	SET CURRENT DECFLOAT ROUNDING MODE	TRUNCATE
INSERT	SET CURRENT DEGREE	UPDATE
LABEL		

The statement string must not:

- Begin with EXEC SQL.
- End with END-EXEC or a semicolon.
- Include references to variables. Global variables are allowed.
- Include parameter markers.

When an EXECUTE IMMEDIATE statement is executed, the specified statement string is parsed and checked for errors. If the SQL statement is not valid, it is not executed and the error condition that prevents its execution is reported in the stand-alone SQLSTATE and SQLCODE. If the SQL statement is valid, but an error occurs during its execution, that error condition is reported in the stand-alone SQLSTATE and SQLCODE. Additional information about the error can be retrieved from the SQL Diagnostics Area (or the SQLCA).

Note

Performance considerations: If the same SQL statement is to be executed more than once, it is more efficient to use the PREPARE and EXECUTE statements rather than the EXECUTE IMMEDIATE statement.

Example

Use C to execute the SQL statement in the variable Qstring.

```
void main ()
{
    EXEC SQL BEGIN DECLARE SECTION;

    char Qstring[100] = "INSERT INTO WORK_TABLE SELECT * FROM EMPPROJACT
        WHERE ACTNO >= 100";

    EXEC SQL END DECLARE SECTION;
    EXEC SQL INCLUDE SQLCA;
    .
    .
    EXEC SQL EXECUTE IMMEDIATE :Qstring;

    return;
}
```

FETCH

The FETCH statement positions a cursor on a row of the result table. It can return zero, one, or multiple rows, and it assigns the values of the rows returned to variables.

Invocation

This statement can only be embedded in an application program. It is an executable statement that cannot be dynamically prepared. Multiple row fetch is not allowed in a REXX procedure.

Authorization

See “[DECLARE CURSOR](#)” on page 1207 for an explanation of the authorization required to use a cursor.

If a global variable is specified in the INTO variable list, the privileges held by the authorization ID of the statement must include at least one of the following:

- The WRITE privilege on the global variable.
- Database administrator authority

Syntax

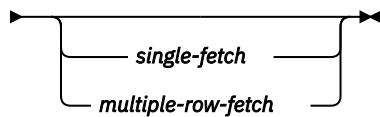
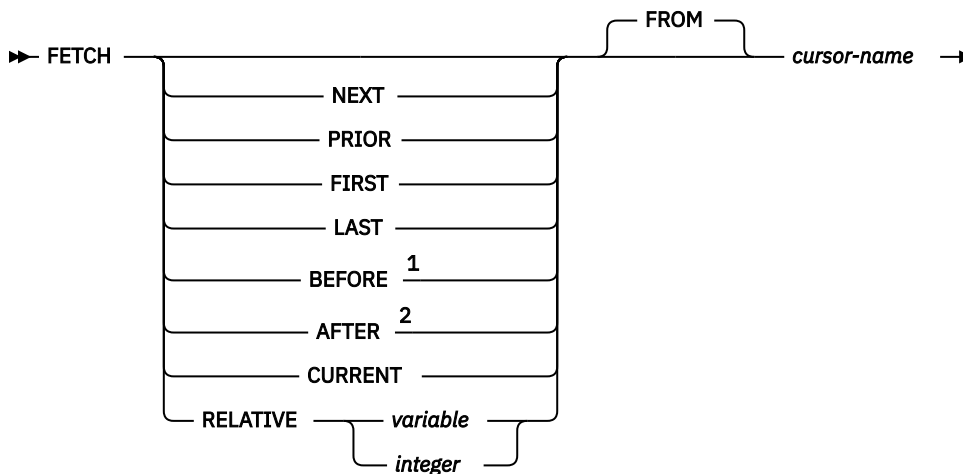

single-fetch

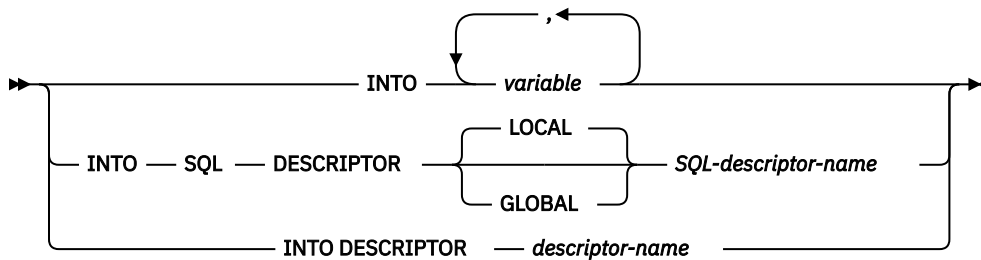

multiple-row-fetch

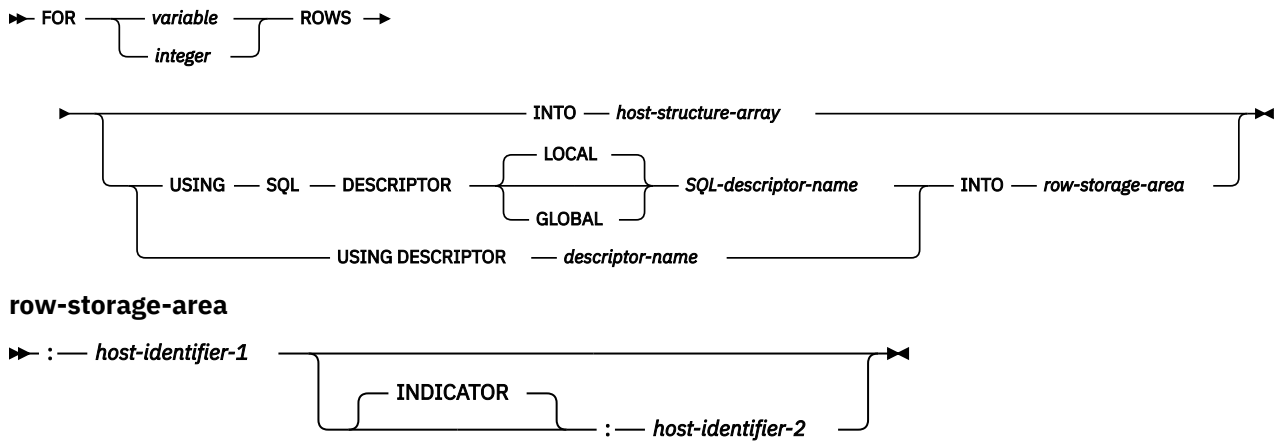

Notes:

- ¹ If BEFORE is specified, a *single-fetch* or *multiple-row-fetch* must not be specified.
- ² If AFTER is specified, a *single-fetch* or *multiple-row-fetch* must not be specified.

Description

The following keywords specify a new position for the cursor: NEXT, PRIOR, FIRST, LAST, BEFORE, AFTER, CURRENT, and RELATIVE. Of those keywords, only NEXT may be used for cursors that have not been declared SCROLL.

NEXT

Positions the cursor on the next row of the result table relative to the current cursor position. NEXT is the default if no other cursor orientation is specified.

PRIOR

Positions the cursor on the previous row of the result table relative to the current cursor position.

FIRST

Positions the cursor on the first row of the result table.

LAST

Positions the cursor on the last row of the result table.

BEFORE

Positions the cursor before the first row of the result table.

AFTER

Positions the cursor after the last row of the result table.

CURRENT

Does not reposition the cursor, but maintains the current cursor position. If the cursor has been declared as DYNAMIC SCROLL and the current row has been updated so its place within the sort order of the result table is changed, an error is returned.

RELATIVE

Variable or *integer* is assigned to an integer value *k*. RELATIVE positions the cursor to the row in the result table that is either *k* rows after the current row if *k*>0, or *k* rows before the current row if *k*<0. If a *variable* is specified, it must be a numeric variable with zero scale and it must not include an indicator variable.

Specification	Alternative
RELATIVE +1	NEXT
RELATIVE -1	PRIOR
RELATIVE 0	CURRENT

FROM

This keyword is provided for clarity only. If a scroll position option is specified, then this keyword is required. If no scrolling option is specified, then the FROM keyword is optional.

cursor-name

Identifies the cursor to be used in the fetch operation. The *cursor-name* must identify a declared cursor as explained in “[Description](#)” on page 1208 for the DECLARE CURSOR statement or when used in Java, an instance of an SQLJ iterator. When the FETCH statement is executed, the cursor must be in the open state.

If a *single-fetch* or *multiple-row-fetch* clause is not specified, no data is returned to the user. However, the cursor is positioned and a row lock may be acquired. For more information about locking, see “[Isolation level](#)” on page 23.

single-fetch

INTO *variable*,...

Identifies one or more host structures or variables that must be declared in accordance with the rules for declaring host structures and variables. In the operational form of INTO, a host structure is replaced by a reference to each of its variables. The first value in the result row is assigned to the first variable in the list, the second value to the second variable, and so on.

A global variable may only be used if the current connection is a local connection (not a DRDA connection).

INTO SQL DESCRIPTOR *SQL-descriptor-name*

Identifies an SQL descriptor which contains valid descriptions of the output variables to be used with the FETCH statement. Before the FETCH statement is executed, a descriptor must be allocated using the ALLOCATE DESCRIPTOR statement.

LOCAL

Specifies the scope of the name of the descriptor to be local to program invocation.

GLOBAL

Specifies the scope of the name of the descriptor to be global to the SQL session.

SQL-descriptor-name

Names the SQL descriptor. The name must identify a descriptor that already exists with the specified scope.

See “[SET DESCRIPTOR](#)” on page 1498 for an explanation of the information in the SQL descriptor.

INTO DESCRIPTOR *descriptor-name*

Identifies an SQLDA that must contain a valid description of zero or more variables.

Before the FETCH statement is processed, the user must set the following fields in the SQLDA. (The rules for REXX are different. For more information see the [Embedded SQL Programming](#) topic collection.)

- SQLN to indicate the number of SQLVAR occurrences provided in the SQLDA
- SQLDABC to indicate the number of bytes of storage allocated for the SQLDA
- SQLD to indicate the number of variables used in the SQLDA when processing the statement
- SQLVAR occurrences to indicate the attributes of the variables

The SQLDA must have enough storage to contain all SQLVAR occurrences. Therefore, the value in SQLDABC must be greater than or equal to $16 + \text{SQLN} * (80)$, where 80 is the length of an SQLVAR occurrence. If LOBs are specified, there must be two SQLVAR entries for each parameter marker and SQLN must be set to two times the number of parameter markers.

SQLD must be set to a value greater than or equal to zero and less than or equal to SQLN. For more information, see [Appendix D, “SQLDA \(SQL descriptor area\),”](#) on page 1667.

The USING DESCRIPTOR clause is not supported for a FETCH statement within a Java program.

multiple-row-fetch

FOR *variable* or *integer* ROWS

Evaluates *variable* or *integer* to an integral value that represents the number of rows to fetch. If a *variable* is specified, it must be a numeric variable with zero scale and it must not include an indicator variable. It must not be a global variable. The total size of the rows, excluding LOBs, must be less than 16M. The cursor is positioned on the row specified by the orientation keyword (for example, NEXT), and that row is fetched. Then the next rows are fetched (moving forward in the table), until either the specified number of rows have been fetched or the end of the cursor is reached. After the fetch operation, the cursor is positioned on the last row fetched.

For example, FETCH PRIOR FROM C1 FOR 3 ROWS causes the previous row, the current row, and the next row to be returned, in that order. The cursor is positioned on the next row. FETCH RELATIVE -1 FROM C1 FOR 3 ROWS returns the same result. FETCH FIRST FROM C1 FOR :x ROWS returns the first x rows, and leaves the cursor positioned on row number x.

When a *multiple-row-fetch* is successfully executed, three statement information items are available in the SQL Diagnostics Area (or the SQLCA):

- ROW_COUNT (or SQLERRD(3) of the SQLCA) shows the number of rows retrieved.
- DB2_ROW_LENGTH (or SQLERRD(4) of the SQLCA) contains the length of the row retrieved.
- DB2_LAST_ROW (or SQLERRD(5) of the SQLCA) contains +100 if the last row was fetched.¹⁰⁷

INTO *host-structure-array*

host-structure-array identifies an array of host structures defined in accordance with the rules for declaring host structures.

The first structure in the array corresponds to the first row, the second structure in the array corresponds to the second row, and so on. In addition, the first value in the row corresponds to the first item in the structure, the second value in the row corresponds to the second item in the structure, and so on. The number of rows to be fetched must be less than or equal to the dimension of the host structure array.

USING SQL DESCRIPTOR *SQL-descriptor-name*

Identifies an SQL descriptor.

LOCAL

Specifies the scope of the name of the descriptor to be local to program invocation.

GLOBAL

Specifies the scope of the name of the descriptor to be global to the SQL session.

SQL-descriptor-name

Names the SQL descriptor. The name must identify a descriptor that already exists with the specified scope.

The COUNT field in the descriptor header must be set to reflect the number of columns in the result set. The TYPE and DATETIME_INTERVAL_CODE (if applicable) must be set for each column in the result set.

USING DESCRIPTOR *descriptor-name*

Identifies an SQLDA that must contain a valid description of zero or more variables that describe the format of a row in the *row-storage-area*.

Before the FETCH statement is processed, the user must set the following fields in the SQLDA:

- SQLN to indicate the number of SQLVAR occurrences provided in the SQLDA.
- SQLDABC to indicate the number of bytes of storage allocated for the SQLDA.
- SQLD to indicate the number of variables used in the SQLDA when processing the statement.

¹⁰⁷ If the number of rows returned is equal to the number of rows requested, then an end of data warning may not occur and DB2_LAST_ROW (or SQLERRD(5) of the SQLCA) may not contain +100.

- SQLVAR occurrences to indicate the attributes of the variables.

The values of the other fields of the SQLDA (such as SQLNAME) may not be defined after the FETCH statement is executed and should not be used.

The SQLDA must have enough storage to contain all SQLVAR occurrences. Therefore, the value in SQLDABC must be greater than or equal to $16 + \text{SQLN} * (80)$, where 80 is the length of an SQLVAR occurrence. If LOBs or distinct types are specified, there must be two SQLVAR entries for each parameter marker and SQLN must be set to two times the number of parameter markers.

SQLD must be set to a value greater than or equal to zero and less than or equal to SQLN. For more information, see [Appendix D, “SQLDA \(SQL descriptor area\),” on page 1667](#).

On completion of the FETCH, the SQLDATA pointer in the first SQLVAR entry addresses the returned value for the first column in the allocated storage in the first row, the SQLDATA pointer in the second SQLVAR entry addresses the returned value for the second column in the allocated storage in the first row, and so on. The SQLIND pointer in the first nullable SQLVAR entry addresses the first indicator value, the SQLIND pointer in the second nullable SQLVAR entry addresses the second indicator value, and so on. The SQLDA must be allocated on a 16-byte boundary.

INTO row-storage-area

host-identifier-1 specified with a variable identifies an allocation of storage in which to return the rows. The rows are returned into the storage area in the format described by the SQLDA or SQL descriptor. *host-identifier-1* must be large enough to hold all the rows requested.

host-identifier-2 identifies the optional indicator area. It should be specified if any of the data types returned are nullable. This variable identifies an allocation of storage in which to return the indicators. The indicators are returned as small integers. *host-identifier-2* must be large enough to contain an indicator for each nullable value for each row to be returned.

The GET DIAGNOSTICS statement can be used to return the DB2_ROW_LENGTH which indicates the length of each row returned into the *row-storage-area*.

The *nth* variable identified by the INTO clause or described in the SQLDA corresponds to the *nth* column of the result table of the cursor. The data type of each variable must be compatible with its corresponding column.

Each assignment to a variable is made according to the retrieval assignment rules described in [“Retrieval assignment” on page 95](#).¹⁰⁸ If the number of variables is less than the number of values in the row, the SQLSTATE is set to '01503' (or the SQLWARN3 field of the SQLCA is set to 'W'). Note that there is no warning if there are more variables than the number of result columns. If the value is null, an indicator variable must be provided. If an assignment error occurs, the value is not assigned to the variable, and no more values are assigned to variables. Any values that have already been assigned to variables remain assigned.

If an error occurs as the result of an arithmetic expression in the SELECT list of an outer SELECT statement (division by zero, overflow, etc.) or a character conversion error occurs, the result is the null value. As in any other case of a null value, an indicator variable must be provided. The value of the variable is undefined. In this case, however, the indicator variable is set to -2. Processing of the statement continues as if the error had not occurred. (However, a warning is returned.) If you do not provide an indicator variable, an error is returned. It is possible that some values have already been assigned to variables and will remain assigned when the error occurs.

multiple-row-fetch is not allowed if any of the result columns are LOBs or if the current connection is to a remote server.

Notes

Cursor position: An open cursor has three possible positions:

- Before a row

¹⁰⁸ If assigning to an SQL-variable or SQL-parameter and the standards option is specified, storage assignment rules apply. For information on the standards option, see [“Standards compliance” on page xix](#).

- On a row
- After the last row

If a cursor is positioned on a row, that row is called the current row of the cursor. A cursor referenced in an UPDATE or DELETE statement must be positioned on a row. A cursor can only be positioned on a row as a result of a FETCH statement.

It is possible for an error to occur that makes the state of the cursor unpredictable.

Variable assignment: The *n*th variable identified by the INTO clause or described in the SQLDA corresponds to the *n*th column of the result table of the cursor. The data type of each variable must be compatible with its corresponding column.

Each assignment to a variable is made according to the Retrieval Assignment rules described in “Assignments and comparisons” on page 91. If the number of variables is less than the number of values in the row, the SQLWARN3 field of the SQLCA is set to 'W'. Note that there is no warning if there are more variables than the number of result columns. If the value is null, an indicator variable must be provided. If an assignment error occurs, the values in the variables are unpredictable.

If the specified variable is a string and is not large enough to contain the result, a warning (SQLSTATE 01004) is returned (and 'W' is assigned to SQLWARN1 in the SQLCA). The actual length of the result is returned in the indicator variable associated with the *variable*, if an indicator variable is provided.

If the specified variable is a C NUL-terminated variable and is not large enough to contain the result and the NUL-terminator:

- If the *CNULRQD option is specified on the CRTSQLCI or CRTSQLCPPI command (or CNULRQD(*YES) on the SET OPTION statement), the following occurs:
 - The result is truncated.
 - The last character is the NUL-terminator.
 - A warning (SQLSTATE 01004) is returned (and 'W' is assigned to SQLWARN1 in the SQLCA).
- If the *NOCNULRQD option on the CRTSQLCI or CRTSQLCPPI command (or CNULRQD(*NO) on the SET OPTION statement) is specified, the following occurs:
 - The NUL-terminator is not returned.
 - A warning (SQLSTATE 01004) is returned (and 'N' is assigned to SQLWARN1 in the SQLCA).

Syntax alternatives: The following keywords are synonyms supported for compatibility to prior releases. These keywords are non-standard and should not be used:

- USING DESCRIPTOR may be used as a synonym for INTO DESCRIPTOR in the single-fetch-clause.

Examples

Example 1: In this C example, the FETCH statement fetches the results of the SELECT statement into the program variables dnum, dname, and mnum. When no more rows remain to be fetched, the not found condition is returned.

```
EXEC SQL DECLARE C1 CURSOR FOR
  SELECT DEPTNO, DEPTNAME, MGRNO FROM TDEPT
  WHERE ADMRDEPT = 'A00';
EXEC SQL OPEN C1;
while (SQLCODE==0) {
  EXEC SQL FETCH C1 INTO :dnum, :dname, :mnum;
}
EXEC SQL CLOSE C1;
```

Example 2: This FETCH statement uses an SQLDA.

```
FETCH CURS USING DESCRIPTOR :sqllda3
```

Example 3: This ILE RPG example uses a row storage area to fetch the data.

```

DCL-S ONE_ROW_PTR POINTER;
DCL-DS ONE_ROW BASED(ONE_ROW_PTR);
  DEPTNO   CHAR(3);
  DEPTNAME VARCHAR(36);
  MGRNO    CHAR(6);
END-DS;
DCL-S ONE_ROW_IND_PTR POINTER;
DCL-DS ONE_ROW_IND BASED(ONE_ROW_IND_PTR);
  DEPTNOIND   INT(5);
  DEPTNAMEIND INT(5);
  MGRNOIND    INT(5);
END-DS;
DCL-S ROWAREA CHAR(450); // 10 records * %SIZE(ONE_ROW)
DCL-S INDAREA CHAR(60); // 10 records * %SIZE(ONE_ROW_IND)
DCL-S ROWS_RETURNED INT(5);
DCL-S I INT(5);

EXEC SQL DECLARE C1 CURSOR FOR
  SELECT DEPTNO, DEPTNAME, MGRNO FROM CORPDATA.DEPARTMENT;

// Set up the descriptor
EXEC SQL ALLOCATE DESCRIPTOR 'FETCH_ROWS' WITH MAX 10;
EXEC SQL SET DESCRIPTOR 'FETCH_ROWS'
  COUNT = 3; // Descriptor contains 3 items
EXEC SQL SET DESCRIPTOR 'FETCH_ROWS'
  VALUE 1 TYPE = 1, LENGTH = 3; // First is CHAR(3)
EXEC SQL SET DESCRIPTOR 'FETCH_ROWS'
  VALUE 2 TYPE = 12, LENGTH = 36; // Second is VARCHAR(36)
EXEC SQL SET DESCRIPTOR 'FETCH_ROWS'
  VALUE 3 TYPE = 1, LENGTH = 6; // Third is CHAR(6)

// Fetch the data
EXEC SQL OPEN C1;
EXEC SQL FETCH C1 FOR 10 ROWS
  USING SQL DESCRIPTOR 'FETCH_ROWS'
  INTO :ROWAREA:INDAREA;
EXEC SQL GET DIAGNOSTICS :ROWS_RETURNED = ROW_COUNT;
EXEC SQL CLOSE C1;

ONE_ROW_PTR = %ADDR(ROWAREA); // Get first row
ONE_ROW_IND_PTR = %ADDR(INDAREA); // Indicators for first row
FOR I = 1 TO ROWS_RETURNED;
  IF MGRNOIND >= 0; // Not a null value
    // Do something with MGRNO
  ENDIF;
  // Handle other values for first row
  ONE_ROW_PTR = ONE_ROW_PTR + %SIZE(ONE_ROW); // Advance to next row
  ONE_ROW_IND_PTR = ONE_ROW_IND_PTR + %SIZE(ONE_ROW_IND);
ENDFOR;

```

FREE LOCATOR

The FREE LOCATOR statement removes the association between a locator variable and its value.

Invocation

This statement can only be embedded in an application program. It cannot be issued interactively. It is an executable statement that can be dynamically prepared. However, the EXECUTE statement with the USING clause must be used to execute the prepared statement. FREE LOCATOR cannot be used with the EXECUTE IMMEDIATE statement. It must not be specified in Java or REXX.

Authorization

None required.

Syntax

►► FREE LOCATOR *variable* ◄◄

Description

variable,...

Identifies one or more locator variables that must be declared in accordance with the rules for declaring locator variables. The locator variable type must be a binary large object locator, a character large object locator, a double-byte character large object locator, or an XML locator.

The *variable* must currently have a locator assigned to it. That is, a locator must have been assigned during this unit of work (by a CALL, FETCH, SELECT INTO, assignment statement, SET variable, or VALUES INTO statement) and must not subsequently have been freed (by a FREE LOCATOR statement); otherwise, an error is returned.

If more than one locator variable is specified and an error occurs on one of the locators, no locators will be freed.

Example

Assume that the employee table contains columns RESUME, HISTORY, and PICTURE and that locators have been established in a program to represent the column values. In a COBOL program, free the CLOB locator variables LOCRES and LOCHIST, and the BLOB locator variable LOCPIC.

```
EXEC SQL  
FREE LOCATOR :LOCRES, :LOCHIST, :LOCPIC  
END-EXEC.
```

GET DESCRIPTOR

The GET DESCRIPTOR statement gets information from an SQL descriptor.

Invocation

This statement can only be embedded in an application program, SQL function, SQL procedure, or trigger. It cannot be issued interactively. It is an executable statement that cannot be dynamically prepared. It must not be specified in REXX.

Authorization

None required.

Syntax

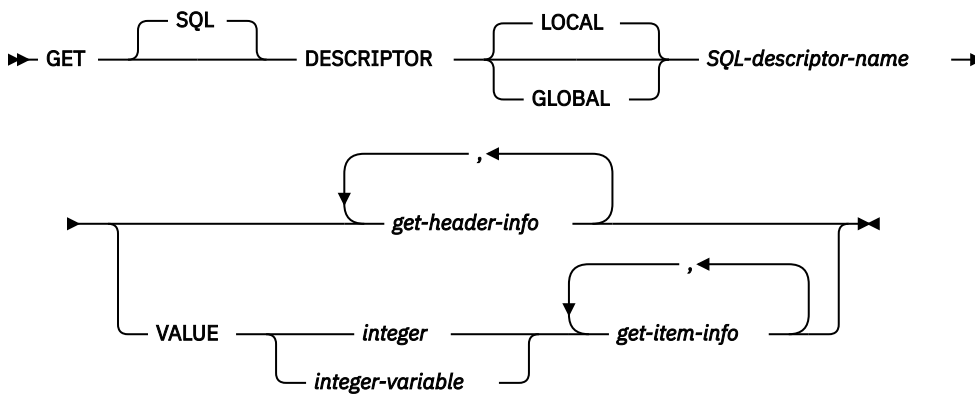

get-header-info

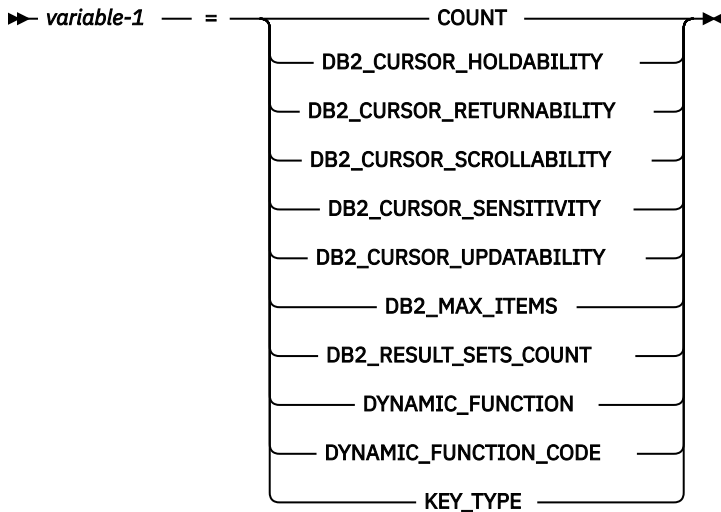

get-item-info

variable-2	CARDINALITY
	DATA
	DATETIME_INTERVAL_CODE
	DB2_BASE_CATALOG_NAME
	DB2_BASE_COLUMN_NAME
	DB2_BASE_SCHEMA_NAME
	DB2_BASE_TABLE_NAME
	DB2_CCSID
	DB2_COLUMN_CATALOG_NAME
	DB2_COLUMN_GENERATED
	DB2_COLUMN_GENERATION_TYPE
	DB2_COLUMN_HIDDEN
	DB2_COLUMN_NAME
	DB2_COLUMN_ROW_CHANGE
	DB2_COLUMN_SCHEMA_NAME
	DB2_COLUMN_TABLE_NAME
	DB2_COLUMN_UPDATABILITY
	DB2_CORRELATION_NAME
	DB2_CURSOR_NAME
	DB2_LABEL
	DB2_PARAMETER_NAME
	DB2_RESULT_SET_LOCATOR
	DB2_RESULT_SET_ROWS
	DB2_SYSTEM_COLUMN_NAME
	INDICATOR
	KEY_MEMBER
	LENGTH
	LEVEL
	NAME
	NULLABLE
	OCTET_LENGTH
	PARAMETER_MODE
	PARAMETER_ORDINAL_POSITION
	PARAMETER_SPECIFIC_CATALOG
	PARAMETER_SPECIFIC_NAME
	PARAMETER_SPECIFIC_SCHEMA
	PRECISION
	RETURNED_CARDINALITY
	RETURNED_LENGTH
	RETURNED_OCTET_LENGTH
	SCALE
	TYPE
	UNNAMED
	USER_DEFINED_TYPE_CATALOG
	USER_DEFINED_TYPE_CODE
	USER_DEFINED_TYPE_NAME
	USER_DEFINED_TYPE_SCHEMA

Description

LOCAL

Specifies the scope of the name of the descriptor to be local to program invocation. The information is returned from the descriptor known in this local scope.

GLOBAL

Specifies the scope of the name of the descriptor to be global to the SQL session. The information is returned from the descriptor known to any program that executes using the same database connection.

SQL-descriptor-name

Names the SQL descriptor. The name must identify a descriptor that already exists with the specified scope.

get-header-info

Returns information about the prepared SQL statement and SQL descriptor.

VALUE

Identifies the item number for which the specified information is retrieved. If the value is greater than the value of COUNT (from the header information), then no result is returned. If the item number is greater than the maximum number of items allocated for the descriptor or the item number is less than 1, an error is returned.

integer

An integer constant in the range of 1 to the number of items in the SQL descriptor.

integer-variable

Identifies a variable declared in the program in accordance with the rules for declaring variables. It must not be a global variable. The data type of the variable must be SMALLINT, INTEGER, BIGINT, or DECIMAL or NUMERIC with a scale of zero. The value of *integer-variable* must be in the range of 1 to the maximum number of items in the SQL descriptor.

get-item-info

Returns information about a specific item in the SQL descriptor.

get-header-info

variable-1

Identifies a variable declared in the program in accordance with the rules for declaring variables, but must not be a file reference variable or a global variable. The data type of the variable must be compatible with the descriptor information item as specified in [Table 91 on page 1320](#). The variable is assigned (using storage assignment rules) to the corresponding descriptor item. For details on the assignment rules, see [“Assignments and comparisons” on page 91](#).

COUNT

A count of the number of items in the descriptor.

DB2_CURSOR_HOLDABILITY

The hold status of the cursor. The possible values are:

0

The descriptor is not describing a cursor or the cursor was not declared WITH HOLD.

1

The cursor was declared WITH HOLD.

DB2_CURSOR_RETURNABILITY

The return status of the cursor's result set. The possible values are:

0

The descriptor is not describing a cursor or the cursor's result set is not returnable.

1

The cursor's result set is returnable to the caller of the procedure.

2

The cursor's result set is returnable to the client.

DB2_CURSOR_SCROLLABILITY

The scroll status of the cursor. The possible values are:

0

The descriptor is not describing a cursor or the cursor was not declared with SCROLL.

1

The cursor was declared with SCROLL.

DB2_CURSOR_SENSITIVITY

The sensitivity of the cursor. The possible values are:

0

The descriptor is not describing a cursor.

1

The cursor is SENSITIVE DYNAMIC.

3

The cursor is INSENSITIVE.

4

The cursor is ASENSITIVE.

DB2_CURSOR_UPDATABILITY

Specifies whether the cursor can be used in an UPDATE statement with WHERE CURRENT OF *cursor-name*. The possible values are:

0

The descriptor is not describing a cursor or the cursor cannot be used in an UPDATE statement with WHERE CURRENT OF *cursor-name*.

1

The cursor can be used in an UPDATE statement with WHERE CURRENT OF *cursor-name*.

DB2_MAX_ITEMS

Represents the value specified as the allocated maximum number of item descriptors on the ALLOCATE DESCRIPTOR statement. If the WITH MAX clause was not specified, the value is the default number of maximum items for the ALLOCATE DESCRIPTOR statement.

DB2_RESULT_SETS_COUNT

The number of result sets returned by the procedure. The value will be 0 if this descriptor is not describing a procedure.

DYNAMIC_FUNCTION

The type of the prepared SQL statement as a character string. For information on statement type, see [Table 94 on page 1344](#).

DYNAMIC_FUNCTION_CODE

The statement code representing the type of the prepared SQL statement. For information on statement codes, see [Table 94 on page 1344](#).

KEY_TYPE

The type of key included in the select list. The possible values are:

0

The descriptor is not describing the columns of a query or there are no key columns referenced in the query, or there is no unique key.

1

The select list includes all the columns of the primary key of the base table referenced by the query.

2

The table referenced by the query does not have a primary key but the select list includes a set of columns that are defined as the preferred candidate key. If there is more than one such preferred candidate key included in the select list, the left-most preferred candidate key is used.

get-item-info

variable-2

Identifies a variable declared in the program in accordance with the rules for declaring variables, but must not be a file reference variable or a global variable. The data type of the variable must be compatible with the descriptor information item as specified in Table 91 on page 1320. The variable is assigned (using storage assignment rules) to the corresponding descriptor item. For details on the assignment rules, see “[Assignments and comparisons](#)” on page 91.

When getting the DATA item, in general the variable must have the same data type, length, precision, scale, and CCSID as specified in Table 91 on page 1320. For variable-length types, the variable length must not be less than the LENGTH in the descriptor. For C nul-terminated types, the variable length must be at least one greater than the LENGTH in the descriptor.

CARDINALITY

The cardinality of the array data type. If this descriptor is the result of a DESCRIBE, this is the maximum cardinality of the array data type. The cardinality is 0 for all other data types.

DATA

The value for the data described by the item descriptor. If the value of INDICATOR is negative, then the value of DATA is undefined and the INDICATOR *get-item-info* must also be specified in the same statement.

DATETIME_INTERVAL_CODE

Codes that define the specific datetime data type.

- 0**
Descriptor item does not have TYPE value of 9.
- 1**
DATE
- 2**
TIME
- 3**
TIMESTAMP

DB2_BASE_CATALOG_NAME

The server name of the base table for the column represented by the item descriptor.

DB2_BASE_COLUMN_NAME

The name of the column as defined in the base table referenced in the described query, possibly indirectly through a view. If a column name cannot be defined or is not applicable, this item will contain the empty string. The name is returned as case sensitive and without delimiters.

DB2_BASE_SCHEMA_NAME

The schema name of the base table for the column represented by the item descriptor. If a schema name cannot be defined or is not applicable, this item will contain the empty string. The name is returned as case sensitive and without delimiters.

DB2_BASE_TABLE_NAME

The table name of the underlying base table for the column represented by the item descriptor. If a table name cannot be defined or is not applicable, this item will contain the empty string. The name is returned as case sensitive and without delimiters.

DB2_CCSID

The CCSID of character, graphic, or XML data. Value is zero for all types that are not based on character or graphic string or XML types. Value is 65535 for binary types or character types with the FOR BIT DATA attribute.

DB2_COLUMN_CATALOG_NAME

The server name of the referenced table or view for the column represented by the item descriptor. If a column catalog name cannot be defined or is not applicable, this item will contain the empty string.

DB2_COLUMN_GENERATED

Indicates whether a column is generated. Possible values are:

- 0** Not generated
- 1** GENERATED ALWAYS
- 2** GENERATED BY DEFAULT

DB2_COLUMN_GENERATION_TYPE

Indicates how the column is generated. Possible values are:

- 0** Not generated
- 1** IDENTITY column
- 2** ROWID column
- 4** Row change timestamp column
- 5** ROW BEGIN column
- 6** ROW END column
- 7** TRANSACTION START ID column
- 8** Generated expression column

DB2_COLUMN_HIDDEN

Indicates whether the column represented by the item descriptor is hidden. Possible values are:

- 0** Not hidden
- 1** Implicitly hidden
- 3** Implicitly hidden for optimistic locking

DB2_COLUMN_NAME

The name of the column as defined in the table or view referenced in the described query. If a column name cannot be defined or is not applicable, this item will contain the empty string. The name is returned as case sensitive and without delimiters.

DB2_COLUMN_ROW_CHANGE

Indicates whether the column represented by the item descriptor was added as a result of using the WITH ROW CHANGE COLUMNS prepare attribute. Possible values are:

- 1** ROW CHANGE TOKEN (distinct)
- 2** ROW CHANGE TOKEN (not distinct)
- 3** RID (only valid from a remote relational database)
- 4** RID_BIT (only valid from a remote relational database)

DB2_COLUMN_SCHEMA_NAME

The schema name of the referenced table or view for the column represented by the item descriptor. If a column schema name cannot be defined or is not applicable, this item will contain the empty string. The name is returned as case sensitive and without delimiters.

DB2_COLUMN_TABLE_NAME

The table or view name of the referenced table or view for the column represented by the item descriptor. If a column table name cannot be defined or is not applicable, this item will contain the empty string. The name is returned as case sensitive and without delimiters.

DB2_COLUMN_UPDATABILITY

Indicates whether the column represented by the item descriptor is updatable. Possible values are:

0

Not updatable

1

Updatable

DB2_CORRELATION_NAME

The empty string is always returned.

DB2_CURSOR_NAME

The name of the cursor in the procedure for this result set. This is only set when the descriptor is describing a procedure.

DB2_LABEL

The label defined for the column. If there is no label for the column, this item will contain the empty string.

DB2_PARAMETER_NAME

The name of the parameter for the stored procedure. Only returned for a CALL statement. The name is returned as case sensitive and without delimiters.

DB2_RESULT_SET_LOCATOR

The result set locator for this result set. This is only set when the descriptor is describing a procedure.

DB2_RESULT_SET_ROWS

The estimated number of rows in the result set. It is set to the value -1 if the number is unknown. This is only set when the descriptor is describing a procedure.

DB2_SYSTEM_COLUMN_NAME

The system name of the column. If a system name cannot be defined or is not applicable, this item will contain blanks.

INDICATOR

The value for the indicator. A non-negative value is used when the value returned in this descriptor item is given in the DATA field. When extended indicator variables are not enabled, a negative value is used when the value returned in this descriptor item is the null value. When extended indicators are enabled:

- -1, -2, -3, -4, or -6 indicates the value returned in this descriptor is the null value.
- -5 indicates the value returned in this descriptor item is DEFAULT.
- -7 indicates the value returned in this descriptor item is UNASSIGNED.

KEY_MEMBER

An indication of whether this column is part of a key.

0

This column is not part of a key.

1

This column is part of a unique key.

2

This column by itself is a unique key.

LENGTH

Returns the maximum length of the data. If the data type is a character or graphic string, an XML type, or a datetime type, the length represents the number of characters (not bytes). If the data type is a binary string or any other type, the length represents the number of bytes. For a description of data type codes and lengths, see [Table 92 on page 1322](#).

LEVEL

The level of the item descriptor. The value is 0.

NAME

The name associated with the select list column described by the item descriptor. The name is returned as case sensitive and without delimiters.

NULLABLE

Indicates whether the column or parameter marker is nullable.

0

The select list column or parameter marker cannot have a null value.

1

The select list column or parameter marker can have a null value.

OCTET_LENGTH

Returns the maximum length of the data in bytes for all types. For a description of data type codes and lengths, see [Table 92 on page 1322](#).

PARAMETER_MODE

The mode of the parameter marker in a CALL statement.

0

The descriptor is not associated with a CALL statement.

1

Input only parameter.

2

Input and output parameter.

4

Output only parameter.

PARAMETER_ORDINAL_POSITION

The ordinal position of the parameter marker in a CALL statement. The value is 0 if the descriptor is not associated with a CALL statement.

PARAMETER_SPECIFIC_CATALOG

The server name of the procedure containing the parameter marker.

PARAMETER_SPECIFIC_NAME

The specific name of the procedure containing the parameter marker. The name is returned as case sensitive and without delimiters.

PARAMETER_SPECIFIC_SCHEMA

The schema name of the procedure containing the parameter marker. The name is returned as case sensitive and without delimiters.

PRECISION

Returns the precision for the data:

SMALLINT

5

INTEGER

10

BIGINT

19

NUMERIC and DECIMAL

Defined precision

REAL

24

DOUBLE

53

DECFLOAT(7)

7

DECFLOAT(16)

16

DECFLOAT(34)

34

TIME

0

TIMESTAMP

Defined precision (0-12)

Other data types

0

RETURNED_CARDINALITY

The current cardinality for an array data type returned by FETCH or CALL. The value is 0 when the data type of the item is not an array.

RETURNED_LENGTH

The returned length in characters for character string, graphic string, and XML data types. The returned length in bytes for binary string data types.

RETURNED_OCTET_LENGTH

The returned length in bytes for all string data types.

SCALE

Returns the defined scale if the data type is DECIMAL or NUMERIC. The scale is 0 for all other data types.

TYPE

Returns a data type code representing the data type of the item. For a description of the data type codes and lengths, see [Table 92 on page 1322](#).

UNNAMED

A value of 1 indicates that the NAME value is generated by the database manager. Otherwise, the value is zero and NAME is the derived name of the column in the select list.

USER_DEFINED_TYPE_CATALOG

The server name of the user-defined type. If the type is not a user-defined data type, this item contains the empty string.

USER_DEFINED_TYPE_CODE

Indicates whether the type of the descriptor item is a user-defined type.

0

The descriptor item is not a user-defined type.

1

The descriptor item is a strongly typed user-defined type.

101

The descriptor item is a weakly typed user-defined type.

USER_DEFINED_TYPE_NAME

The name of the user-defined data type. If the type is not a user-defined data type, this item contains the empty string. The name is returned as case sensitive and without delimiters.

USER_DEFINED_TYPE_SCHEMA

The schema name of the user-defined data type. If the type is not a user-defined data type, this item contains the empty string. The name is returned as case sensitive and without delimiters.

Notes

Data types for items: The following table shows the SQL data type for each descriptor item. When a descriptor item is assigned to a variable, the variable must be compatible with the data type of the descriptor item.

<i>Table 91. Data Types for GET DESCRIPTOR Items</i>	
Item Name	Data Type
Header Information	
COUNT	INTEGER
DB2_CURSOR_HOLDABILITY	INTEGER
DB2_CURSOR_RETURNABILITY	INTEGER
DB2_CURSOR_SCROLLABILITY	INTEGER
DB2_CURSOR_SENSITIVITY	INTEGER
DB2_CURSOR_UPDATABILITY	INTEGER
DB2_MAX_ITEMS	INTEGER
DB2_RESULT_SETS_COUNT	INTEGER
DYNAMIC_FUNCTION	VARCHAR(128)
DYNAMIC_FUNCTION_CODE	INTEGER
KEY_TYPE	INTEGER
Item Information	
CARDINALITY	BIGINT
DATA	Matches the data type specified by TYPE
DATETIME_INTERVAL_CODE	INTEGER
DB2_BASE_CATALOG_NAME	VARCHAR(128)
DB2_BASE_COLUMN_NAME	VARCHAR(128)
DB2_BASE_SCHEMA_NAME	VARCHAR(128)
DB2_BASE_TABLE_NAME	VARCHAR(128)
DB2_CCSID	INTEGER
DB2_COLUMN_CATALOG_NAME	VARCHAR(128)
DB2_COLUMN_GENERATED	INTEGER
DB2_COLUMN_GENERATION_TYPE	INTEGER
DB2_COLUMN_HIDDEN	INTEGER
DB2_COLUMN_NAME	VARCHAR(128)
DB2_COLUMN_ROW_CHANGE	INTEGER
DB2_COLUMN_SCHEMA_NAME	VARCHAR(128)
DB2_COLUMN_TABLE_NAME	VARCHAR(128)
DB2_COLUMN_UPDATABILITY	INTEGER

Table 91. Data Types for GET DESCRIPTOR Items (continued)

Item Name	Data Type
DB2_CORRELATION_NAME	VARCHAR(128)
DB2_CURSOR_NAME	VARCHAR(128)
DB2_LABEL	VARCHAR(60)
DB2_PARAMETER_NAME	VARCHAR(128)
DB2_RESULT_SET_LOCATOR	Result Set Locator
DB2_RESULT_SET_ROWS	BIGINT
DB2_SYSTEM_COLUMN_NAME	CHAR(10)
INDICATOR	INTEGER
KEY_MEMBER	INTEGER
LENGTH	INTEGER
LEVEL	INTEGER
NAME	VARCHAR(128)
NULLABLE	INTEGER
OCTET_LENGTH	INTEGER
PARAMETER_MODE	INTEGER
PARAMETER_ORDINAL_POSITION	INTEGER
PARAMETER_SPECIFIC_CATALOG	VARCHAR(128)
PARAMETER_SPECIFIC_NAME	VARCHAR(128)
PARAMETER_SPECIFIC_SCHEMA	VARCHAR(128)
PRECISION	INTEGER
RETURNED_CARDINALITY	INTEGER
RETURNED_LENGTH	INTEGER
RETURNED_OCTET_LENGTH	INTEGER
SCALE	INTEGER
TYPE	INTEGER
UNNAMED	INTEGER
USER_DEFINED_TYPE_CATALOG	VARCHAR(128)
USER_DEFINED_TYPE_NAME	VARCHAR(128)
USER_DEFINED_TYPE_SCHEMA	VARCHAR(128)
USER_DEFINED_TYPE_CODE	VARCHAR(128)

SQL data type codes and lengths: The following table represents the possible values for TYPE, LENGTH, OCTET_LENGTH, and DATETIME_INTERVAL_CODE descriptor items.

The values in the following table are assigned by the ISO and ANSI SQL Standard and may change as the standard evolves. Include *sqlscds* in the include source files in library QSYSINC should be used when referencing these values.

Table 92. SQL Data Type Codes and Lengths

Data Type	Data Type Code	Length	Octet Length
SMALLINT	5	2	2
INTEGER	4	4	4
BIGINT	25	8	8
DECIMAL	3	(precision/2)+1	(precision/2)+1
NUMERIC(n)	2	n	n
REAL	7	4	4
FLOAT	6	8	8
DOUBLE PRECISION	8	8	8
DECFLOAT(7)	-360	4	4
DECFLOAT(16)	-360	8	8
DECFLOAT(34)	-360	16	16
CHARACTER(n)	1	n	n
VARCHAR(n)	12	<=n	n
CLOB(n)	40	<=n	n
GRAPHIC(n)	-95	n	2*n
VARGRAPHIC(n)	-96	<=n	2*n
DBCLOB(n)	-350	<=n	2*n
BINARY(n)	-2	n	n
VARBINARY(n)	-3	<=n	n
BLOB(n)	30	n	n
DATE (DATETIME_INTERVAL_CODE = 1)	9	Length depends on date format	Based on CCSID
TIME (DATETIME_INTERVAL_CODE = 2)	9	Length depends on time format	Based on CCSID
TIMESTAMP (DATETIME_INTERVAL_CODE = 3)	9	19-32, depending on precision	19-32 or 38-64, depending on precision (based on CCSID)
DATALINK(n)	70	<=n	n
ROWID	-904	40	40
XML	137	0	0
C nul terminated CHARACTER(n)	1	<=n	n
C nul terminated GRAPHIC(n)	-400	<=n	2*n
BLOB File Reference Variable	-916	267	267
CLOB File Reference Variable	-920	267	267
DBCLOB File Reference Variable	-924	267	267

Table 92. SQL Data Type Codes and Lengths (continued)

Data Type	Data Type Code	Length	Octet Length
Result Set Locator	-972	8	8
Array	50	N/A	N/A

Example

Example 1: Retrieve from the descriptor 'NEWDA' the number of descriptor items.

```
EXEC SQL GET DESCRIPTOR 'NEWDA'  
:numitems = COUNT;
```

Example 2: Retrieve from the first item descriptor of descriptor 'NEWDA' the data type and the octet length.

```
GET DESCRIPTOR 'NEWDA'  
VALUE 1 :dtype = TYPE,  
:olength = OCTET_LENGTH;
```

GET DIAGNOSTICS

The GET DIAGNOSTICS statement obtains information about the previous SQL statement that was executed.

Invocation

This statement can only be embedded in an application program, SQL function, SQL procedure, or trigger. It cannot be issued interactively. It is an executable statement that cannot be dynamically prepared. It must not be specified in REXX.

Authorization

None required.

Syntax

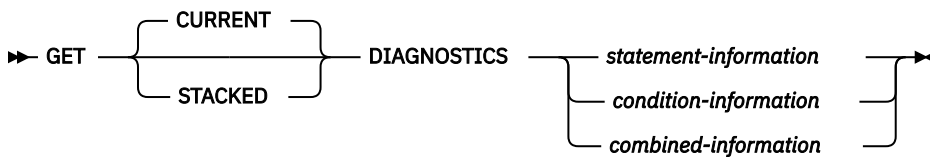

statement-information



condition-information

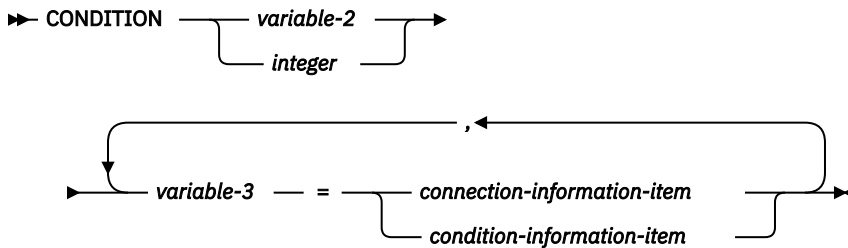

combined-information

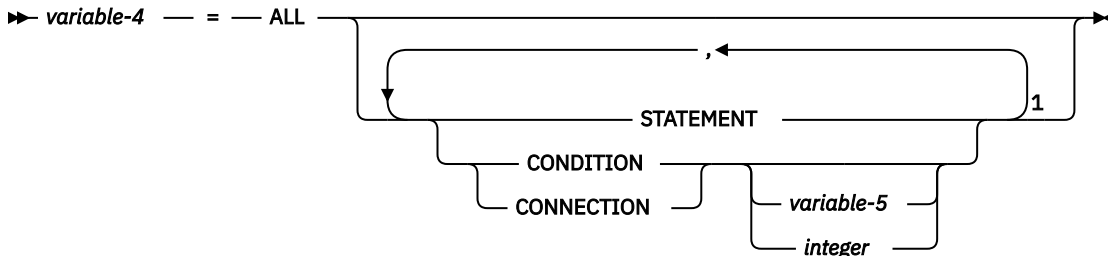

Notes:

- ¹ STATEMENT can only be specified once. If *variable-5* or *integer* is not specified, CONDITION and CONNECTION can only be specified once.

statement-information-item

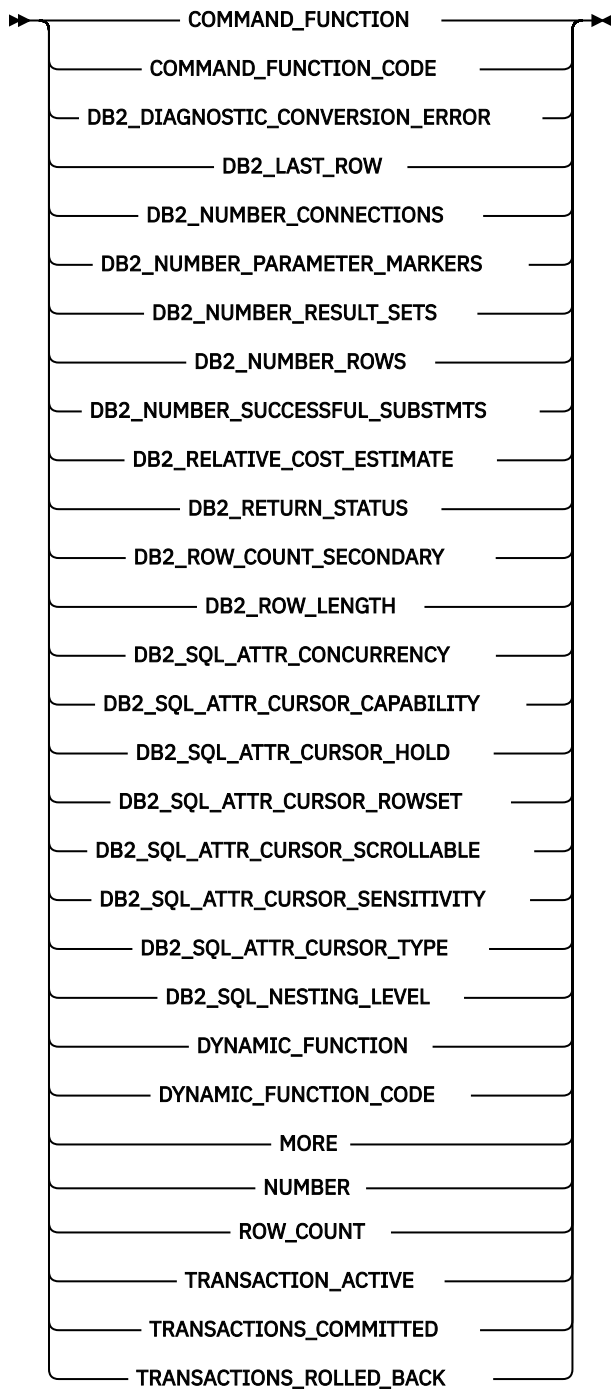

connection-information-item

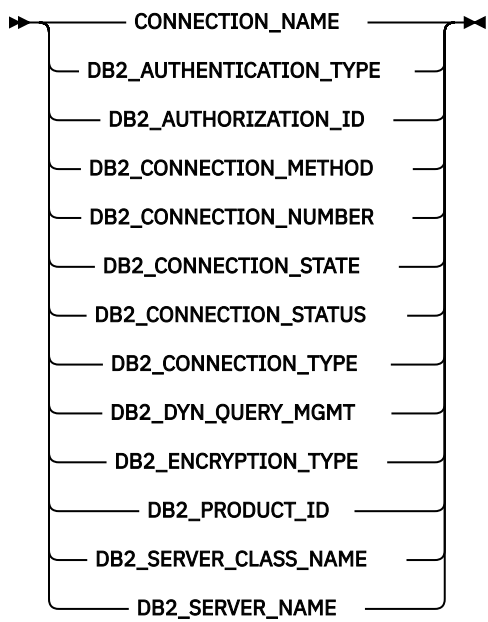

condition-information-item

CATALOG_NAME
CLASS_ORIGIN
COLUMN_NAME
CONDITION_IDENTIFIER
CONDITION_NUMBER
CONSTRAINT_CATALOG
CONSTRAINT_NAME
CONSTRAINT_SCHEMA
CURSOR_NAME
DB2_ERROR_CODE1
DB2_ERROR_CODE2
DB2_ERROR_CODE3
DB2_ERROR_CODE4
DB2_INTERNAL_ERROR_POINTER
DB2_LINE_NUMBER
DB2_MESSAGE_ID
DB2_MESSAGE_ID1
DB2_MESSAGE_ID2
DB2_MESSAGE_KEY
DB2_MODULE_DETECTING_ERROR
DB2_NUMBER_FAILING_STATEMENTS
DB2_OFFSET
DB2_ORDINAL_TOKEN_n
DB2_PARTITION_NUMBER
DB2_REASON_CODE
DB2_RETURNED_SQLCODE
DB2_ROW_NUMBER
DB2_SQLERRD_SET
DB2_SQLERRD1
DB2_SQLERRD2
DB2_SQLERRD3
DB2_SQLERRD4
DB2_SQLERRD5
DB2_SQLERRD6
DB2_TOKEN_COUNT
DB2_TOKEN_STRING
MESSAGE_LENGTH
MESSAGE_OCTET_LENGTH
MESSAGE_TEXT
PARAMETER_MODE
PARAMETER_NAME
PARAMETER_ORDINAL_POSITION
RETURNED_SQLSTATE
ROUTINE_CATALOG
ROUTINE_NAME
ROUTINE_SCHEMA
SCHEMA_NAME
SERVER_NAME
SPECIFIC_NAME
SUBCLASS_ORIGIN
TABLE_NAME
TRIGGER_CATALOG
TRIGGER_NAME
TRIGGER_SCHEMA

Description

CURRENT or STACKED

Specifies which diagnostics area to access.

CURRENT

Specifies to access the first diagnostics area. It corresponds to the previous SQL statement that was executed and that was not a GET DIAGNOSTICS statement. This is the default.

STACKED

Specifies to access the second diagnostics area. The second diagnostics area is only available within a handler. It corresponds to the previous SQL statement that was executed before the handler was entered and that was not a GET DIAGNOSTICS statement. If the GET DIAGNOSTICS statement is the first statement within a handler, then the first diagnostics area and the second diagnostics area contain the same diagnostics information.

statement-information

Returns information about the last SQL statement executed.

variable-1

Identifies a variable declared in the program in accordance with the rules for declaring variables. It must not be a global variable. The data type of the variable must be compatible with the data type as specified in Table 93 on page 1341 for the specified condition information item. The variable is assigned the value of the specified statement information item according to the retrieval assignment rules described in “Retrieval assignment” on page 95. If the value is truncated when assigning it to the variable, a warning (SQLSTATE 01004) is returned and the GET_DIAGNOSTICS_DIAGNOSTICS item of the diagnostics area is updated with the details of this condition.

If a specified diagnostic item does not contain diagnostic information, then the variable is set to a default value based on its data type:

- 0 for an exact numeric diagnostic item,
- an empty string for a VARCHAR diagnostic item,
- and blanks for a CHAR diagnostic item.

condition-information

Returns information about the condition or conditions that occurred when the last SQL statement was executed.

CONDITION *variable-2 or integer*

Identifies the diagnostic for which information is requested. Each diagnostic that occurs while executing an SQL statement is assigned an integer. The value 1 indicates the first diagnostic, 2 indicates the second diagnostic and so on. If the value is 1, then the diagnostic information retrieved corresponds to the condition indicated by the SQLSTATE value actually returned by the execution of the previous SQL statement (other than a GET DIAGNOSTICS statement). The variable specified must be declared in the program in accordance with the rules for declaring exact numeric variables with zero scale. It must not be a global variable. The value specified must not be less than one or greater than the number of available diagnostics.

variable-3

Identifies a variable declared in the program in accordance with the rules for declaring variables. It must not be a global variable. The data type of the variable must be compatible with the data type as specified in Table 93 on page 1341 for the specified condition information item. The variable is assigned the value of the specified condition information item according to the retrieval assignment rules described in “Retrieval assignment” on page 95. If the value is truncated when assigning it to the variable, an error is returned and the GET_DIAGNOSTICS_DIAGNOSTICS item of the diagnostics area is updated with the details of this condition.

If a specified diagnostic item does not contain diagnostic information, then the variable is set to a default value based on its data type:

- 0 for an exact numeric diagnostic item,
- an empty string for a VARCHAR diagnostic item,
- and blanks for a CHAR diagnostic item.

combined-information

Returns multiple information items combined into one string.

variable-4

Identifies a variable declared in the program in accordance with the rules for declaring variables. It must not be a global variable. The data type of the variable must be VARCHAR. The variable is assigned according to the retrieval assignment rules described in [“Retrieval assignment” on page 95](#). If the length of *variable-4* is not sufficient to hold the full returned diagnostic string, the string is truncated, an error is returned and the GET_DIAGNOSTICS_DIAGNOSTICS item of the diagnostics area is updated with the details of this condition.

ALL

Indicates that all diagnostic items that are set for the last SQL statement executed should be combined into one string. The format of the string is a semicolon separated list of all of the available diagnostic information in the form:

```
item-name=character-form-of-the-item-value;
```

The character form of a positive numeric value will not contain a leading plus sign (+) unless the item is DB2_RETURNED_SQLCODE. In this case, a leading plus sign (+) is added. For example:

```
NUMBER=1;RETURNED_SQLSTATE=02000;DB2_RETURNED_SQLCODE=+100;
```

Only items that contain diagnostic information are included in the string. There are also no entries in this string for the DB2_GET_DIAGNOSTICS_DIAGNOSTICS and DB2_SQL_NESTING_LEVEL items.

STATEMENT

Indicates that all *statement-information-item* diagnostic items that contain diagnostic information for the last SQL statement executed should be combined into one string. The format is the same as described above for ALL.

CONDITION

Indicates that *condition-information-item* diagnostic items that contain diagnostic information for the last SQL statement executed should be combined into one string. If *variable-5* or *integer* is specified, then the format is the same as described above for the ALL option. If *variable-5* or *integer* is not specified, then the format includes a condition number entry at the beginning of the information for that condition in the form:

```
CONDITION_NUMBER=X;item-name=character-form-of-the-item-value;
```

where X is the number of the condition. For example:

```
CONDITION_NUMBER=1;RETURNED_SQLSTATE=02000;DB2_RETURNED_SQLCODE=+100;  
CONDITION_NUMBER=2;RETURNED_SQLSTATE=01004;
```

CONNECTION

Indicates that *connection-information-item* diagnostic items that contain diagnostic information for the last SQL statement executed should be combined into one string. If *variable-5* or *integer* is specified, then the format is the same as described above for ALL. If *variable-5* or *integer* is not specified, then the format includes a connection number entry at the beginning of the information for that condition in the form:

```
DB2_CONNECTION_NUMBER=X;item-name=character-form-of-the-item-value;
```

where X is the number of the condition. For example:

```
DB2_CONNECTION_NUMBER=1;CONNECTION_NAME=SVL1;DB2_PRODUCT_ID=DSN07010;
```

variable-5 or integer

Identifies the diagnostic for which ALL CONDITION or ALL CONNECTION information is requested. The variable specified must be declared in the program in accordance with the rules for declaring integer variables. It must not be a global variable. The value specified must not be less than one or greater than the number of available diagnostics.

statement-information-item**COMMAND_FUNCTION**

Returns the name of the previous SQL statement. For information about the statement string values, see [Table 94 on page 1344](#).

COMMAND_FUNCTION_CODE

Returns an integer that identifies the previous SQL statement. For information about the statement code values, see [Table 94 on page 1344](#).

DB2_DIAGNOSTIC_CONVERSION_ERROR

Returns the value 1 if there was a conversion error when converting a character data value for one of the GET DIAGNOSTICS statement values. Otherwise, the value zero is returned.

DB2_GET_DIAGNOSTICS_DIAGNOSTICS

After a GET DIAGNOSTICS statement, if any errors or warnings occurred during the execution of the GET DIAGNOSTICS statement, DB2_GET_DIAGNOSTICS_DIAGNOSTICS returns textual information about these errors or warnings. The format of the information is similar to what would be returned by a GET DIAGNOSTICS :hv = ALL statement.

If a request was made for an information item that the server does not understand, for example, if the server was at a lower DRDA level than the requesting client, DB2_GET_DIAGNOSTICS_DIAGNOSTICS returns the text 'Item not supported:' followed by a comma separated list of item names that were requested but that the server does not support.

DB2_LAST_ROW

For a *multiple-row-fetch* statement, a value of +100 might be returned if the set of rows that have been fetched contains the last row currently in the result table for cursors that are fetching forward, or contains the first row currently in the result table, for cursors that are fetching backward. If the number of rows returned is equal to the number of rows requested, then an end of data warning may not occur and DB2_LAST_ROW may not contain +100.

If a value of +100 for DB2_LAST_ROW is returned for a cursor that is not sensitive to updates, a subsequent FETCH would return with the SQLCODE set to +100 and SQLSTATE set to '02000'. For a cursor that is sensitive to updates, a subsequent FETCH might return more data if any rows have been inserted before the FETCH was executed.

For statements other than *multiple-row-fetch* statements, for *multiple-row-fetch* statements that do not contain the last row currently in the result table, for cursors that are fetching forwards, or that do not contain the first row currently in the result table, for cursors that are fetching backwards, or if the server only returns an SQLCA, the value zero is returned.

DB2_NUMBER_CONNECTIONS

Returns the number of connections that were made in order to get to the server that fulfilled the request from the client. Each such connection may generate a connection information item area which would be available for the single condition.

DB2_NUMBER_PARAMETER_MARKERS

For a PREPARE statement, returns the number of parameter markers in the prepared statement. Otherwise, the value zero is returned.

DB2_NUMBER_RESULT_SETS

For a CALL statement, returns the actual number of result sets returned by the procedure. Otherwise, the value zero is returned.

DB2_NUMBER_ROWS

If the previous SQL statement was an OPEN or a FETCH which caused the size of the result table to be known, returns the number of rows in the result table. For SENSITIVE cursors, this value can be

thought of as an approximation since rows inserted and deleted will affect the next retrieval of this value. Otherwise, the value zero is returned.

DB2_NUMBER_SUCCESSFUL_STMTS

For embedded compound SQL statements, returns a count of the number of successful sub-statements. Otherwise, the value zero is returned.

DB2_RELATIVE_COST_ESTIMATE

For a PREPARE statement, returns a relative cost estimate of the resources required for every execution. It does not reflect an estimate of the time required. When preparing a dynamically defined statement, this value can be used as an indicator of the relative cost of the prepared statement. The value varies depending on changes to statistics and can vary between releases of the product. It is an estimated cost for the access plan chosen by the optimizer. The value zero is returned if the statement is not a PREPARE statement.

DB2_RETURN_STATUS

Identifies the status value returned from the previous SQL CALL statement. If the previous statement is not a CALL statement, the value returned has no meaning and is unpredictable. For more information, see [“RETURN statement” on page 1626](#). Otherwise, the value zero is returned.

For external procedures, if the returned SQLCODE < 0, the SQL_ERROR_CODE1 and DB2_RETURN_STATUS will be set to -1, otherwise SQL_ERROR_CODE1 and DB2_RETURN_STATUS are set to 0.

DB2_ROW_COUNT_SECONDARY

Identifies the number of rows associated with secondary actions from the previous SQL statement that was executed. If the previous SQL statement is a DELETE or MERGE, the value is the total number of rows affected by referential constraints, including cascaded actions and the processing of triggered SQL statements from activated triggers. If the previous SQL statement is an INSERT or an UPDATE, the value is the total number of rows affected as the result of the processing of triggered SQL statements from activated triggers. Otherwise, the value zero is returned.

If the SQL statement is run using isolation level No Commit, this value may be zero.

DB2_ROW_LENGTH

For FETCH, if the result row does not contain a LOB, returns the length of the row(s) retrieved. For OPEN, if the result row does not contain a LOB, returns the length of a result row. For FETCH and OPEN, if the result does contain a LOB, the length returned is unpredictable. Otherwise, the value zero is returned.

DB2_SQL_ATTR_CONCURRENCY

For an OPEN statement, indicates the concurrency control option of read-only, locking, optimistic using timestamps, or optimistic using values.

- R indicates read-only.
- L indicates locking.
- T indicates comparing row versions using timestamps or ROWIDs.
- V indicates comparing values.

Otherwise, a blank is returned.

DB2_SQL_ATTR_CURSOR_CAPABILITY

For an OPEN statement, indicates the capability of the cursor, whether a cursor is read-only, deletable, or updatable.

- R indicates that this cursor can only be used to read.
- D indicates that this cursor can be used to read as well as delete.
- U indicates that this cursor can be used to read, delete as well as update.

Otherwise, a blank is returned.

DB2_SQL_ATTR_CURSOR_HOLD

For an OPEN statement, indicates whether a cursor can be held open across multiple units of work or not.

- N indicates that this cursor will not remain open across multiple units of work.
- Y indicates that this cursor will remain open across multiple units of work.

Otherwise, a blank is returned.

DB2_SQL_ATTR_CURSOR_ROWSET

For an OPEN statement, whether a cursor can be accessed using rowset positioning or not.

- N indicates that this cursor only supports row positioned operations.
- Y indicates that this cursor supports rowset positioned operations.

Otherwise, a blank is returned.

DB2_SQL_ATTR_CURSOR_SCROLLABLE

For an OPEN statement, indicates whether a cursor can be scrolled forward and backward or not.

- N indicates that this cursor is not scrollable.
- Y indicates that this cursor is scrollable.

Otherwise, a blank is returned.

DB2_SQL_ATTR_CURSOR_SENSITIVITY

For an OPEN statement, indicates whether a cursor does or does not show updates to cursor rows made by other connections.

- I indicates insensitive.
- P indicates partial sensitivity.
- S indicates sensitive.
- U indicates unspecified.

Otherwise, a blank is returned.

DB2_SQL_ATTR_CURSOR_TYPE

For an OPEN statement, indicates whether a cursor type is dynamic, forward-only, or static.

- D indicates a dynamic cursor.
- F indicates a forward-only cursor.
- S indicates a static cursor.

Otherwise, a blank is returned.

DB2_SQL_NESTING_LEVEL

Identifies the current level of nesting or recursion in effect when the GET DIAGNOSTICS statement was executed. Each level of nesting corresponds to a nested or recursive invocation of a function, procedure, or trigger. If the GET DIAGNOSTICS statement is executed outside of a level of nesting, the value zero is returned.

If GET DIAGNOSTICS is issued in a user-defined function that is running in parallel, the nesting level is not predictable.

DYNAMIC_FUNCTION

Returns a character string that identifies the type of the SQL-statement being prepared or executed dynamically. For information about the statement string values, see [Table 94 on page 1344](#).

DYNAMIC_FUNCTION_CODE

Returns a number that identifies the type of the SQL-statement being prepared or executed dynamically. For information about the statement code values, see [Table 94 on page 1344](#).

MORE

Indicates whether more errors were raised than could be handled.

- N indicates that all the errors and warnings from the previous SQL statement were stored in the diagnostics area.
- Y indicates that more errors and warnings were raised from the previous SQL statement than there are condition areas in the diagnostics area. The maximum size of the diagnostics area is 90K.

NUMBER

Returns the number of errors and warnings detected by the execution of the previous SQL statement, other than a GET DIAGNOSTICS statement, that have been stored in the diagnostics area. If the previous SQL statement returned success (SQLSTATE 00000), or no previous SQL statement has been executed, the number returned is one. The GET DIAGNOSTICS statement itself may return information via the SQLSTATE parameter, but does not modify the previous contents of the diagnostics area, except for the DB2_GET_DIAGNOSTICS_DIAGNOSTICS item.

ROW_COUNT

Identifies the number of rows associated with the previous SQL statement that was executed. If the previous SQL statement is a DELETE, INSERT, REFRESH, or UPDATE statement, ROW_COUNT identifies the number of rows deleted, inserted, or updated by that statement, excluding rows affected by either triggers or referential integrity constraints. If the previous SQL statement is a MERGE statement, ROW_COUNT identifies the total number of rows deleted, inserted, and updated by that statement, excluding rows affected by either triggers or referential integrity constraints. If the previous SQL statement is a *multiple-row-fetch*, ROW_COUNT identifies the number of rows fetched. Otherwise, the value zero is returned.

TRANSACTION_ACTIVE

Returns the value 1 if an SQL transaction is currently active, and 0 if an SQL transaction is not currently active.

TRANSACTIONS_COMMITTED

If the previous statement was a CALL, returns the number of transactions that were committed during the execution of the SQL or external procedure. Otherwise, the value zero is returned.

TRANSACTIONS_ROLLED_BACK

If the previous statement was a CALL, returns the number of transactions that were rolled back during the execution of the SQL or external procedure. Otherwise, the value zero is returned.

connection-information-item**CONNECTION_NAME**

If the previous SQL statement is a CONNECT, DISCONNECT, or SET CONNECTION, returns the name of the server specified in the previous statement. Otherwise, the name of the current connection.

DB2_AUTHENTICATION_TYPE

Indicates the authentication type, whether server or client.

- C for client authentication.
- E for DCE security services authentication.
- S for server authentication.

Otherwise, a blank is returned.

DB2_AUTHORIZATION_ID

Returns the authorization id used by connected server. Because of userid translation and authorization exits, the local userid may not be the authid used by the server.

DB2_CONNECTION_METHOD

For a CONNECT or SET CONNECTION statement, returns the connection method.

- D indicates *DUW (Distributed Unit of Work).
- R indicates *RUW (Remote Unit of Work).

DB2_CONNECTION_NUMBER

Returns the number of the connections.

DB2_CONNECTION_STATE

Indicates the connection state, whether connected or not.

- -1 indicates the connection is unconnected.
- 1 indicates the connection is connected.

Otherwise, the value zero is returned.

DB2_CONNECTION_STATUS

Indicates whether committable update can be performed or not.

- 1 indicates committable updates can be performed on the connection for this unit of work.
- 2 indicates no committable updates can be performed on the connection for this unit of work.

Otherwise, the value zero is returned.

DB2_CONNECTION_TYPE

Indicated the connection type (either local, remote, or to a driver program) and whether the conversation is protected or not.

- 1 indicates a connection to a local relational database.
- 2 indicates a connection to a remote relational database with the conversation unprotected.
- 3 indicates a connection to a remote relational database with the conversation protected.
- 4 indicates a connection to an application requester driver program.

Otherwise, the value zero is returned.

DB2_DYN_QUERY_MGMT

Returns a value of 1 if DYN_QUERY_MGMT database configuration parameter is enabled. Otherwise, the value zero is returned.

DB2_ENCRYPTION_TYPE

Returns the level of encryption.

- A indicates only the authentication tokens (authid and password) are encrypted.
- D indicates all data is encrypted for the connection.

Otherwise, a blank is returned.

DB2_PRODUCT_ID

Returns a product signature. If the application server is an IBM relational database product, the form is pppvrrm, where:

- ppp identifies the product as follows: ARI for Db2 for VM and VSE, DSN for Db2 for z/OS, QSQ for Db2 for i, and SQL for all other Db2 products
- vv is a two-digit version identifier such as '04'
- rr is a two-digit release identifier such as '01'
- m is a one-digit modification level such as '0'

For example, if the application server is Version 7 of Db2 for z/OS, the value would be 'DSN07010'. Otherwise, the empty string is returned.

DB2_SERVER_CLASS_NAME

Returns the server class name. For example, Db2 for z/OS, Db2 for AIX, Db2 for Windows, and Db2 for i.

DB2_SERVER_NAME

For a CONNECT or SET CONNECTION statement, returns the relational database name. Otherwise, the empty string is returned.

condition-information-item**CATALOG_NAME**

If the returned SQLSTATE is:

- class 09 (Triggered Action Exception), or
- class 23 (Integrity Constraint Violation), or
- class 27 (Triggered Data Change Violation), or
- 40002 (Transaction Rollback - Integrity Constraint Violation),

and the constraint that caused the error is a referential, check, or unique constraint, the server name of the table that owns the constraint is returned.

If the returned SQLSTATE is class 42 (Syntax Error or Access Rule Violation), the server name of the table that caused the error is returned.

If the returned SQLSTATE is class 44 (WITH CHECK OPTION Violation), the server name of the view that caused the error is returned. Otherwise, the empty string is returned.

CLASS_ORIGIN

Returns 'ISO 9075' for those SQLSTATEs whose class is defined by ISO 9075. Returns 'ISO/IEC 13249' for those SQLSTATEs whose class is defined by SQL/MM. Returns 'DB2 SQL' for those SQLSTATEs whose class is defined by IBM Db2 SQL. Returns the value set by user written code if available. Otherwise, the empty string is returned.

COLUMN_NAME

If the returned SQLSTATE is class 42 (Syntax Error or Access Rule Violation) and the error was caused by an inaccessible column, the name of the column that caused the error is returned. Otherwise, the empty string is returned.

CONDITION_IDENTIFIER

If the value of the RETURNED_SQLSTATE corresponds to an unhandled user-defined exception (SQLSTATE 45000), then the condition name of the user-defined exception is returned.

CONDITION_NUMBER

Returns the number of the conditions.

CONSTRAINT_CATALOG

If the returned SQLSTATE is:

- class 23 (Integrity Constraint Violation), or
- class 27 (Triggered Data Change Violation), or
- 40002 (Transaction Rollback - Integrity Constraint Violation),

the name of the server that contains the table that contains the constraint that caused the error is returned. Otherwise, the empty string is returned.

CONSTRAINT_NAME

If the returned SQLSTATE is:

- class 23 (Integrity Constraint Violation), or
- class 27 (Triggered Data Change Violation), or
- 40002 (Transaction Rollback - Integrity Constraint Violation),

the name of the constraint that caused the error is returned. Otherwise, the empty string is returned.

CONSTRAINT_SCHEMA

If the returned SQLSTATE is:

- class 23 (Integrity Constraint Violation), or
- class 27 (Triggered Data Change Violation), or
- 40002 (Transaction Rollback - Integrity Constraint Violation),

the name of the schema of the constraint that caused the error is returned. Otherwise, the empty string is returned.

CURSOR_NAME

If the returned SQLSTATE is class 24 (Invalid Cursor State), the name of the cursor is returned. Otherwise, the empty string is returned.

DB2_ERROR_CODE1

Returns an internal error code. Otherwise, the value zero is returned.

DB2_ERROR_CODE2

Returns an internal error code. Otherwise, the value zero is returned.

DB2_ERROR_CODE3

Returns an internal error code. Otherwise, the value zero is returned.

DB2_ERROR_CODE4

Returns an internal error code. Otherwise, the value zero is returned.

DB2_INTERNAL_ERROR_POINTER

For some errors, this will be a negative value that is an internal error pointer. Otherwise, the value zero is returned.

DB2_LINE_NUMBER

For a CREATE PROCEDURE for an SQL function, SQL procedure, or SQL trigger where an error is encountered parsing the SQL procedure body, returns the line number where the error possibly occurred. Otherwise, the value zero is returned.

DB2_MESSAGE_ID

Returns the message ID corresponding to the MESSAGE_TEXT.

DB2_MESSAGE_ID1

Returns the underlying IBM i CPF escape message that originally caused this error. Otherwise, the empty string is returned.

DB2_MESSAGE_ID2

Returns the underlying IBM i CPD diagnostic message that originally caused this error. Otherwise, the empty string is returned.

DB2_MESSAGE_KEY

For a CALL statement, returns the IBM i message key of the error that caused the procedure to fail. For a trigger error in a DELETE, INSERT, or UPDATE statement, returns the message key of the error that was signaled from the trigger program. The IBM i QMHRCVPM API can be used to return the message description and message data for the message key. Otherwise, the value zero is returned.

DB2_MODULE_DETECTING_ERROR

Returns an identifier indicating which module detected the error. For a SIGNAL statement issued from a routine, the value 'ROUTINE' is returned. For other SIGNAL statements, the value 'PROGRAM' is returned.

DB2_NUMBER_FAILING_STATEMENTS

For a NOT ATOMIC embedded compound SQL statement, returns the number of statements that failed. Otherwise, the value zero is returned.

DB2_OFFSET

For a CREATE PROCEDURE for an SQL procedure where an error is encountered parsing the SQL procedure body, returns the offset into the line number where the error possibly occurred, if available. For an EXECUTE IMMEDIATE or a PREPARE statement where an error is encountered parsing the source statement, returns the offset into the source statement where the error possibly occurred. Otherwise, the value zero is returned.

DB2_ORDINAL_TOKEN_n

Returns the nth token. n must be a value from 1 to 100. For example, DB2_ORDINAL_TOKEN_1 would return the value of the first token, DB2_ORDINAL_TOKEN_2 the second token. A numeric value for a token is converted to character before being returned. If there is no value for the token, the empty string is returned.

DB2_PARTITION_NUMBER

For a partitioned database, returns the partition number of the database partition that encountered the error or warning. If no errors or warnings were encountered, returns the partition number of the current node. Otherwise, the value zero is returned.

DB2_REASON_CODE

Returns the reason code for errors that have a reason code token in the message text. Otherwise, the value zero is returned.

DB2_RETURNED_SQLCODE

Returns the SQLCODE for the specified diagnostic.

DB2_ROW_NUMBER

If the previous SQL statement is a multiple row insert or a multiple row fetch, returns the number of the row where the condition was encountered, when such a value is available and applicable. Otherwise, the value zero is returned.

DB2_SQLERRD_SET

Returns Y to indicate that the DB2_SQLERRD1 through DB2_SQLERRD6 items may be set. Otherwise, a blank is returned.

DB2_SQLERRD1

Returns the value of SQLERRD(1) from the SQLCA returned by the server.

DB2_SQLERRD2

Returns the value of SQLERRD(2) from the SQLCA returned by the server.

DB2_SQLERRD3

Returns the value of SQLERRD(3) from the SQLCA returned by the server.

DB2_SQLERRD4

Returns the value of SQLERRD(4) from the SQLCA returned by the server.

DB2_SQLERRD5

Returns the value of SQLERRD(5) from the SQLCA returned by the server.

DB2_SQLERRD6

Returns the value of SQLERRD(6) from the SQLCA returned by the server.

DB2_TOKEN_COUNT

Returns the number of tokens available for the specified diagnostic.

DB2_TOKEN_STRING

Returns a X'FF' delimited string of the tokens for the specified diagnostic.

MESSAGE_LENGTH

Identifies the length (in characters) of the message text of the error, warning, or successful completion returned from the previous SQL statement that was executed.

MESSAGE_OCTET_LENGTH

Identifies the length (in bytes) of the message text of the error, warning, or successful completion returned from the previous SQL statement that was executed.

MESSAGE_TEXT

Identifies the message text of the error, warning, or successful completion returned from the previous SQL statement that was executed.

When the SQLCODE is 0, the empty string is returned, even if the RETURNED_SQLSTATE value indicates a warning condition.

PARAMETER_MODE

If the returned SQLSTATE is:

- class 39 (External Routine Invocation Exception), or
- class 38 (External Routine Exception), or
- class 2F (SQL Routine Exception), or
- class 22 (Data Exception), or
- class 23 (Integrity Constraint Violation), or
- class 01 (Warning)

and the condition is related to the *ith* parameter of the routine, the parameter mode of the *ith* parameter is returned. Otherwise, the empty string is returned.

PARAMETER_NAME

If the returned SQLSTATE is:

- class 39 (External Routine Invocation Exception), or
- class 38 (External Routine Exception), or

- class 2F (SQL Routine Exception), or
- class 22 (Data Exception), or
- class 23 (Integrity Constraint Violation), or
- class 01 (Warning)

the condition is related to the *i*th parameter of the routine, and a parameter name was specified for the parameter when the routine was created, the parameter name of the *i*th parameter is returned. Otherwise, the empty string is returned.

PARAMETER_ORDINAL_POSITION

If the returned SQLSTATE is:

- class 39 (External Routine Invocation Exception), or
- class 38 (External Routine Exception), or
- class 2F (SQL Routine Exception), or
- class 22 (Data Exception), or
- class 23 (Integrity Constraint Violation), or
- class 01 (Warning)

and the condition is related to the *i*th parameter of the routine, the value of *i* is returned. Otherwise, the empty string is returned.

RETURNED_SQLSTATE

Returns the SQLSTATE for the specified diagnostic.

ROUTINE_CATALOG

If the returned SQLSTATE is:

- class 39 (External Routine Invocation Exception), or
- class 38 (External Routine Exception), or
- class 2F (SQL Routine Exception), or

and the condition is related to the *i*th parameter of the routine, or if the returned SQLSTATE is:

- class 22 (Data Exception), or
- class 23 (Integrity Constraint Violation), or
- class 01 (Warning)

and the condition was raised as the result of an assignment to an SQL parameter during an routine invocation, the server name of the routine is returned. Otherwise, the empty string is returned.

ROUTINE_NAME

If the returned SQLSTATE is:

- class 39 (External Routine Invocation Exception), or
- class 38 (External Routine Exception), or
- class 2F (SQL Routine Exception), or

and the condition is related to the *i*th parameter of the routine, or if the returned SQLSTATE is:

- class 22 (Data Exception), or
- class 23 (Integrity Constraint Violation), or
- class 01 (Warning)

and the condition was raised as the result of an assignment to an SQL parameter during an routine invocation, the name of the routine is returned. Otherwise, the empty string is returned.

ROUTINE_SCHEMA

If the returned SQLSTATE is:

- class 39 (External Routine Invocation Exception), or

- class 38 (External Routine Exception), or
- class 2F (SQL Routine Exception), or

and the condition is related to the *i*th parameter of the routine, or if the returned SQLSTATE is:

- class 22 (Data Exception), or
- class 23 (Integrity Constraint Violation), or
- class 01 (Warning)

and the condition was raised as the result of an assignment to an SQL parameter during an routine invocation, the schema name of the routine is returned. Otherwise, the empty string is returned.

SCHEMA_NAME

If the returned SQLSTATE is:

- class 09 (Triggered Action Exception), or
- class 23 (Integrity Constraint Violation), or
- class 27 (Triggered Data Change Violation), or
- 40002 (Transaction Rollback - Integrity Constraint Violation),

and the constraint that caused the error is a referential, check, or unique constraint, the schema name of the table that owns the constraint is returned.

If the returned SQLSTATE is class 42 (Syntax Error or Access Rule Violation), the schema name of the table that caused the error is returned.

If the returned SQLSTATE is class 44 (WITH CHECK OPTION Violation), the schema name of the view that caused the error is returned. Otherwise, the empty string is returned.

SERVER_NAME

If the previous SQL statement is a CONNECT, DISCONNECT, or SET CONNECTION, the name of the server specified in the previous statement is returned. Otherwise, the name of the server where the statement executed is returned.

SPECIFIC_NAME

If the returned SQLSTATE is:

- class 39 (External Routine Invocation Exception), or
- class 38 (External Routine Exception), or
- class 2F (SQL Routine Exception), or

and the condition is related to the *i*th parameter of the routine, or if the returned SQLSTATE is:

- class 22 (Data Exception), or
- class 23 (Integrity Constraint Violation), or
- class 01 (Warning)

and the condition was raised as the result of an assignment to an SQL parameter during an routine invocation, the specific name of the procedure or function is returned. Otherwise, the empty string is returned.

SUBCLASS_ORIGIN

Returns 'ISO 9075' for those SQLSTATEs whose subclass is defined by ISO 9075. Returns 'ISO/IEC 9579' for those SQLSTATEs whose subclass is defined by RDA. Returns 'ISO/IEC 13249-1', 'ISO/IEC 13249-2', 'ISO/IEC 13249-3', 'ISO/IEC 13249-4', or 'ISO/IEC 13249-5' for those SQLSTATEs whose subclass is defined SQL/MM. Returns 'DB2 SQL' for those SQLSTATEs whose subclass is defined by IBM Db2 SQL. Returns the value set by user written code if available. Otherwise, the empty string is returned.

TABLE_NAME

If the returned SQLSTATE is:

- class 09 (Triggered Action Exception), or

- class 23 (Integrity Constraint Violation), or
- class 27 (Triggered Data Change Violation), or
- 40002 (Transaction Rollback - Integrity Constraint Violation),

and the constraint that caused the error is a referential, check, or unique constraint, the table name that owns the constraint is returned.

If the returned SQLSTATE is class 42 (Syntax Error or Access Rule Violation), the table name that caused the error is returned.

If the returned SQLSTATE is class 44 (WITH CHECK OPTION Violation), the table name that caused the error is returned. Otherwise, the empty string is returned.

TRIGGER_CATALOG

If the returned SQLSTATE is:

- class 09 (Triggered Action Exception), or
- class 27 (Triggered Data Change Violation),

the name of the trigger is returned. Otherwise, the empty string is returned.

TRIGGER_NAME

If the returned SQLSTATE is:

- class 09 (Triggered Action Exception), or
- class 27 (Triggered Data Change Violation),

the name of the trigger is returned. Otherwise, the empty string is returned.

TRIGGER_SCHEMA

If the returned SQLSTATE is:

- class 09 (Triggered Action Exception), or
- class 27 (Triggered Data Change Violation),

the schema name of the trigger is returned. Otherwise, the empty string is returned.

Notes

Considerations for the diagnostics area: The GET DIAGNOSTICS statement does not change the contents of the diagnostics area except for DB2_GET_DIAGNOSTICS_DIAGNOSTICS.

If the GET DIAGNOSTICS statement is specified in an SQL function, SQL procedure, or trigger:

- If information is desired about an error, the GET DIAGNOSTICS statement must be the first executable statement specified in the handler that will handle the error.
- If information is wanted about a warning:
 - If a handler will get control for the warning condition, the GET DIAGNOSTICS statement must be the first statement specified in that handler.
 - If a handler will not get control for the warning condition, the GET DIAGNOSTICS statement must be the next statement executed after that previous statement.

Otherwise, GET DIAGNOSTICS statement returns information about the last executed statement.

Considerations for the SQLCODE and SQLSTATE SQL variables: The GET DIAGNOSTICS statement changes the value of the SQLSTATE and SQLCODE SQL variables.

Case of return values: Values for identifiers in returned diagnostic items are not delimited and are case sensitive. For example, a table name of "abc" would be returned, simply as abc.

Variable assignment: If an assignment error occurs, the values in the variables are unpredictable.

Data types for items: The following table shows, the SQL data type for each diagnostic item. When a diagnostic item is assigned to a variable, the variable must be compatible with the data type of the diagnostic item.

Table 93. Data Types for GET DIAGNOSTICS Items

Item Name	Data Type
Statement Information Item	
COMMAND_FUNCTION	VARCHAR(128)
COMMAND_FUNCTION_CODE	INTEGER
DB2_DIAGNOSTIC_CONVERSION_ERROR	INTEGER
DB2_GET_DIAGNOSTICS_DIAGNOSTICS	VARCHAR(32740)
DB2_LAST_ROW	INTEGER
DB2_NUMBER_CONNECTIONS	INTEGER
DB2_NUMBER_PARAMETER_MARKERS	INTEGER
DB2_NUMBER_RESULT_SETS	INTEGER
DB2_NUMBER_ROWS	DECIMAL(31,0)
DB2_NUMBER_SUCCESSFUL_STMTS	INTEGER
DB2_RELATIVE_COST_ESTIMATE	INTEGER
DB2_RETURN_STATUS	INTEGER
DB2_ROW_COUNT_SECONDARY	DECIMAL(31,0)
DB2_ROW_LENGTH	INTEGER
DB2_SQL_ATTR_CONCURRENCY	CHAR(1)
DB2_SQL_ATTR_CURSOR_CAPABILITY	CHAR(1)
DB2_SQL_ATTR_CURSOR_HOLD	CHAR(1)
DB2_SQL_ATTR_CURSOR_ROWSET	CHAR(1)
DB2_SQL_ATTR_CURSOR_SCROLLABLE	CHAR(1)
DB2_SQL_ATTR_CURSOR_SENSITIVITY	CHAR(1)
DB2_SQL_ATTR_CURSOR_TYPE	CHAR(1)
DB2_SQL_NESTING_LEVEL	INTEGER
DYNAMIC_FUNCTION	VARCHAR(128)
DYNAMIC_FUNCTION_CODE	INTEGER
MORE	CHAR(1)
NUMBER	INTEGER
ROW_COUNT	DECIMAL(31,0)
TRANSACTION_ACTIVE	INTEGER
TRANSACTIONS_COMMITTED	INTEGER
TRANSACTIONS_ROLLED_BACK	INTEGER
Connection Information Item	
CONNECTION_NAME	VARCHAR(128)
DB2_AUTHENTICATION_TYPE	CHAR(1)

Table 93. Data Types for GET DIAGNOSTICS Items (continued)

Item Name	Data Type
DB2_AUTHORIZATION_ID	VARCHAR(128)
DB2_CONNECTION_METHOD	CHAR(1)
DB2_CONNECTION_NUMBER	INTEGER
DB2_CONNECTION_STATE	INTEGER
DB2_CONNECTION_STATUS	INTEGER
DB2_CONNECTION_TYPE	SMALLINT
DB2_DYN_QUERY_MGMT	INTEGER
DB2_ENCRYPTION_TYPE	CHAR(1)
DB2_PRODUCT_ID	VARCHAR(8)
DB2_SERVER_CLASS_NAME	VARCHAR(128)
DB2_SERVER_NAME	VARCHAR(128)
Condition Information Item	
CATALOG_NAME	VARCHAR(128)
CLASS_ORIGIN	VARCHAR(128)
COLUMN_NAME	VARCHAR(128)
CONDITION_IDENTIFIER	VARCHAR(128)
CONDITION_NUMBER	INTEGER
CONSTRAINT_CATALOG	VARCHAR(128)
CONSTRAINT_NAME	VARCHAR(128)
CONSTRAINT_SCHEMA	VARCHAR(128)
CURSOR_NAME	VARCHAR(128)
DB2_ERROR_CODE1	INTEGER
DB2_ERROR_CODE2	INTEGER
DB2_ERROR_CODE3	INTEGER
DB2_ERROR_CODE4	INTEGER
DB2_INTERNAL_ERROR_POINTER	INTEGER
DB2_LINE_NUMBER	INTEGER
DB2_MESSAGE_ID	CHAR(10)
DB2_MESSAGE_ID1	VARCHAR(7)
DB2_MESSAGE_ID2	VARCHAR(7)
DB2_MESSAGE_KEY	INTEGER
DB2_MODULE_DETECTING_ERROR	VARCHAR(128)
DB2_NUMBER_FAILING_STATEMENTS	INTEGER
DB2_OFFSET	INTEGER

Table 93. Data Types for GET DIAGNOSTICS Items (continued)

Item Name	Data Type
DB2_ORDINAL_TOKEN_n	VARCHAR(32740)
DB2_PARTITION_NUMBER	INTEGER
DB2_REASON_CODE	INTEGER
DB2_RETURNED_SQLCODE	INTEGER
DB2_ROW_NUMBER	INTEGER
DB2_SQLERRD_SET	CHAR(1)
DB2_SQLERRD1	INTEGER
DB2_SQLERRD2	INTEGER
DB2_SQLERRD3	INTEGER
DB2_SQLERRD4	INTEGER
DB2_SQLERRD5	INTEGER
DB2_SQLERRD6	INTEGER
DB2_TOKEN_COUNT	INTEGER
DB2_TOKEN_STRING	VARCHAR(1000)
MESSAGE_LENGTH	INTEGER
MESSAGE_OCTET_LENGTH	INTEGER
MESSAGE_TEXT	VARCHAR(32740)
PARAMETER_MODE	VARCHAR(5)
PARAMETER_NAME	VARCHAR(128)
PARAMETER_ORDINAL_POSITION	INTEGER
RETURNED_SQLSTATE	CHAR(5)
ROUTINE_CATALOG	VARCHAR(128)
ROUTINE_NAME	VARCHAR(128)
ROUTINE_SCHEMA	VARCHAR(128)
SCHEMA_NAME	VARCHAR(128)
SERVER_NAME	VARCHAR(128)
SPECIFIC_NAME	VARCHAR(128)
SUBCLASS_ORIGIN	VARCHAR(128)
TABLE_NAME	VARCHAR(128)
TRIGGER_CATALOG	VARCHAR(128)
TRIGGER_NAME	VARCHAR(128)
TRIGGER_SCHEMA	VARCHAR(128)

SQL statement codes and strings: The following table represents the possible values for COMMAND_FUNCTION, COMMAND_FUNCTION_CODE, DYNAMIC_FUNCTION, and DYNAMIC_FUNCTION_CODE diagnostic items.

The values in the following table are assigned by the ISO and ANSI SQL Standard and may change as the standard evolves. Include *sqlscds* in the include source files in library QSYSINC should be used when referencing these values.

Type of statement	Statement string	Statement code
ALLOCATE CURSOR	ALLOCATE CURSOR	1
ALLOCATE DESCRIPTOR	ALLOCATE DESCRIPTOR	2
ALTER FUNCTION	ALTER ROUTINE	17
ALTER MASK	ALTER MASK	-100
ALTER PERMISSION	ALTER PERMISSION	-103
ALTER PROCEDURE	ALTER ROUTINE	17
ALTER SEQUENCE	ALTER SEQUENCE	134
ALTER TABLE	ALTER TABLE	4
ALTER TRIGGER	ALTER TRIGGER	-99
assignment-statement	ASSIGNMENT	5
ASSOCIATE LOCATORS	ASSOCIATE LOCATORS	-6
CALL	CALL	7
CASE	CASE	86
CLOSE (static SQL)	CLOSE CURSOR	9
CLOSE (dynamic SQL)	DYNAMIC CLOSE CURSOR	37
COMMENT	COMMENT	-7
COMMIT	COMMIT WORK	11
compound-statement	BEGIN END	12
CONNECT	CONNECT	13
CREATE ALIAS	CREATE ALIAS	-8
CREATE FUNCTION	CREATE ROUTINE	14
CREATE INDEX	CREATE INDEX	-14
CREATE MASK	CREATE MASK	-101
CREATE PERMISSION	CREATE PERMISSION	-104
CREATE PROCEDURE	CREATE ROUTINE	14
CREATE SCHEMA	CREATE SCHEMA	64
CREATE SEQUENCE	CREATE SEQUENCE	133
CREATE TABLE	CREATE TABLE	77
CREATE TRIGGER	CREATE TRIGGER	80
CREATE TYPE	CREATE TYPE	83
CREATE VARIABLE	CREATE VARIABLE	-83

Table 94. SQL Statement Codes and Strings (continued)

Type of statement	Statement string	Statement code
CREATE VIEW	CREATE VIEW	84
DEALLOCATE DESCRIPTOR	DEALLOCATE DESCRIPTOR	15
DECLARE GLOBAL TEMPORARY TABLE	DECLARE GLOBAL TEMPORARY TABLE	-21
DELETE Positioned (static SQL)	DELETE CURSOR	18
DELETE Positioned (dynamic SQL)	DYNAMIC DELETE CURSOR	38
DELETE Searched	DELETE WHERE	19
DESCRIBE	DESCRIBE	20
DESCRIBE CURSOR	DESCRIBE CURSOR RESULT SET	-72
DESCRIBE PROCEDURE	DESCRIBE PROCEDURE	-23
DESCRIBE TABLE	DESCRIBE TABLE	-24
DISCONNECT	DISCONNECT	22
DROP ALIAS	DROP ALIAS	-25
DROP FUNCTION	DROP ROUTINE	30
DROP INDEX	DROP INDEX	-30
DROP MASK	DROP MASK	-102
DROP PACKAGE	DROP PACKAGE	-32
DROP PERMISSION	DROP PERMISSION	-105
DROP PROCEDURE	DROP ROUTINE	30
DROP SCHEMA	DROP SCHEMA	31
DROP SEQUENCE	DROP SEQUENCE	135
DROP TABLE	DROP TABLE	32
DROP TRIGGER	DROP TRIGGER	34
DROP TYPE	DROP TYPE	35
DROP VARIABLE	DROP VARIABLE	-84
DROP XSROBJECT	DROP XSROBJECT	-95
DROP VIEW	DROP VIEW	36
EXECUTE	EXECUTE	44
EXECUTE IMMEDIATE	EXECUTE IMMEDIATE	43
FETCH (static SQL)	FETCH	45
FETCH (dynamic SQL)	DYNAMIC FETCH	39
FOR	FOR	46
FREE LOCATOR	FREE LOCATOR	98
GET DESCRIPTOR	GET DESCRIPTOR	47
GOTO	GOTO	-37

Table 94. SQL Statement Codes and Strings (continued)

Type of statement	Statement string	Statement code
GRANT (any type)	GRANT	48
HOLD LOCATOR	HOLD LOCATOR	99
IF	IF	88
INSERT	INSERT	50
ITERATE	ITERATE	102
LABEL	LABEL	-39
LEAVE	LEAVE	89
LOCK TABLE	LOCK TABLE	-40
LOOP	LOOP	90
MERGE	MERGE	128
OPEN (static SQL)	OPEN	53
OPEN (dynamic SQL)	DYNAMIC OPEN	40
PREPARE	PREPARE	56
Prepared DELETE Positioned (dynamic SQL)	PREPARABLE DYNAMIC DELETE CURSOR	54
Prepared UPDATE Positioned (dynamic SQL)	PREPARABLE DYNAMIC UPDATE CURSOR	55
REFRESH TABLE	REFRESH TABLE	-41
RELEASE (connection)	RELEASE CONNECTION	-42
RELEASE SAVEPOINT	RELEASE SAVEPOINT	57
RENAME INDEX	RENAME INDEX	-43
RENAME TABLE	RENAME TABLE	-44
REPEAT	REPEAT	95
RESIGNAL	RESIGNAL	91
RETURN	RETURN	58
REVOKE (any type)	REVOKE	59
ROLLBACK	ROLLBACK WORK	62
SAVEPOINT	SAVEPOINT	63
SELECT INTO	SELECT	65
<i>select-statement</i> (dynamic SQL)	SELECT CURSOR	85
SET CONNECTION	SET CONNECTION	67
SET CURRENT DEBUG MODE	SET CURRENT DEBUG MODE	-75
SET CURRENT DECFLOAT ROUNDING MODE	SET CURRENT DECFLOAT ROUNDING MODE	-82
SET CURRENT DEGREE	SET CURRENT DEGREE	-47

Table 94. SQL Statement Codes and Strings (continued)

Type of statement	Statement string	Statement code
SET CURRENT IMPLICIT XMLPARSE OPTION	SET CURRENT IMPLICIT XMLPARSE OPT	-90
SET CURRENT TEMPORAL SYSTEM_TIME	SET CURRENT TEMPORAL SYSTEM_TIME	-98
SET DESCRIPTOR	SET DESCRIPTOR	70
SET ENCRYPTION PASSWORD	SET ENCRYPTION PASSWORD	-48
SET PATH	SET PATH	69
SET RESULT SETS	SET RESULT SETS	-64
SET SCHEMA	SET SCHEMA	74
SET SESSION AUTHORIZATION	SET SESSION AUTHORIZATION	76
SET TRANSACTION	SET TRANSACTION	75
SET transition-variable	ASSIGNMENT	5
SET variable	ASSIGNMENT	5
SIGNAL	SIGNAL	92
TRANSFER OWNERSHIP	TRANSFER OWNERSHIP	-77
TRUNCATE TABLE	TRUNCATE TABLE	-74
UPDATE Positioned (static SQL)	UPDATE CURSOR	81
UPDATE Positioned (dynamic SQL)	DYNAMIC UPDATE CURSOR	42
UPDATE Searched	UPDATE WHERE	82
VALUES	STANDALONE FULLSELECT	-69
VALUES INTO	VALUES INTO	-66
WHILE	WHILE	97
Unrecognized statement	a zero length string	0

Syntax alternatives: The following keywords are synonyms supported for compatibility to prior releases. These keywords are non-standard and should not be used:

- The keyword EXCEPTION can be used as a synonym for CONDITION.
- The keyword RETURN_STATUS can be used as a synonym for DB2_RETURN_STATUS.

Example

In an SQL procedure, execute a GET DIAGNOSTICS statement to determine how many rows were updated.

```
CREATE PROCEDURE sqlproc (IN deptnbr VARCHAR(3))
LANGUAGE SQL
BEGIN
  DECLARE SQLSTATE CHAR(5);
  DECLARE rcount INTEGER;
  UPDATE CORPDATA.PROJECT
    SET PRSTAFF = PRSTAFF + 1.5
    WHERE DEPTNO = deptnbr;
  GET DIAGNOSTICS rcount = ROW_COUNT;
  /* At this point, rcount contains the number of rows that were updated. */
```

END

Within an SQL procedure, handle the returned status value from the invocation of a stored procedure called TRYIT. TRYIT could use the RETURN statement to explicitly return a status value or a status value could be implicitly returned by the database manager. If the procedure is successful, it returns a value of zero.

```
CREATE PROCEDURE TESTIT ()  
LANGUAGE SQL  
A1: BEGIN  
    DECLARE RETVAL INTEGER DEFAULT 0;  
    ...  
    CALL TRYIT  
    GET DIAGNOSTICS RETVAL = RETURN_STATUS;  
    IF RETVAL <> 0 THEN  
        ...  
        LEAVE A1;  
    ELSE  
        ...  
    END IF;  
END A1
```

In an SQL procedure, execute a GET DIAGNOSTICS statement to retrieve the message text for an error.

```
CREATE PROCEDURE divide2 ( IN numerator INTEGER,  
                          IN denominator INTEGER,  
                          OUT divide_result INTEGER,  
                          OUT divide_error VARCHAR(70) )  
LANGUAGE SQL  
BEGIN  
    DECLARE CONTINUE HANDLER FOR SQLEXCEPTION  
        GET DIAGNOSTICS CONDITION 1  
            divide_error = MESSAGE_TEXT;  
    SET divide_result = numerator / denominator;  
END;
```

GRANT (function or procedure privileges)

This form of the GRANT statement grants privileges on a function or procedure.

Invocation

This statement can be embedded in an application program or issued interactively. It is an executable statement that can be dynamically prepared.

Authorization

The privileges held by the authorization ID of the statement must include at least one of the following:

- For each function or procedure identified in the statement:
 - Every privilege specified in the statement
 - The system authority of *OBJMGT on the function or procedure
 - The USAGE privilege on the schema (or system authority *EXECUTE on the directory if this is a Java routine) containing the function or procedure
- Database administrator authority
- Security administrator authority

If WITH GRANT OPTION is specified, the privileges held by the authorization ID of the statement must include at least one of the following:

- Ownership of the function or procedure
- Database administrator authority
- Security administrator authority

Syntax

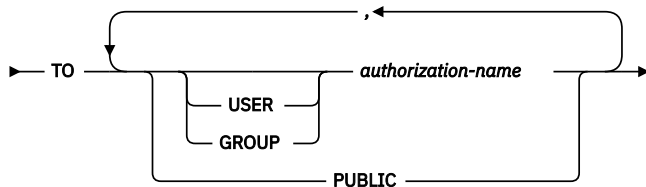
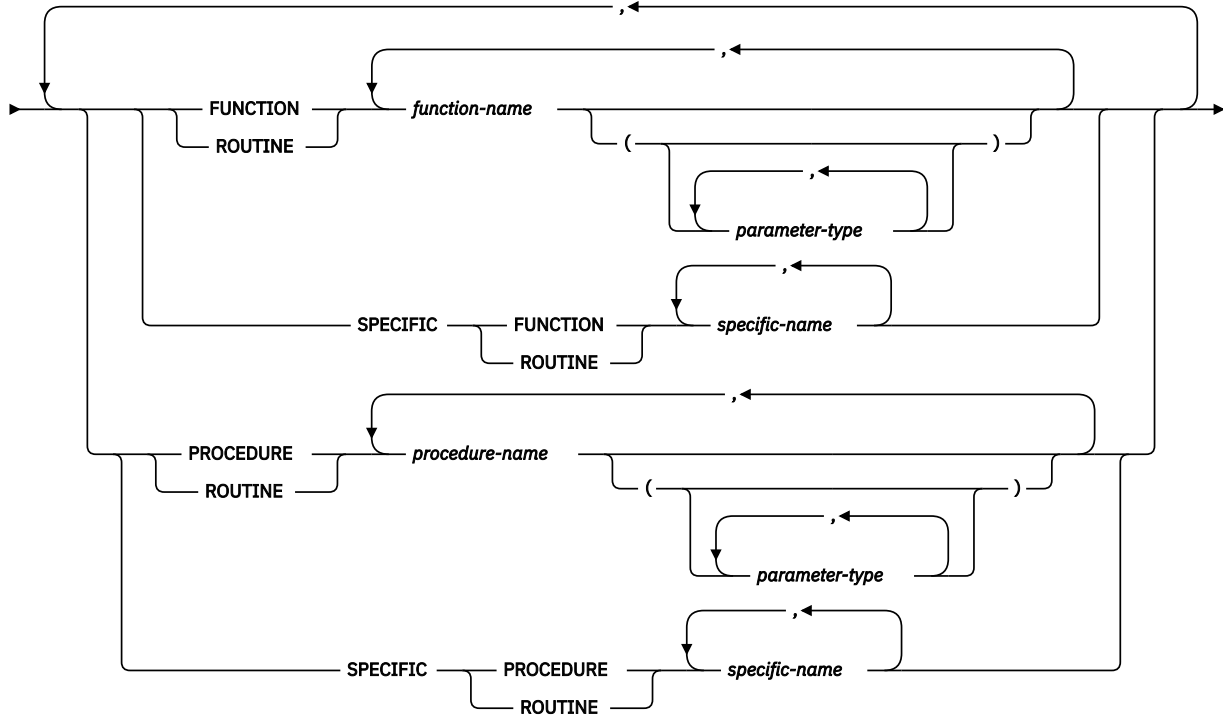
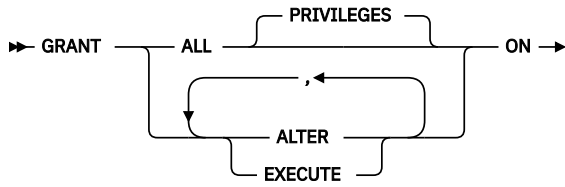

parameter-type

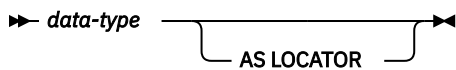

data-type

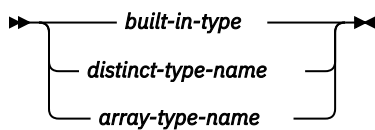

built-in-type

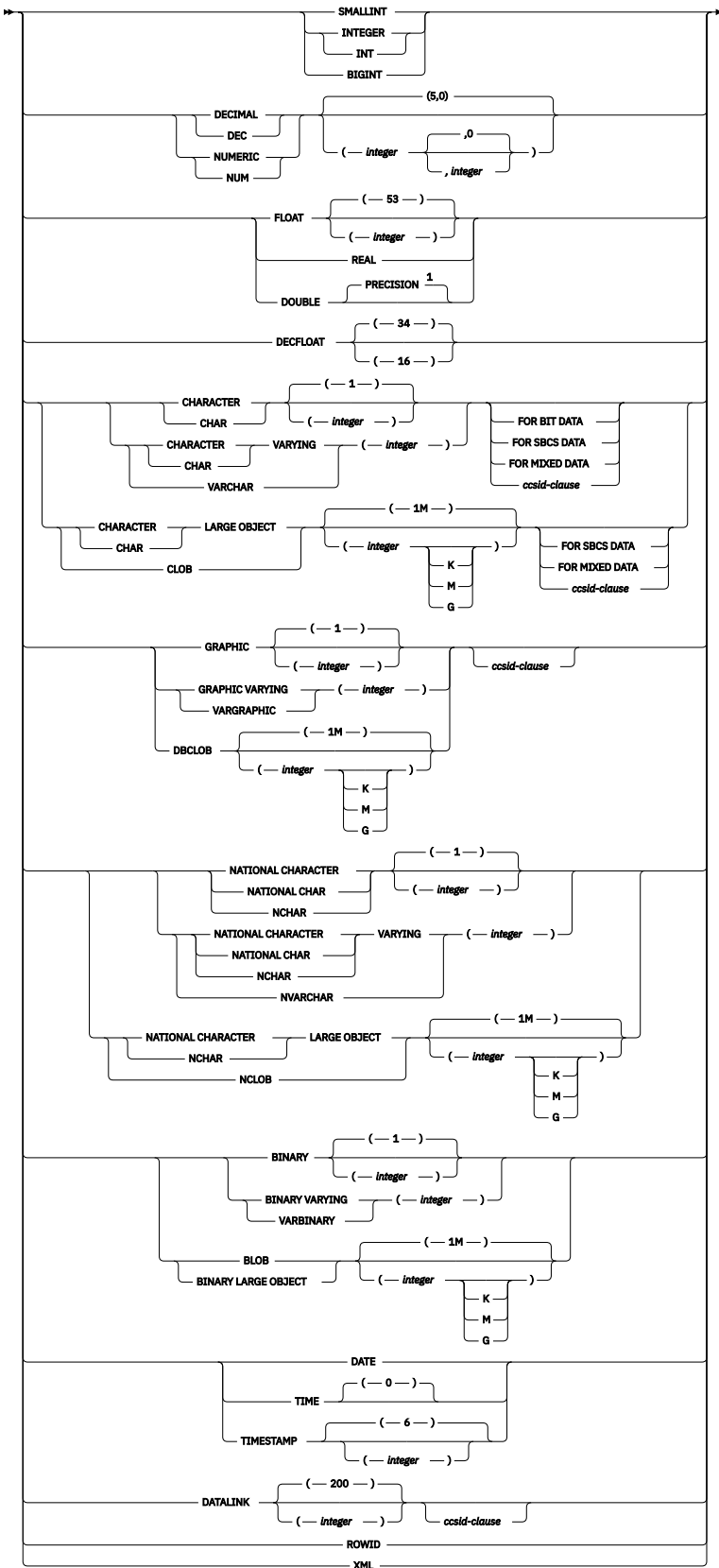

ccsid-clause

► CCSID — *integer* ◄

Notes:

¹ The value that is specified for precision does not have to match the value that was specified when the function was created because matching is based on data type (REAL or DOUBLE).

Description

ALL or ALL PRIVILEGES

Grants one or more privileges. The privileges granted are all those grantable privileges that the authorization ID of the statement has on the specified functions or procedures. Note that granting ALL PRIVILEGES on a function or procedure is not the same as granting the system authority of *ALL.

If you do not use ALL, you must use one or more of the keywords listed below. Each keyword grants the privilege described.

ALTER

Grants the privilege to use the ALTER FUNCTION, ALTER PROCEDURE, or COMMENT statement.

EXECUTE

Grants the privilege to execute the function or procedure.

FUNCTION or SPECIFIC FUNCTION

Identifies the function on which the privilege is granted. The function must exist at the current server and it must be a user-defined function, but not a function that was implicitly generated with the creation of a distinct type. The function can be identified by its name, function signature, or specific name.

FUNCTION *function-name*

Identifies the function by its name. The *function-name* must identify exactly one function. The function may have any number of parameters defined for it. If there is more than one function of the specified name in the specified or implicit schema, an error is returned.

FUNCTION *function-name (parameter-type, ...)*

Identifies the function by its function signature, which uniquely identifies the function. The *function-name (parameter-type, ...)* must identify a function with the specified function signature. The specified parameters must match the data types in the corresponding position that were specified when the function was created. The number of data types, and the logical concatenation of the data types is used to identify the specific function instance on which the privilege is to be granted. Synonyms for data types are considered a match. Parameters that have defaults must be included in this signature.

If *function-name ()* is specified, the function identified must have zero parameters.

function-name

Identifies the name of the function.

(parameter-type, ...)

Identifies the parameters of the function.

If an unqualified distinct type name is specified, the database manager searches the SQL path to resolve the schema name for the distinct type.

For data types that have a length, precision, or scale attribute, use one of the following:

- Empty parentheses indicate that the database manager ignores the attribute when determining whether the data types match. For example, DEC() will be considered a match for a parameter of a function defined with a data type of DEC(7,2). However, FLOAT cannot be specified with empty parenthesis because its parameter value indicates a specific data type (REAL or DOUBLE).
- If a specific value for a length, precision, or scale attribute is specified, the value must exactly match the value that was specified (implicitly or explicitly) in the CREATE FUNCTION statement. If the data type is FLOAT, the precision does not have to exactly match the value that was specified because matching is based on the data type (REAL or DOUBLE).
- If length, precision, or scale is not explicitly specified, and empty parentheses are not specified, the default attributes of the data type are implied. The implicit length must exactly

match the value that was specified (implicitly or explicitly) in the CREATE FUNCTION statement.

Specifying the FOR DATA clause or CCSID clause is optional. Omission of either clause indicates that the database manager ignores the attribute when determining whether the data types match. If either clause is specified, it must match the value that was implicitly or explicitly specified in the CREATE FUNCTION statement.

AS LOCATOR

Specifies that the function is defined to receive a locator for this parameter. If AS LOCATOR is specified, the data type must be a LOB or XML or a distinct type based on a LOB or XML.

SPECIFIC FUNCTION *specific-name*

Identifies the function by its specific name. The *specific-name* must identify a specific function that exists at the current server.

PROCEDURE or SPECIFIC PROCEDURE

Identifies the procedure on which the privilege is granted. The *procedure-name* must identify a procedure that exists at the current server.

PROCEDURE *procedure-name*

Identifies the procedure by its name. The *procedure-name* must identify exactly one procedure. The procedure may have any number of parameters defined for it. If there is more than one procedure of the specified name in the specified or implicit schema, an error is returned.

PROCEDURE *procedure-name (parameter-type, ...)*

Identifies the procedure by its procedure signature, which uniquely identifies the procedure. The *procedure-name (parameter-type, ...)* must identify a procedure with the specified procedure signature. The specified parameters must match the data types in the corresponding position that were specified when the procedure was created. The number of data types, and the logical concatenation of the data types is used to identify the specific procedure instance which is to be granted. Synonyms for data types are considered a match. Parameters that have defaults must be included in this signature.

If *procedure-name ()* is specified, the procedure identified must have zero parameters.

procedure-name

Identifies the name of the procedure.

(parameter-type, ...)

Identifies the parameters of the procedure.

If an unqualified distinct type or array type name is specified, the database manager searches the SQL path to resolve the schema name for the distinct type or array type.

For data types that have a length, precision, or scale attribute, use one of the following:

- Empty parentheses indicate that the database manager ignores the attribute when determining whether the data types match. For example, DEC() will be considered a match for a parameter of a procedure defined with a data type of DEC(7,2). However, FLOAT cannot be specified with empty parenthesis because its parameter value indicates a specific data type (REAL or DOUBLE).
- If a specific value for a length, precision, or scale attribute is specified, the value must exactly match the value that was specified (implicitly or explicitly) in the CREATE PROCEDURE statement. If the data type is FLOAT, the precision does not have to exactly match the value that was specified because matching is based on the data type (REAL or DOUBLE).
- If length, precision, or scale is not explicitly specified, and empty parentheses are not specified, the default attributes of the data type are implied. The implicit length must exactly match the value that was specified (implicitly or explicitly) in the CREATE PROCEDURE statement.

Specifying the FOR DATA clause or CCSID clause is optional. Omission of either clause indicates that the database manager ignores the attribute when determining whether the data

types match. If either clause is specified, it must match the value that was implicitly or explicitly specified in the CREATE PROCEDURE statement.

AS LOCATOR

Specifies that the procedure is defined to receive a locator for this parameter. If AS LOCATOR is specified, the data type must be a LOB or XML or a distinct type based on a LOB or XML.

SPECIFIC PROCEDURE *specific-name*

Identifies the procedure by its specific name. The *specific-name* must identify a specific procedure that exists at the current server.

TO

Indicates to whom the privileges are granted.

USER

Specifies that the *authorization-name* identifies a user profile. If USER is specified, *authorization-name* must be a user profile.

GROUP

Specifies that the *authorization-name* identifies a group profile. If GROUP is specified, *authorization-name* must be a group profile.

***authorization-name*,...**

Lists one or more authorization IDs.

PUBLIC

Grants the privileges to a set of users (authorization IDs). For more information, see [“Authorization, privileges and object ownership” on page 15.](#)

WITH GRANT OPTION

Allows the specified *authorization-names* to grant privileges on the functions or procedures specified in the ON clause to other users.

If WITH GRANT OPTION is omitted, the specified *authorization-names* cannot grant privileges on the functions or procedures specified in the ON clause to another user unless they have received that authority from some other source (for example, from a grant of the system authority *OBJMGT).

Notes

Corresponding System Authorities: Privileges granted to either an SQL or external function or procedure are granted to its associated program (*PGM) or service program (*SRVPGM) object. Privileges granted to a Java external function or procedure are granted to the associated class file or jar file. If the associated program, service program, class file, or jar file is not found when the grant is executed, an error is returned.

GRANT and REVOKE statements assign and remove system authorities for SQL objects. The following table describes the system authorities that correspond to the SQL privileges:

<i>Table 95. Privileges Granted to or Revoked from Non-Java Functions or Procedures</i>	
SQL Privilege	Corresponding System Authorities when Granting to or Revoking from a Function or Procedure
ALL (Grant or revoke of ALL grants or revokes only those privileges the authorization ID of the statement has)	*OBJALTER *OBJOPR *EXECUTE *OBJMGT (Revoke only)
ALTER	*OBJALTER
EXECUTE	*EXECUTE *OBJOPR

<i>Table 95. Privileges Granted to or Revoked from Non-Java Functions or Procedures (continued)</i>	
SQL Privilege	Corresponding System Authorities when Granting to or Revoking from a Function or Procedure
WITH GRANT OPTION	*OBJMGT

<i>Table 96. Privileges Granted to or Revoked from Java Functions or Procedures</i>		
SQL Privilege	Corresponding Data Authorities when Granting to or Revoking from a Java Function or Procedure	Corresponding Object Authorities when Granting to or Revoking from a Java Function or Procedure
ALL (Grant or revoke of ALL grants or revokes only those privileges the authorization ID of the statement has)	*RWX	*OBJEXIST *OBJALTER *OBJMGT (Revoke only)
ALTER	*R	*OBJALTER
EXECUTE	*RX	*EXECUTE
WITH GRANT OPTION	*RWX	*OBJMGT

Corresponding System Authorities When Checking Privileges to a Function or Procedure: The following table describes the system authorities that correspond to the SQL privileges when checking privileges to a function or procedure. The left column lists the SQL privilege. The right column lists the equivalent system authorities.

<i>Table 97. Corresponding System Authorities When Checking Privileges to a Non-Java Function or Procedure</i>	
SQL Privilege	Corresponding System Authorities
ALTER	*OBJALTER
EXECUTE	*EXECUTE and *OBJOPR

<i>Table 98. Corresponding System Authorities When Checking Privileges to a Java Function or Procedure</i>		
SQL Privilege	Corresponding Data Authorities when Checking Privileges to a Java Function or Procedure	Corresponding Object Authorities when Checking Privileges to a Java Function or Procedure
ALTER	*R	*OBJALTER
EXECUTE	*RX	*EXECUTE

Built-in functions: Privileges cannot be granted on built-in functions.

Syntax alternatives: The following keywords are synonyms supported for compatibility to prior releases. These keywords are non-standard and should not be used:

- The keyword RUN can be used as a synonym for EXECUTE.

Example

Grant the EXECUTE privilege on procedure PROCA to PUBLIC.

```
GRANT EXECUTE  
ON PROCEDURE PROCA  
TO PUBLIC
```

GRANT (package privileges)

This form of the GRANT statement grants privileges on a package.

Invocation

This statement can be embedded in an application program or issued interactively. It is an executable statement that can be dynamically prepared.

Authorization

The privileges held by the authorization ID of the statement must include at least one of the following:

- For each package identified in the statement:
 - Every privilege specified in the statement
 - The system authority of *OBJMGT on the package
 - The USAGE privilege on the schema containing the package
- Database administrator authority
- Security administrator authority

If WITH GRANT OPTION is specified, the privileges held by the authorization ID of the statement must include at least one of the following:

- Ownership of the package
- Database administrator authority
- Security administrator authority

Syntax

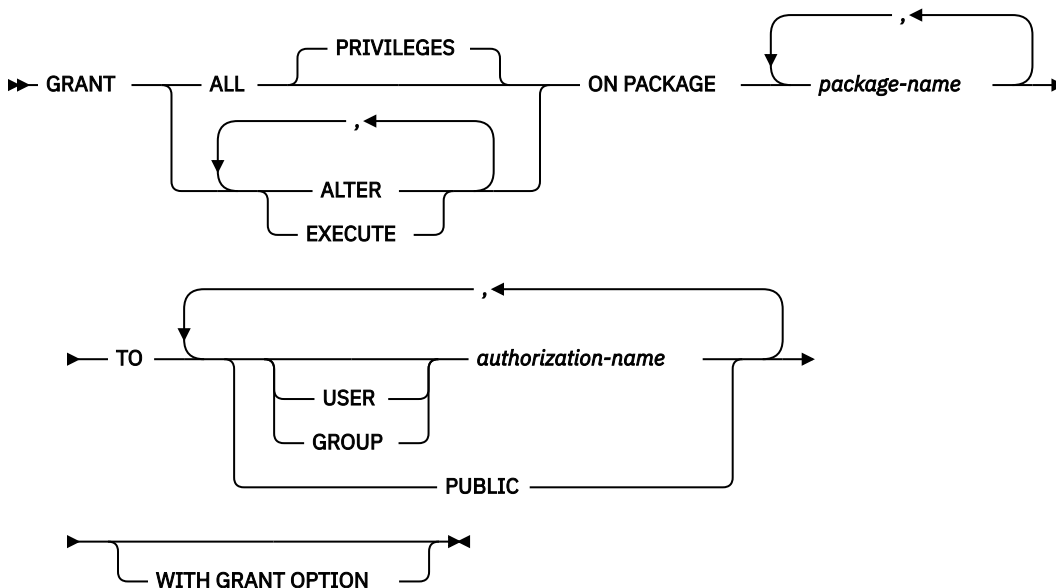

Description

ALL or ALL PRIVILEGES

Grants one or more privileges. The privileges granted are all those grantable privileges that the authorization ID of the statement has on the specified packages. Note that granting ALL PRIVILEGES on a package is not the same as granting the system authority of *ALL.

If you do not use ALL, you must use one or more of the keywords listed below. Each keyword grants the privilege described.

ALTER

Grants the privilege to use the COMMENT and LABEL statements.

EXECUTE

Grants the privilege to execute statements in a package.

ON PACKAGE *package-name*

Identifies the packages on which you are granting the privilege. The *package-name* must identify a package that exists at the current server.

TO

Indicates to whom the privileges are granted.

USER

Specifies that the *authorization-name* identifies a user profile. If USER is specified, *authorization-name* must be a user profile.

GROUP

Specifies that the *authorization-name* identifies a group profile. If GROUP is specified, *authorization-name* must be a group profile.

authorization-name,...

Lists one or more authorization IDs.

PUBLIC

Grants the privileges to a set of users (authorization IDs). For more information, see [“Authorization, privileges and object ownership” on page 15.](#)

WITH GRANT OPTION

Allows the specified *authorization-names* to grant privileges on the packages specified in the ON clause to other users.

If WITH GRANT OPTION is omitted, the specified *authorization-names* cannot grant privileges on the packages specified in the ON clause to another user unless they have received that authority from some other source (for example, from a grant of the system authority *OBJMGT).

Notes

Corresponding System Authorities: GRANT and REVOKE statements assign and remove system authorities for SQL objects. The following table describes the system authorities that correspond to the SQL privileges:

<i>Table 99. Privileges Granted to or Revoked from Packages</i>	
SQL Privilege	Corresponding System Authorities when Granting to or Revoking from a Package
ALL (Grant or revoke of ALL grants or revokes only those privileges the authorization ID of the statement has)	*OBJALTER *OBJOPR *EXECUTE *OBJMGT (Revoke only)
ALTER	*OBJALTER
EXECUTE	*EXECUTE *OBJOPR
WITH GRANT OPTION	*OBJMGT

Corresponding System Authorities When Checking Privileges to a Package: The following table describes the system authorities that correspond to the SQL privileges when checking privileges to a package. The left column lists the SQL privilege. The right column lists the equivalent system authorities.

<i>Table 100. Corresponding System Authorities When Checking Privileges to a Package</i>	
SQL Privilege	Corresponding System Authorities When Checking Privileges to a Package
ALTER	*OBJALTER
EXECUTE	*EXECUTE and *OBJOPR

Syntax alternatives: The following keywords are synonyms supported for compatibility to prior releases. These keywords are non-standard and should not be used:

- The keyword RUN can be used as a synonym for EXECUTE.
- The keyword PROGRAM can be used as a synonym for PACKAGE.

Example

Grant the EXECUTE privilege on package PKGA to PUBLIC.

```
GRANT EXECUTE
ON PACKAGE PKGA
TO PUBLIC
```

GRANT (schema privileges)

This form of the GRANT statement grants privileges on a schema.

Invocation

This statement can be embedded in an application program or issued interactively. It is an executable statement that can be dynamically prepared.

Authorization

The privileges held by the authorization ID of the statement must include at least one of the following:

- For each schema identified in the statement:
 - Every privilege specified in the statement
 - The system authority of *OBJMGT on the schema
- Database administrator authority
- Security administrator authority

Syntax

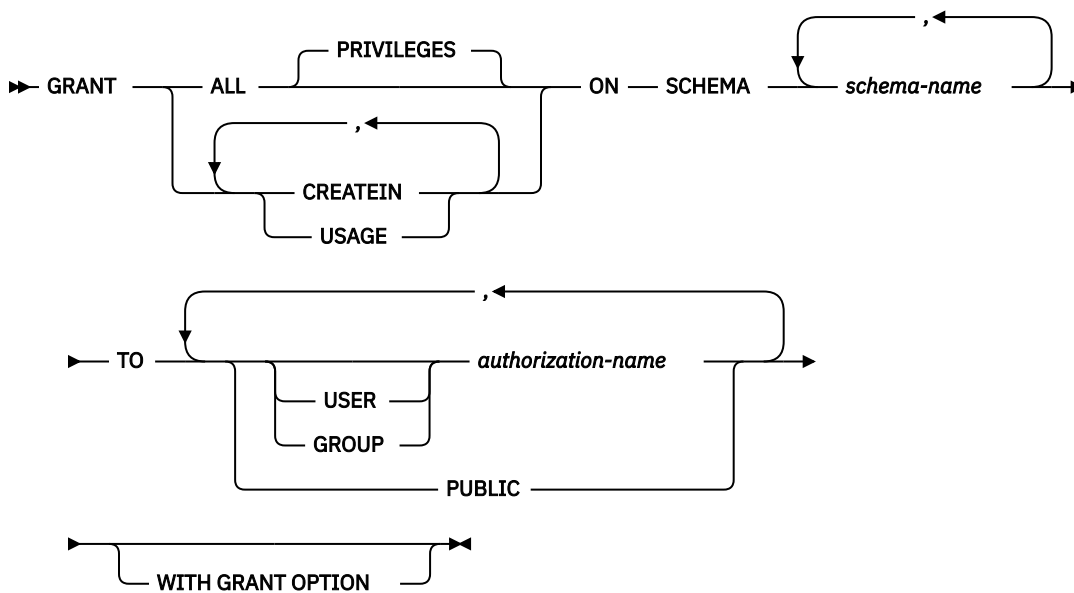

Description

ALL or ALL PRIVILEGES

Grants one or more privileges. The privileges granted are all those grantable privileges that the authorization ID of the statement has on the specified schemas. Note that granting ALL PRIVILEGES on a schema is not the same as granting the system authority of *ALL.

If you do not use ALL, you must use one or more of the keywords listed below. Each keyword grants the privilege described.

CREATEIN

Grants the privilege to create objects in the schema. Other authorities or privileges required to create the object are still required.

USAGE

Grants the privilege to use the schema. USAGE privilege is required to reference any objects that exist in the schema.

ON SCHEMA *schema-name*

Identifies the schemas on which the privilege is granted.

TO

Indicates to whom the privileges are granted.

USER

Specifies that the *authorization-name* identifies a user profile. If USER is specified, *authorization-name* must be a user profile.

GROUP

Specifies that the *authorization-name* identifies a group profile. If GROUP is specified, *authorization-name* must be a group profile.

***authorization-name*,...**

Lists one or more authorization IDs.

PUBLIC

Grants the privileges to a set of users (authorization IDs). For more information, see [“Authorization, privileges and object ownership” on page 15.](#)

WITH GRANT OPTION

Allows the specified *authorization-names* to grant privileges on the schemas specified in the ON clause to other users.

Notes

Corresponding System Authorities: GRANT and REVOKE statements assign and remove system authorities for SQL objects. The following table describes the system authorities that correspond to the SQL privileges when granting to a schema. The left column lists the SQL privilege. The right column lists the equivalent system authorities that are granted or revoked.

SQL Privilege	Corresponding System Authorities when Granting to or Revoking from a Schema
ALL (Grant or revoke of ALL grants or revokes only those privileges the authorization ID of the statement has)	*OBJMGT *OBJOPR *READ *EXECUTE *ADD
CREATEIN	*OBJOPR *READ *EXECUTE *ADD ¹⁰⁹
USAGE	*OBJOPR *READ *EXECUTE
WITH GRANT OPTION	*OBJMGT

¹⁰⁹ Only *ADD is revoked when CREATEIN is revoked.

Corresponding System Authorities When Checking Privileges to a Schema: The following table describes the system authorities that correspond to the SQL privileges when checking privileges to a schema. The left column lists the SQL privilege. The right column lists the equivalent system authorities.

<i>Table 102. Corresponding System Authorities When Checking Privileges to a Schema</i>	
SQL Privilege	Corresponding System Authorities
CREATEIN	*OBJOPR, *READ, *EXECUTE, and *ADD ¹¹⁰
USAGE	*EXECUTE ¹¹⁰

GRANT rules: The GRANT statement will grant only those privileges that the authorization ID of the statement is allowed to grant. If no privileges were granted, an error is returned.

Example

Example 1: Grant the CREATEIN privilege on schema T_SCORES to user JONES.

```
GRANT CREATEIN
  ON SCHEMA T_SCORES
  TO JONES;
```

¹¹⁰ *OBJOPR and *READ are only checked for certain statements (for example CREATES).

GRANT (sequence privileges)

This form of the GRANT statement grants privileges on a sequence.

Invocation

This statement can be embedded in an application program or issued interactively. It is an executable statement that can be dynamically prepared.

Authorization

The privileges held by the authorization ID of the statement must include at least one of the following:

- For each sequence identified in the statement:
 - Every privilege specified in the statement
 - The system authority of *OBJMGT on the sequence
 - The USAGE privilege on the schema containing the sequence
- Database administrator authority
- Security administrator authority

If WITH GRANT OPTION is specified, the privileges held by the authorization ID of the statement must include at least one of the following:

- Ownership of the sequence
- Database administrator authority
- Security administrator authority

Syntax

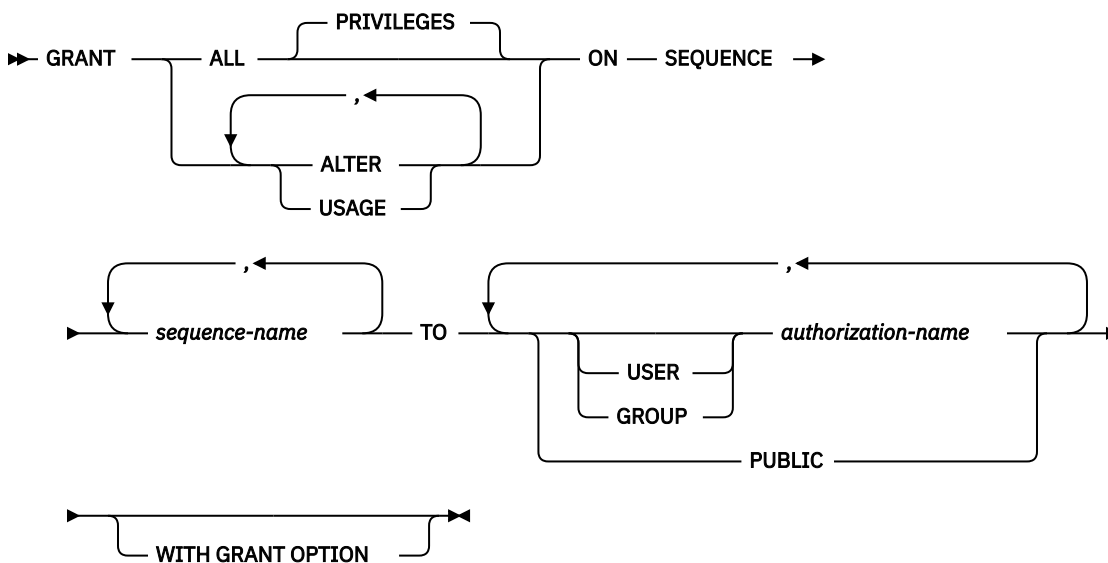

Description

ALL or ALL PRIVILEGES

Grants one or more privileges. The privileges granted are all those grantable privileges that the authorization ID of the statement has on the specified sequences. Note that granting ALL PRIVILEGES on a sequence is not the same as granting the system authority of *ALL.

If you do not use ALL, you must use one or more of the keywords listed below. Each keyword grants the privilege described.

ALTER

Grants the privilege to use the ALTER SEQUENCE, COMMENT, and LABEL statements on a sequence.

USAGE

Grants the privilege to use the sequence in NEXT VALUE or PREVIOUS VALUE expressions.

ON SEQUENCE *sequence-name*

Identifies the sequences on which the privilege is granted. The *sequence-name* must identify a sequence that exists at the current server.

TO

Indicates to whom the privileges are granted.

USER

Specifies that the *authorization-name* identifies a user profile. If USER is specified, *authorization-name* must be a user profile.

GROUP

Specifies that the *authorization-name* identifies a group profile. If GROUP is specified, *authorization-name* must be a group profile.

authorization-name,...

Lists one or more authorization IDs.

PUBLIC

Grants the privileges to a set of users (authorization IDs). For more information, see [“Authorization, privileges and object ownership” on page 15.](#)

WITH GRANT OPTION

Allows the specified *authorization-names* to grant privileges on the sequences specified in the ON clause to other users.

If WITH GRANT OPTION is omitted, the specified *authorization-names* cannot grant the USAGE privilege to others unless they have received that authority from some other source (for example, from a grant of the system authority *OBJMGT).

Notes

Corresponding System Authorities: GRANT and REVOKE statements assign and remove system authorities for SQL objects. The following table describes the system authorities that correspond to the SQL privileges:

<i>Table 103. Privileges Granted to or Revoked from Sequences</i>	
SQL Privilege	Corresponding System Authorities when Granting to or Revoking from a Sequence
ALL (Grant or revoke of ALL grants or revokes only those privileges the authorization ID of the statement has)	*OBJALTER *OBJOPR *EXECUTE *READ *ADD *DLT *UPD *OBJMGT (Revoke only)
ALTER	*OBJALTER

Table 103. Privileges Granted to or Revoked from Sequences (continued)

SQL Privilege	Corresponding System Authorities when Granting to or Revoking from a Sequence
USAGE	*OBJOPR *EXECUTE *READ *ADD *DLT *UPD
WITH GRANT OPTION	*OBJMGT

Corresponding System Authorities When Checking Privileges to a Sequence: The following table describes the system authorities that correspond to the SQL privileges when checking privileges to a sequence. The left column lists the SQL privilege. The right column lists the equivalent system authorities.

Table 104. Corresponding System Authorities When Checking Privileges to a Sequence

SQL Privilege	Corresponding System Authorities
ALTER	*OBJALTER
USAGE	*OBJOPR and *EXECUTE and *READ and *ADD and *DLT and *UPD

Example

Grant any user the USAGE privilege on a sequence called ORG_SEQ.

```
GRANT USAGE
ON SEQUENCE ORG_SEQ
TO PUBLIC
```

GRANT (table or view privileges)

This form of the GRANT statement grants privileges on tables or views.

Invocation

This statement can be embedded in an application program or issued interactively. It is an executable statement that can be dynamically prepared.

Authorization

The privileges held by the authorization ID of the statement must include at least one of the following:

- For each table or view identified in the statement:
 - Every privilege specified in the statement
 - The system authority of *OBJMGT on the table or view
 - The USAGE privilege on the schema containing the table or view
- Database administrator authority
- Security administrator authority

If WITH GRANT OPTION is specified, the privileges held by the authorization ID of the statement must include at least one of the following:

- Ownership of the table
- Database administrator authority
- Security administrator authority

Syntax

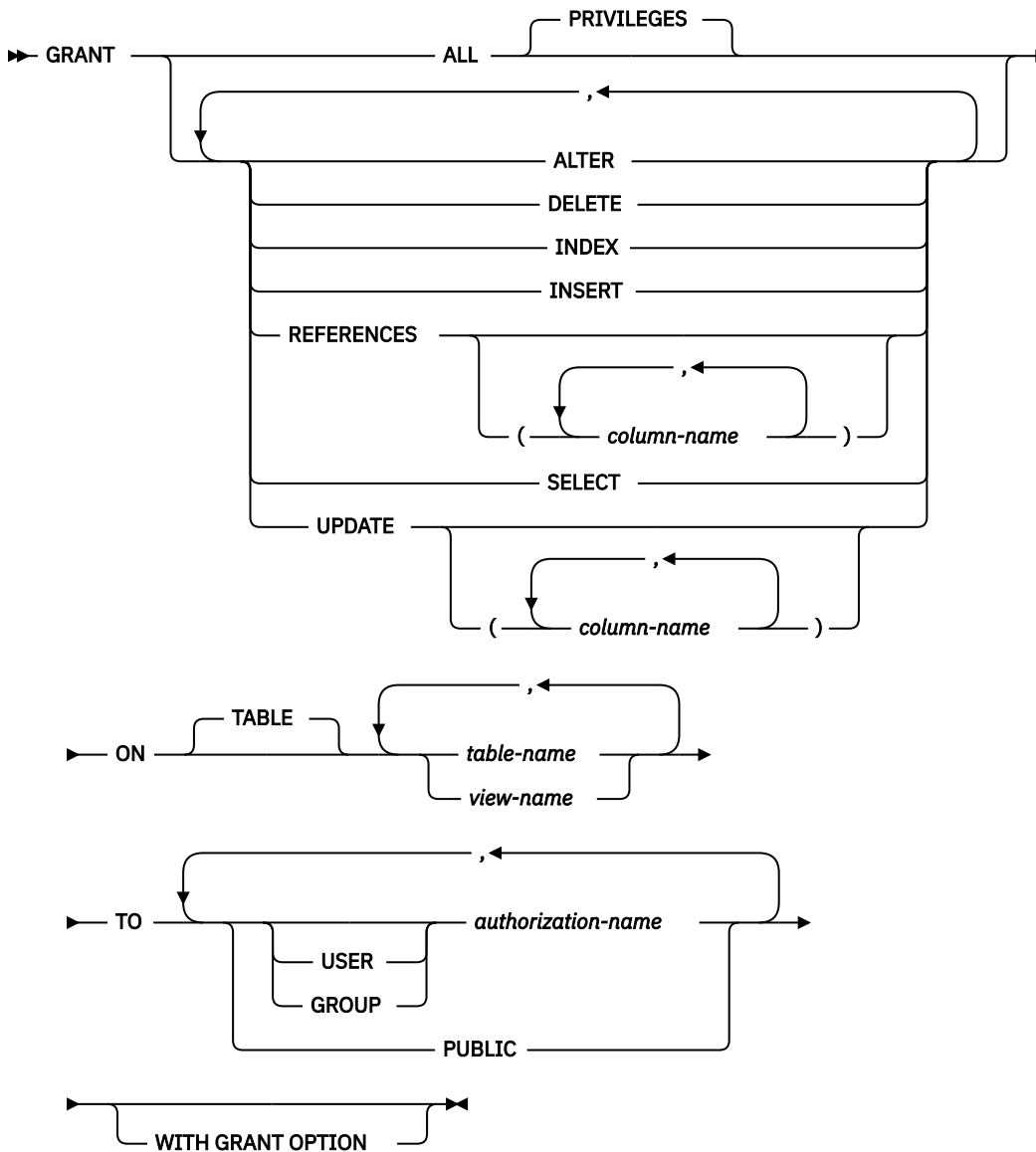

Description

ALL or ALL PRIVILEGES

Grants one or more privileges. The privileges granted are all those grantable privileges that the authorization ID of the statement has on the specified tables or views.

Note that granting ALL PRIVILEGES on a table or view is not the same as granting the system authority of *ALL.

ALTER

Grants the privilege to alter the specified table or create or drop a trigger on the specified table. Grants the privilege to use the COMMENT and LABEL statements on tables and views.

DELETE

Grants the privilege to delete rows from the specified table or view. If a view is specified, it must be a deletable view.

INDEX

Grants the privilege to create an index on the specified table. This privilege cannot be granted on a view.

INSERT

Grants the privilege to insert rows into the specified table or view. If a view is specified, it must be an insertable view.

REFERENCES

Grants the privilege to add a referential constraint in which each specified table is a parent. If a list of columns is not specified or if REFERENCES is granted to all columns of the table or view via the specification of ALL PRIVILEGES, the grantee(s) can add referential constraints using all columns of each table specified in the ON clause as a parent key, even those added later via the ALTER TABLE statement. This privilege can be granted on a view, but the privilege is not used for a view.

REFERENCES (column-name,...)

Grants the privilege to add a referential constraint in which each specified table is a parent using only those columns specified in the column list as a parent key. Each *column-name* must be an unqualified name that identifies a column of each table specified in the ON clause. This privilege can be granted on the columns of a view, but the privilege is not used for a view.

SELECT

Grants the privilege to create a view or read data from the specified table or view. For example, the SELECT privilege is required if a table or view is specified in a query.

UPDATE

Grants the privilege to update rows in the specified table or view. If a list of columns is not specified or if UPDATE is granted to all columns of the table or view via the specification of ALL PRIVILEGES, the grantee(s) can update all updatable columns on each table specified in the ON clause, even those added later via the ALTER TABLE statement. If a view is specified, it must be an updatable view.

UPDATE (column-name,...)

Grants the privilege to use the UPDATE statement to update only those columns that are identified in the column list. Each *column-name* must be an unqualified name that identifies a column of each table and view specified in the ON clause. If a view is specified, it must be an updatable view and the specified columns must be updatable columns.

ON table-name or view-name,...

Identifies the tables or views on which the privileges are granted. The *table-name* or *view-name* must identify a table or view that exists at the current server, but must not identify a declared temporary table.

TO

Indicates to whom the privileges are granted.

USER

Specifies that the *authorization-name* identifies a user profile. If USER is specified, *authorization-name* must be a user profile.

GROUP

Specifies that the *authorization-name* identifies a group profile. If GROUP is specified, *authorization-name* must be a group profile.

authorization-name,...

Lists one or more authorization IDs.

PUBLIC

Grants the privileges to a set of users (authorization IDs). For more information, see [“Authorization, privileges and object ownership”](#) on page 15.

WITH GRANT OPTION

Allows the specified *authorization-names* to grant privileges on the tables and views specified in the ON clause to other users.

If WITH GRANT OPTION is omitted, the specified *authorization-names* cannot grant privileges on the tables and views specified in the ON clause unless they have received that authority from some other source (for example, from a grant of the system authority *OBJMGT).

Notes

Corresponding system authorities: The GRANT and REVOKE statements assign and remove system authorities for SQL objects. The following table describes the system authorities that correspond to the SQL privileges when granting to a table. The left column lists the SQL privilege. The right column lists the equivalent system authorities that are granted or revoked.

Table 105. Privileges Granted to or Revoked from Tables

SQL Privilege	Corresponding System Authorities when Granting to or Revoking from a Table
ALL (GRANT or revoke of ALL only grants or revokes those privileges the authorization ID of the statement has)	*OBJALTER ¹¹¹ *OBJMGT (Revoke only) *OBJOPR *OBJREF *ADD *DLT *READ *UPD
ALTER	*OBJALTER ¹¹²
DELETE	*OBJOPR ¹¹³ *DLT
INDEX	*OBJALTER ¹¹²
INSERT	*OBJOPR ¹¹³ *ADD
REFERENCES	*OBJREF ¹¹²
SELECT	*OBJOPR ¹¹³ *READ
UPDATE	*OBJOPR ¹¹³ *UPD
WITH GRANT OPTION	*OBJMGT

The following table describes the system authorities that correspond to the SQL privileges when granting to a view. The left column lists the SQL privilege. The middle column lists the equivalent system authorities that are granted to or revoked from the view itself. The right column lists the system authorities that are granted to all tables and views referenced in the view's definition, and if a view is referenced, all tables and views referenced in its definition, and so on. ¹¹⁴

If a view references more than one table or view, the *DLT, *ADD, and *UPD system authorities are only granted to the first table or view in the fullselect of the view definition. The *READ system authority is granted to all tables and views referenced in the view definition.

¹¹¹ The SQL INDEX and ALTER privilege correspond to the same system authority of *OBJALTER. Granting both INDEX and ALTER will not provide the user with any additional authorities.

¹¹² If the WITH GRANT OPTION is given to a user, the user will also be able to perform the functions given by ALTER and REFERENCES authority.

¹¹³ *OBJOPR is only revoked when the last system privilege other than *OBJOPR is also revoked for the specified authorization ID or PUBLIC.

¹¹⁴ The specified rights are only granted to the tables and views referenced in the view definition if the user to whom the rights are being granted doesn't already have the rights from another authority source, for example public authority.

If more than one system authority will be granted with an SQL privilege, and any one of the authorities cannot be granted, then a warning occurs and no authorities will be granted for that privilege. Unlike GRANT, REVOKE only revokes system authorities to the view. No system authorities are revoked from the referenced tables and views.

<i>Table 106. Privileges Granted to or Revoked from Views</i>		
SQL Privilege	Corresponding System Authorities Granted to or Revoked from View	Corresponding System Authorities Granted to or Revoked from Referenced Tables and Views
ALL (GRANT or REVOKE of ALL only grants or revokes those privileges the authorization ID of the statement has)	*OBJALTER *OBJMGT (Revoke only) *OBJOPR *OBJREF *ADD *DLT *READ *UPD	*ADD *DLT *READ *UPD
ALTER	*OBJALTER ¹¹²	None
DELETE	*OBJOPR ¹¹³ *DLT	*DLT
INDEX	Not Applicable	Not Applicable
INSERT	*OBJOPR ¹¹³ *ADD	*ADD
REFERENCES	*OBJREF ¹¹²	None
SELECT	*OBJOPR ¹¹³ *READ	*READ
UPDATE	*OBJOPR ¹¹³ *UPD	*UPD
WITH GRANT OPTION	*OBJMGT	None

Corresponding system authorities when checking privileges to a table or view: The following table describes the system authorities that correspond to the SQL privileges when checking privileges to a table. The left column lists the SQL privilege. The right column lists the equivalent system authorities.

<i>Table 107. Corresponding System Authorities when Checking Privileges to a Table</i>	
SQL Privilege	Corresponding System Authorities when Checking Privileges to a Table
ALTER	*OBJALTER or *OBJMGT
DELETE	*OBJOPR and *DLT
INDEX	*OBJALTER or *OBJMGT
INSERT	*OBJOPR and *ADD

SQL Privilege	Corresponding System Authorities when Checking Privileges to a Table
REFERENCES	*OBJREF or *OBJMGT
SELECT	*OBJOPR and *READ
UPDATE	*OBJOPR and *UPD

The following table describes the system authorities that correspond to the SQL privileges when checking privileges to a view. The left column lists the SQL privilege. The middle column lists the equivalent system authorities that are checked on the view itself. The right column lists the system authorities that are checked on all tables and views referenced in the view's definition, and if a view is referenced, all tables and views referenced in its definition, and so on.

SQL Privilege	Corresponding System Authorities to the View	Corresponding System Authorities to the Referenced Tables and Views
ALTER	*OBJALTER and *OBJMGT	None
DELETE ¹¹⁵	*OBJOPR and *DLT	*DLT
INDEX	Not Applicable	Not Applicable
INSERT ¹¹⁶	*OBJOPR and *ADD	*ADD
REFERENCES	*OBJREF or *OBJMGT	None
SELECT	*OBJOPR and *READ	*READ
UPDATE ¹¹⁷	*OBJOPR and *UPD	*UPD

GRANT rules: The GRANT statement will grant only those privileges that the authorization ID of the statement is allowed to grant. If no privileges were granted, an error is returned.

Examples

Example 1: Grant all privileges on the table WESTERN_CR to PUBLIC.

¹¹⁵ When a view is created, the owner does not necessarily acquire the DELETE privilege on the view. The owner only acquires the DELETE privilege if the view allows deletes and the owner also has the DELETE privilege on the first table referenced in the subselect.

¹¹⁶ When a view is created, the owner does not necessarily acquire the INSERT privilege on the view. The owner only acquires the INSERT privilege if the view allows inserts and the owner also has the INSERT privilege on the first table referenced in the subselect.

¹¹⁷ When a view is created, the owner does not necessarily acquire the UPDATE privilege on the view. The owner only acquires the UPDATE privilege if the view allows updates and the owner also has the UPDATE privilege on the first table referenced in the subselect.

```
GRANT ALL PRIVILEGES ON WESTERN_CR  
TO PUBLIC
```

Example 2: Grant the appropriate privileges on the CALENDAR table so that PHIL and CLAIRE can read it and insert new entries into it. Do not allow them to change or remove any existing entries.

```
GRANT SELECT, INSERT ON CALENDAR  
TO PHIL, CLAIRE
```

Example 3: Grant column privileges on TABLE1 and VIEW1 to FRED. Note that both columns specified in this GRANT statement must be found in both TABLE1 and VIEW1.

```
GRANT UPDATE(column_1, column_2)  
ON TABLE1, VIEW1  
TO FRED WITH GRANT OPTION
```

GRANT (type privileges)

This form of the GRANT statement grants privileges on a type.

Invocation

This statement can be embedded in an application program or issued interactively. It is an executable statement that can be dynamically prepared.

Authorization

The privileges held by the authorization ID of the statement must include at least one of the following:

- For each distinct type or array type identified in the statement:
 - Every privilege specified in the statement
 - The system authority of *OBJMGT on the type
 - The USAGE privilege on the schema containing the type
- Database administrator authority
- Security administrator authority

If WITH GRANT OPTION is specified, the privileges held by the authorization ID of the statement must include at least one of the following:

- Ownership of the type
- Database administrator authority
- Security administrator authority

Syntax

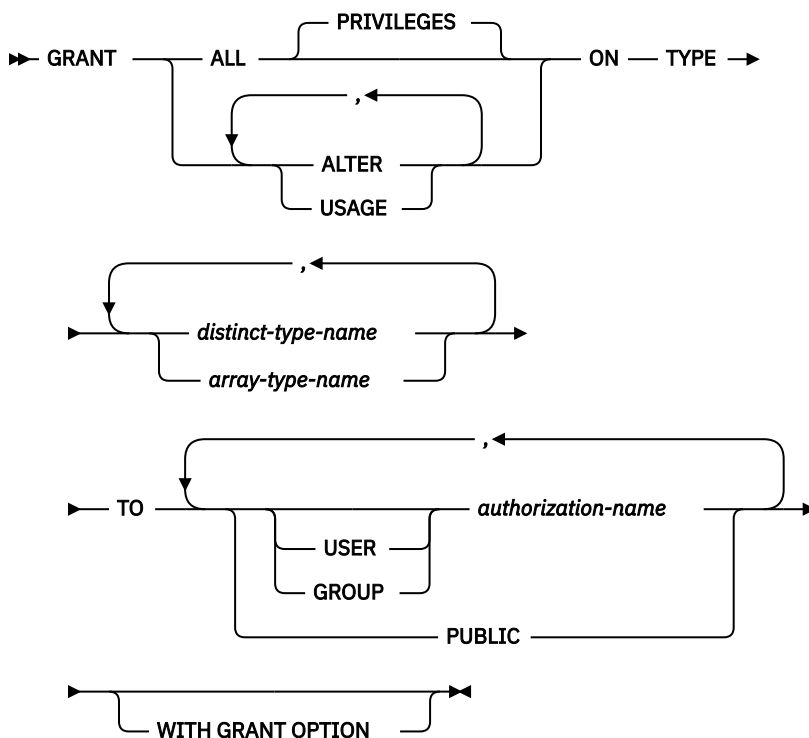

Description

ALL or ALL PRIVILEGES

Grants one or more privileges. The privileges granted are all those grantable privileges that the authorization ID of the statement has on the specified distinct types or array types. Note that granting ALL PRIVILEGES on a type is not the same as granting the system authority of *ALL.

If you do not use ALL, you must use one or more of the keywords listed below. Each keyword grants the privilege described.

ALTER

Grants the privilege to use the COMMENT and LABEL statement.

USAGE

Grants the privilege to use the type in tables, functions, procedures, or CAST expressions.

ON TYPE *distinct-type-name* or *array-type-name*

Identifies the distinct types or array types on which the privilege is granted. The *distinct-type-name* or *array-type-name* must identify a user-defined type that exists at the current server.

TO

Indicates to whom the privileges are granted.

USER

Specifies that the *authorization-name* identifies a user profile. If USER is specified, *authorization-name* must be a user profile.

GROUP

Specifies that the *authorization-name* identifies a group profile. If GROUP is specified, *authorization-name* must be a group profile.

authorization-name,...

Lists one or more authorization IDs.

PUBLIC

Grants the privileges to a set of users (authorization IDs). For more information, see [“Authorization, privileges and object ownership”](#) on page 15.

WITH GRANT OPTION

Allows the specified *authorization-names* to grant privileges on the types specified in the ON clause to other users.

If WITH GRANT OPTION is omitted, the specified *authorization-names* cannot grant the USAGE privilege to others unless they have received that authority from some other source (for example, from a grant of the system authority *OBJMGT).

Notes

Corresponding System Authorities: GRANT and REVOKE statements assign and remove system authorities for SQL objects. The following table describes the system authorities that correspond to the SQL privileges:

SQL Privilege	Corresponding System Authorities when Granting to or Revoking from a User-defined Type
ALL (Grant or revoke of ALL grants or revokes only those privileges the authorization ID of the statement has)	*OBJALTER *OBJOPR *EXECUTE *OBJMGT (Revoke only)
ALTER	*OBJALTER

Table 109. Privileges Granted to or Revoked from User-defined Types (continued)

SQL Privilege	Corresponding System Authorities when Granting to or Revoking from a User-defined Type
USAGE	*EXECUTE *OBJOPR
WITH GRANT OPTION	*OBJMGT

Corresponding System Authorities When Checking Privileges to a User-defined Type: The following table describes the system authorities that correspond to the SQL privileges when checking privileges to a type. The left column lists the SQL privilege. The right column lists the equivalent system authorities.

Table 110. Corresponding System Authorities When Checking Privileges to a User-defined Type

SQL Privilege	Corresponding System Authorities when Granting to or Revoking from a User-defined Type
ALTER	*OBJALTER
USAGE	*EXECUTE and *OBJOPR

When USAGE privilege is required: USAGE privilege is required when a type is explicitly referenced in an SQL statement. For example, in a statement that contains a CAST specification or in a CREATE TABLE statement. The USAGE privilege is not required when a type is indirectly referenced. For example, when a view references a column of a table that has a distinct data type.

Syntax alternatives: The following keywords are synonyms supported for compatibility to prior releases. These keywords are non-standard and should not be used:

- The keywords DATA TYPE or DISTINCT TYPE can be used as a synonym for TYPE.

Example

Grant the USAGE privilege on distinct type SHOE_SIZE to user JONES. This GRANT statement does not give JONES the privilege to execute the cast functions that are associated with the distinct type SHOE_SIZE.

```
GRANT USAGE
ON DISTINCT TYPE SHOE_SIZE
TO JONES
```

GRANT (variable privileges)

This form of the GRANT statement grants privileges on a global variable.

Invocation

This statement can be embedded in an application program or issued interactively. It is an executable statement that can be dynamically prepared.

Authorization

The privileges held by the authorization ID of the statement must include at least one of the following:

- For each global variable identified in the statement:
 - Every privilege specified in the statement
 - The system authority of *OBJMGT on the global variable
 - The USAGE privilege on the schema containing the global variable
- Database administrator authority
- Security administrator authority

If WITH GRANT OPTION is specified, the privileges held by the authorization ID of the statement must include at least one of the following:

- Ownership of the global variable
- Database administrator authority
- Security administrator authority

Syntax

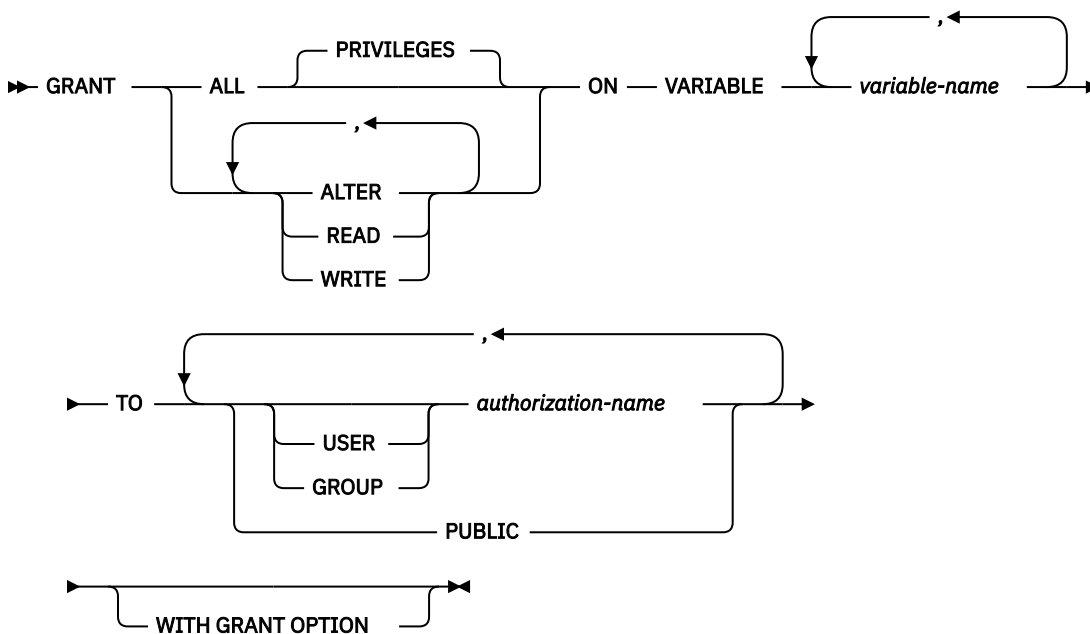

Description

ALL or ALL PRIVILEGES

Grants one or more privileges. The privileges granted are all those grantable privileges that the authorization ID of the statement has on the specified global variables. Note that granting ALL PRIVILEGES on a global variable is not the same as granting the system authority of *ALL.

If you do not use ALL, you must use one or more of the keywords listed below. Each keyword grants the privilege described.

ALTER

Grants the privilege to use the COMMENT and LABEL statements on a global variables.

READ

Grants the privilege to read the value of a global variable.

WRITE

Grants the privilege to assign a value to a global variable.

ON VARIABLE *variable-name*

Identifies the global variables on which the privilege is granted. The *variable-name* must identify a global variable that exists at the current server.

TO

Indicates to whom the privileges are granted.

USER

Specifies that the *authorization-name* identifies a user profile. If USER is specified, *authorization-name* must be a user profile.

GROUP

Specifies that the *authorization-name* identifies a group profile. If GROUP is specified, *authorization-name* must be a group profile.

authorization-name,...

Lists one or more authorization IDs.

PUBLIC

Grants the privileges to a set of users (authorization IDs). For more information, see [“Authorization, privileges and object ownership” on page 15.](#)

WITH GRANT OPTION

Allows the specified *authorization-names* to grant privileges on the global variables specified in the ON clause to other users.

Notes

Corresponding System Authorities: GRANT and REVOKE statements assign and remove system authorities for SQL objects. The following table describes the system authorities that correspond to the SQL privileges:

SQL Privilege	Corresponding System Authorities when Granting to or Revoking from a Global Variable
ALL (Grant or revoke of ALL grants or revokes only those privileges the authorization ID of the statement has)	*OBJALTER *OBJOPR *EXECUTE *UPD *READ *OBJMGT (Revoke only)
ALTER	*OBJALTER

Table 111. Privileges Granted to or Revoked from Global Variables (continued)

SQL Privilege	Corresponding System Authorities when Granting to or Revoking from a Global Variable
READ	*OBJOPR *EXECUTE *READ
WRITE	*OBJOPR *EXECUTE *UPD
WITH GRANT OPTION	*OBJMGT

Corresponding System Authorities When Checking Privileges to a Global Variable: The following table describes the system authorities that correspond to the SQL privileges when checking privileges to a global variable. The left column lists the SQL privilege. The right column lists the equivalent system authorities.

Table 112. Corresponding System Authorities When Checking Privileges to a Global Variable

SQL Privilege	Corresponding System Authorities
ALTER	*OBJALTER
READ	*OBJOPR and *EXECUTE and *READ
WRITE	*OBJOPR and *EXECUTE and *UPD

Example

Grant the READ and WRITE privileges on global variable MYSCHEMA.MYJOB_PRINTER to user ZUBIRI.

```
GRANT READ, WRITE
ON VARIABLE MYSCHEMA.MYJOB_PRINTER
TO ZUBIRI
```

GRANT (XML schema privileges)

This form of the GRANT statement grants privileges on an XSR object.

Invocation

This statement can be embedded in an application program or issued interactively. It is an executable statement that can be dynamically prepared.

Authorization

The privileges held by the authorization ID of the statement must include at least one of the following:

- For each XSR object identified in the statement:
 - Every privilege specified in the statement
 - The system authority of *OBJMGT on the XSR object
 - The USAGE privilege on the schema containing the XSR object
- Database administrator authority
- Security administrator authority

If WITH GRANT OPTION is specified, the privileges held by the authorization ID of the statement must include at least one of the following:

- Ownership of the XSR object
- Database administrator authority
- Security administrator authority

Syntax

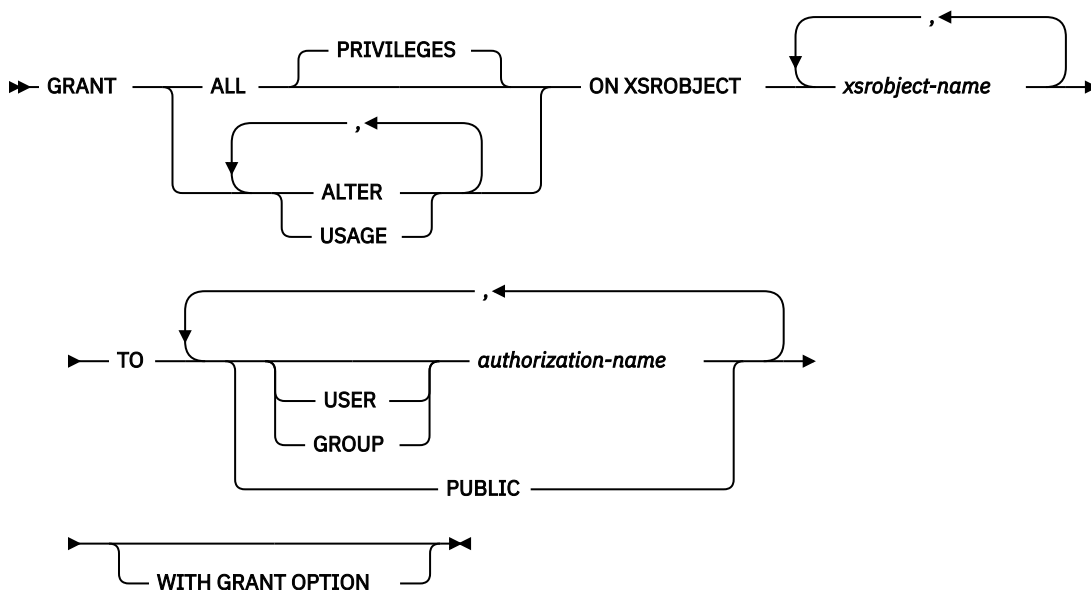

Description

ALL or ALL PRIVILEGES

Grants one or more privileges. The privileges granted are all those grantable privileges that the authorization ID of the statement has on the specified XSR object. Note that granting ALL PRIVILEGES on an XSR object is not the same as granting the system authority of *ALL.

If you do not use ALL, you must use one or more of the keywords listed below. Each keyword grants the privilege described.

ALTER

Grants the privilege to use the COMMENT and LABEL statements.

USAGE

Grants the privilege to use the XSR object for validation or decomposition.

ON XSR OBJECT *xsobject-name*

Identifies the XSR objects for which the privilege is granted. The *xsobject-name* must identify an XSR object that exists at the current server.

TO

Indicates to whom the privileges are granted.

USER

Specifies that the *authorization-name* identifies a user profile. If USER is specified, *authorization-name* must be a user profile.

GROUP

Specifies that the *authorization-name* identifies a group profile. If GROUP is specified, *authorization-name* must be a group profile.

authorization-name,...

Lists one or more authorization IDs.

PUBLIC

Grants the privileges to a set of users (authorization IDs). For more information, see [“Authorization, privileges and object ownership” on page 15.](#)

WITH GRANT OPTION

Allows the specified *authorization-names* to grant privileges on the XSR objects specified in the ON clause to other users.

If WITH GRANT OPTION is omitted, the specified *authorization-names* cannot grant privileges on the XSR objects specified in the ON clause to another user unless they have received that authority from some other source (for example, from a grant of the system authority *OBJMGT).

Notes

GRANT and REVOKE statements assign and remove system authorities for SQL objects. The following table describes the system authorities that correspond to the SQL privileges:

<i>Table 113. Privileges Granted to or Revoked from XSR Objects</i>	
SQL Privilege	Corresponding System Authorities when Granting to or Revoking from an XSR object
ALL (Grant or revoke of ALL grants or revokes only those privileges the authorization ID of the statement has)	*OBJALTER *OBJOPR *READ *EXECUTE *OBJMGT (Revoke only)
ALTER	*OBJALTER
USAGE	*OBJOPR *EXECUTE *READ
WITH GRANT OPTION	*OBJMGT

Corresponding System Authorities When Checking Privileges to an XSR Object: The following table describes the system authorities that correspond to the SQL privileges when checking privileges to an XSR object. The left column lists the SQL privilege. The right column lists the equivalent system authorities.

<i>Table 114. Corresponding System Authorities When Checking Privileges to an XSR Object</i>	
SQL Privilege	Corresponding System Authorities
ALTER	*OBJALTER
USAGE	*OBJOPR and *EXECUTE and *READ

Example

Grant the USAGE privilege on XSR object XMLSCHEMA to PUBLIC.

```
GRANT USAGE  
ON XSROBJECT XMLSCHEMA  
TO PUBLIC
```

HOLD LOCATOR

The HOLD LOCATOR statement allows a LOB or XML locator variable to retain its association with a value beyond a unit of work.

Invocation

This statement can only be embedded in an application program. It cannot be issued interactively. It is an executable statement that can be dynamically prepared. However, the EXECUTE statement with the USING clause must be used to execute the prepared statement. HOLD LOCATOR cannot be used with the EXECUTE IMMEDIATE statement. It must not be specified in REXX.

Authorization

None required.

Syntax

➔ HOLD LOCATOR *variable* ➔

Description

variable,...

Identifies a variable that must be declared in accordance with the rules for declaring variable locator variables. An indicator variable must not be specified. The locator variable type must be a binary large object locator, a character large object locator, a double-byte character large object locator, or an XML locator.

After the HOLD LOCATOR statement is executed, each locator variable in the *variable* list has the hold property.

The variable must currently have a locator assigned to it. That is, a locator must have been assigned during this unit of work (by a CALL, FETCH, SELECT INTO, SET variable, or VALUES INTO statement) and must not subsequently have been freed (by a FREE LOCATOR statement); otherwise, an error is raised.

If more than one variable is specified in the HOLD LOCATOR statement and an error occurs on one of the locators, no locators will be held.

Note

A LOB or XML locator variable that has the hold property is freed (has its association between it and its value removed) when:

- The SQL FREE LOCATOR statement is executed for the locator variable.
- The SQL ROLLBACK statement without a HOLD option is executed.
- The SQL session is terminated.

Example

Assume that the employee table contains columns RESUME, HISTORY, and PICTURE and that locators have been established in a program to represent the values represented by the columns. Give the CLOB locator variables LOCRES and LOCHIST, and the BLOB locator variable LOCPIC the hold property.

```
HOLD LOCATOR :LOCRES, :LOCHIST, :LOCPIC
```

INCLUDE

The INCLUDE statement inserts application code, including declarations and statements, into a source program.

Invocation

This statement can only be embedded in an application program. It is not an executable statement. It must not be specified in Java or REXX.

Authorization

The authorization ID of the statement must have the system authorities *OBJOPR and *READ on the file that contains the member.

Syntax

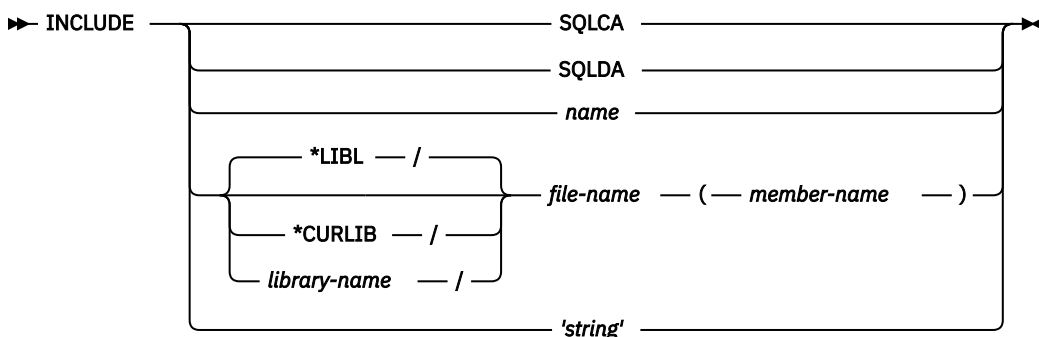

Description

SQLCA

Indicates the description of an SQL communication area (SQLCA) is to be included. INCLUDE SQLCA must not be specified if the program includes a stand-alone SQLCODE or a stand-alone SQLSTATE. An SQLCA can be specified for C, C++, COBOL, and PL/I. If the SQLCA is not specified, the variable SQLCODE or SQLSTATE must appear in the program.

INCLUDE SQLCA must not be specified more than once in the same program. For more information, see [“SQL diagnostic information”](#) on page 802.

The SQLCA should not be specified for RPG programs. In an RPG program, the precompiler automatically includes the SQLCA.

For a description of the SQLCA, see [Appendix C, “SQLCA \(SQL communication area\),”](#) on page 1657.

SQLDA

Specifies the description of an SQL descriptor area (SQLDA) is to be included. INCLUDE SQLDA can be specified in C, C++, COBOL, PL/I, and ILE RPG.

For a description of the SQLDA, see [Appendix D, “SQLDA \(SQL descriptor area\),”](#) on page 1667.

name

Identifies a member or source stream file to be included in the source program.

If precompiling using the SRCFILE parameter, it identifies a member to be included from the file specified on the INCFILE parameter of the CRTSQLxxx command.

If precompiling using the SRCSTMF parameter, it identifies a file to be included using the path from the INCDIR parameter of the CRTSQLxxx command. No suffix will be appended to the name.

The source can contain any host language statements and any SQL statements other than an INCLUDE statement. In COBOL, INCLUDE *member-name* must not be specified in other than the DATA DIVISION or PROCEDURE DIVISION.

file-name (member-name)

Identifies a source file and member to be included in the source program. The library containing the source file is specified in one of these ways:

***LIBL**

Libraries in the job's library list are searched until the first match is found. This is the default.

***CURLIB**

The current library for the job is searched. If no library is specified as the current library for the job, QGPL is used.

library-name

Identifies the name of the library to search.

The source can contain any host language statements and any SQL statements other than an INCLUDE statement. In COBOL, INCLUDE must not be specified in other than the DATA DIVISION or PROCEDURE DIVISION.

Including a source file and member is only allowed when precompiling using the SRCFILE parameter.

'string'

Identifies a file to be included using the path from the INCDIR parameter of the CRTSQLxxx command. The string will be handled as a normal SQL string literal; the source stream file rules for escaping characters will not be followed. No suffix will be appended to the string.

The source can contain any host language statements and any SQL statements other than an INCLUDE statement.

Including a stream file is only allowed when precompiling using the SRCSTMF parameter.

When your program is precompiled, the INCLUDE statement is replaced by source statements.

The INCLUDE statement must be specified at a point in your program where the resulting source statements are acceptable to the compiler.

Notes

CCSID considerations: If the CCSID of the file specified on the SRCFILE or SRCSTMF parameter is different from the CCSID of the source for the INCLUDE statement, the INCLUDE source is converted to the CCSID of the source file.

Example

Include an SQL descriptor area in a C program.

```
EXEC SQL INCLUDE SQLDA;

EXEC SQL DECLARE C1 CURSOR FOR
  SELECT DEPTNO, DEPTNAME, MGRNO FROM TDEPT
  WHERE ADMRDEPT = 'A00';

EXEC SQL OPEN C1;

while (SQLCODE==0) {
  EXEC SQL FETCH C1 INTO :dnum, :dname, :mnum;

  /* Print results */
}

EXEC SQL CLOSE C1;
```

INSERT

The INSERT statement inserts rows into a table or view. Inserting a row into a view also inserts the row into the table on which the view is based if no INSTEAD OF INSERT trigger is defined on this view. If such a trigger is defined, the trigger will be activated instead.

There are four forms of this statement:

- The *INSERT using VALUES* form is used to insert one or more rows into the table or view using the values provided or referenced.
- The *INSERT using fullselect* form is used to insert one or more rows into the table or view using values from other tables or views.
- The *INSERT using n ROWS* form is used to insert multiple rows into the table or view using the values provided in a host-structure-array.
- The *INSERT DEFAULT VALUES* form is used to insert a single row using default values for every column.

Invocation

This statement can be embedded in an application program or issued interactively. It is an executable statement that can be dynamically prepared with the exception of the n ROWS form, which must be a static statement embedded in an application program. The n ROWS form is not allowed in a REXX procedure.

Authorization

The privileges held by the authorization ID of the statement must include at least one of the following:

- For the table or view identified in the statement:
 - The INSERT privilege on the table or view, and
 - The USAGE privilege on the schema containing the table or view
- Database administrator authority

If a *fullselect* is specified, the privileges held by the authorization ID of the statement must also include one of the following:

- For each table or view identified in the *fullselect*:
 - The SELECT privilege on the table or view, and
 - The USAGE privilege on the schema containing the table or view
- Database administrator authority

For information about the system authorities corresponding to SQL privileges, see [Corresponding System Authorities When Checking Privileges to a Table or View](#).

Syntax

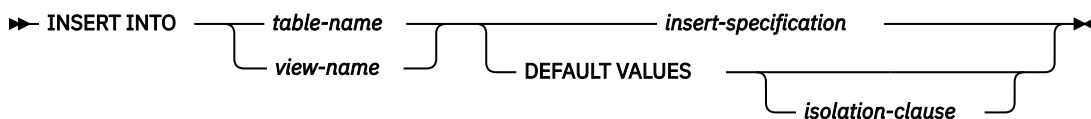

insert-specification

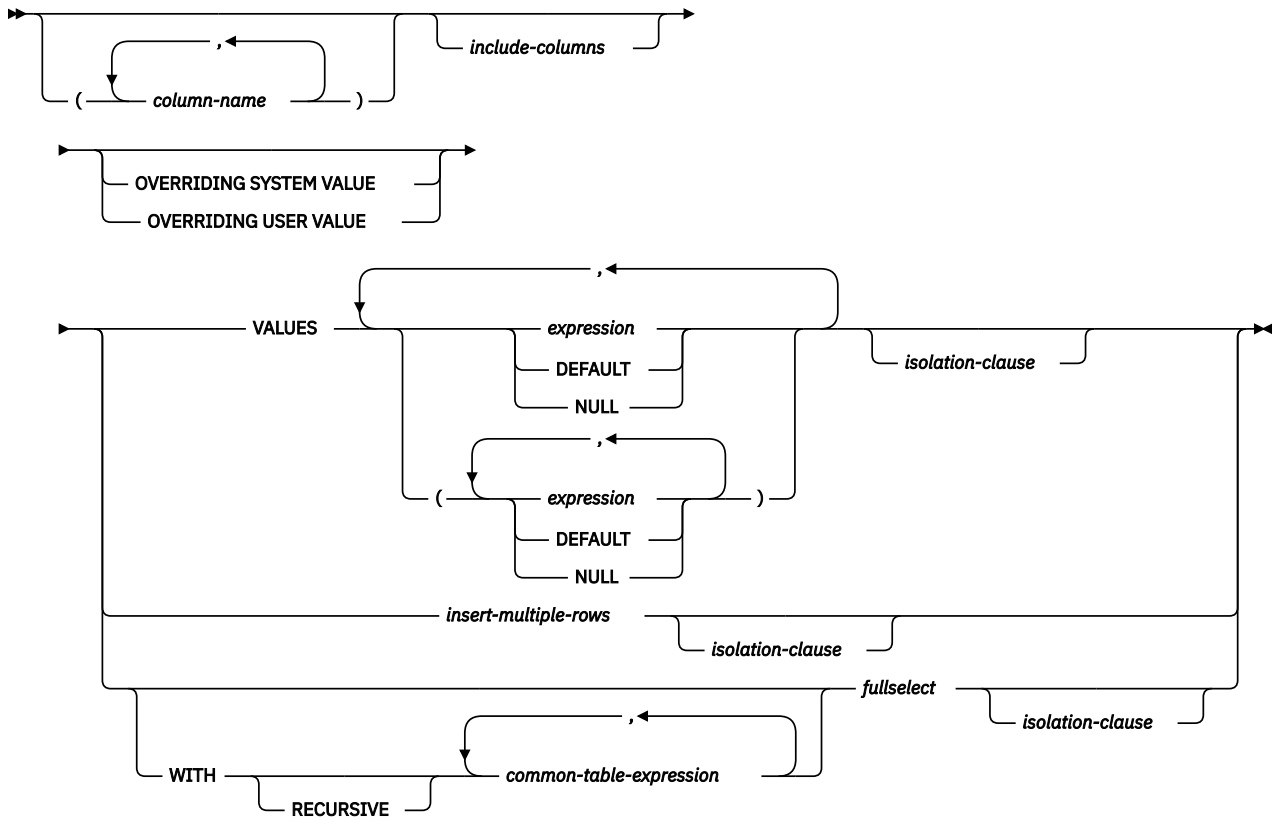

include-columns

➤➤ **INCLUDE** — (→

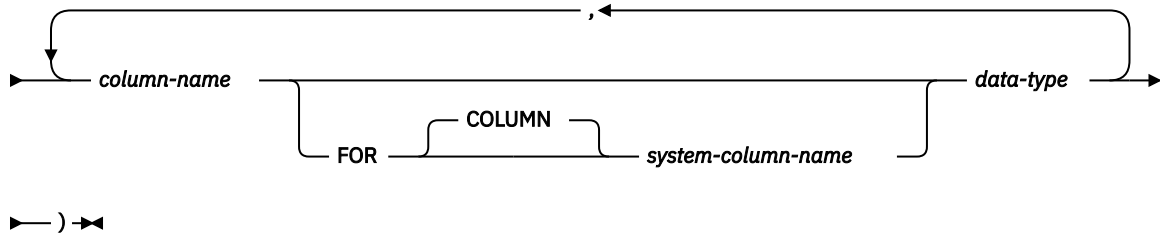

→) ➤➤

insert-multiple-rows

➤➤ *integer* **ROWS** — **VALUES** — (— *host-structure-array* —) ➤➤
variable

isolation-clause

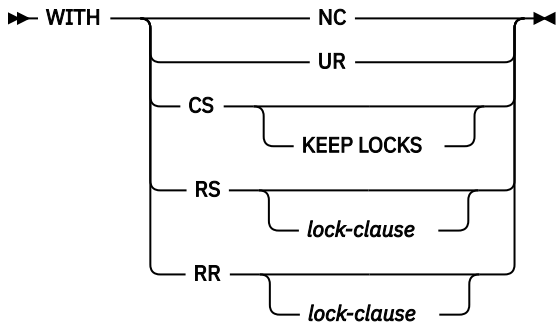

lock-clause

➤➤ **USE AND KEEP EXCLUSIVE LOCKS** ➤➤

data-type

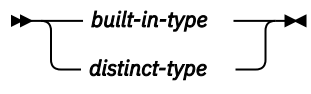

built-in-type

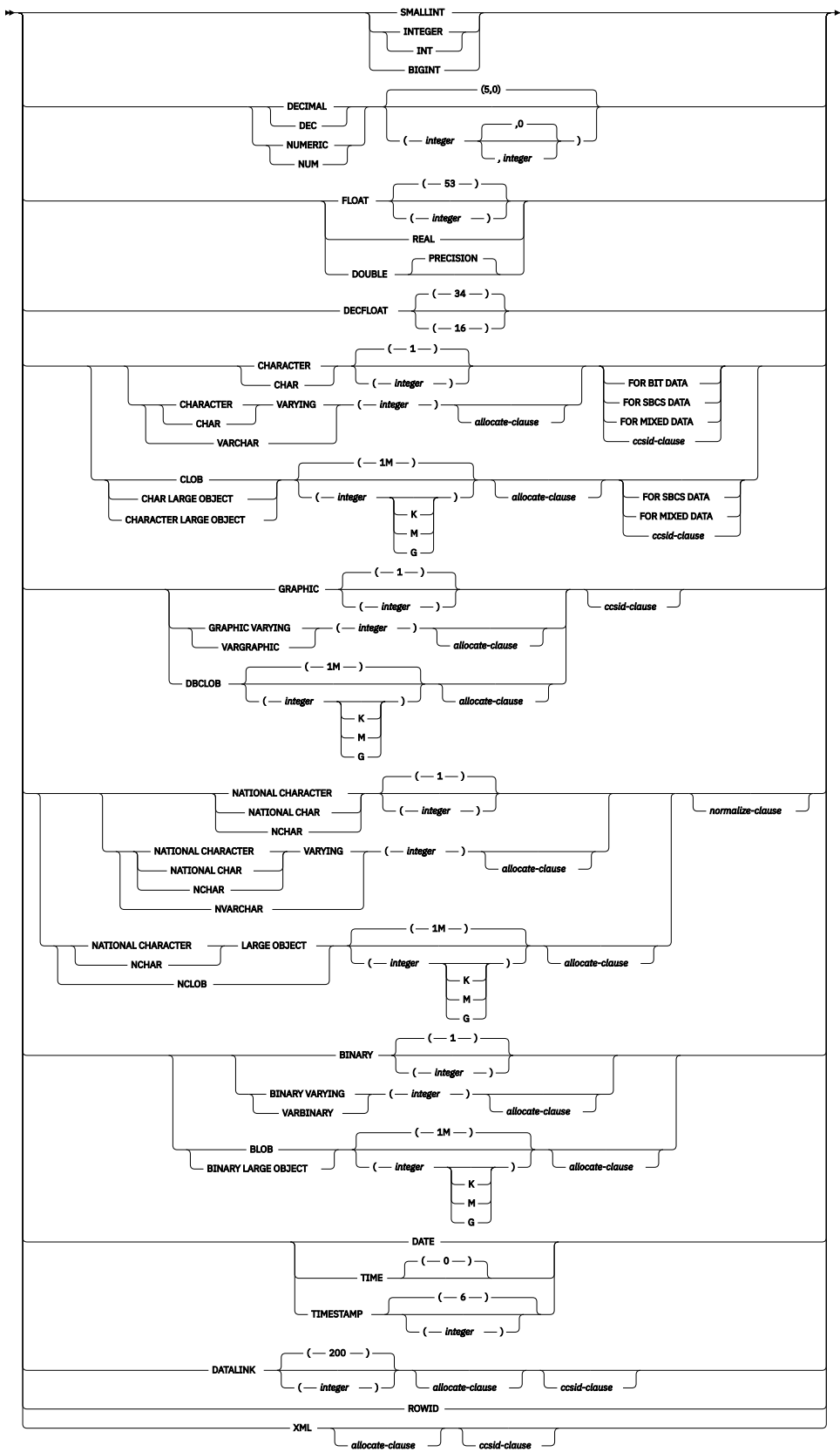

allocate-clause

➔ ALLOCATE — (— integer —) ➔

ccsid-clause

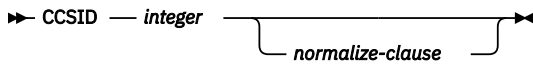

normalize-clause



Description

INTO *table-name* or *view-name*

Identifies the object of the insert operation. The name must identify a table or view that exists at the current server, but it must not identify a history table, a catalog table, a view of a catalog table, or a view that is not insertable. For an explanation of insertable views, see [“CREATE VIEW” on page 1198](#).

DEFAULT VALUES

Specifies that a default value will be assigned to every column in the table. This is the same as specifying a list of values for all the columns with each of the values being the keyword DEFAULT. The value that is inserted depends on how the column was defined, as described for the DEFAULT keyword.

(*column-name*,...)

Specifies the columns for which insert values are provided. Each name must be a name that identifies a column of the table or view. The same column must not be identified more than once. If extended indicators are not enabled, a view column that is not updatable must not be identified. If extended indicators are not enabled and the object of the insert operation is a view with non-updatable columns, a list of column names must be specified and the list must not identify those columns. For an explanation of updatable columns in views, see [“CREATE VIEW” on page 1198](#).

Omission of the column list is an implicit specification of a list in which every column of the table or view is identified in left-to-right order. Any columns defined with the hidden attribute are omitted. This list is established when the statement is prepared and, therefore, does not include columns that were added to a table after the statement was prepared.

If the INSERT statement is embedded in an application and the referenced table or view exists at create program time, the statement is prepared at create program time. Otherwise, the statement is prepared at the first successful execute of the INSERT statement.

include-columns

Specifies a set of columns that are included, along with the columns of *table-name* or *view-name*, in the intermediate result table of the INSERT statement when it is nested in the FROM clause of a fullselect. The *include-columns* are appended to the end of the list of columns specified by *table-name* or *view-name*.

INCLUDE

Specifies a list of columns to be included in the intermediate result table of the INSERT statement. This clause can only be specified if the INSERT statement is nested in the FROM clause of a fullselect.

column-name

Specifies a column of the intermediate result table of the INSERT statement. The name cannot be the same as the name of another include column or a column in *table-name* or *view-name*.

FOR COLUMN *system-column-name*

Provides an IBM i name for the column. The name must not be the same as any *column-name* or *system-column-name* in the INCLUDE column list or in *table-name* or *view-name*.

data-type

Specifies the data type of the include column. For a description of *data-type*, see [“CREATE TABLE” on page 1105](#). If a DATALINK data-type is used, FILE LINK CONTROL is not allowed.

OVERRIDING SYSTEM VALUE or OVERRIDING USER VALUE

Specifies whether system generated values or user-specified values for a ROWID, identity, or row change timestamp column are used. If OVERRIDING SYSTEM VALUE is specified, the implicit or

explicit list of columns for the INSERT statement must contain a ROWID, identity, or row change timestamp column defined as GENERATED ALWAYS. If OVERRIDING USER VALUE is specified, the implicit or explicit list of columns for the INSERT statement must contain a column defined as either GENERATED ALWAYS or GENERATED BY DEFAULT.

OVERRIDING SYSTEM VALUE

Specifies that the value specified in the VALUES clause or produced by a fullselect for a ROWID, identity, or row change timestamp column that is defined as GENERATED ALWAYS is used. A system-generated value is not inserted.

If a value for a row-begin, row-end, transaction-start-ID, or generated expression column is provided, it must be DEFAULT.

OVERRIDING USER VALUE

Specifies that the value specified in the VALUES clause or produced by a fullselect for a column that is defined as either GENERATED ALWAYS or GENERATED BY DEFAULT is ignored. Instead, a system-generated value is inserted, overriding the user-specified value.

If neither OVERRIDING SYSTEM VALUE nor OVERRIDING USER VALUE is specified:

- A value other than DEFAULT cannot be specified for a ROWID, identity, row change timestamp, row-begin, row-end, transaction-start-ID, or generated expression column that is defined as GENERATED ALWAYS.
- A value can be specified for a ROWID, identity, or row change timestamp column that is defined as GENERATED BY DEFAULT. If a value is specified that value is assigned to the column. However, a value can be inserted into a ROWID column defined BY DEFAULT only if the specified value is a valid row ID value that was previously generated by Db2 for z/OS or Db2 for i. When a value is inserted into an identity or row change timestamp column defined BY DEFAULT, the database manager does not verify that the specified value is a unique value for the column unless the identity or row change timestamp column is the sole key in a unique constraint or unique index. Without a unique constraint or unique index, the database manager can guarantee unique values only among the set of system-generated values as long as NO CYCLE is in effect.

If a value is not specified the database manager generates a new value.

VALUES

Specifies one or more new rows to be inserted.

Each variable in the clause must identify a host structure or variable that is declared in accordance with the rules for declaring host structures and variables. In the operational form of the statement, a reference to a host structure is replaced by a reference to each of its variables. For further information about variables and structures, see [“References to host variables” on page 140](#) and [“Host structures” on page 146](#).

The number of values for each row in the VALUES clause must equal the number of names in the implicit or explicit column list and the columns identified in the INCLUDE clause. The first value is inserted in the first column in the list, the second value in the second column, and so on.

expression

An *expression* of the type described in [“Expressions” on page 159](#), that does not include a column name. If *expression* is a *variable*, the variable can identify a structure. If extended indicators are enabled and the expression is not a single variable, the extended indicator values of DEFAULT and UNASSIGNED must not be used for that expression.

DEFAULT

Specifies that the default value is assigned to a column. The value that is inserted depends on how the column was defined, as follows:

- If the column is defined as a generated column based on an expression, the column value is generated by the database manager, based on that expression.
- If the column is a ROWID, an identity column, a row change timestamp column, a row-begin column, a row-end column, or a transaction-start-ID column, the database manager will generate a new value.

- If the WITH DEFAULT clause is used, the default inserted is as defined for the column (see *default-clause* in *column-definition* in [“CREATE TABLE”](#) on page 1105).
- If the WITH DEFAULT clause or the NOT NULL clause is not used, the value inserted is NULL.
- If the NOT NULL clause is used and the WITH DEFAULT clause is not used or DEFAULT NULL is used, the DEFAULT keyword cannot be specified for that column.

DEFAULT must be specified for a ROWID or a generated column that was defined as GENERATED ALWAYS unless OVERRIDING USER VALUE is specified to indicate that any user-specified value will be ignored and a unique system-generated value will be inserted.

NULL

Specifies the value for a column is the null value. NULL should only be specified for nullable columns.

WITH *common-table-expression*

Specifies a common table expression. For an explanation of common table expression, see [“common-table-expression”](#) on page 778.

fullselect

Specifies a set of new rows in the form of the result table of a fullselect. If the result table is empty, SQLSTATE is set to '02000'.

For an explanation of *fullselect*, see [“fullselect”](#) on page 771.

When the base object of the INSERT and a base object of any subselect in the *fullselect* are the same table, the select statement is completely evaluated before any rows are inserted.

The number of columns in the result table must equal the number of names implicitly or explicitly specified in the *column-name* list. The value of the first column of the result is inserted in the first column in the list, the second value in the second column, and so on.

isolation-clause

Specifies the isolation level to be used for this statement.

WITH

Introduces the isolation level, which may be one of:

- *RR* Repeatable read
- *RS* Read stability
- *CS* Cursor stability
- *UR* Uncommitted read
- *NC* No commit

If *isolation-clause* is not specified the default isolation is used. See [“isolation-clause”](#) on page 787 for a description of how the default is determined.

insert-multiple-rows

integer or variable ROWS

Specifies the number of rows to be inserted. If a *variable* is specified, it must be numeric with zero scale and cannot include an indicator variable.

VALUES (*host-structure-array*)

Specifies a set of new rows in the form of an array of host structures. The *host-structure-array* must be declared in the program in accordance with the rules for declaring host structure arrays. A parameter marker may not be used in place of the *host-structure-array* name.

The number of variables in the host structure must equal the number of names in the implicit or explicit column list and the columns identified in the INCLUDE clause. The first host structure in the array corresponds to the first row, the second host structure in the array corresponds to the second row, and so on. In addition, the first variable in the host structure corresponds with the first column of

the row, the second variable in the host structure corresponds with the second column of the row, and so on.

For an explanation of arrays of host structures see [“Host structure arrays”](#) on page 147.

insert-multiple-rows is not allowed if the current connection is to a non-remote server. *insert-multiple-rows* is not allowed in a data change reference in an RPG/400 or PL/I program.

INSERT Rules

Default Values: The value inserted in any column that is not in the column list is the default value of the column. Columns without a default value must be included in the column list. Similarly, if you insert into a view without an INSTEAD OF INSERT trigger, the default value is inserted into any column of the base table that is not included in the view. Hence, all columns of the base table that are not in the view must have a default value.

Assignment: Insert values are assigned to columns in accordance with the storage assignment rules described in [Chapter 2, “Language elements,”](#) on page 43.

Validity: Insert operations must obey the following rules. If they do not, or if any other errors occur during the execution of the INSERT statement, no rows are inserted unless COMMIT(*NONE) was specified.

- *Unique constraints and unique indexes:* If the identified table, or the base table of the identified view, has one or more unique indexes or unique constraints, each row inserted into the table must conform to the limitations imposed by those indexes and constraints (SQLSTATE 23505).

All uniqueness checks are effectively made at the end of the statement unless COMMIT(*NONE) was specified. In the case of a multiple-row INSERT statement, this would occur after all rows were inserted. If COMMIT(*NONE) is specified, checking is performed as each row is inserted.

- *Check constraints:* If the identified table, or the base table of the identified view, has one or more check constraints, each check constraint must be true or unknown for each row inserted into the table (SQLSTATE 23513).

The check constraints are effectively checked at the end of the statement. In the case of a multiple-row INSERT statement, this would occur after all rows were inserted.

- *Views and the CHECK OPTION clause:* If a view is identified, the inserted rows must conform to any applicable CHECK OPTION clause (SQLSTATE 44000). For more information, see [“CREATE VIEW”](#) on page 1198.

Triggers: If the identified table or the base table of the identified view has an insert trigger, the trigger is activated. A trigger might cause other statements to be executed or raise error conditions based on the insert values. If the INSERT statement is used as a *data-change-table-reference*, an AFTER INSERT trigger that attempts to modify the inserted rows will cause an error.

Referential Integrity: Each nonnull insert value of a foreign key must equal some value of the parent key of the parent table in the relationship.

The referential constraints (other than a referential constraint with a RESTRICT delete rule) are effectively checked at the end of the statement. In the case of a multiple-row INSERT statement, this would occur after all rows were inserted and any associated triggers were activated.

If the INSERT statement is used as a *data-change-table-reference*, any referential constraint that attempts to modify the inserted rows will cause an error.

XML values: A value that is inserted into an XML column must be a well-formed XML document.

Inserting rows into a table for which row or column access control is enforced: When an INSERT statement is issued for a table for which row or column access control is enforced, the rules specified in the enabled row permissions or column masks determine whether the row can be inserted. Typically those rules are based on the authorization ID of the statement. The following rules describe how the enabled row permissions and column masks are used during INSERT:

- When a column is referenced while deriving the values of a new row, if that column has an enabled column mask, the masked value is used to derive the new values. If the object table also has column

access control activated, the column mask that is applied to derive the new values must return the column itself, not a constant or an expression. If the column mask does not mask the column to itself, the new value cannot be used for insert and an error is returned.

If the `OVERRIDING USER VALUE` clause is specified, the corresponding values in the new row are ignored, and the above rule for column masks is not applicable to those values.

- If the row can be inserted, and there is a `BEFORE INSERT` trigger for the table, the trigger is activated.

Within the trigger actions, the new values for insert can be modified in the transition variables. When the values return from the trigger, the final values for the new values are the ones for insert.

- A row to be inserted must conform to the enabled row permissions.

When multiple enabled row permissions are defined for a table, a row access control search condition is derived by application of the logical `OR` operator to the search condition in each enabled row permission. A row that conforms to all enabled row permissions is a row that, if the row is inserted, can be retrieved back using the row access control search condition.

- If the rows can be inserted and there is an `AFTER INSERT` trigger for the table, the trigger is activated.

The preceding rules do not apply to the *include-columns*. The *include-columns* will accept whatever values are assigned to them, which could be either masked or unmasked values.

Masked data can be assigned to a variable used as a value for the insert operation. If an insert violation check constraint does not exist for the column, the masked data will be inserted in the column and no error will be issued.

Extended indicator usage: When extended indicators are enabled, indicator values other than positive values and 0 (zero) through -7 must not be specified. The `DEFAULT` and `UNASSIGNED` extended indicator values must not appear in contexts where they are not supported.

Extended indicators: In an `INSERT` statement, the extended indicator value of `UNASSIGNED` has the effect of setting the column to its default value. If a target column is not updatable, it can only be assigned the extended indicator value of `UNASSIGNED`, unless it is a generated column defined as `GENERATED ALWAYS`. If the target column is a generated column defined as `GENERATED ALWAYS`, then it must be assigned the extended indicator value of `DEFAULT` or `UNASSIGNED`.

Extended indicators and insert triggers: The activation of insert triggers is not affected by the use of extended indicators. If all columns in the implicit or explicit column list have been assigned an extended indicator value of `UNASSIGNED` or `DEFAULT`, an insert where all columns have their respective default values is attempted and, if successful, the insert trigger is activated.

Extended indicators and deferred error checks: When extended indicators are enabled, validation that would normally be done during statement preparation to recognize an insert into a non-updatable column is deferred until the statement is executed.

Notes

Insert operation errors: If an insert value violates any constraints, or if any other error occurs during the execution of an `INSERT` statement and `COMMIT(*NONE)` was not specified, all changes from this statement and any triggered SQL statements are rolled back. However, other changes in the unit of work made prior to the error are not rolled back. If `COMMIT(*NONE)` is specified, changes are not rolled back.

Number of rows inserted: After executing an `INSERT` statement, the `ROW_COUNT` statement information item in the SQL Diagnostics Area (or `SQLERRD(3)` of the `SQLCA`) is the number of rows that the database manager inserted. The `ROW_COUNT` item does not include the number of rows that were inserted as a result of a trigger.

For a description of `ROW_COUNT`, see [“GET DIAGNOSTICS” on page 1324](#). For a description of the `SQLCA`, see [Appendix C, “SQLCA \(SQL communication area\),” on page 1657](#).

Locking: If `COMMIT(*RR)`, `COMMIT(*ALL)`, `COMMIT(*CS)`, or `COMMIT(*CHG)` is specified, one or more exclusive locks are acquired during the execution of a successful `INSERT` statement. Until the locks are released by a commit or rollback operation, an inserted row can only be accessed by:

- The application process that performed the insert
- Another application process using COMMIT(*NONE) or COMMIT(*CHG) through a read-only operation

The locks can prevent other application processes from performing operations on the table. For further information about locking, see the description of the [“COMMIT” on page 940](#), [“ROLLBACK” on page 1475](#), and [“LOCK TABLE” on page 1408](#) statements. Also, see [“Isolation level” on page 23](#) and [Database Programming](#).

If the INSERT is used as a *data-change-table-reference* where FINAL TABLE is specified, locks are placed on inserted rows until the SELECT is complete. These locks may prevent indirect changes to the inserted rows from within the same job, such as an AFTER TRIGGER attempting to change an inserted row. These locks are acquired for all isolation levels, including COMMIT(*NONE).

A maximum of 500 000 000 rows can be inserted or changed in any single INSERT statement when COMMIT(*RR), COMMIT(*ALL), COMMIT(*CS), or COMMIT(*CHG) was specified. The number of rows changed includes any rows inserted, updated, or deleted under the same commitment definition as a result of a trigger.

Generated columns: A generated column that is defined as GENERATED ALWAYS should not be specified in the *column-list* unless the corresponding entry in the VALUES list is DEFAULT. The user can specify the OVERRIDING USER VALUE clause to indicate that any user-specified value will be ignored and the system-generated value at the time of the INSERT will be inserted into this column.

Inserting into tables with row-begin, row-end, or transaction start-ID columns: When a row is inserted into a table with these generated columns (for instance, a system-period temporal table), the database manager assigns values to the following columns:

- A row-begin column is assigned a value that is generated using a reading of the time-of-day clock during execution of the first data change statement in the transaction that requires a value to be assigned to the row-begin or transaction start-ID column in a table, or a row in a system-period temporal table is deleted. The database manager ensures uniqueness of the generated values for a row-begin column across transactions. If multiple rows are inserted within a single SQL transaction, the values for the row-begin column are the same for all the rows and are unique from the values generated for the column for another transaction.
- A row-end column is assigned the maximum value for the column (9999-12-30-00.00.00.000000000000).
- A transaction start-ID column is assigned a unique timestamp value per transaction or the null value. The null value is assigned to the transaction start-ID column if the column is nullable. Otherwise, the value is generated using a reading of the time-of-day clock during execution of the first data change statement in the transaction that requires a value to be assigned to the row-begin or transaction start-ID column in a table, or a row in a system-period temporal table is deleted. If multiple rows are inserted within a single SQL transaction, the values for the transaction start-ID column are the same for all the rows and are unique from the values generated for the column for another transaction.

Inserting into a system-period temporal table: When a row is inserted into a system-period temporal table, the database manager assigns values to columns as indicated for tables with row-begin, row-end, or transaction start-ID columns. Also, when a row is inserted, no rows are added to the history table associated with the system-period temporal table.

If the CURRENT TEMPORAL SYSTEM_TIME special register is set to a non-null value and the value of the SYSTIME option is YES, the underlying target of the INSERT statement cannot be a system-period temporal table. This restriction applies regardless of whether the system-period temporal table is directly or indirectly referenced.

REXX: Variables cannot be used in the INSERT statement within a REXX procedure. Instead, the INSERT must be the object of a PREPARE and EXECUTE using parameter markers.

Syntax alternatives: The following keywords are synonyms supported for compatibility to prior releases. These keywords are non-standard and should not be used:

- The keyword NONE can be used as a synonym for NC.
- The keyword CHG can be used as a synonym for UR.

- The keyword ALL can be used as a synonym for RS.

Examples

Example 1: Insert a new department with the following specifications into the DEPARTMENT table:

- Department number (DEPTNO) is 'E31'
- Department name (DEPTNAME) is 'ARCHITECTURE'
- Managed by (MGRNO) a person with number '00390'
- Reports to (ADMRDEPT) department 'E01'.

```
INSERT INTO DEPARTMENT
VALUES ('E31', 'ARCHITECTURE', '00390', 'E01')
```

Example 2: Insert a new department into the DEPARTMENT table as in example 1, but do not assign a manager to the new department.

```
INSERT INTO DEPARTMENT (DEPTNO, DEPTNAME, ADMRDEPT)
VALUES ('E31', 'ARCHITECTURE', 'E01')
```

Example 3: Create a table MA_EMPPROJACT with the same columns as the EMPPROJACT table. Populate MA_EMPPROJACT with the rows from the EMPPROJACT table with a project number (PROJNO) starting with the letters 'MA'.

```
CREATE TABLE MA_EMPPROJACT LIKE EMPPROJACT

INSERT INTO MA_EMPPROJACT
SELECT * FROM EMPPROJACT
WHERE SUBSTR(PROJNO, 1, 2) = 'MA'
```

Example 4: Use a Java program statement to add a skeleton project to the PROJECT table on the connection context 'ctx'. Obtain the project number (PROJNO), project name (PROJNAME), department number (DEPTNO), and responsible employee (RESPEMP) from host variables. Use the current date as the project start date (PRSTDATE). Assign a NULL value to the remaining columns in the table.

```
#sql [ctx] { INSERT INTO PROJECT (PROJNO, PROJNAME, DEPTNO, RESPEMP, PRSTDATE)
VALUES (:PRJNO, :PRJNM, :DPTNO, :REMP, CURRENT DATE) };
```

Example 5: Insert two new departments using one statement into the DEPARTMENT table as in example 2, but do not assign a manager to the new departments.

```
INSERT INTO DEPARTMENT (DEPTNO, DEPTNAME, ADMRDEPT)
VALUES ('B11', 'PURCHASING', 'B01'),
('E41', 'DATABASE ADMINISTRATION', 'E01')
```

Example 6: In a PL/I program, use a multiple-row INSERT to add 10 rows to table DEPARTMENT. The host structure array DEPT contains the data to be inserted.

```
DCL 1 DEPT(10),
3 DEPT CHAR(3),
3 LASTNAME CHAR(29) VARYING,
3 WORKDEPT CHAR(6),
3 JOB CHAR(3);

EXEC SQL INSERT INTO DEPARTMENT 10 ROWS VALUES (:DEPT);
```

Example 7: Insert a new project into the EMPPROJACT table using the Read Uncommitted (UR, CHG) option:

```
INSERT INTO EMPPROJACT
VALUES ('000140', 'PL2100', 30)
WITH CHG
```

Example 8: Specify an INSERT statement as the *data-change-table-reference* within a SELECT statement. Define an extra include column whose values are specified in the VALUES clause, which is then used as an ordering column for the inserted rows.

```
SELECT inorder, ordernum
FROM FINAL TABLE (INSERT INTO ORDERS (CUSTNO)
                   INCLUDE (INSERTNUM INTEGER)
                   VALUES (:cnum1, 1),
                           (:cnum2, 2)) InsertedOrders
ORDER BY insertnum
```

LABEL

The LABEL statement adds or replaces labels in the catalog descriptions of various database objects.

Invocation

This statement can be embedded in an application program or issued interactively. It is an executable statement that can be dynamically prepared.

Authorization

To label a table, view, alias, column, type, package, sequence, view, or XSR object, the privileges held by the authorization ID of the statement must include at least one of the following:

- For the table, view, alias, type, package, sequence, variable, XSR object, function or procedure identified in the statement,
 - The ALTER privilege on the table, view, alias, type, package, sequence, variable, XSR object, function or procedure, and
 - The USAGE privilege on the schema containing the table, view, alias, type, package, sequence, variable, XSR object, function or procedure
- Database administrator authority

To label a constraint or trigger, the privileges held by the authorization ID of the statement must include at least one of the following:

- For the subject table of the constraint or trigger in the statement:
 - The ALTER privilege on the subject table, and
 - The USAGE privilege on the schema that contains the subject table
- Database administrator authority

To label an index, the privileges held by the authorization ID of the statement must include at least one of the following:

- For the index identified in the statement,
 - The system authority *OBJALTER on the index, and
 - The USAGE privilege on the schema containing the index.
- Database administrator authority

To label a function, the privileges held by the authorization ID of the statement must include at least one of the following:

- For the SYSPROCS and SYSROUTINES catalog view and table:
 - The UPDATE privilege on SYSROUTINES,
 - The system authority *OBJOPR on SYSPROCS, and
 - The USAGE privilege on schema QSYS2
- Database administrator authority

To label a procedure, the privileges held by the authorization ID of the statement must include at least one of the following:

- For the SYSPROCS and SYSROUTINES catalog view and table:
 - The UPDATE privilege on SYSROUTINES,
 - The system authority *OBJOPR on SYSPROCS, and
 - The USAGE privilege on schema QSYS2
- Database administrator authority

To label a mask or permission:

- The authorization ID of the statement must have security administrator authority. See [“Administrative authority”](#) on page 15.

To label a sequence, the privileges held by the authorization ID of the statement must also include at least one of the following:

- *USE authority to the Change Data Area (CHGDTAARA) CL command
- Database administrator authority

The authorization ID of the statement has the ALTER privilege on an alias when:

- It is the owner of the alias, or
- It has been granted the system authorities of either *OBJALTER or *OBJMGT to the alias

To label a variable, the privileges held by the authorization ID of the statement must also include at least one of the following:

- For the SYSVARIABLES catalog table:
 - The UPDATE privilege on SYSVARIABLES,
 - The USAGE privilege on schema QSYS2
- Database administrator authority

To label an XSR object, the privileges held by the authorization ID of the statement must also include at least one of the following:

- For the XSROBJECTS catalog table:
 - The UPDATE privilege on XSROBJECTS,
 - The USAGE privilege on schema QSYS2
- Database administrator authority

For information about the system authorities corresponding to SQL privileges, see [Corresponding System Authorities When Checking Privileges to a Table or View](#), [Corresponding System Authorities When Checking Privileges to a Sequence](#), and [Corresponding System Authorities When Checking Privileges to a Package](#).

Syntax

▶ LABEL — ON →

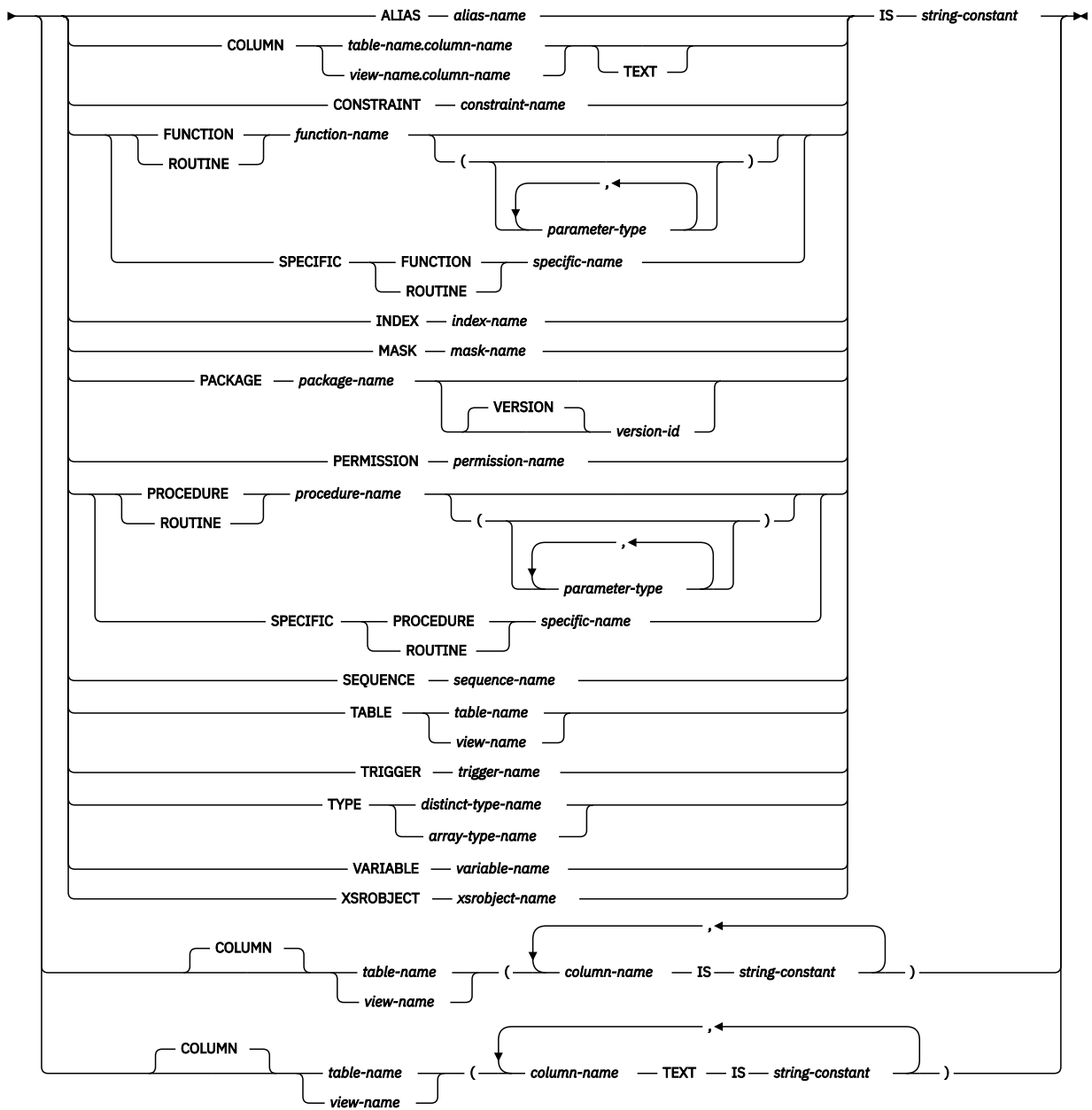

parameter-type

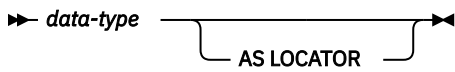

data-type

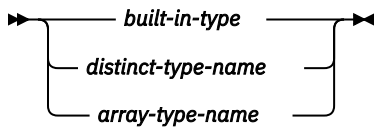

built-in-type

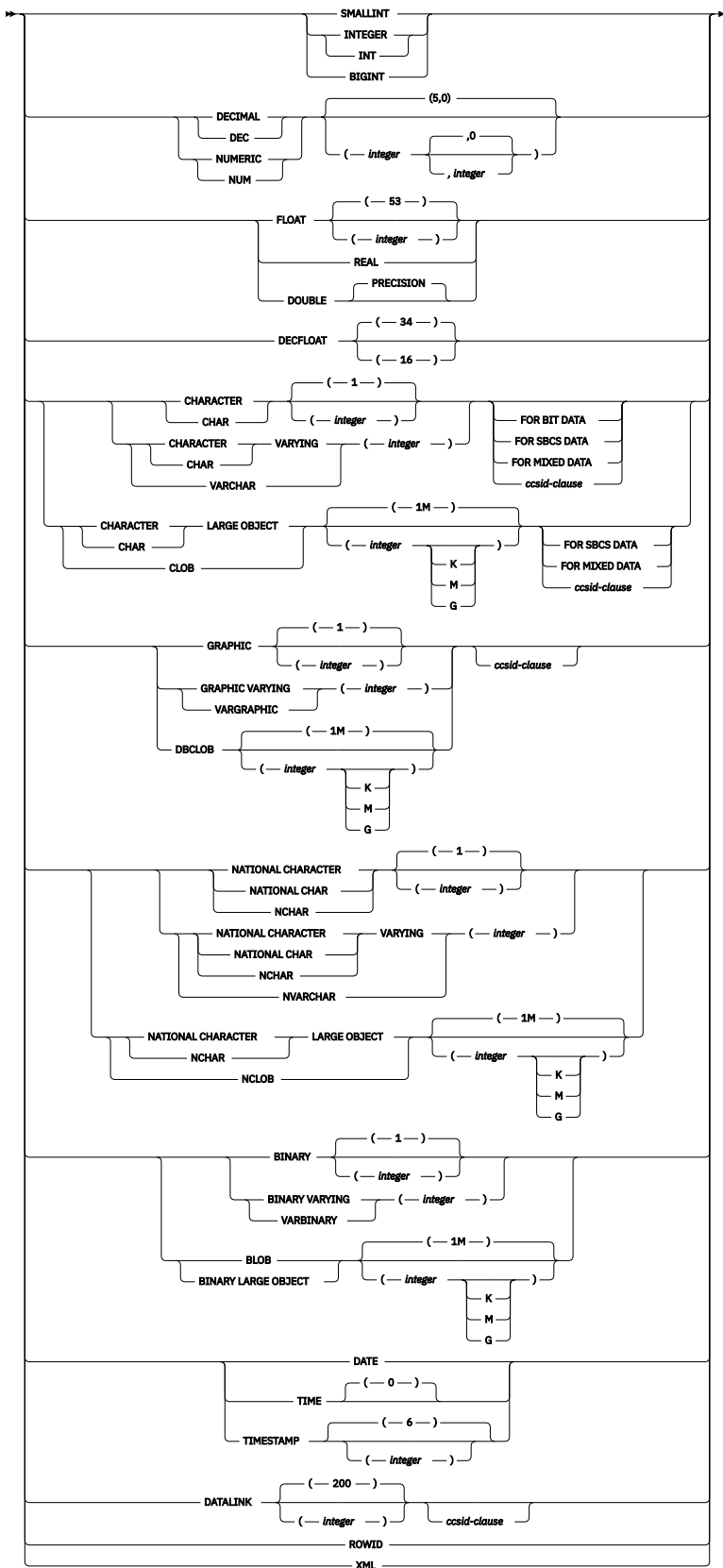

ccsid-clause

➤ CCSID — *integer* ➤

Description

ALIAS

Specifies that the label is for an alias. Labels on aliases are implemented as system object text.

alias-name

Identifies the alias to which the label applies. The name must identify an alias that exists at the current server.

COLUMN

Specifies that the label is for a column. Labels on columns are implemented as system column headings or column text. Column headings are used when displaying or printing query results.

table-name.column-name or *view-name.column-name*

Identifies the column to which the label applies. The *table-name* or *view-name* must identify a table or view that exists at the current server, but must not identify a declared temporary table. The *column-name* must identify a column of that table or view.

TEXT

Specifies that IBM i column text is specified. If TEXT is omitted, a column heading is specified.

CONSTRAINT

Specifies that the label is for a constraint.

constraint-name

Identifies the constraint to which the label applies. The *constraint-name* must identify a constraint that exists at the current server.

FUNCTION or SPECIFIC FUNCTION

Identifies the function on which the label applies. The function must exist at the current server and it must be a user-defined function. The function can be identified by its name, function signature, or specific name.

FUNCTION *function-name*

Identifies the function by its name. The *function-name* must identify exactly one function. The function may have any number of parameters defined for it. If there is more than one function of the specified name in the specified or implicit schema, an error is returned.

FUNCTION *function-name (parameter-type, ...)*

Identifies the function by its function signature, which uniquely identifies the function. The *function-name (parameter-type, ...)* must identify a function with the specified function signature. The specified parameters must match the data types in the corresponding position that were specified when the function was created. The number of data types, and the logical concatenation of the data types is used to identify the specific function instance on which to label. Synonyms for data types are considered a match. Parameters that have defaults must be included in this signature.

If *function-name ()* is specified, the function identified must have zero parameters.

function-name

Identifies the name of the function.

(parameter-type, ...)

Identifies the parameters of the function.

If an unqualified distinct type name is specified, the database manager searches the SQL path to resolve the schema name for the distinct type.

For data types that have a length, precision, or scale attribute, use one of the following:

- Empty parentheses indicate that the database manager ignores the attribute when determining whether the data types match. For example, DEC() will be considered a match for a parameter of a function defined with a data type of DEC(7,2). However, FLOAT cannot be specified with empty parenthesis because its parameter value indicates a specific data type (REAL or DOUBLE).

- If a specific value for a length, precision, or scale attribute is specified, the value must exactly match the value that was specified (implicitly or explicitly) in the CREATE FUNCTION statement. If the data type is FLOAT, the precision does not have to exactly match the value that was specified because matching is based on the data type (REAL or DOUBLE).
- If length, precision, or scale is not explicitly specified, and empty parentheses are not specified, the default attributes of the data type are implied. The implicit length must exactly match the value that was specified (implicitly or explicitly) in the CREATE FUNCTION statement.

Specifying the FOR DATA clause or CCSID clause is optional. Omission of either clause indicates that the database manager ignores the attribute when determining whether the data types match. If either clause is specified, it must match the value that was implicitly or explicitly specified in the CREATE FUNCTION statement.

AS LOCATOR

Specifies that the function is defined to receive a locator for this parameter. If AS LOCATOR is specified, the data type must be a LOB or XML or a distinct type based on a LOB or XML. If AS LOCATOR is specified, FOR SBCS DATA or FOR MIXED DATA must not be specified.

SPECIFIC FUNCTION *specific-name*

Identifies the function by its specific name. The *specific-name* must identify a specific function that exists at the current server.

INDEX

Specifies that the label is for an index. Labels on indexes are implemented as system object text.

index-name

Identifies the index to which the label applies. The name must identify an index that exists at the current server.

MASK

Specifies that the label is for a mask.

mask-name

Identifies the mask to which the label applies. The name must identify a mask that exists at the current server.

PACKAGE

Specifies that the label is for a package. Labels on packages are implemented as system object text.

package-name

Identifies the package to which the label applies. The name must identify a package that exists at the current server.

VERSION *version-id*

version-id is the version identifier that was assigned to the package when it was created. If *version-id* is not specified, a null string is used as the version identifier.

PERMISSION

Specifies that the label is for a permission.

permission-name

Identifies the permission to which the label applies. The name must identify a permission that exists at the current server.

PROCEDURE or SPECIFIC PROCEDURE

Identifies the procedure to which the label applies. The *procedure-name* must identify a procedure that exists at the current server.

PROCEDURE *procedure-name*

Identifies the procedure by its name. The *procedure-name* must identify exactly one procedure. The procedure may have any number of parameters defined for it. If there is more than one procedure of the specified name in the specified or implicit schema, an error is returned.

PROCEDURE *procedure-name (parameter-type, ...)*

Identifies the procedure by its procedure signature, which uniquely identifies the procedure. The *procedure-name (parameter-type, ...)* must identify a procedure with the specified procedure signature. The specified parameters must match the data types in the corresponding position that were specified when the procedure was created. The number of data types, and the logical concatenation of the data types is used to identify the specific procedure instance which is to be labeled on. Synonyms for data types are considered a match. Parameters that have defaults must be included in this signature.

If *procedure-name ()* is specified, the procedure identified must have zero parameters.

procedure-name

Identifies the name of the procedure.

(parameter-type, ...)

Identifies the parameters of the procedure.

If an unqualified distinct type or array type name is specified, the database manager searches the SQL path to resolve the schema name for the distinct type or array type.

For data types that have a length, precision, or scale attribute, use one of the following:

- Empty parentheses indicate that the database manager ignores the attribute when determining whether the data types match. For example, DEC() will be considered a match for a parameter of a procedure defined with a data type of DEC(7,2). However, FLOAT cannot be specified with empty parenthesis because its parameter value indicates a specific data type (REAL or DOUBLE).
- If a specific value for a length, precision, or scale attribute is specified, the value must exactly match the value that was specified (implicitly or explicitly) in the CREATE PROCEDURE statement. If the data type is FLOAT, the precision does not have to exactly match the value that was specified because matching is based on the data type (REAL or DOUBLE).
- If length, precision, or scale is not explicitly specified, and empty parentheses are not specified, the default attributes of the data type are implied. The implicit length must exactly match the value that was specified (implicitly or explicitly) in the CREATE PROCEDURE statement.

Specifying the FOR DATA clause or CCSID clause is optional. Omission of either clause indicates that the database manager ignores the attribute when determining whether the data types match. If either clause is specified, it must match the value that was implicitly or explicitly specified in the CREATE PROCEDURE statement.

AS LOCATOR

Specifies that the procedure is defined to receive a locator for this parameter. If AS LOCATOR is specified, the data type must be a LOB or XML or a distinct type based on a LOB or XML. If AS LOCATOR is specified, FOR SBCS DATA or FOR MIXED DATA must not be specified.

SPECIFIC PROCEDURE *specific-name*

Identifies the procedure by its specific name. The *specific-name* must identify a specific procedure that exists at the current server.

SEQUENCE

Specifies that the label is for a sequence. Labels on sequences are implemented as system object text.

sequence-name

Identifies the sequence on which you want to add a label. The *sequence-name* must identify a sequence that exists at the current server.

TABLE

Specifies that the label is for a table or a view. Labels on tables or views are implemented as system object text.

table-name or view-name

Identifies the table or view on which you want to add a label. The *table-name* or *view-name* must identify a table or view that exists at the current server, but must not identify a declared temporary table.

TRIGGER

Specifies that the label is for a trigger.

trigger-name

Identifies the trigger on which you want to add a label. The *trigger-name* must identify a trigger that exists at the current server.

TYPE *distinct-type-name or array-type-name*

Identifies the distinct type or array type to which the label applies. The *distinct-type-name* or *array-type-name* must identify a type that exists at the current server.

VARIABLE *variable-name*

Identifies the variable to which the label applies. The *variable-name* must identify a variable that exists at the current server.

XSRBJECT *xsubject-name*

Identifies the XSR object to which the label applies. The *xsubject-name* must identify an XSR object that exists at the current server.

IS

Introduces the label you want to provide.

string-constant

Can be any SQL character-string constant of up to either 60 bytes in length for column headings or 50 bytes in length for object text or column text. The constant may contain single-byte and double-byte characters.

The label for a column heading consists of three 20-byte segments. Interactive SQL, the Query for IBM i, IBM Db2 Query Manager and SQL Development Kit for i, and other products can display or print each 20-byte segment on a separate line. If the label for a column contains mixed data, each 20-byte segment must be a valid mixed data character string. The shift characters must be paired within each 20-byte segment.

Notes

Column headings: Column headings are used when displaying or printing query results. The first column heading is displayed or printed on the first line, the second column heading is displayed or printed on the second line, and the third column heading is displayed or printed on the third line. The column headings can be up to 60 bytes in length, where the first 20 bytes is the first column heading, the second 20 bytes is the second column heading, and the third 20 bytes is the third column heading. Blanks are trimmed from the end of each 20-byte column heading.

All 60 bytes of column heading information are available in the catalog view SYSCOLUMNS; however, only the first column heading is returned in an SQLDA on a DESCRIBE or DESCRIBE TABLE statement.

Column text is not returned on a DESCRIBE or DESCRIBE TABLE statement. When the database manager changes the column heading information in a record format description that is shared, the change is reflected in all files sharing the format description. To find out if a file shares a format with another file, use the RCDPMT parameter on the CL command, Display Database Relations (DSPDBR).

Syntax alternatives: The following keywords are synonyms supported for compatibility to prior releases. These keywords are non-standard and should not be used:

- The keyword PROGRAM can be used as a synonym for PACKAGE.
- The keywords DATA TYPE or DISTINCT TYPE can be used as a synonym for TYPE.

Examples

Example 1: Enter a label on the DEPTNO column of table DEPARTMENT.

```
LABEL ON COLUMN DEPARTMENT.DEPTNO  
IS 'DEPARTMENT NUMBER'
```

Example 2: Enter a label on the DEPTNO column of table DEPARTMENT where the column heading is shown on two separate lines.

```
LABEL ON COLUMN DEPARTMENT.DEPTNO  
IS 'Department          Number'
```

Example 3: Enter a label on the PAYROLL package.

```
LABEL ON PACKAGE PAYROLL  
IS 'Payroll Package'
```

LOCK TABLE

The LOCK TABLE statement either prevents concurrent application processes from changing a table or prevents concurrent application processes from using a table.

Invocation

This statement can be embedded in an application program or issued interactively. It is an executable statement that can be dynamically prepared.

Authorization

The privileges held by the authorization ID of the statement must include at least one of the following:

- For the table identified in the statement,
 - The system authority of *OBJOPR on the table, and
 - The USAGE privilege on the schema containing the table
- Database administrator authority

Syntax

```
➤ LOCK TABLE — table-name — IN { SHARE MODE | EXCLUSIVE MODE ALLOW READ | EXCLUSIVE MODE } ➤
```

Description

table-name

Identifies the table to be locked. The table-name must identify a base table that exists at the current server, but must not identify a catalog table or a declared temporary table.

IN SHARE MODE

Prevents concurrent application processes from executing any but read-only operations on the table.

A shared lock (*SHRNUP) is acquired for the application process in which the statement is executed. Other application processes may also acquire a shared lock (*SHRNUP) and prevent this application process from executing any but read-only operations.

IN EXCLUSIVE MODE ALLOW READ

Prevents concurrent application processes from executing any but read-only operations on the table.

An exclusive allow read lock (*EXCLRD) is acquired for the application process in which the statement is executed. Other application processes may not acquire a shared lock (*SHRNUP) and cannot prevent this application process from executing updates, deletes, and inserts on the table.

IN EXCLUSIVE MODE

Prevents concurrent application processes from executing any operations at all on the table.

An exclusive lock (*EXCL) is acquired for the application process in which the statement is executed.

Notes

Locks obtained: Locking is used to prevent concurrent operations.

The lock is released:

- When the unit of work ends, unless the unit of work is ended by a COMMIT HOLD or ROLLBACK HOLD
- When the first SQL program in the program stack ends, unless CLOSQLCSR(*ENDJOB) or CLOSQLCSR(*ENDACTGRP) was specified on the CRTSQLxxx command

- When the activation group ends
- When the connection is changed using a CONNECT (Type 1) statement
- When the connection associated with the lock is disconnected using the DISCONNECT statement
- When the connection is in the release-pending state and a successful COMMIT occurs

You may also issue the Deallocate Object (DLCOBJ) command to unlock the table.

Lock wait time: Conflicting locks already held by other application processes will cause your application to wait up to the default wait time of the job.

Example

Obtain a lock on the DEPARTMENT table.

```
LOCK TABLE DEPARTMENT IN EXCLUSIVE MODE
```

MERGE

The MERGE statement updates a target (a table or view) using data from a source (result of a table reference). Rows in the target that match the input data may be updated or deleted as specified, and rows that do not exist in the target may be inserted as specified. Updating, deleting, or inserting a row in a view updates, deletes, or inserts the row into the tables on which the view is based if no INSTEAD OF trigger is defined on the view.

Invocation

This statement can be embedded in an application program or issued interactively. It is an executable statement that can be dynamically prepared. It is not allowed in a REXX procedure.

Authorization

The privileges held by the authorization ID of the statement must include at least one of the following:

- Database administrator authority
- If an insert operation is specified:
 - The INSERT privilege on the table or view, and
 - The USAGE privilege on the schema containing the table or view
- If a delete operation is specified:
 - The DELETE privilege on the table or view, and
 - The USAGE privilege on the schema containing the table or view
- If an update operation is specified:
 - The UPDATE privilege on the table or view or
 - The UPDATE privilege on each column to be updated; and
 - The USAGE privilege on the schema containing the table or view

If *search-condition*, *insert-operation*, or *assignment-clause* includes a fullselect, the privileges held by the authorization ID of the statement must also include at least one of the following:

- For each table or view identified in the *fullselect*:
 - The SELECT privilege on the table or view, and
 - The USAGE privilege on the schema containing the table or view
- Database administrator authority

If *table-reference* contains any query that references a column of a table or view, the privileges held by the authorization ID of the statement must also include at least one of the following:

- For each table or view identified in the *fullselect*:
 - The SELECT privilege on the table or view, and
 - The USAGE privilege on the schema containing the table or view
- Database administrator authority

For information about the system authorities corresponding to SQL privileges, see [Corresponding System Authorities When Checking Privileges to a Table or View](#).

Syntax

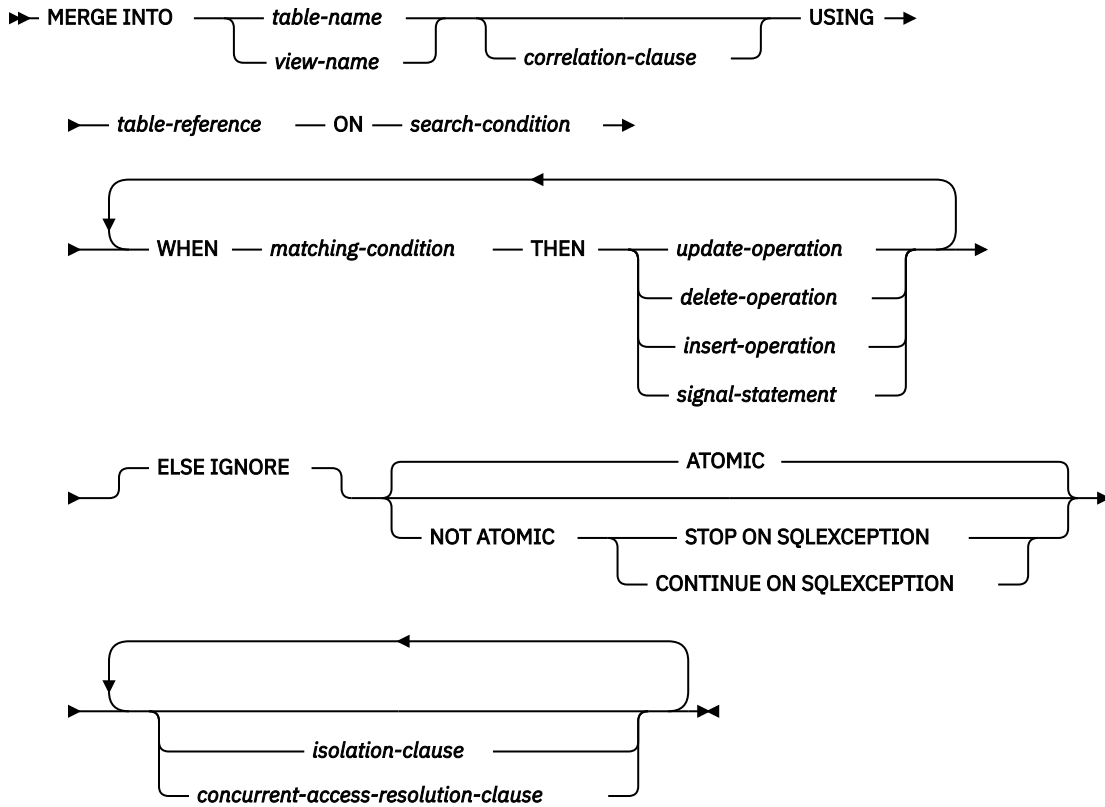

correlation-clause

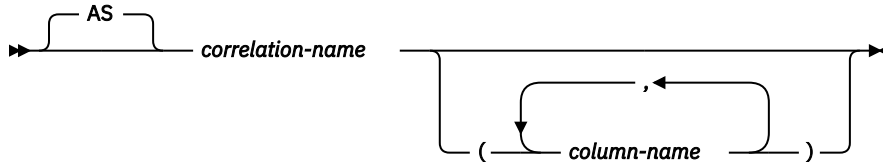

matching-condition



update-operation

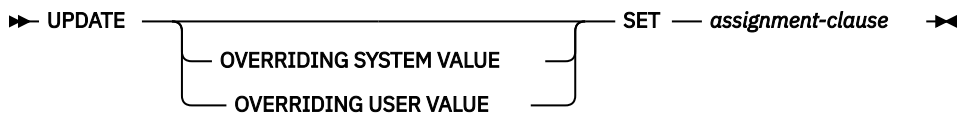

delete-operation

DELETE

insert-operation

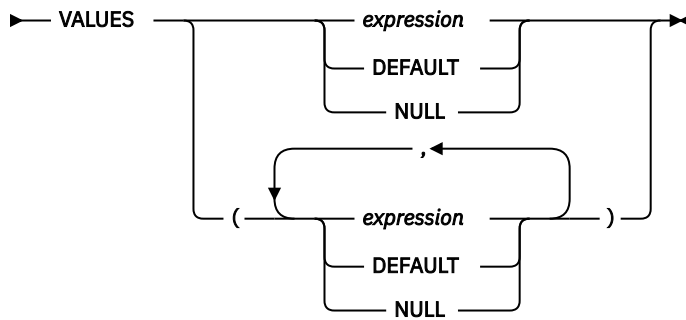

assignment-clause

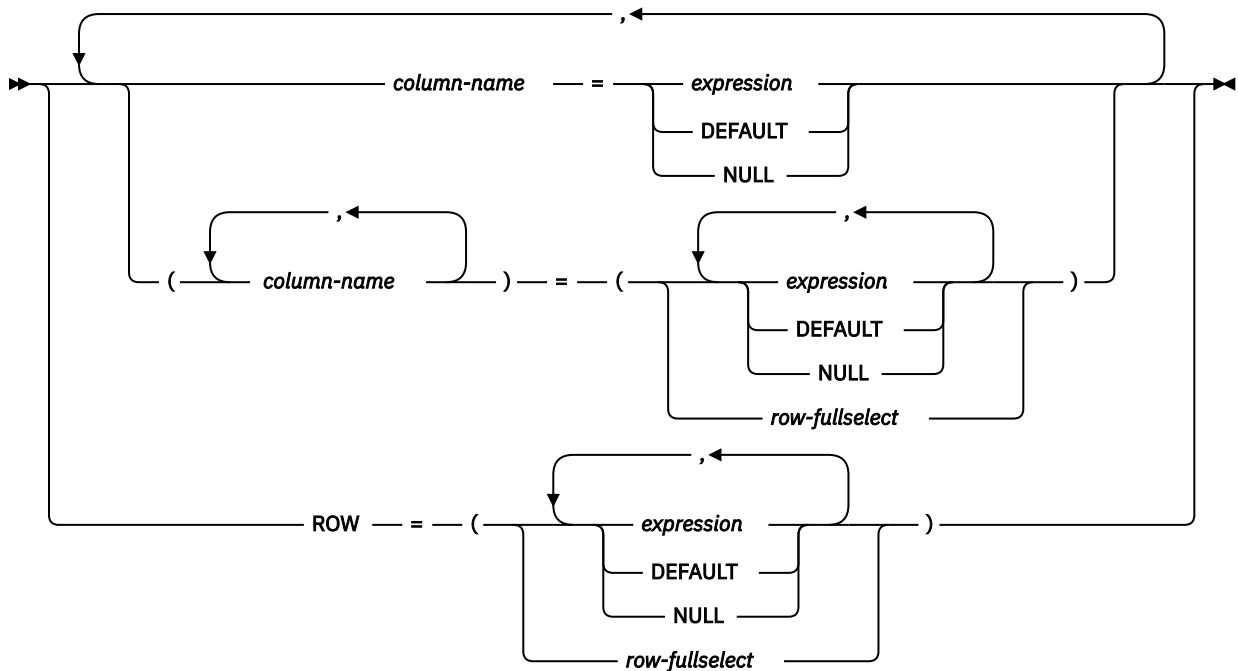

isolation-clause

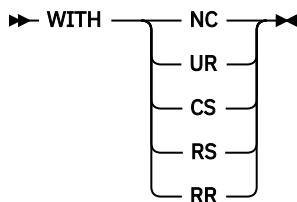

Description

table-name or view-name

Identifies the target of the update, insert, and delete operations of the merge. The name must identify a table or view that exists at the current server, but it must not identify a catalog table, a view of a catalog table, a read-only view, or a non-deletable view independent of any INSTEAD OF triggers defined for it. If *table-name* identifies a history table, no update or insert operations can be specified for the MERGE statement.

AS correlation-name

Can be used within *search-condition*, *matching-condition*, or on the right side of an *assignment-clause* to designate the target table or view. The *correlation-name* is used to qualify references to the columns of the table or view. When a *correlation-name* is specified, *column-names* can also be specified to give names to the columns of the *table-name* or *view-name*. If a column list is specified, there must be a name in the column list for each column in the table or view. For more information, see “Correlation names” on page 133

USING table-reference

Specifies a set of rows as a result table to be merged into the target. If the result table is empty, a warning is returned.

ON search-condition

Specifies the predicates used to determine whether a row from *source-table* matches rows in the target table.

Each *column-name* in the *search-condition*, other than in a subquery, must name a column of the target table or view or the *table-reference*. When the search condition includes a subquery in which the same table is the base object of both the merge and the subquery, the subquery is completely evaluated before any rows are updated or inserted.

Logically, a right join is performed between the target table and the *table-reference* using the ON *search-condition*. For those rows of the join result table where the search condition is true, the specified update or delete operation is performed. For those rows of the join result table where the search condition is not true, the specified insert operation is performed.

The search-condition cannot contain a quantified subquery, IN predicate with a subselect, or EXISTS subquery. It can contain basic predicate subqueries or scalar-fullselects. It cannot contain expressions that use aggregate functions or non-deterministic scalar functions.

WHEN matching-condition

Specifies the condition under which the *update-operation*, *delete-operation*, *insert-operation*, or the *signal-statement* is executed. Each *matching-condition* is evaluated in order of specification. Rows for which the *matching-condition* evaluates to true are not considered in subsequent matching conditions.

MATCHED

Indicates the operation to be performed on the rows where the ON *search-condition* is true. Only UPDATE, DELETE, or *signal-statement* can be specified after THEN.

AND search-condition

Specifies a further search condition to be applied against the rows that matched the ON search condition for the operation to be performed after THEN.

The *search-condition* must not include a subquery in an EXISTS or IN predicate.

NOT MATCHED

Indicates the operation to be performed on the rows where the ON *search-condition* is false or unknown. Only INSERT or *signal-statement* can be specified after THEN.

AND search-condition

Specifies a further search condition to be applied against the rows that did not match the ON search condition for the operation to be performed after THEN.

The *search-condition* must not include a subquery in an EXISTS or IN predicate.

THEN

Specifies the operation to execute when the *matching-condition* evaluates to true.

update-operation

Specifies the update operation to be executed for the rows where the *matching-condition* evaluates to true.

assignment-clause

Specifies a list of column updates.

column-name

Identifies a column to be updated. The *column-name* must identify a column of the target table or view. The *column-name* must not identify a view column derived from a scalar function, constant, or expression. A column name must not be specified more than once.

A view column derived from the same column as another column of the view can be updated, but both columns cannot be updated in the same MERGE statement.

ROW

Identifies all the columns of the target table or view except for columns defined with the hidden attribute. If a view is specified, none of the columns of the view may be derived from a scalar function, constant, or expression.

The number of expressions, NULLs, and DEFAULTs (or the number of result columns from a *row-fullselect*) must match the number of columns in the row.

ROW may not be specified for a view that contains a view column derived from the same column as another column of the view, because both columns cannot be updated in the same UPDATE.

expression

Indicates the new value of the column. The expression must not include an aggregate function except when it occurs within a scalar fullselect.

The expression can contain references to columns of the target *table-name* or *view-name*. For each row that is updated, the value of a target column reference in an expression is the value of the column in the row before the row is updated.

If *expression* is a reference to a single column of the source table, the source table column value may have been specified with an extended indicator value. The effects of extended indicator values apply to the corresponding target columns of the *assignment-clause*.

When extended indicators are enabled, the extended indicator values of DEFAULT (-5) or UNASSIGNED (-7) must not be used if expression is more complex than the following references:

- A single column of the source table
- A single host variable

DEFAULT

Specifies that the default value is assigned to the column. DEFAULT can be specified only for columns that have a default value. For more information about default values, see the description of the DEFAULT clause in [“CREATE TABLE” on page 1105](#).

DEFAULT must be specified for a column that was defined as GENERATED ALWAYS unless OVERRIDING USER VALUE is specified to indicate that any user-specified value will be ignored and a unique system-generated value will be used. A valid value can be specified for a column that was defined as GENERATED BY DEFAULT.

NULL

Specifies the null value as the new value of the column. Specify NULL only for nullable columns.

delete-operation

Specifies the delete operation to be executed for the rows where the *matching-condition* evaluates to true.

insert-operation

Specifies the insert operation to be executed for the rows where the *matching-condition* evaluates to true.

INSERT

Introduces a list of column names and row value expressions to be used for the insert operation.

The number of values in the row value expression must equal the number of names in the implicit or explicit insert column list. The first value is inserted in the first column in the list, the second value in the second column, and so on.

(column-name,...)

Specifies the columns for which insert values are provided. Each name must be a name that identifies a column of the table or view. The same column must not be identified more than once. If extended indicators are not enabled, a view column that is not updatable must not be identified. If extended indicators are not enabled and the object of the insert operation is a view with non-updatable columns, a list of column names must be specified and the list must not identify those columns. For an explanation of updatable columns in views, see [“CREATE VIEW” on page 1198](#).

Omission of the column list is an implicit specification of a list in which every column of the table or view is identified in left-to-right order. Any columns defined with the hidden attribute are omitted. This list is established when the statement is prepared and, therefore, does not include columns that were added to a table after the statement was prepared.

VALUES

Specifies a new row to be inserted.

Each variable in the clause must identify a variable that is declared in accordance with the rules for declaring variables. A host structure cannot be used. For further information about variables, see [“References to host variables” on page 140](#).

expression

An *expression* of the type described in [“Expressions” on page 159](#), that does not include an aggregate function or column name.

When extended indicators are enabled, the extended indicator values of DEFAULT (-5) or UNASSIGNED (-7) must not be used if *expression* is more complex than the following references:

- A single column of the source table
- A single host variable
- A host variable being explicitly cast

DEFAULT

Specifies that the default value is assigned to the column. DEFAULT can be specified only for columns that have a default value. For more information about default values, see the description of the DEFAULT clause in [“CREATE TABLE” on page 1105](#).

DEFAULT must be specified for a column that was defined as GENERATED ALWAYS unless OVERRIDING USER VALUE is specified to indicate that any user-specified value will be ignored and a unique system-generated value will be used. A valid value can be specified for a column that was defined as GENERATED BY DEFAULT.

NULL

Specifies the value for a column is the null value. NULL should only be specified for nullable columns.

OVERRIDING SYSTEM VALUE or OVERRIDING USER VALUE

Specifies whether system generated values or user-specified values for a ROWID, identity, or row change timestamp column are used. If OVERRIDING SYSTEM VALUE is specified, the implicit or explicit list of columns for the INSERT or the SET clause of the UPDATE must contain a ROWID, identity, or row change timestamp column defined as GENERATED ALWAYS. If OVERRIDING USER VALUE is specified, the implicit or explicit list of columns for the INSERT or the SET clause of the UPDATE must contain a column defined as either GENERATED ALWAYS or GENERATED BY DEFAULT.

OVERRIDING SYSTEM VALUE

Specifies that the value specified in the VALUES or SET clause for a column that is defined as GENERATED ALWAYS is used. A system-generated value is not used.

If a value for a row-begin, row-end, transaction-start-ID, or generated expression column is provided, it must be DEFAULT.

OVERRIDING USER VALUE

Specifies that the value specified in the VALUES or SET clause for a column that is defined as either GENERATED ALWAYS or GENERATED BY DEFAULT is ignored. Instead, a system-generated value is used, overriding the user-specified value.

If neither OVERRIDING SYSTEM VALUE nor OVERRIDING USER VALUE is specified:

- A value cannot be specified for a ROWID, identity, row change timestamp, row-begin, row-end, transaction-start-ID, or generated expression column that is defined as GENERATED ALWAYS.
- A value can be specified for a ROWID, identity, or row change timestamp column that is defined as GENERATED BY DEFAULT. If a value is specified, that value is assigned to the column. However, a value can be assigned to a ROWID column defined BY DEFAULT only if the specified value is a valid row ID value that was previously generated by Db2 for z/OS or Db2 for i. When a value is inserted or updated for an identity or row change timestamp column defined BY DEFAULT, the database manager does not verify that the specified value is a unique value for the column unless the identity or row change timestamp column is the sole key in a unique constraint or unique index. Without a unique constraint or unique index, the database manager can guarantee unique values only among the set of system-generated values as long as NO CYCLE is in effect.

If a value is not specified the database manager generates a new value.

signal-statement

Specifies the SIGNAL statement that is to be executed to return an error when the *matching-condition* evaluates to true. See [“SIGNAL” on page 1542](#).

ELSE IGNORE

Specifies that no action is to be taken when the *matching-condition* for all WHEN clauses is false for a row in the USING *table-reference*. No action is taken in this case whether or not ELSE IGNORE is specified.

ATOMIC or NOT ATOMIC

Specifies how to handle errors

ATOMIC

Specifies that if an error occurs during a *update-operation*, *delete-operation*, or *insert-operation*, the entire MERGE statement is rolled back.

NOT ATOMIC

Specifies that if an error occurs during a *update-operation*, *delete-operation*, or *insert-operation*, only that *update-operation*, *delete-operation*, or *insert-operation* is rolled back.

STOP ON SQL EXCEPTION

Specifies that if an error occurs during a *update-operation*, *delete-operation*, or *insert-operation*, the processing of the MERGE statement stops.

CONTINUE ON SQL EXCEPTION

Specifies that if an error occurs during a *update-operation*, *delete-operation*, or *insert-operation*, the processing of the MERGE statement continues.

isolation-clause

Specifies the isolation level to be used for this statement.

WITH

Introduces the isolation level, which may be one of:

- *RR* Repeatable read
- *RS* Read stability
- *CS* Cursor stability
- *UR* Uncommitted read

- *NC* No commit

If *isolation-clause* is not specified the default isolation is used. See [“isolation-clause” on page 787](#) for a description of how the default is determined.

concurrent-access-resolution-clause

Specifies the concurrent access resolution to use for the select statement. For more information, see [“concurrent-access-resolution-clause” on page 789](#).

MERGE Rules

- More than one *update-operation*, *delete-operation*, *insert-operation*, or *signal-statement* can be specified in a single MERGE statement.
- Each row in the target can only be operated on once. A row in the target can only be identified as *MATCHED* with one row in the result table of the *table-reference*. A nested SQL operation (RI or trigger except *INSTEAD OF* trigger) cannot specify the target table (or a table within the same hierarchy) as a target of an *UPDATE*, *DELETE*, *INSERT*, or *MERGE* statement.

For other rules that affect the update, insert, or delete portion of the MERGE statement, see the "Rules" section of the corresponding statement description.

Extended indicator usage: When extended indicators are enabled, indicator values other than positive values and 0 (zero) through -7 must not be set. The *DEFAULT* and *UNASSIGNED* extended indicator values must not appear in contexts where they are not supported.

Extended indicators: In an update operation of the MERGE statement:

- An extended indicator value of *UNASSIGNED* has the effect of leaving the target column set to its current value, as if it had not been specified in the statement.
- An extended indicator value of *DEFAULT* must not be specified for a *row-begin*, *row-end*, *transaction-start-ID*, or generated expression column.
- An extended indicator value of *UNASSIGNED* must not be assigned to all of the target columns.

MERGE restriction: If the target table of the MERGE statement has triggers or is the parent in a referential integrity constraint, the *update-operation* or *insert-operation* must not contain a global variable, a function, or a subselect.

Notes

Logical order of processing: For a *NOT ATOMIC MERGE* statement, each source row is processed independently as if a separate MERGE statement were executed for each source row. For example, a source row that causes an update of a target row, will fire any triggers (including statement level triggers) when the update of the row is performed. Thus, if 5 rows are updated, any update triggers (including statement level update triggers) will be fired 5 times.

For an *ATOMIC MERGE* statement, the source rows are processed as if a set of rows is processed by each *WHEN* clause. Thus, if 5 rows are updated, any row level update triggers will be fired 5 times, but *n* statement level update triggers will be fired, where *n* is the number of *WHEN* clauses that contain an *UPDATE*, including any *WHEN* clauses that contain an *UPDATE* that did not process any of the source rows. For *ATOMIC MERGE*, the logical order of processing is:

1. Determine the set of rows to be processed from the source and target. If any of the special registers *CURRENT DATE*, *CURRENT TIME*, or *CURRENT TIMESTAMP* are used in this statement, only one clock reading is done for the whole statement.
2. Use the *ON* clause to classify these rows as either *MATCHED* or *NOT MATCHED*.
3. Evaluate any *matching-condition* in the *WHEN* clauses.
4. Evaluate any expression in any *assignment-clause* and *insert-operation*.
5. Execute each *signal-statement*.
6. Apply each *update-operation*, *delete-operation*, or *insert-operation* to the applicable rows in the order of specification. The triggers activated by each *update-operation*, *delete-operation*, or *insert-operation*

are executed. Statement level triggers are activated even if no rows satisfy the *update-operation*, *delete-operation*, or *insert-operation*. Each *update-operation*, *delete-operation*, or *insert-operation* can affect the triggers of each subsequent *update-operation*, *delete-operation*, or *insert-operation*.

Number of rows updated: After executing a MERGE statement, the ROW_COUNT statement information item in the SQL Diagnostics Area (or SQLERRD(3) of the SQLCA) is the number of rows operated on by the MERGE statement, excluding rows identified by the ELSE IGNORE clause. The ROW_COUNT item and SQLERRD(3) does not include the number of rows that were operated on as a result of triggers. The value in the DB2_ROW_COUNT_SECONDARY statement information item (or SQLERRD(5) of the SQLCA) includes the number of these rows.

For a description of ROW_COUNT and DB2_ROW_COUNT_SECONDARY, see [“GET DIAGNOSTICS” on page 1324](#). For a description of the SQLCA, see [Appendix C, “SQLCA \(SQL communication area\),” on page 1657](#).

GET DIAGNOSTICS considerations: If a MERGE statement completes with one or more errors, the GET DIAGNOSTICS statement can be used after the MERGE statement to check which input row(s) failed. The GET DIAGNOSTICS *statement-information-item*, NUMBER, indicates the number of conditions (errors or warnings) detected by execution of the MERGE statement. For each condition, the GET DIAGNOSTICS *condition-information-item*, DB2_ROW_NUMBER, indicates the input source row that caused an error.

Inserted row cannot also be updated: No attempt is made to update a row in the target that did not already exist before the MERGE statement was executed; that is, there are no updates of rows that were inserted by the MERGE statement.

Concurrent row changes in MERGE target: MERGE processing determines affected rows in the MERGE target before performing any *update-operations*, *delete-operations*, or *insert-operations*. Unless using a restrictive isolation level such as repeatable read, concurrent processes could insert or modify rows in the MERGE target between the time when the set of affected target rows is determined and when a specific row *update-operation*, *delete-operation*, or *insert-operation* is processed. Such concurrent activity could produce an error. For example, MERGE processing could determine that a source row does not exist in the target where a column value in the target has a unique key constraint. Before the MERGE attempts to insert a new row based on the source data, a concurrent process could insert a row with the same key value. This would cause a duplicate key error when the MERGE processing attempts to insert its row.

Locking: If COMMIT(*RR), COMMIT(*ALL), COMMIT(*CS), or COMMIT(*CHG) is specified, one or more exclusive locks are acquired during the execution of a successful MERGE statement. Until the locks are released by a commit or rollback operation, an inserted or updated row can only be accessed by:

- The application process that performed the insert or update
- Another application process using COMMIT(*NONE) or COMMIT(*CHG) through a read-only operation

The locks can prevent other application processes from performing operations on the table. For further information about locking, see the description of the [“COMMIT” on page 940](#), [“ROLLBACK” on page 1475](#), and [“LOCK TABLE” on page 1408](#) statements. Also, see [“Isolation level” on page 23](#) and [Database Programming](#).

A maximum of 500 000 000 rows can be acquired in any single MERGE statement when COMMIT(*RR), COMMIT(*ALL), COMMIT(*CS), or COMMIT(*CHG) was specified. The number of row locks includes any rows inserted, updated, or deleted in the MERGE target and any rows inserted, updated, or deleted under the same commitment definition as a result of a trigger. The number of row locks also includes source rows referenced by the USING *table-reference* if COMMIT(*ALL) is specified.

Tables with active row and column access controls: For information about how enabled row permissions and column masks affect the update and insert operations in the MERGE statement, see the INSERT and UPDATE statement information.

NOT ATOMIC processing: When NOT ATOMIC is specified, the rows of source data are processed separately. Any reference to special registers (such as CURRENT TIMESTAMP) in the MERGE statement are evaluated as each row or source data is processed. Statement level triggers are activated as each row of source data is processed.

If an error occurs during the operation for a row of source data, the row being processed at the time of the error is not inserted, updated, or deleted. Processing of an individual row is an atomic operation. Any other changes previously made during the processing of the MERGE statement are not rolled back. If CONTINUE ON EXCEPTION is specified, execution continues with the next row to be processed.

System-period temporal tables: When a MERGE statement is processed for a system-period temporal table, the rows are affected in the same way as if the specific data change operation was invoked.

Examples

Example 1: For activities whose description has changed, update the description in the archive table. For new activities, insert into the archive table. The archive and activities tables both have activity as a primary key.

```
MERGE INTO archive ar
  USING (SELECT activity, description FROM activities) ac
  ON (ar.activity = ac.activity)
  WHEN MATCHED THEN
    UPDATE SET description = ac.description
  WHEN NOT MATCHED THEN
    INSERT (activity, description) VALUES(ac.activity, ac.description)
```

Example 2: Using the shipment table, merge rows into the inventory table, increasing the quantity by part count in the shipment table for rows that match; else insert the new partno into the inventory table.

```
MERGE INTO inventory AS in
  USING (SELECT partno, description, count FROM shipment
        WHERE shipment.partno IS NOT NULL) AS sh
  ON (in.partno = sh.partno)
  WHEN MATCHED THEN
    UPDATE SET description = sh.description,
              quantity = in.quantity + sh.count
  WHEN NOT MATCHED THEN
    INSERT (partno, description, quantity)
    VALUES (sh.partno, sh.description, sh.count)
```

Example 3: Using the transaction table, merge rows into the account table, updating the balance from the set of transactions against an account ID and inserting new accounts from the consolidated transactions where they do not already exist.

```
MERGE INTO account AS a
  USING (SELECT id, SUM(amount) sum_amount FROM transaction
        GROUP BY id) AS t
  ON a.id = t.id
  WHEN MATCHED THEN
    UPDATE SET balance = a.balance + t.sum_amount
  WHEN NOT MATCHED THEN
    INSERT (id, balance) VALUES (t.id, t.sum_amount)
```

Example 4: Using the transaction_log table, merge rows into the employee_file table, updating the phone and office columns with the latest transaction_log row based on the transaction time, and inserting a new employee_file row where the row does not already exist.

```
MERGE INTO employee_file AS e
  USING (SELECT empid, phone, office
        FROM (SELECT empid, phone, office,
                    ROW_NUMBER() OVER (PARTITION BY empid
                                       ORDER BY transaction_time DESC) rn
        FROM transaction_log) AS nt
        WHERE rn = 1) AS t
  ON e.empid = t.empid
  WHEN MATCHED THEN
    UPDATE SET (phone, office) = (t.phone, t.office)
  WHEN NOT MATCHED THEN
    INSERT (empid, phone, office)
    VALUES(t.empid, t.phone, t.office)
```

Example 5: Using dynamically supplied values for an employee row, update the master employee table if the data corresponds to an existing employee, or insert the row if the data is for a new employee. The following example is a fragment of code from a C program.

```

hv1 =
"MERGE INTO employee AS t
  USING (VALUES(CAST(? AS CHAR(6)), CAST(? AS VARCHAR(12)),
               CAST(? AS CHAR(1)), CAST(? AS VARCHAR(15)),
               CAST(? AS SMALLINT), CAST(? AS INTEGER)))
    s (empno, firstnme, midinit, lastname, edlevel, salary)
  ON t.empno = s.empno
  WHEN MATCHED THEN
    UPDATE SET salary = s.salary
  WHEN NOT MATCHED THEN
    INSERT (empno, firstnme, midinit, lastname, edlevel, salary)
      VALUES (s.empno, s.firstnme, s.midinit, s.lastname, s.edlevel,
              s.salary)";
EXEC SQL PREPARE s1 FROM :hv1;
EXEC SQL EXECUTE s1 USING :hv2, :hv3, :hv4, :hv5, :hv6, :hv7;

```

Example 6: Update the list of activities organized by Group A in the archive table. Delete all outdated activities and update the activities information (description and date) in the archive table if they have been changed. For new upcoming activities, insert into the archive. Signal an error if the data of the activity is not known. The date of the activities in the archive table must be specified. Each group has an activities table. For example, activities_groupA contains all activities that they organize, and the archive table contains all upcoming activities organized by different groups in a company. The archive table has (group, activity) as the primary key, and data is not nullable. All activities tables have activity as the primary key. The last_modified column in the archive is defined with CURRENT_TIMESTAMP as the default value.

```

MERGE INTO archive ar
  USING (SELECT activity, description, date, last_modified
        FROM activities_groupA) ac
  ON (ar.activity = ac.activity) AND ar.group = 'A'
  WHEN MATCHED AND ac.date IS NULL THEN
    SIGNAL SQLSTATE '70001'
    SET MESSAGE_TEXT = 'Activity cannot be modified. Reason: date is not known'
  WHEN MATCHED and ac.date < CURRENT_DATE THEN
    DELETE
  WHEN MATCHED AND ar.last_modified < ac.last_modified THEN
    UPDATE SET (description, date, last_modified)
      = (ac.description, ac.date, DEFAULT)
  WHEN NOT MATCHED AND ac.date IS NULL THEN
    SIGNAL SQLSTATE '70002'
    SET MESSAGE_TEXT = 'Activity cannot be inserted. Reason: date is not known'

  WHEN NOT MATCHED AND ac.date >= CURRENT_DATE THEN
    INSERT (group, activity, description, date)
      VALUES ('A', ac.activity, ac.description, ac.date)
  ELSE IGNORE

```

OPEN

The OPEN statement opens a cursor so that it can be used to fetch rows from its result table.

Invocation

This statement can only be embedded in an application program. It is an executable statement that cannot be dynamically prepared. It must not be specified in Java.

Authorization

If a global variable is referenced in a statement, the privileges held by the authorization ID of the statement must include at least one of the following:

- For the global variable identified in the statement,
 - The READ privilege on the global variable, and
 - The USAGE privilege on the schema containing the global variable
- Database administrator authority

See “[DECLARE CURSOR](#)” on page 1207 for the authorization required to use a cursor.

Syntax

➤ OPEN — *cursor-name* ➔

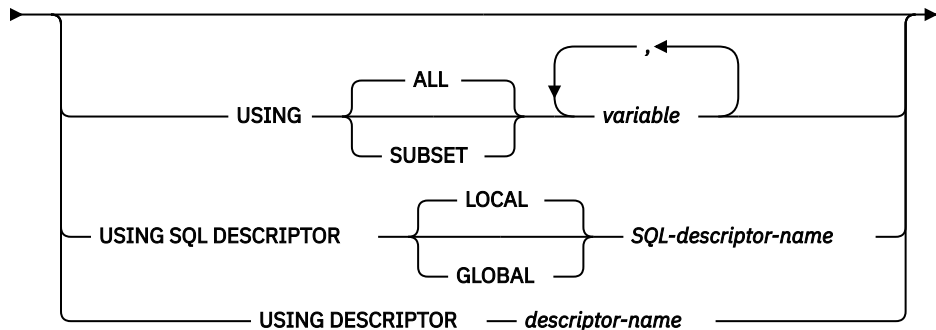

Description

cursor-name

Identifies the cursor to be opened. The *cursor-name* must identify a declared cursor as explained in the Notes for the DECLARE CURSOR statement. When the OPEN statement is executed, the cursor must be in the closed state.

The SELECT statement associated with the cursor is either:

- The *select-statement* specified in the DECLARE CURSOR statement, or
- The prepared *select-statement* identified by the *statement-name* specified in the DECLARE CURSOR statement. If the statement has not been successfully prepared, or is not a *select-statement*, the cursor cannot be successfully opened.

The result table of the cursor is derived by evaluating the SELECT statement. The evaluation uses the current values of any special registers specified in the SELECT statement and the current values of any variables specified in the SELECT statement or the USING clause of the OPEN statement. The rows of the result table can be derived during the execution of the OPEN statement and a temporary table can be created to hold them; or they can be derived during the execution of subsequent FETCH statements. In either case, the cursor is placed in the open state and positioned before the first row of its result table. If the table is empty the position of the cursor is effectively “after the last row.”

USING

Introduces a list of variables whose values are substituted for the parameter markers (question marks) of a prepared statement. For an explanation of parameter markers, see [“PREPARE” on page 1427](#).

- If a *statement-name* is specified in the DECLARE CURSOR statement that includes parameter markers, USING must be used. If the prepared statement does not include parameter markers, USING is ignored.
- If a *select-statement* is specified in the DECLARE CURSOR statement, USING may be used to override the variable values. For more information, see [Variable value override](#).

If the DECLARE CURSOR statement names a prepared statement that includes parameter markers, you must use USING. If the prepared statement does not include parameter markers, USING is ignored.

USING ALL or USING SUBSET

Identifies host structures or variables.

USING ALL

All the variables in the list are used for substitution of parameter markers in the prepared statement.

USING SUBSET

Some or all of the variables in the list are used for substitution of parameter markers in the prepared statement.

- Any host variable with an extended indicator value of UNASSIGNED will be removed from the list. The result is as if the host variable was not specified in the statement.
- All other indicator values have no special meaning to the OPEN statement.

variable,...

Identifies host structures or variables that must be declared in the program in accordance with the rules for declaring host structures and variables. A reference to a host structure is replaced by a reference to each of its variables. The resulting number of variables must be the same as the number of parameter markers in the prepared statement. The *n*th variable corresponds to the *n*th parameter marker in the prepared statement.

A global variable may only be used if the current connection is a local connection (not a DRDA connection).

USING SQL DESCRIPTOR *SQL-descriptor-name*

Identifies an SQL descriptor.

LOCAL

Specifies the scope of the name of the descriptor to be local to program invocation.

GLOBAL

Specifies the scope of the name of the descriptor to be global to the SQL session.

SQL-descriptor-name

Names the SQL descriptor. The name must identify a descriptor that already exists with the specified scope.

See [“SET DESCRIPTOR” on page 1498](#) for an explanation of the information in the SQL descriptor.

USING DESCRIPTOR *descriptor-name*

Identifies an SQLDA that must contain a valid description of input variables.

Before the OPEN statement is processed, the user must set the following fields in the SQLDA. (The rules for REXX are different. For more information see [Embedded SQL Programming](#).)

- SQLN to indicate the number of SQLVAR occurrences provided in the SQLDA
- SQLDABC to indicate the number of bytes of storage allocated for the SQLDA
- SQLD to indicate the number of variables used in the SQLDA when processing the statement

- SQLVAR occurrences to indicate the attributes of the variables

The SQLDA must have enough storage to contain all SQLVAR occurrences. If LOBs or distinct types are present in the results, there must be additional SQLVAR entries for each parameter. For more information about the SQLDA, which includes a description of the SQLVAR and an explanation on how to determine the number of SQLVAR occurrences, see [Appendix D, “SQLDA \(SQL descriptor area\),”](#) on page 1667.

SQLD must be set to a value greater than or equal to zero and less than or equal to SQLN. It must be the same as the number of parameter markers in the prepared statement. The *n*th variable described by the SQLDA corresponds to the *n*th parameter marker in the prepared statement.

Note that because RPG/400 does not provide the facility for setting pointers and the SQLDA uses pointers to locate the appropriate variables, you will have to set these pointers outside your RPG/400 application.

Notes

Closed state of cursors: All cursors in a program are in the closed state when:

- The program is called:
 - If CLOSQLCSR(*ENDPGM) is specified, all cursors are in the closed state each time the program is called.
 - If CLOSQLCSR(*ENDSQL) is specified, all cursors are in the closed state only the first time the program is called as long as one SQL program remains on the call stack.
 - If CLOSQLCSR(*ENDJOB) is specified, all cursors are in the closed state only the first time the program is called as long as the job remains active.
 - If CLOSQLCSR(*ENDMOD) is specified, all cursors are in the closed state each time the module is initiated.
 - If CLOSQLCSR(*ENDACTGRP) is specified, all cursors are in the closed state only the first time the module in the program is initiated in the activation group.
- A program starts a new unit of work by executing a COMMIT statement without a HOLD option. Cursors declared with the HOLD option are not closed by a COMMIT statement without a HOLD option. A COMMIT HOLD statement does not close cursors whether they are declared with a HOLD option or not.
- A program starts a new unit of work by executing a ROLLBACK statement without a HOLD option. A ROLLBACK HOLD statement does not close cursors whether they are declared with a HOLD option or not.
- A CONNECT (Type 1) statement was executed.

A cursor can also be in the closed state because:

- A CLOSE statement was executed.
- A DISCONNECT statement disconnected the connection with which the cursor was associated.
- The connection with which the cursor was associated was in the release-pending state and a successful COMMIT occurred.
- A CONNECT (Type 1) statement was executed.

To retrieve rows from the result table of a cursor, the FETCH statement must be executed when the cursor is open. The only way to change the state of a cursor from closed to open is to execute an OPEN statement.

Effect of temporary tables: If the result table of a cursor is not read-only, its rows are derived during the execution of subsequent FETCH statements. The same method may be used for a read-only result table. However, if a result table is read-only, Db2 for i may choose to use the temporary table method instead. With this method the entire result table is inserted into a temporary table during the execution of the OPEN statement. When a temporary table is used, the results of a program can differ in several ways:

- An error can occur during OPEN that would otherwise not occur until some later FETCH statement.

- The INSERT, UPDATE, and DELETE statements that are executed while the cursor is open cannot affect the result table.
- Any NEXT VALUE expressions in the SELECT statement are evaluated for every row of the result table during OPEN. Thus, sequence values are generated, for every row of the result table during OPEN.
- Any functions are evaluated for every row of the result table during OPEN. Thus, any external actions and SQL statements that modify SQL data within the functions are performed for every row of the result table during OPEN.

Conversely, if a temporary table is not used, INSERT, UPDATE, and DELETE statements executed while the cursor is open can affect the result table, and any NEXT VALUE expressions and functions in the SELECT statement are evaluated as each row is fetched. The effect of such operations is not always predictable. For example, if cursor CUR is positioned on a row of its result table defined as SELECT * FROM T, and a row is inserted into T, the effect of that insert on the result table is not predictable because its rows are not ordered. A subsequent FETCH CUR might or might not retrieve the new row of T.

Parameter marker replacement: When the SELECT statement of the cursor is evaluated, each parameter marker in the statement is effectively replaced by its corresponding variable. The replacement of a parameter marker is an assignment operation in which the source is the value of the variable, and the target is a variable within the database manager. For a typed parameter marker, the attributes of the target variable are those specified by the CAST specification. For an untyped parameter marker, the attributes of the target variable are determined according to the context of the parameter marker. For the rules that affect parameter markers, see [Table 115 on page 1434](#).

Let V denote a variable that corresponds to parameter marker P. The value of V is assigned to the target variable for P in accordance with the rules for assigning a value to a column. Thus:

- V must be compatible with the target.
- If V is a number, the absolute value of its integral part must not be greater than the maximum absolute value of the integral part of the target.
- If the attributes of V are not identical to the attributes of the target, the value is converted to conform to the attributes of the target.
- If the target cannot contain nulls, the value of V must not be null.

However, unlike the rules for assigning a value to a column:

- If V is a string, the value will be truncated (without an error), if its length is greater than the length attribute of the target.

When the SELECT statement of the cursor is evaluated, the value used in place of P is the value of the target variable for P. For example, if V is CHAR(6), and the target is CHAR(8), the value used in place of P is the value of V padded with two blanks.

Variable value override: The USING clause is intended for a prepared SELECT statement that contains parameter markers. However, it can also be used when the SELECT statement of the cursor is part of the DECLARE CURSOR statement. In this case, the OPEN statement is executed as if each variable in the SELECT statement were a parameter marker, except that the attributes of the target variables are the same as the attributes of the variables in the SELECT statement. The effect is to override the values of the variables in the SELECT statement of the cursor with the values of the variables specified in the USING clause.

Examples

Example 1: Write the embedded statements in a COBOL program that will:

1. Define a cursor C1 that is to be used to retrieve all rows from the DEPARTMENT table for departments that are administered by (ADMRDEPT) department 'A00'
2. Place the cursor C1 before the first row to be fetched.

```
EXEC SQL DECLARE C1 CURSOR FOR
        SELECT DEPTNO, DEPTNAME, MGRNO FROM DEPARTMENT
        WHERE ADMRDEPT = 'A00' END-EXEC.
```

```
EXEC SQL OPEN C1 END-EXEC.
```

Example 2: Code an OPEN statement to associate a cursor DYN_CURSOR with a dynamically defined *select-statement* in a C program. Assume each prepared *select-statement* always defines two items in its select list with the first item having a data type of integer and the second item having a data type of VARCHAR(64). (The related host variable definitions, PREPARE statement, and DECLARE CURSOR statement are also shown in the example below.)

```
EXEC SQL BEGIN DECLARE SECTION;
    static short hv_int;
    char hv_vchar64[64];
    char stmt1_str[200];
EXEC SQL END DECLARE SECTION;

EXEC SQL PREPARE STMT1_NAME FROM :stmt1_str;

EXEC SQL DECLARE DYN_CURSOR CURSOR FOR STMT1_NAME;

EXEC SQL OPEN DYN_CURSOR USING :hv_int, :hv_vchar64;
```

Example 3: Code an OPEN statement as in example 3, but in this case the number and data types of the items in the select statement are not known.

```
EXEC SQL BEGIN DECLARE SECTION;
    char stmt1_str[200];
EXEC SQL END DECLARE SECTION;
EXEC SQL INCLUDE SQLDA;

EXEC SQL PREPARE STMT1_NAME FROM :stmt1_str;
EXEC SQL DECLARE DYN_CURSOR CURSOR FOR STMT1_NAME;

EXEC SQL OPEN DYN_CURSOR USING DESCRIPTOR :sqlda;
```

Example 4: Code a prepared select statement from optional pieces of text, then open it with only the host variables that apply to the generated statement.

Suppose there are three host variables with corresponding indicators:

```
PRED1HV and PRED1IND, a VARCHAR(50) variable
PRED2HV and PRED2IND, a DECIMAL(10,2) variable
PRED3HV and PRED3IND, a TIMESTAMP variable
```

Build the statement based on selection conditions set by the application. Note that this is pseudocode.

```
stmt = 'SELECT * FROM MYTABLE WHERE DUEDATE > CURRENT DATE';
IF Selection1 THEN
    stmt = stmt CONCAT ' AND COL1 = ?';
    PRED1HV = <value supplied for selection1>;
    PRED1IND = 0;
ELSE
    PRED1IND = -7; /* Predicate omitted, so omit the host variable on the OPEN */
IF Selection2 THEN
    stmt = stmt CONCAT ' AND COL2 < ?';
    PRED2HV = <value supplied for selection2>;
    PRED2IND = 0;
ELSE
    PRED2IND = -7; /* Predicate omitted, so omit the host variable on the OPEN */
IF Selection3 THEN
    stmt = stmt CONCAT ' AND COL3 = ?';
    PRED3HV = <value supplied for selection3>;
    PRED3IND = 0;
ELSE
    PRED3IND = -7; /* Predicate omitted, so omit the host variable on the OPEN */

EXEC SQL DECLARE COND_CURSOR FOR SELECT1;
EXEC SQL PREPARE SELECT1 FROM :stmt;
```

The following OPEN statement can be used for any combination of generated predicates and will omit any host variables that have an indicator value of -7. The data types of the host variables must match their use in the query, so which ones to omit is important.

```
EXEC SQL OPEN COND_CURSOR USING SUBSET :PREDHV1:PREDIND1, :PREDHV2:PREDIND2, :PREDHV3:PREDIND3;
```

If PREDIND2 has a value of -7, the OPEN is logically equivalent to:

```
EXEC SQL OPEN COND_CURSOR USING :PREDHV1:PREDIND1, :PREDHV3:PREDIND3;
```

PREPARE

The PREPARE statement creates an executable form of an SQL statement from a character-string form of the statement. The character-string form is called a *statement string*, and the executable form is called a *prepared statement*.

Invocation

This statement can only be embedded in an application program, SQL function, SQL procedure, or trigger. It is an executable statement that cannot be dynamically prepared. It must not be specified in Java.

Authorization

The authorization rules are the same as those defined for the SQL statement specified by the PREPARE statement. For example, see [“select-statement” on page 777](#) for the authorization rules that apply when a SELECT statement is prepared.

If DLYPRP(*NO) is specified on the CRTSQLxxx command, the authorization checking is performed when the statement is prepared, except:

- If a DROP SCHEMA statement is prepared, privileges on all objects in the schema are not checked until the statement is executed.
- If a DROP TABLE statement is prepared, privileges on all views, indexes, and logical files that reference the table are not checked until the statement is executed.
- If a DROP VIEW statement is prepared, privileges on all views that reference the view are not checked until the statement is executed.
- If a CREATE TRIGGER statement is prepared, privileges on objects referenced in the *triggered-action* are not checked until the statement is executed.
- If a DROP, COMMENT, or LABEL of a FUNCTION, PROCEDURE, SEQUENCE, TYPE, TRIGGER, VARIABLE, or XSROBJECT statement is prepared, authorities are not checked until the statement is executed.
- If a GRANT or REVOKE statement is prepared, authorities are not checked until the statement is executed.

If DLYPRP(*YES) is specified on the CRTSQLxxx command, all authorization checking is deferred until the statement is executed or used in an OPEN statement.

The authorization ID of the statement is the run-time authorization ID unless USRPRF(*OWNER) and DYNUSRPRF(*OWNER) were specified on the CRTSQLxxx command when the program was created. For more information, see [“Authorization IDs and authorization names” on page 61](#).

If a global variable is referenced in a statement, the privileges held by the authorization ID of the statement must include at least one of the following:

- For the global variable identified in the statement,
 - The READ privilege on the global variable, and
 - The USAGE privilege on the schema containing the global variable
- Database administrator authority

Syntax

► PREPARE — *statement-name* →

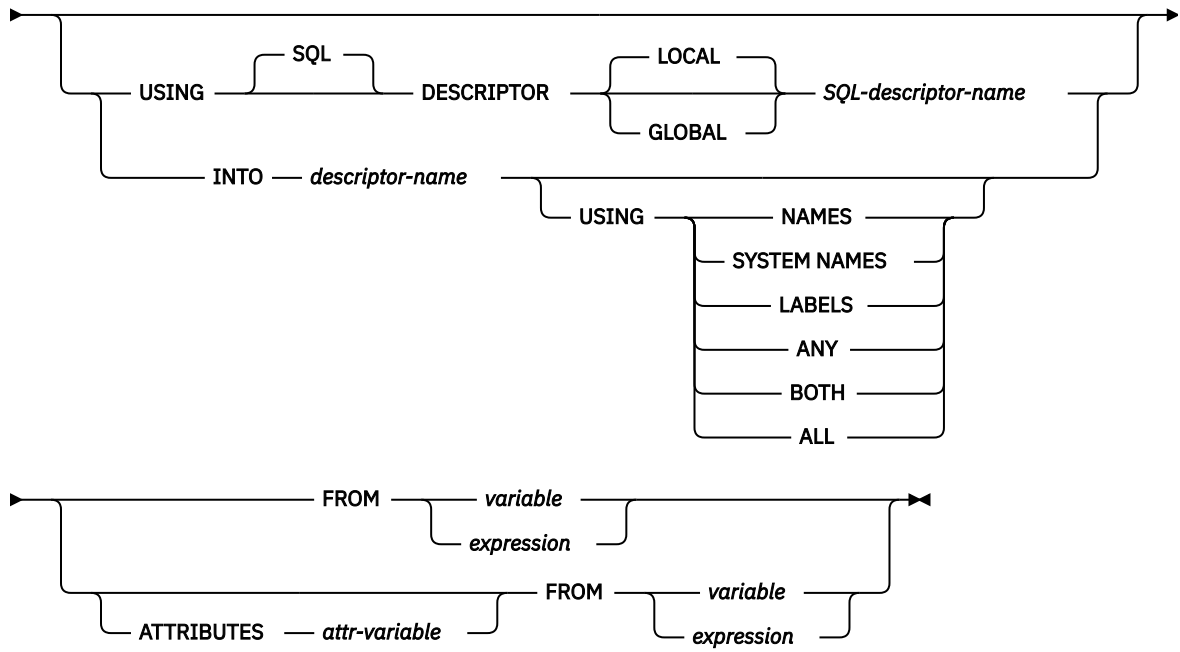

attribute-string

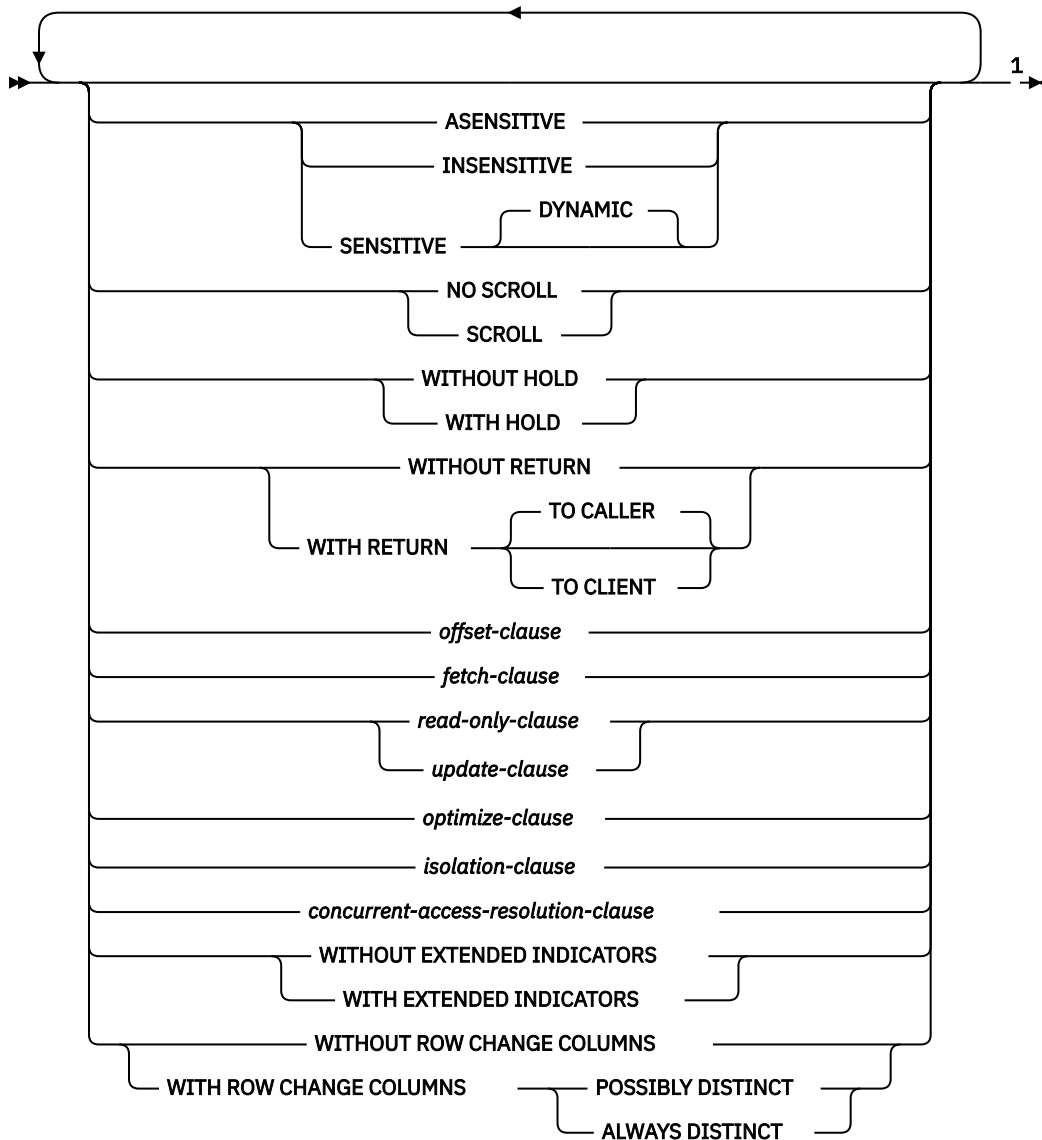

Notes:

¹ The same clause must not be specified more than once. If the options are not specified, their defaults are whatever was specified for the corresponding options in an associated DECLARE CURSOR and the prepared SELECT statement.

Description

statement-name

Names the prepared statement. If the name identifies an existing prepared statement, that prepared statement is destroyed if:

- it was prepared in the same instance of the same program, or
- CLOSQCSR(*ENDJOB), CLOSQCSR(*ENDACTGRP), or CLOSQCSR(*ENDSQL) are specified on the CRTSQLxxx commands associated with both prepared statements.

The name must not identify a prepared statement that is the SELECT statement of an open cursor of this instance of the program.

USING SQL DESCRIPTOR *SQL-descriptor-name*

Identifies an SQL descriptor. If USING is specified, and the PREPARE statement is successfully executed, information about the prepared statement is placed in the SQL descriptor specified by the *SQL-descriptor-name*. Thus, the PREPARE statement:

```
EXEC SQL PREPARE S1 USING SQL DESCRIPTOR :sqldescriptor FROM :V1;
```

is equivalent to:

```
EXEC SQL PREPARE S1 FROM :V1;  
EXEC SQL DESCRIBE S1 USING SQL DESCRIPTOR :sqldescriptor;
```

LOCAL

Specifies the scope of the name of the descriptor to be local to program invocation.

GLOBAL

Specifies the scope of the name of the descriptor to be global to the SQL session.

SQL-descriptor-name

Names the SQL descriptor. The name must identify a descriptor that already exists with the specified scope.

See [“GET DESCRIPTOR” on page 1311](#) for an explanation of the information that is placed in the SQL descriptor.

INTO

If INTO is used, and the PREPARE statement is successfully executed, information about the prepared statement is placed in the SQLDA specified by the *descriptor-name*. Thus, the PREPARE statement:

```
EXEC SQL PREPARE S1 INTO :SQLDA FROM :V1;
```

is equivalent to:

```
EXEC SQL PREPARE S1 FROM :V1;  
EXEC SQL DESCRIBE S1 INTO :SQLDA;
```

descriptor-name

Identifies an SQL descriptor area (SQLDA), which is described in Appendix D, [“SQLDA \(SQL descriptor area\),” on page 1667](#). Before the PREPARE statement is executed, the following variable in the SQLDA must be set (The rules for REXX are different. For more information, see the [Embedded SQL Programming](#) topic collection.) :

SQLN

Indicates the number of variables represented by SQLVAR. (SQLN provides the dimension of the SQLVAR array.) SQLN must be set to a value greater than or equal to zero before the PREPARE statement is executed. For information about techniques to determine the number of occurrences required, see [“Determining how many SQLVAR occurrences are needed” on page 1670](#).

See [“DESCRIBE” on page 1258](#) for an explanation of the information that is placed in the SQLDA.

USING

Specifies what value to assign to each SQLNAME variable in the SQLDA. If the requested value does not exist or a name is longer than 30, SQLNAME is set to length 0.

NAMES

Assigns the name of the column. This is the default. For a prepared statement where the names are explicitly specified in the select-list, the name specified is returned.

SYSTEM NAMES

Assigns the system column name of the column.

LABELS

Assigns the label of the column. (Column labels are defined by the LABEL statement.) Only the first 20 bytes of the label are returned.

ANY

Assigns the column label. If the column has no label, the label is the column name.

BOTH

Assigns both the label and name of the column. In this case, two or three occurrences of SQLVAR per column, depending on whether the result set contains distinct types, are needed to accommodate the additional information. To specify this expansion of the SQLVAR array, set SQLN to $2*n$ or $3*n$ (where n is the number of columns in the table or view). The first n occurrences of SQLVAR contain the column names. Either the second or third n occurrences contain the column labels. If there are no distinct types, the labels are returned in the second set of SQLVAR entries. Otherwise, the labels are returned in the third set of SQLVAR entries.

If the same SQLDA is used on a subsequent FETCH statement, set SQLN to n after the PREPARE is complete.

ALL

Assigns the label, column name, and system column name. In this case three or four occurrences of SQLVAR per column, depending on whether the result set contains distinct types, are needed to accommodate the additional information. To specify this expansion of the SQLVAR array, set SQLN to $3*n$ or $4*n$ (where n is the number of columns in the result table). The first n occurrences of SQLVAR contain the system column names. The second or third n occurrences contain the column labels. The third or fourth n occurrences contain the column names if they are different from the system column name. If there are no distinct types, the labels are returned in the second set of SQLVAR entries and the column names are returned in the third set of SQLVAR entries. Otherwise, the labels are returned in the third set of SQLVAR entries and the column names are returned in the fourth set of SQLVAR entries.

If the same SQLDA is used on a subsequent FETCH statement, set SQLN to n after the PREPARE is complete.

ATTRIBUTES *attr-variable*

Specifies the attributes for this cursor that are in effect if a corresponding attribute has not been specified as part of the outermost fullselect of the associated SELECT statement. If attributes are specified for the outermost fullselect, they are used instead of the corresponding attributes specified on the PREPARE statement. In turn, if attributes are specified in the PREPARE statement, they are used instead of the corresponding attributes specified on a DECLARE CURSOR statement.

All attributes other than USE CURRENTLY COMMITTED and WAIT FOR OUTCOME are ignored if the prepared statement is not a *select-statement*.

attr-variable must identify a character-string or Unicode graphic variable that is declared in the program in accordance with the rules for declaring string variables. *attr-variable* must be a string variable (either fixed-length or varying-length) that has a length attribute that does not exceed the maximum length of a VARCHAR. Leading and trailing blanks are removed from the value of the variable. The variable must contain a valid *attribute-string*.

An indicator variable can be used to indicate whether attributes are actually provided on the PREPARE statement. Thus, applications can use the same PREPARE statement regardless of whether attributes need to be specified or not. The options that can be specified as part of the *attribute-string* are as follows:

ASENSITIVE, SENSITIVE, or INSENSITIVE

Specifies whether the cursor is asensitive, sensitive, or insensitive to changes. For more information, see [“DECLARE CURSOR” on page 1207](#).

If SENSITIVE is specified, then a *fetch-clause* must not be specified. If INSENSITIVE is specified, then an *update-clause* must not be specified.

NO SCROLL or SCROLL

Specifies whether the cursor is scrollable or not scrollable. For more information, see [“DECLARE CURSOR” on page 1207](#).

WITHOUT HOLD or WITH HOLD

Specifies whether the cursor should be prevented from being closed as a consequence of a commit operation. For more information, see [“DECLARE CURSOR” on page 1207](#).

WITHOUT RETURN or WITH RETURN

Specifies whether the result table of the cursor is intended to be used as a result set that will be returned from a procedure. For more information, see [“DECLARE CURSOR” on page 1207](#).

offset-clause

Specifies the number of rows to skip before any rows are retrieved. For more information, see [“offset-clause” on page 767](#). The *offset-row-count* must be a constant.

fetch-clause

Specifies that a maximum number of rows should be retrieved. For more information, see [“fetch-clause” on page 768](#). The *fetch-row-count* must be a constant. The alternate LIMIT syntax is not supported.

read-only-clause or update-clause

Specifies whether the result table is read-only or updatable. The *update-clause* clause must be specified without column names (FOR UPDATE). For more information, see [“read-only-clause” on page 785](#) and [“update-clause” on page 784](#).

optimize-clause

Specifies that the database manager should assume that the program does not intend to retrieve more than *integer* rows from the result table. For more information, see [“optimize-clause” on page 786](#).

isolation-clause

Specifies an isolation level at which the select statement is executed. For more information, see [“isolation-clause” on page 787](#).

concurrent-access-resolution-clause

Specifies the concurrent access resolution to use for the select statement. For more information, see [“concurrent-access-resolution-clause” on page 789](#).

WITHOUT EXTENDED INDICATORS or WITH EXTENDED INDICATORS

Specifies whether the values provided for indicator variables during execution of an INSERT or UPDATE follow standard SQL semantics for indicating NULL values, or may use extended indicator values including DEFAULT or UNASSIGNED.

WITH EXTENDED INDICATORS must only be specified when the statement is an INSERT using VALUES form of the INSERT statement, an UPDATE statement, or when the statement contains an INSERT using VALUES form of the INSERT statement.

WITHOUT ROW CHANGE COLUMNS or WITH ROW CHANGE COLUMNS POSSIBLY DISTINCT or WITH ROW CHANGE COLUMNS ALWAYS DISTINCT

Specifies whether additional column(s) should be added to the result set of a prepared *select-statement* that can be subsequently be used to identify whether a value of a column in the row might have changed. Additional row change columns are only added if a single table (or an updatable view) is referenced in the outermost subselect. The DESCRIBE and GET DESCRIPTOR statements will indicate which rows have been added.

WITHOUT ROW CHANGE COLUMNS

Row change columns are not added to the result set. This is the default.

WITH ROW CHANGE COLUMNS POSSIBLY DISTINCT

Row change columns are added to the result set even if they do not uniquely represent a single row. The columns added can be used to determine whether a value of a column in the row might have changed since it was originally fetched.

- If the row change column values have not changed since they were first fetched, then no columns of the row have been changed since they were first fetched.
- If the row change column values have changed since they were first fetched, then columns of the row may or may not have changed since the row change values are not guaranteed to represent a single row.

WITH ROW CHANGE COLUMNS ALWAYS DISTINCT

Row change columns are added to the result set only if they uniquely represent a single row. Otherwise, no row change columns are added to the result set. The columns added can be used to determine whether a value of a column in the row has changed since it was originally fetched. (Note that a table requires a row change timestamp column to guarantee that the row change columns of a row uniquely identify a single row.)

- If the row change column values have not changed since they were first fetched, then no columns of the row have been changed since they were first fetched.
- If the row change column values have changed since they were first fetched, then columns of the row have changed.

A warning is returned (SQLSTATE 0168T) if WITH ROW CHANGE COLUMNS ALWAYS DISTINCT is specified and the database manager is unable to return distinct row change columns.

FROM

Introduces the statement string. The statement string is the value of the specified *expression*, *string-expression*, or the identified *variable*.

variable

Identifies a *variable* that is declared in the program in accordance with the rules for declaring character-string or Unicode graphic variables. An indicator variable must not be specified.

expression

An *expression* of the type described in “Expressions” on page 159, that does not include an aggregate function or column name. It must return a value that is a character string or a Unicode graphic string. If a variable is specified in the *expression* it must not have a CCSID of 65535.¹¹⁸

The statement string must be one of the following SQL statements:

ALLOCATE CURSOR	INSERT	SET CURRENT DEGREE
ALTER	LABEL	SET CURRENT IMPLICIT XMLPARSE OPTION
ASSOCIATE LOCATORS	LOCK TABLE	SET CURRENT TEMPORAL SYSTEM_TIME
CALL	MERGE	SET ENCRYPTION PASSWORD
COMMENT	REFRESH TABLE	SET PATH
COMMIT	RELEASE SAVEPOINT	SET SCHEMA
Compound (dynamic)	RENAME	SET SESSION AUTHORIZATION
CREATE	REVOKE	SET TRANSACTION
DECLARE GLOBAL TEMPORARY TABLE	ROLLBACK	SET variable ¹¹⁹
DELETE	SAVEPOINT	TRANSFER OWNERSHIP
DROP	<i>select-statement</i>	TRUNCATE
FREE LOCATOR	SET CURRENT DEBUG MODE	UPDATE
GRANT	SET CURRENT DECFLOAT ROUNDING MODE	VALUES INTO
HOLD LOCATOR		

The statement string must not:

- Begin with EXEC SQL.
- End with END-EXEC or a semicolon.
- Include references to variables. Global variables are allowed.

¹¹⁸ In a PL/I program, a PL/I string expression can also be specified.

¹¹⁹ The target of the SET variable statement must be a global variable.

Notes

Parameter markers: Although a statement string cannot include references to host variables, SQL variables, or SQL parameters, it may include *parameter markers* or global variables. Parameter markers can be replaced by the values of variables when the prepared statement is executed. A parameter marker is a question mark (?) that is used where a variable could be used if the statement string were a static SQL statement. For an explanation of how parameter markers are replaced by values, see [“OPEN” on page 1421](#) and [“EXECUTE” on page 1296](#).

There are two types of parameter markers:

Typed parameter marker

A parameter marker that is specified along with its target data type. It has the general form:

```
CAST(? AS data-type)
```

This notation is not a function call, but a “promise” that the type of the parameter at run time will be of the data type specified or some data type that can be converted to the specified data type. For example, in:

```
UPDATE EMPLOYEE
SET LASTNAME = TRANSLATE(CAST(? AS VARCHAR(12)))
WHERE EMPNO = ?
```

the value of the argument of the TRANSLATE function will be provided at run time. The data type of that value will either be VARCHAR(12), or some type that can be converted to VARCHAR(12). For more information, refer to [“CAST specification” on page 177](#).

Untyped parameter marker

A parameter marker that is specified without its target data type. It has the form of a single question mark. The data type of an untyped parameter marker is provided by context. For example, the untyped parameter marker in the predicate of the above update statement is the same as the data type of the EMPNO column.

Typed parameter markers can be used in dynamic SQL statements wherever a variable is supported and the data type is based on the promise made in the CAST function.

Untyped parameter markers can be used in dynamic SQL statements in selected locations where variables are supported. These locations and the resulting data type are found in the following tables:

Table 115. Untyped Parameter Marker Usage in Expressions (Including Select List, CASE, and VALUES)

Untyped Parameter Marker Location	Data Type
Alone in a select list that is not in a subquery	Error
Alone in a select list that is in an EXISTS subquery	Error
Alone in a select list that is in a subquery	The data type of the other operand of the subquery. ¹²⁰
Alone as <i>offset-row-count</i> in an <i>offset-clause</i> .	BIGINT
Alone as <i>fetch-row-count</i> in a <i>fetch-clause</i> .	BIGINT
Both operands of a single arithmetic operator, after considering operator precedence and order of operation rules.	DECFLOAT(34)

Includes cases such as:

```
? + ? + 10
```

Table 115. Untyped Parameter Marker Usage in Expressions (Including Select List, CASE, and VALUES) (continued)

Untyped Parameter Marker Location	Data Type
One operand of a single operator in an arithmetic expression (not a datetime expression) Includes cases such as: <code>? + ? * 10</code>	The data type of the other operand.
Labelled duration within a datetime expression with a unit type other than SECONDS. (Note that the portion of a labelled duration that indicates the type of units cannot be a parameter marker.)	DECIMAL(15,0)
Labelled duration within a datetime expression with a type unit of SECONDS. (Note that the portion of a labelled duration that indicates the type of units cannot be a parameter marker.)	DECIMAL(27,12)
Any other operand of a datetime expression (for instance 'timecol + ?' or '? - datecol').	Error
Both operands of a CONCAT operator	DBCLOB(1G) CCSID 1200
One operand of a CONCAT operator when the other operand is a non-CLOB character data type	VARCHAR(32740) with the same CCSID as the other operand
One operand of a CONCAT operator, when the other operand is a non-DBCLOB graphic data type	VARGRAPHIC(16370) with the same CCSID as the other operand
One operand of a CONCAT operator when the other operand is a non-BLOB binary type	VARBINARY(32740)
One operand of a CONCAT operator, when the other operand is a large object string	Same as that of the other operand
The expression following the CASE keyword in a simple CASE expression	Result of applying the “Rules for result data types” on page 107 to the expressions following the WHEN keyword that are other than untyped parameter markers
At least one of the result-expressions in a CASE expression (both Simple and Searched) with the rest of the result-expressions either untyped parameter marker or NULL.	Error
Any or all expressions following WHEN in a simple CASE expression.	Result of applying the “Rules for result data types” on page 107 to the expression following CASE and the expressions following WHEN that are not untyped parameter markers.
A result-expression in a CASE expression (both simple and searched) where at least one result-expression is not NULL and not an untyped parameter marker.	Result of applying the “Rules for result data types” on page 107 to all result-expressions that are other than NULL or untyped parameter markers.
Alone as a <i>column-expression</i> in a single-row VALUES clause that is not within an INSERT statement and not within the VALUES clause of an insert operation of a MERGE statement.	Error

Table 115. Untyped Parameter Marker Usage in Expressions (Including Select List, CASE, and VALUES)
(continued)

Untyped Parameter Marker Location	Data Type
Alone as a <i>column-expression</i> in a multi-row VALUES clause that is not within an INSERT statement, and for which the <i>column-expressions</i> in the same position in all other <i>row-expressions</i> are untyped parameter markers.	Error
Alone as a <i>column-expression</i> in a multi-row VALUES clause that is not within an INSERT statement, and for which a <i>column-expression</i> in the same position of at least one other <i>row-expression</i> is not an untyped parameter marker or NULL.	Result of applying the “Rules for result data types” on page 107 to all operands that are other than untyped parameter markers.
Alone as a <i>column-expression</i> in a single-row VALUES clause within an INSERT statement.	The data type of the column. If the column is defined as a user-defined distinct type, then it is the source data type of the user-defined distinct type. ¹²⁰
Alone as a <i>column-expression</i> in a multi-row VALUES clause within an INSERT statement.	The data type of the column. If the column is defined as a user-defined distinct type, then it is the source data type of the user-defined distinct type. ¹²⁰
Alone as a <i>column-expression</i> in a VALUES clause of the source-table for a MERGE statement	Error
Alone as a <i>column-expression</i> in the VALUES clause of an insert operation of a MERGE statement	The data type of the column. If the column is defined as a user-defined distinct type, then it is the source data type of the user-defined distinct type. ¹²⁰
Alone as a <i>column-expression</i> on the right side of assignment-clause for an update operation of a MERGE statement	The data type of the column. If the column is defined as a user-defined distinct type, then it is the source data type of the user-defined distinct type. ¹²⁰
Alone as a value on the right hand side of a SET clause of an UPDATE statement.	The data type of the column. If the column is defined as a user-defined distinct type, then it is the source data type of the user-defined distinct type. ¹²⁰
As a value in an <i>insert-multiple-rows</i> of an INSERT statement.	INTEGER
As a value on the right side of a SET special register statement	The data type of the special register.
As a value in the VALUES clause of the VALUES INTO statement, where the associated expression is a global variable.	The data type of the global variable.
As a value in the INTO clause of the VALUES INTO statement	The data type of the associated expression. ¹²⁰
As a value in a FREE LOCATOR or HOLD LOCATOR statement	Locator.

Table 115. Untyped Parameter Marker Usage in Expressions (Including Select List, CASE, and VALUES) (continued)

Untyped Parameter Marker Location	Data Type
As a value for the password in a SET ENCRYPTION PASSWORD statement	VARCHAR(128)
As a value for the hint in a SET ENCRYPTION PASSWORD statement	VARCHAR(32)

Table 116. Untyped Parameter Marker Usage in Predicates

Untyped Parameter Marker Location	Data Type
Both operands of a comparison operator or DISTINCT predicate	VARGRAPHIC(16370) CCSID 1200
One operand of a comparison operator or DISTINCT predicate where the other operand is other than an untyped parameter marker or a strongly typed distinct type.	The data type of the other operand. If the other operand is a weakly typed distinct type, the source data type of the distinct type. ¹²⁰
One operand of a comparison operator where the other operand is a strongly typed distinct type.	Error
All operands of a BETWEEN predicate	VARGRAPHIC(16370) CCSID 1200
Two operands of a BETWEEN predicate	Same as that of the only non-parameter marker.
Only one operand of a BETWEEN predicate	Result of applying the “Rules for result data types” on page 107 on all operands that are other than untyped parameter markers, except the CCSID attribute is the CCSID of the value specified at execution time.
All operands of an IN predicate, for example, ? IN (?,?,?)	VARGRAPHIC(16370) CCSID 1200
The first operand of an IN predicate where the right hand side is a fullselect, for example, ? IN (fullselect).	Data type of the selected column
The first operand of an IN predicate where the right hand side is not a fullselect, for example, ? IN (?,A,B) or for example, ? IN (A,?,B,?).	Result of applying the “Rules for result data types” on page 107 on all operands of the IN list (operands to the right of IN keyword) that are other than untyped parameter markers, except the CCSID attribute is the CCSID of the value specified at execution time.
Any or all operands of the IN list of the IN predicate, for example, A IN (?,B,?).	Result of applying the “Rules for result data types” on page 107 on all operands of the IN predicate (operands to the left and right of the IN predicate) that are other than untyped parameter markers, except the CCSID attribute is the CCSID of the value specified at execution time.
Any operands in a row-value-expression of an IN predicate, for example, (c1,?) IN ...	Error
Any select list items in a subquery if a row-value-expression is specified in an IN predicate, for example, (c1,c2) IN (SELECT ?, c1 FROM ...)	Error

Table 116. Untyped Parameter Marker Usage in Predicates (continued)

Untyped Parameter Marker Location	Data Type
First operand of the IS JSON predicate	CLOB(2G) CCSID 1208
<i>json-expression</i> or <i>sql-json-path-expression</i> of the JSON_EXISTS predicate.	CLOB(2G) CCSID 1208
All three operands of the LIKE predicate.	Match expression (operand 1) and pattern expression (operand 2) VARCHAR(32740); escape expression (operand 3) is VARCHAR(1) ¹²¹ with the CCSID of the job.
The match expression of the LIKE predicate when either the pattern expression or the escape expression is other than an untyped parameter marker.	Either VARCHAR(32740) or VARGRAPHIC(16370) or VARBINARY(32740) depending on the data type of the first operand that is not an untyped parameter marker. The CCSID depends on the CCSID of the first operand.
The pattern expression of the LIKE predicate when either the match expression or the escape expression is other than an untyped parameter marker.	Either VARCHAR(32740) or VARGRAPHIC(16370) or VARBINARY(32740) depending on the data type of the first operand that is not an untyped parameter marker. The CCSID depends on the CCSID of the first operand. For information about using fixed-length variables for the value of the pattern, see “LIKE predicate” on page 216 .
The escape expression of the LIKE predicate when either the match expression or the pattern expression is other than an untyped parameter marker.	Either VARCHAR(1) ¹²¹ or VARGRAPHIC(1) or VARBINARY(1) depending on the result of applying the “Rules for result data types” on page 107 on all operands that are other than untyped parameter markers. The CCSID also depends on result of applying these rules.
Operand of the NULL predicate	VARGRAPHIC(16370) CCSID 1200

Table 117. Untyped Parameter Marker Usage in Built-in Functions

Untyped Parameter Marker Location	Data Type
All arguments of BITAND, BITANDNOT, BITOR, BITXOR, BITNOT, COALESCE, IFNULL, LAND, LOR, MIN, MAX, NULLIF, VALUE, or XOR	Error
Any argument of COALESCE, IFNULL, LAND, LOR, MIN, MAX, NULLIF, or VALUE, or XOR where at least one argument is other than an untyped parameter marker.	Result of applying the “Rules for result data types” on page 107 on all arguments that are other than untyped parameter markers. If the result is a weakly typed distinct type, the source data type of the distinct type. If the result is a strongly typed distinct type, an error is returned.
An argument of BITAND, BITANDNOT, BITOR, and BITXOR where the other argument is other than an untyped parameter marker.	If the other argument is SMALLINT, INTEGER, or BIGINT, the data type of the other argument. Otherwise, DECFLOAT(34).
First argument of BSON_TO_JSON	BLOB(2G)
All arguments of COMPARE_DECFLOAT, DECFLOAT_SORTKEY, NORMALIZE_DECFLOAT, QUANTIZE, and TOTALORDER	DECFLOAT(34)

Table 117. Untyped Parameter Marker Usage in Built-in Functions (continued)

Untyped Parameter Marker Location	Data Type
First argument of DAYNAME	TIMESTAMP(12)
First argument of DECFLOAT_FORMAT	VARGRAPHIC(16370) CCSID 1200
Second argument of DECFLOAT_FORMAT	Error
First argument of HASH, HASH_MD5, HASH_SHA1, HASH_SHA256, or HASH_SHA512	DBCLOB(1G) CCSID 1200
Second argument of HASH	INTEGER
First argument of INTERPRET	BLOB(2G)
<i>JSON-expression</i> (when FORMAT BSON is specified) argument of JSON_ARRAY, JSON_OBJECT, JSON_QUERY, or JSON_VALUE	BLOB(2G)
<i>JSON-expression</i> (when FORMAT BSON is not specified), <i>key-name-expression</i> , or <i>sql-json-path-expression</i> arguments of JSON_ARRAY, JSON_OBJECT, JSON_QUERY, or JSON_VALUE	CLOB(2G) CCSID 1208
First argument of JSON_TO_BSON	CLOB(2G) CCSID 1208
Both arguments of LOCATE, POSITION, or POSSTR	DBCLOB(1G) CCSID 1200
One argument of LOCATE, POSITION, or POSSTR when the other argument is a character data type.	VARCHAR(32740) with the CCSID of the other argument
One argument of LOCATE, POSITION, or POSSTR when the other argument is a graphic data type.	VARGRAPHIC(16370) with the CCSID of the other argument
One argument of LOCATE, POSITION, or POSSTR when the other argument is a binary data type.	VARBINARY(32740)
Both the first and second arguments of LOCATE_IN_STRING or OVERLAY	DBCLOB(1G) CCSID 1200
The first or second argument of LOCATE_IN_STRING or OVERLAY when the other string argument is a character data type.	VARCHAR(32740) with the CCSID of the other argument
The first or second argument of LOCATE_IN_STRING or OVERLAY when the other string argument is a graphic data type.	VARGRAPHIC(16370) with the CCSID of the other argument
The first or second argument of LOCATE_IN_STRING or OVERLAY when the other string argument is a binary data type.	VARBINARY(32740)
The third or fourth argument of LOCATE_IN_STRING or OVERLAY	INTEGER
The second argument of LPAD or RPAD	INTEGER
The third argument of LPAD or RPAD	VARCHAR(32740)
The first argument of LTRIM or RTRIM	DBCLOB(1G) CCSID 1200

Table 117. Untyped Parameter Marker Usage in Built-in Functions (continued)

Untyped Parameter Marker Location	Data Type
The second argument of LTRIM or RTRIM	VARCHAR(32740) if the first argument is a character type; VARBINARY(32740) if the first argument is a binary type; VARGRAPHIC(16370) if the first argument is a graphic type. The CCSID depends on the CCSID of the first argument.
The argument of UPPER, LOWER, UCASE, and LCASE	DBCLOB(1G) CCSID 1200
First argument of MONTHNAME	TIMESTAMP(12)
First or second argument of MONTHS_BETWEEN	TIMESTAMP(12)
First operand of REGEXP_LIKE, REGEXP_INSTR, REGEXP_SUBSTR, REGEXP_COUNT, and REGEXP_REPLACE	DBCLOB(1G) CCSID 1200
Second operand of REGEXP_LIKE, REGEXP_INSTR, REGEXP_SUBSTR, REGEXP_COUNT, and REGEXP_REPLACE	DBCLOB(32K) CCSID 1200
Third operand of REGEXP_REPLACE	DBCLOB(32K) CCSID 1200
<i>source-string</i> operand of REGEXP_LIKE, REGEXP_COUNT, REGEXP_INSTR, REGEXP_SUBSTR, and REGEXP_REPLACE	DBCLOB(32K) CCSID 1200
<i>pattern-expression</i> of REGEXP_LIKE, REGEXP_COUNT, REGEXP_INSTR, REGEXP_SUBSTR, and REGEXP_REPLACE	DBCLOB(32K) CCSID 1200
<i>replacement-string</i> operand of REGEXP_REPLACE	DBCLOB(32K) CCSID 1200
<i>start</i> operand of REGEXP_LIKE, REGEXP_COUNT, REGEXP_INSTR, REGEXP_SUBSTR, and REGEXP_REPLACE	INTEGER
<i>flags</i> operand of REGEXP_LIKE, REGEXP_COUNT, REGEXP_INSTR, REGEXP_SUBSTR, and REGEXP_REPLACE	VARCHAR(6)
<i>occurrence</i> operand of REGEXP_INSTR, REGEXP_SUBSTR, and REGEXP_REPLACE	INTEGER
<i>return-option</i> operand of REGEXP_INSTR	INTEGER
<i>group</i> operand of REGEXP_INSTR and REGEXP_SUBSTR	INTEGER
SUBSTR (first argument)	DBCLOB(1G) CCSID 1200
SUBSTR (second and third arguments)	INTEGER
The first argument of TRANSLATE	Error
The second and third arguments of TRANSLATE	VARCHAR(32740) if the first argument is a character type; VARGRAPHIC(16370) if the first argument is a graphic type. The CCSID depends on the CCSID of the first argument.

Table 117. Untyped Parameter Marker Usage in Built-in Functions (continued)

Untyped Parameter Marker Location	Data Type
The fourth argument of TRANSLATE	VARCHAR(1) if the first argument is a character type; VARGRAPHIC(1) if the first argument is a graphic type. The CCSID depends on the CCSID of the first argument.
The first argument of TIMESTAMP or TIMESTAMP_ISO	Error
The second argument of TIMESTAMP	TIME
The first argument of TIMESTAMP_FORMAT	VARGRAPHIC(16370) CCSID 1200
The first argument of VARCHAR_FORMAT	TIMESTAMP(12)
The second argument of TIMESTAMP_FORMAT or VARCHAR_FORMAT	Error
Any argument after the first argument of VERIFY_GROUP_FOR_USER	VARCHAR(128)
First argument of XMLVALIDATE	XML ¹²²
First argument of XMLPARSE	CLOB(2G) or DBCLOB(1G) based on the CCSID value for the query option SQL_XML_DATA_CCSID
First argument of XMLCOMMENT	VARCHAR(32740) or VARGRAPHIC(16370) based on the CCSID value for the query option SQL_XML_DATA_CCSID
First argument of XMLTEXT	VARCHAR(32740) or VARGRAPHIC(16370) based on the CCSID value for the query option SQL_XML_DATA_CCSID
Second argument of XMLPI	VARCHAR(36740) or VARGRAPHIC(16370) based on the CCSID value for the query option SQL_XML_DATA_CCSID
First argument of XMLSERIALIZE	XML ¹²³
All arguments of XMLDOCUMENT	XML ¹²²
All arguments of XMLCONCAT	XML ¹²²
First, second, and third arguments of XSLTRANSFORM	XML ¹²³
Array index of an ARRAY	BIGINT
Unary minus	DECFLOAT(34)
Unary plus	DECFLOAT(34)
All other arguments of all other scalar functions.	Error
Argument of MEDIAN	DECFLOAT(34)
First or second argument of CORRELATION, COVARIANCE, COVARIANCE_SAMP, or any of the Regression functions	DECFLOAT(34) if the other argument is DECFLOAT. Otherwise, DOUBLE.
JSON-expression (when FORMAT BSON is specified) argument of JSON_ARRAYAGG or JSON_OBJECTAGG	BLOB(2G)

Table 117. Untyped Parameter Marker Usage in Built-in Functions (continued)

Untyped Parameter Marker Location	Data Type
JSON-expression (when FORMAT BSON is not specified) or key-name-expression argument of JSON_ARRAYAGG or JSON_OBJECTAGG	CLOB(2G) CCSID 1208
Second argument of LISTAGG	VARCHAR(32740) if the first argument is a character type; VARBINARY(32740) if the first argument is a binary type; VARGRAPHIC(16370) if the first argument is a graphic type. The CCSID depends on the CCSID of the first argument.
Argument or order by expression of PERCENTILE_CONT or PERCENTILE_DISC	DECFLOAT(34)
Arguments of all other aggregate functions	Error
JSON-expression or sql-json-path-expression argument of JSON_TABLE	CLOB(2G) CCSID 1208

Table 118. Untyped Parameter Marker Usage in User-defined Routines

Untyped Parameter Marker Location	Data Type
Argument of a function	The data type of the parameter, as defined when the function was created
Argument of a procedure	The data type of the parameter, as defined when the procedure was created

Error checking: When a PREPARE statement is executed, the statement string is parsed and checked for errors. If the statement string is not valid, a prepared statement is not created and an error is returned.

In local and remote processing, the DLYPREP(*YES) option can cause some SQL statements to receive "delayed" errors. For example, DESCRIBE, EXECUTE, and OPEN might receive an SQLCODE that normally occurs during PREPARE processing.

Reference and execution rules: Prepared statements can be referred to in the following kinds of statements, with the following restrictions shown:

Statement	The prepared statement restrictions
DESCRIBE	None
DECLARE CURSOR	Must be SELECT when the cursor is opened
EXECUTE	Must not be SELECT

A prepared statement can be executed many times. If a prepared statement is not executed more than once and does not contain parameter markers, it is more efficient to use the EXECUTE IMMEDIATE statement rather than the PREPARE and EXECUTE statements.

Extended indicator usage: The EXTENDED INDICATORS clause indicates whether extended indicator variable values are enabled in the SET *assignment-clause* of an UPDATE statement, the VALUES *expression-list* of an INSERT statement, or the insert operation or update operation of a MERGE statement.

¹²⁰ If the data type is DATE, TIME, or TIMESTAMP, then VARCHAR(32740) is used.

¹²¹ If the escape expression is MIXED data, the data type is VARCHAR(4).

¹²² The CCSID for XML is determined as described in "XML Values" on page 80.

¹²³ The CCSID is determined based on the attributes of the *data-type* specified on the AS clause as described in "CAST specification" on page 177. If the *data-type* is a binary string or bit data, then the SQL_XML_DATA_CCSID is used for the CCSID attribute.

Extended indicator variables and deferred error checks: When extended indicator variables are enabled, the UNASSIGNED indicator variable value effectively causes its target column to be omitted from the statement. Because of this, validation that is normally done during statement preparation is delayed until statement execution.

Prepared statement persistence: All prepared statements are destroyed when:¹²⁴

- A CONNECT (Type 1) statement is executed.
- A DISCONNECT statement disconnects the connection with which the prepared statement is associated.
- A prepared statement is associated with a release-pending connection and a successful commit occurs.
- The associated scope (job, activation group, or program) of the SQL statement ends.

Scope of a statement: The scope of *statement-name* is the source program in which it is defined. You can only reference a prepared statement by other SQL statements that are precompiled with the PREPARE statement. For example, a program called from another separately compiled program cannot use a prepared statement that was created by the calling program.

The scope of *statement-name* is also limited to the thread in which the program that contains the statement is running. For example, if the same program is running in two separate threads in the same job, the second thread cannot use a statement that was prepared by the first thread.

Although the scope of a statement is the program in which it is defined, each package created from the program includes a separate instance of the prepared statement and more than one prepared statement can exist at run time. For example, assume a program using CONNECT (Type 2) statements connects to location X and location Y in the following sequence:

```
EXEC SQL CONNECT TO X;  
EXEC SQL PREPARE S FROM :hv1;  
EXEC SQL EXECUTE S;  
.  
.  
EXEC SQL CONNECT TO Y;  
EXEC SQL PREPARE S FROM :hv1;  
EXEC SQL EXECUTE S;
```

The second prepare of S prepares another instance of S at Y.

A prepared statement can only be referenced in the same instance of the program in the program stack, unless CLOSQLCSR(*ENDJOB), CLOSQLCSR(*ENDACTGRP), or CLOSQLCSR(*ENDSQL) is specified on the CRTSQLxxx commands.

- If CLOSQLCSR(*ENDJOB) is specified, the prepared statement can be referred to by any instance of the program (that prepared the statement) on the program stack. In this case, the prepared statement is destroyed at the end of the job.
- If CLOSQLCSR(*ENDSQL) is specified, the prepared statement can be referred to by any instance of the program (that prepared the statement) on the program stack until the last SQL program on the program stack ends. In this case, the prepared statement is destroyed when the last SQL program on the program stack ends.
- If CLOSQLCSR(*ENDACTGRP) is specified, the prepared statement can be referred to by all instances of the module in the program that prepared the statement until the activation group ends. In this case, the prepared statement is destroyed when the activation group ends.

Allocating the SQL descriptor: If a USING clause is specified, before the PREPARE statement is executed, the SQL descriptor must be allocated using the ALLOCATE DESCRIPTOR statement. If the number of descriptor items allocated is less than the number of result columns, a warning (SQLSTATE 01005) is returned.

¹²⁴ Prepared statements may be cached and not actually destroyed. However, a cached statement can only be used if the same statement is prepared again.

PREPARE and *LIBL: Normally, any unqualified names of objects are resolved when a statement is prepared. Hence, any changes to the CURRENT SCHEMA or CURRENT PATH after the statement has been prepared have no effect on which objects will be referenced when the statement is executed or opened. However, if system naming is used and an object name is implicitly qualified with *LIBL, the object is resolved at execute or open time. Any changes to the library list after the statement is prepared but before execute or open time will affect which objects will be referenced when the statement is executed or opened.

Examples

Example 1: Prepare and execute a non-select-statement in a COBOL program. Assume the statement is contained in a variable HOLDER and that the program will place a statement string into the variable based on some instructions from the user. The statement to be prepared does not have any parameter markers.

```
EXEC SQL PREPARE STMT_NAME FROM :HOLDER END-EXEC.
EXEC SQL EXECUTE STMT_NAME END-EXEC.
```

Example 2: Prepare and execute a non-select-statement as in example 1, except assume the statement to be prepared can contain any number of parameter markers.

```
EXEC SQL PREPARE STMT_NAME FROM :HOLDER END-EXEC.
EXEC SQL EXECUTE STMT_NAME USING DESCRIPTOR :INSERT_DA END-EXEC.
```

Assume that the following statement is to be prepared:

```
INSERT INTO DEPARTMENT VALUES(?, ?, ?, ?)
```

To insert department number G01 named COMPLAINTS, which has no manager and reports to department A00, the structure INSERT_DA should have the following values before executing the EXECUTE statement.

SQLDAID		
SQLDABC	336	
SQLN	4	
SQLD	4	
SQLTYPE	452	
SQLLEN	3	
SQLDATA		→ G01
SQLIND		
SQLNAME		
SQLTYPE	448	
SQLLEN	29	
SQLDATA		→ COMPLAINTS
SQLIND		
SQLNAME		
SQLTYPE	453	
SQLLEN	6	
SQLDATA		
SQLIND		→ 1
SQLNAME		
SQLTYPE	452	
SQLLEN	3	
SQLDATA		→ A00
SQLIND		
SQLNAME		

RBAL3501-0

REFRESH TABLE

The REFRESH TABLE statement refreshes the data in a materialized query table. The statement deletes all rows in the materialized query table and then inserts the result rows from the *select-statement* specified in the definition of the materialized query table.

Invocation

This statement can be embedded in an application program or issued interactively. It is an executable statement that can be dynamically prepared.

Authorization

The privileges held by the authorization ID of the statement must include at least one of the following:

- For the table identified in the statement,
 - The system authority *OBJMGT on the table
 - The DELETE privilege on the table
 - The INSERT privilege on the table
 - The USAGE privilege on the schema containing the table
- Database administrator authority

For information on the system authorities corresponding to SQL privileges, see [Corresponding System Authorities When Checking Privileges to a Table or View](#).

Syntax

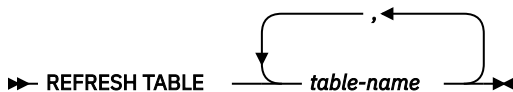

Description

table-name

Identifies the materialized table to be refreshed. The *table-name* must identify a materialized query table that exists at the current server. REFRESH TABLE evaluates the *select-statement* in the definition of the materialized query table to refresh the table.

Notes

Refresh use of materialized query tables: No materialized query tables are used to evaluate the *select-statement* during the processing of REFRESH TABLE statement.

Refresh isolation level: The isolation level used to evaluate the *select-statement* is either:

- the isolation level specified on the *isolation-level* clause of the *select-statement*, or
- if the *isolation-level* clause was not specified, the isolation level of the materialized query table recorded when CREATE TABLE or ALTER TABLE was issued.

Number of rows: After successful execution of a REFRESH TABLE statement, the ROW_COUNT statement information item in the SQL Diagnostics Area (or SQLERRD(3) in the SQLCA) will contain the number of rows inserted into the materialized query table.

Example

Refresh the data in the TRANSCOUNT materialized query table.

RELEASE (connection)

The RELEASE statement places one or more connections in the release-pending state.

Invocation

This statement can only be embedded within an application program or issued interactively. It is an executable statement that cannot be dynamically prepared. It must not be specified in Java or REXX.

RELEASE is not allowed in a trigger or function.

Authorization

If a global variable is referenced in a statement, the privileges held by the authorization ID of the statement must include at least one of the following:

- For the global variable identified in the statement,
 - The READ privilege on the global variable, and
 - The USAGE privilege on the schema containing the global variable
- Database administrator authority

Syntax

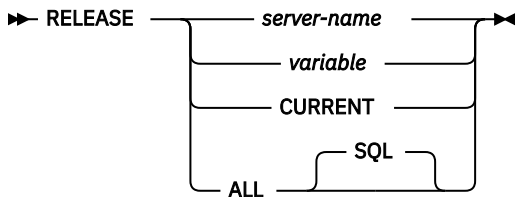

Description

server-name or variable

Identifies a connection by the specified server name or the server name contained in the variable. It can be a global variable if it is qualified with schema name. If a variable is specified:

- It must be a character-string variable.
- It must not be followed by an indicator variable.
- The server name must be left-justified within the variable and must conform to the rules for forming an ordinary identifier.
- If the length of the server name is less than the length of the variable, it must be padded on the right with blanks.

When the RELEASE statement is executed, the specified server name or the server name contained in the variable must identify an existing connection of the activation group.

CURRENT

Identifies the current connection of the activation group. The activation group must be in the connected state.

ALL or ALL SQL

Identifies all existing connections of the activation group (local as well as remote connections).

An error or warning does not occur if no connections exist when the statement is executed.

An application server named ALL can only be identified by a variable or a delimited identifier.

If the RELEASE statement is successful, each identified connection is placed in the release-pending state and will therefore be ended during the next commit operation. If the RELEASE statement is unsuccessful, the connection state of the activation group and the states of its connections are unchanged.

Notes

RELEASE and CONNECT (Type 1): Using CONNECT (Type 1) semantics does not prevent using RELEASE.

Scope of RELEASE: RELEASE does not close cursors, does not release any resources, and does not prevent further use of the connection.

Resource considerations for remote connections: Resources are required to create and maintain remote connections. Thus, a remote connection that is not going to be reused should be in the release-pending state and one that is going to be reused should not be in the release-pending state.

Connection states: ROLLBACK does not reset the state of a connection from release-pending to held.

If the current connection is in the release-pending state when a commit operation is performed, the connection is ended and the activation group is in the unconnected state. In this case, the next executed SQL statement must be CONNECT or SET CONNECTION.

RELEASE ALL places the connection to the local release-pending in the release-pending state. A connection in the release-pending state is ended during a commit operation even though it has an open cursor defined with the WITH HOLD clause.

Examples

Example 1: The connection to TOROLAB1 is not needed in the next unit of work. The following statement will cause it to be ended during the next commit operation.

```
EXEC SQL RELEASE TOROLAB1;
```

Example 2: The current connection is not needed in the next unit of work. The following statement will cause it to be ended during the next commit operation.

```
EXEC SQL RELEASE CURRENT;
```

Example 3: None of the existing connections are needed in the next unit of work. The following statement will cause it to be ended during the next commit operation.

```
EXEC SQL RELEASE ALL;
```

RELEASE SAVEPOINT

The RELEASE SAVEPOINT statement releases the identified savepoint and any subsequently established savepoints within a unit of work at the current server.

Invocation

This statement can be embedded in an application program or issued interactively. It is an executable statement that can be dynamically prepared.

Authorization

None required.

Syntax

```
➤ RELEASE  SAVEPOINT — savepoint-name ➤
```

Description

savepoint-name

Identifies the savepoint to release. The name must identify a savepoint that exists at the current server. The named savepoint and all the savepoints at the current server that were subsequently established in the unit of work are released. After a savepoint is released, it is no longer maintained, and rollback to the savepoint is no longer possible.

Notes

Savepoint Names: The name of the savepoint that was released can be re-used in another SAVEPOINT statement, regardless of whether the UNIQUE keyword was specified on an earlier SAVEPOINT statement specifying this same savepoint name.

Isolation Level Restriction: A RELEASE SAVEPOINT statement is not allowed if commitment control is not active for the activation group. For information about determining which commitment definition is used, see [“Notes” on page 940](#) in COMMIT statement.

Example

Assume that a main routine sets savepoint A and then invokes a subroutine that sets savepoints B and C. When control returns to the main routine, release savepoint A and any subsequently set savepoints. Savepoints B and C, which were set by the subroutine, are released in addition to A.

```
RELEASE SAVEPOINT A
```

RENAME

The RENAME statement renames a table, view, or index. The name and/or the system object name of the table, view, or index can be changed.

Invocation

This statement can be embedded in an application program or issued interactively. It is an executable statement that can be dynamically prepared.

Authorization

The privileges held by the authorization ID of the statement must include at least one of the following:

- The following system authorities:
 - If the name of the object is changed:
 - The system authority of *OBJMGT on the table, view, or index to be renamed
 - The USAGE privilege on the schema containing the table, view, or index to be renamed
 - If the system name of the object is changed:
 - The system authority of *OBJMGT on the table, view, or index to be renamed
 - The USAGE privilege and the system authority of *UPD on the schema containing the table, view, or index to be renamed
- Database administrator authority

Syntax

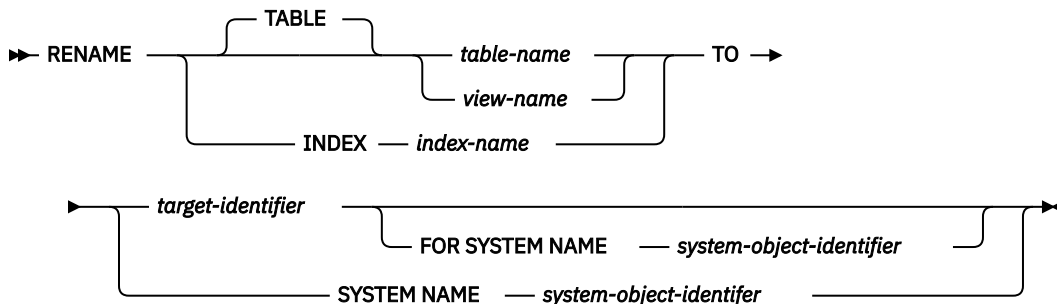

Description

TABLE *table-name* or *view-name*

Identifies the table or view that will be renamed. The *table-name* or *view-name* must identify a table or view that exists at the current server, but must not identify a catalog table or a declared temporary table. The specified name can be an alias name. The specified table or view is renamed to the new name. All privileges, constraints, indexes, triggers, views, and logical files on the table or view are preserved.

Any access plans that reference the table or view are implicitly prepared again when a program that uses the access plan is next run. Since the program refers to a table or view with the original name, if a table or view with the original name does not exist at that time, an error is returned.

INDEX *index-name*

Identifies the index that will be renamed. The *index-name* must identify an index that exists at the current server. The specified index is renamed to the new name.

Any access plans that reference the index are not affected by rename.

target-identifier

Identifies the new *table-name*, *view-name*, or *index-name* of the table, view, or index, respectively. *target-identifier* must not be the same as a table, view, alias, or index that already exists at the current server. The *target-identifier* must be an unqualified SQL identifier.

SYSTEM NAME system-object-identifier

Identifies the new *system-object-identifier* of the table, view, or index, respectively. *system-object-identifier* must not be the same as a table, view, alias, or index that already exists at the current server. The *system-object-identifier* must be an unqualified system identifier.

If the name of the object and the system name of the object are the same and *target-identifier* is not specified, specifying *system-object-identifier* will be the new name and system object name. Otherwise, specifying *system-object-identifier* will only affect the system name of the object and not affect the name of the object.

If both *target-identifier* and *system-object-identifier* are specified, they cannot both be valid system object names.

Notes

Effects of the statement: The specified table, view, or index is renamed to the new name. For a renamed table, all privileges and indexes on the table are preserved. For a renamed index, all privileges are preserved.

Invalidation of packages and access plans: Any access plans that refer to that table are invalidated. For more information see [“Packages and access plans” on page 12](#).

Considerations for aliases: If an alias name is specified for *table-name*, the table must exist at the current server, and the table that is identified by the alias is renamed. The name of the alias is not changed and continues to refer to the old table name after the rename.

There is no support for changing the name of an alias with the RENAME statement. To change the name to which the alias refers, the alias must be dropped and recreated.

Rename rules: The rename operation performed depends on the new name specified.

- If the new name is a valid system identifier,
 - the alternative name (if any) is removed, and
 - the system object name is changed to the new name.
- If the new name is not a valid system identifier,
 - the alternative name is added or changed to the new name, and
 - a new system object name is generated if the system object name (of the table or view) was specified as the table, view, or index to rename. For more information about generated table name rules, see [“Rules for Table Name Generation” on page 1157](#).

If an alias name is specified for *table-name*, the alias must exist at the current server, and the table that is identified by the alias is renamed. The name of the alias is not changed and continues to refer to the old table after the rename. There is no support for changing the name of an alias.

Examples

Example 1: Change the name of the EMPLOYEE table to CURRENT_EMPLOYEES:

```
RENAME TABLE EMPLOYEE  
TO CURRENT_EMPLOYEES
```

Example 2: Change the name of the unique index using EMPNO, called XEMP1, to UXEMPNO:

```
RENAME INDEX XEMP1  
TO UXEMPNO
```

Example 3: Rename a table named MY_IN_TRAY to MY_IN_TRAY_94. The system object name will remain unchanged (MY_IN_TRAY).

```
RENAME TABLE MY_IN_TRAY TO MY_IN_TRAY_94  
FOR SYSTEM NAME MY_IN_TRAY
```

REVOKE (function or procedure privileges)

This form of the REVOKE statement removes the privileges on a function or procedure.

Invocation

This statement can be embedded in an application program or issued interactively. It is an executable statement that can be dynamically prepared.

Authorization

The privileges held by the authorization ID of the statement must include at least one of the following:

- For each function or procedure identified in the statement:
 - Every privilege specified in the statement
 - The system authority of *OBJMGT on the function or procedure
 - The USAGE privilege on the schema (or the system authority of *EXECUTE on the directory if this is a Java routine) containing the function or procedure
- Database administrator authority
- Security administrator authority

Syntax

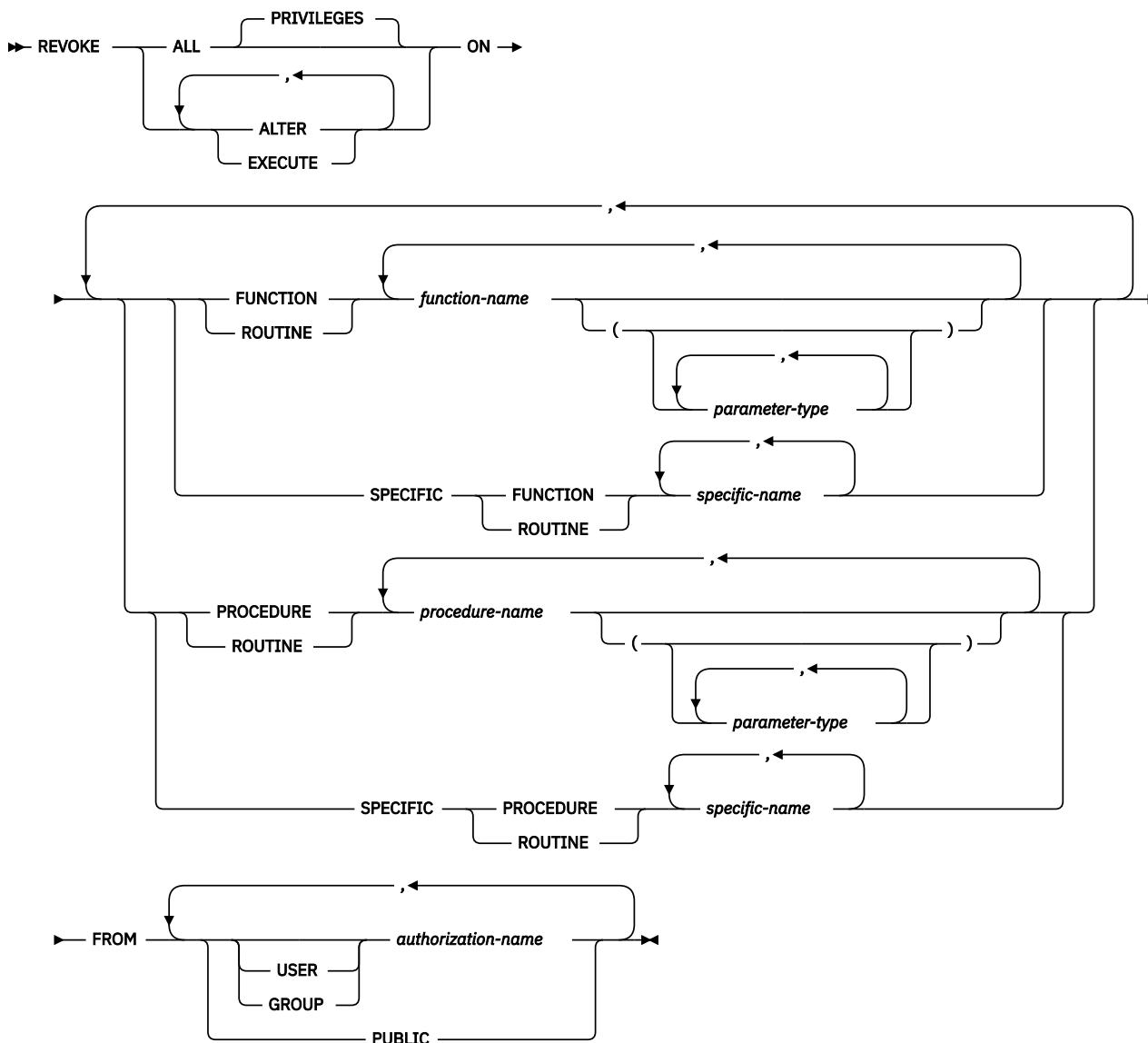

parameter-type

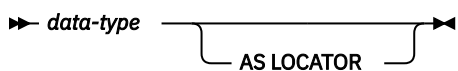

data-type

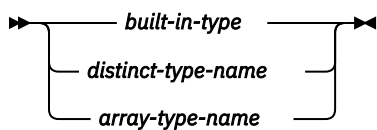

built-in-type

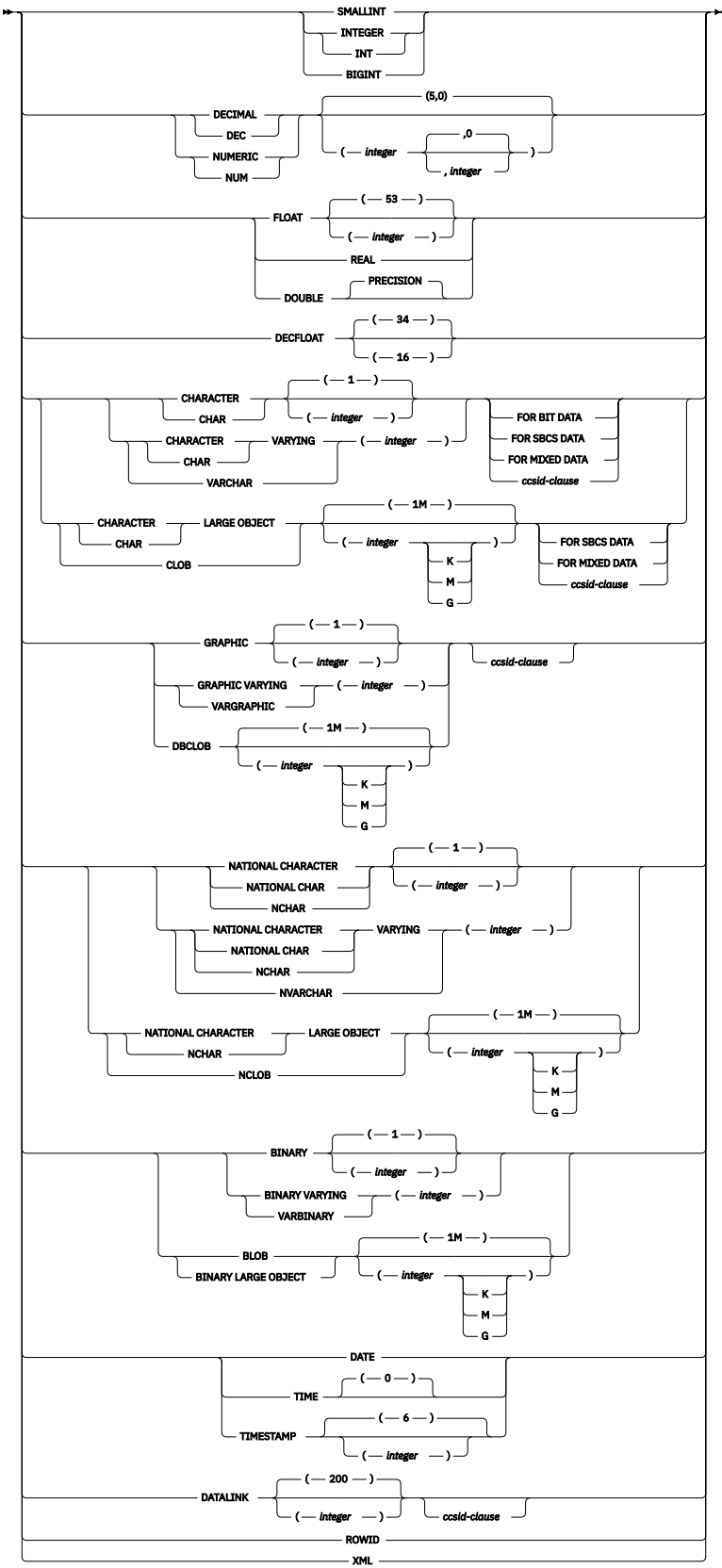

ccsid-clause

► CCSID — integer ◀

Description

ALL or ALL PRIVILEGES

Revokes one or more function or procedure privileges from each *authorization-name*. The privileges revoked are those privileges on the identified functions or procedures that were granted to the *authorization-names*. Note that revoking ALL PRIVILEGES on a function or procedure is not the same as revoking the system authority of *ALL.

If you do not use ALL, you must use one or more of the keywords listed below. Each keyword revokes the privilege described.

ALTER

Revokes the privilege to use the ALTER FUNCTION, ALTER PROCEDURE, or COMMENT statement.

EXECUTE

Revokes the privilege to execute a function or procedure.

FUNCTION or SPECIFIC FUNCTION

Identifies the function from which the privilege is revoked. The function must exist at the current server and it must be a user-defined function, but not a function that was implicitly generated with the creation of a distinct type. The function can be identified by its name, function signature, or specific name.

FUNCTION *function-name*

Identifies the function by its name. The *function-name* must identify exactly one function. The function may have any number of parameters defined for it. If there is more than one function of the specified name in the specified or implicit schema, an error is returned.

FUNCTION *function-name (parameter-type, ...)*

Identifies the function by its function signature, which uniquely identifies the function. The *function-name (parameter-type, ...)* must identify a function with the specified function signature. The specified parameters must match the data types in the corresponding position that were specified when the function was created. The number of data types, and the logical concatenation of the data types is used to identify the specific function instance on which the privilege is to be revoked. Synonyms for data types are considered a match. Parameters that have defaults must be included in this signature.

If *function-name ()* is specified, the function identified must have zero parameters.

function-name

Identifies the name of the function.

(parameter-type, ...)

Identifies the parameters of the function.

If an unqualified distinct type name is specified, the database manager searches the SQL path to resolve the schema name for the distinct type.

For data types that have a length, precision, or scale attribute, use one of the following:

- Empty parentheses indicate that the database manager ignores the attribute when determining whether the data types match. For example, DEC() will be considered a match for a parameter of a function defined with a data type of DEC(7,2). However, FLOAT cannot be specified with empty parenthesis because its parameter value indicates a specific data type (REAL or DOUBLE).
- If a specific value for a length, precision, or scale attribute is specified, the value must exactly match the value that was specified (implicitly or explicitly) in the CREATE FUNCTION statement. If the data type is FLOAT, the precision does not have to exactly match the value that was specified because matching is based on the data type (REAL or DOUBLE).
- If length, precision, or scale is not explicitly specified, and empty parentheses are not specified, the default attributes of the data type are implied. The implicit length must exactly match the value that was specified (implicitly or explicitly) in the CREATE FUNCTION statement.

Specifying the FOR DATA clause or CCSID clause is optional. Omission of either clause indicates that the database manager ignores the attribute when determining whether the data types match. If either clause is specified, it must match the value that was implicitly or explicitly specified in the CREATE FUNCTION statement.

AS LOCATOR

Specifies that the function is defined to receive a locator for this parameter. If AS LOCATOR is specified, the data type must be a LOB or XML or a distinct type based on a LOB or XML.

SPECIFIC FUNCTION *specific-name*

Identifies the function by its specific name. The *specific-name* must identify a specific function that exists at the current server.

PROCEDURE or SPECIFIC PROCEDURE

Identifies the procedure from which the privilege is revoked. The *procedure-name* must identify a procedure that exists at the current server.

PROCEDURE *procedure-name*

Identifies the procedure by its name. The *procedure-name* must identify exactly one procedure. The procedure may have any number of parameters defined for it. If there is more than one procedure of the specified name in the specified or implicit schema, an error is returned.

PROCEDURE *procedure-name (parameter-type, ...)*

Identifies the procedure by its procedure signature, which uniquely identifies the procedure. The *procedure-name (parameter-type, ...)* must identify a procedure with the specified procedure signature. The specified parameters must match the data types in the corresponding position that were specified when the procedure was created. The number of data types, and the logical concatenation of the data types is used to identify the specific procedure instance which is to be revoked. Synonyms for data types are considered a match. Parameters that have defaults must be included in this signature.

If *procedure-name ()* is specified, the procedure identified must have zero parameters.

procedure-name

Identifies the name of the procedure.

(parameter-type, ...)

Identifies the parameters of the procedure.

If an unqualified distinct type or array type name is specified, the database manager searches the SQL path to resolve the schema name for the distinct type or array type.

For data types that have a length, precision, or scale attribute, use one of the following:

- Empty parentheses indicate that the database manager ignores the attribute when determining whether the data types match. For example, DEC() will be considered a match for a parameter of a procedure defined with a data type of DEC(7,2). However, FLOAT cannot be specified with empty parenthesis because its parameter value indicates a specific data type (REAL or DOUBLE).
- If a specific value for a length, precision, or scale attribute is specified, the value must exactly match the value that was specified (implicitly or explicitly) in the CREATE PROCEDURE statement. If the data type is FLOAT, the precision does not have to exactly match the value that was specified because matching is based on the data type (REAL or DOUBLE).
- If length, precision, or scale is not explicitly specified, and empty parentheses are not specified, the default attributes of the data type are implied. The implicit length must exactly match the value that was specified (implicitly or explicitly) in the CREATE PROCEDURE statement.

Specifying the FOR DATA clause or CCSID clause is optional. Omission of either clause indicates that the database manager ignores the attribute when determining whether the data types match. If either clause is specified, it must match the value that was implicitly or explicitly specified in the CREATE PROCEDURE statement.

AS LOCATOR

Specifies that the procedure is defined to receive a locator for this parameter. If AS LOCATOR is specified, the data type must be a LOB or XML or a distinct type based on a LOB or XML.

SPECIFIC PROCEDURE *specific-name*

Identifies the procedure by its specific name. The *specific-name* must identify a specific procedure that exists at the current server.

FROM

Identifies from whom the privileges are revoked.

USER

Specifies that the *authorization-name* identifies a user profile. If USER is specified, *authorization-name* must be a user profile.

GROUP

Specifies that the *authorization-name* identifies a group profile. If GROUP is specified, *authorization-name* must be a group profile.

***authorization-name*,...**

Lists one or more authorization IDs. Do not specify the same *authorization-name* more than once.

PUBLIC

Revokes a grant of the privilege to PUBLIC. For more information, see [“Authorization, privileges and object ownership” on page 15](#).

Notes

Multiple grants: If you revoke a privilege on a function or procedure, it nullifies any grant of the privilege on that function or procedure, regardless of who granted it.

Revoking WITH GRANT OPTION: The only way to revoke the WITH GRANT OPTION is to revoke ALL.

Privilege warning: Revoking a specific privilege from a user does not necessarily prevent that user from performing an action that requires that privilege. For example, the user may still have the privilege through PUBLIC privileges or database administrator authority.

Corresponding system authorities: When a function or procedure privilege is revoked, the corresponding system authorities are revoked. For information about the system authorities that correspond to SQL privileges see [“GRANT \(function or procedure privileges\)” on page 1349](#).

Privileges revoked from either an SQL or external function or procedure are revoked from its associated program (*PGM) or service program (*SRVPGM) object. Privileges revoked from a Java external function or procedure are revoked from the associated class file or jar file. If the associated program, service program, class file, or jar file is not found when the revoke is executed, an error is returned.

Syntax alternatives: The following keywords are synonyms supported for compatibility to prior releases. These keywords are non-standard and should not be used:

- The keyword RUN can be used as a synonym for EXECUTE.

Example

Revoke the EXECUTE privilege on procedure PROCA from PUBLIC.

```
REVOKE EXECUTE
ON PROCEDURE PROCA
FROM PUBLIC
```

REVOKE (package privileges)

This form of the REVOKE statement removes the privileges on a package.

Invocation

This statement can be embedded in an application program or issued interactively. It is an executable statement that can be dynamically prepared.

Authorization

The privileges held by the authorization ID of the statement must include at least one of the following:

- For each package identified in the statement:
 - Every privilege specified in the statement
 - The system authority of *OBJMGT on the package
 - The USAGE privilege on the schema containing the package
- Database administrator authority
- Security administrator authority

Syntax

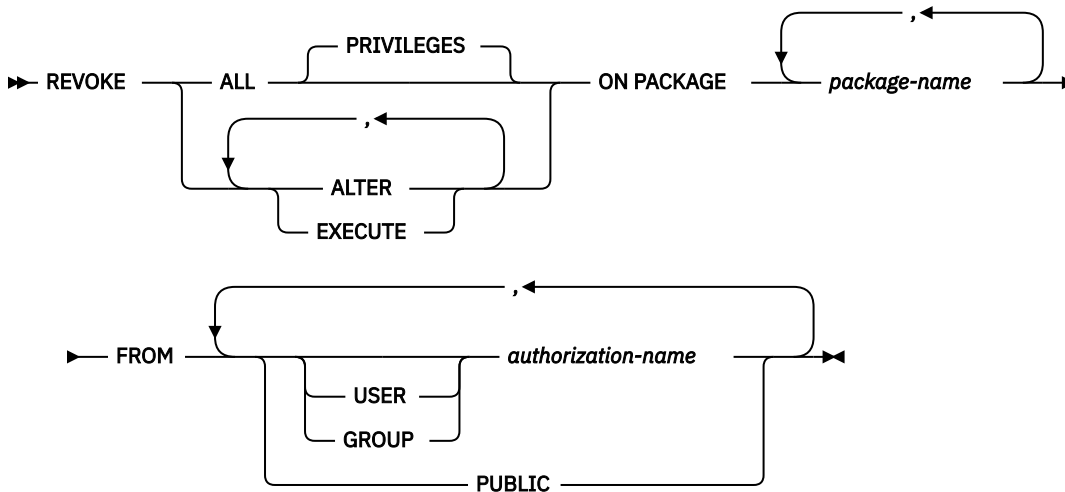

Description

ALL or ALL PRIVILEGES

Revokes one or more package privileges from each *authorization-name*. The privileges revoked are those privileges on the identified packages that were granted to the *authorization-names*. Note that revoking ALL PRIVILEGES on a package is not the same as revoking the system authority of *ALL.

If you do not use ALL, you must use one or more of the keywords listed below. Each keyword revokes the privilege described.

ALTER

Revokes the privilege to use the COMMENT and LABEL statements.

EXECUTE

Revokes the privilege to execute statements in a package.

ON PACKAGE *package-name*

Identifies the package from which the EXECUTE privilege is revoked. The *package-name* must identify a package that exists at the current server.

FROM

Identifies from whom the privileges are revoked.

USER

Specifies that the *authorization-name* identifies a user profile. If USER is specified, *authorization-name* must be a user profile.

GROUP

Specifies that the *authorization-name* identifies a group profile. If GROUP is specified, *authorization-name* must be a group profile.

authorization-name,...

Lists one or more authorization IDs. Do not specify the same *authorization-name* more than once.

PUBLIC

Revokes a grant of the privilege to PUBLIC. For more information, see [“Authorization, privileges and object ownership”](#) on page 15.

Notes

Multiple grants: If you revoke a privilege on a package, it nullifies any grant of the privilege on that package, regardless of who granted it.

Revoking WITH GRANT OPTION: The only way to revoke the WITH GRANT OPTION is to revoke ALL.

Privilege warning: Revoking a specific privilege from a user does not necessarily prevent that user from performing an action that requires that privilege. For example, the user may still have the privilege through PUBLIC privileges or database administrator authority.

Corresponding system authorities: When a package privilege is revoked, the corresponding system authorities are revoked. For information about the system authorities that correspond to SQL privileges see [“GRANT \(package privileges\)”](#) on page 1357.

Syntax alternatives: The following keywords are synonyms supported for compatibility to prior releases. These keywords are non-standard and should not be used:

- The keyword RUN can be used as a synonym for EXECUTE.
- The keyword PROGRAM can be used as a synonym for PACKAGE.

Example

Example 1: Revoke the EXECUTE privilege on package PKGA from PUBLIC.

```
REVOKE EXECUTE
ON PACKAGE PKGA
FROM PUBLIC
```

Example 2: Revoke the EXECUTE privilege on package RRSP_PKG from user FRANK and PUBLIC.

```
REVOKE EXECUTE
ON PACKAGE RRSP_PKG
FROM FRANK, PUBLIC
```

REVOKE (schema privileges)

This form of the REVOKE statement removes the privileges on a schema.

Invocation

This statement can be embedded in an application program or issued interactively. It is an executable statement that can be dynamically prepared.

Authorization

The privileges held by the authorization ID of the statement must include at least one of the following:

- For each schema identified in the statement:
 - Every privilege specified in the statement
 - The system authority of *OBJMGT on the schema
- Database administrator authority
- Security administrator authority

Syntax

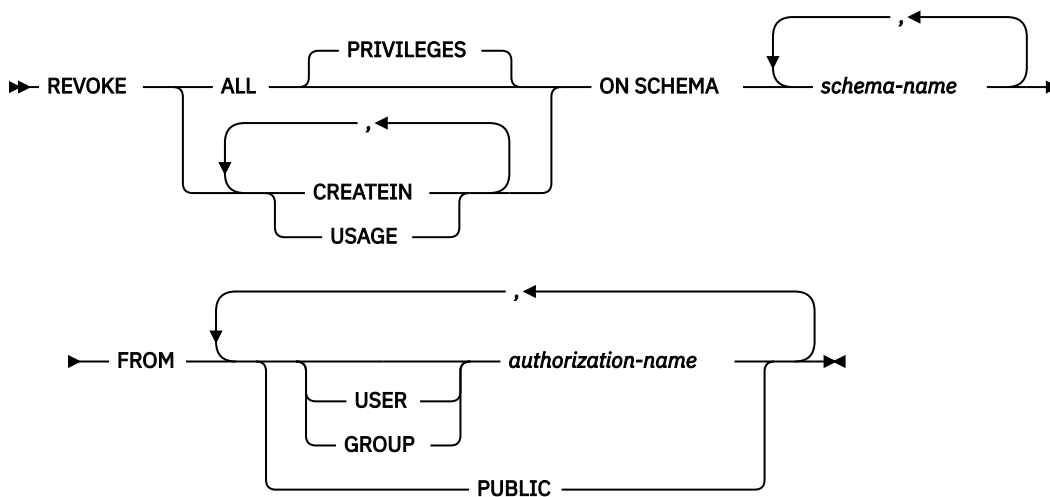

Description

ALL or ALL PRIVILEGES

Revokes one or more schema privileges from each *authorization-name*. The privileges revoked are those privileges on the identified schemas that were granted to the *authorization-names*. Note that revoking ALL PRIVILEGES on a schema is not the same as revoking the system authority of *ALL.

If you do not use ALL, you must use one or more of the keywords listed below. Each keyword revokes the privilege described.

CREATEIN

Revokes the privilege to create objects in the schema.

USAGE

Revokes the privilege to use the schema. USAGE privilege is required to reference any objects that exist in the schema.

ON SCHEMA *schema-name*

Identifies the schema from which the privilege is revoked.

FROM

Identifies from whom the privileges are revoked.

USER

Specifies that the *authorization-name* identifies a user profile. If USER is specified, *authorization-name* must be a user profile.

GROUP

Specifies that the *authorization-name* identifies a group profile. If GROUP is specified, *authorization-name* must be a group profile.

authorization-name,...

Lists one or more authorization IDs. Do not specify the same *authorization-name* more than once.

PUBLIC

Revokes a grant of the privilege to PUBLIC. For more information, see [“Authorization, privileges and object ownership”](#) on page 15.

Notes

Multiple grants: If you revoke a privilege on a schema, it nullifies any grant of the privilege on that schema, regardless of who granted it.

Revoking WITH GRANT OPTION: The only way to revoke the WITH GRANT OPTION is to revoke ALL.

Privilege warning: Revoking a specific privilege from a user does not necessarily prevent that user from performing an action that requires that privilege. For example, the user may still have the privilege through PUBLIC privileges or database administrator authority.

Corresponding system authorities: When a schema privilege is revoked, the corresponding system authorities are revoked. For information on the system authorities that correspond to SQL privileges see [“GRANT \(schema privileges\)”](#) on page 1360.

Example

Example 1: Revoke the CREATEIN privilege on schema T_SCORES from user JONES.

```
REVOKE CREATEIN
ON SCHEMA T_SCORES
FROM JONES;
```

REVOKE (sequence privileges)

This form of the REVOKE statement removes the privileges on a sequence.

Invocation

This statement can be embedded in an application program or issued interactively. It is an executable statement that can be dynamically prepared.

Authorization

The privileges held by the authorization ID of the statement must include at least one of the following:

- For each sequence identified in the statement:
 - Every privilege specified in the statement
 - The system authority of *OBJMGT on the sequence
 - The USAGE privilege on the schema containing the sequence
- Database administrator authority
- Security administrator authority

Syntax

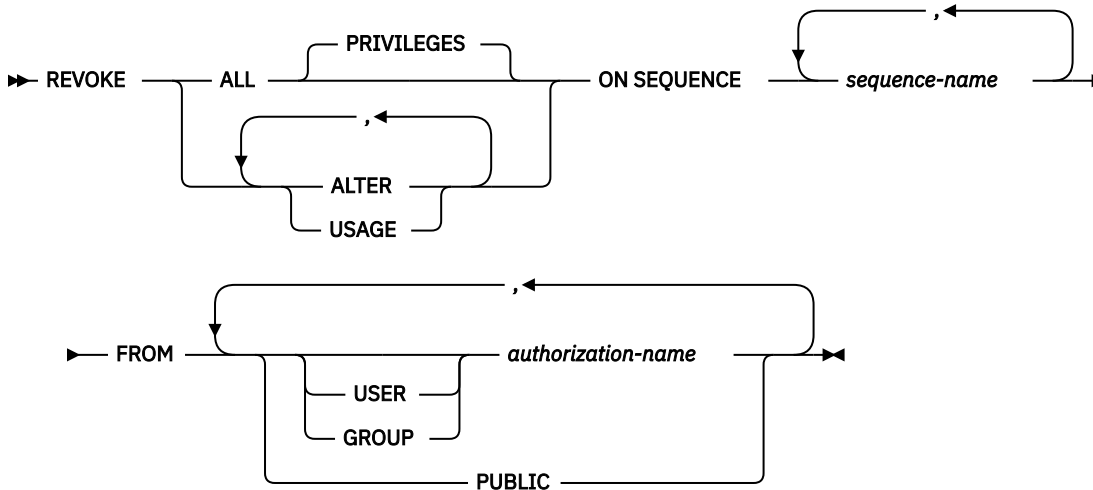

Description

ALL or ALL PRIVILEGES

Revokes one or more sequence privileges from each *authorization-name*. The privileges revoked are those privileges on the identified sequences that were granted to the *authorization-names*. Note that revoking ALL PRIVILEGES on a sequence is not the same as revoking the system authority of *ALL.

If you do not use ALL, you must use one or more of the keywords listed below. Each keyword revokes the privilege described.

ALTER

Revokes the privilege to use the ALTER SEQUENCE, COMMENT, and LABEL statements on a sequence.

USAGE

Revokes the privilege to use the sequence in NEXT VALUE or PREVIOUS VALUE expressions.

ON SEQUENCE *sequence-name*

Identifies the sequence from which the privilege is revoked. The *sequence-name* must identify a sequence that exists at the current server.

FROM

Identifies from whom the privileges are revoked.

USER

Specifies that the *authorization-name* identifies a user profile. If USER is specified, *authorization-name* must be a user profile.

GROUP

Specifies that the *authorization-name* identifies a group profile. If GROUP is specified, *authorization-name* must be a group profile.

authorization-name,...

Lists one or more authorization IDs. Do not specify the same *authorization-name* more than once.

PUBLIC

Revokes a grant of the privilege to PUBLIC. For more information, see [“Authorization, privileges and object ownership”](#) on page 15.

Notes

Multiple grants: If you revoke a privilege on a sequence, it nullifies any grant of the privilege on that sequence, regardless of who granted it.

Revoking WITH GRANT OPTION: The only way to revoke the WITH GRANT OPTION is to revoke ALL.

Privilege warning: Revoking a specific privilege from a user does not necessarily prevent that user from performing an action that requires that privilege. For example, the user may still have the privilege through PUBLIC privileges or database administrator authority.

Corresponding system authorities: When a sequence privilege is revoked, the corresponding system authorities are revoked. For information on the system authorities that correspond to SQL privileges see [“GRANT \(sequence privileges\)”](#) on page 1363.

Example

REVOKE the USAGE privilege from PUBLIC on a sequence called ORG_SEQ.

```
REVOKE USAGE
ON SEQUENCE ORG_SEQ
FROM PUBLIC
```

REVOKE (table or view privileges)

This form of the REVOKE statement removes privileges on a table or view.

Invocation

This statement can be embedded in an application program or issued interactively. It is an executable statement that can be dynamically prepared.

Authorization

The privileges held by the authorization ID of the statement must include at least one of the following:

- For each table or view identified in the statement:
 - Every privilege specified in the statement
 - The system authority of *OBJMGT on the table or view
 - The USAGE privilege on the schema containing the table or view
- Database administrator authority
- Security administrator authority

Syntax

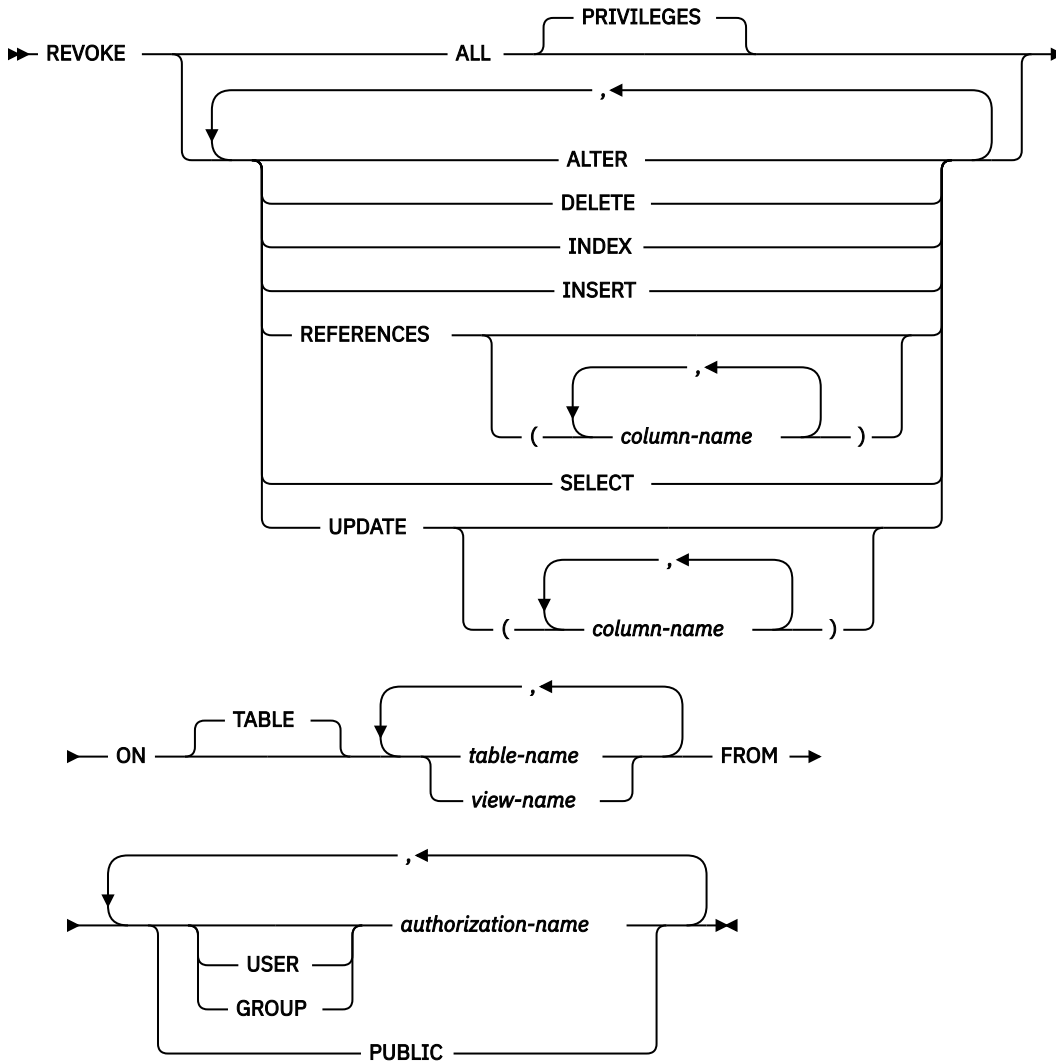

Description

ALL or ALL PRIVILEGES

Revokes one or more privileges from each *authorization-name*. The privileges revoked are those privileges on the identified tables and views that were granted to the *authorization-names*. Note that revoking ALL PRIVILEGES on a table or view is not the same as revoking the system authority of *ALL.

If you do not use ALL, you must use one or more of the keywords listed below. Each keyword revokes the privilege described, but only as it applies to the tables and views named in the ON clause.

ALTER

Revokes the privilege to alter the specified table and the privilege to add a comment, add a label, or create an index on the specified table or view.

DELETE

Revokes the privilege to delete rows from the specified table or view.

INDEX

Revokes the privilege to create an index on the specified table.

INSERT

Revokes the privilege to insert rows in the specified table or view.

REFERENCES

Revokes the privilege to add a referential constraint in which the table is a parent.

REFERENCES (column-name,...)

Revokes the privilege to add a referential constraint using the specified column(s) in the parent key. Each column name must be an unqualified name that identifies a column in each table identified in the ON clause.

SELECT

Revokes the privilege to use the SELECT or CREATE VIEW statement.

UPDATE

Revokes the privilege to use the UPDATE statement.

UPDATE (column-name,...)

Revokes the privilege to update the specified columns. Each column name must be an unqualified name that identifies a column in each table identified in the ON clause.

ON table-name or view-name, ...

Identifies the table or view from which the privileges are revoked. The *table-name* or *view-name* must identify a table or view that exists at the current server, but must not identify a declared temporary table.

FROM

Identifies from whom the privileges are revoked.

USER

Specifies that the *authorization-name* identifies a user profile. If USER is specified, *authorization-name* must be a user profile.

GROUP

Specifies that the *authorization-name* identifies a group profile. If GROUP is specified, *authorization-name* must be a group profile.

authorization-name,...

Lists one or more authorization IDs. Do not specify the same *authorization-name* more than once.

PUBLIC

Revokes a grant of the privilege to PUBLIC. For more information, see [“Authorization, privileges and object ownership”](#) on page 15.

Notes

Multiple grants: If the same privilege is granted to the same user more than once, revoking that privilege from that user nullifies all those grants.

If you revoke a privilege, it nullifies any grant of that privilege, regardless of who granted it.

Revoking WITH GRANT OPTION: The only way to revoke the WITH GRANT OPTION is to revoke ALL.

Privilege warning: Revoking a specific privilege from a user does not necessarily prevent that user from performing an action that requires that privilege. For example, the user may still have the privilege through PUBLIC privileges or database administrator authority.

If more than one system authority will be revoked with an SQL privilege, and any one of the authorities cannot be revoked, then a warning occurs and no authorities will be revoked for that privilege.

Corresponding system authorities: When a table privilege is revoked, the corresponding system authorities are revoked, except:

- When revoking authorities to a table or view, *OBJOPR is revoked only when *ADD, *DLT, *READ, and *UPD have all been revoked.
- When revoking authorities to a view, authorities will not be revoked from any tables or views referenced in the fullselect of the view definition.

For information about the system authorities that correspond to SQL privileges see [“GRANT \(table or view privileges\)”](#) on page 1366.

Revoking either the INDEX or ALTER privilege, revokes the system authority *OBJALTER.

Examples

Example 1: Revoke SELECT privileges on table EMPLOYEE from user ENGLES.

```
REVOKE SELECT
ON TABLE EMPLOYEE
FROM ENGLES
```

Example 2: Revoke update privileges on table EMPLOYEE previously granted to all users. Note that grants to specific users are not affected.

```
REVOKE UPDATE
ON TABLE EMPLOYEE
FROM PUBLIC
```

Example 3: Revoke all privileges on table EMPLOYEE from users PELLOW and ANDERSON.

```
REVOKE ALL
ON TABLE EMPLOYEE
FROM PELLOW, ANDERSON
```

Example 4: Revoke the privilege to update column_1 in VIEW1 from FRED.

```
REVOKE UPDATE(column_1)
ON VIEW1
FROM FRED
```

REVOKE (type privileges)

This form of the REVOKE statement removes the privileges on a type.

Invocation

This statement can be embedded in an application program or issued interactively. It is an executable statement that can be dynamically prepared.

Authorization

The privileges held by the authorization ID of the statement must include at least one of the following:

- For each distinct type or array type identified in the statement:
 - Every privilege specified in the statement
 - The system authority of *OBJMGT on the type
 - The USAGE privilege on the schema containing the type
- Database administrator authority
- Security administrator authority

Syntax

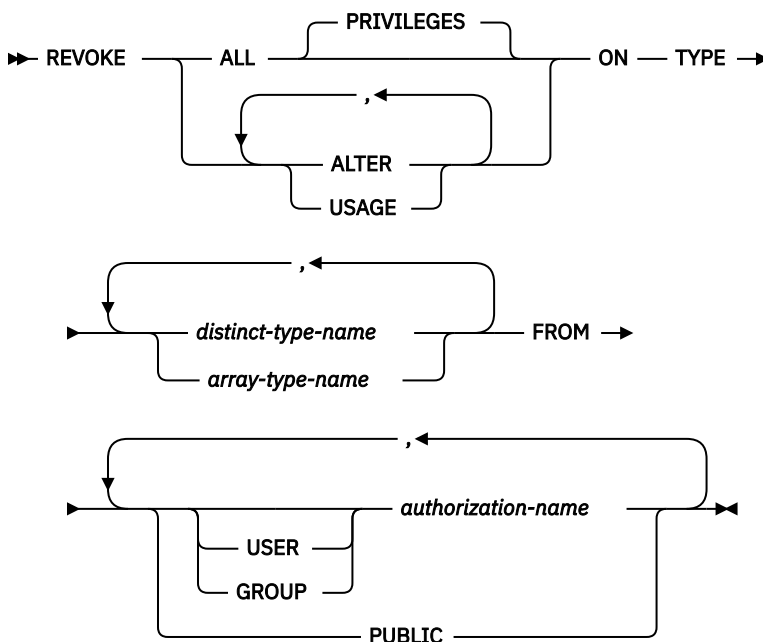

Description

ALL or ALL PRIVILEGES

Revokes one or more type privileges from each *authorization-name*. The privileges revoked are those privileges on the identified user-defined types that were granted to the *authorization-names*. Note that revoking ALL PRIVILEGES on a type is not the same as revoking the system authority of *ALL.

If you do not use ALL, you must use one or more of the keywords listed below. Each keyword revokes the privilege described.

ALTER

Revokes the privilege to use the COMMENT and LABEL statements.

USAGE

Revokes the privilege to use user-defined types in tables, functions, procedures, or as the source type in a CREATE TYPE statement.

ON TYPE *distinct-type-name* or *array-type-name*

Identifies the distinct type from which the privilege is revoked. The *distinct-type-name* or *array-type-name* must identify a user-defined type that exists at the current server.

FROM

Identifies from whom the privileges are revoked.

USER

Specifies that the *authorization-name* identifies a user profile. If USER is specified, *authorization-name* must be a user profile.

GROUP

Specifies that the *authorization-name* identifies a group profile. If GROUP is specified, *authorization-name* must be a group profile.

***authorization-name*,...**

Lists one or more authorization IDs. Do not specify the same *authorization-name* more than once.

PUBLIC

Revokes a grant of the privilege to PUBLIC. For more information, see [“Authorization, privileges and object ownership” on page 15](#).

Notes

Multiple grants: If authorization ID A granted the same privilege to authorization ID B more than once, revoking that privilege from B nullifies all those grants.

Revoking WITH GRANT OPTION: The only way to revoke the WITH GRANT OPTION is to revoke ALL.

Privilege warning: Revoking a specific privilege from a user does not necessarily prevent that user from performing an action that requires that privilege. For example, the user may still have the privilege through PUBLIC privileges or database administrator authority.

Corresponding system authorities: When a type privilege is revoked, the corresponding system authorities are revoked. For information about the system authorities that correspond to SQL privileges see [“GRANT \(type privileges\)” on page 1374](#).

Syntax alternatives: The following keywords are synonyms supported for compatibility to prior releases. These keywords are non-standard and should not be used:

- The keywords DATA TYPE or DISTINCT TYPE can be used as a synonym for TYPE.

Example

Revoke the USAGE privilege on distinct type SHOESIZE from user JONES.

```
REVOKE USAGE
ON DISTINCT TYPE SHOESIZE
FROM JONES
```

REVOKE (variable privileges)

This form of the REVOKE statement removes the privileges on a created global variable.

Invocation

This statement can be embedded in an application program or issued interactively. It is an executable statement that can be dynamically prepared.

Authorization

The privileges held by the authorization ID of the statement must include at least one of the following:

- For each variable identified in the statement:
 - Every privilege specified in the statement
 - The system authority of *OBJMGT on the global variable
 - The USAGE privilege on the schema containing the global variable
- Database administrator authority
- Security administrator authority

Syntax

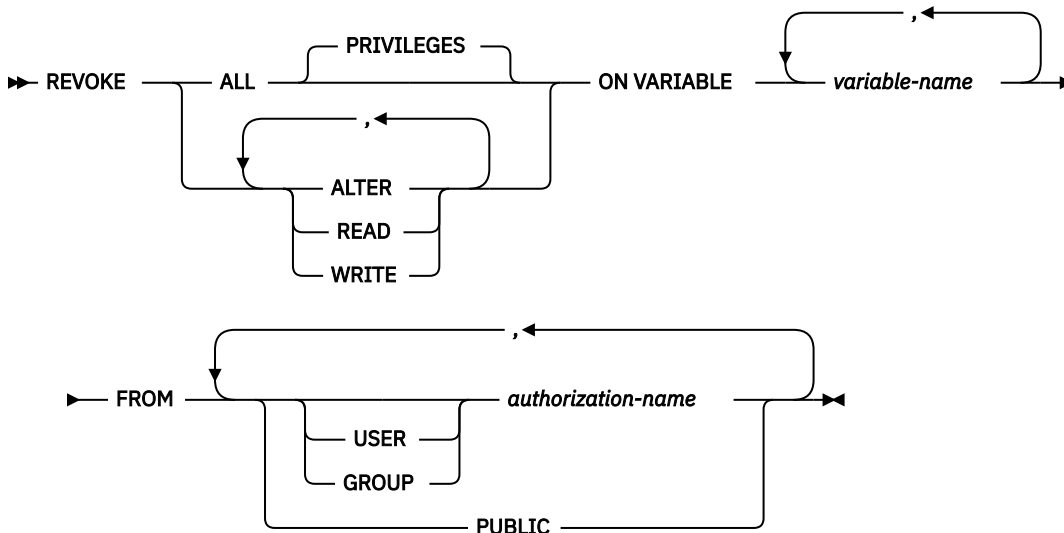

Description

ALL or ALL PRIVILEGES

Revokes one or more global variable privileges from each *authorization-name*. The privileges revoked are those privileges on the identified global variables that were granted to the *authorization-names*. Note that revoking ALL PRIVILEGES on a global variable is not the same as revoking the system authority of *ALL.

If you do not use ALL, you must use one or more of the keywords listed below. Each keyword revokes the privilege described.

ALTER

Revokes the privilege to use COMMENT and LABEL statements on the specified global variables.

READ

Revokes the privilege to read the value of the specified global variables.

WRITE

Revokes the privilege to assign a value to the specified global variables.

ON VARIABLE *variable-name*

Identifies the global variables from which one or more privileges are to be revoked. Each *variable-name* must identify a global variable that exists at the current server.

FROM

Identifies from whom the privileges are revoked.

USER

Specifies that the *authorization-name* identifies a user profile. If USER is specified, *authorization-name* must be a user profile.

GROUP

Specifies that the *authorization-name* identifies a group profile. If GROUP is specified, *authorization-name* must be a group profile.

***authorization-name*,...**

Lists one or more authorization IDs. Do not specify the same *authorization-name* more than once.

PUBLIC

Revokes a grant of the privilege to PUBLIC. For more information, see [“Authorization, privileges and object ownership” on page 15](#).

Notes

Multiple grants: If you revoke a privilege on a variable, it nullifies any grant of the privilege on that variable, regardless of who granted it.

Revoking WITH GRANT OPTION: The only way to revoke the WITH GRANT OPTION is to revoke ALL.

Privilege warning: Revoking a specific privilege from a user does not necessarily prevent that user from performing an action that requires that privilege. For example, the user may still have the privilege through PUBLIC privileges or database administrator authority.

Corresponding system authorities: When a global variable privilege is revoked, the corresponding system authorities are revoked. For information on the system authorities that correspond to SQL privileges see [“GRANT \(variable privileges\)” on page 1377](#).

Example

REVOKE the WRITE privilege on a global variable MYSCHEMA.MYJOB_PRINTER from user ZUBIRI.

```
REVOKE WRITE
ON VARIABLE MYSCHEMA.MYJOB_PRINTER
FROM ZUBIRI
```

REVOKE (XML schema privileges)

This form of the REVOKE statement removes the privileges on an XSR object.

Invocation

This statement can be embedded in an application program or issued interactively. It is an executable statement that can be dynamically prepared.

Authorization

The privileges held by the authorization ID of the statement must include at least one of the following:

- For each XSR object identified in the statement:
 - Every privilege specified in the statement
 - The system authority of *OBJMGT on the XSR object
 - The USAGE privilege on the schema containing the XSR object
- Database administrator authority
- Security administrator authority

Syntax

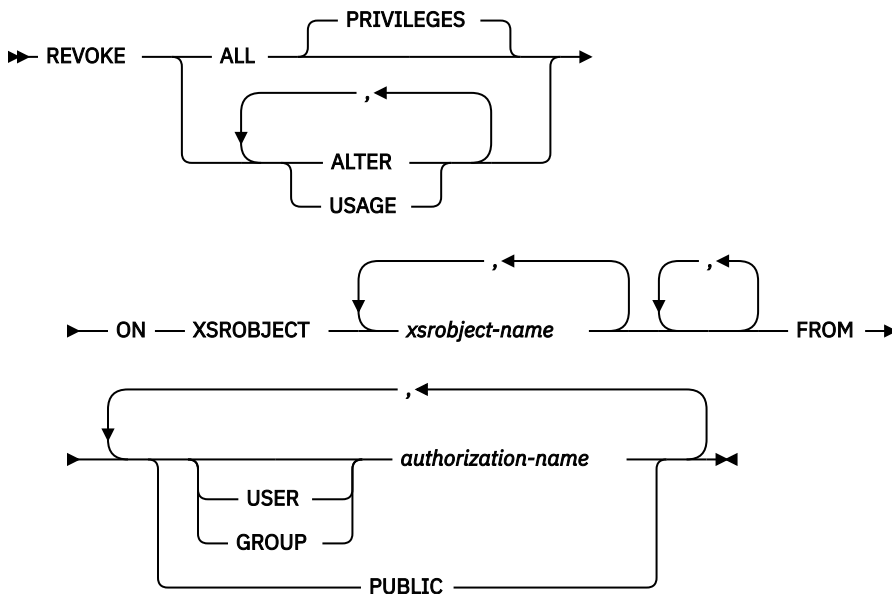

Description

ALL or ALL PRIVILEGES

Revokes one or more XSR object privileges from each *authorization-name*. The privileges revoked are those privileges on the identified XSR objects that were granted to the *authorization-names*. Note that revoking ALL PRIVILEGES on an XSR object is not the same as revoking the system authority of *ALL.

If you do not use ALL, you must use one or more of the keywords listed below. Each keyword revokes the privilege described.

ALTER

Revokes the privilege to use the COMMENT and LABEL statements.

USAGE

Revokes the privilege to use an XSR object.

ON XSRBJECT *xsobject-name*

Identifies the XSR objects for which the privilege is revoked. The *xsobject-name* must identify an XSR object that exists at the current server.

FROM

Identifies from whom the privileges are revoked.

USER

Specifies that the *authorization-name* identifies a user profile. If USER is specified, *authorization-name* must be a user profile.

GROUP

Specifies that the *authorization-name* identifies a group profile. If GROUP is specified, *authorization-name* must be a group profile.

***authorization-name*,...**

Lists one or more authorization IDs. Do not specify the same *authorization-name* more than once.

PUBLIC

Revokes a grant of the privilege to PUBLIC. For more information, see [“Authorization, privileges and object ownership” on page 15](#).

Notes

Multiple grants: If you revoke a privilege on an XSR object, it nullifies any grant of the privilege on that XSR object, regardless of who granted it.

Revoking WITH GRANT OPTION: The only way to revoke the WITH GRANT OPTION is to revoke ALL.

Privilege warning: Revoking a specific privilege from a user does not necessarily prevent that user from performing an action that requires that privilege. For example, the user may still have the privilege through PUBLIC privileges or database administrator authority.

Corresponding system authorities: When an XSR object privilege is revoked, the corresponding system authorities are revoked. For information about the system authorities that correspond to SQL privileges see [“GRANT \(XML schema privileges\)” on page 1380](#).

Example

Revoke the USAGE privilege on XSR object XMLSCHEMA from PUBLIC.

```
REVOKE USAGE
ON XSRBJECT XMLSCHEMA
FROM PUBLIC
```

ROLLBACK

The ROLLBACK statement is used to back out changes.

The ROLLBACK statement can be used to either:

- End a unit of work and back out all the relational database changes that were made by that unit of work. If relational databases are the only recoverable resources used by the application process, ROLLBACK also ends the unit of work.
- Back out only the changes made after a savepoint was set within the unit of work without ending the unit of work. Rolling back to a savepoint enables selected changes to be undone.

Invocation

This statement can be embedded in an application program or issued interactively. It is an executable statement that can be dynamically prepared.

ROLLBACK is not allowed in a trigger if the trigger program and the triggering program run under the same commitment definition. ROLLBACK is not allowed in a procedure if the procedure is called on a Distributed Unit of Work connection to a remote application server or if the procedure is defined as ATOMIC. ROLLBACK is not allowed in a function.

Authorization

None required.

Syntax

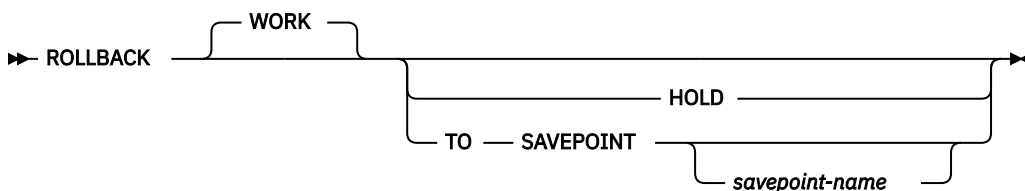

Description

When ROLLBACK is used without the TO SAVEPOINT clause, the unit of work in which it is executed is ended. All changes made by SQL schema statements and SQL data change statements during the unit of work are backed out. For more information see [Chapter 7, “Statements,” on page 793](#).

The generation of identity values is not under transaction control. Values generated and consumed by inserting rows into a table that has an identity column are independent of executing the ROLLBACK statement. Also, executing the ROLLBACK statement does not affect the IDENTITY_VAL_LOCAL function.

Special registers are not under transaction control. Executing a ROLLBACK statement does not affect special registers.

Sequences are not under transaction control. Executing a ROLLBACK statement does not affect the current value generated and consumed by executing a NEXT VALUE expression.

Global variables are not under transaction control. Executing a ROLLBACK statement does not affect the value of any instantiated global variable.

The impact of ROLLBACK or ROLLBACK TO SAVEPOINT on the contents of a declared temporary table is determined by the setting of the ON ROLLBACK clause of the DECLARE GLOBAL TEMPORARY TABLE statement.

WORK

ROLLBACK WORK has the same effect as ROLLBACK.

HOLD

Specifies a hold on resources. If specified, currently open cursors are not closed cursors whether they are declared with a HOLD option or not. All resources acquired during the unit of work, except locks on the rows of tables, are held. Locks on specific rows implicitly acquired during the unit of work, however, are released.

At the end of a ROLLBACK HOLD, the cursor position is the same as it was at the start of the unit of work, unless

- ALWBLK(*ALLREAD) was specified when the program or routine that contains the cursor was created
- ALWBLK(*READ) and ALWCPYDTA(*OPTIMIZE) were specified when the program or routine that contains the cursor was created

TO SAVEPOINT

Specifies that the unit of work is not to be ended and that only a partial rollback (to a savepoint) is to be performed. If a savepoint name is not specified, rollback is to the last active savepoint. For example, if in a unit of work, savepoints A, B, and C are set in that order and then C is released, ROLLBACK TO SAVEPOINT causes a rollback to savepoint B. If no savepoint is active, an error is returned.

savepoint-name

Identifies the savepoint to which to roll back. The name must identify a savepoint that exists at the current server.

After a successful ROLLBACK TO SAVEPOINT, the savepoint continues to exist.

All database changes (including changes made to declared temporary tables that were declared with the ON ROLLBACK PRESERVE ROWS clause) that were made after the savepoint was set are backed out. All locks and LOB locators are retained.

The impact on cursors resulting from a ROLLBACK TO SAVEPOINT depends on the statements within the savepoint:

- If the savepoint contains SQL schema statements on which a cursor is dependent, the cursor is closed. Attempts to use such a cursor after a ROLLBACK TO SAVEPOINT results in an error.
- Otherwise, the cursor is not affected by the ROLLBACK TO SAVEPOINT (it remains open and positioned).

Any savepoints at the current server that are set after the one to which rollback is performed are released. The savepoint to which rollback is performed is not released.

Notes

Recommended coding practices: Code an explicit COMMIT or ROLLBACK statement at the end of an application process. Either an implicit commit or rollback operation will be performed at the end of an application process depending on the application environment. Thus, a portable application should explicitly execute a COMMIT or ROLLBACK before execution ends in those environments where explicit COMMIT or ROLLBACK is permitted.

Other effects of rollback: Rollback without the TO SAVEPOINT clause and HOLD clause causes the following to occur:

- All cursors that were opened during the unit of work are closed whether they are declared with a HOLD option or not.
- All LOB locators, including those that are held, are freed.
- All locks acquired under this unit of work's commitment definition are released.

ROLLBACK has no effect on the state of connections.

Implicit ROLLBACK: The ending of the default activation group causes an implicit rollback. Thus, an explicit COMMIT or ROLLBACK statement should be issued before the end of the default activation group.

A ROLLBACK is automatically performed when:

1. The default activation group ends without a final COMMIT being issued.
2. A failure occurs that prevents the activation group from completing its work (for example, a power failure).

If the unit of work is in the prepared state because a COMMIT was in progress when the failure occurred, a rollback is not performed. Instead, resynchronization of all the connections involved in the unit of work will occur. For more information, see the [Commitment control](#) topic collection.

3. A failure occurs that causes a loss of the connection to an application server (for example, a communications line failure).

If the unit of work is in the prepared state because a COMMIT was in progress when the failure occurred, a rollback is not performed. Instead, resynchronization of all the connections involved in the unit of work will occur. For more information, see the [Commitment control](#) topic collection.

4. An activation group other than the default activation group ends abnormally.

Row lock limit: A unit of work may include the processing of up to and including 4 million rows, including rows retrieved during a SELECT INTO or FETCH statement, and rows inserted, deleted, or updated as part of INSERT, DELETE, and UPDATE operations.¹²⁶

Unaffected statements: The commit and rollback operations do not affect the DROP SCHEMA statement, and this statement is not, therefore, allowed if the current isolation level is anything other than No Commit (NC).

ROLLBACK restrictions: A ROLLBACK statement is not allowed if commitment control is not active for the activation group. For information about determining which commitment definition is used, see the [commitment definition](#) discussion in the COMMIT statement.

A commit or rollback in a user-defined function in a secondary thread is not allowed.

ROLLBACK has no effect on the state of connections.

If, within a unit of work, a CLOSE is followed by a ROLLBACK, all changes made within the unit of work are backed out. The CLOSE itself is not backed out and the file is not reopened.

Examples

Example 1: See the [“Example” on page 942](#) under COMMIT for examples using the ROLLBACK statement.

Example 2: After a unit of recovery started, assume that three savepoints A, B, and C were set and that C was released:

```
SAVEPOINT A ON ROLLBACK RETAIN CURSORS;  
...  
SAVEPOINT B ON ROLLBACK RETAIN CURSORS;  
...  
SAVEPOINT C ON ROLLBACK RETAIN CURSORS;  
...  
RELEASE SAVEPOINT C
```

Roll back all database changes only to savepoint A:

```
ROLLBACK WORK TO SAVEPOINT A
```

¹²⁵ Unless you specified COMMIT(*CHG) or COMMIT(*CS), in which case these rows are not included in this total.

¹²⁶ This limit also includes:

- Any rows accessed or changed through files opened under commitment control through high-level language file processing
- Any rows deleted, updated, or inserted as a result of a trigger or CASCADE, SET NULL, or SET DEFAULT referential integrity delete rule.

If a savepoint name was not specified (that is, ROLLBACK WORK TO SAVEPOINT), the rollback would be to the last active savepoint that was set, which is B.

SAVEPOINT

The SAVEPOINT statement sets a savepoint within a unit of work to identify a point in time within the unit of work to which relational database changes can be rolled back.

Invocation

This statement can be embedded in an application program or issued interactively. It is an executable statement that can be dynamically prepared.

Authorization

None required.

Syntax

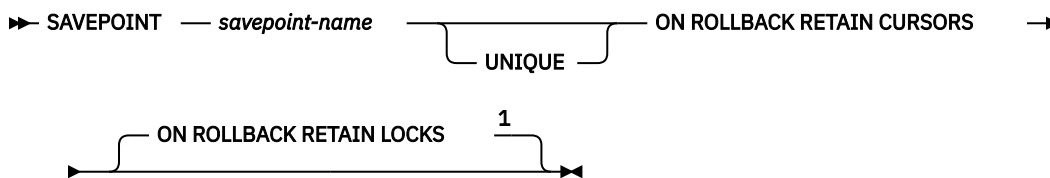

Notes:

¹ The ROLLBACK options can be specified in any order.

Description

savepoint-name

Identifies a new *savepoint*. The specified *savepoint-name* cannot begin with 'SYS'.

UNIQUE

Specifies that the application program cannot reuse the savepoint name within the unit of work. An error occurs if a savepoint with the same name as *savepoint-name* already exists within the unit of work.

Omitting UNIQUE indicates that the application can reuse the savepoint name within the unit of work. If *savepoint-name* identifies a savepoint that already exists within the unit of work and the savepoint was not created with the UNIQUE option, the existing savepoint is destroyed and a new savepoint is created. Destroying a savepoint to reuse its name for another savepoint is not the same as releasing the savepoint. Reusing a savepoint name destroys only one savepoint. Releasing a savepoint with the RELEASE SAVEPOINT statement releases the savepoint and all savepoints that have been subsequently set.

ON ROLLBACK RETAIN CURSORS

Specifies that cursors that are opened after the savepoint is set are not closed upon rollback to the savepoint.

- If SQL schema statements are executed for a table or view within the scope of the SAVEPOINT statement, any cursor that references that table or view is closed. Attempts to use such a cursor after a ROLLBACK TO SAVEPOINT results in an error.
- Otherwise, the cursor is not affected by the ROLLBACK TO SAVEPOINT (it remains open and positioned).

Although these cursors remain open after rollback to the savepoint, they might not be usable. For example, if rolling back to the savepoint causes the insertion of a row on which the cursor is positioned to be rolled back, using the cursor to update or delete the row results in an error.

ON ROLLBACK RETAIN LOCKS

Specifies that any locks that are acquired after the savepoint is set are not released on rollback to the savepoint.

Notes

Savepoint persistence: A savepoint, *S*, is destroyed when:

- A COMMIT or ROLLBACK (without a TO SAVEPOINT clause) statement is executed.
- A ROLLBACK TO SAVEPOINT statement is executed that specifies savepoint *S* or a savepoint that was established earlier than *S* in the unit of work.
- A RELEASE SAVEPOINT statement is executed that specifies savepoint *S* or a savepoint that was established earlier than *S* in the unit of work.
- A SAVEPOINT statement specifies the same name as an existing savepoint that was not created with the UNIQUE keyword.

Effect on INSERT: In an application, inserts may be buffered. The buffer will be flushed when SAVEPOINT, ROLLBACK, or RELEASE TO SAVEPOINT statements are issued.

SAVEPOINT restriction: A SAVEPOINT statement is not allowed if commitment control is not active for the activation group. For information about determining which commitment definition is used, see [“Notes” on page 940](#) in COMMIT statement.

Example

Assume that you want to set three savepoints at various points in a unit of work. Name the first savepoint A and allow the savepoint name to be reused. Name the second savepoint B and do not allow the name to be reused. Because you no longer need savepoint A when you are ready to set the third savepoint, reuse A as the name of the savepoint.

```
SAVEPOINT A ON ROLLBACK RETAIN CURSORS;  
.  
.  
SAVEPOINT B UNIQUE ON ROLLBACK RETAIN CURSORS;  
.  
.  
SAVEPOINT A ON ROLLBACK RETAIN CURSORS;
```

SELECT

The SELECT statement is a form of query. It can be embedded in an SQLJ application program or issued interactively.

For detailed information, see [“select-clause” on page 725](#) and [Chapter 6, “Queries,” on page 723](#).

SELECT INTO

The SELECT INTO statement produces a result table consisting of at most one row, and assigns the values in that row to variables.

Invocation

This statement can only be embedded in an application program. It is an executable statement that cannot be dynamically prepared. It must not be specified in REXX.

Authorization

The privileges held by the authorization ID of the statement must include at least one of the following:

- For each table or view identified in the statement,
 - The SELECT privilege on the table or view, and
 - The USAGE privilege on the schema containing the table or view
- Database administrator authority

If a global variable is specified in the INTO variable list, the privileges held by the authorization ID of the statement must include at least one of the following:

- The WRITE privilege on the global variable.
- Database administrator authority

For information about the system authorities corresponding to SQL privileges, see [Corresponding System Authorities When Checking Privileges to a Table or View](#).

Syntax

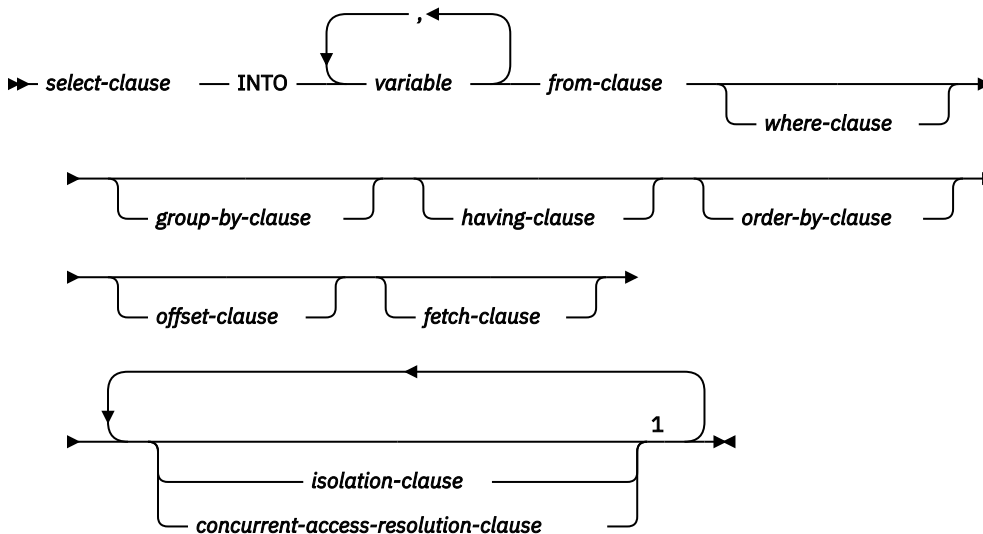

Notes:

- ¹ Each clause may be specified only once.

Description

The result table is derived by evaluating the `isolation-clause`, `concurrent-access-resolution-clause`, `from-clause`, `where-clause`, `group-by-clause`, `having-clause`, `order-by-clause`, `offset-clause`, `fetch-clause`, and `select-clause`, in this order.

See Chapter 6, “Queries,” on page 723 for a description of the *select-clause*, *from-clause*, *where-clause*, *group-by-clause*, *having-clause*, *order-by-clause*, *offset-clause*, *fetch-clause*, *isolation-clause*, and *concurrent-access-resolution-clause*.

INTO variable,...

Identifies one or more host structures or variables that must be declared in the program in accordance with the rules for declaring host structures and variables. In the operational form of the INTO clause, a reference to a host structure is replaced by a reference to each of its variables. The first value in the result row is assigned to the first variable in the list, the second value to the second variable, and so on. The data type of each variable must be compatible with its corresponding column.

Notes

Variable assignment: Each assignment to a variable is performed according to the retrieval assignment rules described in “Assignments and comparisons” on page 91.¹²⁷ If the number of variables is less than the number of values in the row, an SQL warning (SQLSTATE 01503) is returned (and the SQLWARN3 field of the SQLCA is set to 'W'). Note that there is no warning if there are more variables than the number of result columns. If a value is null, an indicator variable must be provided for that value.

If the specified variable is character and is not large enough to contain the result, a warning (SQLSTATE 01004) is returned (and 'W' is assigned to SQLWARN1 in the SQLCA). The actual length of the result may be returned in the indicator variable associated with the variable, if an indicator variable is provided. For further information, see “Variables” on page 139.

If an assignment error occurs, the value of that variable and any following variables is unpredictable. Any values that have already been assigned to variables remain assigned.

Multiple assignments: If more than one variable is specified in the INTO clause, the query is completely evaluated before the assignments are performed. Thus, references to a *variable* in the select list are always the value of the *variable* prior to any assignment in the SELECT INTO statement.

Empty result table: If the result table is empty, the statement assigns '02000' to the SQLSTATE variable and does not assign values to the variables.

Result tables with more than one row: If more than one row satisfies the search condition, statement processing is terminated and an error is returned (SQLSTATE 21000). If an error occurs because the result table has more than one row, values may or may not be assigned to the variables. If values are assigned to the variables, the row that is the source of the values is undefined and not predictable.

Result column evaluation considerations: If an error occurs while evaluating a result column in the select list of a SELECT INTO statement, as the result of an arithmetic expression (such as division by zero, or overflow) or a numeric or character conversion error, the result is the null value. As in any other case of a null value, an indicator variable must be provided. The value of the variable is undefined. In this case, however, the indicator variable is set to the value of -2. Processing of the statement continues and a warning is returned. If an indicator variable is not provided, an error is returned and no more values are assigned to variables. It is possible that some values have already been assigned to variables and will remain assigned when the error is returned.

When a datetime value is returned, the length of the variable must be large enough to store the complete value. Otherwise, depending on how much of the value would have to be truncated, a warning or an error is returned. See “Datetime assignments” on page 97 for details.

Examples

Example 1: Using a COBOL program statement, put the maximum salary (SALARY) from the EMPLOYEE table into the host variable MAX-SALARY (DECIMAL(9,2)).

```
EXEC SQL  SELECT MAX(SALARY)
          INTO :MAX-SALARY
```

¹²⁷ If assigning to an SQL-variable or SQL-parameter and the standards option is specified, storage assignment rules apply. For information about the standards option, see “Standards compliance” on page xix.

```
FROM EMPLOYEE WITH CS
END-EXEC.
```

Example 2: Using a Java program statement, select the row from the EMPLOYEE table on the connection context 'ctx' with an employee number (EMPNO) value the same as that stored in the host variable HOST_EMP (java.lang.String). Then put the last name (LASTNAME) and education level (EDLEVEL) from that row into the host variables HOST_NAME (String) and HOST_EDUCATE (Integer).

```
#sql [ctx] { SELECT LASTNAME, EDLEVEL
             INTO :HOST_NAME, :HOST_EDUCATE
             FROM EMPLOYEE
             WHERE EMPNO = :HOST_EMP   };
```

Example 3: Put the row for employee 528671, from the EMPLOYEE table, into the host structure EMPREC. Assume that the row will be updated later and should be locked when the query executes.

```
EXEC SQL SELECT *
          INTO :EMPREC
          FROM EMPLOYEE
          WHERE EMPNO = '528671'
          WITH RS USE AND KEEP EXCLUSIVE LOCKS
END-EXEC.
```

SET CONNECTION

The SET CONNECTION statement establishes the current server of the activation group by identifying one of its existing connections.

Invocation

This statement can only be embedded within an application program or issued interactively. It is an executable statement that cannot be dynamically prepared. It must not be specified in Java or REXX.

SET CONNECTION is not allowed in a trigger or function.

Authorization

If a global variable is referenced in a statement, the privileges held by the authorization ID of the statement must include at least one of the following:

- For the global variable identified in the statement,
 - The READ privilege on the global variable, and
 - The USAGE privilege on the schema containing the global variable
- Database administrator authority

Syntax

➔ SET CONNECTION 

Description

server-name or variable

Identifies the connection by the specified server name or the server name contained in the variable. It can be a global variable if it is qualified with schema name. If a variable is specified:

- It must be a character-string variable with a length attribute that is not greater than 18.
- It must not be followed by an indicator variable.
- The server name must be left-justified within the variable and must conform to the rules for forming an ordinary identifier.
- If the length of the server name is less than the length of the variable, it must be padded on the right with blanks.

Let S denote the specified server name or the server name contained in the variable. S must identify an existing connection of the application process. If S identifies the current connection, the state of S and all other connections of the application process are unchanged, but information about S is placed in the SQLERRP field of the SQLCA. The following rules apply when S identifies a dormant connection.

If the SET CONNECTION statement is successful:

- Connection S is placed in the current state.
- S is placed in the CURRENT SERVER special register.
- Information about the application server is placed in the *connection-information-items* in the SQL Diagnostics Area.
- Information about application server S is also placed in the SQLERRP field of the SQLCA. If the application server is an IBM relational database product, the information has the form *pppvrrm*, where:
 - *ppp* identifies the product as follows:
 - ARI for Db2 for VSE and VM

- DSN for Db2 for z/OS
- QSQ for Db2 for i
- SQL for all other Db2 products
- *vv* is a two-digit version identifier such as '04'
- *rr* is a two-digit release identifier such as '01'
- *m* is a one-digit modification level such as '0'

For example, if the application server is Version 4 of Db2 for z/OS, the value of SQLERRP is 'DSN04010'.

- Additional information about the connection is available from the DB2_CONNECTION_STATUS and DB2_CONNECTION_TYPE connection information items in the SQL Diagnostics Area.

The DB2_CONNECTION_STATUS connection information item indicates the status of connection for this unit of work. It will have one of the following values:

- 1 - Committable updates can be performed on the connection for this unit of work.
- 2 - No committable updates can be performed on the connection for this unit of work.

The DB2_CONNECTION_TYPE connection information item indicates the type of connection. It will have one of the following values:

- 1 - Connection is to a local relational database.
- 2 - Connection is to a remote relational database with the conversation unprotected.
- 3 - Connection is to a remote relational database with the conversation protected.
- 4 - Connection is to an application requester driver program.

- Additional information about the connection is also placed in the SQLERRD(4) field of the SQLCA. SQLERRD(4) will contain a value indicating whether the application server allows committable updates to be performed. Following is a list of values and their meanings for the SQLERRD(4) field of the SQLCA on the CONNECT :

- 1 - Committable updates can be performed and either the connection uses an unprotected conversation, is a connection established to an application requester driver program using a CONNECT (Type 1) statement, or is a local connection established using a CONNECT (Type 1) statement.
- 2 - No committable updates can be performed; conversation is unprotected.
- 3 - It is unknown if committable updates can be performed; conversation is protected.
- 4 - It is unknown if committable updates can be performed; conversation is unprotected.
- 5 - It is unknown if committable updates can be performed and the connection is either a local connection established using a CONNECT (Type 2) statement or a connection to an application requester driver program established using a CONNECT (Type 2) statement.

- Additional information about the connection is placed in the SQLERRMC field of the SQLCA. Refer to Appendix B, "SQL Communication Area" for a description of the information in the SQLERRMC field.
- Any previously current connection is placed in the dormant state.

If the SET CONNECTION statement is unsuccessful, the connection state of the activation group and the states of its connections are unchanged.

Notes

SET CONNECTION for CONNECT (Type 1): The use of CONNECT (Type 1) statements does not prevent the use of SET CONNECTION, but the statement either fails or does nothing because dormant connections do not exist.

Status after connection is restored: When a connection is used, made dormant, and then restored to the current state in the same unit of work, the status of locks, cursors, and prepared statements for that connection reflects its last use by the activation group.

Local connections: A SET CONNECTION to a local connection will fail if the current independent auxiliary Storage pool (IASP) name space does not match the local connection's relational database.

Example

Execute SQL statements at TOROLAB1, execute SQL statements at TOROLAB2, and then execute more SQL statements at TOROLAB1.

```
EXEC SQL CONNECT TO TOROLAB1;
```

(Execute statements referencing objects at TOROLAB1)

```
EXEC SQL CONNECT TO TOROLAB2;
```

(Execute statements referencing objects at TOROLAB2)

```
EXEC SQL SET CONNECTION TOROLAB1;
```

(Execute statements referencing objects at TOROLAB1)

The first CONNECT statement creates the TOROLAB1 connection, the second CONNECT statement places it in the dormant state, and the SET CONNECTION statement returns it to the current state.

SET CURRENT DEBUG MODE

The SET CURRENT DEBUG MODE statement assigns a value to the CURRENT DEBUG MODE special register.

Invocation

This statement can be embedded in an application program or issued interactively. It is an executable statement that can be dynamically prepared.

Authorization

None.

Syntax

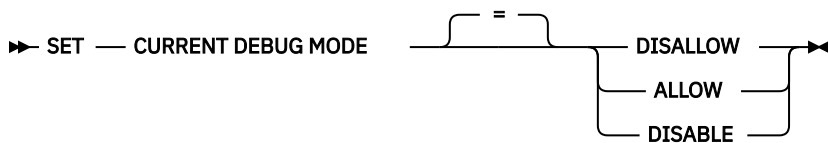

Description

The value of CURRENT DEBUG MODE is replaced by the specified keyword:

DISALLOW

Procedures will be created so they cannot be debugged by the Unified Debugger. When the DEBUG MODE attribute of a procedure is DISALLOW, the procedure can be subsequently altered to change the DEBUG MODE attribute.

ALLOW

Procedures will be created so they can be debugged by the Unified Debugger. When the DEBUG MODE attribute of a procedure is ALLOW, the procedure can be subsequently altered to change the DEBUG MODE attribute.

DISABLE

Procedures will be created so they cannot be debugged by the Unified Debugger. When the DEBUG MODE attribute of a procedure is DISABLE, the procedure cannot be subsequently altered to change the DEBUG MODE attribute.

Notes

Transaction considerations: The SET CURRENT DEBUG MODE statement is not a committable operation. ROLLBACK has no effect on the current debug mode.

Initial current debug mode: The initial value of the current debug mode is DISALLOW.

Current debug mode scope: The scope of the current debug mode is the activation group.

Example

Example 1: The following statement sets the CURRENT DEBUG MODE to allow subsequent procedures created by the CREATE PROCEDURE (SQL) statement to be debuggable.

```
SET CURRENT DEBUG MODE = ALLOW
```

Example 2: The following statement sets the CURRENT DEBUG MODE to disallow subsequent procedures created by the CREATE PROCEDURE (SQL) statement to be debuggable and to prevent those procedures from being altered to make them debuggable.

SET CURRENT DEBUG MODE = DISABLE

SET CURRENT DECFLOAT ROUNDING MODE

The SET CURRENT DECFLOAT ROUNDING MODE statement changes the value of the CURRENT DECFLOAT ROUNDING MODE special register.

Invocation

This statement can be embedded in an application program or issued interactively. It is an executable statement that can be dynamically prepared.

Authorization

If a global variable is referenced in the statement, the privileges held by the authorization ID of the statement must include at least one of the following:

- For the global variable identified in the statement,
 - The READ privilege on the global variable, and
 - The USAGE privilege on the schema containing the global variable
- Database administrator authority

Syntax

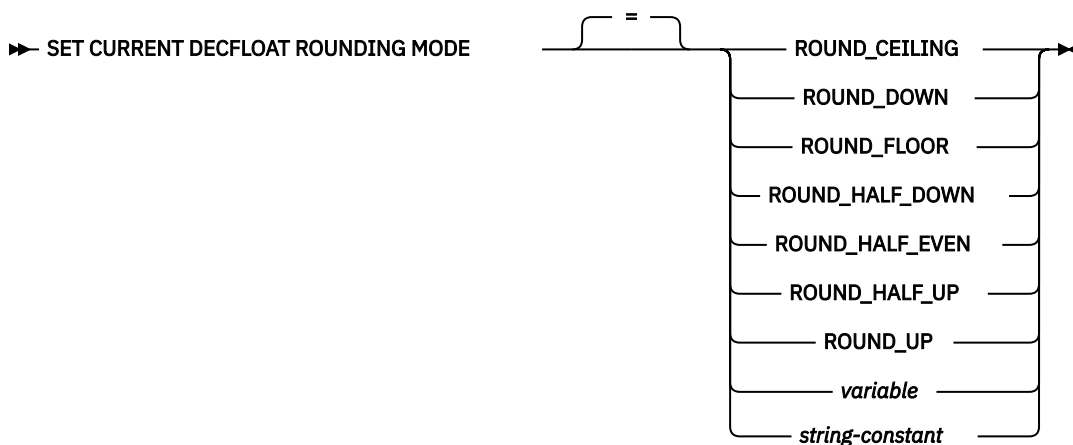

Description

ROUND_CEILING

Round toward +Infinity. If all of the discarded digits are zero or if the sign is negative, the result is unchanged other than the removal of discarded digits. Otherwise, the result coefficient is incremented by one (rounded up).

ROUND_DOWN

Round toward zero (truncation). The discarded digits are ignored.

ROUND_FLOOR

Round toward -Infinity. If all of the discarded digits are zero or if the sign is positive, the result is unchanged other than the removal of the discarded digits. Otherwise, the sign is negative and the result coefficient is incremented by one.

ROUND_HALF_DOWN

Round to nearest; if equidistant, round down. If the discarded digits represent greater than half (0.5) of the value of a one in the next left position, then the result coefficient is incremented by one (rounded up). Otherwise, the discarded digits are ignored.

This rounding mode is not recommended when creating a portable application since it is not supported by the IEEE draft standard for floating-point arithmetic.

ROUND_HALF_EVEN

Round to nearest; if equidistant, round so that the final digit is even. If the discarded digits represent greater than half (0.5) of the value of a one in the next left position, then the result coefficient is incremented by one (rounded up). If they represent less than half, then the result coefficient is not adjusted (that is, the discarded digits are ignored). Otherwise (they represent exactly half), the result coefficient is unaltered if its rightmost digit is even or incremented by one (rounded up) if its rightmost digit is odd (to make an even digit).

ROUND_HALF_UP

Round to nearest; if equidistant, round up. If the discarded digits represent greater than or equal to half (0.5) of the value of a one in the next left position, then the result coefficient is incremented by one (rounded up). Otherwise, the discarded digits are ignored.

ROUND_UP

Round away from zero. If all of the discarded digits are zero, the result is unchanged other than the removal of discarded digits. Otherwise, the result coefficient is incremented by one (rounded up).

This rounding mode is not recommended when creating a portable application since it is not supported by the IEEE draft standard for floating-point arithmetic.

string-constant

A character constant that contains a specification of the rounding mode.

variable

Specifies a variable which contains the value for the CURRENT DECFLOAT ROUNDING MODE. The content is not folded to uppercase.

The variable:

- Must be a character-string or Unicode graphic-string variable.
- Must not be followed by an indicator variable.
- Must contain one of the seven rounding mode keywords.
- Must be padded on the right with blanks if the variable is fixed length.

Notes

Transaction considerations: The SET CURRENT DECFLOAT ROUNDING MODE statement is not a committable operation. ROLLBACK has no effect on the CURRENT DECFLOAT ROUNDING MODE.

Initial CURRENT DECFLOAT ROUNDING MODE: The initial value of CURRENT DECFLOAT ROUNDING MODE in an activation group is established by the first SQL statement that is executed in the activation group.

- If the first SQL statement in an activation group is executed from an SQL program or SQL package, the CURRENT DECFLOAT ROUNDING MODE special register is set to the value of the DECFLTRND parameter.
- Otherwise, the initial value is ROUND_HALF_EVEN.

CURRENT DECFLOAT ROUNDING MODE scope is activation group.

Examples

Example 1: Set the CURRENT DECFLOAT ROUNDING MODE special register to ROUND_DOWN using a string constant and using a keyword.

```
SET CURRENT DECFLOAT ROUNDING MODE = 'ROUND_DOWN'
```

```
SET CURRENT DECFLOAT ROUNDING MODE = ROUND_DOWN
```

SET CURRENT DEGREE

The SET CURRENT DEGREE statement assigns a value to the CURRENT DEGREE special register.

Invocation

This statement can be embedded in an application program or issued interactively. It is an executable statement that can be dynamically prepared. It must not be specified in REXX.

Authorization

The privileges held by the authorization ID of the statement must include *JOBCTL special authority or be authorized to the SQL Administrator function of IBM i through Application Administration in System i Navigator. The Change Function Usage (CHGFCNUSG) command, with a function ID of QIBM_DB_SQLADM, can also be used to change the list of authorized users.

If a global variable is referenced in the statement, the privileges held by the authorization ID of the statement must include at least one of the following:

- For the global variable identified in the statement,
 - The READ privilege on the global variable, and
 - The USAGE privilege on the schema containing the global variable
- Database administrator authority

Syntax

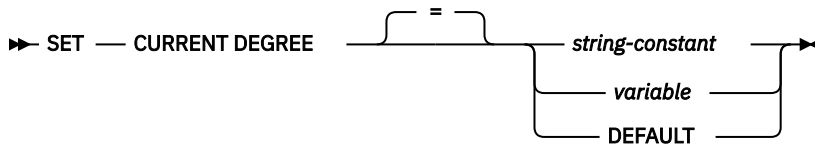

Description

The value of CURRENT DEGREE is replaced by the value of the string constant or variable.

string-constant

Specifies a character string constant. The content is not folded to uppercase.

The length of the *string-constant* must not exceed 5 after trimming any leading and trailing blanks.

variable

Specifies a variable that contains the value for CURRENT DEGREE.

The variable:

- Must be a CHAR, VARCHAR, Unicode GRAPHIC, or Unicode VARGRAPHIC variable. The actual length of the contents of the *variable* must not be greater than 5 after trimming any leading and trailing blanks.
- Must not be the null value.
- Must have contents in uppercase characters. All characters are case-sensitive and are not converted to uppercase characters.

DEFAULT

If the PARALLEL_DEGREE parameter in a current query options file (QAQQINI) is specified, the CURRENT DEGREE will be reset to the PARALLEL_DEGREE. Otherwise, the CURRENT DEGREE will be reset from the degree specified by the QQRYDEGREE system value.

The value of the string constant or variable must be one of the following:

1

No parallel processing is allowed.

2 through 32767

Specifies the degree of parallelism that will be used.

ANY

Specifies that the database manager can choose to use any number of tasks for either I/O or SMP parallel processing.

Use of parallel processing and the number of tasks used is determined based on the number of processors available in the system, this job's share of the amount of active memory available in the pool in which the job is run, and whether the expected elapsed time for the operation is limited by CPU processing or I/O resources. The database manager chooses an implementation that minimizes elapsed time based on the job's share of the memory in the pool.

NONE

No parallel processing is allowed.

MAX

The database manager can choose to use any number of tasks for either I/O or SMP parallel processing. MAX is similar to ANY except the database manager assumes that all active memory in the pool can be used.

IO

Any number of tasks can be used when the database manager chooses to use I/O parallel processing for queries. SMP is not allowed.

Notes

Transaction considerations: The SET CURRENT DEGREE statement is not a committable operation. ROLLBACK has no effect on CURRENT DEGREE.

Initial current degree: The initial value of CURRENT DEGREE is equal to the parallelism degree in effect from the CHGQRYA CL command, PARALLEL_DEGREE parameter in the current query options file (QAQQINI), or the QQRYDEGREE system value.

Parallelism degree precedence: The parallelism degree can be controlled in several ways. The actual parallelism degree used is determined as follows:

- If a SET CURRENT DEGREE statement or a CHGQRYA CL command with a DEGREE keyword has been executed, the parallelism degree specified by the most recent of either is the value of CURRENT DEGREE.
- If neither a SET CURRENT DEGREE statement nor a CHGQRYA CL command with a DEGREE keyword has been executed,
 - If a current query options file (QAQQINI) with a PARALLEL_DEGREE parameter has been specified, the parallelism degree specified by the QAQQINI file is the value of CURRENT DEGREE.
 - Otherwise, the parallelism degree specified by the QQRYDEGREE system value is the value of CURRENT DEGREE.

For more information, see [Database Performance and Query Optimization](#) topic collection.

Current degree scope: The scope of CURRENT DEGREE is the job.

Parallel limitations: If the DB2 Symmetric Multiprocessing feature is not installed, a warning is returned and parallelism is not used.

Some SQL statements cannot use parallelism.

Example

Example 1: The following statement sets the CURRENT DEGREE to inhibit parallelism.

```
SET CURRENT DEGREE = '1'
```

Example 2: The following statement sets the CURRENT DEGREE to allow parallelism.

```
SET CURRENT DEGREE = 'ANY'
```

SET CURRENT IMPLICIT XMLPARSE OPTION

The SET CURRENT IMPLICIT XMLPARSE OPTION statement changes the value of the CURRENT IMPLICIT XMLPARSE OPTION special register.

Invocation

This statement can be embedded in an application program or issued interactively. It is an executable statement that can be dynamically prepared.

Authorization

If a global variable is referenced in the statement, the privileges held by the authorization ID of the statement must include at least one of the following:

- For the global variable identified in the statement,
 - The READ privilege on the global variable, and
 - The USAGE privilege on the schema containing the global variable
- Database administrator authority

Syntax

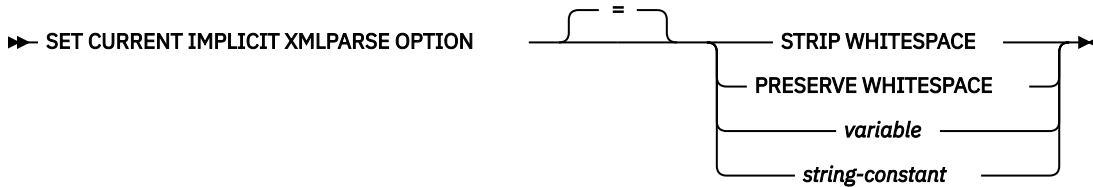

Description

STRIP WHITESPACE

Whitespace is removed on implicit XMLPARSE.

PRESERVE WHITESPACE

Whitespace is not removed on implicit XMLPARSE.

variable

Specifies a variable which contains the value for the CURRENT IMPLICIT XMLPARSE OPTION. The content is folded to uppercase.

The variable:

- Must be a character-string or Unicode graphic-string variable.
- Must not be followed by an indicator variable.
- Must contain one of the two implicit XMLPARSE options.
- Must be padded on the right with blanks if the variable is fixed length.

string-constant

A character constant that contains a specification of the implicit XMLPARSE option. The value must be a left justified string that is either 'STRIP WHITESPACE' or 'PRESERVE WHITESPACE' with exactly one blank character between the keywords. The content is folded to uppercase.

Notes

Transaction considerations: The SET CURRENT IMPLICIT XMLPARSE OPTION statement is not a committable operation. ROLLBACK has no effect on the CURRENT IMPLICIT XMLPARSE OPTION.

Initial CURRENT IMPLICIT XMLPARSE OPTION: The initial value of CURRENT IMPLICIT XMLPARSE OPTION is 'STRIP WHITESPACE'.

Both static and dynamic statements are affected by this special register.

The CURRENT IMPLICIT XMLPARSE OPTION scope is the connection.

Example

Set the value of the CURRENT IMPLICIT XMLPARSE OPTION special register to 'PRESERVE WHITESPACE'.

```
SET CURRENT IMPLICIT XMLPARSE OPTION = PRESERVE WHITESPACE
```

SET CURRENT TEMPORAL SYSTEM_TIME

The SET CURRENT TEMPORAL SYSTEM_TIME statement changes the value of the CURRENT TEMPORAL SYSTEM_TIME special register.

Invocation

This statement can be embedded in an application program or issued interactively. It is an executable statement that can be dynamically prepared.

Authorization

None required.

Syntax

► SET CURRENT TEMPORAL SYSTEM_TIME 

Description

NULL

Specifies the null value.

expression

An expression that can be assigned to a TIMESTAMP(12). The expression must not contain a scalar fullselect or a function that is non-deterministic, external action, or modifies SQL data.

Notes

Transaction considerations: The SET CURRENT TEMPORAL SYSTEM_TIME statement is not a committable operation. ROLLBACK has no effect on CURRENT TEMPORAL SYSTEM_TIME.

CURRENT TEMPORAL SYSTEM_TIME scope: The scope of the CURRENT TEMPORAL SYSTEM_TIME special register is the activation group and connection.

Examples

Example 1: Set the CURRENT TEMPORAL SYSTEM_TIME special register to the previous month.

```
SET CURRENT TEMPORAL SYSTEM_TIME = CURRENT_TIMESTAMP - 1 MONTH
```

Example 2: Set the CURRENT TEMPORAL SYSTEM_TIME special register to the null value.

```
SET CURRENT TEMPORAL SYSTEM_TIME = NULL
```

SET DESCRIPTOR

The SET DESCRIPTOR statement sets information in an SQL descriptor.

Invocation

This statement can only be embedded in an application program, SQL function, SQL procedure, or trigger. It cannot be issued interactively. It is an executable statement that cannot be dynamically prepared. It must not be specified in REXX.

Authorization

None required.

Syntax

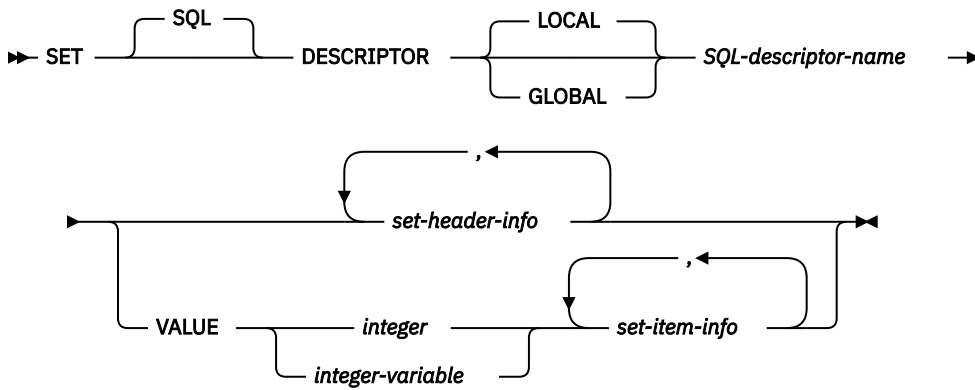

set-header-info

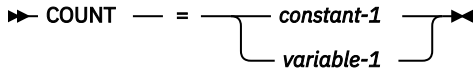

set-item-info

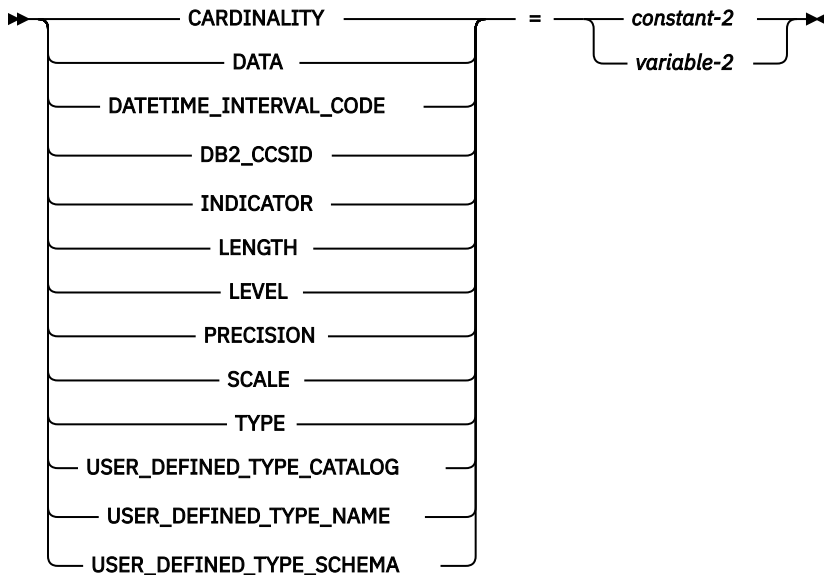

Description

LOCAL

Specifies the scope of the name of the descriptor to be local to program invocation. The information provided is set into the descriptor known in this local scope.

GLOBAL

Specifies the scope of the name of the descriptor to be global to the SQL session. The information provided is set into the descriptor known to any program that executes using the same database connection.

SQL-descriptor-name

Names the SQL descriptor. The name must identify a descriptor that already exists with the specified scope.

set-header-info

Sets attributes into the SQL descriptor. The same descriptor item must not be specified more than once in a single SET DESCRIPTOR statement.

VALUE

Specifies the item number for which the specified information is set. If the item number is greater than the maximum number of items allocated for the descriptor or the item number is less than 1, an error is returned.

integer

An integer constant in the range of 1 to the number of items allocated in the SQL descriptor.

integer-variable

Identifies a variable declared in the program in accordance with the rules for declaring variables. It must not be a global variable. The data type of the variable must be SMALLINT, INTEGER, BIGINT, or DECIMAL or NUMERIC with a scale of zero. The value of variable must be in the range of 1 to the maximum number of items allocated in the SQL descriptor.

set-item-info

Sets information about a specific item into the SQL descriptor. The same descriptor item must not be specified more than once in a single SET DESCRIPTOR statement. Items that are not applicable to the specified type are ignored.

set-header-info

COUNT

A count of the number of items that will be specified in the descriptor.

variable-1

Identifies a variable declared in the program in accordance with the rules for declaring variables, but must not be a file reference variable or a global variable. The data type of the variable must be compatible with the COUNT header item as specified in [Table 91 on page 1320](#). The variable is assigned (using storage assignment rules) to the COUNT header item. For details on the assignment rules, see [“Assignments and comparisons” on page 91](#).

constant-1

Identifies a constant value used to set the COUNT header item. The data type of the constant must be compatible with the COUNT header item as specified in [Table 91 on page 1320](#). The constant is assigned (using storage assignment rules) to the COUNT header item. For details on the assignment rules, see [“Assignments and comparisons” on page 91](#).

set-item-info

CARDINALITY

Specifies the cardinality for the item. This is only allowed when TYPE is an array.

DATA

Specifies the value for the data described by the item descriptor. If the value of INDICATOR is negative, then the value of DATA is undefined. The assigned value cannot be a constant.

DATETIME_INTERVAL_CODE

Specifies the specific datetime data type. DATETIME_INTERVAL_CODE must be specified if TYPE is set to 9.

- 1**
DATE
- 2**
TIME
- 3**
TIMESTAMP

DB2_CCSID

Specifies the CCSID of character, graphic, XML, or datetime data. The value is not applicable for all other data types. If the DB2_CCSID is not specified or 0 is specified:

- For XML data, the SQL_XML_DATA_CCSID QAQQINI option setting will be used.
- Otherwise, the CCSID of the variable will be determined by the CCSID of the job.

INDICATOR

Specifies the value for the indicator. A non-negative indicates a DATA value will be provided for this descriptor item. When extended indicator variables are not enabled, a negative value indicates the value described by this descriptor item is the null value. If not set, the value of INDICATOR is 0. When extended indicator variables are enabled:

- -1, -2, -3, -4, or -6 indicates the value described by this descriptor item is the null value.
- -5 indicates the value described by this descriptor item is the DEFAULT value.
- -7 indicates the value described by this descriptor item is the UNASSIGNED value.
- 0 or a positive value indicates a DATA value will be provided for this descriptor item.

LENGTH

Specifies the maximum length of the data. If the data type is a character or graphic string type, XML type, or a datetime type, the length represents the number of characters (not bytes). If the data type is a binary string or any other type, the length represents the number of bytes. If LENGTH is not specified, a default length will be used. For a description of the defaults, see [Table 119 on page 1501](#).

LEVEL

The level of the item descriptor.

- 0**
Item is a primary descriptor entry.
- 1**
Item is for a secondary descriptor entry. This is for an array entry.

PRECISION

Specifies the precision for descriptor items of data type DECIMAL, NUMERIC, DECFLOAT, DOUBLE, REAL, FLOAT, and TIMESTAMP. If PRECISION is not specified, a default precision will be used. For a description of the defaults, see [Table 119 on page 1501](#).

SCALE

Specifies the scale for descriptor items of data type DECIMAL or NUMERIC. If SCALE is not specified, a default scale will be used. For a description of the defaults, see [Table 119 on page 1501](#).

TYPE

Specifies a data type code representing the data type of the descriptor item. For a description of the data type codes and lengths, see [Table 92 on page 1322](#). Either TYPE or USER_DEFINED_TYPE_NAME and USER_DEFINED_TYPE_SCHEMA (but not both) must be specified for each descriptor item.

USER_DEFINED_TYPE_CATALOG

Specifies the server name of the user-defined type. If USER_DEFINED_TYPE_CATALOG is specified, it must be equal to the current server. Otherwise, the USER_DEFINED_TYPE_CATALOG is the current server.

USER_DEFINED_TYPE_NAME

Specifies the name of the user-defined data type. Either TYPE or USER_DEFINED_TYPE_NAME and USER_DEFINED_TYPE_SCHEMA (but not both) must be specified for each descriptor item.

USER_DEFINED_TYPE_SCHEMA

Specifies the schema containing the user-defined type. Either TYPE or USER_DEFINED_TYPE_NAME and USER_DEFINED_TYPE_SCHEMA (but not both) must be specified for each descriptor item.

variable-2

Identifies a variable declared in the program in accordance with the rules for declaring variables, but must not be a file reference variable or a global variable. The data type of the variable must be compatible with the descriptor information item as specified in Table 91 on page 1320. The variable is assigned (using storage assignment rules) to the corresponding descriptor item. For details on the assignment rules, see “Assignments and comparisons” on page 91.

When setting the DATA item, in general the variable must have the same data type, length, precision, scale, and CCSID as specified in Table 91 on page 1320. For variable-length types, the variable length must not be less than the LENGTH in the descriptor. For C nul-terminated types, the variable length must be at least one greater than the LENGTH in the descriptor.

constant-2

Identifies a constant value used to set the descriptor item. The data type of the constant must have the same data type, length, precision, scale, and CCSID as specified in Table 91 on page 1320. The constant is assigned (using storage assignment rules) to the corresponding descriptor item. For details on the assignment rules, see “Assignments and comparisons” on page 91.

If the descriptor item to be set is DATA, *constant-2* cannot be specified.

Notes

Default values for descriptor items: The following table represents the default values for LENGTH, PRECISION, and SCALE, if they are not specified for a descriptor item.

Data Type	LENGTH	PRECISION	SCALE
DECIMAL and NUMERIC		5	0
FLOAT		53	0
DECFLOAT		34	
CHARACTER, VARCHAR, and CLOB	1		
GRAPHIC, VARGRAPHIC, and DBCLOB	1		
BINARY, VARBINARY, and BLOB	1		
DATE	10		
TIME	8		
TIMESTAMP	26	6	
XML	1		

Example

Example 1: Set the number of items in descriptor 'NEWDA' to the value in :numitems.

```
EXEC SQL SET DESCRIPTOR 'NEWDA'  
COUNT = :numitems;
```

Example 2: Set the value of the type and length for the first item descriptor of descriptor 'NEWDA'

```
SET DESCRIPTOR 'NEWDA'  
VALUE 1 TYPE = :dtype,  
LENGTH = :olength;
```

SET ENCRYPTION PASSWORD

The SET ENCRYPTION PASSWORD statement sets the default password and hint that will be used by the encryption and decryption functions. The password is not associated with authentication and is only used for data encryption and decryption.

For information about using this statement, see “ENCRYPT_AES” on page 393, “ENCRYPT_RC2” on page 396, “ENCRYPT_TDES” on page 399, and “DECRYPT_BIT, DECRYPT_BINARY, DECRYPT_CHAR and DECRYPT_DB” on page 376.

Invocation

This statement can be embedded in an application program or issued interactively. It is an executable statement that can be dynamically prepared.

Authorization

If a global variable is referenced in the statement, the privileges held by the authorization ID of the statement must include at least one of the following:

- For each global variable identified in the statement,
 - The READ privilege on the global variable, and
 - The USAGE privilege on the schema containing the global variable
- Database administrator authority

Syntax

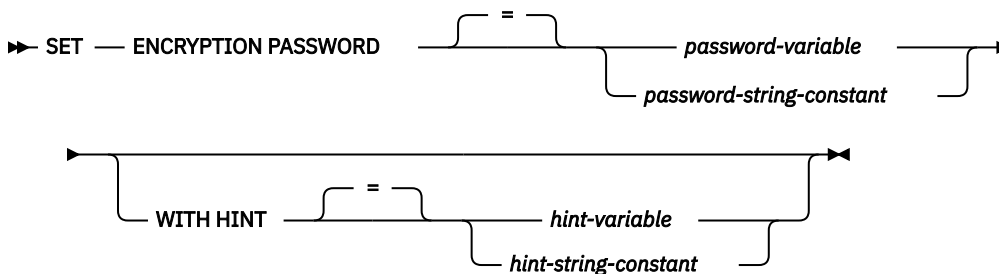

Description

password-variable

Specifies a variable that contains an encryption password.

The variable:

- Must be a CHAR, VARCHAR, Unicode GRAPHIC, or Unicode VARGRAPHIC variable. The actual length of the contents of the variable must be between 6 and 127 inclusive or must be an empty string. If an empty string is specified, the default encryption password is set to no value.
- Must not be the null value.
- All characters are case-sensitive and are not converted to uppercase characters.

password-string-constant

A character constant. The length of the constant must be between 6 and 127 inclusive or must be an empty string. If an empty string is specified, the default encryption password is set to no value. The literal form of the password is not allowed in static SQL or REXX.

WITH HINT

Indicates that a value is specified that will help data owners remember passwords (for example, 'Ocean' as a hint to remember 'Pacific'). If a hint value is specified, the hint is used as the default for

encryption functions. The hint can subsequently be retrieved for an encrypted value using the `GETHINT` function. If this clause is not specified and a hint is not explicitly specified on the encryption function, no hint will be embedded in encrypted data result.

hint-variable

Specifies a variable that contains an encryption password hint.

The variable:

- Must be a CHAR, VARCHAR, Unicode GRAPHIC, or Unicode VARGRAPHIC variable. The actual length of the contents of the variable must not be greater than 32. If an empty string is specified, the default encryption password hint is set to no value.
- Must not be the null value.
- All characters are case-sensitive and are not converted to uppercase characters.

hint-string-constant

A character constant. The length of the constant must not be greater than 32. If an empty string is specified, the default encryption password hint is set to no value.

Notes

Password protection: To prevent inadvertent access to the encryption password, do not specify *password-string-constant* in the source for a program, procedure, or function. Instead, use a variable.

When connected to a remote relational database, the specified password itself is sent "in the clear". That is, the password itself is not encrypted. To protect the password in these cases, consider using a communications encryption mechanism such as IPSEC (or SSL if connecting between IBM i products).

Transaction considerations: The `SET ENCRYPTION PASSWORD` statement is not a committable operation. `ROLLBACK` has no effect on the default encryption password or default encryption password hint.

Initial encryption password value: The initial value of both the default encryption password and the default encryption password hint is the empty string ('').

Encryption password scope: The scope of the default encryption password and default encryption password hint is the activation group and connection.

Example

Set the `ENCRYPTION PASSWORD` to the value in `:hv1`.

```
SET ENCRYPTION PASSWORD :hv1
```

SET OPTION

The SET OPTION statement establishes the processing options to be used for SQL statements.

Invocation

This statement can be used in a REXX procedure or embedded in an application program. If used in a REXX procedure, it is an executable statement. If embedded in an application program, it is not executable and must precede any other SQL statements. This statement cannot be dynamically prepared.

Authorization

None required.

Syntax

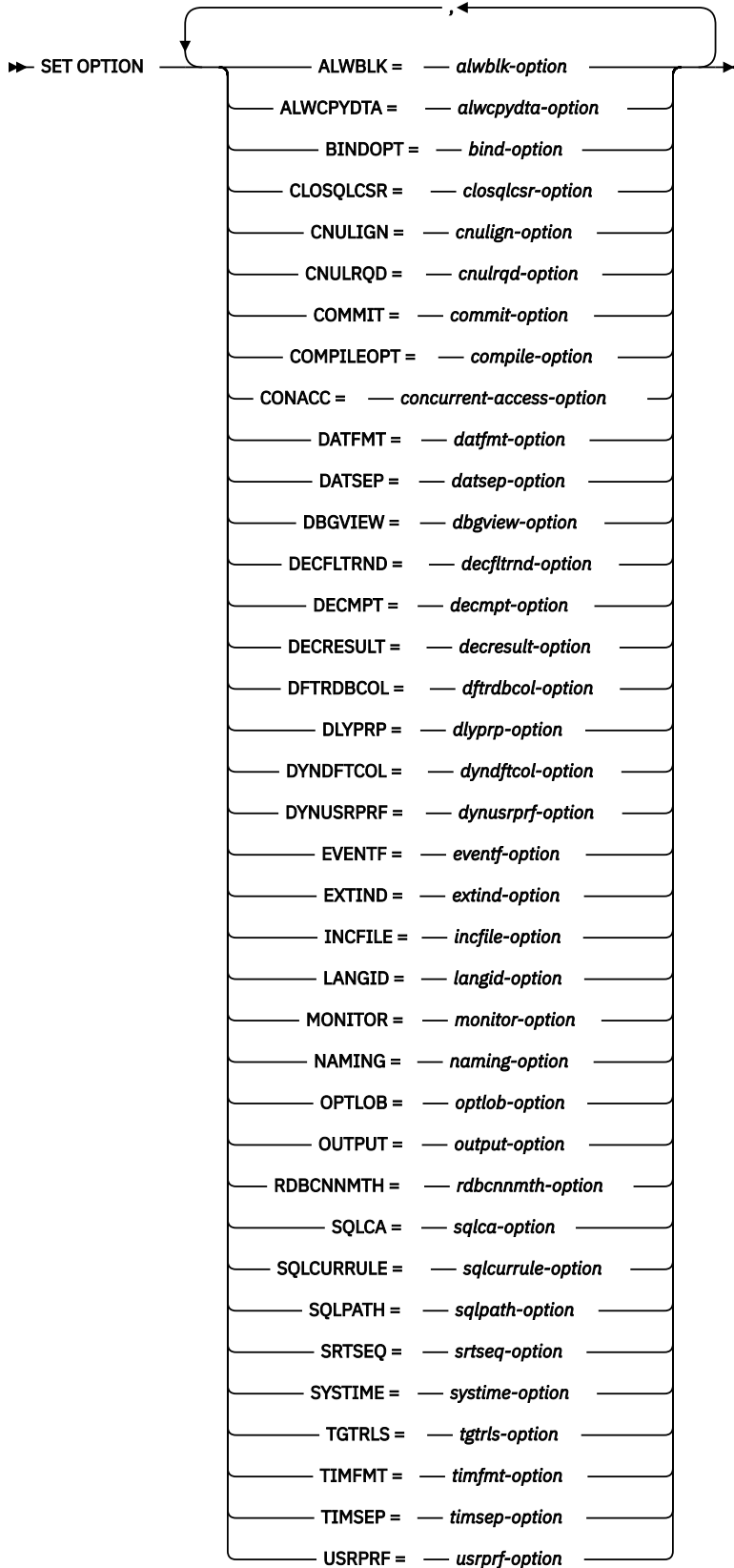

alwblk-option



alwcpydta-option

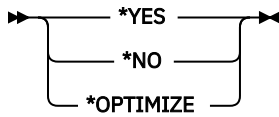

bind-option

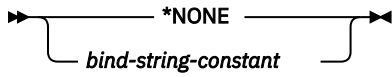

closqlcsr-option

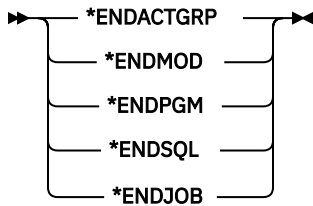

cnulign-option

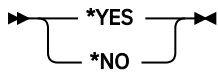

cnulrqd-option

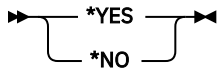

commit-option

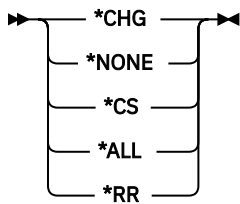

compile-option

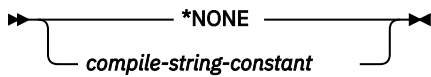

concurrent-access-option

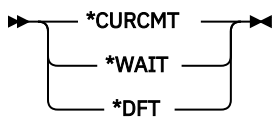

datfmt-option

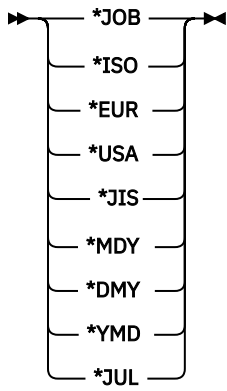

datsep-option

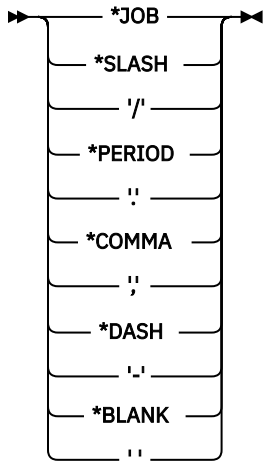

decfltrnd-option

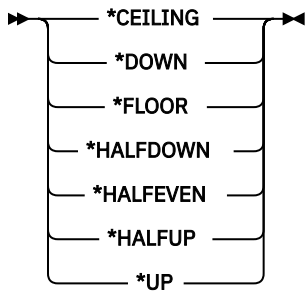

decmnt-option

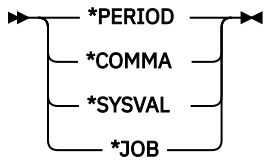

decresult-option

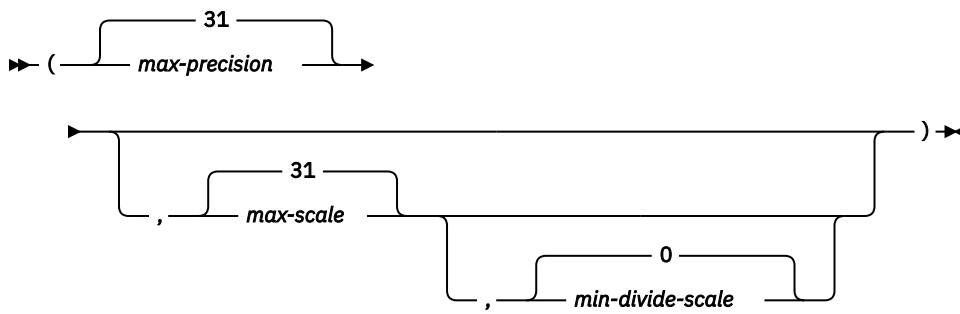

dbgview-option

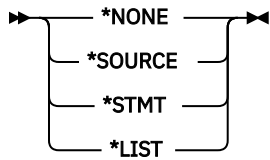

dftrdbcol-option

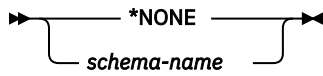

dlyprp-option

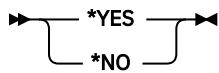

dyndftcol-option

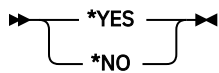

dynusrprf-option



eventf-option

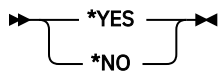

extind-option

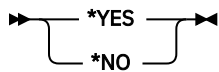

incfile-option

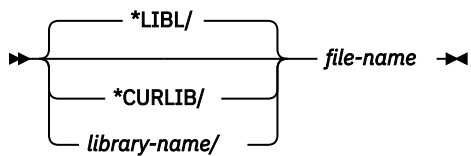

langid-option

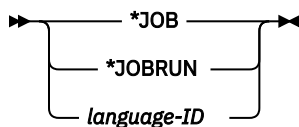

monitor-option

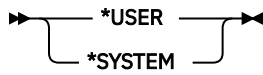

naming-option

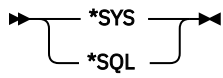

optlob-option

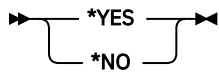

output-option

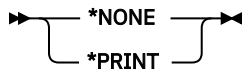

rdbcnmth-option

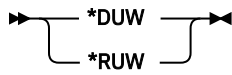

sqlca-option

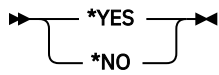

sqlcurrule-option

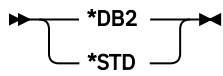

sqlpath-option

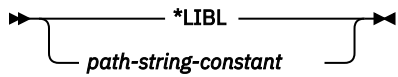

srtseq-option

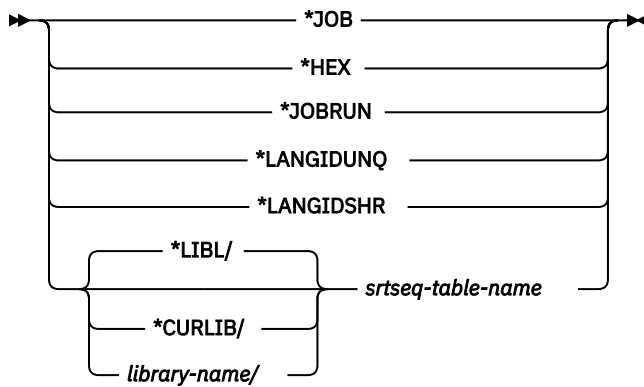

system-option

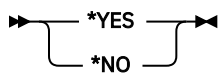

tgtrls-option



timfmt-option

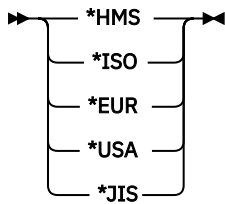

timsep-option

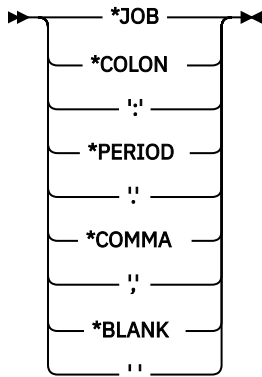

usrprf-option

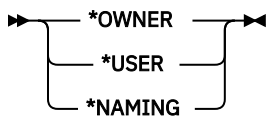

Description

ALWBLK

Specifies whether the database manager can use row blocking and the extent to which blocking can be used for read-only cursors. This option will be ignored in REXX.

***ALLREAD**

Rows are blocked for read-only cursors if COMMIT is *NONE, *CHG, or *CS. All cursors in a program that are not explicitly able to be updated are opened for read-only processing even though EXECUTE or EXECUTE IMMEDIATE statements may be in the program.

Specifying *ALLREAD:

- Allows row blocking under commitment control level *CHG and *CS in addition to the blocking allowed for *READ.
- Can improve the performance of almost all read-only cursors in programs, but limits queries in the following ways:
 - The Rollback (ROLLBACK) command, a ROLLBACK statement in host languages, or the ROLLBACK HOLD SQL statement does not reposition a read-only cursor when:
 - ALWBLK(*ALLREAD) was specified when the program or routine that contains the cursor was created
 - ALWBLK(*READ) and ALWCOPYDTA(*OPTIMIZE) were specified when the program or routine that contains the cursor was created
 - Dynamic running of a positioned UPDATE or DELETE statement (for example, using EXECUTE IMMEDIATE), cannot be used to update a row in a cursor unless the DECLARE statement for the cursor includes the FOR UPDATE clause.

***NONE**

Rows are not blocked for retrieval of data for cursors.

Specifying *NONE:

- Guarantees that the data retrieved is current.
- May reduce the amount of time required to retrieve the first row of data for a query.
- Stops the database manager from retrieving a block of data rows that is not used by the program when only the first few rows of a query are retrieved before the query is closed.
- Can degrade the overall performance of a query that retrieves a large number of rows.

***READ**

Rows are blocked for read-only retrieval of data for cursors when:

- *NONE is specified on the COMMIT parameter, which indicates that commitment control is not used.
- The cursor is declared with a FOR READ ONLY clause or there are no dynamic statements that could run a positioned UPDATE or DELETE statement for the cursor.

Specifying *READ can improve the overall performance of queries that meet the above conditions and retrieve a large number of rows.

ALWCPYDTA

Specifies whether a copy of the data can be used in a SELECT statement. This option will be ignored in REXX.

***OPTIMIZE**

The system determines whether to use the data retrieved directly from the database or to use a copy of the data. The decision is based on which method provides the best performance. If COMMIT is *CHG or *CS and ALWBLK is not *ALLREAD, or if COMMIT is *ALL or *RR, then a copy of the data is used only when it is necessary to run a query.

***YES**

A copy of the data is used only when necessary.

***NO**

A copy of the data is not allowed. If a temporary copy of the data is required to perform the query, an error message is returned.

BINDOPT

Specifies additional parameters to be used on the CRTPGM or CRTSRVPGM CL command that is used when creating an SQL function, SQL procedure, or SQL trigger. The BINDOPT string is added to the CRTPGM or CRTSRVPGM CL command generated by the precompiler. The contents of the string are not validated. The bind command will issue an error if any parameter is incorrect. The following bind options cannot be specified in this string since they are set by the precompiler: ACTGRP, ALWRINZ, AUT, ENTMOD, EXPORT, MODULE, REPLACE, STGMDL, TEXT, TGTRLS, and USRPRF.

This option is only allowed in an SQL function, SQL procedure, or SQL trigger. This option will be ignored in REXX.

***NONE**

No additional parameters will be used on the CRTPGM or CRTSRVPGM CL command.

bind-string-constant

A character constant of no more than 5000 characters containing the bind options.

CLOSQCSR

Specifies when SQL cursors are implicitly closed, SQL prepared statements are implicitly discarded, and LOCK TABLE locks are released. SQL cursors are explicitly closed when you issue the CLOSE, COMMIT, or ROLLBACK (without HOLD) SQL statements. This option will be ignored in REXX.

*ENDACTGRP and *ENDMOD are for use by ILE programs and modules, SQL functions, SQL procedures, or SQL triggers. *ENDPGM, *ENDSQL, and *ENDJOB are for use by non-ILE programs.

SQL scalar functions, SQL procedures, and SQL triggers use *ENDMOD as the default. SQL table functions are always created using *ENDACTGRP.

***ENDACTGRP**

SQL cursors are closed, SQL prepared statements are implicitly discarded, and LOCK TABLE locks are released when the activation group ends.

***ENDMOD**

SQL cursors are closed and SQL prepared statements are implicitly discarded when the module is exited. LOCK TABLE locks are released when the first SQL program on the call stack ends. Note that a cursor may only be logically closed and will only be physically closed when the first program with SQL leaves the stack and only if that program was not compiled with *ENDACTGRP.

***ENDPGM**

SQL cursors are closed and SQL prepared statements are discarded when the program ends. LOCK TABLE locks are released when the first SQL program on the call stack ends.

***ENDSQL**

SQL cursors remain open between calls and can be fetched without running another SQL OPEN. One of the programs higher on the call stack must have run at least one SQL statement. SQL cursors are closed, SQL prepared statements are discarded, and LOCK TABLE locks are released when the first SQL program on the call stack ends. If *ENDSQL is specified for a program that is the first SQL program called (the first SQL program on the call stack), the program is treated as if *ENDPGM was specified.

***ENDJOB**

SQL cursors remain open between calls and can be fetched without running another SQL OPEN. The programs higher on the call stack do not need to have run SQL statements. SQL cursors are left open, SQL prepared statements are preserved, and LOCK TABLE locks are held when the first SQL program on the call stack ends. SQL cursors are closed, SQL prepared statements are discarded, and LOCK TABLE locks are released when the job ends.

CNULIGN

Specifies whether a NUL-terminator is ignored for character and graphic host variables. This option will only be used for SQL statements in C and C++ programs.

This option is not allowed in an SQL function, SQL procedure, or SQL trigger.

***YES**

Character and graphic host variables defined as NUL-terminated will be treated as fixed length variables for INSERT and UPDATE statements. NUL-terminators are considered part of the data.

***NO**

NUL-terminated character and graphic host variables use NUL-terminators for INSERT and UPDATE statements.

CNULRQD

Specifies whether a NUL-terminator is returned for character and graphic host variables. This option will only be used for SQL statements in C and C++ programs.

This option is not allowed in an SQL function, SQL procedure, or SQL trigger.

***YES**

Output character and graphic host variables always contain the NUL-terminator. If there is not enough space for the NUL-terminator, the data is truncated and the NUL-terminator is added. Input character and graphic host variables require a NUL-terminator.

***NO**

For output character and graphic host variables, the NUL-terminator is not returned when the host variable is exactly the same length as the data. Input character and graphic host variables do not require a NUL-terminator.

COMMIT

Specifies the isolation level to be used. In REXX, files that are referred to in the source are not affected by this option. Only tables, views, and packages referred to in SQL statements are affected. For more information about isolation levels, see [“Isolation level!”](#) on page 23

***CHG**

Specifies the isolation level of Uncommitted Read.

***NONE**

Specifies the isolation level of No Commit. If the DROP SCHEMA statement is included in a REXX procedure, *NONE must be used.

***CS**

Specifies the isolation level of Cursor Stability.

***ALL**

Specifies the isolation level of Read Stability.

***RR**

Specifies the isolation level of Repeatable Read.

COMPILEOPT

Specifies additional parameters to be used on the compiler command. The COMPILEOPT string is added to the compiler command built by the precompiler. If 'INCDIR(' is anywhere in the string, the precompiler will call the compiler using the SRCSTMF parameter. The contents of the string is not validated. The compiler command will issue an error if any parameter is incorrect. Using any of the keywords that the precompiler passes to the compiler will cause the compiler command to fail because of duplicate parameters. Refer to the [Embedded SQL Programming](#) topic collection for a list of parameters that the precompiler generates for the compiler command. This option will be ignored in REXX.

This option is not allowed in an SQL function, SQL procedure, or SQL trigger.

***NONE**

No additional parameters will be used on the compiler command.

character-string

A character constant of no more than 5000 characters containing the compiler options.

CONACC

Specifies the concurrent access resolution to use for select statements.

***CURCMT**

Specifies that the database manager is to use the currently committed version of data when encountering a row that is in the process of being updated or deleted. Rows that are in the process of being inserted are skipped. This value will be honored when possible for isolation level of *CS.

***WAIT**

Specifies to wait for a commit or rollback for data that is in the process of being updated or deleted by another transaction. This value will be honored when possible for isolation levels of *CS and *ALL.

***DFT**

Specifies that the concurrent access option will not be explicitly set for this program. The value that is in effect when the program is invoked will be used.

DATFMT

Specifies the format used when accessing date result columns. All output date fields are returned in the specified format. For input date strings, the specified value is used to determine whether the date is specified in a valid format.

Note: An input date string that uses the format *USA, *ISO, *EUR, or *JIS is always valid.

***JOB:**

The format specified for the job is used. Use the Display Job (DSPJOB) command to determine the current date format for the job.

***ISO**

The International Organization for Standardization (ISO) date format (yyyy-mm-dd) is used.

***EUR**

The European date format (dd.mm.yyyy) is used.

***USA**

The United States date format (mm/dd/yyyy) is used.

***JIS**

The Japanese Industrial Standard date format (yyyy-mm-dd) is used.

***MDY**

The date format (mm/dd/yy) is used.

***DMY**

The date format (dd/mm/yy) is used.

***YMD**

The date format (yy/mm/dd) is used.

***JUL**

The Julian date format (yy/ddd) is used.

DATSEP

Specifies the separator used when accessing date result columns.

Note: This parameter applies only when *JOB, *MDY, *DMY, *YMD, or *JUL is specified on the DATFMT parameter.

***JOB**

The date separator specified for the job is used. Use the Display Job (DSPJOB) command to determine the current value for the job.

***SLASH or '/'**

A slash (/) is used.

***PERIOD or '.'**

A period (.) is used.

***COMMA or ','**

A comma (,) is used.

***DASH or '-'**

A dash (-) is used.

***BLANK or ''**

A blank () is used.

DBGVIEW

Specifies whether the object can be debugged by the system debug facilities and the type of debug information to be provided by the compiler. The DBGVIEW parameter can only be specified in the body of SQL functions, procedures, and triggers.

If DEBUG MODE in a CREATE PROCEDURE or ALTER PROCEDURE statement is specified, a DBGVIEW option in the SET OPTION statement must not be specified.

The possible choices are:

***NONE**

A debug view will not be generated.

***SOURCE**

Allows the compiled module object to be debugged using SQL statement source. If *SOURCE is specified, the modified source is stored in source file QSQDSRC in the same schema as the created function, procedure, or trigger.

***STMT**

Allows the compiled module object to be debugged using program statement numbers and symbolic identifiers.

***LIST**

Generates the listing view for debugging the compiled module object.

If DEBUG MODE is not specified, but a DBGVIEW option in the SET OPTION statement is specified, the procedure cannot be debugged by the Unified Debugger, but can be debugged by the system debug facilities. If neither DEBUG MODE nor a DBGVIEW option is specified, the debug mode used is from the CURRENT DEBUG MODE special register.

DECFLTRND

Specifies the DECFLOAT rounding mode used for static SQL statements. The possible choices are:

***CEILING**

Round toward +Infinity. If all of the discarded digits are zero or if the sign is negative the result is unchanged other than the removal of the discarded digits. Otherwise, the result coefficient is incremented by one (rounded up).

***DOWN**

Round toward zero (truncation). The discarded digits are ignored.

***FLOOR**

Round toward -Infinity. If all of the discarded digits are zero or if the sign is positive, the result is unchanged other than the removal of the discarded digits. Otherwise, the sign is negative and the result coefficient is incremented by one.

***HALFDOWN**

Round to nearest; if equidistant, round down. If the discarded digits represent greater than half (0.5) of the value of a one in the next left position, then the result coefficient is incremented by one (rounded up). Otherwise, the discarded digits are ignored.

***HALFEVEN**

Round to nearest; if equidistant, round so that the final digit is even. If the discarded digits represent greater than half (0.5) of the value of a one in the next left position, then the result coefficient is incremented by one (rounded up). If they represent less than half, then the result coefficient is not adjusted (that is, the discarded digits are ignored). Otherwise (they represent exactly half), the result coefficient is unaltered if its rightmost digit is even or incremented by one (rounded up) if its rightmost digit is odd (to make an even digit).

***HALFUP**

Round to nearest; if equidistant, round up. If the discarded digits represent greater than or equal to half (0.5) of the value of a one in the next left position, then the result coefficient is incremented by one (rounded up). Otherwise, the discarded digits are ignored.

***UP**

Round away from zero. If all of the discarded digits are zero, the result is unchanged other than the removal of discarded digits. Otherwise, the result coefficient is incremented by one (rounded up).

DECMPT

Specifies the symbol that you want to represent the decimal point. The possible choices are:

***PERIOD**

The representation for the decimal point is a period.

***COMMA**

The representation for the decimal point is a comma.

***SYSVAL**

The representation for the decimal point is the system value (QDECfmt).

***JOB**

The representation for the decimal point is the job value (DECFMT).

DECRESULT

Specifies the maximum precision, maximum scale, and minimum divide scale that should be used during decimal operations, such as decimal arithmetic. The specified limits only apply to NUMERIC and DECIMAL data types.

max-precision

An integer constant that is the maximum precision that should be returned from decimal operations. The value can be 31 or 63. The default is 31.

max-scale

An integer constant that is the maximum scale that should be returned from decimal operations. The value can range from 0 to the maximum precision. The default is 31.

min-divide-scale

An integer constant that is the minimum scale that should be returned from division operations. The value can range from 1 to 9 and cannot be greater than *max-scale*. The default is 0, where 0 indicates that no minimum scale is specified.

DFTRBCOL

Specifies the schema name used for the unqualified names of tables, views, indexes, and SQL packages. This parameter applies only to static SQL statements. This option will be ignored in REXX.

***NONE**

The naming convention specified on the OPTION precompile parameter or by the SET OPTION NAMING option will be used.

schema-name

Specify the name of the schema. This value is used instead of the naming convention specified on the OPTION precompile parameter or by the SET OPTION NAMING option.

DLYPRP

Specifies whether the dynamic statement validation for a PREPARE statement is delayed until an OPEN, EXECUTE, or DESCRIBE statement is run. Delaying validation improves performance by eliminating redundant validation. This option will be ignored in REXX.

***NO**

Dynamic statement validation is not delayed. When the dynamic statement is prepared, the access plan is validated. When the dynamic statement is used in an OPEN or EXECUTE statement, the access plan is revalidated. Because the authority or the existence of objects referred to by the dynamic statement may change, you must still check the SQLCODE or SQLSTATE after issuing the OPEN or EXECUTE statement to ensure that the dynamic statement is still valid.

***YES**

Dynamic statement validation is delayed until the dynamic statement is used in an OPEN, EXECUTE, or DESCRIBE SQL statement. When the dynamic statement is used, the validation is completed and an access plan is built. If you specify *YES, you should check the SQLCODE and SQLSTATE after running an OPEN, EXECUTE, or DESCRIBE statement to ensure that the dynamic statement is valid.

Note: If you specify *YES, performance is not improved if the INTO clause is used on the PREPARE statement or if a DESCRIBE statement uses the dynamic statement before an OPEN is issued for the statement.

DYNDFTCOL

Specifies the schema name specified for the DFTRBCOL parameter is also used for dynamic statements. This option will be ignored in REXX.

***NO**

Do not use the value specified for DFTRBCOL for unqualified names of tables, views, indexes, and SQL packages for dynamic SQL statements. The naming convention specified on the OPTION precompile parameter or by the SET OPTION NAMING option will be used.

***YES**

The schema name specified for DFTRDBCOL will be used for the unqualified names of the tables, views, indexes, and SQL packages in dynamic SQL statements.

DYNUSRPRF

Specifies the user profile to be used for dynamic SQL statements. This option will be ignored in REXX.

***USER**

Local dynamic SQL statements are run under the user profile of the job. Distributed dynamic SQL statements are run under the user profile of the application server job.

***OWNER**

Local dynamic SQL statements are run under the user profile of the program's owner. Distributed dynamic SQL statements are run under the user profile of the SQL package's owner.

EVENTF

Specifies whether an event file will be generated. CoOperative Development Environment/400® (CODE/400) uses the event file to provide error feedback integrated with the CODE/400 editor.

***YES**

The compiler produces an event file for use by CoOperative Development Environment/400 (CODE/400).

***NO**

The compiler will not produce an event file for use by CoOperative Development Environment/400 (CODE/400).

EXTIND

Specifies how to treat indicator variable values passed for SQL statements.

***NO**

Specifies that extended indicator variables are not enabled and non-updatable columns are not allowed in the implicit or explicit UPDATE clause of a *select-statement*.

***YES**

Specifies that extended indicator variables are enabled and non-updatable columns are allowed in the implicit or explicit UPDATE clause of a *select-statement*.

INCFILE

Specifies the name of the source file to use for INCLUDE SQL statements. It will be used to locate any source member listed in an INCLUDE SQL statement when a source file name is not specified in the INCLUDE SQL statement.

This option is only allowed in an SQL function, SQL procedure, or SQL trigger. This option will be ignored in REXX.

file-name

Specify the name of the source file to be used. The name of the file can be qualified by one of the following library values:

***LIBL**

All libraries in the user and system portions of the job's library list are searched until the first match is found.

***CURLIB**

The current library for the job is searched. If no library is specified as the current library for the job, the QGPL library is used.

library-name

Specifies the name of the library to be searched.

LANGID

Specifies the language identifier to be used when SRTSEQ(*LANGIDUNQ) or SRTSEQ(*LANGIDSHR) is specified.

***JOB or *JOB RUN**

The LANGID value for the job is used.

For distributed applications, LANGID(*JOB RUN) is valid only when SRTSEQ(*JOB RUN) is also specified.

language-id

Specify a language identifier to be used. For information about the values that can be used for the language identifier, see the [Language identifier](#) topic in the Globalization topic collection.

MONITOR

Specifies whether the statements should be identified as user or system statements when a database monitor is run.

***USER**

The SQL statements are identified as user statements. This is the default.

***SYSTEM**

The SQL statements are identified as system statements.

NAMING

Specifies whether the SQL naming convention or the system naming convention is to be used. This option is not allowed in an SQL function, SQL procedure, or SQL trigger.

The possible choices are:

***SYS**

The system naming convention will be used.

***SQL**

The SQL naming convention will be used.

OPTLOB

Specifies whether accesses to XML and LOBs can be optimized when accessing through DRDA. The possible choices are:

***YES**

LOB and XML accesses should be optimized. The first FETCH for a cursor determines how the cursor will be used for LOBs and XML on all subsequent FETCHes. This option remains in effect until the cursor is closed.

If the first FETCH uses a locator to access a LOB or XML column, no subsequent FETCH for that cursor can fetch that LOB or XML column into a LOB or XML variable.

If the first FETCH places the LOB or XML column into a LOB or XML variable, no subsequent FETCH for that cursor can use a locator for that column.

***NO**

LOB accesses should not be optimized. There is no restriction on whether a column is retrieved into a LOB locator or into a LOB variable. This option can cause performance to degrade.

OUTPUT

Specifies whether the precompiler and compiler listings are generated. The OUTPUT parameter can only be specified in the body of SQL functions, procedures, and triggers. The possible choices are:

***NONE**

The precompiler and compiler listings are not generated.

***PRINT**

The precompiler and compiler listings are generated.

RDBCNNMTH

Specifies the semantics used for CONNECT statements. This option will be ignored in REXX.

***DUW**

CONNECT (Type 2) semantics are used to support distributed unit of work. Consecutive CONNECT statements to additional relational databases do not result in disconnection of previous connections.

***RUW**

CONNECT (Type 1) semantics are used to support remote unit of work. Consecutive CONNECT statements result in the previous connection being disconnected before a new connection is established.

SQLCA

Specifies whether the fields in an SQLCA will be set after each SQL statement. The SQLCA option is only allowed for ILE C, ILE C++, ILE COBOL, and ILE RPG. This option is not allowed in an SQL function, SQL procedure, or SQL trigger.

The possible choices are:

***YES**

The fields in an SQLCA will be set after each SQL statement. The user program can reference all the values in the SQLCA following the execution of an SQL statement.

***NO**

The fields in an SQLCA will not be set after each SQL statement. The user program should use the GET DIAGNOSTICS statement to retrieve information about the execution of the SQL statement.

SQLCA(*NO) will typically perform better than SQLCA(*YES).

In other host languages, an SQLCA is required and fields in the SQLCA will be set after each SQL statement.

SQLCURRULE

Specifies the semantics used for SQL statements.

***DB2**

The semantics of all SQL statements will default to the rules established for Db2. The following semantics are controlled by this option:

- Hexadecimal constants are treated as character data.
- Unicode graphic-string constants are UCS-2 (CCSID 13488).
- Assignments to SQL-variables and SQL-parameters within the body of a routine or a trigger will use retrieval assignment rules.
- When describing a select statement into an SQLDA and SQLN is smaller than the required number of SQLVAR entries, SQLSTATE 01005 is returned only when the result table contains LOBs or UDTs.

***STD**

The semantics of all SQL statements will default to the rules established by the ISO and ANSI SQL standards. The following semantics are controlled by this option:

- Hexadecimal constants are treated as binary data.
- Unicode graphic-string constants are UTF-16 (CCSID 1200).
- Assignments to SQL-variables and SQL-parameters within the body of a routine or a trigger will use storage assignment rules.
- When describing a select statement into an SQLDA and SQLN is smaller than the required number of SQLVAR entries, SQLSTATE 01005 is always returned.

SQLPATH

Specifies the path to be used to find procedures, functions, and user defined types in static SQL statements. This option will be ignored in REXX.

***LIBL**

The path used is the library list at runtime.

character-string

A character constant with one or more schema names that are separated by commas. Only system schema names can be specified.

SRTSEQ

Specifies the collating sequence table to be used for string comparisons in SQL statements.

Note: *HEX must be specified if a REXX procedure connects to an application server that is not a Db2 for i or a IBM i product whose release level is prior to V2R3M0.

***JOB or *JOB RUN**

The SRTSEQ value for the job is used.

***HEX**

A collating sequence table is not used. The hexadecimal values of the characters are used to determine the collating sequence.

***LANGIDUNQ**

The collating sequence table must contain a unique weight for each character in the code page.

***LANGIDSHR**

The shared-weight sort table for the LANGID specified is used.

srtseq-table-name

Specify the name of the collating sequence table to be used with this program. The name of the collating sequence table can be qualified by one of the following library values:

***LIBL**

All libraries in the user and system portions of the job's library list are searched until the first match is found.

***CURLIB**

The current library for the job is searched. If no library is specified as the current library for the job, the QGPL library is used.

library-name

Specify the name of the library to be searched.

SYSTIME

Specifies whether the CURRENT TEMPORAL SYSTEM_TIME special register affects static and dynamic SQL statements.

The possible choices are:

***YES**

Any references to system-period temporal tables are affected by the value of the CURRENT TEMPORAL SYSTEM_TIME special register.

***NO**

Any references to system-period temporal tables are not affected by the value of the CURRENT TEMPORAL SYSTEM_TIME special register.

TGTRLS

Specifies the release of the operating system on which the user intends to use the object being created. The TGTRLS parameter can only be specified in the body of SQL functions, procedures, and triggers, or as part of an external function or external procedure create statement.

VxRxMx

Specify the release in the format VxRxMx, where Vx is the version, Rx is the release, and Mx is the modification level. For example, V7R1M0 is version 7, release 1, modification level 0. The object can be used on a system with the specified release or with any subsequent release of the operating system installed.

If you specify a release value which is earlier than the earliest release level currently supported by the operating system, the level will be upgraded to the current N-2 release value. No message will be issued.

TIMFMT

Specifies the format used when accessing time result columns. All output time fields are returned in the specified format. For input time strings, the specified value is used to determine whether the time is specified in a valid format.

Note: An input time string that uses the format *USA, *ISO, *EUR, or *JIS is always valid.

***HMS**

The (hh:mm:ss) format is used.

***ISO**

The International Organization for Standardization (ISO) time format (hh.mm.ss) is used.

***EUR**

The European time format (hh.mm.ss) is used.

***USA**

The United States time format (hh:mm xx) is used, where xx is AM or PM.

***JIS**

The Japanese Industrial Standard time format (hh:mm:ss) is used.

TIMSEP

Specifies the separator used when accessing time result columns.

Note: This parameter applies only when *HMS is specified on the TIMFMT parameter.

***JOB**

The time separator specified for the job is used. Use the Display Job (DSPJOB) command to determine the current value for the job.

***COLON or ':'**

A colon (:) is used.

***PERIOD or '.'**

A period (.) is used.

***COMMA or ','**

A comma (,) is used.

***BLANK or ''**

A blank () is used.

USRPRF

Specifies the user profile that is used when the compiled program object is run, including the authority that the program object has for each object in static SQL statements. The profile of either the program owner or the program user is used to control which objects can be used by the program object. This option will be ignored in REXX.

***NAMING**

The user profile is determined by the naming convention. If the naming convention is *SQL, USRPRF(*OWNER) is used. If the naming convention is *SYS, USRPRF(*USER) is used.

***USER**

The profile of the user running the program object is used.

***OWNER**

The user profiles of both the program owner and the program user are used when the program is run.

Notes

Default values: The default values for the options depend on the language, object type, and the options in effect at create time:

- When an SQL procedure, SQL function, or SQL trigger is created, the default values for the options are those in effect at the time the object is created. For example, if an SQL procedure is created and the

current COMMIT option is *CS, *CS is the default COMMIT option. Each option is then updated as it is encountered within the SET OPTION statement.

- For application programs other than REXX, the default values for the options are specified on the CRTSQLxxx command. Each option is then updated as it is encountered within a SET OPTION statement. All SET OPTION statements must precede any other embedded SQL statements.
- At the start of a REXX procedure the options are set to their default value. The default value for each option is the first value listed in the syntax diagram. When an option is changed by a SET OPTION statement, the new value will stay in effect until the option is changed again or the REXX procedure ends.

Syntax alternatives: The following keywords are synonyms supported for compatibility to prior releases. These keywords are non-standard and should not be used:

- *UR can be used as a synonym for *CHG.
- *NC can be used as a synonym for *NONE.
- *RS can be used as a synonym for *ALL.

Examples

Example 1: Set the isolation level to *ALL and the naming mode to SQL names.

```
EXEC SQL SET OPTION COMMIT =*ALL, NAMING =*SQL
```

Example 2: Set the date format to European, the isolation level to *CS, and the decimal point to the comma.

```
EXEC SQL SET OPTION DATFMT = *EUR, COMMIT = *CS, DECMPPT = *COMMA
```

SET PATH

The SET PATH statement changes the value of the CURRENT PATH special register.

Invocation

This statement can be embedded in an application program or issued interactively. It is an executable statement that can be dynamically prepared.

Authorization

If a global variable is referenced in the statement, the privileges held by the authorization ID of the statement must include at least one of the following:

- For each global variable identified in the statement,
 - The READ privilege on the global variable, and
 - The USAGE privilege on the schema containing the global variable
- Database administrator authority

Syntax

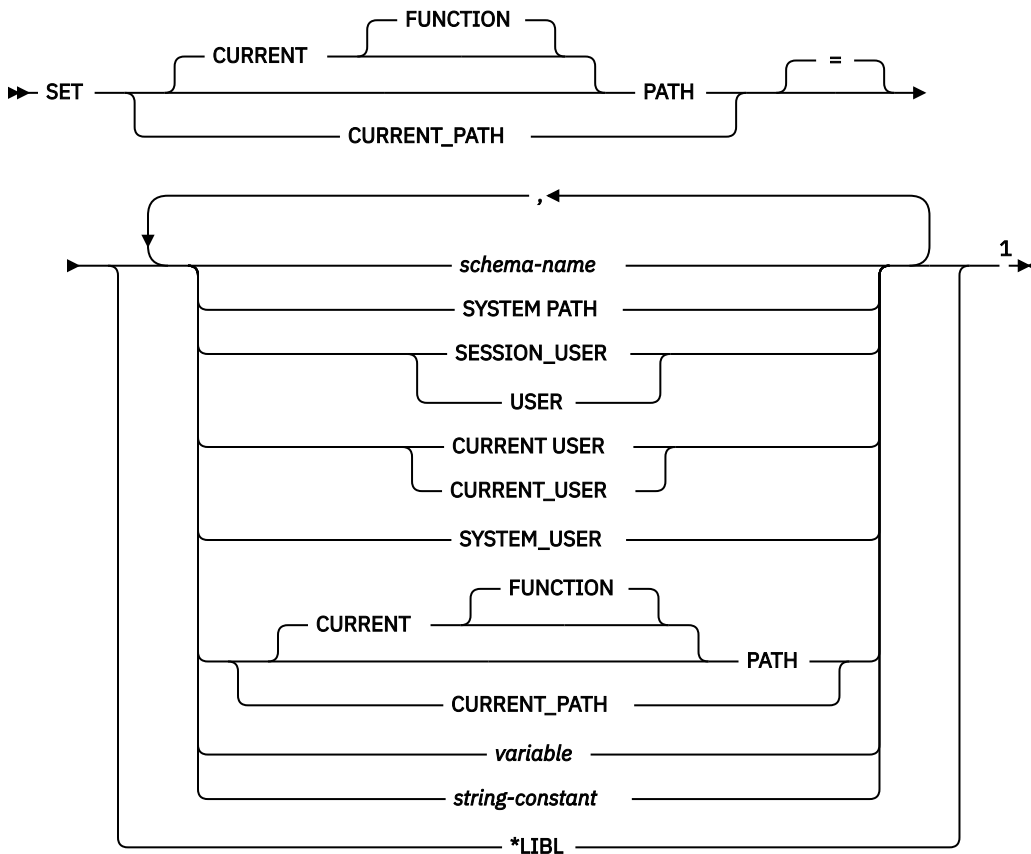

Notes:

- ¹ SYSTEM PATH, SESSION_USER, USER, CURRENT_USER, SYSTEM_USER, and CURRENT PATH may each be specified at most once on the right side of the statement.

Description

schema-name

Identifies a schema. If a specified schema name is a system schema name, no validation that the schema exists is made at the time the PATH is set. For example, if a *schema-name* is misspelled, it could affect the way subsequent SQL operates. If the specified schema name is not a system schema name, the schema must exist at the time the PATH is set.

Although not recommended, PATH can be specified as a *schema-name* if it is specified as "PATH".

SYSTEM PATH

Specifies the schema names for the system path. This value is the same as specifying the schema names "QSYS","QSYS2","SYSPROC","SYSIBMADM".

SESSION_USER or USER

Specifies the value of the SESSION_USER special register.

CURRENT USER

Specifies the value of the CURRENT_USER special register.

SYSTEM_USER

Specifies the value of the SYSTEM_USER special register.

CURRENT PATH

Specifies the value of the CURRENT_PATH special register before the execution of this statement. CURRENT_PATH is not allowed if the current path is *LIBL.

variable

Specifies a variable that contains one or more schema names that are separated by commas. It can be a global variable if it is qualified with schema name.

The variable:

- Must be a CHAR, VARCHAR, Unicode GRAPHIC, or Unicode VARGRAPHIC variable. The actual length of the contents of the *variable* must not exceed the maximum length of a path.
- Must not be followed by an indicator variable.
- Must not be the null value.
- Each schema name must conform to the rules for forming an ordinary or delimited identifier.
- Each schema name must not contain lowercase letters or characters that cannot be specified in an ordinary identifier.
- Must be padded on the right with blanks if the variable is fixed length character.
- If the SET statement is specified in an SQL routine, SQL trigger, or compound statement, *variable* cannot be a global variable with an unqualified name.

string-constant

A character constant with one or more schema names that are separated by commas.

The string constant:

- Each schema name must conform to the rules for forming an ordinary or delimited identifier.
- Each schema name must not contain lowercase letters or characters that cannot be specified in an ordinary identifier.

***LIBL**

The path is set to the library list of the current thread.

Notes

Transaction considerations: The SET PATH statement is not a committable operation. ROLLBACK has no effect on the CURRENT_PATH.

Rules for the content of the SQL path:

- A schema name must not appear more than once in the path.

- The number of schemas that can be specified is limited by the total length of the CURRENT PATH special register. The special register string is built by taking each schema name specified and removing trailing blanks, delimiting with double quotes, and separating each schema name by a comma. An error is returned if the length of the resulting string exceeds 3483 bytes. A maximum of 268 schema names can be represented in the path.
- There is a difference between specifying a single keyword (such as USER, or PATH, or CURRENT_PATH) as a single keyword, or as a delimited identifier. To indicate that the current value of a special register specified as a single keyword should be used in the SQL path, specify the name of the special register as a keyword. If the name of the special register is specified as a delimited identifier instead (for example, "USER"), it is interpreted as a schema name of that value ('USER'). For example, assuming that the current value of the USER special register is SMITH, then SET PATH = SYSIBM, USER, "USER" results in a CURRENT PATH value of "SYSIBM","SMITH","USER".
- The following rules are used to determine whether a value specified in a SET PATH statement is a variable or a *schema-name*:
 - If *name* is the same as a parameter or SQL variable in the SQL procedure, *name* is interpreted as a parameter or SQL variable, and the value in *name* is assigned to PATH.
 - If *name* is not the same as a parameter or SQL variable in the SQL procedure, *name* is interpreted as *schema-name*, and the value *name* is assigned to PATH.

The system path: SYSTEM PATH refers to the system path for a platform. The schemas QSYS, QSYS2, SYSPROC, and SYSIBMADM do not need to be specified. If not included in the path, they are implicitly assumed as the last schemas (in this case, it is not included in the CURRENT PATH special register).

The initial value of the CURRENT PATH special register is *LIBL if system naming was used for the first SQL statement run in the activation group. The initial value is "QSYS";"QSYS2";"SYSPROC";"SYSIBMADM";"X" (where X is the value of the USER special register) if SQL naming was used for the first SQL statement.

Using the SQL path: The CURRENT PATH special register is used to resolve user-defined types, functions, and procedures in dynamic SQL statements. For more information see [“SQL path” on page 57](#).

Example

The following statement sets the CURRENT PATH special register.

```
SET PATH = FERMAT, "McDuff", SYSIBM
```

The following statement retrieves the current value of the SQL path special register into the host variable called CURPATH.

```
EXEC SQL VALUES (CURRENT PATH) INTO :CURPATH;
```

The value would be "FERMAT","McDuff","SYSIBM" if set by the previous example.

SET RESULT SETS

The SET RESULT SETS statement specifies the result sets that can be returned from a procedure.

Invocation

This statement can only be embedded in an application program or SQL procedure. It is an executable statement that cannot be dynamically prepared. It is not allowed in a Java or REXX procedure.

Authorization

None required.

Syntax

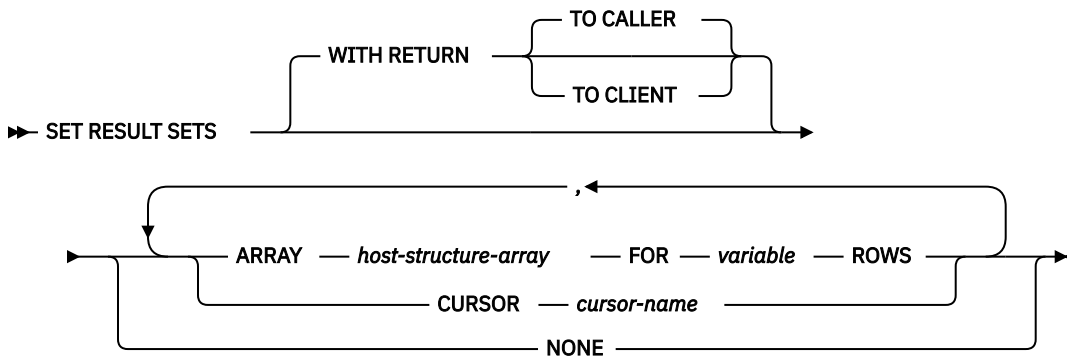

Description

WITH RETURN

Specifies that the result table of the cursor is intended to be used as a result set that will be returned from a procedure.

For non-scrollable cursors, the result set consists of all rows from the current cursor position to the end of the result table. For scrollable cursors, the result set consists of all rows of the result table.

TO CALLER

Specifies that the cursor can return a result set to the caller of the procedure. For example, if the caller is a client application, the result set is returned to the client application.

TO CLIENT

Specifies that the cursor can return a result set to the client application. This cursor is invisible to any intermediate nested procedures. If a function or trigger called the procedure either directly or indirectly, result sets cannot be returned to the client and the cursor will be closed after the procedure finishes.

CURSOR *cursor-name*

Identifies a cursor to be used to define a result set that can be returned from a procedure. The *cursor-name* must identify a declared cursor as explained in “Description” on page 1208 for the DECLARE CURSOR statement. When the SET RESULT SETS statement is executed, the cursor must be in the open state. It cannot be an allocated cursor.

ARRAY *host-structure-array*

host-structure-array identifies an array of host structures defined in accordance with the rules for declaring host structures. The array cannot contain a C NUL-terminated host variable.

The first structure in the array corresponds to the first row of the result set, the second structure in the array corresponds to the second row of the result set, and so on. In addition, the first value in the

row corresponds to the first item in the structure, the second value in the row corresponds to the second item in the structure, and so on.

LOBs and XML cannot be returned in an array when using DRDA.

Only one array can be specified in a SET RESULT SETS statement, including any RETURN TO CLIENT array result sets from nested calls to procedures.

FOR *variable* ROWS

Specifies the number of rows in the result set. The *variable* must be a numeric variable with zero scale, and it must not include an indicator variable. It must not be a global variable. The number of rows specified must be less than or equal to the dimension of the host structure array.

NONE

Specifies that no result sets will be returned. Cursors left open when the procedure ends will not be returned.

Notes

For more information about result sets, see [Result sets from procedures](#) and [WITH RETURN clause](#).

External procedures: There are three ways to return result sets from an external procedure:

- If a SET RESULT SETS statement is executed in the procedure, the SET RESULT SETS statement identifies the result sets. The result sets are returned in the order specified on the SET RESULT SETS statement.
- If a SET RESULT SETS statement is not executed in the procedure,
 - If no cursors have specified a WITH RETURN clause, each cursor that the procedure opens and leaves open when it returns identifies a result set. The result sets are returned in the order in which the cursors are opened.
 - If any cursors have specified a WITH RETURN clause, each cursor that is defined with the WITH RETURN clause that the procedure opens and leaves open when it returns identifies a result set. The result sets are returned in the order in which the cursors are opened.

When a result set is returned using an open cursor, the rows are returned starting with the current cursor position.

The RESULT SETS clause should be specified on the ALTER PROCEDURE (external), CREATE PROCEDURE (external) statement, or DECLARE PROCEDURE statement to return result sets from a procedure. The maximum number of result sets returned cannot be larger than the number specified on the ALTER PROCEDURE (external), CREATE PROCEDURE (external) statement, or DECLARE PROCEDURE statement.

SQL procedures: In order to return result sets from an SQL procedure, the procedure must be created with the RESULT SETS clause. Each cursor that is defined with the WITH RETURN clause that the procedure opens and leaves open when it returns identifies a result set.

- If a SET RESULT SETS statement is executed in the procedure, the SET RESULT SETS statement identifies which of these result sets to return. The result sets are returned in the order specified on the SET RESULT SETS statement.
- If a SET RESULT SETS statement is not executed in the procedure the result sets are returned in the order in which the cursors are opened.

When a result set is returned using an open cursor, the rows are returned starting with the current cursor position.

The RESULT SETS clause must be specified on the CREATE PROCEDURE (SQL) statement to return any result sets from an SQL procedure. The maximum number of result sets returned cannot be larger than the number specified on the CREATE PROCEDURE statement.

Example

The following SET RESULT SETS statement specifies cursor X as the result set that will be returned when the procedure is called. For more information and complete examples showing the use of result sets from ODBC clients, see the [IBM i Access Family](#) topic collection.

```
EXEC SQL SET RESULT SETS CURSOR X;
```

SET SCHEMA

The SET SCHEMA statement changes the value of the CURRENT SCHEMA special register.

Invocation

This statement can be embedded in an application program or issued interactively. It is an executable statement that can be dynamically prepared.

Authorization

If a global variable is referenced in the statement, the privileges held by the authorization ID of the statement must include at least one of the following:

- For the global variable identified in the statement,
 - The READ privilege on the global variable, and
 - The USAGE privilege on the schema containing the global variable
- Database administrator authority

Syntax

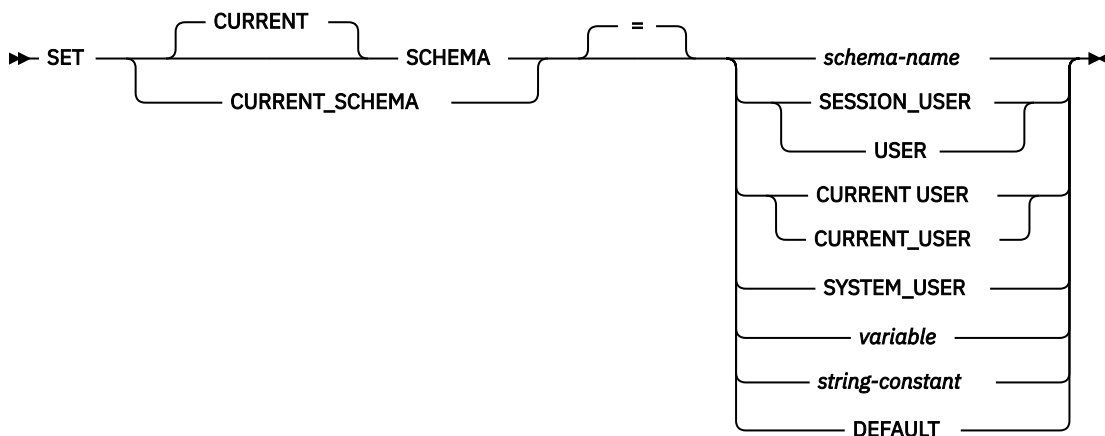

Description

schema-name

Identifies a schema. If the specified schema name is a system schema name, no validation that the schema exists is made at the time the current schema is set. If the specified schema name is not a system schema name, the schema must exist at the time the current schema is set.

If the value specified does not conform to the rules for a *schema-name*, an error is returned.

SESSION_USER or USER

This value is the SESSION_USER special register.

CURRENT USER

Specifies the value of the CURRENT USER special register.

SYSTEM_USER

This value is the SYSTEM_USER special register.

variable

Specifies a variable which contains a schema name. It can be a global variable if it is qualified with schema name. The content is not folded to uppercase.

The variable:

- Must be a character-string or Unicode graphic variable. The actual length of the contents of the *variable* after trimming any trailing blanks must not exceed the length of a schema name. See Appendix A, “SQL limits,” on page 1635.
- Must not be followed by an indicator variable.
- Must not be the null value.
- Must conform to the rules for forming an ordinary or delimited identifier.
- Must be padded on the right with blanks if the variable is fixed length.
- Must not be the keyword SESSION_USER, CURRENT_USER, SYSTEM_USER, or USER.
- If the SET statement is specified in an SQL routine, SQL trigger, or compound statement, *variable* cannot be a global variable with an unqualified name.

string-constant

A character constant with a schema name.

The string constant:

- Must have a length after trimming any trailing blanks that does not exceed the maximum length of a schema name
- Must include a schema name that is left justified and conforms to the rules for forming an ordinary or delimited identifier.
- Must not be the keyword SESSION_USER, CURRENT_USER, SYSTEM_USER, or USER.

DEFAULT

The CURRENT SCHEMA is set to its initial value. The initial value for SQL naming is USER. The initial value for system naming is *LIBL.

Notes

Considerations for keywords: There is a difference between specifying a single keyword (such as USER) as a single keyword or as a delimited identifier. To indicate that the current value of the USER special register should be used for setting the current schema, specify USER as a keyword. If USER is specified as a delimited identifier instead (for example, "USER"), it is interpreted as a schema name of that value ("USER").

Transaction considerations: The SET SCHEMA statement is not a committable operation. ROLLBACK has no effect on the CURRENT SCHEMA.

Impact on other special registers: Setting the CURRENT SCHEMA special register does not affect the CURRENT PATH special register. Hence, the CURRENT SCHEMA will not be included in the SQL path and functions, procedures and user-defined type resolution may not find these objects. To include the current schema value in the SQL path, whenever the SET SCHEMA statement is issued, also issue the SET PATH statement including the schema name from the SET SCHEMA statement.

CURRENT SCHEMA: The value of the CURRENT SCHEMA special register is used as the qualifier for some unqualified names in all dynamic SQL statements except in programs where the DYNDFTCOL has been specified. If DYNDFTCOL is specified in a program, its schema name is used instead of the CURRENT SCHEMA schema name. For information about qualification of names, see [“Qualification of unqualified object names”](#) on page 57.

For SQL naming, the initial value of the CURRENT SCHEMA special register is equivalent to USER. For system naming, the initial value of the CURRENT SCHEMA special register is *LIBL.

Syntax alternatives: CURRENT SQLID is accepted as a synonym for CURRENT SCHEMA and the effect of a SET CURRENT SQLID statement will be identical to that of a SET CURRENT SCHEMA statement. No other effects, such as statement authorization changes, will occur.

SET SCHEMA is equivalent to calling the QSQCHGDC API.

Examples

Example 1: The following statement sets the CURRENT SCHEMA special register.

```
SET SCHEMA = RICK
```

Example 2: The following example retrieves the current value of the CURRENT SCHEMA special register into the host variable called CURSCHEMA.

```
EXEC SQL VALUES(CURRENT SCHEMA) INTO :CURSCHEMA
```

The value would be RICK, set by the previous example.

SET SESSION AUTHORIZATION

The SET SESSION AUTHORIZATION statement changes the value of the SESSION_USER and USER special registers. It also changes the name of the user profile associated with the current thread.

Invocation

This statement can be embedded within an application program or issued interactively. It is an executable statement that can be dynamically prepared. It must not be specified in REXX.

SET SESSION AUTHORIZATION is not allowed in an SQL trigger, SQL function, or SQL procedure.

Authorization

If the authorization name specified on the statement is different than the value in the SYSTEM_USER special register, the privileges held by the authorization ID of the statement must include the system authority of *ALLOBJ.

No authorization is required to execute this statement if the authorization name specified on the statement is the same as the SYSTEM_USER special register.

If a global variable is referenced in the statement, the privileges held by the authorization ID of the statement must include at least one of the following:

- For the global variable identified in the statement,
 - The READ privilege on the global variable, and
 - The USAGE privilege on the schema containing the global variable
- Database administrator authority

Syntax

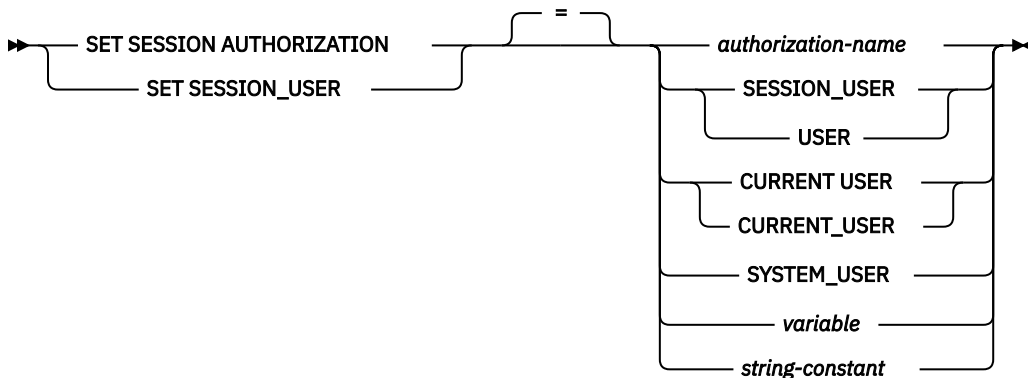

Description

authorization-name

Identifies an authorization ID that is to be used as the new value for the SESSION_USER special register and the runtime authorization ID.

The authorization ID must be a valid user profile or group user profile that exists at the current server. Several system user profiles that do not have a user profile handle may not be used. For more information, see the Get Profile Handle API.

CURRENT USER

The SESSION_USER special register and the runtime authorization ID are set to the CURRENT USER special register.

SESSION_USER or USER

The SESSION_USER special register and the runtime authorization ID are set to the USER special register.

SYSTEM_USER

The SESSION_USER special register and the runtime authorization ID are set to the SYSTEM_USER special register.

variable

A variable which contains an authorization ID name. It can be a global variable if it is qualified with schema name.

The variable:

- Must be a character-string variable.
- If *variable* has an associated indicator variable, the value of that indicator variable must not indicate a null value
- Must include an authorization ID that is left justified and must conform to the rules for forming an ordinary or delimited identifier.
- Must be padded on the right with blanks.
- Must not be the null value.
- Must not be the keyword USER, SESSION_USER, SYSTEM_USER, or CURRENT_USER.

string-constant

A character constant with an authorization ID.

Notes

Other effects of SET SESSION AUTHORIZATION: SET SESSION AUTHORIZATION causes the following to occur:

- All cursors that were opened during the unit of work are closed.
- All LOB locators are freed.
- All locks acquired under this unit of work's commitment definition are released.
- All prepared statements are destroyed.
- All SQL descriptor areas are deallocated.
- All procedure result sets are cleared.
- The encryption password is reset.
- All open native database files and Integrated File System (IFS) files are closed, including sockets, NTC sessions, and memory maps.

Other resources are preserved when SET SESSION AUTHORIZATION is executed, including global variables and declared temporary tables. It is recommended that all declared temporary tables be dropped or cleared and global variables be cleared before executing the SET SESSION AUTHORIZATION statement.

SET SESSION AUTHORIZATION restrictions: This statement can only be issued as the first statement that results in work that might be backed out during the unit of work. The following executable statements may be issued prior to executing SET SESSION AUTHORIZATION:

- All SQL transaction statements
- All SQL connection statements
- All SQL session statements
- GET DIAGNOSTICS

SET SESSION AUTHORIZATION is not allowed if any connections other than the connection to the current server exist, including any local connections to a non-default activation group.

SET SESSION AUTHORIZATION is not allowed if any held cursors are open or any held locators exist.

SET SESSION AUTHORIZATION scope: The scope of the SET SESSION AUTHORIZATION is the current thread. Other threads in the application process are unaffected.

Examples

Example 1: The following statement sets the SESSION_USER special register.

```
SET SESSION_USER = RAJIV
```

Example 2: Set the session authorization ID (the SESSION_USER special register) to be the value of the system authorization ID, which is the ID that established the connection on which the statement has been issued.

```
SET SESSION AUTHORIZATION SYSTEM_USER
```

SET TRANSACTION

The SET TRANSACTION statement sets the isolation level, read only attribute, or diagnostics area size for the current unit of work.

Invocation

This statement can be embedded within an application program or issued interactively. It is an executable statement that can be dynamically prepared.

Authorization

If a global variable is referenced in the statement, the privileges held by the authorization ID of the statement must include at least one of the following:

- For the global variable identified in the statement,
 - The READ privilege on the global variable, and
 - The USAGE privilege on the schema containing the global variable
- Database administrator authority

Syntax

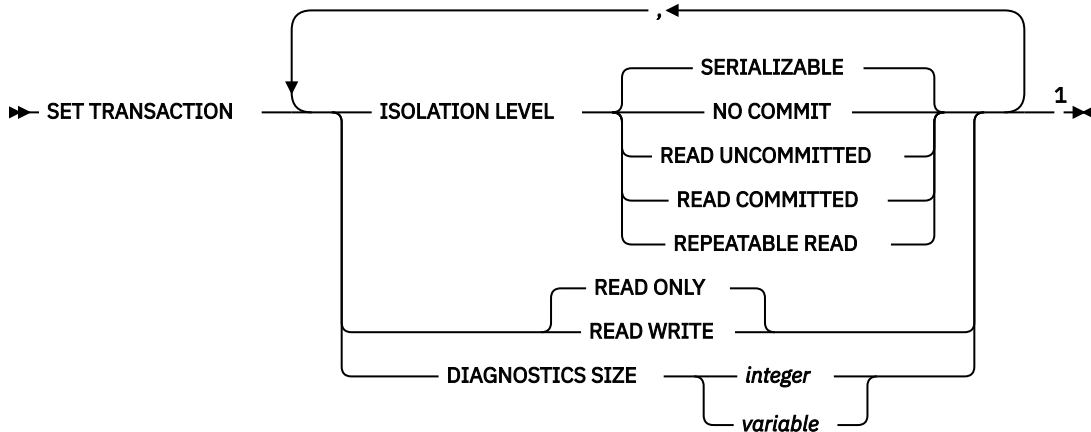

Notes:

- ¹ Only one ISOLATION LEVEL clause, one READ WRITE or READ ONLY clause, and one DIAGNOSTICS SIZE clause may be specified.

Description

ISOLATION LEVEL

Specifies the isolation level of the transaction. If the ISOLATION LEVEL clause is not specified, ISOLATION LEVEL SERIALIZABLE is implicit

NO COMMIT

Specifies isolation level NC (COMMIT(*NONE)).

READ UNCOMMITTED

Specifies isolation level UR (COMMIT(*CHG)).

READ COMMITTED

Specifies isolation level CS (COMMIT(*CS)).

REPEATABLE READ

Specifies isolation level RS (COMMIT(*ALL)).

SERIALIZABLE

Specifies isolation level RR (COMMIT(*RR)).

READ WRITE or READ ONLY

Specifies whether the transaction allows data change operations.

READ WRITE

Specifies that all SQL operations are allowed. This is the default unless ISOLATION LEVEL READ UNCOMMITTED is specified.

READ ONLY

Specifies that only SQL operations that do not change SQL data are allowed. If ISOLATION LEVEL READ UNCOMMITTED is specified, this is the default.

DIAGNOSTICS SIZE

Specifies the maximum number of GET DIAGNOSTICS condition areas for the current transaction. The GET DIAGNOSTICS *statement-information-item* MORE will be set to 'Y' for the current statement if the statement exceeds the maximum number of condition areas for the current transaction. The maximum size of the diagnostics area is 90K. The specified maximum number of condition areas must be between 1 and 32767.

integer

An integer constant that specifies the maximum number of condition areas for the current transaction.

variable

Identifies a variable which contains the maximum number of condition areas for the current transaction. The variable must be a numeric variable with a zero scale and must not be followed by an indicator variable.

Notes

Scope of SET TRANSACTION: The SET TRANSACTION statement sets the isolation level for SQL statements for the current activation group of the process. If that activation group has commitment control scoped to the job, then the SET TRANSACTION statement sets the isolation level of all other activation groups with job commit scoping as well.

If an isolation clause is specified in an SQL statement, that isolation level overrides the transaction isolation level and is used for dynamic SQL statements.

The scope of the SET TRANSACTION statement is based on the context in which it is run. If the SET TRANSACTION statement is run in a trigger, the isolation level specified applies to all subsequent SQL statements until another SET TRANSACTION statement occurs or until the trigger completes, whichever happens first. If the SET TRANSACTION statement is run outside a trigger, the isolation level specified applies to all subsequent SQL statements (except those statements within a trigger that are executed after a SET TRANSACTION statement in the trigger) until a COMMIT or ROLLBACK operation occurs.

For more information about isolation levels, see [“Isolation level”](#) on page 23.

SET TRANSACTION restrictions: The SET TRANSACTION statement can only be executed when it is the first SQL statement in a unit of work, unless:

- all previous statements executed in the unit of work are SET TRANSACTION statements or statements that are executed under isolation level NC, or
- it is executed in a trigger.

In a trigger, SET TRANSACTION with READ ONLY is allowed only on a COMMIT boundary. The SET TRANSACTION statement can be executed in a trigger at any time, but it is recommended that it be executed as the first statement in the trigger. The SET TRANSACTION statement is useful within triggers to set the isolation level for SQL statements in the trigger to the same level as the application which caused the trigger to be activated.

A SET TRANSACTION statement is not allowed if the current connection is to a remote application server unless it is in a trigger at the current server. Once a SET TRANSACTION statement is executed, CONNECT and SET CONNECTION statements are not allowed until the unit of work is committed or rolled back.

SET TRANSACTION is not allowed as the first statement in a secondary thread.

The SET TRANSACTION statement has no effect on WITH HOLD cursors that are still open when the SET TRANSACTION statement is executed.

Syntax alternatives: The following keywords are synonyms supported for compatibility to prior releases. These keywords are non-standard and should not be used:

- The keywords NC or NONE can be used as synonyms for NO COMMIT.
- The keywords UR and CHG can be used as synonyms for READ UNCOMMITTED.
- The keyword CS can be used as a synonym for READ COMMITTED.
- The keywords RS or ALL can be used as synonyms for REPEATABLE READ.
- The keyword RR can be used as a synonym for SERIALIZABLE.

Examples

Example 1: The following SET TRANSACTION statement sets the isolation level to NONE (equivalent to specifying *NONE on the SQL precompiler command).

```
EXEC SQL SET TRANSACTION ISOLATION LEVEL NO COMMIT;
```

Example 2: The following SET TRANSACTION statement sets the isolation level to SERIALIZABLE.

```
SET TRANSACTION ISOLATION LEVEL SERIALIZABLE
```

SET variable

The SET variable statement produces a result table consisting of at most one row and assigns the values in that row to variables.

Invocation

This statement can be embedded in an application program. It is an executable statement that can be dynamically prepared if the all variables being set are global variables. It must not be specified in REXX.

Authorization

If a *row-fullselect* is specified, see “fullselect” on page 771 for an explanation of the authorization required for each subselect.

If a global variable is specified on the left hand side of the assignment, the privileges held by the authorization ID of the statement must include at least one of the following:

- The WRITE privilege on the global variable.
- Database administrator authority

Syntax

➤ SET ➤

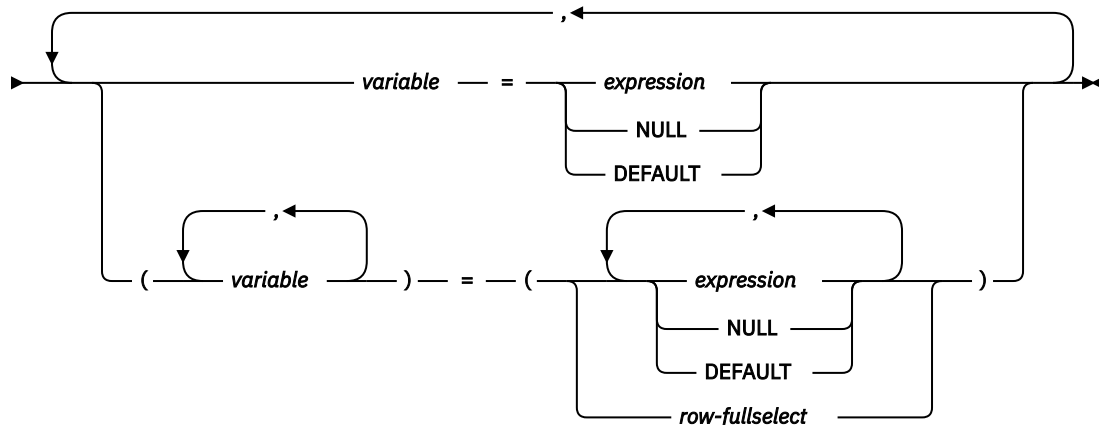

row-fullselect

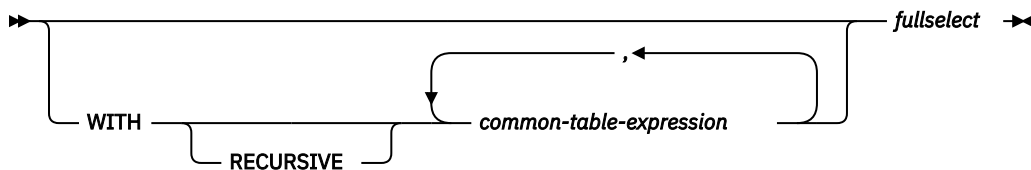

Description

variable, ...

Identifies one or more variables or host structures that must be declared in accordance with the rules for declaring variables (see “References to host variables” on page 140). A host structure is logically replaced by a list of variables that represent each of the elements of the host structure.

The value to be assigned to each *variable* can be specified immediately following the *variable*, for example, *variable* = *expression*, *variable* = *expression*. Or, sets of parentheses can be used to specify all the *variables* and then all the values, for example, (*variable*, *variable*) = (*expression*, *expression*).

The data type of each variable must be compatible with its corresponding result column. Each assignment is made according to the rules described in [“Assignments and comparisons”](#) on page 91. The number of *variables* specified to the left of the equal operator must equal the number of values in the corresponding result specified to the right of the equal operator. If the value is null, an indicator variable must be provided. If an assignment error occurs, the value is not assigned to the variable, and no more values are assigned to variables. Any values that have already been assigned to variables remain assigned.

If an error occurs as the result of an arithmetic expression in the *expression* or SELECT list of the subselect (division by zero, or overflow) or a character conversion error occurs, the result is the null value. As in any other case of a null value, an indicator variable must be provided. The value of the variable is undefined. In this case, however, the indicator variable is set to -2. Processing of the statement continues as if the error had not occurred. (However, a warning is returned.) If you do not provide an indicator variable, an error is returned. It is possible that some values have already been assigned to variables and will remain assigned when the error occurs.

expression

Specifies the new value of the variable. The *expression* is any expression of the type described in [“Expressions”](#) on page 159. It must not include a column name.

NULL

Specifies that the new value for the variable is the null value.

DEFAULT

Specifies that the new value for the variable is its initial default value. DEFAULT can only be assigned to a global variable. Only one variable can be assigned in the SET statement when DEFAULT is used.

row-fullselect

A fullselect that returns a single result row. The result column values are assigned to each corresponding *variable*. If the result of the fullselect is no rows, then null values are assigned. An error is returned if there is more than one row in the result.

WITH common-table-expression

Specifies a common table expression. For an explanation of common table expression, see [“common-table-expression”](#) on page 778.

fullselect

A *fullselect* that returns a single result row. The result column values are assigned to each corresponding *variable*. If the result of the *fullselect* is no rows, then null values are assigned. An error is returned if there is more than one row in the result.

Notes

Variable assignment: If the specified variable is character and is not large enough to contain the result, a warning (SQLSTATE 01004) is returned (and 'W' is assigned to SQLWARN1 in the SQLCA). The actual length of the result is returned in the indicator variable associated with the variable, if an indicator variable is provided.

If the specified variable is a C NUL-terminated variable and is not large enough to contain the result and the NUL-terminator:

- If the *CNULRQD option is specified on the CRTSQLCI or CRTSQLCPPI command (or CNULRQD(*YES) on the SET OPTION statement), the following occurs:
 - The result is truncated.
 - The last character is the NUL-terminator.
 - The value 'W' is assigned to SQLWARN1 in the SQLCA.
- If the *NOCNULRQD option on the CRTSQLCI or CRTSQLCPPI command (or CNULRQD(*NO) on the SET OPTION statement) is specified, the following occurs:
 - The NUL-terminator is not returned.
 - The value 'N' is assigned to SQLWARN1 in the SQLCA.

Multiple assignments: If more than one assignment is included in the same SET statement, all *expressions* and *row-fullselects* are completely evaluated before the assignments are performed. Thus, references to a target variable in an *expression* or *row-fullselect* are always the value of the target variable prior to any assignment in the SET statement.

Examples

Example 1: Assign the value of the CURRENT PATH special register to host variable HV1.

```
EXEC SQL SET :HV1 = CURRENT PATH;
```

Example 2: Assume that LOB locator LOB1 is associated with a CLOB value. Assign a portion of the CLOB value to host variable DETAILS using the LOB locator.

```
EXEC SQL SET :DETAILS = SUBSTR(:LOB1,1,35);
```

SIGNAL

The SIGNAL statement signals an error or warning condition. It causes an error or warning to be returned with the specified SQLSTATE and optional *condition-information-items*.

Invocation

This statement can only be embedded in an application program. It is an executable statement that cannot be dynamically prepared. It must not be specified in REXX.

Authorization

None required.

Syntax

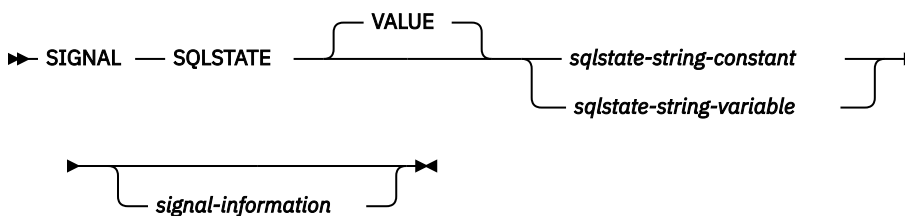

signal-information

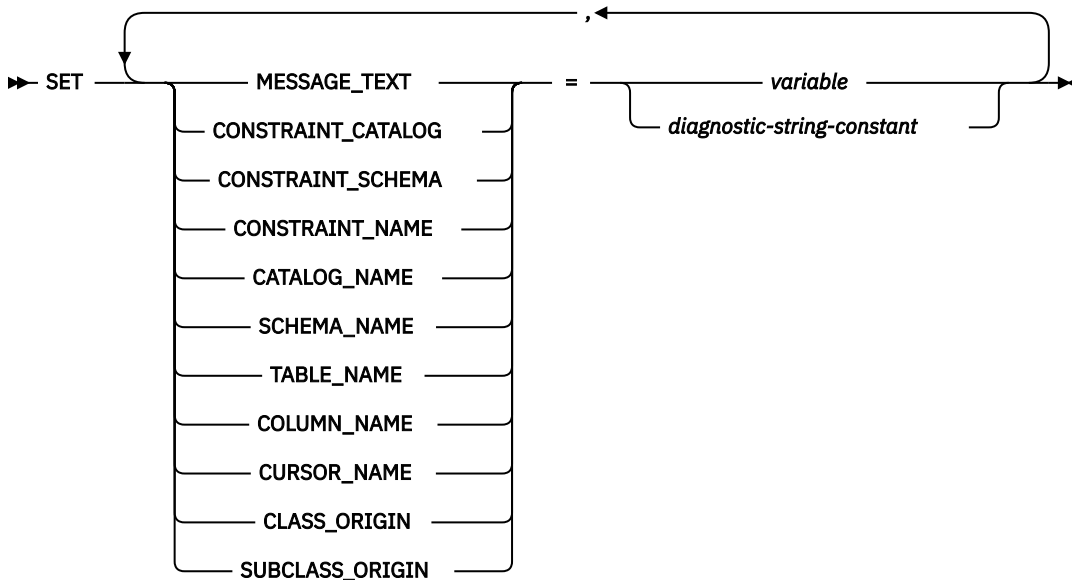

Description

SQLSTATE VALUE

Specifies the SQLSTATE that will be signalled. The specified value must not be null and must follow the rules for SQLSTATES:

- Each character must be from the set of digits ('0' through '9') or non-accented upper case letters ('A' through 'Z').
- The SQLSTATE class (first two characters) cannot be '00' since this represents successful completion.

If the SQLSTATE does not conform to these rules, an error is returned.

sqlstate-string-constant

The *sqlstate-string-constant* must be a character string constant with exactly 5 characters.

sqlstate-string-variable

The *sqlstate-string-variable* must be a character or Unicode graphic variable. It cannot be a global variable. The actual length of the contents of the *variable* must be 5.

SET

Introduces the assignment of values to *condition-information-items*. The *condition-information-item* values can be accessed using the GET DIAGNOSTICS statement. The only *condition-information-item* that can be accessed in the SQLCA is MESSAGE_TEXT.

MESSAGE_TEXT

Specifies a string that describes the error or warning.

If an SQLCA is used,

- the string is returned in the SQLERRMC field of the SQLCA
- if the actual length of the string is longer than 1000 bytes, it is truncated without a warning.

CONSTRAINT_CATALOG

Specifies a string that indicates the name of the database that contains a constraint related to the signalled error or warning.

CONSTRAINT_SCHEMA

Specifies a string that indicates the name of the schema that contains a constraint related to the signalled error or warning.

CONSTRAINT_NAME

Specifies a string that indicates the name of a constraint related to the signalled error or warning.

CATALOG_NAME

Specifies a string that indicates the name of the database that contains a table or view related to the signalled error or warning.

SCHEMA_NAME

Specifies a string that indicates the name of the schema that contains a table or view related to the signalled error or warning.

TABLE_NAME

Specifies a string that indicates the name of a table or view related to the signalled error or warning.

COLUMN_NAME

Specifies a string that indicates the name of a column in the table or view related to the signalled error or warning.

CURSOR_NAME

Specifies a string that indicates the name of a cursor related to the signalled error or warning.

CLASS_ORIGIN

Specifies a string that indicates the origin of the SQLSTATE class related to the signalled error or warning.

SUBCLASS_ORIGIN

Specifies a string that indicates the origin of the SQLSTATE subclass related to the signalled error or warning.

variable

Identifies a variable that must be declared in accordance with the rules for declaring variables (see “References to host variables” on page 140). The variable contains the value to be assigned to the *condition-information-item*. The variable must be defined as CHAR, VARCHAR, Unicode GRAPHIC, or Unicode VARGRAPHIC variable. It cannot be a global variable.

diagnostic-string-constant

Specifies a character string constant that contains the value to be assigned to the *condition-information-item*.

Notes

SQLSTATE values: Any valid SQLSTATE value can be used in the SIGNAL statement. However, it is recommended that programmers define new SQLSTATEs based on ranges reserved for applications. This prevents the unintentional use of an SQLSTATE value that might be defined by the database manager in a future release.

SQLSTATE values are comprised of a two-character class code value, followed by a three-character subclass code value. Class code values represent classes of successful and unsuccessful execution conditions.

- SQLSTATE classes that begin with the characters '7' through '9' or 'I' through 'Z' may be defined. Within these classes, any subclass may be defined.
- SQLSTATE classes that begin with the characters '0' through '6' or 'A' through 'H' are reserved for the database manager. Within these classes, subclasses that begin with the characters '0' through 'H' are reserved for the database manager. Subclasses that begin with the characters 'I' through 'Z' may be defined.

For more information about SQLSTATEs, see the [SQL Messages and Codes](#) topic collection.

Assignment: When the SIGNAL statement is executed, the value of each of the specified *string-constants* and *variables* is assigned to the corresponding *condition-information-item*. However, if the length of a *string-constant* or *variable* is longer than the maximum length of the corresponding *condition-information-item*, it is truncated without a warning. For details on the assignment rules, see “[Assignments and comparisons](#)” on page 91. For details on the maximum length of specific *condition-information-items*, see “[GET DIAGNOSTICS](#)” on page 1324.

Processing a SIGNAL statement: When a SIGNAL statement is issued, the SQLCODE is based on the SQLSTATE value as follows:

- If the specified SQLSTATE class is either '01' or '02', a warning or not found is signalled and the SQLCODE is set to +438.
- Otherwise, an exception is signalled and the SQLCODE is set to -438.

Examples

Example 1: Signal SQLSTATE '75002' with a descriptive message text.

```
EXEC SQL SIGNAL SQLSTATE '75002'  
        SET MESSAGE_TEXT = 'Customer number is not known';
```

Example 2: Signal SQLSTATE '75002' with a descriptive message text and associate a specific table with the error.

```
EXEC SQL SIGNAL SQLSTATE '75002'  
        SET MESSAGE_TEXT = 'Customer number is not known',  
        SCHEMA_NAME = 'CORPDATA',  
        TABLE_NAME = 'CUSTOMER';
```

TAG

The TAG statement identifies the branch location for a WHENEVER statement in ILE RPG. The statement can be used to define a *host-label* instead of defining the label directly with an RPG TAG operation.

Invocation

This statement can only be embedded in an ILE RPG application program. It is not an executable statement.

Authorization

None required.

Syntax

➤ TAG — *host-label* ➤

Description

host-label

Specifies the label to use for generating an ILE RPG TAG operation. This is intended to identify the next executable statement for the GOTO clause of a WHENEVER statement.

Note

SQL does not verify the position of the TAG statement or the uniqueness or value of *host-label*. The ILE RPG compiler must allow a TAG operation at the SQL TAG statement's location.

Example

In a free-form ILE RPG program, continue processing at HANDLER for an SQL statement that produces an error.

```
EXEC SQL WHENEVER SQLERROR GOTO HANDLER;  
EXEC SQL TAG HANDLER;
```

TRANSFER OWNERSHIP

The TRANSFER OWNERSHIP statement transfers ownership of a database object.

Invocation

This statement can be embedded in an application program or issued interactively. It is an executable statement that can be dynamically prepared.

Authorization

To transfer ownership for a table, view, or index, the authorization ID of the statement must be the owner of the object and the privileges held must include at least one of the following:

- The following system authorities:
 - The system authorities of *OBJOPR and *OBJEXIST on the object to be transferred
 - The USAGE privilege on the schema that contains the object to be transferred
- Database administrator authority
- Security administrator authority

For information about the system authorities corresponding to SQL privileges, see [Corresponding System Authorities When Checking Privileges to a Table or View](#).

Syntax

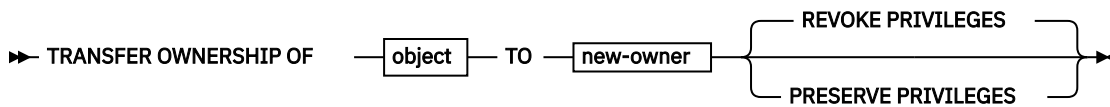

object

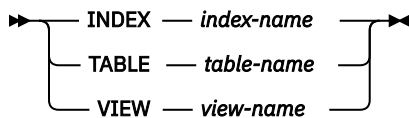

new-owner

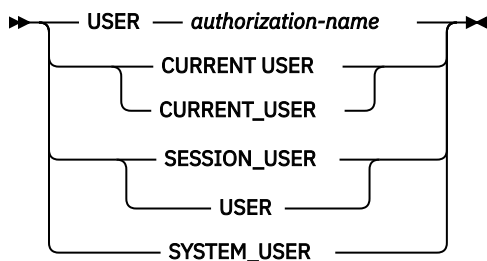

Description

INDEX *index-name*

Identifies the index that is to have its ownership transferred. The *index-name* must identify an index that exists at the current server.

TABLE *table-name*

Identifies the table that is to have its ownership transferred. The *table-name* must identify a base table that exists at the current server, but must not identify a declared global temporary table or a catalog table.

VIEW *view-name*

Identifies the view that is to have its ownership transferred. The *view-name* must identify a view that exists at the current server, but must not identify a catalog view.

USER *authorization-name*

Specifies the authorization ID to which ownership of the object is being transferred.

CURRENT USER or CURRENT_USER

Specifies that the value of the CURRENT_USER special register is to be used as the authorization ID to which ownership of the object is being transferred.

SESSION_USER or USER

Specifies that the value of the SESSION_USER special register is to be used as the authorization ID to which ownership of the object is being transferred.

SYSTEM_USER

Specifies that the value of the SYSTEM_USER special register is to be used as the authorization ID to which ownership of the object is being transferred.

REVOKE PRIVILEGES or PRESERVE PRIVILEGES

Specifies the privileges of the current owner of the object after the ownership is transferred.

REVOKE PRIVILEGES

Specifies that the current owner will not have any explicit privileges to the object after the transfer is complete.

PRESERVE PRIVILEGES

Specifies that the current owner of an object that is to have its ownership transferred will continue to hold any existing privileges on the object after the transfer. For example, any privileges that were granted to the creator of a view continue to be held by the original owner even after ownership has been transferred to another user.

Rules

Ownership of most system-defined objects cannot be transferred.

Ownership of objects in a schema whose name starts with 'SYS' or 'Q' cannot be transferred.

An authorization ID that has security administrator authority cannot transfer ownership of an object to itself, if it is not already the owner of the object.

Notes

- All privileges that the current owner has on the object are transferred to the new owner.
- When the ownership of a database object is transferred, the new owner will not necessarily have privileges for the object's dependencies.
- If an attempt is made to transfer ownership of an object to its owner, a warning is returned.

Examples

Example 1: Transfer ownership of table T1 to PAUL.

```
TRANSFER OWNERSHIP OF TABLE WALID.T1  
TO USER PAUL PRESERVE PRIVILEGES
```

Paul becomes the owner of table WALID.T1 and is granted all the privileges that the previous owner of the table had. The prior owner retains all privileges as well.

Example 2: Transfer ownership of view V1 to HENRY and remove privileges from the previous owner

```
TRANSFER OWNERSHIP OF VIEW V1  
TO USER HENRY
```

Henry becomes the owner of view V1 and is granted all the privileges that the previous owner of the view had. The prior owner no longer has any explicit privileges on the view.

TRUNCATE

The TRUNCATE statement deletes all of the rows from a table.

Invocation

This statement can be embedded in an application program or issued interactively. It is an executable statement that can be dynamically prepared.

Authorization

The privileges held by the authorization ID of the statement must include at least one of the following:

- For the table identified in the statement:
 - The DELETE privilege on the table, and
 - The USAGE privilege on the schema containing the table.
- Database administrator authority

If the IGNORE DELETE TRIGGERS option is specified, the privileges held by the authorization ID of the statement must include the following:

- The ALTER privilege on the table and the system authority of *OBJOPR on the table.

If row access control or column access control is activated for the table, the privileges held by the authorization ID of the statement must include the following:

- The system authorities of *OBJOPR and *OBJEXIST on the table.

For information about the system authorities corresponding to SQL privileges, see [Corresponding System Authorities When Checking Privileges to a Table or View](#).

Syntax

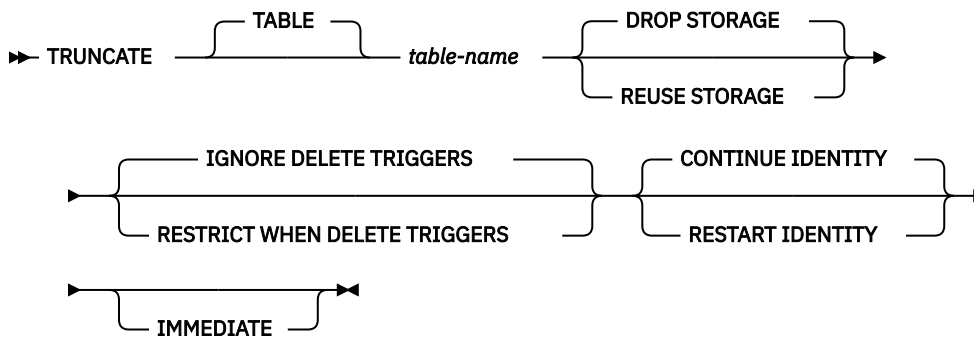

Description

table-name

Identifies the table from which rows are to be deleted. The name must identify a table that exists at the current server. It must not identify a catalog table, a view, or a system-period temporal table.

DROP STORAGE or REUSE STORAGE

Specifies whether to drop or reuse the existing storage that is allocated for the table.

DROP STORAGE

All storage allocated for the table is released and made available. This is the default.

REUSE STORAGE

All storage allocated for the table will continue to be allocated for the table, but the storage will be considered empty.

IGNORE DELETE TRIGGERS or RESTRICT WHEN DELETE TRIGGERS

Specifies what to do when delete triggers are defined on the table.

IGNORE DELETE TRIGGERS

Specifies that any delete triggers that are defined for the table are not activated by the truncation operation. This is the default.

RESTRICT WHEN DELETE TRIGGERS

Specifies that an error is returned if delete triggers are defined on the table

CONTINUE IDENTITY or RESTART IDENTITY

Specifies how to handle generation of identity column values.

CONTINUE IDENTITY

If an identity column exists for the table, the next identity column value generated continues with the next value that would have been generated if the TRUNCATE statement had not been executed. This is the default.

RESTART IDENTITY

If an identity column exists for the table, the next identity column value generated is the initial value that was specified when the identity column was defined.

IMMEDIATE

Specifies that the truncate operation is processed immediately and cannot be undone.

The truncated table is immediately available for use in the same unit of work. Although a ROLLBACK statement is allowed to execute after a TRUNCATE statement, the truncate operation is not undone, and the table remains in a truncated state. For example, if another data change operation is done on the table after the TRUNCATE IMMEDIATE statement and then the ROLLBACK statement is executed, the truncate operation will not be undone, but all other data change operations are undone.

The truncate operation cannot be performed if any session has a cursor open on the table or holds a lock on the table.

If IMMEDIATE is not specified, a ROLLBACK statement can undo the truncate operation.

Notes

Referential Integrity: The identified table cannot be a parent table in a referential constraint.

Number of rows deleted: The ROW_COUNT condition area item in the SQL Diagnostics Area (or SQLERRD(3) in the SQLCA) is set to -1 for the truncate operation. The total number of rows that were deleted from the table is not returned.

If no rows exist in the table, a SQLSTATE value of '02000' is returned.

For a description of the SQLCA, see [Appendix C, “SQLCA \(SQL communication area\),”](#) on page 1657.

Examples

Example 1: Empty an unused inventory table regardless of any existing triggers and return its allocated space.

```
TRUNCATE TABLE INVENTORY
DROP STORAGE
IGNORE DELETE TRIGGERS;
```

Example 2: Empty an unused inventory table regardless of any existing triggers but preserve its allocated space for later reuse.

```
TRUNCATE TABLE INVENTORY
REUSE STORAGE
IGNORE DELETE TRIGGERS;
```

Example 3: Empty an unused inventory table permanently (a ROLLBACK statement cannot undo the truncate operation when the IMMEDIATE option is specified) regardless of any existing triggers and preserve its allocated space for reuse.

```
TRUNCATE TABLE INVENTORY  
REUSE STORAGE  
IGNORE DELETE TRIGGERS  
IMMEDIATE;
```

UPDATE

The UPDATE statement updates the values of specified columns in rows of a table or view. Updating a row of a view updates a row of its base table, if no INSTEAD OF UPDATE trigger is defined on this view. If such a trigger is defined, the trigger will be activated instead.

There are two forms of this statement:

- The *Searched* UPDATE form is used to update one or more rows (optionally determined by a search condition).
- The *Positioned* UPDATE form is used to update exactly one row (as determined by the current position of a cursor).

Invocation

A Searched UPDATE statement can be embedded in an application program or issued interactively. A Positioned UPDATE must be embedded in an application program. Both forms are executable statements that can be dynamically prepared.

Authorization

The privileges held by the authorization ID of the statement must include at least one of the following:

- For the table or view identified in the statement:
 - The UPDATE privilege on the table or view, or
 - The UPDATE privilege on each column to be updated; and
 - The USAGE privilege on the schema containing the table or view
- Database administrator authority

If the *expression* in the *assignment-clause* contains a reference to a column of the table or view, or if the *search-condition* in a Searched UPDATE contains a reference to a column of the table or view, then the privileges held by the authorization ID of the statement must also include one of the following:

- The SELECT privilege on the table or view
- security administrator authority

If the *search-condition* includes a subquery or if the *assignment-clause* includes a *scalar-fullselect* or *row-fullselect*, see [Chapter 6, “Queries,” on page 723](#) for an explanation of the authorization required for each subselect.

For information about the system authorities corresponding to SQL privileges, see [Corresponding System Authorities When Checking Privileges to a Table or View](#).

Syntax

Searched UPDATE:

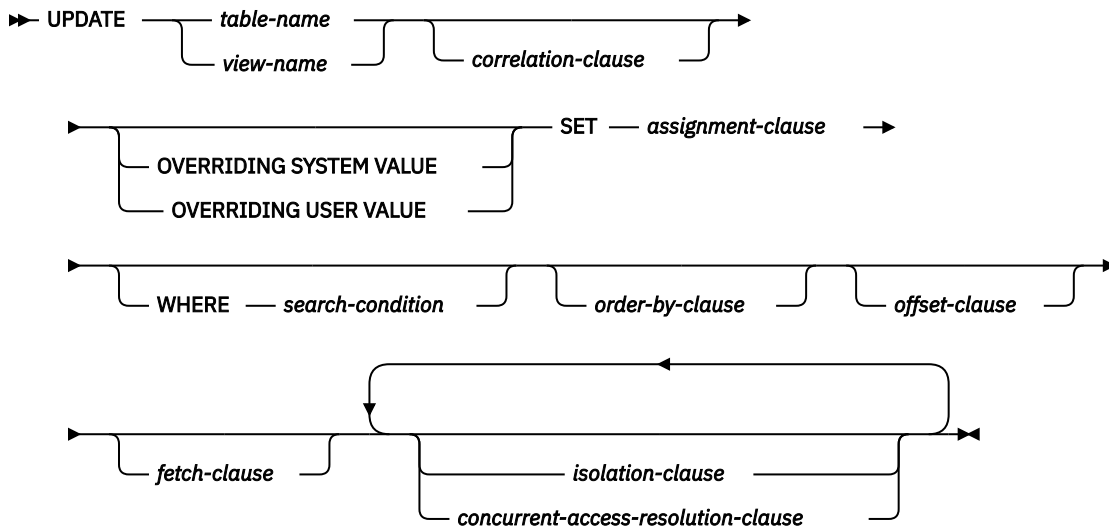

Positioned UPDATE:

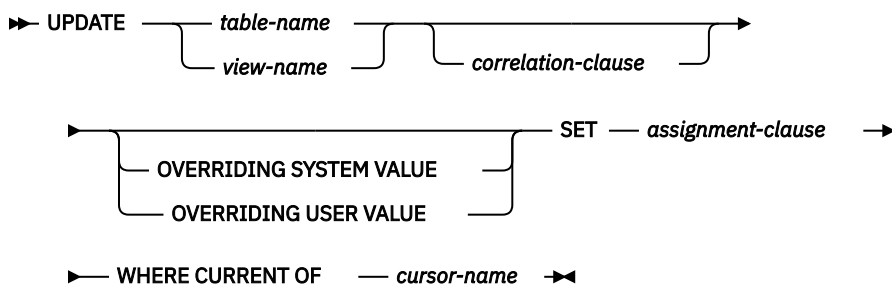

assignment-clause

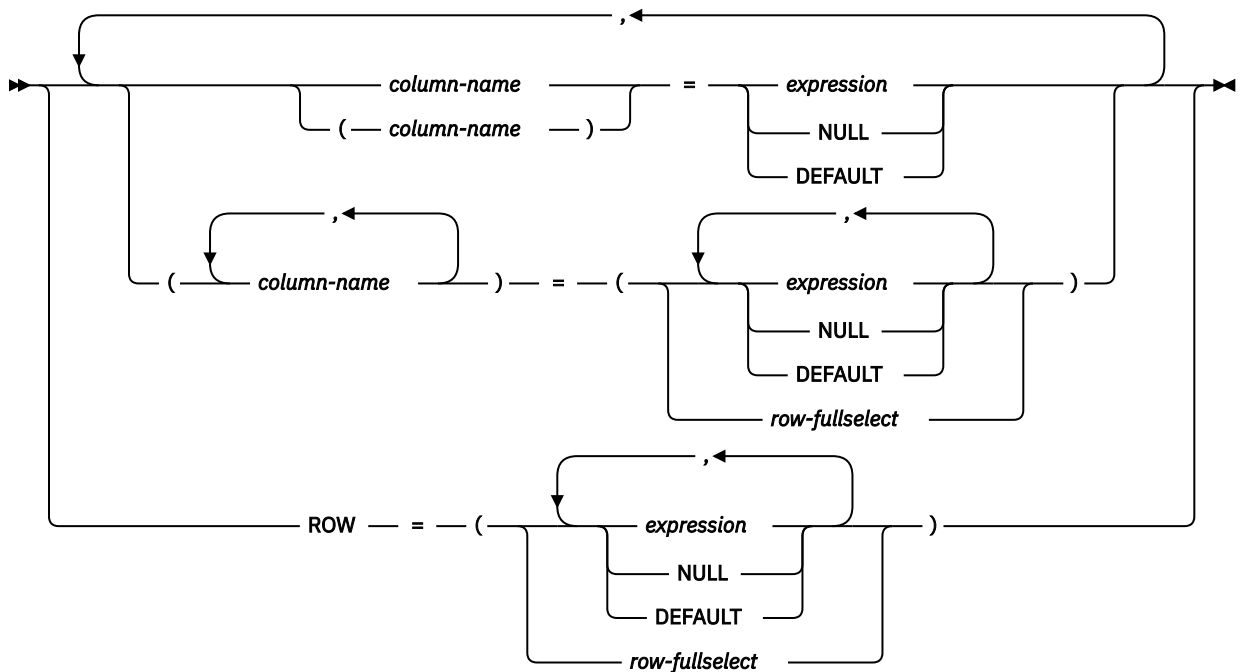

order-by-clause

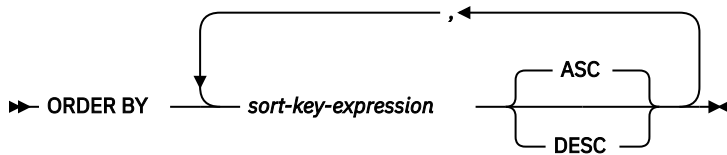

isolation-clause

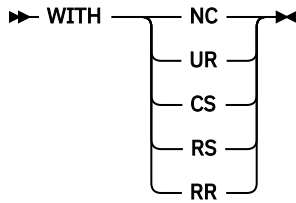

Description

table-name or view-name

Identifies the table or view to be updated. The name must identify a table or view that exists at the current server, but it must not identify a history table, a catalog table, a view of a catalog table, or a read-only view. For an explanation of read-only views and updatable views, see [“CREATE VIEW”](#) on page 1198.

correlation-clause

Can be used within *search-condition* or *assignment-clause* to designate the table or view. For an explanation of *correlation-clause*, see [“table-reference”](#) on page 730. For an explanation of *correlation-name*, see [“Correlation names”](#) on page 133.

OVERRIDING SYSTEM VALUE or OVERRIDING USER VALUE

Specifies whether system-generated values or user-specified values for a ROWID, identity, or row change timestamp column are used. If **OVERRIDING SYSTEM VALUE** is specified, the implicit or explicit list of columns in the SET clause must contain a ROWID, identity, or row change timestamp column defined as **GENERATED ALWAYS**. If **OVERRIDING USER VALUE** is specified, the implicit or explicit list of columns in the SET clause must contain a column defined as either **GENERATED ALWAYS** or **GENERATED BY DEFAULT**.

OVERRIDING SYSTEM VALUE

Specifies that the value specified in the SET clause for a ROWID, identity, or row change timestamp column that is defined as **GENERATED ALWAYS** is used. A system-generated value is not used.

If a value for a row-begin, row-end, transaction-start-ID, or generated expression column is provided, it must be **DEFAULT**.

OVERRIDING USER VALUE

Specifies that the value specified in the SET clause for a column that is defined as either **GENERATED ALWAYS** or **GENERATED BY DEFAULT** is ignored. Instead, a system-generated value is used, overriding the user-specified value.

If neither **OVERRIDING SYSTEM VALUE** or **OVERRIDING USER VALUE** is specified:

- A value cannot be specified for a ROWID, identity, row change timestamp, row-begin, row-end, transaction-start-ID, or generated expression column that is defined as **GENERATED ALWAYS**.
- A value can be specified for a ROWID column that is defined as **GENERATED BY DEFAULT**. If a value is specified, that value is assigned to the column. However, a value in a ROWID column defined **BY DEFAULT** can be updated only if the specified value is a valid row ID value that was previously generated by Db2 for z/OS or Db2 for i.
- A value can be specified for an identity or row change timestamp column that is defined as **GENERATED BY DEFAULT**. When a value of an identity column or row change timestamp column defined **BY DEFAULT** is updated, the database manager does not verify that the specified value is a unique value for the column unless the identity column or row change timestamp column is the sole

key in a unique constraint or unique index. Without a unique constraint or unique index, the database manager can guarantee unique values only among the set of system-generated values as long as NO CYCLE is in effect.

If a value is not specified the database manager generates a new value.

SET

Introduces the assignment of values to column names.

assignment-clause

column-name

Identifies a column to be updated. The *column-name* must identify a column of the specified table or view. If extended indicators are not enabled, that column must be an updatable column. A column must not be specified more than once.

For a Positioned UPDATE:

- If the UPDATE clause was specified in the SELECT statement of the cursor, each column name in the SET list must also appear in the UPDATE clause.
- If the UPDATE clause was not specified in the SELECT statement of the cursor, the name of any updatable column may be specified.

For more information, see [“update-clause” on page 784](#).

A view column derived from the same column as another column of the view can be updated, but both columns cannot be updated in the same UPDATE statement.

If a list of *column-names* is specified, the number of *expressions*, NULLs, and DEFAULTS must match the number of *column-names*.

ROW

Identifies all the columns of the specified table or view except for columns defined with the hidden attribute. If a view is specified, none of the columns of the view may be derived from a scalar function, constant, or expression.

The number of *expressions*, NULLs, and DEFAULTs (or the number of result columns from a *row-fullselect*) must match the number of columns in the row.

For a Positioned UPDATE, if the UPDATE clause was specified in the SELECT statement of the cursor, each column of the table or view must also appear in the UPDATE clause. For more information, see [“update-clause” on page 784](#).

ROW may not be specified for a view that contains a view column derived from the same column as another column of the view, because both columns cannot be updated in the same UPDATE statement.

expression

Specifies the new value of the column. The *expression* is any expression of the type described in [“Expressions” on page 159](#). It must not include an aggregate function.

A *column-name* in an expression must name a column of the named table or view. For each row updated, the value of the column in the expression is the value of the column in the row before the row is updated.

Each variable in the clause must identify a host structure or variable that is declared in accordance with the rules for declaring host structures and variables. In the operational form of the statement, a reference to a host structure is replaced by a reference to each of its variables. If *expression* is a single host variable, the host variable can include an indicator with an extended indicator value. If extended indicators are enabled and an expression in the assignment clause is not a single host variable, the extended indicator values of DEFAULT and UNASSIGNED must not be used. For further information about variables and structures, see [“References to host variables” on page 140](#) and [“Host structures” on page 146](#). If a host structure is specified, the keyword ROW must be specified.

NULL

Specifies the new value for a column is the null value. NULL should only be specified for nullable columns.

DEFAULT

Specifies that the default value is assigned to a column. The value that is used depends on how the column was defined, as follows:

- If the column is defined as a generated column based on an expression, the column value will be generated by the database manager, based on the expression.
- If the column is a ROWID, identity column, row-begin column, row-end column, or transaction-start-ID column, the database manager will generate a new value.
- If the WITH DEFAULT clause is used, the default used is as defined for the column (see *default-clause* in *column-definition* in [“CREATE TABLE” on page 1105](#)).
- If the WITH DEFAULT clause or the NOT NULL clause is not used, the value used is NULL.
- If the column is defined as a row change timestamp column, a new row change timestamp value is assigned to the column.

If the NOT NULL clause is used and the WITH DEFAULT clause is not used, or if DEFAULT NULL is used, the DEFAULT keyword cannot be specified for that column.

DEFAULT must be specified for an identity column defined as GENERATED ALWAYS unless OVERRIDING SYSTEM VALUE is used.

The only value that a row-begin, row-end, transaction-start-ID, or generated expression column can be set to is DEFAULT.

row-fullselect

A fullselect that returns a single result row. The number of result columns in the select list must match the number of *column-names* (or if ROW is specified, the number of columns in the row) specified for assignment. The result column values are assigned to each corresponding *column-name*. If the result of the fullselect is no rows, then null values are assigned. An error is returned if there is more than one row in the result.

The *row-fullselect* may contain references to columns of the target table of the UPDATE statement. For each row updated, the value of such a column in the expression is the value of the column in the row before the row is updated.

WHERE

Specifies the rows to be updated. The clause can be omitted, or a *search-condition* or *cursor-name* can be specified. If the clause is omitted, all rows of the table or view are updated.

search-condition

Is any search described in [“Search conditions” on page 228](#). Each *column-name* in the search condition, other than in a subquery, must name a column of the table or view. When the search condition includes a subquery in which the same table is the base object of both the UPDATE and the subquery, the subquery is completely evaluated before any rows are updated.

The *search-condition* is applied to each row of the table or view. The updated rows are those for which the results of the *search-condition* are true.

If the *search-condition* contains a subquery, the subquery can be thought of as being executed each time the *search-condition* is applied to a row, and the results of that subquery used in applying the *search-condition*. In actuality, a subquery with no correlated references may be executed only once. A subquery with a correlated reference may have to be executed once for each row.

CURRENT OF *cursor-name*

Identifies the cursor to be used in the update operation. The *cursor-name* must identify a declared cursor as explained in [“DECLARE CURSOR” on page 1207](#).

The table or view named must also be named in the FROM clause of the SELECT statement of the cursor, and the result table of the cursor must not be read-only. For an explanation of read-only result tables, see [“DECLARE CURSOR” on page 1207](#).

The DECLARE CURSOR statement must not have a period-specification for the table or view used by the update statement.

When the UPDATE statement is executed, the cursor must be positioned on a row; that row is updated.

order-by-clause

Specifies the order of the rows for application of the *offset-clause* and *fetch-clause*. An *order-by-clause* should be specified to ensure a predictable order for determining the set of rows to be updated based on the *offset-clause* and *fetch-clause*.

sort-key-expression

An expression that specifies the value that is to be used to order the rows that qualify for the update operation. If a single *sort-key-expression* is identified, the rows are ordered by the values of that *sort-key-expression*. If more than one *sort-key-expression* is identified, the rows are ordered by the values of the first *sort-key-expression*, then by the values of the second *sort-key-expression*, and so on.

The result of the *sort-key-expression* must not be DATALINK or XML.

ASC

Uses the values of the *sort-key-expression* in ascending order. This is the default.

DESC

Uses the values of the *sort-key-expression* in descending order.

Ordering is performed in accordance with the comparison rules described in [Chapter 2, “Language elements,” on page 43](#). The null value is higher than all other values. If your ordering specification does not determine a complete ordering, rows with duplicate values of the last identified *sort-key-expression* have an arbitrary order. If you do not specify ORDER BY, the rows to be updated have an arbitrary order.

offset-clause

Limits the effect of the update by skipping a subset of the qualifying rows. For more information on the *offset-clause*, see [“offset-clause” on page 767](#).

fetch-clause

Limits the effect of the update to a subset of the qualifying rows. For more information on the *fetch-clause*, see [“fetch-clause” on page 768](#).

isolation-clause

Specifies the isolation level to be used for this statement.

WITH

Introduces the isolation level, which may be one of:

- *RR* Repeatable read
- *RS* Read stability
- *CS* Cursor stability
- *UR* Uncommitted read
- *NC* No commit

If *isolation-clause* is not specified the default isolation is used. See [“isolation-clause” on page 787](#) for a description of how the default is determined.

concurrent-access-resolution-clause

Specifies the concurrent access resolution to use for the select statement. For more information, see [“concurrent-access-resolution-clause” on page 789](#).

UPDATE Rules

Assignment: Update values are assigned to columns in accordance with the storage assignment rules described in [“Assignments and comparisons”](#) on page 91.

Validity: Updates must obey the following rules. If they do not, or if any other errors occur during the execution of the UPDATE statement, no rows are updated.

- *Fullselects:* The *row-fullselect* or *scalar-fullselect* shall return no more than one row (SQLSTATE 21000).
- *Unique constraints and unique indexes:* If the identified table, or the base table of the identified view, has one or more unique indexes or unique constraints, each row update in the table must conform to the limitations imposed by those indexes and constraints (SQLSTATE 23505).

All uniqueness checks are effectively made at the end of the statement. In the case of a multiple-row UPDATE statement of a column involved in a unique index or unique constraint, this would occur after all rows were updated.

- *Check constraints:* If the identified table, or the base table of the identified view, has one or more check constraints, each check constraint must be true or unknown for each row updated in the table (SQLSTATE 23513).

All check constraints are effectively validated at the end of the statement. In the case of a multiple-row UPDATE statement, this would occur after all rows were updated.

- *Views and the WITH CHECK OPTION:* If a view is identified, the updated rows must conform to any applicable WITH CHECK OPTION (SQLSTATE 44000). For more information, see [“CREATE VIEW”](#) on page 1198.

Triggers: If the identified table or the base table of the identified view has an update trigger, the trigger is activated. A trigger might cause other statements to be executed or raise error conditions based on the updated values.

Referential Integrity: The value of the parent key in a parent row must not be changed.

If the update values produce a foreign key that is nonnull, the foreign key must be equal to some value of the parent key of the parent table of the relationship.

The referential constraints (other than a referential constraint with a RESTRICT delete rule) are effectively checked at the end of the statement. In the case of a multiple-row UPDATE statement, this would occur after all rows were updated.

XML values: When an XML column is updated, the new value must be a well-formed XML document.

Updating rows in a table for which row or column access control is enforced: When an UPDATE statement is issued for a table for which row or column access control is enforced, the rules specified in the enabled row permissions or column masks determine whether the row can be updated. Typically those rules are based on the authorization ID of the statement. The following describes how enabled row permissions and column masks are used during UPDATE:

- Row permissions are used to identify the set of rows to be updated.

When multiple enabled row permissions are defined for a table, a row access control search condition is derived by application of the logical OR operator to the search condition in each enabled permission. This row access control search condition is applied to the table to determine which rows are accessible to the authorization ID of the UPDATE statement. If the WHERE clause is specified in the UPDATE statement, the user-specified predicates are applied on the accessible rows to determine the rows to be updated. If there is no WHERE clause, all the accessible rows are the rows to be updated.

- If there are rows to be updated, the following rules determine whether those rows can be updated:
 - When a column is referenced while deriving the values of a new row, if the column has an enabled column mask, the masked value is used to derive the new values. If the object table also has column access control activated, the column mask that is applied to derive the new values must return the column itself, not a constant or an expression. If the column mask does not mask the column to itself, the new value cannot be used for update and an error is returned.
 - If the rows are updatable, and there is a BEFORE UPDATE trigger for the table, the trigger is activated.

Within the trigger actions, the new values for update might be modified in transition variables. When the final values are returned from the trigger, the new values are used for the update.

- The rows that are to be updated must conform to the enabled row permissions:

For each row that is to be updated, the old values are replaced with the new values that were specified in the UPDATE statement. A row that conforms to the enabled row permissions is a row that, if updated, can be retrieved using the derived row access control search condition.

- If the rows are updatable, and there is an AFTER UPDATE trigger for the table, the trigger is activated.

Masked data can be assigned to a variable used as a value for the update operation. If an update violation check constraint does not exist for the column, the masked data will be updated into the column and no error will be issued.

Updating a partitioning key of a partitioned table: If a partitioning key of a row of a partitioned table is updated such that the row belongs in a different partition:

- The specified target table must not be an alias that references a single partition of the table.
- The specified target table must be journaled.

Extended indicator usage: When extended indicators are enabled, indicator values other than positive values and 0 (zero) through -7 must not be specified. The DEFAULT and UNASSIGNED extended indicator values must not appear in contexts in which they are not supported.

Extended indicators: In the *assignment-clause* of an UPDATE statement, an expression that is a reference to a single host variable can result in assigning an extended indicator value. Specifying an indicator value with the extended indicator value of UNASSIGNED has the same effect as if the column had not been specified in the *assignment-clause*. Assigning an extended indicator value of DEFAULT assigns the default value to the column, and must only be specified for a column that is defined with a default value.

If a target column is not updatable, for example an identity column defined as GENERATED ALWAYS, it must be assigned the extended indicator variable value of UNASSIGNED, unless it is a generated column defined as GENERATED ALWAYS. If the target column is a generated column defined as GENERATED ALWAYS, then it must be assigned the extended indicator variable value of DEFAULT or UNASSIGNED.

An UPDATE statement must not specify the extended indicator value of UNASSIGNED for all target columns.

Extended indicators and update triggers: If the indicator value for a target column is UNASSIGNED, that column is not considered to have been updated.

Extended indicators and deferred error checks: When extended indicators are enabled, validation that would otherwise be done during statement preparation to recognize an update of a non-updatable column is deferred until the statement is executed.

Considerations for a system-period temporal table: When a row of a system-period temporal table is updated, the database manager updates the values of the row-begin and transaction-start-ID columns as follows:

- A row-begin column is assigned a value that is generated using a reading of the time-of-day clock during execution of the first data change statement in the transaction that requires a value to be assigned to the row begin or transaction start-ID column in a table, or a row in a system-period temporal table is deleted. The database manager ensures uniqueness of the generated values for a row-begin column across transactions. The timestamp value might be adjusted to ensure that rows inserted into an associated history table have the end timestamp value greater than the begin timestamp value which can happen when a conflicting transaction is updating the same row in the system-period temporal table. The SYSTIME_PERIOD_ADJ QAQQINI option must be set to *ADJUST for this adjustment to the timestamp value to occur. If multiple rows are updated within a single SQL transaction and an adjustment is not needed, the values for the row-begin column are the same for all the rows and are unique from the values generated for the column for another transaction.
- A transaction start-ID column is assigned a unique timestamp value per transaction or the null value. The null value is assigned to the transaction start-ID column if the column is nullable and there is a row-

begin column in the table for which the value did not need to be adjusted. Otherwise, the value is generated using a reading of the time-of-day clock during execution of the first data change statement in the transaction that requires a value to be assigned to the row begin or transaction start-ID column in a table, or a row in a system-period temporal table is deleted. If multiple rows are updated within a single SQL transaction, the values for the transaction start-ID column are the same for all the rows and are unique from the values generated for the column for another transaction.

If the UPDATE statement has a search condition containing a correlated subquery that references historical rows (explicitly referencing the name of the history table name or implicitly through the use of a period specification in the FROM clause), the old version of the updated rows that are inserted as historical rows (into the history table if any) are potentially visible to update operations for the rows subsequently processed for the statement.

If the CURRENT TEMPORAL SYSTEM_TIME special register is set to a non-null value and the value of the SYSTIME option is YES, the underlying target (direct or indirect) of the UPDATE statement cannot be a system-period temporal table.

If the CURRENT TEMPORAL SYSTEM_TIME special register is set to a non-null value and the value of the SYSTIME option is YES, the target of an UPDATE statement cannot be a view defined with the WITH CHECK OPTION if the view definition includes a WHERE clause containing an invocation of an external routine with a data access indication other than NO SQL.

Considerations for a history table: When a row of a system-period temporal table is updated, a historical copy of the row is inserted into the corresponding history table and the end timestamp of the historical row is captured in the form of a system determined value that corresponds to the time of the data change operation. The database manager assigns the value that is generated using a reading of the time-of-day clock during execution of the first data change statement in the transaction that requires a value to be assigned to the row begin or transaction start-ID column in a table, or a row in a system-period temporal table is deleted. The database manager ensures uniqueness of the generated values for an end column in a history table across transactions. The timestamp value might be adjusted to ensure that rows inserted into the history table have the end timestamp value greater than the begin timestamp value which can happen when a conflicting transaction is updating the same row in the system-period temporal table. The SYSTIME_PERIOD_ADJ QAQQINI option must be set to *ADJUST for this adjustment to the timestamp value to occur. Otherwise, an error is returned.

For an update operation, the adjustment only affects the value for the end column corresponding to the row-end column in the history table associated with the system-period temporal table. Take these adjustments into consideration on subsequent references to the table whether there is a search for the transaction start time in the values for the columns corresponding to the row-begin and row-end columns of the period in the associated system-period temporal table.

Notes

Update operation errors: If an update value violates any constraints, or if any other error occurs during the execution of the UPDATE statement and COMMIT(*NONE) was not specified, all changes made during the execution of the statement are backed out. However, other changes in the unit of work made prior to the error are not backed out. If COMMIT(*NONE) is specified, changes are not backed out.

It is possible for an error to occur that makes the state of the cursor unpredictable.

Number of rows updated: When an UPDATE statement completes execution, the number of rows updated is returned in the ROW_COUNT statement information item in the SQL Diagnostics Area (and SQLERRD(3) in the SQLCA). For a description of the SQLCA, see [Appendix C, “SQLCA \(SQL communication area\),”](#) on page 1657.

For a description of ROW_COUNT, see [“GET DIAGNOSTICS”](#) on page 1324. For a description of the SQLCA, see [Appendix C, “SQLCA \(SQL communication area\),”](#) on page 1657.

Locking: Unless appropriate locks already exist, one or more exclusive locks are acquired by the execution of a successful UPDATE statement. Until these locks are released by a commit or rollback operation, the updated rows can only be accessed by:

- The application process that performed the update.

- Another application process using COMMIT(*NONE) or COMMIT(*CHG) through a read-only operation

The locks can prevent other application processes from performing operations on the table. For further information about locking, see the description of the COMMIT, ROLLBACK, and LOCK TABLE statements, and isolation levels in [“Isolation level” on page 23](#). Also, see the [Database Programming topic collection](#).

A maximum of 500 000 000 rows can be updated or changed in any single UPDATE statement when COMMIT(*RR), COMMIT(*ALL), COMMIT(*CS), or COMMIT(*CHG) has been specified. The number of rows changed includes any rows inserted, updated, or deleted under the same commitment definition as a result of a trigger.

REXX: Variables cannot be used in the UPDATE statement within a REXX procedure. Instead, the UPDATE must be the object of a PREPARE and EXECUTE using parameter markers.

Datalinks: If the URL value of a DATALINK column is updated, this is the same as deleting the old DATALINK value then inserting the new one. First, if the old value was linked to a file, that file is unlinked. Then, unless the linkage attributes of the DATALINK value are empty, the specified file is linked to that column.

The comment value of a DATALINK column can be updated without relinking the file by specifying an empty string as the URL path (for example, as the data-location argument of the DLVALUE scalar function or by specifying the new value to be the same as the old value). If a DATALINK column is updated with a null, it is the same as deleting the existing DATALINK value.

An error may occur when attempting to update a DATALINK value if the file server of either the existing value or the new value is no longer registered with the database server

Syntax alternatives: The following keywords are synonyms supported for compatibility to prior releases. These keywords are non-standard and should not be used:

- The keyword NONE can be used as a synonym for NC.
- The keyword CHG can be used as a synonym for UR.
- The keyword ALL can be used as a synonym for RS.

Examples

Example 1: Change the job (JOB) of employee number (EMPNO) '000290' in the EMPLOYEE table to 'LABORER'.

```
UPDATE EMPLOYEE
SET JOB = 'LABORER'
WHERE EMPNO = '000290'
```

Example 2: Increase the project staffing (PRSTAFF) by 1.5 for all projects that department (DEPTNO) 'D21' is responsible for in the PROJECT table.

```
UPDATE PROJECT
SET PRSTAFF = PRSTAFF + 1.5
WHERE DEPTNO = 'D21'
```

Example 3: All the employees except the manager of department (WORKDEPT) 'E21' have been temporarily reassigned. Indicate this by changing their job (JOB) to NULL and their pay (SALARY, BONUS, COMM) values to zero in the EMPLOYEE table.

```
UPDATE EMPLOYEE
SET JOB=NULL, SALARY=0, BONUS=0, COMM=0
WHERE WORKDEPT = 'E21' AND JOB <> 'MANAGER'
```

Example 4: In a Java program display the rows from the EMPLOYEE table on the connection context 'ctx' and then, if requested to do so, change the job (JOB) of certain employees to the new job keyed in (NEWJOB).

```
#sql iterator empIterator implements sqlj.runtime.ForUpdate
with( updateColumns='JOB' )
```

```

    ( ... );
empIterator C1;

#sql [ctx] C1 = { SELECT * FROM EMPLOYEE };

#sql { FETCH :C1 INTO ... };
while ( !C1.endFetch() ) {
    System.out.println( ... );

    ...
    if ( condition for updating row ) {
        #sql [ctx] { UPDATE EMPLOYEE
                    SET JOB = :NEWJOB
                    WHERE CURRENT OF :C1 };
    }

    #sql { FETCH :C1 INTO ... };
}
C1.close();

```

VALUES

The VALUES statement is a form of query. It can be embedded in an SQLJ application program or issued interactively.

For detailed information, see [“fullselect” on page 771](#).

VALUES INTO

The VALUES INTO statement produces a result table consisting of at most one row and assigns the values in that row to variables.

Invocation

This statement can be embedded in an application program. It is an executable statement that can be dynamically prepared, but cannot be issued interactively unless all variables being assigned are global variables. It must not be specified in REXX or Java.

Authorization

If a *row-fullselect* is specified, see [Chapter 6, “Queries,”](#) on page 723 for an explanation of the authorization required for each subselect.

If a global variable is specified on the right hand side of the assignment, the privileges held by the authorization ID of the statement must include at least one of the following:

- The WRITE privilege on the global variable.
- Database administrator authority

Syntax

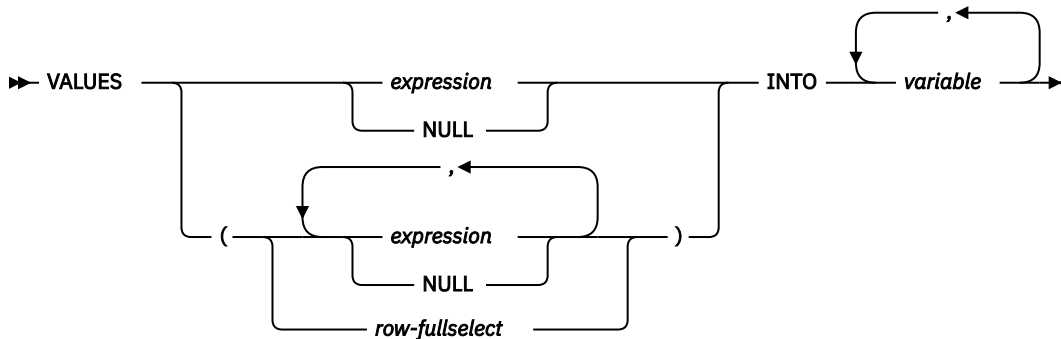

Description

VALUES

Introduces a single row consisting of one or more columns.

expression

Specifies the new value of the variable. The *expression* is any expression of the type described in [“Expressions”](#) on page 159. It must not include a column name. Host structures are not supported.

NULL

Specifies that the new value for the variable is the null value.

row-fullselect

A fullselect that returns a single result row. The result column values are assigned to each corresponding *variable*. If the result of the fullselect is no rows, then null values are assigned. An error is returned if there is more than one row in the result.

INTO *variable*,...

Identifies one or more host structures or variables that must be declared in the program in accordance with the rules for declaring host structures and variables. In the operational form of INTO, a reference to a host structure is replaced by a reference to each of its variables. The first value specified is assigned to the first variable, the second value to the second variable, and so on.

Notes

Variable assignment: Each assignment to a variable is performed according to the retrieval assignment rules described in “Assignments and comparisons” on page 91.¹²⁸ If the number of variables is less than the number of values in the row, an SQL warning (SQLSTATE 01503) is returned (and the SQLWARN3 field of the SQLCA is set to 'W'). Note that there is no warning if there are more variables than the number of result columns. If a value is null, an indicator variable must be provided for that value.

If the specified variable is character and is not large enough to contain the result, a warning (SQLSTATE 01004) is returned (and 'W' is assigned to SQLWARN1 in the SQLCA). The actual length of the result may be returned in the indicator variable associated with the variable, if an indicator variable is provided. For further information, see “Variables” on page 139.

If an assignment error occurs, the value is not assigned to the variable, and no more values are assigned to variables. Any values that have already been assigned to variables remain assigned.

If the specified variable is a C NUL-terminated host variable and is not large enough to contain the result and the NUL-terminator:

- If the *CNULRQD option is specified on the CRTSQLCI or CRTSQLCPPI command (or CNULRQD(*YES) on the SET OPTION statement), the following occurs:
 - The result is truncated.
 - The last character is the NUL-terminator.
 - The value 'W' is assigned to SQLWARN1 in the SQLCA.
- If the *NOCNULRQD option on the CRTSQLCI or CRTSQLCPPI command (or CNULRQD(*NO) on the SET OPTION statement) is specified, the following occurs:
 - The NUL-terminator is not returned.
 - The value 'N' is assigned to SQLWARN1 in the SQLCA.

Result column evaluation considerations: If an error occurs while evaluating a result column in the expression list of a VALUES INTO statement as the result of an arithmetic expression (such as division by zero, or overflow) or a numeric or character conversion error, the result is the null value. As in any other case of a null value, an indicator variable must be provided. The value of the variable is undefined. In this case, however, the indicator variable is set to the value of -2. Processing of the statement continues and a warning is returned. If an indicator variable is not provided, an error is returned and no more values are assigned to variables. It is possible that some values have already been assigned to variables and will remain assigned when the error is returned.

When a datetime value is returned, the length of the variable must be large enough to store the complete value. Otherwise, depending on how much of the value would have to be truncated, a warning or error is returned. See “Datetime assignments” on page 97 for details.

Multiple assignments: If more than one variable is specified in the INTO clause, all *expressions* are evaluated before the assignments are performed. Thus, references to a *variable* in an *expression* are always the value of the *variable* prior to any assignment in the VALUES INTO statement.

Examples

Example 1: Assign the value of the CURRENT PATH special register to host variable HV1.

```
EXEC SQL VALUES CURRENT PATH  
INTO :HV1;
```

Example 2: Assume that LOB locator LOB1 is associated with a CLOB value. Assign a portion of the CLOB value to host variable DETAILS using the LOB locator, and assign CURRENT TIMESTAMP to the host variable TIMETRACK.

¹²⁸ If assigning to an SQL-variable or SQL-parameter and the standards option is specified, storage assignment rules apply. For information about the standards option, see “Standards compliance” on page xix.

```
EXEC SQL VALUES (SUBSTR(:LOB1,1,35), CURRENT_TIMESTAMP)
INTO :DETAILS, :TIMETRACK;
```

WHENEVER

The WHENEVER statement specifies the action to be taken when a specified exception condition occurs.

Invocation

This statement can only be embedded in an application program. It is not an executable statement. It must not be specified in Java or REXX. See the [Embedded SQL Programming](#) topic collection for information about handling errors in REXX.

Authorization

None required.

Syntax

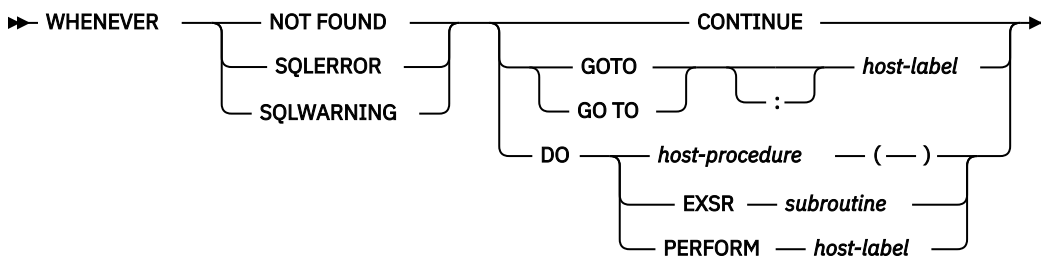

Description

The NOT FOUND, SQLERROR, or SQLWARNING clause is used to identify the type of exception condition.

NOT FOUND

Identifies any condition that results in an SQLSTATE of '02000' or an SQLCODE of +100.

SQLERROR

Identifies any condition that results in a negative SQLCODE'.

SQLWARNING

Identifies any condition that results in an SQLSTATE value where the first two characters are '01' or a warning condition (SQLWARN0 is 'W'), or that results in a positive SQLCODE other than +100.

The CONTINUE, GO TO, or DO clauses are used to specify the next statement to be executed when the identified type of exception condition exists.

CONTINUE

Specifies the next sequential instruction of the source program.

GOTO or GO TO *host-label*

Specifies the statement identified by *host-label*. For *host-label*, substitute a single token, optionally preceded by a colon. The form of the token depends on the host language. In a COBOL program, for example, it can be a *section-name* or an unqualified *paragraph-name*.

DO *host-procedure*

Indicates that a call should be made to a host language procedure. After the procedure has completed, execution will continue with the next sequential instruction of the program. This clause can only be used in C, C++, ILE COBOL, and ILE RPG. The rules for the target of the call depend upon the host language. No parameters may be passed on the call nor can any results be obtained from the call.

DO EXSR *subroutine*

Indicates that an RPG subroutine should be called with the RPG Invoke Subroutine (EXSR) operation. After the subroutine has completed, execution will continue with the next sequential instruction of the program. This clause can only be used in ILE RPG.

DO PERFORM *host-label*

Indicates that a COBOL procedure should be called with the COBOL PERFORM statement. After the procedure has completed, execution will continue with the next sequential instruction of the program. This clause can only be used in ILE COBOL. The *host-label* can be a section-name or an unqualified paragraph-name.

Notes

WHENEVER statement scope: Every executable SQL statement in a program is within the scope of one implicit or explicit WHENEVER statement of each type. The scope of a WHENEVER statement is related to the listing sequence of the statements in the program, not their execution sequence.

An SQL statement is within the scope of the last WHENEVER statement of each type that is specified before that SQL statement in the source program. If a WHENEVER statement of some type is not specified before an SQL statement, that SQL statement is within the scope of an implicit WHENEVER statement of that type in which CONTINUE is specified.

SQL does support nested programs in COBOL, C, and RPG. However, SQL does not honor normal COBOL, C, and RPG scoping rules. That is, the last WHENEVER statement specified in the program source prior to the nested procedure is still in effect for that nested program. The label referenced in the WHENEVER statement must be duplicated within that inner program. Alternatively, the inner program could specify a new WHENEVER statement.

For ILE RPG, the SQL TAG statement can be used to generate the *host-label* branch location for the GOTO. See [“TAG” on page 1545](#).

Examples

The following statements can be embedded in a COBOL program.

- *Example 1:* Go to the label HANDLER for any statement that produces an error.

```
EXEC SQL WHENEVER SQLERROR GOTO HANDLER END-EXEC.
```

- *Example 2:* Continue processing for any statement that produces a warning.

```
EXEC SQL WHENEVER SQLWARNING CONTINUE END-EXEC.
```

- *Example 3:* Go to the label ENDDATA for any statement that does not return data when expected to do so.

```
EXEC SQL WHENEVER NOT FOUND GOTO ENDDATA END-EXEC.
```

- *Example 4:* Call the program or procedure specified by the RPG prototype ERRORPROC for any statement that produces an error.

```
EXEC SQL WHENEVER SQLERROR DO ERRORPROC();
```

- *Example 5:* Call the program or procedure specified by the C prototype errorproc for any statement that produces an error.

```
EXEC SQL WHENEVER SQLERROR DO errorproc();
```

Chapter 8. SQL procedural language (SQL PL)

SQL can be used as a structured programming language to write the routine body for SQL functions, SQL procedures, SQL triggers, and compound (dynamic) statements. This is known as the SQL procedural language, also referred to as SQL PL.

SQL procedures and SQL functions are collectively referred to as SQL routines. SQL procedures are created by specifying an SQL routine body on the CREATE PROCEDURE statement. SQL functions are created by specifying an SQL routine body on the CREATE FUNCTION statement. SQL triggers are created by specifying an SQL routine body on the CREATE TRIGGER statement. A compound (dynamic) statement is defined by specifying an SQL routine body on the compound (dynamic) statement.

An SQL procedure can also be altered. The OR REPLACE option on the CREATE PROCEDURE or CREATE FUNCTION statement can be used to replace an SQL routine with a new version. You can also specify a new SQL routine body on the ALTER PROCEDURE statement or the ALTER FUNCTION statement.

An SQL routine body must be a single SQL statement which may be an SQL control statement.

The SQL routine body is the executable part of the procedure, function, or trigger that is transformed by the database manager into a program or service program. When an SQL routine, trigger, or global variable is created, SQL creates temporary source files (QTEMP/QSQLSRC and QTEMP/QSQLT00000) that will contain C source code with embedded SQL statements. When SQL creates these temporary source files, a record length of 160 is used and the CCSID value of the source statement is set as the CCSID value for the new file. If either of these source files exist, they will be modified if needed to have the same CCSID as the source. The record length of these source files should be 160 or unexpected results may occur. The name of the source file member is the same as the system name of the routine, trigger, or global variable. If DBGVIEW(*SOURCE) is specified, SQL creates the root source for the routine or trigger in source file QSQDSRC in the same library as the procedure, function, or trigger.

An SQL procedure is created as a program (*PGM) or service program (*SRVPGM) object using the CRTPGM or CRTSRVPGM command. An SQL function is created as a service program object. An SQL trigger is created as a program object. The program or service program is created in the library that is the implicit or explicit qualifier of the procedure, function, or trigger name.

When the program or service program is created, the SQL statements, including most control statements, become embedded SQL statements in the program or service program. The CALL, SIGNAL, RESIGNAL, and GET DIAGNOSTIC control statements also become embedded SQL statements in the program or service program.

The specified procedure or function is registered in the SYSROUTINES and SYSPARMS catalog tables, and an internal link is created from SYSROUTINES to the program. When the procedure is called using the SQL CALL statement or when the function is invoked in an SQL statement, the program associated with the routine is called. The specified SQL trigger is registered in the SYSTRIGGERS catalog table.

SQL control statements

Control statements are SQL statements that allow SQL to be used as a structured programming language. SQL control statements provide the capability to control the logic flow, declare and set variables, and handle warnings and exceptions. Some SQL control statements include other nested SQL statements.

SQL-control-statement

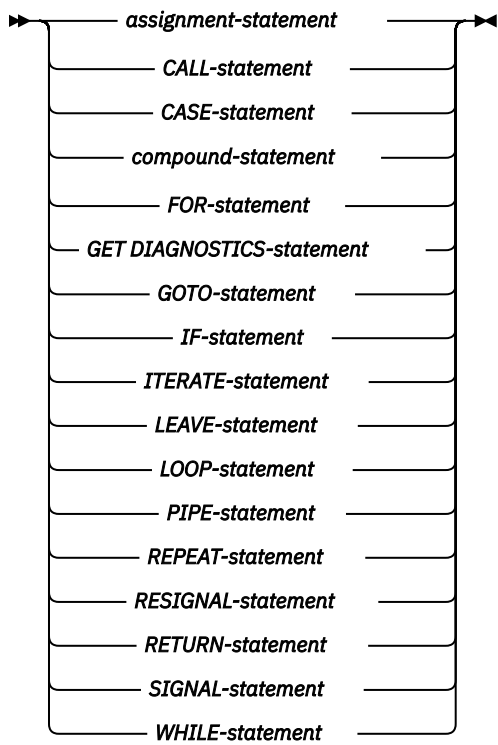

Control statements are supported in SQL procedures, SQL functions, SQL triggers, and compound (dynamic) statements.

References to SQL parameters and SQL variables

SQL parameters and SQL variables can be referenced anywhere in an SQL procedure statement where an expression or variable can be specified.

Host variables cannot be specified in SQL functions, SQL procedures, SQL triggers, or compound (dynamic) statements. SQL parameters can be referenced anywhere in the routine and can be qualified with the routine name. SQL variables can be referenced anywhere in the compound statement in which they are declared, including any statement that is directly or indirectly nested within that compound statement. If the compound statement where the variable is declared has a label, references to the variable name can be qualified with that label.

All SQL parameters and SQL variables are considered nullable except SQL variables that are explicitly declared as NOT NULL. The name of an SQL parameter or SQL variable in an SQL routine can be the same as the name of a column in a table or view referenced in the routine. The name of an SQL variable can also be the same as the name of another SQL variable declared in the same routine. This can occur when the two SQL variables are declared in different *compound-statements*. The *compound-statement* that contains the declaration of an SQL variable determines the scope of that variable. See [“compound-statement”](#) on page 1588, for more information.

Names that are the same should be explicitly qualified. Qualifying a name clearly indicates whether the name refers to a column, global variable, SQL variable, or SQL parameter. If the name is not qualified, or qualified but still ambiguous, the following rules describe how the name is resolved. The name is resolved by checking for a match in the following order:

- If the tables and views specified in an SQL routine body exist at the time the routine is created, the name will first be checked as a column name.
- If not found as a column, it will then be checked as an SQL variable name. The SQL variable can be declared within the *compound-statement* that contains the reference, or within a compound statement in which that compound statement is nested. If two SQL variables are within the same scope and have the same name,¹²⁹ the SQL variable that is declared in the innermost compound statement is used.
- If not found as an SQL variable name, the name will be checked as an SQL parameter name.

If the name is still not resolved as a column, SQL variable, or SQL parameter and the scope of the name included a table or view that does not exist at the current server, it will be assumed to be a column or global variable. If all the tables and views exist at the current server, it will be assumed to be a global variable. If the SQL_GVAR_BUILD_RULE QAQQINI option is *EXIST and the global variable does not exist, an error will be issued.

The name of an SQL variable or SQL parameter in an SQL routine can be the same as the name of an identifier used in certain SQL statements. If the name is not qualified, the following rules describe whether the name refers to the identifier or to the SQL parameter or SQL variable. Qualified SQL parameters and SQL variables are not supported for these names.

- In the SET PATH and SET SCHEMA statements, the name is checked as an SQL parameter name or SQL variable name. If not found as an SQL variable or SQL parameter name, it will then be used as an identifier.
- In the CONNECT, DISCONNECT, RELEASE, and SET CONNECTION statements, the name is used as an identifier.
- In the CALL statement, the name is used as an identifier.
- In the ASSOCIATE LOCATORS and DESCRIBE PROCEDURE statements when used in a CREATE TRIGGER statement, the name is used as an identifier.

¹²⁹ Which can happen if they are declared in different compound statements.

References to SQL condition names

The name of an SQL condition can be the same as the name of another SQL condition declared in the same routine. This can occur when the two SQL conditions are declared in different *compound-statements*.

The *compound-statement* that contains the declaration of an SQL condition name determines the scope of that condition name. A condition name must be unique within the compound statement in which it is declared, excluding any declarations in compound statements that are nested within that compound statement. A condition name can only be referenced within the compound statement in which it is declared, including any compound statements that are nested within that compound statement. When there is a reference to a condition name, the condition that is declared in the innermost compound statement is the condition that is used. See [“compound-statement” on page 1588](#), for more information.

References to SQL cursor names

The name of an SQL cursor can be the same as the name of another SQL cursor declared in the same routine. This can occur when the two SQL cursors are declared in different *compound-statements*. The cursor name specified in a FOR statement can be the same as the name of another SQL cursor declared in the same *compound-statement*.

The *compound-statement* that contains the declaration of an SQL cursor determines the scope of that cursor name. A cursor name must be unique within the compound statement in which it is declared, excluding any declarations in compound statements that are nested within that compound statement. A cursor name can only be referenced within the compound statement in which it is declared, including any compound statements that are nested within that compound statement. When there is a reference to a cursor name, the cursor that is declared in the innermost compound statement is the cursor that is used. See [“compound-statement” on page 1588](#), for more information.

References to SQL labels

Labels can be specified at the beginning of most SQL procedure statements. If a label is specified on an SQL procedure statement, it must be unique from other labels within the same scope. A label must not be the same as any other label within the same compound statement, must not be the same as a label specified on the compound statement itself, and if the compound statement is nested within another compound statement, the label must not be the same as the label specified on any higher level compound statement. The label must not be the same as the name of the SQL function, SQL procedure, or SQL trigger that contains the SQL procedure statement.

Specifying a label for an SQL procedure statement defines that label and determines the scope of that label. A label name can only be referenced within the compound statement in which it is defined, including any statement that is directly or indirectly nested within that compound statement. A label can be specified as the target of a GOTO, LEAVE, or ITERATE statement, subject to the rules for the statement that references the label as a target.

Summary of 'name' scoping in nested compound statements

Nested compound statements can be used within an SQL routine to define the scope of SQL variable declarations, cursors, condition names, and condition handlers.

Additionally, labels have a defined scope in the context of nested compound statements. However the rules for name space, and how non-unique names can be referenced, differs depending on the type of name. The following table summarizes these differences.

Table 120. Summary of 'Name' Scoping in Nested Compound Statements

Type of name	Must be unique within...	Qualification allowed?	Can be referenced within...
SQL variable	the compound statement in which it is declared, excluding any declarations in compound statements that are nested within that compound statement.	Yes, can be qualified with the label of the compound statement in which the variable was declared.	the compound statement in which it is declared, including any compound statements that are nested within that compound statement. When multiple SQL variables are defined with the same name you can use a label to explicitly refer to a specific variable that is not the most local in scope.
condition	the compound statement in which it is declared, excluding any declarations in compound statements that are nested within that compound statement.	No	the compound statement in which it is declared, including any compound statements that are nested within that compound statement. Can be used in the declaration of a condition handler, or in a SIGNAL or RESIGNAL statement. Note: When multiple conditions are defined with the same name there is no way to explicitly refer to the condition that is not the most local in scope.
cursor	the compound statement in which it is declared, excluding any declarations in compound statements that are nested within that compound statement.	No	the compound statement in which it is declared, including any compound statements that are nested within that compound statement. Note: When multiple cursors are defined with the same name there is no way to explicitly refer to the cursor that is not the most local in scope. However, if the cursor is defined as a result set cursor (for example, the WITH RETURN clause was specified as part of the cursor declaration), the invoking application can access the result set.
label	the compound statement that declared the variable, including any declarations in compound statements that are nested within that compound statement.	No	the compound statement in which it is declared, including any compound statements that are nested within that compound statement. Use a label to qualify the name of an SQL variable or as the target of a GOTO, LEAVE, or ITERATE statement.

SQL-procedure-statement

An SQL control statement may allow multiple SQL statements to be specified within the SQL control statement. These statements are defined as SQL procedure statements.

Syntax

<i>SQL-control-statement</i>	
<i>ALLOCATE CURSOR-statement</i>	
<i>ALLOCATE DESCRIPTOR-statement</i>	
<i>ALTER FUNCTION-statement</i>	(2)
<i>ALTER MASK-statement</i>	
<i>ALTER PERMISSION-statement</i>	
<i>ALTER PROCEDURE-statement</i>	(2)
<i>ALTER SEQUENCE-statement</i>	
<i>ALTER TABLE-statement</i>	
<i>ALTER TRIGGER-statement</i>	
<i>ASSOCIATE LOCATORS-statement</i>	
<i>CLOSE-statement</i>	
<i>COMMENT-statement</i>	
<i>COMMIT-statement</i>	(1)
<i>CONNECT-statement</i>	(1)
<i>CREATE ALIAS-statement</i>	
<i>CREATE FUNCTION (external scalar)-statement</i>	
<i>CREATE FUNCTION (external table)-statement</i>	
<i>CREATE FUNCTION (sourced)-statement</i>	
<i>CREATE INDEX-statement</i>	
<i>CREATE MASK-statement</i>	
<i>CREATE PERMISSION-statement</i>	
<i>CREATE PROCEDURE (external)-statement</i>	
<i>CREATE SCHEMA-statement</i>	
<i>CREATE SEQUENCE-statement</i>	
<i>CREATE TABLE-statement</i>	
<i>CREATE TYPE-statement</i>	
<i>CREATE VIEW-statement</i>	
<i>DEALLOCATE DESCRIPTOR-statement</i>	
<i>DECLARE GLOBAL TEMPORARY TABLE-statement</i>	
<i>DELETE-statement</i>	
<i>DESCRIBE-statement</i>	
<i>DESCRIBE CURSOR-statement</i>	
<i>DESCRIBE INPUT-statement</i>	
<i>DESCRIBE PROCEDURE-statement</i>	
<i>DESCRIBE TABLE-statement</i>	
<i>DISCONNECT-statement</i>	(1)
<i>DROP-statement</i>	

Syntax (continued)

<i>EXECUTE-statement</i>	
<i>EXECUTE IMMEDIATE-statement</i>	
<i>FETCH-statement</i>	
<i>GET DESCRIPTOR-statement</i>	
<i>GRANT-statement</i>	
<i>INCLUDE-statement</i>	
<i>INSERT-statement</i>	
<i>LABEL-statement</i>	
<i>LOCK TABLE-statement</i>	
<i>MERGE-statement</i>	
<i>OPEN-statement</i>	
<i>PREPARE-statement</i>	
<i>REFRESH TABLE-statement</i>	
<i>RELEASE-statement</i>	
<i>RELEASE SAVEPOINT-statement</i>	
<i>RENAME-statement</i>	
<i>REVOKE-statement</i>	
<i>ROLLBACK-statement</i>	(1)
<i>SAVEPOINT-statement</i>	
<i>SELECT INTO-statement</i>	
<i>SET CONNECTION-statement</i>	(1)
<i>SET CURRENT DEBUG MODE-statement</i>	
<i>SET CURRENT DECFLOAT ROUNDING MODE-statement</i>	
<i>SET CURRENT DEGREE-statement</i>	
<i>SET CURRENT IMPLICIT XMLPARSE OPTION-statement</i>	
<i>SET CURRENT TEMPORAL SYSTEM_TIME-statement</i>	
<i>SET DESCRIPTOR-statement</i>	
<i>SET ENCRYPTION PASSWORD-statement</i>	
<i>SET PATH-statement</i>	
<i>SET RESULT SETS-statement</i>	(1)
<i>SET SCHEMA-statement</i>	
<i>SET TRANSACTION-statement</i>	(3)
<i>SET transition-variable-statement</i>	(4)
<i>TRANSFER OWNERSHIP-statement</i>	
<i>TRUNCATE-statement</i>	
<i>UPDATE-statement</i>	
<i>VALUES INTO-statement</i>	

Notes:

1. A COMMIT, ROLLBACK, CONNECT, DISCONNECT, SET CONNECTION, or SET RESULT SETS statement is only allowed in an SQL procedure.

2. An ALTER PROCEDURE (SQL), ALTER FUNCTION (SQL scalar), or ALTER FUNCTION (SQL table) statement with a REPLACE keyword is not allowed in an *SQL-routine-body*.
3. A SET TRANSACTION statement is only allowed in an SQL function or trigger.
4. A *SET transition-variable-statement* is only allowed in a trigger. A *fullselect* and *VALUES-statement* can also be specified in a trigger.

Notes

Comments: Comments can be included within the body of an SQL procedure. In addition to the double-dash form of comments (--), a comment can begin with /* and end with */. The following rules apply to this form of a comment.

- The beginning characters /* must be adjacent and on the same line.
- The ending characters */ must be adjacent and on the same line.
- Comments can be started wherever a space is valid.
- Comments can be continued to the next line.

Detecting and processing error and warning conditions: As an SQL statement is executed, the database manager stores information about the processing of the statement in a diagnostics area (including the SQLSTATE and SQLCODE), unless otherwise noted in the description of the SQL statement. A completion condition indicates the SQL statement completed successfully, completed with a warning condition, or completed with a not found condition. An exception condition indicates that the SQL statement was not successful.

A condition handler can be defined in a compound statement to execute when an exception condition, a warning condition, or a not found condition occurs. The declaration of a condition handler includes the code that is to be executed when the condition handler is activated. When a condition other than a successful completion occurs in the processing of *SQL-procedure-statement*, if a condition handler that could handle the condition is within scope, one such condition handler will be activated to process the condition. See “[compound-statement](#)” on [page 1588](#) for information about defining condition handlers. The code in the condition handler can check for a warning condition, not found condition, or exception condition and take the appropriate action. Use one of the following methods at the beginning of the body of a condition handler to check the condition in the diagnostics area that caused the handler to be activated:

- Issue a GET DIAGNOSTICS statement to request the condition information. See “[GET DIAGNOSTICS statement](#)” on [page 1598](#).
- Test the SQL variables SQLSTATE and SQLCODE.

If the condition is a warning and there is not a handler for the condition, the above two methods can also be used outside of the body of a condition handler immediately following the statement for which the condition is wanted. If the condition is an error and there is not a handler for the condition, the routine or trigger terminates with the error condition.

assignment-statement

The *assignment-statement* assigns a value to an SQL parameter, an SQL variable, or a *transition-variable*.

Syntax

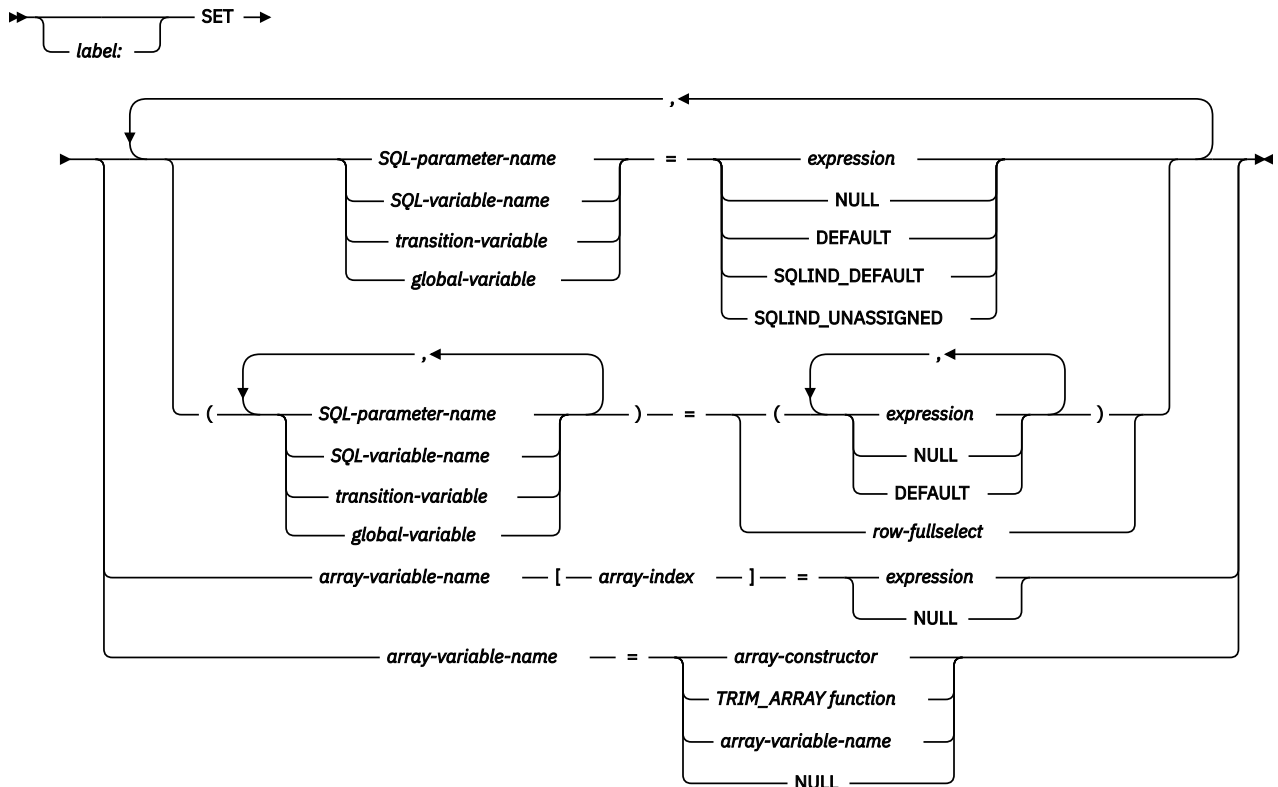

row-fullselect

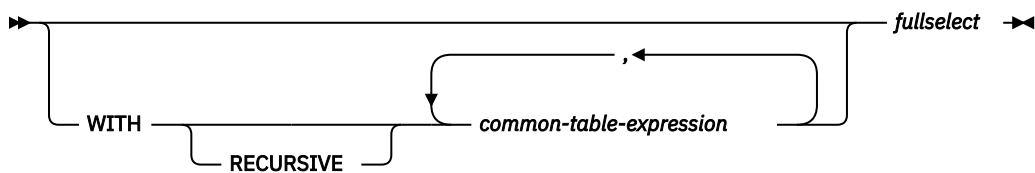

Description

label

Specifies the label for the *assignment-statement* statement. The label name cannot be the same as the routine name or another label within the same scope. For more information, see [“References to SQL labels”](#) on page 1574.

SQL-parameter-name

Identifies the SQL parameter that is the assignment target. The SQL parameter must be specified in *parameter-declaration* in the CREATE PROCEDURE or CREATE FUNCTION statement.

SQL-variable-name

Identifies the SQL variable that is the assignment target. SQL variables can only be declared in a *compound-statement* and must be declared before they are used.

transition-variable

Identifies the column to be updated in the new row. A *transition-variable* must identify a column in the subject table of a trigger, optionally qualified by a correlation name that identifies the new value. An

OLD *transition-variable* must not be identified. A *transition-variable* can only be modified in a BEFORE trigger.

A *transition-variable* must not be identified more than once in the same *assignment-statement*.

Values are assigned to *transition-variables* according to the storage assignment rules. For more information see [“Assignments and comparisons”](#) on page 91.

global-variable

Identifies the global variable that is the assignment target.

expression

Specifies the expression or value that is the source for the assignment.

An *expression* may contain references to OLD and NEW *transition-variables*. If the CREATE TRIGGER statement contains both OLD and NEW clauses, references to *transition-variables* must be qualified by the *correlation-name*.

NULL

Specifies the null value. For *transition-variables*, NULL can only be specified for nullable columns.

DEFAULT

Specifies that the default value will be used. DEFAULT can only be specified for a global variable and in SQL triggers for transition variables. DEFAULT is not allowed for a *transition-variable* associated with a GENERATED column. Only one global variable can be assigned in the SET statement when DEFAULT is used.

SQLIND_DEFAULT

Specifies that the indicator associated with this variable is assigned the extended indicator value of DEFAULT. The target of the assignment must be an SQL variable or an SQL parameter. An error is returned if the variable does not allow a null value. Only one variable can be assigned in the SET statement when SQLIND_DEFAULT is used.

SQLIND_UNASSIGNED

Specifies that the indicator associated with this variable is assigned the extended indicator value of UNASSIGNED. The target of the assignment must be an SQL variable or an SQL parameter. An error is returned if the variable does not allow a null value. Only one variable can be assigned in the SET statement when SQLIND_UNASSIGNED is used.

row-fullselect

A fullselect that returns a single result row. The result column values are assigned to the corresponding variable or parameter. If the result of the fullselect is no rows, then null values are assigned. An error is returned if there is more than one row in the result.

WITH *common-table-expression*

Specifies a common table expression. For an explanation of common table expression, see [“common-table-expression”](#) on page 778.

fullselect

A *fullselect* that returns a single result row. The result column values are assigned to each corresponding variable. If the result of the *fullselect* is no rows, then null values are assigned. An error is returned if there is more than one row in the result.

array-variable-name

Identifies an SQL variable or parameter. The variable or parameter must be of an array type.

[*array-index*]

Numeric expression that specifies which element in the array will be the target of the assignment. The array index must be of an exact numeric type with zero scale; it cannot be null. Its value must be between 1 and the maximum cardinality defined for the array.

array-constructor

Specifies the value of an array constructor. See [“ARRAY constructor”](#) on page 173.

TRIM_ARRAY function

Specifies the TRIM_ARRAY scalar function. See [“TRIM_ARRAY”](#) on page 606.

Notes

Assignment rules: Assignments in the assignment statement must conform to the SQL retrieval assignment rules as described in [“Assignments and comparisons”](#) on page 91.¹³⁰

If the assignment is of the form `SET A[idx] = rhs`, where *A* is an array variable name, *idx* is an expression used as the array index, and *rhs* is an expression of a compatible type as the array element, then:

1. If array *A* is the null value, set *A* to the empty array.
2. Let *C* be the cardinality of array *A*.
3. If *idx* is less than or equal to *C*, the value in the position identified by *idx* is replaced by the value of *rhs*.
4. If *idx* is greater than *C*, then:
 - a. The value in position *i*, for *i* greater than *C* and less than *idx*, is set to the null value.
 - b. The value in position *idx* is set to the value of *rhs*.
 - c. The cardinality of *A* is set to *idx*.

Assignments involving SQL parameters: An IN parameter can appear on the left or right side of an *assignment-statement*. When control returns to the caller, the original value of the IN parameter is retained. An OUT parameter can also appear on the left or right side of an *assignment-statement*. If used without first being assigned a value, the value is null. When control returns to the caller, the last value that is assigned to an OUT parameter is returned to the caller. For an INOUT parameter, the first value of the parameter is determined by the caller, and the last value that is assigned to the parameter is returned to the caller.

Multiple SQL parameter or SQL variable assignments: If more than one variable is specified as the target of the *assignment-statement*, the targets of the *assignment-statement* are completely evaluated before the assignments are performed. Thus, a reference to a variable in a target expression is always the value of the variable prior to any assignment.

Extended indicator values: For the extended indicator values of SQLIND_DEFAULT and SQLIND_UNASSIGNED to be recognized, the SQL routine or SQL trigger must be created with the SET OPTION EXTIND = *YES. For more information about extended indicator values, see [“References to host variables”](#) on page 140.

Arrays: If an assignment is to an array or array element, only one assignment is allowed in the statement.

Special Registers: If a variable has been declared with an identifier that matches the name of a special register (such as PATH), then the variable must be delimited to distinguish it from assignment to the special register (for example, SET "PATH" = 1; for a variable called PATH declared as an integer).

Considerations for SQLSTATE and SQLCODE variables: Assignment to these variables is not prohibited; however, it is not recommended as assignment does not affect the diagnostics area or result in the activation of condition handlers. The SQLCODE and SQLSTATE will be reset and the diagnostics area or SQLCA initialized for each *assignment-statement* other than *assignment-statements* that:

- assign the SQLSTATE or SQLCODE variable to another variable or
- set a constant value into the SQLSTATE or SQLCODE variable.

Examples

Example 1: Increase the SQL variable `p_salary` by 10 percent.

```
SET p_salary = p_salary + (p_salary * .10)
```

Example 2: Set SQL variable `p_salary` to the null value

¹³⁰ If assigning to an SQL-variable or SQL-parameter and the standards option is specified, storage assignment rules apply. For information about the standards option, see [“Standards compliance”](#) on page xix.

```
SET p_salary = NULL
```

Example 3: Set the SQL array variable `p_phonenumbers` to an array of fixed numbers.

```
SET p_phonenumbers = ARRAY[9055553907, 4165554213, 4085553678]
```

Example 4: Set the SQL array variable `p_phonenumbers` to an array of numbers retrieved from the `PHONENUMBER` table.

```
SET p_phonenumbers = ARRAY  
  [SELECT NUMBER FROM PHONENUMBERS  
   WHERE EMPID = 624]
```

Example 5: Assign `p_mynumber` to the first and tenth elements of the SQL array variable `p_phonenumbers`. After the first assignment, the cardinality of `p_phonenumbers` is 1. After the second assignment, the cardinality is 10, and elements 2 to 9 have been implicitly assigned the null value.

```
SET p_phonenumbers[1] = p_mynumber  
SET p_phonenumbers[10] = p_mynumber
```

Example 6: Ensure that the salary column is never greater than 50000. If the new value is greater than 50000, set it to 50000.

```
CREATE TRIGGER LIMIT_SALARY  
  BEFORE INSERT ON EMPLOYEE  
  REFERENCING NEW AS NEW_VAR  
  FOR EACH ROW MODE DB2SQL  
  WHEN (NEW_VAR.SALARY > 50000)  
  BEGIN ATOMIC  
    SET NEW_VAR.SALARY = 50000;  
  END
```

Example 7: When the job title is updated, increase the salary based on the new job title. Assign the years in the position to 0.

```
CREATE TRIGGER SET_SALARY  
  BEFORE UPDATE OF JOB ON STAFF  
  REFERENCING OLD AS OLD_VAR  
  NEW AS NEW_VAR  
  FOR EACH ROW MODE DB2SQL  
  BEGIN ATOMIC  
    SET (NEW_VAR.SALARY, NEW_VAR.YEARS) =  
      (OLD_VAR.SALARY * CASE NEW_VAR.JOB  
       WHEN 'Sales' THEN 1.1  
       WHEN 'Mgr' THEN 1.05  
       ELSE 1 END ,0);  
  END
```

CALL statement

The CALL statement invokes a procedure. The syntax of CALL in an SQL function, SQL procedure, or SQL trigger is a subset of what is supported as a CALL statement in other contexts.

See “CALL” on page 920 for details.

Syntax

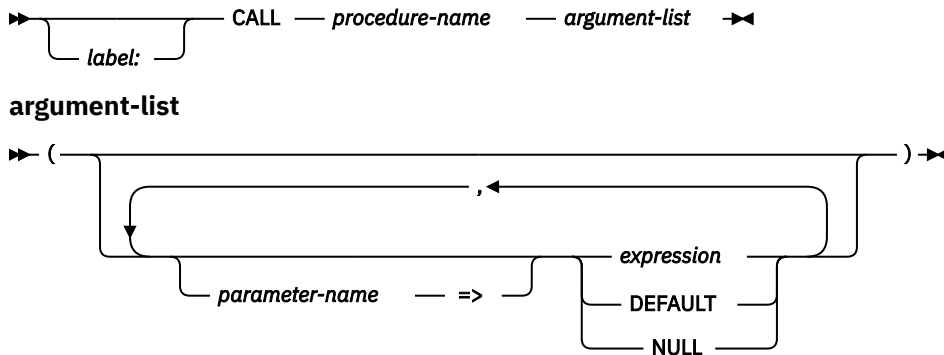

Description

label

Specifies the label for the CALL statement. The label name cannot be the same as the routine name or another label within the same scope. For more information, see “References to SQL labels” on page 1574.

procedure-name

Identifies the procedure to call. The *procedure-name* must identify a procedure that exists at the current server.

argument-list

Identifies a list of values to be passed as parameters to the procedure. The *n*th unnamed argument corresponds to the *n*th parameter in the procedure.

Each parameter defined (using CREATE PROCEDURE) as OUT must be specified as either a *SQL-variable-name* or a *SQL-parameter-name*. A default cannot be specified for an OUT parameter. If a default is used for an INOUT parameter, then the default expression is used to initialize the parameter for input to the procedure. No value is returned for this parameter when the procedure exits.

When a procedure is called, arguments must be specified for all parameters that are not defined to have a default value. When an argument is assigned to a parameter using the named syntax, then all the arguments that follow it must also be assigned using the named syntax.

Any references to date, time, or timestamp special register values in the argument list will use one clock reading for any default expressions and a separate clock reading for any references in the explicit arguments.

The number of arguments specified must be the same as the number of parameters of a procedure defined at the current server with the specified *procedure-name*.

The application requester assumes all parameters that are variables are INOUT parameters. All parameters that are not variables are assumed to be input parameters. The actual attributes of the parameters are determined by the current server.

parameter-name

Name of the parameter to which the argument value is assigned. The name must match a parameter name defined for the procedure. Named arguments correspond to the same named

parameter regardless of the order in which they are specified in the argument list. When an argument is assigned to a parameter by name, all the arguments that follow it must also be assigned by name.

A named argument must be specified only one time (implicitly or explicitly).

Named arguments are not allowed on a call to a procedure that was not defined using a CREATE PROCEDURE statement.

expression

An *expression* of the type described in [“Expressions” on page 159](#), that does not include an aggregate function or column name.

DEFAULT

Specifies the default as defined in the CREATE PROCEDURE statement is used as an argument to the procedure; otherwise the NULL value is used.

NULL

Specifies a null value as an argument to the procedure.

Notes

Rules for arguments to OUT and INOUT parameters: Each OUT or INOUT parameter must be specified as an SQL parameter or SQL variable.

Special registers: The initial value of a special register in a procedure is inherited from the caller of the procedure. A value assigned to a special register within the procedure is used for the entire SQL procedure and will be inherited by any procedure subsequently called from that procedure. When a procedure returns to its caller, the special registers are restored to the original values of the caller.

Related information: See [“CALL” on page 920](#) for more information.

Example

Call procedure *proc1* and pass SQL variables as parameters.

```
CALL proc1(v_empno, v_salary)
```

CASE statement

The CASE statement selects an execution path based on multiple conditions.

Syntax

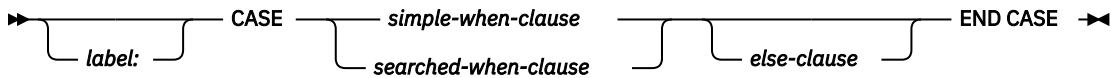

simple-when-clause

expression →

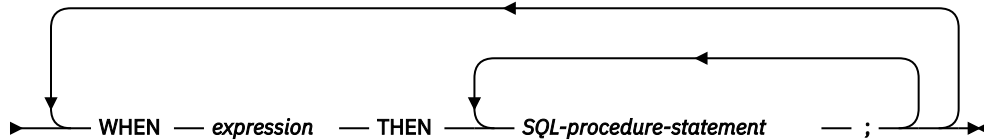

searched-when-clause

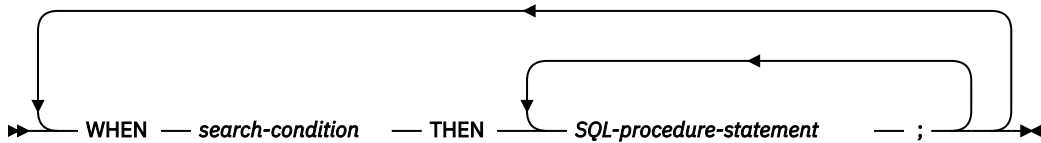

else-clause

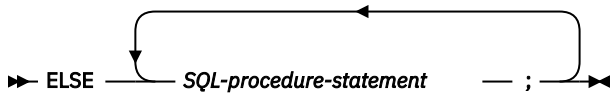

Description

label

Specifies the label for the CASE statement. The label name cannot be the same as the routine name or another label within the same scope. For more information, see [“References to SQL labels”](#) on page 1574.

simple-when-clause

The value of the *expression* prior to the first WHEN keyword is tested for equality with the value of each *expression* that follows the WHEN keyword. If the comparison is true, the statements in the associated THEN clause are executed and processing of the CASE statement ends. If the result is unknown or false, processing continues to the next comparison. If the result does not match any of the comparisons, and an ELSE clause is present, the statements in the ELSE clause are executed.

searched-when-clause

The *search-condition* following the WHEN keyword is evaluated. If it evaluates to true, the statements in the associated THEN clause are executed and processing of the CASE statement ends. If it evaluates to false, or unknown, the next *search-condition* is evaluated. If no *search-condition* evaluates to true and an ELSE clause is present, the statements in the ELSE clause are executed.

else-clause

If none of the conditions specified in the *simple-when-clause* or *searched-when-clause* are true, then the statements in the *else-clause* are executed.

If none of the conditions specified in the WHEN are true, and an ELSE clause is not specified, an error is issued at runtime, and the execution of the CASE statement is terminated (SQLSTATE 20000).

SQL-procedure-statement

Specifies a statement to execute. See [“SQL-procedure-statement”](#) on page 1576.

Notes

Nesting of CASE statements: CASE statements that use a *simple-when-clause* can be nested up to three levels. CASE statements that use a *searched-when-clause* have no limit to the number of nesting levels.

Considerations for SQLSTATE and SQLCODE variables: When the first *SQL-procedure-statement* in the CASE statement is executed, the SQLSTATE and SQLCODE SQL variables reflect the result of evaluating the *expressions* or *search-conditions* of that CASE statement. If a CASE statement does not include an ELSE clause and none of the *search-conditions* evaluate to true, then any error returned from the *expression* is returned.

Examples

Example 1: Depending on the value of SQL variable v_workdept, update column DEPTNAME in table DEPARTMENT with the appropriate name.

The following example shows how to do this using the syntax for a *simple-when-clause*.

```
CASE v_workdept
  WHEN 'A00'
    THEN UPDATE department SET
           deptname = 'DATA ACCESS 1';
  WHEN 'B01'
    THEN UPDATE department SET
           deptname = 'DATA ACCESS 2';
  ELSE UPDATE department SET
           deptname = 'DATA ACCESS 3';
END CASE
```

Example 2: The following example shows how to do this using the syntax for a *searched-when-clause*:

```
CASE
  WHEN v_workdept = 'A00'
    THEN UPDATE department SET
           deptname = 'DATA ACCESS 1';
  WHEN v_workdept = 'B01'
    THEN UPDATE department SET
           deptname = 'DATA ACCESS 2';
  ELSE UPDATE department SET
           deptname = 'DATA ACCESS 3';
END CASE
```

compound-statement

A compound statement groups other statements together in an SQL procedure. A compound statement allows the declaration of SQL variables, cursors, and condition handlers.

Syntax

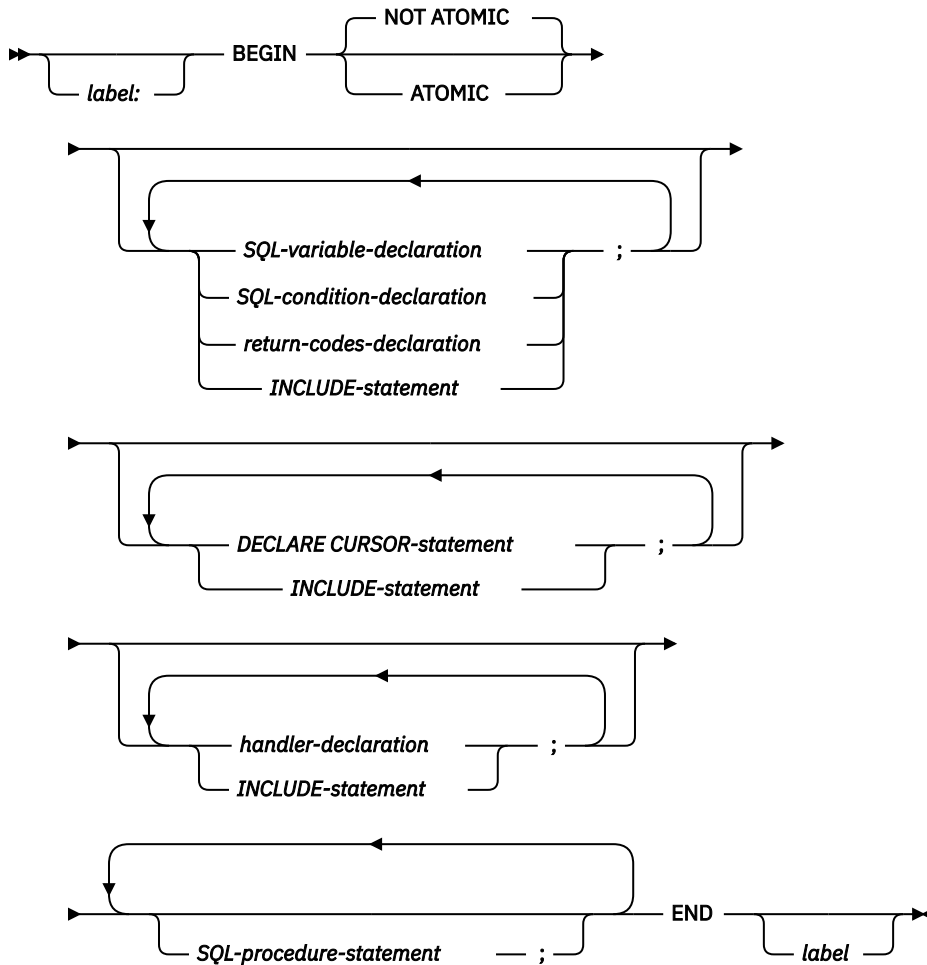

SQL-variable-declaration

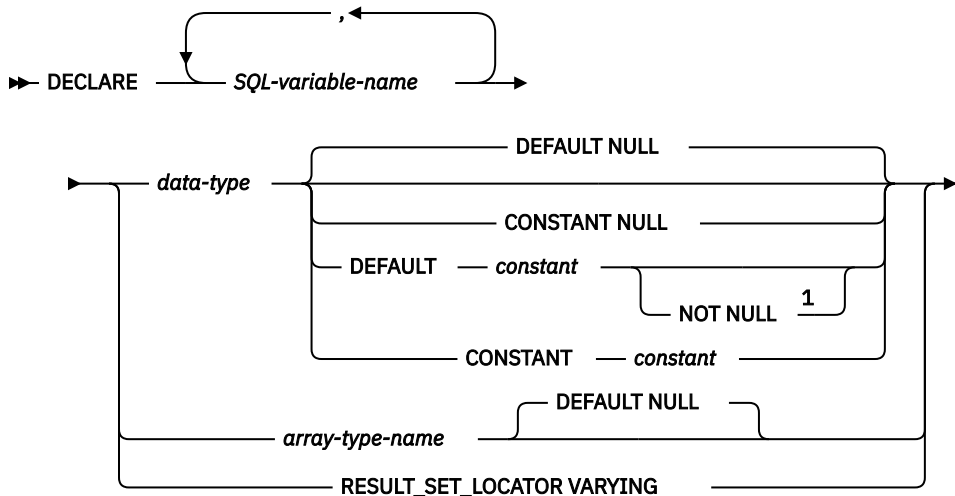

SQL-condition-declaration

➤ DECLARE — *SQL-condition-name* — CONDITION →

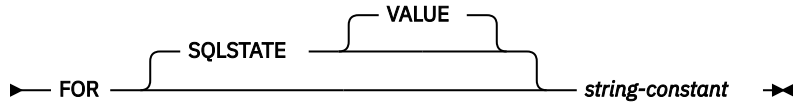

return-codes-declaration

➤ DECLARE →

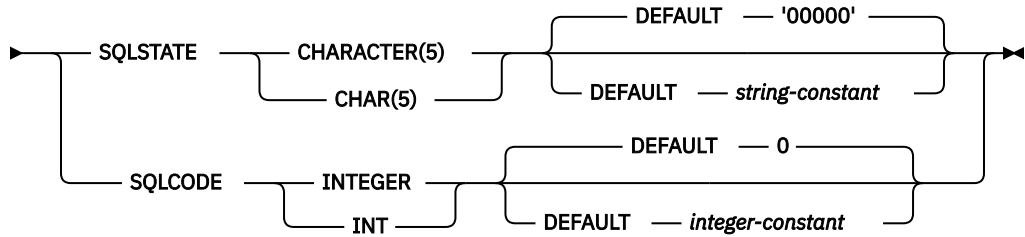

handler-declaration



specific-condition-value

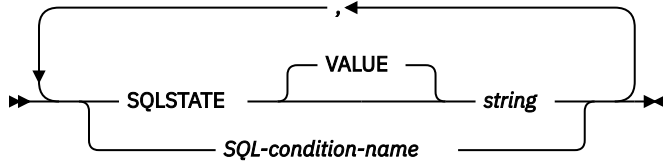

general-condition-value

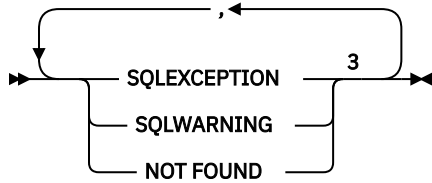

data-type

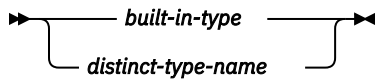

Notes:

- ¹ The DEFAULT and NOT NULL clauses can be specified in either order.
- ² *specific-condition-value* and *general-condition-value* cannot be specified in the same handler declaration.
- ³ The same clause must not be specified more than once.

built-in-type

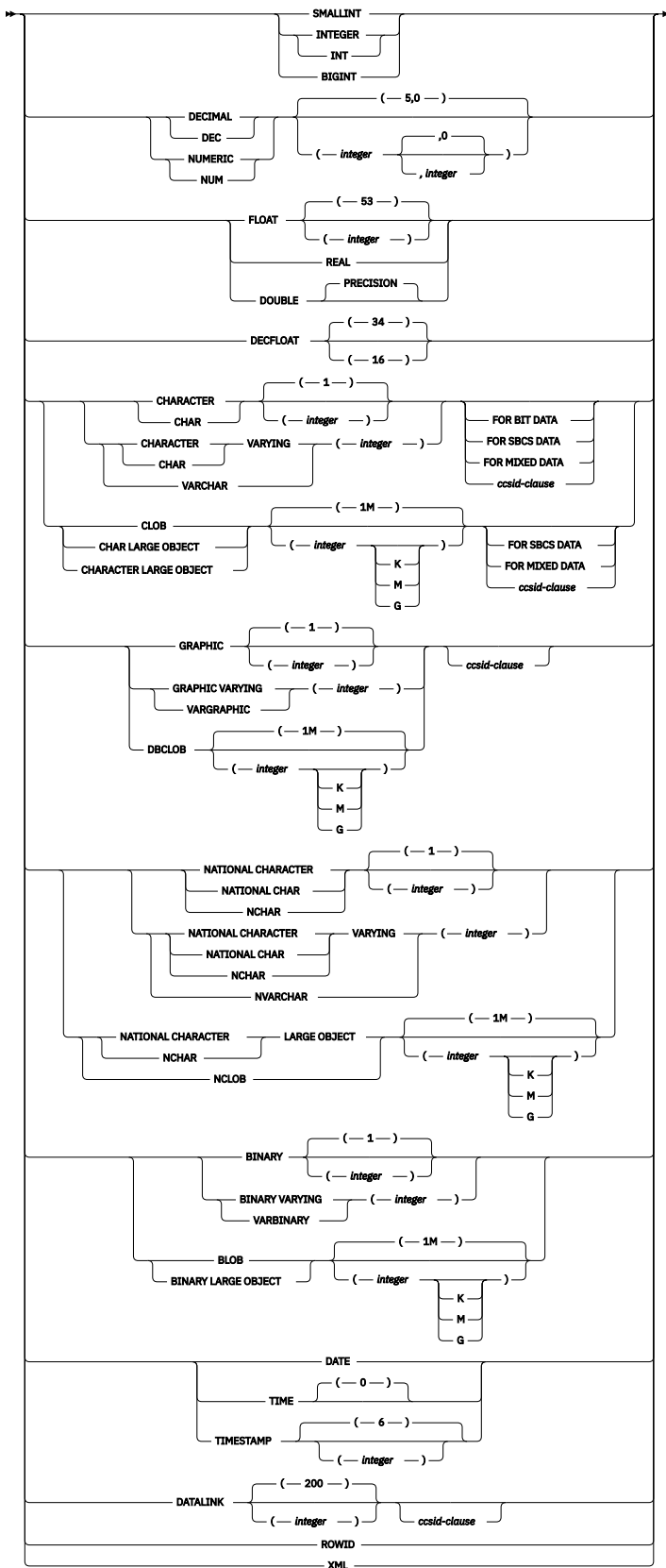

ccsid-clause

➤ CCSID — integer ➤

Description

label

Specifies the label for the *compound-statement*. If the ending label is specified, it must be the same as the beginning label. The label name cannot be the same as the routine name or another label within the same scope. For more information, see [“References to SQL labels”](#) on page 1574.

ATOMIC

ATOMIC indicates that an unhandled exception condition within the *compound-statement* causes the *compound-statement* to be rolled back. If ATOMIC is specified, COMMIT or ROLLBACK statements cannot be specified in the compound statement (ROLLBACK TO SAVEPOINT may be specified).

NOT ATOMIC

NOT ATOMIC indicates that an unhandled exception condition within the *compound-statement* does not cause the *compound-statement* to be rolled back. If NOT ATOMIC is specified in the outermost compound statement of an SQL trigger, it is treated as ATOMIC.

If ATOMIC is specified in an SQL procedure or function, the routine must have a data classification of MODIFIES SQL DATA.

SQL-variable-declaration

Declares a variable that is local to the *compound-statement*.

SQL-variable-name

Defines the name of a local SQL variable. The database manager converts all un delimited SQL variable names to uppercase. The name must not be the same as another SQL variable within the same *compound-statement*, excluding any declarations in *compound-statements* nested within the *compound-statement*. Do not name SQL variables the same as column names or parameter names. See [“References to SQL parameters and SQL variables”](#) on page 1571 for how SQL variable names are resolved when there are columns with the same name involved in a statement. Variable names should not begin with 'SQL'.

data-type

Specifies the data type of the variable. See [“CREATE TABLE”](#) on page 1105 for a description of data type.

If the *data-type* is a graphic string data type, consider specifying CCSID 1200 or 13488 to indicate UTF-16 or UCS-2 data. If a CCSID is not specified, the CCSID of the graphic string variable will be the associated DBCS CCSID for the job.

array-type-name

Specifies that the SQL variable is an array as defined with the CREATE TYPE (Array) statement.

DEFAULT constant or NULL

Defines the default for the SQL variable. The specified constant must represent a value that could be assigned to the variable in accordance with the rules of assignment as described in [“Assignments and comparisons”](#) on page 91. The variable is initialized when the *compound-statement* in which it is declared is entered. If a default value is not specified, the SQL variable is initialized to NULL. SQL variables of type XML cannot have a default value specified. SQL variables of *array-type* are always initialized to NULL.

NOT NULL

Prevents the SQL variable from containing the NULL value. Omission of NOT NULL implies that the variable can be null. SQL variables of type XML cannot have NOT NULL specified.

CONSTANT constant or NULL

Specifies that the SQL variable has a fixed value that cannot be changed. An SQL variable that is defined using CONSTANT cannot be used as the target of any assignment operation. The specified constant must represent a value that could be assigned to the variable in accordance with the rules of assignment as described in [“Assignments and comparisons”](#) on page 91.

RESULT_SET_LOCATOR VARYING

Specifies the data type for a result set locator variable.

SQL-condition-declaration

Declares a condition name and corresponding SQLSTATE value.

SQL-condition-name

Specifies the name of the condition. The condition name must be unique within the *compound-statement* (excluding any declarations in *compound-statements* nested within the *compound-statement*) in which it is declared.

FOR SQLSTATE string-constant

Specifies the SQLSTATE associated with this condition. The string constant must be specified as 5 characters. The SQLSTATE class (the first 2 characters) must not be '00'.

return-codes-declaration

Declares special SQL variables called SQLSTATE and SQLCODE that are set for the first condition in the diagnostics area after executing an SQL statement other than GET DIAGNOSTICS or an empty *compound-statement*. The SQLSTATE and SQLCODE variables can only be declared in the outermost *compound-statement* of an SQL procedure, SQL function, or SQL trigger.

The SQLSTATE and SQLCODE special variables are only intended to be used as a means of obtaining the SQL return codes that resulted from processing the previous SQL statement other than GET DIAGNOSTICS. If there is any intention to use the SQLSTATE and SQLCODE values, save the values immediately to other SQL variables to avoid having the values replaced by the SQL return codes returned after executing the next SQL statement. If a handler is defined that handles an SQLSTATE, you can use an assignment statement to save that SQLSTATE (or the associated SQLCODE) value in another SQL variable, if the assignment is the first statement in the handler.

Assignment to these variables is not prohibited; however, it is not recommended. Assignment to these special variables is ignored by condition handlers. The SQLSTATE and SQLCODE special variables cannot be set to NULL.

DECLARE CURSOR-statement

Declares a cursor in the routine body. The cursor name must be unique within the *compound-statement*, excluding any declarations in *compound-statements* nested within the *compound-statement*.

A *cursor-name* can only be referenced within the *compound-statement* in which it is declared, including any *compound-statements* nested within the *compound-statement*.

Use an OPEN statement to open the cursor, and a FETCH statement to read rows using the cursor. If the cursor in an SQL procedure and is intended for use as a result set:

- specify WITH RETURN when declaring the cursor
- create the procedure using the DYNAMIC RESULT SETS clause with a non-zero value
- do not specify a CLOSE statement in the *compound-statement*.

Any open cursor that does not meet these criteria is closed at the end of the *compound-statement*.

For more information about declaring a cursor, refer to [“DECLARE CURSOR” on page 1207](#).

handler-declaration

Specifies a *handler*, an *SQL-procedure-statement* to execute when an exception or completion condition occurs in the *compound-statement*.

A condition handler declaration cannot reference the same condition value or SQLSTATE value more than once, and cannot reference an SQLSTATE value and a condition name that represent the same SQLSTATE value. For a list of SQLSTATE values as well as more information, see the [SQL messages and codes](#) topic collection.

Furthermore, when two or more condition handlers are declared in a compound statement, no two condition handler declarations may specify the same:

- general condition category or
- specific condition, either as an SQLSTATE value or as a condition name that represents the same value.

A condition handler is active for the set of *SQL-procedure-statements* that follow the *handler-declarations* within the *compound-statement* in which it is declared, including any nested compound statements.

A handler for a condition may exist at several levels of nested compound statements. For example, assume that compound statement *n1* contains another compound statement *n2* which contains another compound statement *n3*. When an exception condition occurs within *n3*, any active handlers within *n3* are first allowed to handle the condition. If no appropriate handler exists in *n3*, then the condition is resignalled to *n2* and the active handlers within *n2* may handle the condition. If no appropriate handler exists in *n2*, then the condition is resignalled to *n1* and the active handlers within *n1* may handle the condition. If no appropriate handler exists in *n1*, the condition is considered unhandled.

There are three types of condition handlers:

CONTINUE

Specifies that after the condition handler is activated and completes successfully, control is returned to the SQL statement following the one that raised the exception. If the error occurs while executing a comparison as in an IF, CASE, FOR, WHILE, or REPEAT, control returns to the statement following the corresponding END IF, END CASE, END FOR, END WHILE, or END REPEAT.

EXIT

Specifies that after the condition handler is activated and completes successfully, control is returned to the end of the compound statement that declared the condition handler.

UNDO

Specifies that when the condition handler is activated changes made by the *compound-statement* are rolled back. When the handler completes successfully, control is returned to the end of the *compound-statement*. If UNDO is specified, then ATOMIC must be specified.

UNDO cannot be specified in the outermost *compound-statement* of an SQL function or SQL trigger.

The conditions under which the handler is activated are:

SQLSTATE string

Specifies that the handler is invoked when the specific SQLSTATE occurs. The SQLSTATE class (the first 2 characters) must not be '00'.

SQL-condition-name

Specifies that the handler is invoked when the specific SQLSTATE associated with the condition name occurs. The *SQL-condition-name* must be previously defined in a *SQL-condition-declaration*.

SQLEXCEPTION

Specifies that the handler is invoked when an exception condition occurs. An exception condition is represented by an SQLSTATE value where the first two characters are not '00', '01', or '02'.

SQLWARNING

Specifies that the handler is invoked when a warning condition occurs. A warning condition is represented by an SQLSTATE value where the first two characters are '01'.

NOT FOUND

Specifies that the handler is invoked when a NOT FOUND condition occurs. A NOT FOUND condition is represented by an SQLSTATE value where the first two characters are '02'.

Notes

Nesting compound statements: Compound statements can be nested. Nested compound statements can be used to scope variable definitions, condition names, condition handlers, and cursors to a subset of the statements in the *compound-statement*. This can simplify the processing done for each SQL procedure statement. Support for nested compound statements enables the use of a compound statement within the declaration of a condition handler.

Condition handlers: Condition handlers in a *compound-statement* are similar to WHENEVER statements used in external SQL application programs. A condition handler can be defined to automatically get

control when an exception, warning, or not found condition occurs. The body of a condition handler contains code that is executed when the condition handler is activated. A condition handler can be activated as a result of an exception, warning, or not found condition that is returned by the database manager for the processing of an SQL statement, or the activating condition can be the result of a SIGNAL or RESIGNAL statement issued within the procedure body.

A condition handler is declared within a compound statement, and it is active for the set of *SQL-procedure-statements* that follow all of the condition handler declarations within the compound statement in which the condition handler is declared. To be more specific, the scope of a condition handler declaration H is the list of *SQL-procedure-statements* that follows the condition handler declarations contained within the compound statement in which H appears. This means that the scope of H does not include the statements contained in the body of the condition handler H, implying that a condition handler cannot handle conditions that arise inside its own body. Similarly, for any two condition handlers H1 and H2 declared in the same compound statement, H1 will not handle conditions arising in the body of H2, and H2 will not handle conditions arising in the body of H1.

The declaration of a condition handler specifies the condition that activates it, the type of the condition handler (CONTINUE, EXIT, or UNDO), and the handler action. The type of the condition handler determines where control is returned to after successful completion of the handler action.

Condition handler activation: When a condition other than successful completion occurs in the processing of an *SQL-procedure-statement*, if a condition handler that could handle the condition is within scope, one such condition handler will be activated to process the condition.

In a routine with nested compound statements, condition handlers that could handle a specific condition may exist at several levels of the nested compound statements. The condition handler that is activated is a condition handler that is declared innermost to the scope in which the condition was encountered. If more than one condition handler at that nesting level could handle the condition, the condition handler that is activated is the most appropriate handler declared in that compound statement.

The most appropriate handler is a handler that is defined in the *compound-statement* which most closely matches the SQLSTATE of the exception or completion condition.

For example, if the innermost compound statement declares a specific handler for SQLSTATE 22001 as well as a handler for SQLEXCEPTION, the specific handler for SQLSTATE 22001 is the most appropriate handler when an SQLSTATE 22001 is encountered. In this case, the specific handler is activated.

When a condition handler is activated, the condition handler action is executed. If the handler action completes successfully or with an unhandled warning, the diagnostics area is cleared, and the type of the condition handler (CONTINUE, EXIT, or UNDO handler) determines where control is returned. Additionally, the SQLSTATE and SQLCODE SQL variables are cleared when a handler completes successfully or with an unhandled warning.

If the handler action does not complete successfully, and an appropriate handler exists for the condition encountered in the handler action, that condition handler is activated. Otherwise, the condition encountered within the condition handler is unhandled.

Unhandled conditions: If a condition is encountered and an appropriate handler does not exist for that condition, the condition is unhandled.

- If the unhandled condition is an exception, the SQL procedure, SQL function, or SQL trigger containing the failing statement is terminated with an unhandled exception condition.
- If the unhandled condition is a warning or not found condition, processing continues with the next statement. Note that the processing of the next SQL statement will cause information about the unhandled condition in the diagnostics area to be overwritten, and evidence of the unhandled condition will no longer exist.

Considerations for using SIGNAL or RESIGNAL statements with nested compound statements: If an *SQL-procedure-statement* specified in the condition handler is either a SIGNAL or RESIGNAL statement with an exception SQLSTATE, the compound statement terminates with the specified exception. This happens even if this condition handler or another condition handler in the same compound statement specifies CONTINUE, since these condition handlers are not in the scope of this exception. If the compound statement is nested in another compound statement, condition handlers in the higher level

compound statement may handle the exception because those condition handlers are within the scope of the exception.

Null values in SQL parameters and SQL variables: If the value of an SQL parameter or SQL variable is null and it is used in an SQL statement (such as CONNECT or DESCRIBE) that does not allow an indicator variable, an error is returned.

Effect on open cursors: Upon exit from the *compound-statement* for any reason, all open cursors that are declared in that compound statement are closed, unless they are declared to return result sets or unless *ENDACTGRP is specified.

Considerations for SQLSTATE and SQLCODE SQL variables: The compound statement itself does not affect the SQLSTATE and SQLCODE SQL variables. However, SQL statements contained within the compound statement can affect the SQLSTATE and SQLCODE SQL variables. At the end of the compound statement the SQLSTATE and SQLCODE SQL variables reflect the result of the last SQL statement executed within that compound statement that caused a change to the SQLSTATE and SQLCODE SQL variables. If the SQLSTATE and SQLCODE variables were not changed within the compound statement, they contain the same values as when the compound statement was entered.

Examples

Create a procedure body with a compound statement that performs the following actions.

1. Declares SQL variables.
2. Declares a cursor to return the salary of employees in a department determined by an IN parameter.
3. Declares an EXIT handler for the condition NOT FOUND (end of file) which assigns the value 6666 to the OUT parameter medianSalary.
4. Select the number of employees in the given department into the SQL variable v_numRecords.
5. Fetch rows from the cursor in a WHILE loop until 50% + 1 of the employees have been retrieved.
6. Return the median salary.

```
CREATE PROCEDURE DEPT_MEDIAN
(IN deptNumber SMALLINT,
 OUT medianSalary DOUBLE)
LANGUAGE SQL
BEGIN
  DECLARE v_numRecords INTEGER DEFAULT 1;
  DECLARE v_counter INTEGER DEFAULT 0;
  DECLARE c1 CURSOR FOR
    SELECT salary FROM staff
      WHERE DEPT = deptNumber
      ORDER BY salary;
  DECLARE EXIT HANDLER FOR NOT FOUND
    SET medianSalary = 6666;
    /* initialize OUT parameter */
    SET medianSalary = 0;
  SELECT COUNT(*) INTO v_numRecords FROM staff
    WHERE DEPT = deptNumber;
  OPEN c1;
  WHILE v_counter < (v_numRecords / 2 + 1) DO
    FETCH c1 INTO medianSalary;
    SET v_counter = v_counter + 1;
  END WHILE;
  CLOSE c1;
END
```

FOR statement

The FOR statement executes a statement or group of statements for each row of a table.

Syntax

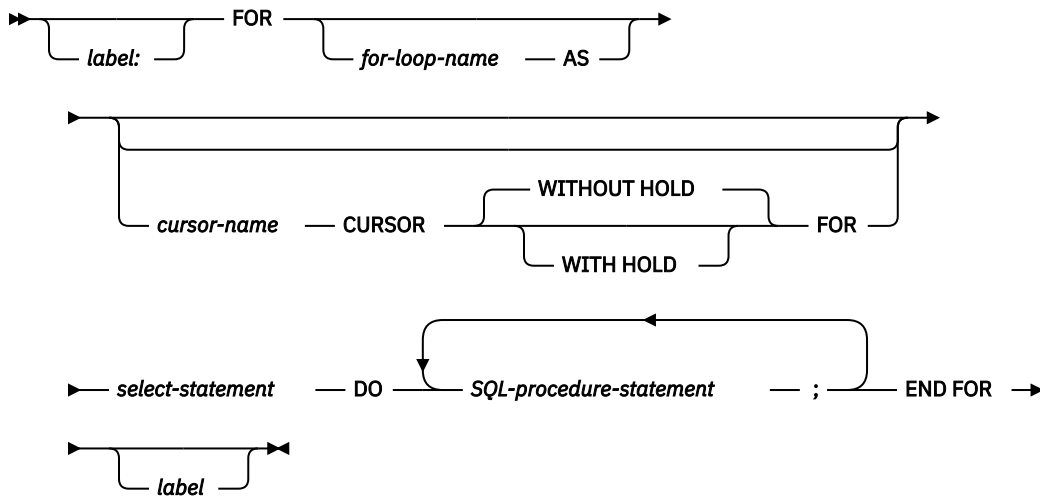

Description

label

Specifies the label for the FOR statement. If the ending label is specified, it must be the same as the beginning label. The label name cannot be the same as the routine name or another label within the same scope. For more information, see [“References to SQL labels”](#) on page 1574.

for-loop-name

Specifies the label for the implicit *compound-statement* that is generated to implement the FOR statement. It follows the rules for the label of a *compound-statement* except that it cannot be used with an ITERATE, GOTO, or LEAVE statement within the FOR statement. The *for-loop-name* is used to qualify the column names returned by the specified *select-statement*. It must not be the same as any label within the same scope. For more information, see [“References to SQL labels”](#) on page 1574.

Either the *for-loop-name* or *label* can be used to qualify other SQL variable names in the statement.

If *for-loop-name* is specified, then it should be used to qualify any other SQL variable names in the statement when debugging the SQL function, SQL procedure, or SQL trigger.

cursor-name

Names a cursor.

WITH HOLD

Prevents the cursor from being closed as a consequence of a commit operation. A cursor declared using the WITH HOLD clause is implicitly closed at commit time only if the connection associated with the cursor is ended during the commit operation. For more information, see [“DECLARE CURSOR”](#) on page 1207.

select-statement

Specifies the select statement of the cursor.

Each expression in the select list must have a name. If an expression is not a simple column name, the AS clause must be used to name the expression. If the AS clause is specified, that name is used for the variable and must be unique.

SQL-procedure-statement

Specifies the SQL statements to be executed for each row of the result table of the cursor. The SQL statements should not include an OPEN, FETCH, or CLOSE specifying the cursor name of the FOR statement.

Notes

FOR statement rules: The FOR statement executes one or multiple statements for each row in a result table of the cursor. The cursor is defined by specifying a select list that describes the columns and rows selected. The statements within the FOR statement are executed for each row selected.

The select list must consist of unique column names and the objects referenced in the *select-statement* must exist when the function, procedure, or trigger is created.

The cursor specified in a FOR statement cannot be referenced outside the FOR statement and cannot be specified on an OPEN, FETCH, or CLOSE statement.

Handler warning: Handlers may be used to handle errors that might occur on the open of the cursor or fetch of a row using the cursor in the FOR statement. Handlers defined to handle these open or fetch conditions should not be CONTINUE handlers as they may cause the FOR statement to loop indefinitely.

Example

In this example, the FOR statement is used to specify a cursor that selects 3 columns from the employee table. For every row selected, SQL variable *fullname* is set to the last name followed by a comma, the first name, a blank, and the middle initial. Each value for *fullname* is inserted into table TNAMES.

```
BEGIN
  DECLARE fullname CHAR(40);
  FOR v1 AS
    c1 CURSOR FOR
      SELECT firstnme, midinit, lastname FROM employee
    DO
      SET fullname =
        lastname || ', ' || firstnme || ' ' || midinit;
      INSERT INTO TNAMES VALUES ( fullname );
    END FOR;
END;
```

GET DIAGNOSTICS statement

The GET DIAGNOSTICS statement obtains information about the previous SQL statement that was executed. The syntax of GET DIAGNOSTICS in an SQL function, SQL procedure, or SQL trigger is a subset of what is supported as a GET DIAGNOSTICS statement in other contexts.

See “GET DIAGNOSTICS” on page 1324 for details.

Syntax

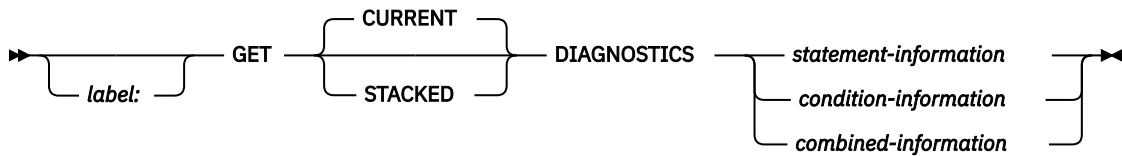

statement-information

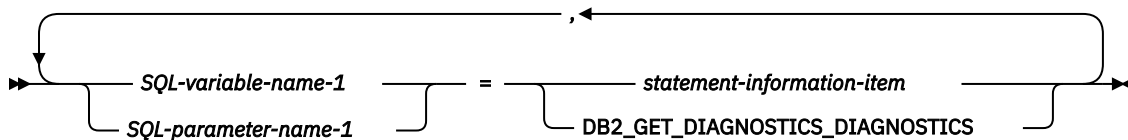

condition-information

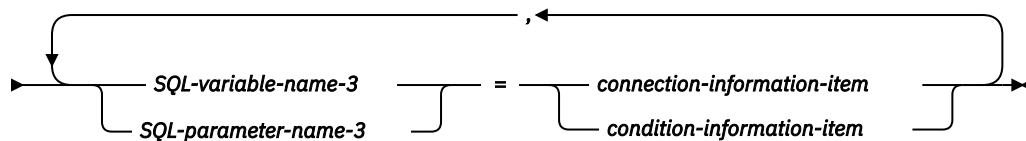
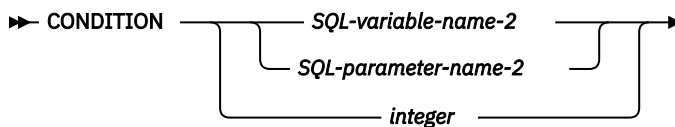

combined-information

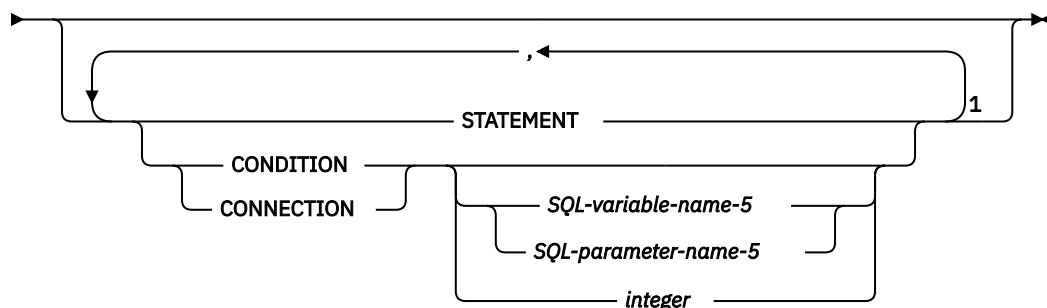
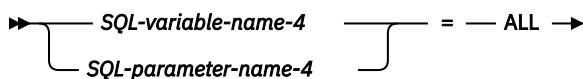

Notes:

¹ STATEMENT can only be specified once. If *SQL-variable-name-5*, *SQL-parameter-name-5*, or *integer* is not specified, CONDITION and CONNECTION can only be specified once.

statement-information-item

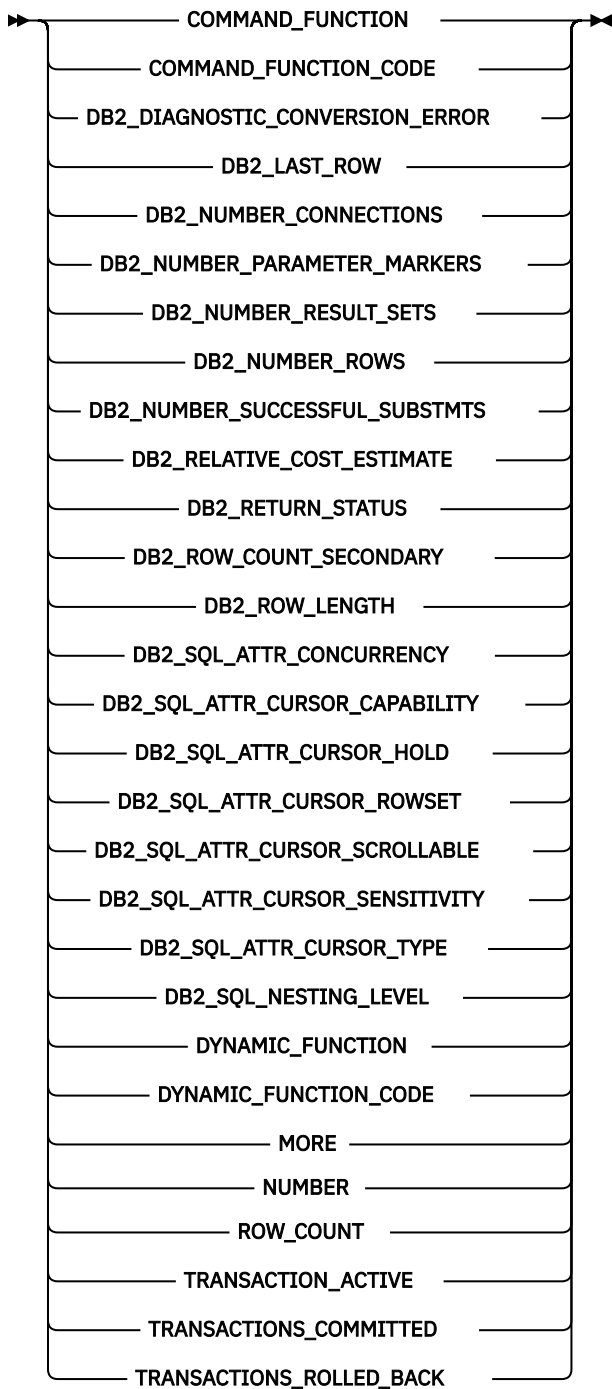

connection-information-item

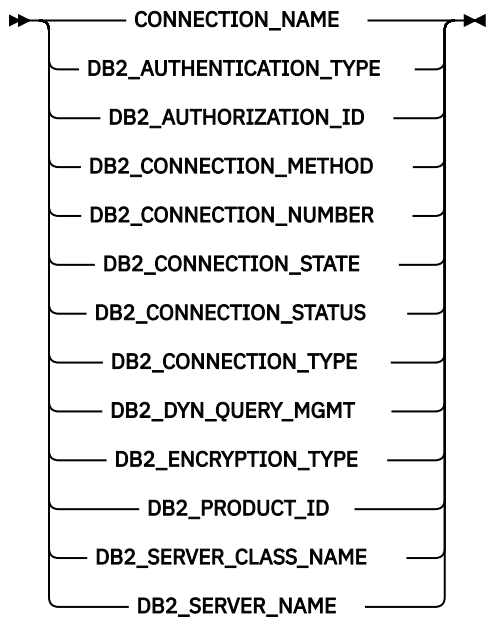

condition-information-item

CATALOG_NAME
CLASS_ORIGIN
COLUMN_NAME
CONDITION_IDENTIFIER
CONDITION_NUMBER
CONSTRAINT_CATALOG
CONSTRAINT_NAME
CONSTRAINT_SCHEMA
CURSOR_NAME
DB2_ERROR_CODE1
DB2_ERROR_CODE2
DB2_ERROR_CODE3
DB2_ERROR_CODE4
DB2_INTERNAL_ERROR_POINTER
DB2_LINE_NUMBER
DB2_MESSAGE_ID
DB2_MESSAGE_ID1
DB2_MESSAGE_ID2
DB2_MESSAGE_KEY
DB2_MODULE_DETECTING_ERROR
DB2_NUMBER_FAILING_STATEMENTS
DB2_OFFSET
DB2_ORDINAL_TOKEN_n
DB2_PARTITION_NUMBER
DB2_REASON_CODE
DB2_RETURNED_SQLCODE
DB2_ROW_NUMBER
DB2_SQLERRD_SET
DB2_SQLERRD1
DB2_SQLERRD2
DB2_SQLERRD3
DB2_SQLERRD4
DB2_SQLERRD5
DB2_SQLERRD6
DB2_TOKEN_COUNT
DB2_TOKEN_STRING
MESSAGE_LENGTH
MESSAGE_OCTET_LENGTH
MESSAGE_TEXT
PARAMETER_MODE
PARAMETER_NAME
PARAMETER_ORDINAL_POSITION
RETURNED_SQLSTATE
ROUTINE_CATALOG
ROUTINE_NAME
ROUTINE_SCHEMA
SCHEMA_NAME
SERVER_NAME
SPECIFIC_NAME
SUBCLASS_ORIGIN
TABLE_NAME
TRIGGER_CATALOG
TRIGGER_NAME
TRIGGER_SCHEMA

Description

label

Specifies the label for the GET DIAGNOSTICS statement. If the ending label is specified, it must be the same as the beginning label. The label name cannot be the same as the routine name or another label within the same scope. For more information, see [“References to SQL labels”](#) on page 1574.

CURRENT or STACKED

Specifies which diagnostics area to access.

CURRENT

Specifies to access the first diagnostics area. It corresponds to the previous SQL statement that was executed and that was not a GET DIAGNOSTICS statement. This is the default.

STACKED

Specifies to access the second diagnostics area. The second diagnostics area is only available within a handler. It corresponds to the previous SQL statement that was executed before the handler was entered and that was not a GET DIAGNOSTICS statement. If the GET DIAGNOSTICS statement is the first statement within a handler, then the first diagnostics area and the second diagnostics area contain the same diagnostics information.

statement-information

Returns information about the last SQL statement executed.

SQL-variable-name-1 or SQL-parameter-name-1

Identifies a variable described in the program in accordance with the rules for declaring SQL variables and SQL parameters. The data type of the SQL variable or SQL parameter must be compatible with the data type as specified in [Table 93 on page 1341](#) for the specified condition information item. The variable is assigned the value of the specified statement information item according to the retrieval assignment rules described in [“Retrieval assignment”](#) on page 95. If the value is truncated when assigning it to the SQL variable or SQL parameter, a warning is returned (SQLSTATE 01004) and the GET_DIAGNOSTICS_DIAGNOSTICS item of the diagnostics area is updated with the details of this condition.

If a specified diagnostic item does not contain diagnostic information, then the SQL variable or SQL parameter is set to a default value, based on its data type: 0 for an exact numeric diagnostic item, an empty string for a VARCHAR diagnostic item and blanks for a CHAR diagnostic item.

condition-information

Returns information about the condition or conditions that occurred when the last SQL statement was executed.

CONDITION SQL-variable-name-2 or SQL-parameter-name-2 or integer

Identifies the diagnostic for which information is requested. Each diagnostic that occurs while executing an SQL statement is assigned an integer. The value 1 indicates the first diagnostic, 2 indicates the second diagnostic and so on. If the value is 1, then the diagnostic information retrieved corresponds to the condition indicated by the SQLSTATE value actually returned by the execution of the previous SQL statement (other than a GET DIAGNOSTICS statement). The SQL variable or SQL parameter specified must be described in the program in accordance with the rules for declaring exact numeric variables with zero scale. The value specified must not be less than one or greater than the number of available diagnostics

SQL-variable-name-3 or SQL-parameter-name-3

Identifies a variable described in the program in accordance with the rules for declaring SQL variables or SQL parameters. The data type of the SQL variable or SQL parameter must be compatible with the data type as specified in [Table 93 on page 1341](#) for the specified condition information item. The SQL variable or SQL parameter is assigned the value of the specified condition information item according to the retrieval assignment rules described in [“Retrieval assignment”](#) on page 95. If the value is truncated when assigning it to the SQL variable or SQL parameter, a warning is returned (SQLSTATE 01004) and the GET_DIAGNOSTICS_DIAGNOSTICS item of the diagnostics area is updated with the details of this condition.

If a specified diagnostic item does not contain diagnostic information, then the SQL variable or SQL parameter is set to a default value, based on its data type: 0 for an exact numeric diagnostic item, an empty string for a VARCHAR diagnostic item and blanks for a CHAR diagnostic item.

combined-information

Returns multiple information items combined into one string.

If the GET DIAGNOSTICS statement is specified in an SQL function, SQL procedure, or trigger, the GET DIAGNOSTICS statement must be the first statement specified in the handler that will handle the error.

If information is wanted about a warning,

- If a handler will get control for the warning condition, the GET DIAGNOSTICS statement must be the first statement specified in that handler.
- If a handler will not get control for the warning condition, the GET DIAGNOSTICS statement must be the next statement executed after that previous statement.

SQL-variable-name-4 or SQL-parameter-name-4

Identifies a variable described in the program in accordance with the rules for declaring SQL variables or SQL parameters. The data type of the SQL variable or SQL parameter must be VARCHAR. The SQL variable or SQL parameter is assigned according to the retrieval assignment rules described in “Retrieval assignment” on page 95. If the length of *SQL-variable-name-4* or *SQL-parameter-name-4* is not sufficient to hold the full returned diagnostic string, the string is truncated, a warning is returned (SQLSTATE 01004) and the GET_DIAGNOSTICS_DIAGNOSTICS item of the diagnostics area is updated with the details of this condition.

ALL

Indicates that all diagnostic items that are set for the last SQL statement executed should be combined into one string. The format of the string is a semicolon separated list of all of the available diagnostic information in the form:

```
item-name=character-form-of-the-item-value;
```

The character form of a positive numeric value will not contain a leading plus sign (+) unless the item is RETURNED_SQLCODE. In this case, a leading plus sign (+) is added. For example:

```
NUMBER=1;RETURNED_SQLSTATE=02000;DB2_RETURNED_SQLCODE=+100;
```

Only items that contain diagnostic information are included in the string. There are also no entries in this string for the DB2_GET_DIAGNOSTICS_DIAGNOSTICS and DB2_SQL_NESTING_LEVEL items.

STATEMENT

Indicates that all *statement-information-item* diagnostic items that contain diagnostic information for the last SQL statement executed should be combined into one string. The format is the same as described above for ALL.

CONDITION

Indicates that *condition-information-item* diagnostic items that contain diagnostic information for the last SQL statement executed should be combined into one string. If *SQL-variable-name-5* or *SQL-parameter-name-5* or *integer* is specified, then the format is the same as described above for the ALL option. If *SQL-variable-name-5* or *SQL-parameter-name-5* or *integer* is not specified, then the format includes a condition number entry at the beginning of the information for that condition in the form:

```
CONDITION_NUMBER=X;item-name=character-form-of-the-item-value;
```

where X is the number of the condition. For example:

```
CONDITION_NUMBER=1;RETURNED_SQLSTATE=02000;RETURNED_SQLCODE=+100;  
CONDITION_NUMBER=2;RETURNED_SQLSTATE=01004;
```

CONNECTION

Indicates that *connection-information-item* diagnostic items that contain diagnostic information for the last SQL statement executed should be combined into one string. If *SQL-variable-name-5* or *SQL-parameter-name-5* or *integer* is specified, then the format is the same as described above for ALL. If *SQL-variable-name-5* or *SQL-parameter-name-5* or *integer* is not specified, then the format includes a connection number entry at the beginning of the information for that condition in the form:

```
CONNECTION_NUMBER=X; item-name=character-form-of-the-item-value;
```

where X is the number of the condition. For example:

```
CONNECTION_NUMBER=1; CONNECTION_NAME=SVL1; DB2_PRODUCT_ID=DSN07010;
```

SQL-variable-name-5 or SQL-parameter-name-5 or integer

Identifies the diagnostic for which ALL CONDITION or ALL CONNECTION information is requested. The SQL variable or SQL parameter specified must be described in the program in accordance with the rules for declaring integer SQL variables or SQL parameters. The value specified must not be less than one or greater than the number of available diagnostics.

statement-information-item

For a description of the *statement-information-items*, see [“statement-information-item” on page 1330](#).

connection-information-item

For a description of the *connection-information-items*, see [“connection-information-item” on page 1333](#).

condition-information-item

For a description of the *condition-information-items*, see [“condition-information-item” on page 1334](#).

Notes

Effect of statement:: The GET DIAGNOSTICS statement does not change the contents of the diagnostics area except for DB2_GET_DIAGNOSTICS_DIAGNOSTICS.

Considerations for the SQLCODE and SQLSTATE SQL variables: The GET DIAGNOSTICS statement changes the value of the SQLSTATE and SQLCODE SQL variables.

Case of return values: Values for identifiers in returned diagnostic items are not delimited and are case sensitive. For example, a table name of "abc" would be returned, simply as abc.

Data types for items: When a diagnostic item is assigned to a SQL variable or SQL parameter, the SQL variable or SQL parameter must be compatible with the data type of the diagnostic item. For more information, see [Table 93 on page 1341](#).

Keyword Synonym: The following keywords are synonyms supported for compatibility to prior releases. These keywords are non-standard and should not be used:

- The keyword EXCEPTION can be used as a synonym for CONDITION.
- The keyword RETURN_STATUS can be used as a synonym for DB2_RETURN_STATUS.

Example

Example 1:: In an SQL procedure, execute a GET DIAGNOSTICS statement to determine how many rows were updated.

```
CREATE PROCEDURE sqlprocg (IN deptnbr VARCHAR(3))
LANGUAGE SQL
BEGIN
  DECLARE SQLSTATE CHAR(5);
  DECLARE rcount INTEGER;
  UPDATE CORPDATA.PROJECT
  SET PRSTAFF = PRSTAFF + 1.5
  WHERE DEPTNO = deptnbr;
```

```

GET DIAGNOSTICS rcount = ROW_COUNT;
/* At this point, rcount contains the number of rows that were updated. */
END

```

Example 2:: Within an SQL procedure, handle the returned status value from the invocation of a stored procedure called TRYIT. TRYIT could use the RETURN statement to explicitly return a status value or a status value could be implicitly returned by the database manager. If the procedure is successful, it returns a value of zero.

```

CREATE PROCEDURE TESTIT ()
LANGUAGE SQL
A1: BEGIN
    DECLARE RETVAL INTEGER DEFAULT 0;
    ...
    CALL TRYIT
    GET DIAGNOSTICS RETVAL = RETURN_STATUS;
    IF RETVAL <> 0 THEN
        ...
        LEAVE A1;
    ELSE
        ...
    END IF;
END A1

```

Example 3:: In an SQL procedure, execute a GET DIAGNOSTICS statement to retrieve the message text for an error.

```

CREATE PROCEDURE divide2 ( IN numerator INTEGER,
                           IN denominator INTEGER,
                           OUT divide_result INTEGER,
                           OUT divide_error VARCHAR(70) )
LANGUAGE SQL
BEGIN
    DECLARE CONTINUE HANDLER FOR SQLEXCEPTION
    GET DIAGNOSTICS EXCEPTION 1
        divide_error = MESSAGE_TEXT;
    SET divide_result = numerator / denominator;
END;

```

GOTO statement

The GOTO statement branches to a user-defined label within an SQL function, SQL procedure, or SQL trigger.

Syntax

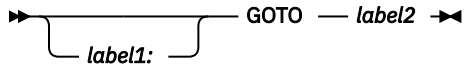

The diagram illustrates the syntax of the GOTO statement. It shows a horizontal line with an arrowhead pointing to the right, labeled 'GOTO'. Below this line, a bracket labeled 'label1:' spans from the start of the line to a point before the 'GOTO' text. To the right of the 'GOTO' text, another horizontal line with an arrowhead pointing to the right is labeled 'label2'.

Description

label1

Specifies the label for the GOTO statement. The label name cannot be the same as the routine name or another label within the same scope. For more information, see [“References to SQL labels” on page 1574](#).

label2

Specifies the labelled statement where processing is to continue. The labelled statement and the GOTO statement must both be in the same scope:

- If the GOTO statement is defined in a FOR statement, *label2* must be defined inside the same FOR statement, excluding a nested FOR statement or nested compound statement.
- If the GOTO statement is defined outside a FOR statement, *label2* must not be defined within a FOR statement or nested compound statement.
- If the GOTO statement is defined in a condition handler, *label2* must be defined inside the same handler.
- If the GOTO statement is defined outside a condition handler, *label2* must not be defined within a condition handler.

If *label2* is not defined within a scope that the GOTO statement can reach, an error is returned.

Notes

Using a GOTO statement: It is recommended that the GOTO statement be used sparingly. This statement interferes with normal sequence of processing SQL statements, thus making a routine more difficult to read and maintain. Before using a GOTO statement, determine whether another statement, such as IF or LEAVE, can be used in place, to eliminate the need for a GOTO statement.

Effect on open cursors: When a GOTO statement transfers control out of a compound statement, all open cursors that are declared in the compound statement that contains the GOTO statement are closed, unless they are declared to return result sets or unless *ENDACTGRP is specified.

Effect on ATOMIC compound statements: When a GOTO statement transfers control out of an ATOMIC compound statement, the savepoint that was implicitly started when the ATOMIC compound statement was entered is released.

Considerations for SQLSTATE and SQLCODE variables: The GOTO statement does not affect the SQLSTATE and SQLCODE SQL variables. At the end of the GOTO statement the SQLSTATE and SQLCODE SQL variables reflect the result of the last statement executed before that GOTO statement.

Example

In the following statement, the parameters *rating* and *v_empno* are passed in to the procedure. The time in service is returned as a date duration in output parameter *return_parm*. If the time in service with the company is less than 6 months, the GOTO statement transfers control to the end of the procedure and *new_salary* is left unchanged.

```

CREATE PROCEDURE adjust_salary
(IN v_empno CHAR(6),
 IN rating INTEGER,
 OUT return_parm DECIMAL(8,2))
LANGUAGE SQL
MODIFIES SQL DATA
BEGIN
  DECLARE new_salary DECIMAL(9,2);
  DECLARE service DECIMAL(8,2);
  SELECT salary, CURRENT_DATE - hiredate
  INTO new_salary, service
  FROM employee
  WHERE empno = v_empno;
  IF service < 600
  THEN GOTO exit1;
  END IF;
  IF rating = 1
  THEN SET new_salary = new_salary + (new_salary * .10);
  ELSEIF rating = 2
  THEN SET new_salary = new_salary + (new_salary * .05);
  END IF;
  UPDATE employee
  SET salary = new_salary
  WHERE empno = v_empno;

  EXIT1: SET return_parm = service;
END

```

IF statement

The IF statement executes different sets of SQL statements based on the result of search conditions.

Syntax

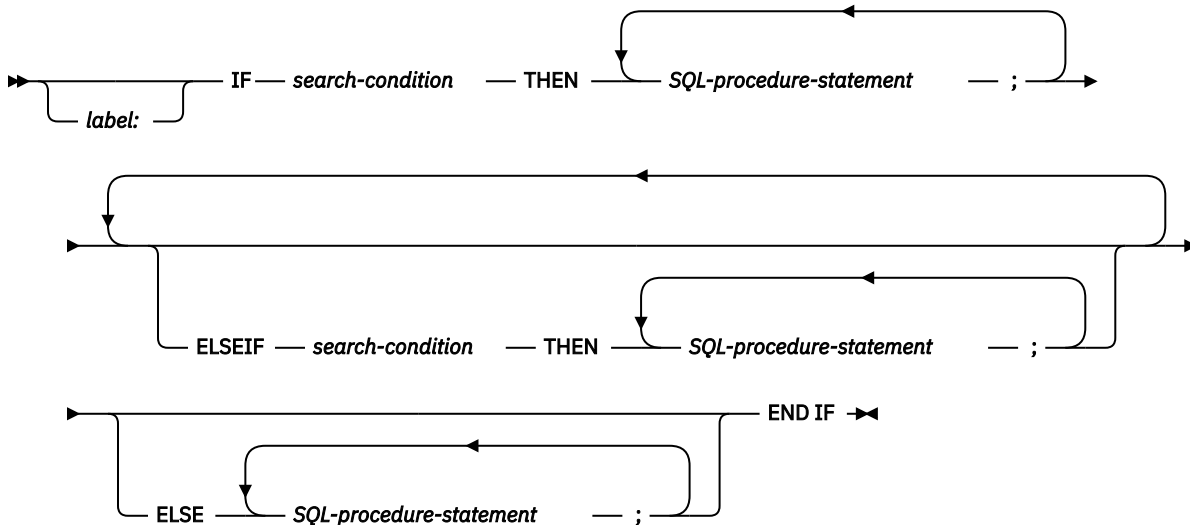

Description

label

Specifies the label for the IF statement. The label name cannot be the same as the routine name or another label within the same scope. For more information, see [“References to SQL labels”](#) on page 1574.

search-condition

Specifies the *search-condition* for which an SQL statement should be executed. If the condition is unknown or false, processing continues to the next search condition, until either a condition is true or processing reaches the ELSE clause.

SQL-procedure-statement

Specifies an SQL statement to execute if the preceding *search-condition* is true.

Notes

Considerations for SQLSTATE and SQLCODE SQL variables: When the first *SQL-procedure-statement* in the IF statement is executed, the SQLSTATE and SQLCODE SQL variables reflect the result of evaluating the *search-conditions* of that IF statement. If an IF statement does not include an ELSE clause and none of the *search-conditions* evaluate to true, then when the statement that follows the IF statement is executed, the SQLSTATE and SQLCODE SQL variables reflect the result of evaluating the search conditions of that IF statement.

Example

The following SQL procedure accepts two IN parameters: an employee number and an employee rating. Depending on the value of *rating*, the employee table is updated with new values in the salary and bonus columns.

```
CREATE PROCEDURE UPDATE_SALARY_IF
  (IN employee_number CHAR(6), INOUT rating SMALLINT)
LANGUAGE SQL
MODIFIES SQL DATA
BEGIN
  DECLARE not_found CONDITION FOR SQLSTATE '02000';
```

```
DECLARE EXIT HANDLER FOR not_found
SET rating = -1;
IF rating = 1
THEN UPDATE employee
SET salary = salary * 1.10, bonus = 1000
WHERE empno = employee_number;
ELSEIF rating = 2
THEN UPDATE employee
SET salary = salary * 1.05, bonus = 500
WHERE empno = employee_number;
ELSE UPDATE employee
SET salary = salary * 1.03, bonus = 0
WHERE empno = employee_number;
END IF;
END
```

INCLUDE statement

The INCLUDE statement inserts application code, including declarations and statements, into an SQL routine body. The included code can either be SQL code that is immediately added to the routine definition or ILE C code to be added during the create of the SQL procedure, SQL function, or SQL trigger.

Authorization

The authorization ID of the statement must have the system authorities *OBJOPR and *READ on the file that contains the member.

Syntax

➤ INCLUDE ➡

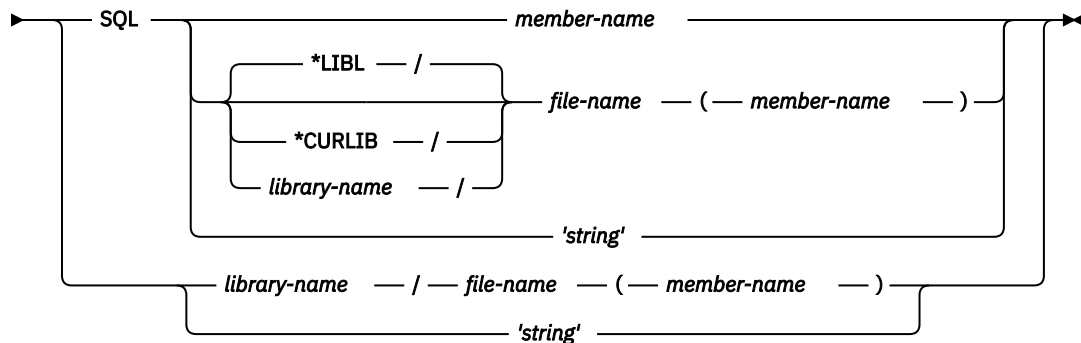

Description

The INCLUDE statement must be specified at a point in the source where the included source statements are syntactically acceptable. Both forms of the INCLUDE statement can be specified as an *SQL-procedure-statement* within the body of a *compound-statement*. An INCLUDE SQL statement can also be specified within the declarations and handlers of a *compound-statement*. There is no limit to the number of includes that can be specified in one statement, but the included source cannot contain an embedded include.

SQL

The included source contains only SQL syntax that is allowed in an *SQL-routine-body* or *SQL-trigger-body*. These statements will be expanded inline as part of the *SQL-routine-body* or *SQL-trigger-body*. They will be processed as if they are directly part of the statement text for the statement. The statement text saved for the SQL procedure, function, or trigger will contain this included source. If the QSYS2.GENERATE_SQL procedure is used, the generated source will show the expanded SQL statements wherever an INCLUDE SQL was used.

member-name

Identifies a member to be included within the SQL procedure, SQL function, or SQL trigger. The source file and library will be determined using the INCFILE option on the SET OPTION statement. For more information, see [“SET OPTION”](#) on page 1505.

file-name (member-name)

Identifies a source file and member to be included within the SQL procedure, SQL function, or SQL trigger. The library containing the source file is specified in one of these ways:

***LIBL**

All libraries in the job's library list are searched until the first match is found. This is the default.

***CURLIB**

The current library for the job is searched. If no library is specified as the current library for the job, QGPL is used.

library-name

Identifies the name of the library.

'string'

Identifies a source stream file to be included. The string will be handled as a normal SQL string literal; the source stream file rules for escaping characters will not be followed. No suffix will be appended to the string.

SQL not specified

The included source contains only ILE C language statements or embedded SQL statements prefixed with EXEC SQL. A corresponding EXEC SQL INCLUDE statement will be generated as part of the program source that is generated for this SQL procedure, SQL function, or SQL trigger.

If the include requires additional service programs to be bound during the creation of the procedure, function, or trigger, you can use the BINDOPT option on the SET OPTION statement to add a BNDSRVPGM parameter to reference exports found in other service programs. For more information, see “SET OPTION” on page 1505.

library-name / file-name (member-name)

Specifies the fully qualified source file and member containing ILE C language statements to be included during the creation of the SQL procedure, SQL function, or SQL trigger.

'string'

Specifies the complete path for a source stream file containing ILE C language statements to be included during the creation of the SQL procedure, SQL function, or SQL trigger.

Notes

CCSID considerations: If the CCSID of the SQL statement is different from the CCSID of the source for the INCLUDE statement, the INCLUDE source is converted to the CCSID of the SQL statement.

Source considerations: The source of a C include should not exceed 160 source columns. Anything beyond that position will be truncated.

String literals in an SQL include cannot be longer than the width of the embedding source.

The source of an SQL include should contain complete SQL statements. Although not enforced, unpredictable results may occur if this rule is violated.

SQL trigger consideration: When an SQL trigger uses the INCLUDE statement to include ILE C, any operation that requires the trigger program to be rebuilt has a runtime dependency on the include file. If the trigger program is not found, it can be automatically rebuilt by the database when the trigger is fired, when the table is copied, or when the table is restored. If the include file is not available, the trigger will not create and any function requiring the trigger will fail.

Examples

- Use the INCLUDE statement to embed a common condition handler in an SQL function.

```
CREATE FUNCTION H1 ()
  RETURNS INT
  DETERMINISTIC
  NO EXTERNAL ACTION
  NOT FENCED
  BEGIN
    DECLARE RES INT;
    INCLUDE SQL SQLINCLUDE(COMMONCOND);

    SET RES = AFUNCTION();
    RETURN RES;
  END;
```

COMMONCOND in file SQLINCLUDE in the library list contains the following. The condition handler calls an SQL procedure named ERR_PROC for a specific not found condition. As part of the message handling, it uses the ROUTINE_SCHEMA and ROUTINE_SPECIFIC_NAME built-in global variables to indicate the source of the error.

```

DECLARE NO_FUNC CONDITION FOR SQLSTATE '42704';
DECLARE CONTINUE HANDLER FOR NO_FUNC
BEGIN
  CALL ERR_PROC(SYSIBM.ROUTINE_SCHEMA CONCAT '.' CONCAT
                SYSIBM.ROUTINE_SPECIFIC_NAME CONCAT
                ': Function not found');
END;

```

- Use the INCLUDE statement to embed a call to a C function. It will use the Qp0zLprintf interface to print the input parameter.

```

CREATE PROCEDURE LPRINTF(P1 VARCHAR(1000))
BEGIN
  IF P1 IS NOT NULL THEN
    INCLUDE QGPL/CINCLUDE(MYLPRINTF);
  END IF;
END;

```

Member MYLPRINTF in file CINCLUDE in library QGPL contains the following code. Note that this include has a reference to the function's input parameter. You need to examine the generated C code to determine what the names are.

```

{
  /* declare prototype for Qp0zLprintf */
  extern int Qp0zLprintf (char *format, ...);

  /* print input parameter to job log */
  Qp0zLprintf("%.s\n", LPRINTF.P1.LEN, LPRINTF.P1.DAT);
}

```

ITERATE statement

The ITERATE statement causes the flow of control to return to the beginning of a labelled loop.

Syntax

→  ITERATE — *target-label* →

Description

label

Specifies the label for the ITERATE statement. The label name cannot be the same as the routine name or another label within the same scope. For more information, see [“References to SQL labels” on page 1574](#).

target-label

Specifies the label of the FOR, LOOP, REPEAT, or WHILE statement to which the flow of control is passed. *target-label* must be defined as a label for a FOR, LOOP, REPEAT, or WHILE statement. The ITERATE statement must be in that FOR, LOOP, REPEAT, or WHILE statement, or in the block of code that is directly or indirectly nested within that statement, subject to the following restrictions:

- If the ITERATE statement is in a condition handler, *target-label* must be defined in that condition handler.
- If the ITERATE statement is not in a condition handler, *target-label* must not be defined in a condition handler.
- If the ITERATE statement is in a FOR statement, *target-label* must be that label on that FOR statement, or the label must be defined inside that FOR statement.

Notes

Considerations for SQLSTATE and SQLCODE variables: The ITERATE statement does not affect the SQLSTATE and SQLCODE SQL variables. At the end of the ITERATE statement the SQLSTATE and SQLCODE SQL variables reflect the result of the last statement executed before that ITERATE statement.

Example

This example uses a cursor to return information for a new department. If the *not_found* condition handler was invoked, the flow of control passes out of the loop. If the value of *v_dept* is 'D11', an ITERATE statement passes the flow of control back to the top of the LOOP statement. Otherwise, a new row is inserted into the DEPARTMENT table.

```
CREATE PROCEDURE ITERATOR ()
LANGUAGE SQL
MODIFIES SQL DATA
BEGIN
  DECLARE v_dept CHAR(3);
  DECLARE v_deptname VARCHAR(29);
  DECLARE v_admdept CHAR(3);
  DECLARE at_end INTEGER DEFAULT 0;
  DECLARE not_found CONDITION FOR SQLSTATE '02000';
  DECLARE c1 CURSOR FOR
    SELECT deptno,deptname,admdept
    FROM department
    ORDER BY deptno;
  DECLARE CONTINUE HANDLER FOR not_found
    SET at_end = 1;
  OPEN c1;
  ins_loop:
  LOOP
    FETCH c1 INTO v_dept, v_deptname, v_admdept;
    IF at_end = 1 THEN
      LEAVE ins_loop;
```

```
ELSEIF v_dept = 'D11' THEN
    ITERATE ins_loop;
END IF;
INSERT INTO department (deptno,deptname,admdept)
    VALUES ('NEW', v_deptname, v_admdept);
END LOOP;
CLOSE c1;
END
```

LEAVE statement

The LEAVE statement continues execution by leaving a block or loop.

Syntax

```
→ ┌──────────┐ LEAVE — label2 →  
  |           |  
  | label1:   |
```

Description

label1

Specifies the label for the LEAVE statement. The label name cannot be the same as the routine name or another label within the same scope. For more information, see [“References to SQL labels” on page 1574](#).

label2

Specifies the label of the compound, FOR, LOOP, REPEAT, or WHILE statement to exit.

The LEAVE statement cannot be used to leave a handler.

Notes

Effect on open cursors: When a LEAVE statement transfers control out of a compound statement, all open cursors that are declared in the compound statement that contains the LEAVE statement are closed, unless they are declared to return result sets or unless *ENDACTGRP is specified.

Considerations for SQLSTATE and SQLCODE variables: The LEAVE statement does not affect the SQLSTATE and SQLCODE SQL variables. At the end of the LEAVE statement the SQLSTATE and SQLCODE SQL variables reflect the result of the last statement executed before that LEAVE statement.

Examples

The example contains a loop that fetches data for cursor *c1*. If the value of SQL variable *at_end* is not zero, the LEAVE statement transfers control out of the loop.

```
CREATE PROCEDURE LEAVE_LOOP (OUT COUNTER INTEGER)
LANGUAGE SQL
BEGIN
  DECLARE v_counter INTEGER;
  DECLARE v_firstname VARCHAR(12);
  DECLARE v_midinit CHAR(1);
  DECLARE v_lastname VARCHAR(15);
  DECLARE at_end SMALLINT DEFAULT 0;
  DECLARE not_found CONDITION FOR SQLSTATE '02000';
  DECLARE c1 CURSOR FOR
    SELECT firstname, midinit, lastname
    FROM employee;
  DECLARE CONTINUE HANDLER FOR not_found
    SET at_end = 1;
  SET v_counter = 0;
  OPEN c1;
  fetch_loop:
  LOOP
    FETCH c1 INTO v_firstname, v_midinit, v_lastname;
    IF at_end <> 0 THEN
      LEAVE fetch_loop;
    END IF;
    SET v_counter = v_counter + 1;
  END LOOP fetch_loop;
  SET counter = v_counter;
  CLOSE c1;
END
```

LOOP statement

The LOOP statement repeats the execution of a statement or a group of statements.

Syntax

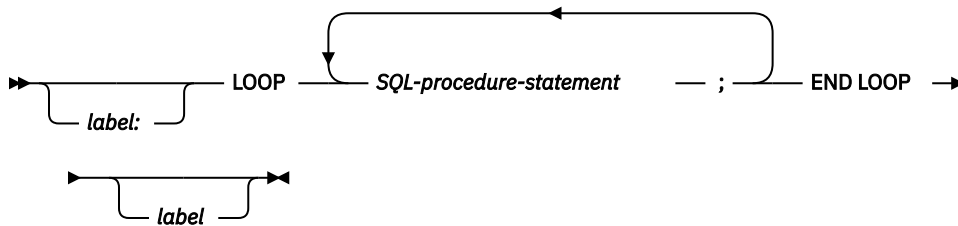

Description

label

Specifies the label for the LOOP statement. If the ending label is specified, it must be the same as the beginning label. The label name cannot be the same as the routine name or another label within the same scope. For more information, see [“References to SQL labels” on page 1574](#).

SQL-procedure statement

Specifies an SQL statement to be executed in the loop

Notes

Considerations for the diagnostics area: At the beginning of the first iteration of the LOOP statement, and with every subsequent iteration, the diagnostics area is cleared.

Considerations for SQLSTATE and SQLCODE variables: Prior to executing the first *SQL-procedure statement* within that LOOP statement, the SQLSTATE and SQLCODE values reflect the last values that were set prior to the LOOP statement. If the loop is terminated with a GOTO or a LEAVE statement, the SQLSTATE and SQLCODE values reflect the successful completion of that statement. When the LOOP statement iterates, the SQLSTATE and SQLCODE values reflect the result of the last SQL statement executed within the LOOP statement.

Examples

This procedure uses a LOOP statement to fetch values from the employee table. Each time the loop iterates, the OUT parameter *counter* is incremented and the value of *v_midinit* is checked to ensure that the value is not a single space (' '). If *v_midinit* is a single space, the LEAVE statement passes the flow of control outside of the loop.

```
CREATE PROCEDURE LOOP_UNTIL_SPACE (OUT COUNTER INTEGER)
LANGUAGE SQL
BEGIN
  DECLARE v_counter INTEGER DEFAULT 0;
  DECLARE v_firstname VARCHAR(12);
  DECLARE v_midinit CHAR(1);
  DECLARE v_lastname VARCHAR(15);
  DECLARE c1 CURSOR FOR
    SELECT firstname, midinit, lastname
    FROM employee;
  DECLARE CONTINUE HANDLER FOR NOT FOUND
    SET counter = -1;
  OPEN c1;
  fetch_loop:
  LOOP
    FETCH c1 INTO v_firstname, v_midinit, v_lastname;
    IF v_midinit = ' ' THEN
      LEAVE fetch_loop;
    END IF;
    SET v_counter = v_counter + 1;
```

```
END LOOP fetch_loop;  
SET counter = v_counter;  
CLOSE c1;  
END
```

PIPE statement

The PIPE statement returns one row from a table function. An SQL table function that uses a PIPE statement is referred to as a pipelined function.

Syntax

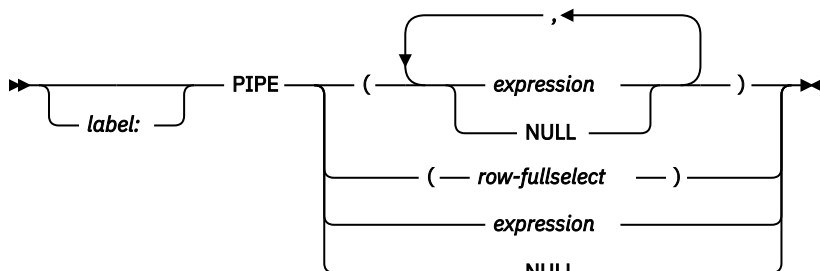

Description

label

Specifies the label for the PIPE statement. The label name cannot be the same as the routine name or another label within the same scope. For more information, see [“References to SQL labels”](#) on page 1574.

(expression, ...)

Specifies a row value is returned from the function. The number of expressions or NULL keywords in the list must match the number of columns in the function result. The data types of each expression must be assignable to the data type of the corresponding column defined for the function result, using the storage assignment rules as described in [“Assignments and comparisons”](#) on page 91.

row-fullselect

Specifies a fullselect that returns a single row. The number of columns in the fullselect must match the number of columns in the function result. The data types of the result table columns of the fullselect must be assignable to the data types of the columns defined for the function result, using the storage assignment rules as described in [“Assignments and comparisons”](#) on page 91. If the result of the row fullselect is no rows, a null value is returned for each column. An error is returned if there is more than one row in the result.

expression

Specifies a scalar value is returned from the function. The table function must return a single column and the value of the expression must be assignable to that column.

NULL

Specifies that a null value is returned from the function. If there is more than one result column, a null value is returned for each column.

Example

Use a PIPE statement to return rows from an SQL table function.

```
CREATE FUNCTION TRANSFORM() RETURNS TABLE ( EMPLOYEE_NAME CHAR(20), UNIQUE# INT )
BEGIN
  DECLARE EMPNAME VARCHAR(15);
  DECLARE MYRECNUM INTEGER DEFAULT 1;
  DECLARE AT_END INTEGER DEFAULT 0;
  DECLARE EMP_CURSOR CURSOR FOR SELECT lastname FROM employee;
  DECLARE CONTINUE HANDLER FOR SQLSTATE '02000'
    SET AT_END = 1;

  OPEN EMP_CURSOR;
  MYLOOP: LOOP
    FETCH EMP_CURSOR INTO EMPNAME;
    IF AT_END = 1 THEN
```



```
    LEAVE MYLOOP;
  END IF;
  PIPE (EMPNAME, MYRECNUM); -- return single row
  SET MYRECNUM = MYRECNUM + 1;
END LOOP;

CLOSE EMP_CURSOR;
RETURN;
END;
```

REPEAT statement

The REPEAT statement executes a statement or group of statements until a search condition is true.

Syntax

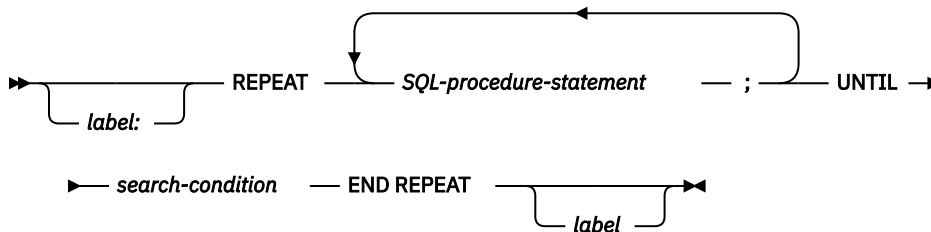

Description

label

Specifies the label for the REPEAT statement. If the ending label is specified, it must be the same as the beginning label. The label name cannot be the same as the routine name or another label within the same scope. For more information, see [“References to SQL labels” on page 1574](#).

SQL-procedure-statement

Specifies an SQL statement to be executed in the REPEAT loop.

search-condition

The *search-condition* is evaluated after each execution of the REPEAT loop. If the condition is true, the REPEAT loop will exit. If the condition is unknown or false, the looping continues.

Notes

Considerations for the diagnostics area: At the beginning of the first iteration of the REPEAT statement, and with every subsequent iteration, the diagnostics area is cleared.

Considerations for SQLSTATE and SQLCODE SQL variables: With each iteration of the REPEAT statement, the SQLSTATE and SQLCODE SQL variables are cleared prior to executing the first *SQL-procedure-statement* within the REPEAT statement. At the beginning of the first iteration of the REPEAT statement, the SQLSTATE and SQLCODE values reflect the last values that were set prior to the REPEAT statement. At the beginning of iterations 2 through n of the REPEAT statement, the SQLSTATE and SQLCODE values reflect the result of evaluating the search condition in the UNTIL clause of that REPEAT statement. If the loop is terminated with a GOTO, ITERATE, or LEAVE statement, the SQLSTATE and SQLCODE values reflect the successful completion of that statement. Otherwise, after the END REPEAT of the REPEAT statement completes, the SQLSTATE and SQLCODE values reflect the result of evaluating the search condition in the UNTIL clause of that REPEAT statement.

Example

A REPEAT statement fetches rows from a table until the *not_found* condition handler is invoked.

```
CREATE PROCEDURE REPEAT_STMT (OUT COUNTER INTEGER)
LANGUAGE SQL
BEGIN
  DECLARE v_counter INTEGER DEFAULT 0;
  DECLARE v_firstname VARCHAR(12);
  DECLARE v_midinit CHAR(1);
  DECLARE v_lastname VARCHAR(15);
  DECLARE at_end SMALLINT DEFAULT 0;
  DECLARE not_found CONDITION FOR SQLSTATE '02000';
  DECLARE c1 CURSOR FOR
    SELECT firstname, midinit, lastname
    FROM employee;
  DECLARE CONTINUE HANDLER FOR not_found
    SET at_end = 1;
```

```
OPEN c1;
fetch_loop:
REPEAT
  FETCH c1 INTO v_firstname, v_middlename, v_lastname;
  SET v_counter = v_counter + 1;
  UNTIL at_end > 0
END REPEAT fetch_loop;
SET counter = v_counter;
CLOSE c1;
END
```

RESIGNAL statement

The RESIGNAL statement is used within a condition handler to re-raise the current condition, or raise an alternate condition so that it can be processed at a higher level. It causes an exception, warning, or not found condition to be returned, along with optional message text.

Issuing the RESIGNAL statement without an operand causes the current condition to be passed outwards.

Syntax

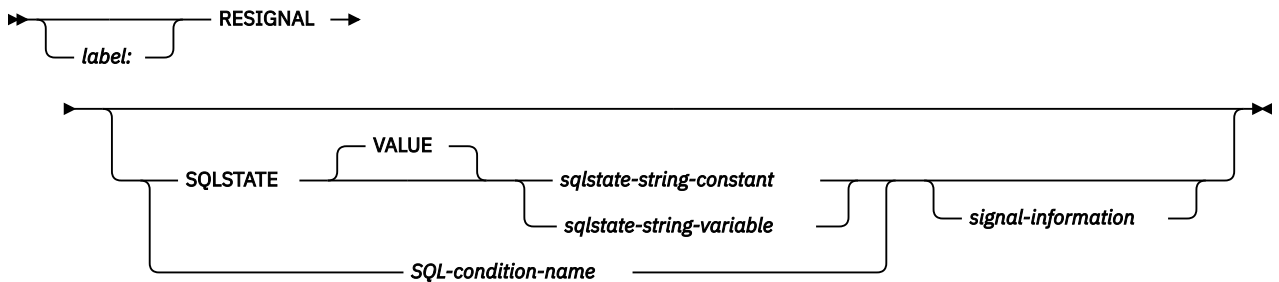

signal-information

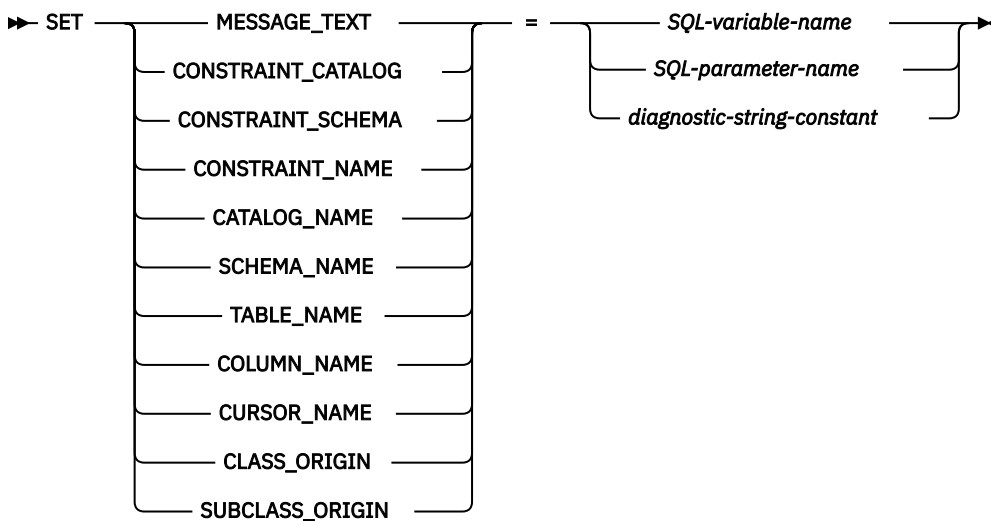

Description

label

Specifies the label for the RESIGNAL statement. The label name cannot be the same as the routine name or another label within the same scope. For more information, see [“References to SQL labels”](#) on page 1574.

SQLSTATE VALUE

Specifies the SQLSTATE that will be resigned. Any valid SQLSTATE value can be used. The specified value must follow the rules for SQLSTATEs:

- Each character must be from the set of digits ('0' through '9') or non-accented upper case letters ('A' through 'Z').
- The SQLSTATE class (first two characters) cannot be '00' since this represents successful completion.

If the SQLSTATE does not conform to these rules, an error is returned.

sqlstate-string-constant

The *sqlstate-string-constant* must be a character string constant with exactly 5 characters.

sqlstate-string-variable

The *sqlstate-string-variable* must be a character or Unicode graphic variable. The actual length of the contents of the *sqlstate-string-variable* must be 5.

SQL-condition-name

Specifies the name of the condition that will be returned. The *SQL-condition-name* must be declared within the *compound-statement*.

SET

Introduces the assignment of values to *condition-information-items*. The *condition-information-item* values can be accessed using the GET DIAGNOSTICS statement. The only *condition-information-item* that can be accessed in the SQLCA is MESSAGE_TEXT.

MESSAGE_TEXT

Specifies a string that describes the error or warning.

If an SQLCA is used,

- the string is returned in the SQLERRMC field of the SQLCA
- if the actual length of the string is longer than 1000 bytes, it is truncated without a warning.

CONSTRAINT_CATALOG

Specifies a string that indicates the name of the database that contains a constraint related to the signalled error or warning.

CONSTRAINT_SCHEMA

Specifies a string that indicates the name of the schema that contains a constraint related to the signalled error or warning.

CONSTRAINT_NAME

Specifies a string that indicates the name of a constraint related to the signalled error or warning.

CATALOG_NAME

Specifies a string that indicates the name of the database that contains a table or view related to the signalled error or warning.

SCHEMA_NAME

Specifies a string that indicates the name of the schema that contains a table or view related to the signalled error or warning.

TABLE_NAME

Specifies a string that indicates the name of a table or view related to the signalled error or warning.

COLUMN_NAME

Specifies a string that indicates the name of a column in the table or view related to the signalled error or warning.

CURSOR_NAME

Specifies a string that indicates the name of a cursor related to the signalled error or warning.

CLASS_ORIGIN

Specifies a string that indicates the origin of the SQLSTATE class related to the signalled error or warning.

SUBCLASS_ORIGIN

Specifies a string that indicates the origin of the SQLSTATE subclass related to the signalled error or warning.

SQL-variable-name

Identifies an SQL variable declared within the *compound-statement*, that contains the value to be assigned to the *condition-information-item*. The SQL variable must be defined as CHAR, VARCHAR, Unicode GRAPHIC, or Unicode VARGRAPHIC variable.

SQL-parameter-name

Identifies an SQL parameter declared within the *compound-statement*, that contains the value to be assigned to the *condition-information-item*. The SQL parameter must be defined as CHAR, VARCHAR, Unicode GRAPHIC, or Unicode VARGRAPHIC variable.

diagnostic-string-constant

Specifies a character string constant that contains the value to be assigned to the *condition-information-item*.

Notes

SQLSTATE values: Any valid SQLSTATE value can be used in the RESIGNAL statement. However, it is recommended that programmers define new SQLSTATEs based on ranges reserved for applications. This prevents the unintentional use of an SQLSTATE value that might be defined by the database manager in a future release.

For more information about SQLSTATEs, see the [SQL Messages and Codes](#) topic collection.

Assignment: When the RESIGNAL statement is executed, the value of each of the specified *string-constants* and *variables* is assigned to the corresponding *condition-information-item*. However, if the length of a *string-constant* or *variable* is longer than the maximum length of the corresponding *condition-information-item*, it is truncated without a warning. For details on the assignment rules, see “[Assignments and comparisons](#)” on page 91. For details on the maximum length of specific *condition-information-items*, see “[GET DIAGNOSTICS](#)” on page 1324.

Processing a RESIGNAL statement:

- If the RESIGNAL statement is specified without a SQLSTATE clause or a *SQL-condition-name*, the SQL function, SQL procedure, or SQL trigger resignals the identical condition that invoked the handler and the SQLCODE is not changed.
- When a RESIGNAL statement is issued and an SQLSTATE or *SQL-condition-name* is specified, the SQLCODE is based on the SQLSTATE value as follows:
 - If the specified SQLSTATE class is either '01' or '02', a warning or not found is signalled and the SQLCODE is set to +438.
 - Otherwise, an exception is returned and the SQLCODE is set to –438.

If the SQLSTATE or condition indicates that an exception is signalled (SQLSTATE class other than '01' or '02');

- If a handler exists in the same compound statement as the RESIGNAL statement, and the *compound-statement* contains a handler for SQLEXCEPTION or the specified SQLSTATE or condition; the exception is handled and control is transferred to that handler.
- If the *compound-statement* is nested and an outer level *compound-statement* has a handler for SQLEXCEPTION or the specified SQLSTATE or condition; the exception is handled and control is transferred to that handler.
- Otherwise, the exception is not handled and control is immediately returned to the end of the compound statement.

If the SQLSTATE or condition indicates that a warning (SQLSTATE class '01') or not found (SQLSTATE class '02') is signalled:

- If a handler exists in the same compound statement as the RESIGNAL statement, and the *compound-statement* contains a handler for SQLWARNING (if the SQLSTATE class is '01'), NOT FOUND (if the SQLSTATE class is '02'), or the specified SQLSTATE or condition; the warning or not found condition is handled and control is transferred to that handler.
- If the *compound-statement* is nested and an outer level compound statement contains a handler for SQLWARNING (if the SQLSTATE class is '01'), NOT FOUND (if the SQLSTATE class is '02'), or the specified SQLSTATE or condition; the warning or not found condition is not handled and processing continues with the next statement.
- Otherwise, the warning is not handled and processing continues with the next statement.

Considerations for the diagnostics area: The RESIGNAL statement might modify the contents of the current diagnostics area. If an SQLSTATE or *SQL-condition-name* is specified as part of the RESIGNAL statement, the RESIGNAL statement starts with a clear of the diagnostics area and sets the RETURNED_SQLSTATE to reflect the specified SQLSTATE or *SQL-condition-name*. If any *signal-information* is specified, the corresponding items in the condition area are assigned the specified values. DB2_RETURNED_SQLCODE is set to +438 or -438 corresponding to the specified SQLSTATE or *SQL-condition-name*.

Example

This example detects a division by zero error. The IF statement uses a SIGNAL statement to invoke the overflow condition handler. The condition handler uses a RESIGNAL statement to return a different SQLSTATE value to the client application.

```
CREATE PROCEDURE divide ( IN numerator INTEGER,
                        IN denominator INTEGER,
                        OUT divide_result INTEGER )
LANGUAGE SQL
BEGIN
  DECLARE overflow CONDITION FOR '22003';
  DECLARE CONTINUE HANDLER FOR overflow
    RESIGNAL SQLSTATE '22375';
  IF denominator = 0 THEN
    SIGNAL overflow;
  ELSE
    SET divide_result = numerator / denominator;
  END IF;
END
```

RETURN statement

The RETURN statement returns from a routine. For SQL scalar functions, it returns the result of the function. For SQL non-pipelined table functions, it returns a table as the result of the function. For SQL pipelined table functions, it indicates the end of the result table has been reached. For an SQL procedure, it optionally returns an integer status value.

Syntax

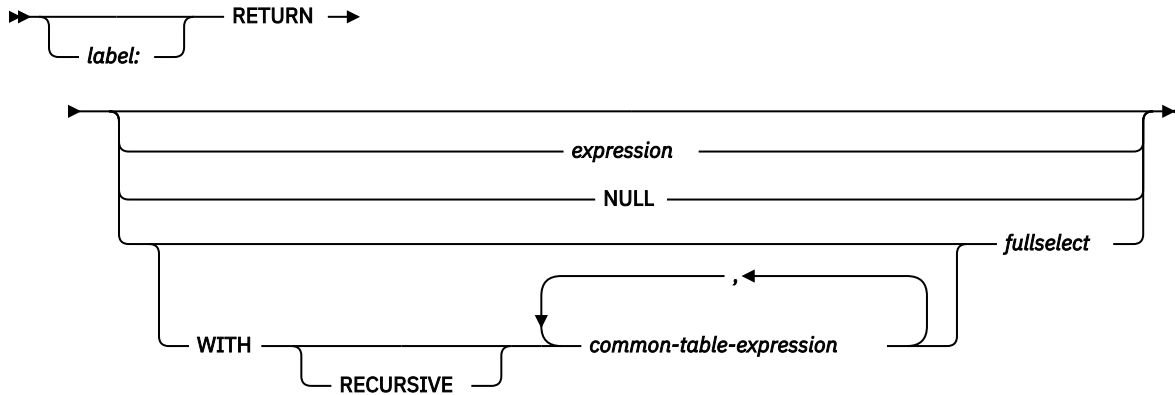

Description

label

Specifies the label for the RETURN statement. The label name cannot be the same as the routine name or another label within the same scope. For more information, see [“References to SQL labels” on page 1574](#).

expression

Specifies a value that is returned from the routine:

- If the routine is a scalar function, the data type of the result must be assignable to the data type defined for the function result, using the storage assignment rules as described in [“Assignments and comparisons” on page 91](#). An aggregate function, or user-defined function that is sourced on an aggregate function must not be specified for a RETURN statement in an SQL scalar function.
- If the routine is a table function, a scalar expression (other than a scalar fullselect) cannot be specified.
- If the routine is a procedure, the data type of *expression* must be INTEGER. If the *expression* evaluates to the null value, a value of zero is returned.

NULL

Specifies that the null value is returned from the routine.

- If the routine is a scalar function, the null value is returned.
- If the routine is a table function, NULL must not be specified.
- If the routine is a procedure, NULL must not be specified.

WITH common-table-expression

Specifies one or more *common table expressions* to be used in the fullselect.

fullselect

Specifies the row or rows to be returned for the routine.

- If the routine is a scalar function, the fullselect must return one column and, at most, one row. The data type of the result column must be assignable to the data type defined for the function result, using the storage assignment rules as described in [“Assignments and comparisons” on page 91](#).

- If the routine is a table function, the fullselect can return zero or more rows with one or more columns. The number of columns in the fullselect must match the number of columns in the function result. In addition, the data types of the result table columns of the fullselect must be assignable to the data types of the columns defined for the function result, using the storage assignment rules as described in [“Assignments and comparisons”](#) on page 91.
- If the routine is a procedure, fullselect must not be specified.

Notes

Returning from a table function:

- The last statement executed in the *SQL-routine-body* must be a RETURN statement.
- For a non-pipelined table function, the RETURN statement indicates the rows to be returned. Exactly one RETURN statement must be specified and it must contain a *fullselect*.
- For a pipelined table function, one or more RETURN statements must be specified and they must contain no return values.

Returning from a procedure:

- If a RETURN statement with a specified return value is used to return from a procedure then the SQLCODE, SQLSTATE, and message length in the SQLCA or diagnostics area are initialized to zeros, and message text is set to blanks. An error is not returned to the caller.
- If a RETURN statement is not used to return from a procedure or if a value is not specified on the RETURN statement,
 - if the procedure returns with an SQLCODE that is greater than or equal to zero, the specified target for DB2_RETURN_STATUS in a GET DIAGNOSTICS statement will be set to a value of 0
 - if the procedure returns with an SQLCODE that is less than zero, the specified target for DB2_RETURN_STATUS in a GET DIAGNOSTICS statement will be set to a value of -1.
- When a value is returned from a procedure, the caller may access the value using:
 - the GET DIAGNOSTICS statement to retrieve the DB2_RETURN_STATUS when the SQL procedure was called from another SQL procedure
 - the parameter bound for the return value parameter marker in the escape clause CALL syntax (? =CALL...) in an ODBC or JDBC application
 - directly from the SQLCA returned from processing the CALL of an SQL procedure by retrieving the value of sqlerrd[0] when the SQLCODE is not less than zero. When the SQLCODE is less than zero, the sqlerrd[0] value is not set and the application should assume a return status value of -1.

RETURN restrictions:

- RETURN is not allowed in SQL triggers.
- In a compound(dynamic) statement, RETURN cannot specify a return value.

Example

Example 1: Use a RETURN statement to return from an SQL procedure with a status value of zero if successful, and -200 if not.

```

BEGIN
  ...
  GOTO fail;
  ...
  success: RETURN 0
  fail: RETURN -200
  ...
END

```

Example 2: Define a scalar function that returns the tangent of a value using the existing sine and cosine functions.

```
CREATE FUNCTION mytan (x DOUBLE)  
RETURNS DOUBLE  
LANGUAGE SQL  
CONTAINS SQL  
NO EXTERNAL ACTION  
DETERMINISTIC  
RETURN SIN(x)/COS(x)
```

SIGNAL statement

The SIGNAL statement signals an error or warning condition. It causes an error or warning to be returned with the specified SQLSTATE and optional *condition-information-items*. The syntax of SIGNAL in an SQL function, SQL procedure, or SQL trigger is similar to what is supported as a SIGNAL statement in other contexts.

See “SIGNAL” on page 1542 for details.

Syntax

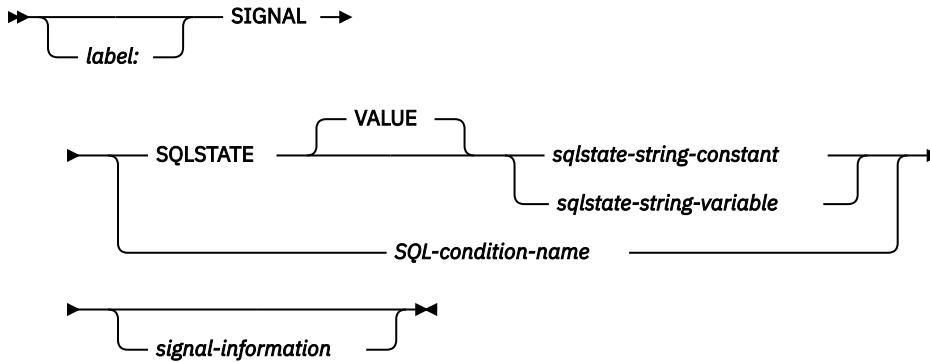

signal-information

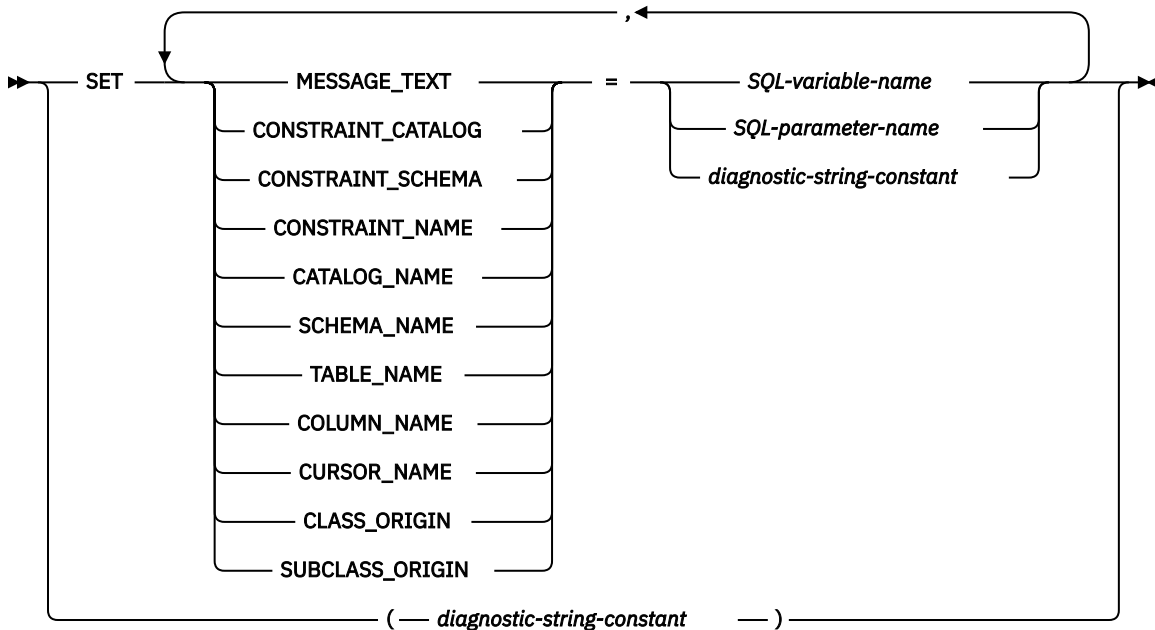

Description

label

Specifies the label for the SIGNAL statement. The label name cannot be the same as the routine name or another label within the same scope. For more information, see “References to SQL labels” on page 1574.

SQLSTATE VALUE

Specifies the SQLSTATE that will be signalled. The specified value must not be null and must follow the rules for SQLSTATES:

- Each character must be from the set of digits ('0' through '9') or non-accented upper case letters ('A' through 'Z').
- The SQLSTATE class (first two characters) cannot be '00' since this represents successful completion.

If the SQLSTATE does not conform to these rules, an error is returned.

sqlstate-string-constant

The *sqlstate-string-constant* must be a character string constant with exactly 5 characters.

sqlstate-string-variable

The *sqlstate-string-variable* must be a character or Unicode graphic variable. The actual length of the contents of the *variable* must be 5.

SQL-condition-name

Specifies the name of the condition that will be signalled. The *SQL-condition-name* must be declared within the *compound-statement*.

SET

Introduces the assignment of values to *condition-information-items*. The *condition-information-item* values can be accessed using the GET DIAGNOSTICS statement. The only *condition-information-item* that can be accessed in the SQLCA is MESSAGE_TEXT.

MESSAGE_TEXT

Specifies a string that describes the error or warning.

If an SQLCA is used,

- the string is returned in the SQLERRMC field of the SQLCA
- if the actual length of the string is longer than 1000 bytes, it is truncated without a warning.

CONSTRAINT_CATALOG

Specifies a string that indicates the name of the database that contains a constraint related to the signalled error or warning.

CONSTRAINT_SCHEMA

Specifies a string that indicates the name of the schema that contains a constraint related to the signalled error or warning.

CONSTRAINT_NAME

Specifies a string that indicates the name of a constraint related to the signalled error or warning.

CATALOG_NAME

Specifies a string that indicates the name of the database that contains a table or view related to the signalled error or warning.

SCHEMA_NAME

Specifies a string that indicates the name of the schema that contains a table or view related to the signalled error or warning.

TABLE_NAME

Specifies a string that indicates the name of a table or view related to the signalled error or warning.

COLUMN_NAME

Specifies a string that indicates the name of a column in the table or view related to the signalled error or warning.

CURSOR_NAME

Specifies a string that indicates the name of a cursor related to the signalled error or warning.

CLASS_ORIGIN

Specifies a string that indicates the origin of the SQLSTATE class related to the signalled error or warning.

SUBCLASS_ORIGIN

Specifies a string that indicates the origin of the SQLSTATE subclass related to the signalled error or warning.

SQL-variable-name

Identifies an SQL variable declared within the *compound-statement*, that contains the value to be assigned to the *condition-information-item*. The SQL variable must be defined as CHAR, VARCHAR, Unicode GRAPHIC, or Unicode VARGRAPHIC variable.

SQL-parameter-name

Identifies an SQL parameter declared within the *compound-statement*, that contains the value to be assigned to the *condition-information-item*. The SQL parameter must be defined as CHAR, VARCHAR, Unicode GRAPHIC, or Unicode VARGRAPHIC variable.

diagnostic-string-constant

Specifies a character string constant that contains the value to be assigned to the *condition-information-item*.

(diagnostic-string-constant)

Specifies a character string constant that contains the message text.

This form is only allowed in the triggered action of a CREATE TRIGGER statement.

To conform with the ANS and ISO standards, this form should not be used. It is provided for compatibility with other products.

Notes

SQLSTATE values: Any valid SQLSTATE value can be used in the SIGNAL statement. However, it is recommended that programmers define new SQLSTATES based on ranges reserved for applications. This prevents the unintentional use of an SQLSTATE value that might be defined by the database manager in a future release.

For more information about SQLSTATES, see the [SQL Messages and Codes](#) topic collection.

Assignment: When the SIGNAL statement is executed, the value of each of the specified *string-constants* and *variables* is assigned to the corresponding *condition-information-item*. However, if the length of a *string-constant* or *variable* is longer than the maximum length of the corresponding *condition-information-item*, it is truncated without a warning. For details on the assignment rules, see “[Assignments and comparisons](#)” on page 91. For details on the maximum length of specific *condition-information-items*, see “[GET DIAGNOSTICS](#)” on page 1324.

Processing a SIGNAL statement: When a SIGNAL statement is issued, the SQLCODE returned in the SQLCA is based on the SQLSTATE value as follows:

- If the specified SQLSTATE class is either '01' or '02', a warning or not found is signalled and the SQLCODE is set to +438.
- Otherwise, an exception is signalled and the SQLCODE is set to -438.

If the SQLSTATE or condition indicates that an exception (SQLSTATE class other than '01' or '02') is signalled,

- If a handler exists in the same compound statement as the SIGNAL statement, and the compound statement contains a handler for SQLEXCEPTION or the specified SQLSTATE or condition; the exception is handled and control is transferred to that handler.
- If the *compound-statement* is nested and an outer level *compound-statement* has a handler for SQLEXCEPTION or the specified SQLSTATE or condition; the exception is handled and control is transferred to that handler.
- Otherwise, the exception is not handled and control is immediately returned to the end of the compound statement.

If the SQLSTATE or condition indicates that a warning (SQLSTATE class '01') or not found (SQLSTATE class '02') is signalled,

- If a handler exists in the same compound statement as the SIGNAL statement, and the compound statement contains a handler for SQLWARNING (if the SQLSTATE class is '01'), NOT FOUND (if the

SQLSTATE class is '02'), or the specified SQLSTATE or condition; the warning or not found condition is handled and control is transferred to that handler.

- If the *compound-statement* is nested and an outer level compound statement contains a handler for SQLWARNING (if the SQLSTATE class is '01'), NOT FOUND (if the SQLSTATE class is '02'), or the specified SQLSTATE or condition; the warning or not found condition is not handled and processing continues with the next statement.
- Otherwise, the warning is not handled and processing continues with the next statement.

Considerations for the diagnostics area: The SIGNAL statement starts with a clear of the diagnostics area and then sets the RETURNED_SQLSTATE to reflect the specified SQLSTATE or *SQL-condition-name*. If any *signal-information* is specified, the corresponding items in the condition area are assigned the specified values. DB2_RETURNED_SQLCODE is set to +438 or -438 corresponding to the specified SQLSTATE or *SQL-condition-name*.

Example

An SQL procedure for an order system that signals an application error when a customer number is not known to the application. The ORDERS table includes a foreign key to the CUSTOMER table, requiring that the CUSTNO exist before an order can be inserted.

```
CREATE PROCEDURE SUBMIT_ORDER
  (IN ONUM INTEGER, IN CNUM INTEGER,
   IN PNUM INTEGER, IN QNUM INTEGER)
  LANGUAGE SQL
  MODIFIES SQL DATA
  BEGIN
    DECLARE EXIT HANDLER FOR SQLSTATE VALUE '23503'
      SIGNAL SQLSTATE '75002'
      SET MESSAGE_TEXT = 'Customer number is not known';
    INSERT INTO ORDERS (ORDERNO, CUSTNO, PARTNO, QUANTITY)
      VALUES (ONUM, CNUM, PNUM, QNUM);
  END
```

WHILE statement

The WHILE statement repeats the execution of a statement while a specified condition is true.

Syntax

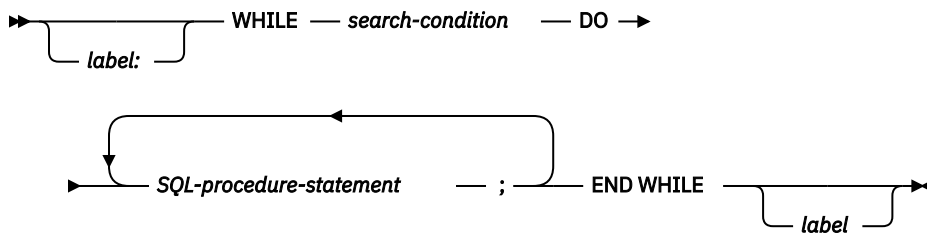

Description

label

Specifies the label for the WHILE statement. If the ending label is specified, it must be the same as the beginning label. The label name cannot be the same as the routine name or another label within the same scope. For more information, see [“References to SQL labels” on page 1574](#).

search-condition

Specifies a condition that is evaluated before each execution of the WHILE loop. If the condition is true, the *SQL-procedure-statements* in the WHILE loop are executed.

SQL-procedure-statement

Specifies an SQL statement or statements to execute within the WHILE loop.

Notes

Considerations for the diagnostics area: At the beginning of the first iteration of the WHILE statement, and with every subsequent iteration, the diagnostics area is cleared.

Considerations for SQLSTATE and SQLCODE SQL variables: With each iteration of the WHILE statement, when the first *SQL-procedure-statement* is executed, the SQLSTATE and SQLCODE SQL variables reflect the result of evaluating the search condition of that WHILE statement. If the loop is terminated with a GOTO, ITERATE, or LEAVE statement, the SQLSTATE and SQLCODE values reflect the successful completion of that statement. Otherwise, after the END WHILE of the WHILE statement completes, the SQLSTATE and SQLCODE reflect the result of evaluating the search condition of that WHILE statement.

Example

This example uses a WHILE statement to iterate through FETCH and SET statements. While the value of SQL variable *v_counter* is less than half of number of employees in the department identified by the IN parameter *deptNumber*, the WHILE statement continues to perform the FETCH and SET statements. When the condition is no longer true, the flow of control leaves the WHILE statement and closes the cursor.

```
CREATE PROCEDURE dept_median
(IN deptNumber SMALLINT,
 OUT medianSalary DECIMAL(7,2))
LANGUAGE SQL
BEGIN
  DECLARE v_numRecords INTEGER DEFAULT 1;
  DECLARE v_counter INTEGER DEFAULT 0;
  DECLARE c1 CURSOR FOR
    SELECT salary
    FROM staff
    WHERE dept = deptNumber
    ORDER BY salary;
  DECLARE EXIT HANDLER FOR NOT FOUND
    SET medianSalary = 6666;
```

```
SET medianSalary = 0;
SELECT COUNT(*) INTO v_numRecords
  FROM staff
  WHERE dept = deptNumber;
OPEN c1;
WHILE v_counter < (v_numRecords/2 + 1) DO
  FETCH c1 INTO medianSalary;
  SET v_counter = v_counter +1;
END WHILE;
CLOSE c1;
END
```

Appendix A. SQL limits

The following tables describe certain SQL and database limits imposed by the Db2 for i database manager.

Note:

- System storage limits may preclude the limits specified here. For example, see [“Maximum row sizes”](#) on page 1154.
- A limit of *storage* means that the limit is dependent on the amount of storage available.
- A limit of *statement* means that the limit is dependent on the limit for the maximum length of a statement.

Table 121. Identifier Length Limits

Identifier Limits	Db2 for i Limit
Longest authorization name	10 ¹³¹
Longest correlation name	128
Longest cursor name	128
Longest descriptor name	128
Longest external program name (string form)	279 ¹³²
Longest external program name (unqualified form)	10
Longest host identifier ¹³³	128
Longest package version-id	64
Longest partition name	10
Longest savepoint name	128
Longest schema name	128
Longest server name	18
Longest statement name	128
Longest SQL condition name	128
Longest SQL label	128
Longest unqualified alias name	128
Longest unqualified column name	128
Longest unqualified constraint name	128
Longest unqualified distinct type name	128
Longest unqualified function name	128
Longest unqualified global variable name	128
Longest unqualified index name	128
Longest unqualified mask name	128
Longest unqualified nodegroup name	10
Longest unqualified package name	10

Table 121. Identifier Length Limits (continued)

Identifier Limits	Db2 for i Limit
Longest unqualified permission name	128
Longest unqualified procedure name	128
Longest unqualified sequence name	128
Longest unqualified specific name	128
Longest unqualified SQL parameter name	128
Longest unqualified SQL variable name	128
Longest unqualified system column name	10
Longest unqualified system object name	10
Longest unqualified system schema name	10
Longest unqualified table and view name	128
Longest unqualified trigger name	128
Longest unqualified XSR object name	128
Longest XML element name, attribute name, prefix name, or processing instruction name specified in XMLELEMENT, XMLFOREST, XMLATTRIBUTES, XMLNAMESPACES or XMLPI	128
Longest XML path name specified in XMLTABLE	128
Longest XML element name, attribute name, prefix name, or processing instruction name for a parsed XML document	1000
Longest XML schema location uniform resource identifier (URI)	1000
Longest JSON path name	128

Table 122. Numeric Limits

Numeric Limits	Db2 for i Limit
Smallest SMALLINT value	-32 768
Largest SMALLINT value	+32 767
Smallest INTEGER value	-2 147 483 648
Largest INTEGER value	+2 147 483 647
Smallest BIGINT value	-9 223 372 036 854 775 808
Largest BIGINT value	+9 223 372 036 854 775 807
Largest decimal precision	63

¹³¹ As an application requester, Db2 for i can send an authorization name of up to 255 bytes.

¹³² For REXX procedures, the limit is 33.

¹³³ For an RPG, COBOL, or REXX program, the limit is 64.

Table 123. String Limits (continued)

String Limits	Db2 for i Limit
Maximum length of GRAPHIC (in double-byte characters)	16382 ¹³⁶
Maximum length of VARGRAPHIC (in double-byte characters)	16369 ¹³⁶
Maximum length of DBCLOB (in double-byte characters)	1 073 741 823
Maximum length of BINARY (in bytes)	32765 ¹³⁶
Maximum length of VARBINARY (in bytes)	32739 ¹³⁶
Maximum length of BLOB (in bytes)	2 147 483 647
Maximum length of serialized XML (in bytes)	2 147 483 647
Maximum length of character constant	32740
Maximum length of a graphic constant	16370
Maximum length of binary constant	32740
Maximum length of concatenated character string	2 147 483 647
Maximum length of concatenated graphic string	1 073 741 823
Maximum length of concatenated binary string	2 147 483 647
Maximum number of hexadecimal constant digits	32 762
Maximum length of catalog comments	2000 ¹³⁷
Maximum length of column label (in bytes)	60
Maximum length of SQL routine label	128
Maximum length of table, package, or alias label	50
Maximum length of C NUL-terminated	32739 ¹³⁶
Maximum length of C NUL-terminated graphic	16369 ¹³⁶

Table 124. XML Limits

XML Limits	Db2 for i Limit
Maximum length of an XML schema document (in bytes)	2 147 483 647
Maximum length of a parsed XML entity	1 gigabyte
Maximum depth of an internal XML tree	128

Table 125. JSON Limits

JSON Limits	Db2 for i Limit
Maximum length of an JSON document (in bytes)	2 147 483 647

¹³⁶ If the column is NOT NULL, the maximum is one more.

¹³⁷ For sequences the limit is 500.

Table 126. Datetime Limits

Datetime Limits	Db2 for i Limit
Smallest DATE value	0001-01-01
Largest DATE value	9999-12-31
Smallest TIME value	00:00:00
Largest TIME value	24:00:00
Smallest TIMESTAMP value	0001-01-01-00.00.00.000000000000
Largest TIMESTAMP value	9999-12-31-24.00.00.000000000000
Smallest timestamp precision	0
Largest timestamp precision	12

Table 127. DataLink Limits

Datalink Limits	Db2 for i Limit
Maximum length of DATALINK	32718
Maximum length of DATALINK comment	254

Table 128. Database Manager Limits

Database Manager Limits	Db2 for i Limit
Relational Database	
Maximum number of schemas	storage
Maximum number of tables in a relational database	storage
Maximum number of nodes in a nodegroup	32
Schemas	
Maximum number of objects in a schema	approximately 1 000 000
Tables and Views	
Maximum number of columns in a table	8000
Maximum number of columns in a view	8000
Maximum length of a row without LOBs including all overhead	32766
Maximum length of a row with LOBs including all overhead	3 758 096 383
Maximum number of rows in a non-partitioned table	4 294 967 288
Maximum number of rows in a data partition	4 294 967 288
Maximum size of a non-partitioned table	1.7 terabytes
Maximum size of a data partition	1.7 terabytes
Maximum number of data partitions in a single partitioned table	256
Maximum number of table partitioning columns	120

Table 128. Database Manager Limits (continued)

Database Manager Limits	Db2 for i Limit
Maximum number of tables referenced in a view or materialized query table	1000 ¹³⁸
Maximum number of dependent views, materialized query tables, and indexes on a table or view.	storage
Constraints	
Maximum number of constraints on a table	5000
Maximum number of columns in a UNIQUE constraint	120
Maximum combined length of columns in a UNIQUE constraint (in bytes)	32767 ¹³⁶
Maximum number of referencing columns in a foreign key	120
Maximum combined length of referencing columns in a foreign key (in bytes)	32767 ¹³⁶
Maximum length of a CHECK constraint (in bytes)	statement
Triggers	
Maximum number of triggers on a table	300
Maximum runtime depth of cascading triggers	200
Indexes	
Maximum number of indexes on a table	approximately 15000
Maximum number of columns in an index key	120
Maximum length of an index key	32767 ¹³⁶
Maximum size of a non-partitioned index	1.7 terabytes
Maximum size of a partition of a partitioned index	1.7 terabytes
SQL	
Maximum length of an SQL statement (in bytes)	2 097 152
Maximum number of tables referenced in an SQL statement	1000 ¹³⁸
Maximum number of variables and constants in an SQL statement	32700 ¹³⁹
Maximum number of elements in a select list	approximately 8000 ¹⁴⁰
Maximum number of predicates in a WHERE or HAVING clause	statement
Maximum number of columns in a GROUP BY clause	total GROUP BY length
Maximum total length of columns in a GROUP BY clause	3.5 gigabytes ¹⁴¹
Maximum number of elements in a CUBE grouping	10
Maximum number of columns in an ORDER BY clause	total ORDER BY length

Table 128. Database Manager Limits (continued)

Database Manager Limits	Db2 for i Limit
Maximum total length of columns in an ORDER BY clause	3.5 gigabytes ¹⁴¹
Maximum levels of recursion for hierarchical query	250
Maximum levels allowed for a subquery	256
Maximum number of values in an insert operation	8000
Maximum number of SET clauses in a single update operation	8000
Routines	
Maximum number of parameters in a procedure	2000 ¹⁴²
Maximum number of parameters in a function	2000 ¹⁴²
Maximum number of return columns in a table function	8000
Maximum number of nested levels for routines	storage
Types	
Maximum cardinality of an array type	2 147 483 647
Applications	
Maximum number of host variable declarations in a precompiled program	storage ¹⁴³
Maximum length of a host variable value (in bytes)	2 147 483 647
Maximum length of an MQ message CLOB value (in bytes)	2M
Maximum length of an MQ message varying length value (in bytes)	32000
Maximum number of declared cursors in a program	storage
Maximum number of cursors opened at one time	storage ¹⁴⁴
Maximum number of rows locked in a unit of work	500 000 000
Maximum number of DDL statements in a unit of work	131 036
Maximum number of locators in a transaction	16 000 000 ¹⁴⁵
Maximum size of an SQLDA (in bytes)	16 777 215
Maximum number of prepared statements	storage
Maximum number of savepoints active at one time	storage
Maximum number of simultaneously allocated CLI handles in a process	160 000 ¹⁴⁶
Maximum size of a package	1008 megabytes ¹⁴⁷
Maximum length of a path	8843
Maximum number of schemas in a path	268
Maximum length of a password	127

Table 128. Database Manager Limits (continued)

Database Manager Limits	Db2 for i Limit
Maximum length of a hint	32
Maximum size of a program, service program, or module associated space (in bytes)	16 777 216
Maximum size of the diagnostics area	90K
Maximum size of an array variable	4GB

¹³⁸ The maximum number of members (and partitions) referenced is also 1000. In DELETE and UPDATE statements the maximum number is 256. In a complex SQL statement, the number of tables that can be referenced may be limited by internal structures.

¹³⁹ The limit is restricted by internal structures and may be less depending on how the constants are used in the statement and if very large string constants or variables are used.

¹⁴⁰ The limit is based on the size of internal structures generated for the parsed SQL statement.

¹⁴¹ The limit is 32766 if CQE processed the select statement. The limit will be less if an ICU collating sequence or ALWCOPYDTA(*NO) is used.

¹⁴² SQL procedures and SQL functions can have up to 2000 parameters. The number of parameters for external procedures and external functions cannot exceed 2000 and is limited by the maximum number of parameters allowed by the language.

¹⁴³ In RPG/400 and PL/I programs when the old parameter passing technique is used, the limit is approximately 4000. The limit is based on the number of pointers allowed in the program. In all other cases, the limit is based on operating system constraints.

¹⁴⁴ The maximum number of cursors open at one time in a single job is approximately 20 966.

¹⁴⁵ The maximum number of locators in a transaction in SQL Server mode is 209 000.

¹⁴⁶ The maximum number of allocated handles per DRDA connection is 500.

¹⁴⁷ The maximum size of a DRDA package can be increased from 500 megabytes to 1 gigabyte by using a QAQQINI option.

Appendix B. Characteristics of SQL statements

This appendix contains information on the characteristics of SQL statements pertaining to the various places where they are used.

- [“Actions allowed on SQL statements” on page 1644](#) shows whether an SQL statement can be executed, prepared interactively or dynamically, and whether the statement is processed by the requester, the server or the precompiler.
- [“SQL statement data access classification for routines” on page 1647](#) shows the level of SQL data access that must be specified to use the SQL statement in a routine.
- [“Considerations for using distributed relational database” on page 1650](#) provides information about the use of SQL statements when the application server is not the same as the application requester.

Actions allowed on SQL statements

Indicates whether an SQL statement can be executed, prepared interactively or dynamically, and whether the statement is processed by the requester, the server, or the precompiler.

The table below shows whether a specific Db2 statement can be executed, prepared interactively or dynamically, or processed by the requester, the server, or the precompiler. The letter **Y** means yes.

Table 129. Actions allowed on SQL statements

SQL statement	Executable	Interactively or dynamically prepared	Processed by		
			Requesting system	Server	Precompiler
ALLOCATE CURSOR ⁵	Y	Y	Y		
ALLOCATE DESCRIPTOR ^{4 5}	Y			Y	
ALTER	Y	Y		Y	
ASSOCIATE LOCATORS ⁵	Y	Y	Y		
BEGIN DECLARE SECTION ^{4 5}					Y
CALL	Y	Y		Y	
CLOSE ⁴	Y			Y	
COMMENT	Y	Y		Y	
COMMIT	Y	Y		Y	
compound (dynamic)	Y	Y		Y	
CONNECT (type 1 and type 2) ^{4 5}	Y		Y		
CREATE	Y	Y		Y	
DEALLOCATE DESCRIPTOR ^{4 5}	Y			Y	
DECLARE CURSOR ⁴					Y
DECLARE GLOBAL TEMPORARY TABLE	Y	Y		Y	
DECLARE PROCEDURE ^{4 5}					Y
DECLARE STATEMENT ^{4 5}					Y
DECLARE VARIABLE ^{4 5}					Y
DELETE	Y	Y		Y	
DESCRIBE ⁴	Y			Y	
DESCRIBE CURSOR ^{4 5}	Y		Y		
DESCRIBE INPUT ^{4 5}	Y			Y	
DESCRIBE PROCEDURE ^{4 5}	Y		Y		
DESCRIBE TABLE ⁴	Y			Y	
DISCONNECT ^{4 5}	Y		Y		
DROP	Y	Y		Y	

Table 129. Actions allowed on SQL statements (continued)

SQL statement	Executable	Interactively or dynamically prepared	Processed by		
			Requesting system	Server	Precompiler
END DECLARE SECTION ^{4 5}					Y
EXECUTE ⁴	Y			Y	
EXECUTE IMMEDIATE ⁴	Y			Y	
FETCH	Y			Y	
FREE LOCATOR ^{4 5}	Y	Y		Y	
GET DESCRIPTOR ^{4 5}	Y			Y	
GET DIAGNOSTICS ⁵	Y			Y	
GRANT	Y	Y		Y	
HOLD LOCATOR ^{4 5}	Y	Y		Y	
INCLUDE ^{4 5}					Y
INSERT	Y	Y		Y	
LABEL	Y	Y		Y	
LOCK TABLE	Y	Y		Y	
MERGE	Y	Y		Y	
OPEN ⁴	Y			Y	
PREPARE ⁴	Y			Y	
REFRESH TABLE	Y	Y		Y	
RELEASE connection ^{4 5}	Y		Y		
RELEASE SAVEPOINT	Y	Y		Y	
RENAME	Y	Y		Y	
REVOKE	Y	Y		Y	
ROLLBACK	Y	Y		Y	
SAVEPOINT	Y	Y		Y	
SELECT INTO ⁵	Y			Y	
SET CONNECTION ^{4 5}	Y		Y		
SET CURRENT DEBUG MODE	Y	Y		Y	
SET CURRENT DECFLOAT ROUNDING MODE	Y	Y		Y	
SET CURRENT DEGREE ⁵	Y	Y		Y	
SET CURRENT IMPLICIT XMLPARSE OPTION	Y	Y		Y	
SET CURRENT TEMPORAL SYSTEM_TIME ⁵	Y	Y		Y	

Table 129. Actions allowed on SQL statements (continued)

SQL statement	Executable	Interactively or dynamically prepared	Processed by		
			Requesting system	Server	Precompiler
SET DESCRIPTOR ^{4 5}	Y			Y	
SET ENCRYPTION PASSWORD	Y	Y		Y	
SET OPTION ^{4 5}					Y
SET PATH	Y	Y		Y	
SET RESULT SETS ^{3 5}	Y			Y	
SET SCHEMA	Y	Y		Y	
SET SESSION AUTHORIZATION ⁵	Y	Y		Y	
SET TRANSACTION	Y	Y		Y	
SET transition-variable ¹	Y			Y	
SET variable	Y	Y ⁶	Y		
SIGNAL ⁵	Y			Y	
SQL-control-statement ²	Y			Y	
TRANSFER OWNERSHIP	Y	Y		Y	
TRUNCATE	Y	Y		Y	
UPDATE	Y	Y		Y	
VALUES ¹	Y			Y	
VALUES INTO ⁵	Y	Y		Y	
WHENEVER ^{4 5}					Y

Notes:

1. This statement can only be used in the triggered action of a trigger.
2. This statement can only be used in an SQL function, SQL procedure, or SQL trigger.
3. This statement can only be used in a procedure.
4. This statement is not applicable in a Java program.
5. This statement is not supported in a REXX program.
6. The target of the SET variable statement must be a global variable.

SQL statement data access classification for routines

Indicates the level of SQL data access that must be specified to use the SQL statement in a routine.

The following table indicates whether an SQL statement (specified in the first column) is allowed to execute in a function or procedure with the specified SQL data access classification. If an executable SQL statement is encountered in a function or procedure defined with NO SQL, SQLSTATE 38001 is returned. For other executions contexts, SQL statements that are not supported in any context return SQLSTATE 38003. For other SQL statements not allowed in a CONTAINS SQL context, SQLSTATE 38004 is returned and in a READS SQL DATA context, SQLSTATE 38002 is returned. During creation of an SQL function or SQL procedure, a statement that does not match the SQL data access classification will cause SQLSTATE 42895 to be returned.

Table 130. SQL Statement and SQL Data Access Classification

SQL Statement	NO SQL	CONTAINS SQL	READS SQL DATA	MODIFIES SQL DATA
ALLOCATE CURSOR			Y	Y
ALLOCATE DESCRIPTOR			Y	Y
ALTER ...				Y
ASSOCIATE LOCATORS			Y	Y
BEGIN DECLARE SECTION	Y ¹	Y	Y	Y
CALL		Y	Y	Y
CLOSE			Y	Y
COMMENT				Y
COMMIT ³		Y	Y	Y
compound (dynamic)		Y ²	Y ²	Y
CONNECT (type 1 and type 2) ³				
CREATE ...				Y
DEALLOCATE DESCRIPTOR			Y	Y
DECLARE CURSOR	Y ¹	Y	Y	Y
DECLARE GLOBAL TEMPORARY TABLE				Y
DECLARE PROCEDURE	Y ¹	Y	Y	Y
DECLARE STATEMENT	Y ¹	Y	Y	Y
DECLARE VARIABLE	Y ¹	Y	Y	Y
DELETE				Y
DESCRIBE			Y	Y
DESCRIBE CURSOR			Y	Y
DESCRIBE INPUT			Y	Y
DESCRIBE PROCEDURE			Y	Y
DESCRIBE TABLE			Y	Y
DISCONNECT ³				

Table 130. SQL Statement and SQL Data Access Classification (continued)

SQL Statement	NO SQL	CONTAINS SQL	READS SQL DATA	MODIFIES SQL DATA
DROP ...				Y
END DECLARE SECTION	Y ¹	Y	Y	Y
EXECUTE		Y ²	Y ²	Y
EXECUTE IMMEDIATE		Y ²	Y ²	Y
FETCH			Y	Y
FREE LOCATOR		Y	Y	Y
GET DESCRIPTOR			Y	Y
GET DIAGNOSTICS		Y	Y	Y
GRANT ...				Y
HOLD LOCATOR		Y	Y	Y
INCLUDE	Y ¹	Y	Y	Y
INSERT				Y
LABEL				Y
LOCK TABLE		Y	Y	Y
MERGE				Y
OPEN			Y	Y
PREPARE		Y	Y	Y
REFRESH TABLE				Y
RELEASE CONNECTION ³				
RELEASE SAVEPOINT				Y
RENAME				Y
REVOKE ...				Y
ROLLBACK ³		Y	Y	Y
ROLLBACK TO SAVEPOINT				Y
SAVEPOINT				Y
SELECT INTO			Y	Y
SET CONNECTION ³				
SET CURRENT DEBUG MODE			Y	Y
SET CURRENT DECFLOAT ROUNDING MODE		Y	Y	Y
SET CURRENT DEGREE			Y	Y
SET CURRENT IMPLICIT XMLPARSE OPTION		Y	Y	Y
SET CURRENT TEMPORAL SYSTEM_TIME		Y	Y	Y

Table 130. SQL Statement and SQL Data Access Classification (continued)

SQL Statement	NO SQL	CONTAINS SQL	READS SQL DATA	MODIFIES SQL DATA
SET DESCRIPTOR			Y	Y
SET ENCRYPTION PASSWORD		Y	Y	Y
SET OPTION	Y ¹	Y	Y	Y
SET PATH		Y	Y	Y
SET RESULT SETS		Y	Y	Y
SET SCHEMA			Y	Y
SET SESSION AUTHORIZATION			Y	Y
SET TRANSACTION		Y	Y	Y
SET variable		Y	Y	Y
SIGNAL		Y	Y	Y
TRANSFER OWNERSHIP				Y
TRUNCATE				Y
UPDATE				Y
VALUES				
VALUES INTO			Y	Y
WHENEVER	Y ¹	Y	Y	Y

Note:

1. Although the NO SQL option implies that no SQL statements can be specified, non-executable statements are not restricted.
2. It depends on the statement being executed. The statement specified for the EXECUTE statement or any statement executed within a compound (dynamic) statement must be a statement that is allowed in the context of the particular SQL access level in effect. For example, if the SQL access level in effect is READS SQL DATA, the statement must not be an INSERT, UPDATE, or DELETE.
3. Connection management and transaction statements are not allowed in a procedure running on a remote server. COMMIT and ROLLBACK are not allowed in an ATOMIC SQL procedure.

Considerations for using distributed relational database

This section contains information that may be useful in developing applications that use application servers which are not the same product as their application requesters.

All Db2 products support extensions to IBM SQL. Some of these extensions are product-specific, but many are already shared by more than one product or support is planned but not yet generally available.

For the most part, an application can use the statements and clauses that are supported by the database manager of the current server, even though that application might be running through the application requester of a database manager that does not support some of those statements and clauses.

Restrictions to this general rule are identified by application requester:

- for Db2 for z/OS Application Server application requester, see [Table 131 on page 1651](#)
- for Db2 for i Application Server application requester, see [Table 132 on page 1652](#)
- for Db2 LUW application requester, see [Table 133 on page 1653](#).

Note that an 'R' in the table indicates that this SQL function is not supported in the specified environment. An 'R' in every column of the same row means that the function is available only if the current server and requester are the same product or that the statement is blocked by the application requester from being processed at the application server.

Table 131. Db2 for z/OS Application Requester

SQL Statement or Function	Db2 for z/OS Application Server	Db2 for i Application Server	Db2 LUW Application Server
COMMIT HOLD	R	R	R
DECLARE STATEMENT			
DECLARE TABLE			
DECLARE VARIABLE			
DESCRIBE TABLE			R
DESCRIBE with USING clause			R
DISCONNECT	R	R	R
ROWID data types			R
DATALINK data types	R	R	R
BINARY and VARBINARY data types			R
Host declarations not documented in language specific appendices		148	148
PREPARE with USING clause			R
ROLLBACK HOLD	R	R	R
SET CURRENT PACKAGESET			
SET variable		R	R
SET TRANSACTION	R	R	R
Scrollable Cursor statements	R	R	R
UPDATE cursor - FOR UPDATE clause not specified			

¹⁴⁸ The statement is supported if the application requester understands it.

Table 132. Db2 for i Application Requester

SQL Statement or Function	Db2 for z/OS Application Server	Db2 for i Application Server	Db2 LUW Application Server
COMMIT HOLD	R		R
DECLARE STATEMENT			
DECLARE TABLE			
DECLARE VARIABLE			
DESCRIBE TABLE			R
DESCRIBE with USING clause			R
DISCONNECT			
Host Variables - optional colon	R	R	R
ROWID data types			R
DATALINK data types	R		R
BINARY and VARBINARY data types			R
Host declarations not documented in language specific appendices	148		148
PREPARE with USING clause			R
ROLLBACK HOLD	R		R
SET CURRENT PACKAGESET	R	R	R
SET variable	R	R	R
SET TRANSACTION	R		R
Scrollable Cursor statements	R		R
UPDATE cursor - FOR UPDATE clause not specified	R		

Table 133. Db2 LUW application requester

SQL Statement or Function	Db2 for z/OS Application Server	Db2 for i Application Server	Db2 LUW Application Server
COMMIT HOLD	R	R	R
DECLARE STATEMENT	R	R	R
DECLARE TABLE	R	R	R
DECLARE VARIABLE	R	R	R
DESCRIBE TABLE	R	R	R
DESCRIBE with USING clause	R	R	R
DISCONNECT			
Host Variables - optional colon	R	R	R
ROWID data types	149	149	R
DATALINK data types	R	R	R
BINARY and VARBINARY data types	R	R	R
Host declarations not documented in language specific appendices	148	148	
PREPARE with USING clause	R	R	R
ROLLBACK HOLD	R	R	R
SET CURRENT PACKAGESET			
SET variable	R	R	R
SET TRANSACTION	R	R	R
Scrollable Cursor statements	R	R	R
UPDATE cursor - FOR UPDATE clause not specified	R		

¹⁴⁹ The Db2 LUW application requester application requester will process a ROWID data type at the application server using the compatible VARCHAR(40) FOR BIT DATA data type.

CONNECT (type 1) and CONNECT (type 2) differences

There are two types of CONNECT statements.

They have the same syntax, but they have different semantics:

- CONNECT (type 1) is used for remote unit of work. See “Remote unit of work” on page 37.
- CONNECT (type 2) is used for distributed unit of work. See “CONNECT (type 2)” on page 957.

The following table summarizes the differences between CONNECT (type 1) and CONNECT (type 2) rules:

Table 134. CONNECT (type 1) and CONNECT (type 2) Differences

Type 1 Rules	Type 2 Rules
CONNECT statements can only be executed when the activation group is in the connectable state. No more than one CONNECT statement can be executed within the same unit of work.	More than one CONNECT statement can be executed within the same unit of work. There are no rules about the connectable state.
If the CONNECT statement fails because the server name is not listed in the local directory, the connection state of the activation group is unchanged. If a CONNECT statement fails because the activation group is not in the connectable state, the SQL connection status of the activation group is unchanged. If a CONNECT statement fails for any other reason, the activation group is placed in the unconnected state.	If a CONNECT statement fails, the current SQL connection is unchanged and any subsequent SQL statements are executed by the current server.
CONNECT ends all existing connections of the activation group. Accordingly, CONNECT also closes any open cursors for that activation group.	CONNECT does not end connections and does not close cursors.
A CONNECT to the current server is executed like any other CONNECT (type 1) statement.	A CONNECT to the current server causes an error.

Determining the CONNECT rules that apply

A program preparation option is used to specify the type of CONNECT that will be performed by a program. The program preparation option is specified using the RDBCNNMTH parameter on the CRTSQLxxx command.

Connecting to servers that only support remote unit of work

CONNECT (type 2) connections to application servers that only support remote unit of work might result in connections that are read-only.

If a CONNECT (type 2) is performed to an application server that only supports remote unit of work:

- The connection allows read-only operations if, at the time of the connect, there are any dormant connections that allow updates. In this case, the connection does not allow updates.
- Otherwise, the connection allows updates.

If a CONNECT (type 2) is performed to an application server that supports distributed unit of work:

¹⁵⁰ Db2 for i using the initial DRDA support for native TCP/IP is an example of an application server that supports only remote unit of work.

- The connection allows read-only operations when there are dormant connections that allow updates to application servers that only support remote unit of work. In this case, the connection allows updates as soon as the dormant connection is ended.
- Otherwise, the connection allows updates.

Appendix C. SQLCA (SQL communication area)

An SQLCA is a set of variables that may be updated at the end of the execution of every SQL statement. A program that contains executable SQL statements may provide one, but no more than one SQLCA (unless a stand-alone SQLCODE or a stand-alone SQLSTATE variable is used instead), except in Java, where the SQLCA is not applicable.

Instead of using an SQLCA, the GET DIAGNOSTICS statement can be used in all languages to return return codes and other information about the previous SQL statement. For more information, see [“GET DIAGNOSTICS”](#) on page 1324.

The SQL INCLUDE statement can be used to provide the declaration of the SQLCA in all host languages except Java, RPG, or REXX. For information about the use of the SQLCA in a REXX procedure, see the [Embedded SQL Programming](#) topic collection. For information about how to access the information regarding errors and warnings in Java, refer to the [IBM Developer Kit for Java](#) topic collection.

In C, COBOL, and PL/I, the name of the storage area must be SQLCA. Every SQL statement must be within the scope of its declaration.

If a stand-alone SQLCODE or SQLSTATE is specified in the program, the SQLCA must not be included. For more information, see [“SQL diagnostic information”](#) on page 802.

The stand-alone SQLCODE and stand-alone SQLSTATE must not be specified in the Java or REXX language.

Field descriptions

The names in the following table are those provided by the SQL INCLUDE statement.

For the most part, C (and C++), COBOL, and PL/I use the same names. RPG names are different, because in RPG/400, they are limited to 6 characters. In ILE RPG, both a long name and the short 6 character name is supported. Note one instance where PL/I names differ from the COBOL names.

Table 135. Names Provided by the SQL INCLUDE Statement

C Name	COBOL Name	ILE RPG Name	Field	Field Value
PL/I Name	RPG/400 Name	Data Type		
SQLCAID sqlcaid	SQLCAID SQLAID	CHAR(8)		An "eye catcher" for storage dumps, containing 'SQLCA'.
SQLCABC sqlcabc	SQLCABC SQLABC	INTEGER		Contains the length of the SQLCA, 136.
SQLCODE sqlcode	SQLCODE SQLCOD	INTEGER		Contains an SQL return code. Code Meaning 0 Successful execution although SQLWARN indicators might have been set. positive Successful execution, but with a warning condition. negative Error condition.

Table 135. Names Provided by the SQL INCLUDE Statement (continued)

C Name COBOL Name PL/I Name	ILE RPG Name RPG/400 Name	Field Data Type	Field Value
SQLERRML ¹ sqlerrml	SQLERRML SQLERL	SMALLINT	Length indicator for SQLERRMC, in the range 0 through 70. 0 means that the value of SQLERRMC is not pertinent.
SQLERRMC ¹ sqlerrmc	SQLERRMC SQLERM	CHAR(70)	Contains message replacement text associated with the SQLCODE. For CONNECT and SET CONNECTION, the SQLERRMC field contains information about the connection, see Table 138 on page 1662 for a description of the replacement text.
SQLERRP sqlerrp	SQLERRP SQLERP	CHAR(8)	Contains the name of the product and module returning the error or warning. The first three characters identify the product: <ul style="list-style-type: none"> • ARI for Db2 for VM and VSE • DSN for Db2 for z/OS • QSQ for Db2 for i • SQL for all other Db2 products See “CONNECT (type 1)” on page 952 or “CONNECT (type 2)” on page 957 for additional information.
SQLERRD sqlerrd	SQLERRD SQLERR ²	Array	Contains six INTEGER variables that provide diagnostic information, see Table 137 on page 1660 for a description of the diagnostic information.
SQLWARN sqlwarn	SQLWARN SQLWRN ³	CHAR(11)	A set of 11 CHAR(1) warning indicators, each containing blank or 'W' or 'N'.
SQLSTATE sqlstate	SQLSTATE SQLSTT	CHAR(5)	A return code that indicates the outcome of the most recently executed SQL statement.

Notes:

1

In COBOL, SQLERRM includes SQLERRML and SQLERRMC. In PL/I, the varying-length string SQLERRM is equivalent to SQLERRML prefixed to SQLERRMC.

2

In RPG/400, SQLERR is defined as 24 characters (not an array) that are redefined by the fields SQLER1 through SQLER6. The fields are full-word binary. In ILE RPG, SQLERR is also redefined as an array. The name of the array is SQLERRD.

3

In RPG/400, SQLWRN is defined as 11 characters (not an array) that are redefined by the fields SQLWNO through SQLWNA. The fields are full-word binary. In ILE RPG, SQLWRN is also redefined as an array. The name of the array is SQLWARN.

Table 136. SQLWARN Diagnostic Information

C Name COBOL Name PL/I Name	ILE RPG Name RPG/400 Name	Field Value
SQLWARN0 sqlwarn[0]	SQLWARN(1) SQLWN0	Contains 'W' if at least one other indicator contains 'W' or 'N', it is blank if all other indicators are blank.
SQLWARN1 sqlwarn[1]	SQLWARN(2) SQLWN1	Contains 'W' if the value of a string column was truncated when assigned to a host variable. Contains 'N' if *NOCNULRQD was specified on the CRTSQLCI or CRTSQLCPPI command (or CNULRQD(*NO) on the SET OPTION statement) and if the value of a string column was assigned to a C NUL-terminated host variable and if the host variable was large enough to contain the result but not large enough to contain the NUL-terminator.
SQLWARN2 sqlwarn[2]	SQLWARN(3) SQLWN2	Contains 'W' if the null values were eliminated from the argument of a function; not necessarily set to 'W' for the MIN or MAX function because its results are not dependent on the elimination of null values.
SQLWARN3 sqlwarn[3]	SQLWARN(4) SQLWN3	Contains 'W' if the number of columns is larger than the number of host variables.
SQLWARN4 sqlwarn[4]	SQLWARN(5) SQLWN4	Contains 'W' if a prepared UPDATE or DELETE statement does not include a WHERE clause.
SQLWARN5 sqlwarn[5]	SQLWARN(6) SQLWN5	Contains a character value of 1 (read only), 2 (read and delete), or 4 (read, delete, and update) to reflect capability of a cursor after the OPEN statement.
SQLWARN6 sqlwarn[6]	SQLWARN(7) SQLWN6	Contains 'W' if date arithmetic results in an end-of-month adjustment.
SQLWARN7 sqlwarn[7]	SQLWARN(8) SQLWN7	Reserved
SQLWARN8 sqlwarn[8]	SQLWARN(9) SQLWN8	Contains 'W' if the result of a character conversion contains the substitution character.
SQLWARN9 sqlwarn[9]	SQLWARN(10) SQLWN9	Reserved
SQLWARNA sqlwarn[10]	SQLWARN(11) SQLWNA	Reserved

Table 137. SQLERRD Diagnostic Information

C Name COBOL Name PL/I Name	ILE RPG Name RPG/400 Name	Field Value
SQLERRD(1) sqlerrd[0]	SQLERRD(1) SQLER1	<p>Contains the last four characters of the CPF escape message if SQLCODE is less than 0. For example, if the message is CPF5715, X'F5F7F1F5' is placed in SQLERRD(1).¹</p> <p>For a call to a procedure, contains the return status value specified on the RETURN statement. If a return status value is not specified on the RETURN statement or the procedure is an external procedure,</p> <ul style="list-style-type: none"> • 0 is returned if the CALL statement is successful, or • -1 is returned if the CALL statement is not successful.
SQLERRD(2) sqlerrd[1]	SQLERRD(2) SQLER2	<p>Contains the last four characters of a CPD diagnostic message if the SQL code is less than 0.¹</p> <p>For a CALL statement, SQLERRD(2) contains the number of result sets.</p> <p>For an OPEN statement, if the cursor is insensitive to changes, SQLERRD(2) contains the actual number of rows in the result set. If the cursor is sensitive to changes, SQLERRD(2) contains an estimated number of rows in the result set.</p>
SQLERRD(3) sqlerrd[2]	SQLERRD(3) SQLER3	<p>For a CONNECT for status statement, SQLERRD(3) contains information about the connection status. See “CONNECT (type 2)” on page 957 for more information.</p> <p>For INSERT, MERGE, UPDATE, REFRESH, and DELETE, shows the number of rows affected.</p> <p>For a TRUNCATE statement, the value will be -1.</p> <p>For a FETCH statement, SQLERRD(3) contains the number of rows fetched.</p> <p>For the PREPARE statement, contains the estimated number of rows selected. If the number of rows is greater than 2 147 483 647, then 2 147 483 647 is returned.</p>

Table 137. SQLERRD Diagnostic Information (continued)

C Name COBOL Name PL/I Name	ILE RPG Name RPG/400 Name	Field Value
SQLERRD(4) sqlerrd[3]	SQLERRD(4) SQLER4	<p>For the PREPARE statement, contains a relative number estimate of the resources required for every execution. This number varies depending on the current availability of indexes, file sizes, CPU model, etc. It is an estimated cost for the access plan chosen by the Db2 for i Query Optimizer.</p> <p>For a CONNECT and SET CONNECTION statement, SQLERRD(4) contains the type of conversation used and whether or not committable updates can be performed. See “CONNECT (type 2)” on page 957 for more information.</p> <p>For a CALL statement, SQLERRD(4) contains the message key of the error that caused the procedure to fail. The QMHRTVPM API can be used to return the message description for the message key.</p> <p>For a trigger error in a DELETE, INSERT MERGE, or UPDATE statement, SQLERRD(4) contains the message key of the error that was signaled from the trigger program. The QMHRTVPM API can be used to return the message description for the message key.</p> <p>For a FETCH statement, if the result row does not contain a LOB, SQLERRD(4) contains the length of the row(s) retrieved.</p> <p>For an OPEN statement, if the result row does not contain a LOB, SQLERRD(4) contains the length of a result row.</p>
SQLERRD(5) sqlerrd[4]	SQLERRD(5) SQLER5	<p>For a CONNECT or SET CONNECTION statement, SQLERRD(5) contains:</p> <ul style="list-style-type: none"> • -1 if the connection is unconnected • 0 if the connection is local • 1 if the connection is remote <p>For a DELETE, INSERT, MERGE, or UPDATE statement, shows the number of rows affected by referential constraints and triggers.</p> <p>For an EXECUTE IMMEDIATE or PREPARE statement, may contain the position of a syntax error.</p> <p>For a multiple-row FETCH statement, SQLERRD(5) contains +100 if the last row currently in the table has been fetched.</p> <p>For a PREPARE statement, SQLERRD(5) contains the number of parameter markers in the prepared statement.</p>
SQLERRD(6) sqlerrd[5]	SQLERRD(6) SQLER6	<p>Contains the SQL completion message identifier when the SQLCODE is 0.</p> <p>In all other cases, it is undefined.</p>

Note:

1

SQLERRD(1) and SQLERRD(2) are set only if appropriate and only if the current server is Db2 for i.

Table 138. SQLERRMC Replacement Text for CONNECT and SET CONNECTION

Description	Data type
Relational Database Name	CHAR(18)
Product Identification (same as SQLERRP)	CHAR(8)
User ID of the server job	CHAR(10)
Connection method (*DUW or *RUW)	CHAR(10)
DDM server class name	CHAR(10)
QAS	
Db2 for i	
QDB2	
Db2 for z/OS	
QDB2/6000	
Db2 for AIX	
QDB2/HPUX	
Db2 for HP-UX**	
QDB2/LINUX	
Db2 for Linux®	
QDB2/NT	
Db2 for Windows** NT, 2000, and XP	
QDB2/SUN	
Db2 for SUN** Solaris**	
QSQLDS/VM	
Db2 Server for VM	
QSQLDS/VSE	
Db2 Server for VSE	
Connection type (same as SQLERRD(4))	SMALLINT

INCLUDE SQLCA declarations

This section shows the equivalent INCLUDE SQLCA declaration for C and C++, COBOL, PL/I, RPG/400, and ILE RPG.

In **C and C++**, INCLUDE SQLCA declarations are equivalent to the following:

```
#ifndef    SQLCODE
struct    sqlca
{
    unsigned char    sqlcaid[8];
    long            sqlcabc;
    long            sqlcode;
    short           sqlerrml;
    unsigned char    sqlerrmc[70];
    unsigned char    sqlerrp[8];
    long            sqlerrd[6];
    unsigned char    sqlwarn[11];
    unsigned char    sqlstate[5];
};
#define    SQLCODE    sqlca.sqlcode
#define    SQLWARN0    sqlca.sqlwarn[0]
#define    SQLWARN1    sqlca.sqlwarn[1]
#define    SQLWARN2    sqlca.sqlwarn[2]
#define    SQLWARN3    sqlca.sqlwarn[3]
#define    SQLWARN4    sqlca.sqlwarn[4]
#define    SQLWARN5    sqlca.sqlwarn[5]
#define    SQLWARN6    sqlca.sqlwarn[6]
#define    SQLWARN7    sqlca.sqlwarn[7]
#define    SQLWARN8    sqlca.sqlwarn[8]
#define    SQLWARN9    sqlca.sqlwarn[9]
#define    SQLWARNA    sqlca.sqlwarn[10]
#define    SQLSTATE    sqlca.sqlstate
#endif
struct sqlca sqlca;
```

In **COBOL**, INCLUDE SQLCA declarations are equivalent to the following:

```
01 SQLCA.
  05 SQLCAID      PIC X(8).
  05 SQLCABC      PIC S9(9) BINARY.
  05 SQLCODE      PIC S9(9) BINARY.
  05 SQLERRM.
    49 SQLERRML   PIC S9(4) BINARY.
    49 SQLERRMC   PIC X(70).
  05 SQLERRP      PIC X(8).
  05 SQLERRD      OCCURS 6 TIMES
                  PIC S9(9) BINARY.
  05 SQLWARN.
    10 SQLWARN0   PIC X(1).
    10 SQLWARN1   PIC X(1).
    10 SQLWARN2   PIC X(1).
    10 SQLWARN3   PIC X(1).
    10 SQLWARN4   PIC X(1).
    10 SQLWARN5   PIC X(1).
    10 SQLWARN6   PIC X(1).
    10 SQLWARN7   PIC X(1).
    10 SQLWARN8   PIC X(1).
    10 SQLWARN9   PIC X(1).
    10 SQLWARNA   PIC X(1).
  05 SQLSTATE     PIC X(5).
```

Note: In COBOL, INCLUDE SQLCA must not be specified outside the Working Storage Section.

In **PL/I**, INCLUDE SQLCA declarations are equivalent to the following:

```
DCL 1 SQLCA,
  2 SQLCAID      CHAR(8),
  2 SQLCABC      BIN FIXED(31),
  2 SQLCODE      BIN FIXED(31),
  2 SQLERRM      CHAR(70) VAR,
  2 SQLERRP      CHAR(8),
```

```
2 SQLERRD(6)    BIN FIXED(31),
2 SQLWARN,
3 SQLWARN0     CHAR(1),
3 SQLWARN1     CHAR(1),
3 SQLWARN2     CHAR(1),
3 SQLWARN3     CHAR(1),
3 SQLWARN4     CHAR(1),
3 SQLWARN5     CHAR(1),
3 SQLWARN6     CHAR(1),
3 SQLWARN7     CHAR(1),
3 SQLWARN8     CHAR(1),
3 SQLWARN9     CHAR(1),
3 SQLWARNA     CHAR(1),
2 SQLSTATE     CHAR(5);
```

In **RPG/400**; SQLCA declarations are equivalent to the following:

ISQLCA	DS				
I		1	8	SQLAID	SQL
I		B 9	120	SQLABC	SQL
I		B 13	160	SQLCOD	SQL
I		B 17	180	SQLERL	SQL
I		19	88	SQLERM	SQL
I		89	96	SQLERP	SQL
I		97	120	SQLERR	SQL
I		B 97	1000	SQLER1	SQL
I		B 101	1040	SQLER2	SQL
I		B 105	1080	SQLER3	SQL
I		B 109	1120	SQLER4	SQL
I		B 113	1160	SQLER5	SQL
I		B 117	1200	SQLER6	SQL
I		121	131	SQLWRN	SQL
I		121	121	SQLWN0	SQL
I		122	122	SQLWN1	SQL
I		123	123	SQLWN2	SQL
I		124	124	SQLWN3	SQL
I		125	125	SQLWN4	SQL
I		126	126	SQLWN5	SQL
I		127	127	SQLWN6	SQL
I		128	128	SQLWN7	SQL
I		129	129	SQLWN8	SQL
I		130	130	SQLWN9	SQL
I		131	131	SQLWNA	SQL
I		132	136	SQLSTT	SQL

In **ILE RPG**; SQLCA declarations are equivalent to the following:

```
// SQL COMMUNICATION AREA
DCL-DS SQLCA;
SQLCAID CHAR(8) INZ('0000000000000000');
SQLAID CHAR(8) OVERLAY(SQLCAID);
SQLCABC INT(10);
SQLABC BINDEC(9) OVERLAY(SQLCABC);
SQLCODE INT(10);
SQLCOD BINDEC(9) OVERLAY(SQLCODE);
SQLERRML INT(5);
SQLERL BINDEC(4) OVERLAY(SQLERRML);
SQLERRMC CHAR(70);
SQLERM CHAR(70) OVERLAY(SQLERRMC);
SQLERP CHAR(8);
SQLERP CHAR(8) OVERLAY(SQLERP);
SQLERR CHAR(24);
SQLER1 BINDEC(9) OVERLAY(SQLERR:*NEXT);
SQLER2 BINDEC(9) OVERLAY(SQLERR:*NEXT);
SQLER3 BINDEC(9) OVERLAY(SQLERR:*NEXT);
SQLER4 BINDEC(9) OVERLAY(SQLERR:*NEXT);
SQLER5 BINDEC(9) OVERLAY(SQLERR:*NEXT);
SQLER6 BINDEC(9) OVERLAY(SQLERR:*NEXT);
SQLERRD INT(10) DIM(6) OVERLAY(SQLERR);
SQLWRN CHAR(11);
SQLWN0 CHAR(1) OVERLAY(SQLWRN:*NEXT);
SQLWN1 CHAR(1) OVERLAY(SQLWRN:*NEXT);
SQLWN2 CHAR(1) OVERLAY(SQLWRN:*NEXT);
SQLWN3 CHAR(1) OVERLAY(SQLWRN:*NEXT);
SQLWN4 CHAR(1) OVERLAY(SQLWRN:*NEXT);
SQLWN5 CHAR(1) OVERLAY(SQLWRN:*NEXT);
SQLWN6 CHAR(1) OVERLAY(SQLWRN:*NEXT);
SQLWN7 CHAR(1) OVERLAY(SQLWRN:*NEXT);
SQLWN8 CHAR(1) OVERLAY(SQLWRN:*NEXT);
SQLWN9 CHAR(1) OVERLAY(SQLWRN:*NEXT);
SQLWNA CHAR(1) OVERLAY(SQLWRN:*NEXT);
SQLWARN CHAR(1) DIM(11) OVERLAY(SQLWRN);
SQLSTATE CHAR(5);
SQLSTT CHAR(5) OVERLAY(SQLSTATE);
END-DS SQLCA;
```

Appendix D. SQLDA (SQL descriptor area)

An SQLDA is a set of variables that is used for execution of the SQL DESCRIBE statement, and it may optionally be used by the PREPARE, OPEN, CALL, FETCH, and EXECUTE statements.

An SQLDA can be used in a DESCRIBE or PREPARE statement, altered with the addresses of storage areas¹⁵¹, and then used again in a FETCH statement.

SQLDAs are supported for all languages, but predefined declarations are provided only for C (and C++), COBOL, ILE RPG, PL/I, and REXX. In REXX, the SQLDA is somewhat different than in the other languages; for information about the use of SQLDAs in REXX, see the [Embedded SQL Programming](#) topic collection.

The meaning of the information in an SQLDA depends on its use.

- When an SQLDA is used in a DESCRIBE or PREPARE statement, an SQLDA provides information to an application program about a prepared *select-statement*. Each column of the result table is described in an SQLVAR occurrence or set of related SQLVAR occurrences.
- In OPEN, EXECUTE, CALL, and FETCH, an SQLDA provides information to the database manager about storage areas for input or output data. Each storage area is described in the SQLVARs.
 - For OPEN and EXECUTE of a statement other than CALL, each SQLVAR occurrence or set of related SQLVAR occurrences describes a storage area that is used to contain an input value which is substituted for a parameter marker in the associated SQL statement that was previously prepared.
 - For FETCH, each SQLVAR occurrence or set of related SQLVAR occurrences describes a storage area that is used to contain an output value from a row of the result table.
 - For CALL and EXECUTE of a prepared CALL statement, each SQLVAR occurrence or set of related SQLVAR occurrences describes a storage area that is used to contain an input or output value (or both) that corresponds to an argument in the argument list for the procedure.

An SQLDA consists of four variables in a header followed by an arbitrary number of occurrences of a *base SQLVAR*. When the SQLDA describes either LOBs or distinct types the base SQLVARs are followed by the same number of occurrences of an *extended SQLVAR*.

Base SQLVAR entry

The base SQLVAR entry is always present. The fields of this entry contain the base information about the column or variable such as data type code, length attribute (except for LOBs), column name (or label), CCSID, variable address, and indicator variable address.

Extended SQLVAR entry

The extended SQLVAR entry is needed (for each column) if the result includes any LOB or distinct type columns. For distinct types, the extended SQLVAR contains the distinct type name. For LOBs, the extended SQLVAR contains the length attribute of the variable and a pointer to the buffer that contains the actual length. If locators or file reference variables are used to represent LOBs, an extended SQLVAR is not necessary.

The extended SQLVAR entry is also needed for each column when:

- USING BOTH is specified, which indicates that column names and labels are returned.
- USING ALL is specified, which indicates that column names, labels, and system column names are returned.

The fields in the extended SQLVAR that return LOB and distinct type information do not overlap, and the fields that return LOB and label information do not overlap. Depending on the combination of labels, LOBs and distinct types, more than one extended SQLVAR entry per column may be required to return the information. See [“Determining how many SQLVAR occurrences are needed”](#) on page 1670.

¹⁵¹ A storage area could be the storage for a variable defined in the program (that may also be a host variable) or an area of storage explicitly allocated by the application.

Field descriptions in an SQLDA header

An SQLDA consists of four variables in a header structure followed by an arbitrary number of occurrences of a sequence of five variables collectively named SQLVAR. In OPEN, CALL, FETCH, and EXECUTE, each occurrence of SQLVAR describes a variable. In PREPARE and DESCRIBE, each occurrence describes a column of a result table.

The SQL INCLUDE statement provides the following field names:

Table 139. Field Descriptions for an SQLDA Header

C Name ¹⁵² PL/I Name COBOL Name	Field Data Type	Usage in DESCRIBE and PREPARE (set by the database manager except for SQLN)	Usage in FETCH, OPEN, CALL, or EXECUTE (set by the user prior to executing the statement)
sqldaid SQLDAID	CHAR(8)	An 'eye catcher' for storage dumps, containing 'SQLDA '. The 7th byte of the SQLDAID can be used to determine whether more than one SQLVAR entry is needed for each column. For details, see “Determining how many SQLVAR occurrences are needed” on page 1670.	A '2' in the 7th byte indicates that two SQLVAR entries were allocated for each column. A '3' in the 7th byte indicates that three SQLVAR entries were allocated for each column. A '4' in the 7th byte indicates that four SQLVAR entries were allocated for each column.
sqldabc SQLDABC	INTEGER	Length of the SQLDA.	Number of bytes of storage allocated for the SQLDA. Enough storage must be allocated to contain SQLN occurrences. SQLDABC must be set to a value greater than or equal to $16+SQLN*(80)$, where 80 is the length of an SQLVAR occurrence. If LOBs or distinct types are specified, there must be two SQLVAR entries for each parameter marker.
sqln SQLN	SMALLINT	Unchanged by the database manager. Must be set to a value greater than or equal to zero before the PREPARE or DESCRIBE statement is executed. It should be set to a value that is greater than or equal to the number of columns in the result or a multiple of the number of columns in the result when multiple sets of SQLVAR entries are necessary. Indicates the total number of occurrences of SQLVAR.	Total number of occurrences of SQLVAR provided in the SQLDA. SQLN must be set to a value greater than or equal to zero. If LOBs or distinct types are specified, there must be two SQLVAR entries for each parameter marker and SQLN must be set to two times the number of parameter markers.

¹⁵² In this column, the lowercase name is the C Name. The uppercase name is the COBOL, PL/I, or RPG Name.

Table 139. Field Descriptions for an SQLDA Header (continued)

C Name ¹⁵² PL/I Name COBOL Name	Field Data Type	Usage in DESCRIBE and PREPARE (set by the database manager except for SQLN)	Usage in FETCH, OPEN, CALL, or EXECUTE (set by the user prior to executing the statement)
sqld SQLD	SMALLINT	The number of columns described by occurrences of SQLVAR (zero if the statement being described is not a select-statement, CALL, or VALUES INTO).	Number of occurrences of SQLVAR entries in the SQLDA that are used when executing the statement. SQLD must be set to a value greater than or equal to zero and less than or equal to SQLN.

Determining how many SQLVAR occurrences are needed

The number of SQLVAR occurrences needed depends on the statement that the SQLDA was provided for and the data types of the columns or parameters being described. See the tables above for more information.

The 7th byte of SQLDAID is always set to the number of sets of SQLVARs necessary when LOBs or UDTs are in the result set.

If SQLD is not set to a sufficient number of SQLVAR occurrences:

- When LOBs and UDTs are not in the result set, SQLD is set to the total number of SQLVAR occurrences needed for all sets. When there are LOBs or UDTs in the result set, SQLD is set to the number of columns in the result table and the seventh byte of SQLDAID indicates the number of sets of SQLVAR entries needed. The number of required SQLVAR entries can always be determined by multiplying SQLD by the value in the seventh byte of SQLDAID.
- A warning (SQLSTATE 01594) is returned if at least enough SQLVARs were specified for the Base SQLVAR Entries. The Base SQLVAR entries are returned, but no extended SQLVARs are returned.
- A warning (SQLSTATE 01005) is returned if enough SQLVARs were not specified for even the Base SQLVAR Entries. No SQLVAR entries are returned.¹⁵³

Table 140 on page 1671, Table 141 on page 1671, and Table 142 on page 1671 show how to map the base and extended SQLVAR entries. For an SQLDA that contains both base and extended SQLVAR entries, the base SQLVAR entries are in the first block, followed by a block of extended SQLVAR entries, which if necessary, are followed by a second or third block of extended SQLVAR entries. In each block, the number of occurrences of the SQLVAR entry is equal to the value in SQLD even though many of the extended SQLVAR entries might be unused.

¹⁵³ If LOBs or UDTs are not in the result set, the warning is only returned if the standards option is specified. For information about the standards option, see [“Standards compliance” on page xix](#).

Table 140. Contents of SQLVAR Arrays for USING NAMES, USING SYSTEM NAMES, USING LABELS or USING ANY

LOBs	DISTINCT types	7th byte of SQLDAID	SQLN Minimum	First Set (Base)	Second Set (Extended)	Third Set (Extended)	Fourth Set (Extended)
No	No	Blank	n	Column names, system column names, or labels	Not used	Not used	Not used
Yes	No	2	2n	Column names, system column names, or labels	LOBs	Not used	Not used
No	Yes	2	2n	Column names, system column names, or labels	Distinct types	Not used	Not used
Yes	Yes	2	2n	Column names, system column names, or labels	LOBs and distinct types	Not used	Not used

Table 141. Contents of SQLVAR Arrays for USING BOTH

LOBs	DISTINCT types	7th byte of SQLDAID	SQLN Minimum	First Set (Base)	Second Set (Extended)	Third Set (Extended)	Fourth Set (Extended)
No	No	2	2n	Column names	Labels	Not used	Not used
Yes	No	2	2n	Column names	LOBs and labels	Not used	Not used
No	Yes	3	3n	Column names	Distinct types	Labels	Not used
Yes	Yes	3	3n	Column names	LOBs and distinct types	Labels	Not used

Table 142. Contents of SQLVAR Arrays for USING ALL

LOBs	DISTINCT types	7th byte of SQLDAID	SQLN Minimum	First Set (Base)	Second Set (Extended)	Third Set (Extended)	Fourth Set (Extended)
No	No	3	3n	System column names	Labels	Column names	Not used

Table 142. Contents of SQLVAR Arrays for USING ALL (continued)

LOBs	DISTINCT types	7th byte of SQLDAID	SQLN Minimum	First Set (Base)	Second Set (Extended)	Third Set (Extended)	Fourth Set (Extended)
Yes	No	3	3n	System column names	LOBs and labels	Column names	Not used
No	Yes	4	4n	System column names	Distinct types	Labels	Column names
Yes	Yes	4	4n	System column names	LOBs and distinct types	Labels	Column names

Field descriptions in an occurrence of SQLVAR

This section includes field descriptions in an occurrence of a base and secondary SQLVAR.

Fields in an occurrence of a base SQLVAR

Table 143. Field Descriptions for an SQLVAR

C Name ¹⁵⁴ COBOL Name PL/I Name RPG Name	Field Data Type	Usage in DESCRIBE and PREPARE (set by the database manager)	Usage in FETCH, OPEN, CALL, and EXECUTE (set by the user prior to executing the statement)
sqltype SQLTYPE	SMALLINT	Indicates the data type of the column and whether it can contain nulls. For a description of the type codes, see Table 145 on page 1677 . For a distinct type, the data type on which the distinct type is based is placed in this field. The base SQLVAR contains no indication that this is part of the description of a distinct type.	Indicates the data type of the host variable and whether an indicator variable is provided. For a description of the type codes, see Table 145 on page 1677 .
sqllen SQLLEN	SMALLINT	The length attribute of the column. For datetime columns, the length of the string representation of the values. See Table 145 on page 1677 . For a LOB, the value is 0 regardless of the length attribute of the LOB. For XML, the value is 0. Field SQLLONGLEN in the extended SQLVAR entry contains the length attribute of the LOB or XML.	The length attribute of the host variable. See Table 145 on page 1677 . For a LOB, the value is 0 regardless of the length attribute of the LOB. Field SQLLONGLEN in the extended SQLVAR entry contains the length attribute of the LOB. For XML AS BLOB, CLOB, or DBCLOB, the value is 0.
sqlres SQLRES	CHAR(12)	Reserved. Provides boundary alignment for SQLDATA.	Reserved. Provides boundary alignment for SQLDATA.
sqldata SQLDATA	pointer	The CCSID of a string column or XML column as described in Table 146 on page 1680 .	Contains the address of the host variable. For LOB host variables, if the SQLDATALEN field in the extended SQLVAR is null, this points to the four-byte LOB length, followed immediately by the LOB data. If the SQLDATALEN field in the extended SQLVAR is not null, this points to the LOB data and the SQLDATALEN field points to the four-byte LOB length.

¹⁵⁴ In this column, the lowercase name is the C Name. The uppercase name is the PL/I, COBOL, and RPG Name.

Table 143. Field Descriptions for an SQLVAR (continued)

C Name ¹⁵⁴ COBOL Name PL/I Name RPG Name	Field Data Type	Usage in DESCRIBE and PREPARE (set by the database manager)	Usage in FETCH, OPEN, CALL, and EXECUTE (set by the user prior to executing the statement)
sqlind SQLIND	pointer	<p>For a select-statement, indicates whether the column was added as a result of using the WITH ROW CHANGE COLUMNS attribute:</p> <ul style="list-style-type: none"> • -1 ROW CHANGE TOKEN (distinct) • -2 ROW CHANGE TOKEN (not distinct) • -3 RID • -4 RID_BIT <p>Otherwise, reserved.</p>	<p>Contains the address of the indicator variable. Not used if there is no indicator variable (as indicated by an even value of SQLTYPE).</p>
sqlname SQLNAME	VARCHAR(30)	<p>The unqualified name of the column. If the column does not have a name, a string is constructed from the expression and returned.</p> <p>The name is case sensitive and does not contain surrounding delimiters.</p>	<p>Contains the CCSID of the host variable as described in Table 146 on page 1680.</p> <p>For XML data, sqlname can be set as follows to indicate as XML subtype:</p> <p>The length of sqlname is 8</p> <p>Bytes 1 and 2: Must be X'0000'.</p> <p>Bytes 3 and 4: May contain a CCSID.</p> <p>Bytes 5 and 6 X'0100' XML host variable (XML AS CLOB, XML AS DBCLOB, XML AS BLOB, XML AS CLOB_FILE, XML AS DBCLOB_FILE, XML AS BLOB_FILE)</p> <p>Bytes 7 and 8: Must be X'0000'.</p>

Fields in an occurrence of a secondary SQLVAR

Table 144. Field Descriptions for an Extended SQLVAR

C Name ¹⁵⁵ COBOL Name PL/I Name RPG Name	Field Data Type	Usage in DESCRIBE and PREPARE (set by the database manager)	Usage in FETCH, OPEN, CALL, and EXECUTE (set by the user prior to executing the statement)
len.sqllonglen SQLLONGL SQLLONGLEN	INTEGER	The length attribute of a LOB column. For XML, the value is 0.	The length attribute of a LOB or XML host variable. The database manager ignores the SQLLEN field in the base SQLVAR for these data types. The length attribute indicates the number of bytes for a BLOB, and the number of characters for a CLOB, DBCLOB, or for XML.
*	CHAR(12)	Reserved. Provides boundary alignment for SQLDATALEN.	Reserved. Provides boundary alignment for SQLDATALEN.
*	pointer	Reserved.	Reserved.
sqldatalen SQLDATAL SQLDATALEN	pointer	Not used.	Used only for LOB host variables. If the value of this field is not null, this field points to a four-byte long buffer that contains the actual length of the LOB in bytes (even for DBCLOBs). The SQLDATA field in the matching base SQLVAR then points to the LOB data. If the value of this field is null, the actual length of the LOB is stored in the first four bytes pointed to by the SQLDATA field in the matching base SQLVAR, and the LOB data immediately follows the four-byte length. The actual length indicates the number of bytes for a BLOB or CLOB and the number of double-byte characters for a DBCLOB. Regardless of whether this field is used, field SQLLONGLEN must be set.

¹⁵⁵ In this column, the lowercase name is the C Name. The first uppercase name is the PL/I and RPG Name. The second uppercase name is the COBOL Name.

Table 144. Field Descriptions for an Extended SQLVAR (continued)

C Name ¹⁵⁵	COBOL Name	PL/I Name	RPG Name	Field Data Type	Usage in DESCRIBE and PREPARE (set by the database manager)	Usage in FETCH, OPEN, CALL, and EXECUTE (set by the user prior to executing the statement)
sqldatatype_name SQLTNAM SQLDATATYPE-NAME	VARCHAR (30)	The SQLTNAM field of the extended SQLVAR is set to one of the following:	Not used.	<ul style="list-style-type: none"> • For a distinct type column, the database manager sets this to the fully qualified distinct type name. If the qualified name is longer than 30 bytes, it is truncated. • For a label, the database manager sets this to the first 20 bytes of the label. • For a column name, the database manager sets this to the column name. 		

SQLTYPE and SQLLEN

The following table shows the values that may appear in the SQLTYPE and SQLLEN fields of the SQLDA. In PREPARE and DESCRIBE, an even value of SQLTYPE means the column does not allow nulls, and an odd value means the column does allow nulls.

Note: In an SQLDA used in DESCRIBE or PREPARE statements, an odd value is returned for an expression if one operand is nullable or if the expression may result in a -2 mapping-error null value.

In FETCH, OPEN, CALL, and EXECUTE, an even value of SQLTYPE means no indicator variable is provided, and an odd value means that SQLIND contains the address of an indicator variable.

Table 145. SQLTYPE and SQLLEN values for PREPARE, DESCRIBE, FETCH, OPEN, CALL, or EXECUTE

SQLTYPE	For PREPARE and DESCRIBE		For FETCH, OPEN, CALL, and EXECUTE	
	COLUMN DATA TYPE	SQLLEN	HOST VARIABLE DATA TYPE	SQLLEN
384/385	Date ¹⁵⁸	10	Fixed-length character-string representation of a date	Length attribute of the host variable
388/389	Time	8	Fixed-length character-string representation of a time	Length attribute of the host variable
392/393	Timestamp	19 for TIMESTAMP(0) otherwise 20+p for TIMESTAMP(p)	Fixed-length character-string representation of a timestamp	Length attribute of the host variable
396/397	DataLink	Length attribute of the column	DataLink	Length attribute of the host variable
400/401	Not Applicable	Not Applicable	NUL-terminated graphic string	Length attribute of the host variable
404/405	BLOB	0 ¹⁵⁷	BLOB	Not used. ¹⁵⁷
408/409	CLOB	0 ¹⁵⁷	CLOB	Not used. ¹⁵⁷
412/413	DBCLOB	0 ¹⁵⁷	DBCLOB	Not used. ¹⁵⁷
448/449	Varying-length character string	Length attribute of the column	Varying-length character string	Length attribute of the host variable
452/453	Fixed-length character string	Length attribute of the column	Fixed-length character string	Length attribute of the host variable
456/457	Long varying-length character string	Length attribute of the column	Long varying-length character string	Length attribute of the host variable
460/461	Not Applicable	Not Applicable	NUL-terminated character string	Length attribute of the host variable
464/465	Varying-length graphic string	Length attribute of the column	Varying-length graphic string	Length attribute of the host variable
468/469	Fixed-length graphic string	Length attribute of the column	Fixed-length graphic string	Length attribute of the host variable

Table 145. *SQLTYPE* and *SQLLEN* values for *PREPARE*, *DESCRIBE*, *FETCH*, *OPEN*, *CALL*, or *EXECUTE* (continued)

SQLTYPE	For PREPARE and DESCRIBE		For FETCH, OPEN, CALL, and EXECUTE	
	COLUMN DATA TYPE	SQLLEN	HOST VARIABLE DATA TYPE	SQLLEN
472/473	Long varying-length graphic string	Length attribute of the column	Long graphic string	Length attribute of the host variable
476/477	Not Applicable	Not Applicable	PASCAL L-string	Length attribute of the host variable
480/481	Floating point	4 for single precision, 8 for double precision	Floating point	4 for single precision, 8 for double precision
484/485	Packed decimal	Precision in byte 1; scale in byte 2	Packed decimal	Precision in byte 1; scale in byte 2
488/489	Zoned decimal	Precision in byte 1; scale in byte 2	Zoned decimal	Precision in byte 1; scale in byte 2
492/493	Big integer	8 ¹⁵⁶	Big integer	8
496/497	Large integer	4 ¹⁵⁶	Large integer	4
500/501	Small integer	2 ¹⁵⁶	Small integer	2
504/505	Not Applicable	Not Applicable	DISPLAY SIGN LEADING SEPARATE	Precision in byte 1; scale in byte 2
904/905	ROWID	40	ROWID	40
908/909	Varying-length binary string	Length attribute of the column	Varying-length binary string	Length attribute of the host variable
912/913	Fixed-length binary string	Length attribute of the column	Fixed-length binary string	Length attribute of the host variable
916/917	Not Applicable	Not Applicable	BLOB file reference variable	267
920/921	Not Applicable	Not Applicable	CLOB file reference variable	267
924/925	Not Applicable	Not Applicable	DBCLOB file reference variable	267
960/961	Not Applicable	Not Applicable	BLOB locator	4
964/965	Not Applicable	Not Applicable	CLOB locator	4
968/969	Not Applicable	Not Applicable	DBCLOB locator	4
972	Not Applicable	Not Applicable	Result set locator	8
988/989	XML	0	Not Applicable. Use XML AS CLOB, XML AS DBCLOB, or XML AS BLOB	0
996/997	Not Applicable DECFLOAT(16) DECFLOAT(34)	Not Applicable 8 16	DECFLOAT(7) ¹⁵⁹ DECFLOAT(16) DECFLOAT(34)	4 8 16

Table 145. *SQLTYPE* and *SQLLEN* values for *PREPARE*, *DESCRIBE*, *FETCH*, *OPEN*, *CALL*, or *EXECUTE* (continued)

SQLTYPE	For PREPARE and DESCRIBE		For FETCH, OPEN, CALL, and EXECUTE	
	COLUMN DATA TYPE	SQLLEN	HOST VARIABLE DATA TYPE	SQLLEN
2452/2453	Not Applicable	Not Applicable	XML locator	4

¹⁵⁶ Binary numbers can be represented in the SQLDA with a length of 2, 4, or 8, or with the precision in byte 1 and the scale in byte 2. If the first byte is greater than x'00', it indicates precision and scale.

¹⁵⁷ Field SQLLONGLEN in the extended SQLVAR contains the length attribute of the column.

¹⁵⁸ Less for *JUL, *YMD, *DMY, and *MDY formats. For more information, see [Table 8 on page 76](#)

¹⁵⁹ Db2 does not internally store DECFLOAT(7) numbers, but it will support DECFLOAT(7) numbers from applications. A DECFLOAT(7) variable referenced in an SQL statement will be converted to DECFLOAT(16).

CCSID values in SQLDATA or SQLNAME

In the OPEN, FETCH, CALL, and EXECUTE statements, the SQLNAME field of the SQLVAR element can be used to specify a CCSID for string host variables. If the SQLNAME field is used to specify a CCSID, the SQLNAME length must be set to 8. In addition, the first 4 bytes of SQLNAME must be set as described in the table below. If no CCSID is specified, the job CCSID is used.

In the DESCRIBE, DESCRIBE TABLE, and PREPARE statements, the SQLDATA field of the SQLVAR element contains the CCSID of the column of the result table if that column is a string column. The CCSID is located in bytes 3 and 4 as described in [Table 146 on page 1680](#).

Table 146. CCSID values for SQLDATA or SQLNAME

Data Type	Encoding Scheme	Bytes 1 & 2	Bytes 3 & 4
Character	SBCS data	X'0000'	ccsid
Character	Mixed data	X'0000'	ccsid
Character	Bit data	X'0000'	65535
Graphic	Not Applicable	X'0000'	ccsid
Any other data type	Not Applicable	Not Applicable	Not Applicable

Unrecognized and unsupported SQLTYPES

The values that appear in the SQLTYPE field of the SQLDA are dependent on the level of data type support available at the sender as well as the receiver of the data. This is particularly important as new data types are added to the product.

New data types may or may not be supported by the sender or receiver of the data and may or may not even be recognized by the sender or receiver of the data. Depending on the situation, the new data type may be returned, or a compatible data type agreed upon by both the sender and receiver of the data may be returned or an error may result.

When the sender and receiver agree to use a compatible data type, the following indicates the mapping that will take place. This mapping will take place when at least one of the sender or receiver does not support the data type provided. The unsupported data type can be provided by either the application or the database manager.

Table 147. Compatible Data Types for Unsupported Data Types

Data Type	Compatible Data Type
BIGINT	DECIMAL(19,0)
ROWID	VARCHAR(40) FOR BIT DATA
TIMESTAMP(n)	TIMESTAMP(6)

INCLUDE SQLDA declarations

This section shows the equivalent INCLUDE SQLDA declaration for C and C++, COBOL, ILE COBOL, PL/I, and ILE RPG.

For C and C++

In C and C++, INCLUDE SQLDA declarations are equivalent to the following:

```
#ifndef SQLDASIZE
struct sqlda
{
    unsigned char  sqldaaid[8];
    long          sqldabc;
    short         sqln;
    short         sqld;
    struct sqlvar
    {
        short      sqltype;
        short      sqlen;
        union {
            unsigned char *sqldata;
            long long sqld_result_set_locator; };
        union {
            short *sqlind;
            long sqld_row_change;
            long sqld_result_set_rows; };
        struct sqlname
        {
            short      length;
            unsigned char data[30];
        } sqlname;
    } sqlvar[1];
};

struct sqlvar2
{ struct
    { long          sqllonglen;
      char         reserve1[28];
    } len;
  char *sqldatalen;
  struct sqldistinct_type
  { short          length;
    unsigned char data[30];
    } sqldatatype_name;
};

#define SQLDASIZE(n) (sizeof(struct sqlda)+(n-1) * sizeof(struct sqlvar))
#endif
```

Figure 11. INCLUDE SQLDA Declarations for C and C++

```
/*
*****
/* Macros for using the sqlvar2 fields.
*****
/*
*****
/* '2' in the 7th byte of sqldaaid indicates a doubled number of
/* sqlvar entries.
/*
/* '3' in the 7th byte of sqldaaid indicates a tripled number of
/* sqlvar entries.
/*
/* '4' in the 7th byte of sqldaaid indicates a quadrupled number of
/* sqlvar entries.
/*
*****
#define SQLDOUBLED '2'
#define SQLSINGLED ' '
/*
*****
/* GETSQLDOUBLED(daptr) returns 1 if the SQLDA pointed to by
/* daptr has been doubled, or 0 if it has not been doubled.
/*
*****
#define GETSQLDOUBLED(daptr) (((daptr)->sqldaaid[6]== \
(char) SQLDOUBLED) ? \
(1) : \
(0))
```

```

/*****
/* SETSQLDOUBLED(daptr, SQLDOUBLED) sets the 7th byte of sqlda
/* to '2'.
/* SETSQLDOUBLED(daptr, SQLSINGLED) sets the 7th byte of sqlda
/* to be a ' '.
*****/
#define SETSQLDOUBLED(daptr, newvalue) \
    (((daptr)->sqlda[6] =(newvalue)))

/*****
/* GETSQLDALONGLEN(daptr,n) returns the data length of the nth
/* entry in the sqlda pointed to by daptr. Use this only if the
/* sqlda was doubled or tripled and the nth SQLVAR entry has a
/* LOB datatype.
*****/
#define GETSQLDALONGLEN(daptr,n) ((long) (((struct sqlvar2 *) \
&((daptr)->sqlvar[(n) +((daptr)->sqld)])) ->len.sqllonglen))

/*****
/* SETSQLDALONGLEN(daptr,n,len) sets the sqllonglen field of the
/* sqlda pointed to by daptr to len for the nth entry. Use this only
/* if the sqlda was doubled or tripled and the nth SQLVAR entry has
/* a LOB datatype.
*****/
#define SETSQLDALONGLEN(daptr,n,length) { \
    struct sqlvar2 *var2ptr; \
    var2ptr = (struct sqlvar2 *) &((daptr)->sqlvar[(n)+ \
    ((daptr)->sqld)]); \
    var2ptr->len.sqllonglen = (long) (length); \
}

/*****
/* SETSQLDALENPTR(daptr,n,ptr) sets a pointer to the data length for
/* the nth entry in the sqlda pointed to by daptr.
/* Use this only if the sqlda has been doubled or tripled.
*****/
#define SETSQLDALENPTR(daptr,n,ptr) { \
    struct sqlvar2 *var2ptr; \
    var2ptr = (struct sqlvar2 *) &((daptr)->sqlvar[(n)+ \
    ((daptr)->sqld)]); \
    var2ptr->sqldatalen = (char *) ptr; \
}

/*****
/* GETSQLDALENPTR(daptr,n) returns a pointer to the data length for
/* the nth entry in the sqlda pointed to by daptr. Unlike the inline
/* value (union sql8bytelen len), which is 8 bytes, the sqldatalen
/* pointer field returns a pointer to a long (4 byte) integer.
/* If the SQLDATALEN pointer is zero, a NULL pointer is be returned.
/*
/* NOTE: Use this only if the sqlda has been doubled or tripled.
*****/
#define GETSQLDALENPTR(daptr,n) ( \
    (((struct sqlvar2 *) &(daptr)->sqlvar[(n) + \
    (daptr)->sqld])->sqldatalen == NULL) ? \
    ((long *) NULL) : ((long *) ((struct sqlvar2 *) \
    &(daptr)->sqlvar[(n) + (daptr) ->sqld])->sqldatalen))

```

For COBOL and ILE COBOL

In COBOL and ILE COBOL, INCLUDE SQLDA declarations are equivalent to the following:

```
1 SQLDA.  
  05 SQLDAID      PIC X(8).  
  05 SQLDABC      PIC S9(9) BINARY.  
  05 SQLN         PIC S9(4) BINARY.  
  05 SQLD         PIC S9(4) BINARY.  
  05 SQLVAR OCCURS 0 TO 409 TIMES DEPENDING ON SQLD.  
  10 SQLVAR1.  
    15 SQLTYPE    PIC S9(4) BINARY.  
    15 SQLLEN     PIC S9(4) BINARY.  
    15 FILLER     REDEFINES SQLLEN.  
      20 SQLPRECISION PIC X.  
      20 SQLSCALE    PIC X.  
    15 SQLRES     PIC X(12).  
    15 SQLDATA    POINTER.  
    15 SQL-RESULT-SET-LOCATOR-R REDEFINES SQLDATA.  
      20 SQL-RESULT-SET-LOCATOR PIC S9(18) BINARY.  
    15 SQLIND     POINTER.  
    15 SQL-ROW-CHANGE-SQL-R REDEFINES SQLIND.  
      20 SQLD-ROW-CHANGE PIC S9(9) BINARY.  
    15 SQL-RESULT-SET-ROWS-R PIC REDEFINES SQLIND.  
      20 SQLD-RESULT-SET-ROWS PIC S9(9) BINARY.  
    15 SQLNAME.  
      49 SQLNAMEL PIC S9(4) BINARY.  
      49 SQLNAMEC PIC X(30).  
  10 SQLVAR2 REDEFINES SQLVAR1.  
    15 SQLVAR2-RESERVED-1 PIC S9(9) BINARY.  
    15 SQLLONGLEN REDEFINES SQLVAR2-RESERVED-1  
      PIC S9(9) BINARY.  
    15 SQLVAR2-RESERVED-2 PIC X(28).  
    15 SQLDATALEN POINTER.  
    15 SQLDATATYPE-NAME.  
      49 SQLDATATYPE_NAMEL PIC S9(4) BINARY.  
      49 SQLDATATYPE_NAMEC PIC X(30).
```

Figure 12. INCLUDE SQLDA Declarations for COBOL

For PL/I

In PL/I, INCLUDE SQLDA declarations are equivalent to the following:

```
DCL 1 SQLDA BASED(SQLDAPTR),
    2 SQLDAID CHAR(8),
    2 SQLDABC BIN FIXED(31),
    2 SQLN BIN FIXED,
    2 SQLD BIN FIXED,
    2 SQLVAR (99),
    3 SQLTYPE BIN FIXED,
    3 SQLLEN BIN FIXED,
    3 SQLRES CHAR(12),
    3 SQLDATA PTR,
    3 SQLIND PTR,
    3 SQLNAME CHAR(30) VAR,

    1 SQLDA2 BASED(SQLDAPTR),
    2 SQLDAID2 CHAR(8),
    2 SQLDABC2 FIXED(31) BINARY,
    2 SQLN2 FIXED(15) BINARY,
    2 SQLD2 FIXED(15) BINARY,
    2 SQLVAR2 (99),
    3 SQLBIGLEN,
    4 SQLLONGL FIXED(31) BINARY,
    4 SQLRSVDL FIXED(31) BINARY,
    3 SQLDATAL POINTER,
    3 SQLTNAME CHAR(30) VAR;

DECLARE SQLSIZE FIXED(15) BINARY;
DECLARE SQLDAPTR PTR;
DECLARE SQLDOUBLED CHAR(1) INITIAL('2') STATIC;
DECLARE SQLSINGLED CHAR(1) INITIAL(' ') STATIC;
```

Figure 13. INCLUDE SQLDA Declarations for PL/I

For ILE RPG

In ILE RPG, INCLUDE SQLDA declarations are equivalent to the following:

```
// SQL DESCRIPTOR AREA
DCL-DS SQLDA;
  SQLDAID CHAR(8);
  SQLDABC INT(10);
  SQLN INT(5);
  SQLD INT(5);
  SQL_VAR CHAR(80) DIM(SQL_NUM);
  *N POINTER OVERLAY(SQL_VAR:17);
  *N POINTER OVERLAY(SQL_VAR:33);
END-DS SQLDA;
DCL-DS SQLVAR;
  SQLTYPE INT(5);
  SQLLEN INT(5);
  SQLRES CHAR(12);
  SQLINFO1 CHAR(16);
  SQLDATA POINTER OVERLAY(SQLINFO1);
  SQL_RESULT_SET_LOCATOR INT(20) OVERLAY(SQLINFO1);
  SQLINFO2 CHAR(16);
  SQLIND POINTER OVERLAY(SQLINFO2);
  SQL_ROW_CHANGE INT(10) OVERLAY(SQLINFO2);
  SQL_RESULT_SET_ROWS INT(10) OVERLAY(SQLINFO2);
  SQLNAMELEN INT(5);
  SQLNAME CHAR(30);
END-DS SQLVAR;
// EXTENDED SQLDA
DCL-DS SQLVAR2;
  SQLLONGL INT(10);
  SQLRSVDL CHAR(28);
  SQLDATAL POINTER;
  SQLTNAMELN INT(5);
  SQLTNAME CHAR(30);
END-DS SQLVAR2;
```

Figure 14. INCLUDE SQLDA Declarations for ILE RPG

The user is responsible for the definition of SQL_NUM. SQL_NUM must be defined as a numeric constant with the dimension required for SQL_VAR.

Since RPG does not support structures within arrays, the SQLDA generates three data structures. The second and third data structures are used to setup/reference the part of the SQLDA which contains the field descriptions.

To set the field descriptions of the SQLDA the program sets up the field description in the subfields of SQLVAR (or SQLVAR2) and then does a MOVEA of SQLVAR (or SQLVAR2) to SQL_VAR, n where n is the number of the field in the SQLDA. This is repeated until all the field descriptions are set.

When the SQLDA field descriptions are to be referenced the user does a MOVEA of SQL_VAR, n to SQLVAR (or SQLVAR2) where n is the number of the field description to be processed.

Appendix E. CCSID values

The tables in this section describe the CCSIDs and conversions provided by the IBM relational database products.

For more information, see “Character conversion” on page 28.

The following list defines the symbols used in the Db2 product column in the following tables:

X

Indicates that the conversion tables exist to convert from or to that CCSID. This also implies that this CCSID can be used to tag local data.

C

Indicates that conversion tables exist to convert from that CCSID to another CCSID. This also implies that this CCSID cannot be used to tag local data, because the CCSID is in a foreign encoding scheme (for example, a PC-Data CCSID such as 850 cannot be used to tag local data in Db2 for i).

blank

Indicates that the specific product does not support the CCSID at all. Such a CCSID must not be used unless interoperability with the specific product is not necessary.

This information is current as of the publishing date of this book for the CCSIDs listed. Additional CCSIDs may have been added since the publishing date and are not in the lists below.

Table 148. Universal Character Set (UTF-8, UTF-16, and UCS-2)

CCSID	Description	z/OS	i	AIX	HP	Sun	NT	SCO	SGI	Linux
1200	UTF-16	X	X	X	X	X	X	X	X	X
1208	UTF-8 Level 3	X	X	X	X	X	X	X	X	X
13488	UCS-2 Level 1	C	X	C*	C*	C*	C*	C*	C*	C*

Note: * In Db2 LUW, 13488 is only used to tag the GRAPHIC column of eucJP and eucTW databases.

Table 149. CCSIDs for EBCDIC Group 1 (Latin-1) Countries or Regions

CCSID	Description	z/OS	i	AIX	HP	Sun	NT	SCO	SGI	Linux
37	USA, Canada, Netherlands, Portugal, Brazil, Australia, New Zealand	X	X	C	C	C	C	C	C	C
256	Word Processing, Netherlands	X	X							
273	Austria, Germany	X	X	C	C	C	C	C	C	C
274	Belgium	X		C	C	C	C	C	C	C
277	Denmark, Norway	X	X	C	C	C	C	C	C	C
278	Finland, Sweden	X	X	C	C	C	C	C	C	C
280	Italy	X	X	C	C	C	C	C	C	C
284	Spain, Latin America (Spanish)	X	X	C	C	C	C	C	C	C
285	United Kingdom	X	X	C	C	C	C	C	C	C
297	France	X	X	C	C	C	C	C	C	C

Table 149. CCSIDs for EBCDIC Group 1 (Latin-1) Countries or Regions (continued)

CCSID	Description	z/OS	i	AIX	HP	Sun	NT	SCO	SGI	Linux
500	Belgium, Canada, Switzerland, International Latin-1	X	X	C	C	C	C	C	C	C
871	Iceland	X	X	C	C	C	C	C	C	C
924	Latin-0	X	X							
1047	Latin-0 (with Euro)	X	X							
1140	USA, Canada, Netherlands, Portugal, Brazil, Australia, New Zealand	X	X	C	C	C	C	C	C	C
1141	Austria, Germany	X	X	C	C	C	C	C	C	C
1142	Denmark, Norway	X	X	C	C	C	C	C	C	C
1143	Finland, Sweden	X	X	C	C	C	C	C	C	C
1144	Italy	X	X	C	C	C	C	C	C	C
1145	Spain, Latin America (Spanish)	X	X	C	C	C	C	C	C	C
1146	United Kingdom	X	X	C	C	C	C	C	C	C
1147	France	X	X	C	C	C	C	C	C	C
1148	Belgium, Canada, Switzerland, International Latin-1	X	X	C	C	C	C	C	C	C
1149	Iceland	X	X	C	C	C	C	C	C	C

Table 150. CCSIDs for PC-Data and ISO Group 1 (Latin-1) Countries or Regions

CCSID	Description	z/OS	i	AIX	HP	Sun	NT	SCO	SGI	Linux
437	USA	X	C	C	C	C	C	C	C	C
819	Latin-1 countries or regions (ISO 8859-1)	X	C	X	X	X	C	X	X	X
850	Latin Alphabet Number 1; Latin-1 countries or regions	X	C	X	C	C	C	C	C	C
858	Latin Alphabet Number 1; Latin-1 countries or regions (with Euro)	X	C							
860	Portugal (850 subset)	X	C	C	C	C	C	C	C	C
861	Iceland	X	C							
863	Canada (850 subset)	X	C	C	C	C	C	C	C	C
865	Denmark, Norway, Finland, Sweden	X	C							
923	Latin-0	X	C	X	X	X	C	C	C	X
1009	IRV 7-bit	X	C							

Table 150. CCSIDs for PC-Data and ISO Group 1 (Latin-1) Countries or Regions (continued)

CCSID	Description	z/OS	i	AIX	HP	Sun	NT	SCO	SGI	Linux
1010	France 7-bit	X	C							
1011	Germany 7-bit	X	C							
1012	Italy 7-bit	X	C							
1013	United Kingdom 7-bit	X	C							
1014	Spain 7-bit	X	C							
1015	Portugal 7-bit	X	C							
1016	Norway 7-bit	X	C							
1017	Denmark 7-bit	X	C							
1018	Finland and Sweden 7-bit	X	C							
1019	Belgium and Netherlands 7-bit	X	C							
1051	HP Emulation	X	C	C	X	C	C	C	C	C
1252	Windows ** Latin-1	X	C	C	C	C	X	C	C	C
1275	Macintosh ** Latin-1	X	C							
5348	Windows Latin-1 (with Euro)	X	C							

Table 151. CCSIDs for EBCDIC Group 1a (Non-Latin-1 SBCS) Countries or Regions

CCSID	Description	z/OS	i	AIX	HP	Sun	NT	SCO	SGI	Linux
420	Arabic (Type 4)	X	X	C	C	C	C	C	C	C
423	Greek	X	X	C	C	C	C	C	C	C
424	Hebrew (Type 4)	X	X	C	C	C	C	C	C	C
425	Arabic (Type 5)		X	C	C	C	C	C	C	C
870	Latin-2 Multilingual	X	X	C	C	C	C	C	C	C
875	Greek	X	X	C	C	C	C	C	C	C
880	Cyrillic Multilingual	X	X							
905	Turkey Latin-3 Multilingual	X	X							
918	Urdu	X	X							
1025	Cyrillic Multilingual	X	X	C	C	C	C	C	C	C
1026	Turkey Latin-5	X	X	C	C	C	C	C	C	C
1097	Farsi	X	X							
1112	Baltic Multilingual	X	X	C	C	C	C	C	C	C
1122	Estonia	X	X	C	C	C	C	C	C	C
1123	Ukraine	X	X	C	C	C	C	C	C	C
1137	Devanagari	X	X	C	C	C	C	C	C	C
1153	Latin-2 (with Euro)	X	X	C	C	C	C	C	C	C

Table 151. CCSIDs for EBCDIC Group 1a (Non-Latin-1 SBCS) Countries or Regions (continued)

CCSID	Description	z/OS	i	AIX	HP	Sun	NT	SCO	SGI	Linux
1154	Cyrillic (with Euro)	X	X	C	C	C	C	C	C	C
1155	Turkey Latin-5 (with Euro)	X	X	C	C	C	C	C	C	C
1156	Balitic (with Euro)	X	X	C	C	C	C	C	C	C
1157	Estonia (with Euro)	X	X	C	C	C	C	C	C	C
1158	Ukraine (with Euro)	X	X	C	C	C	C	C	C	C
1166	Cyrillic Multilingual (with Euro)		X							
1175	Turkey Latin-5 (with Turkish lira)		X							
4971	Greek (with Euro)	X	X							
5233	Devanagari (with Indian rupee)		X							
8612	Arabic (Type 5)	X	X							
12708	Arabic (Type 7)		X							
62211	Hebrew (Type 5)		X	C	C	C	C	C	C	C
62224	Arabic (Type 6)		X	C	C	C	C	C	C	C
62229	Hebrew (Type 8)			C	C	C	C	C	C	C
62233	Arabic (Type 8)			C	C	C	C	C	C	C
62234	Arabic (Type 9)			C	C	C	C	C	C	C
62235	Hebrew (Type 6)		X	C	C	C	C	C	C	C
62240	Hebrew (Type 11)			C	C	C	C	C	C	C
62245	Hebrew (Type 10)		X	C	C	C	C	C	C	C
62250	Arabic (Type 12)			C	C	C	C	C	C	C
62251	Arabic (Type 6)		X	C	C	C	C	C	C	C

Table 151. CCSIDs for EBCDIC Group 1a (Non-Latin-1 SBCS) Countries or Regions (continued)

CCSID	Description	z/OS	i	AIX	HP	Sun	NT	SCO	SGI	Linux
String Types:										
4	Visual / Left-to-Right / Shaped / Symmetrical Swapping Off									
5	Implicit / Left-to-Right / Unshaped / Symmetrical Swapping On									
6	Implicit / Right-to-Left / Unshaped / Symmetrical Swapping On									
7	Visual / Contextual / Unshaped / Symmetrical Swapping Off									
8	Visual / Right-to-Left / Shaped / Symmetrical Swapping Off									
9	Visual / Right-to-Left / Shaped / Symmetrical Swapping On									
10	Implicit / Contextual-Left / Unshaped / Symmetrical Swapping On									
11	Implicit / Contextual-Right / Unshaped / Symmetrical Swapping On									
12	Implicit / Right-to-Left / Shaped / Symmetrical Swapping On									

Table 152. CCSIDs for PC-Data and ISO Group 1a (Non-Latin-1 SBCS) Countries or Regions

CCSID	Description	z/OS	i	AIX	HP	Sun	NT	SCO	SGI	Linux
720	Arabic (MS-Dos)	X	C							
737	Greek (MS-Dos)	X	C	C	C	C	X	C	C	C
775	Baltic (MS-Dos)	X	C							
808	Cyrillic (with Euro)	X								
813	Greek/Latin (ISO 8859-7)	X	C	X	X	C	C	X	C	X
848	Ukraine (with Euro)	X								
849	Belarus (with Euro)	X								
851	Greek	X	C							
852	Latin-2 Multilingual	X	C	C	C	C	C	C	C	C
855	Cyrillic Multilingual	X	C	C	C	C	C	C	C	C
856	Arabic (Type 5)	X	C	X	C	C	C	C	C	C
857	Turkey Latin-5	X	C	C	C	C	C	C	C	C
862	Hebrew (Type 4)	X	C	C	C	C	C	C	C	C
864	Arabic (Type 5)	X	C	C	C	C	C	C	C	C
866	Cyrillic	X	C	C	C	C	C	C	C	C
867	Hebrew (with Euro) (Type 10)	X								

Table 152. CCSIDs for PC-Data and ISO Group 1a (Non-Latin-1 SBCS) Countries or Regions (continued)

CCSID	Description	z/OS	i	AIX	HP	Sun	NT	SCO	SGI	Linux
868	Urdu	X	C							
869	Greek	X	C	C	C	C	C	C	C	C
872	Cyrillic Multilingual (with Euro)	X								
878	Russian Internet	X	C							
901	Baltic 8-bit (with Euro)	X	C							
902	Estonia 8-bit (with Euro)	X	C							
912	Latin-2 (ISO 8859-2)	X	C	X	X	C	C	X	C	X
914	Latin-4 (ISO 8859-4)	X	C							
915	Cyrillic Multilingual (ISO 8859-5)	X	C	X	X	C	C	X	C	X
916	Hebrew/Latin (ISO 8859-8) (Type 5)	X	C	X	C	C	C	C	C	X
920	Turkey Latin-5 (ISO 8859-9)	X	C	X	X	C	C	X	C	X
921	Baltic 8-bit (ISO 8859-13)	X	C	X	C	C	C	C	C	C
922	Estonia 8-bit	X	C	X	C	C	C	C	C	C
1008	Arabic 8-bit ISO	X	C							
1046	Arabic (Type 5)	X	C	X	C	C	C	C	C	C
1089	Arabic (ISO 8859-6) (Type 5)	X	C	X	X	C	C	C	C	C
1098	Farsi	X	C							
1124	Ukraine 8-bit ISO	X	C	X	C	C	C	C	C	C
1125	Ukraine	X	C	C	C	C	C	C	C	C
1131	Belarus	X	C	C	C	C	C	C	C	C
1250	Windows Latin-2	X	C	C	C	C	X	C	C	C
1251	Windows Cyrillic	X	C	C	C	C	X	C	C	C
1253	Windows Greek	X	C	C	C	C	X	C	C	C
1254	Windows Turkey	X	C	C	C	C	X	C	C	C
1255	Windows Hebrew (Type 5)	X	C	C	C	C	X	C	C	C
1256	Windows Arabic (Type 5)	X	C	C	C	C	X	C	C	C
1257	Windows Baltic	X	C	C	C	C	X	C	C	C
1280	Macintosh** Greek	X	C							
1281	Macintosh** Turkish	X	C							
1282	Macintosh** Latin-2	X	C							
1283	Macintosh** Cyrillic	X	C							
4909	ISO 8859-7 Greek/Latin (with Euro)	X	C							

Table 152. CCSIDs for PC-Data and ISO Group 1a (Non-Latin-1 SBCS) Countries or Regions (continued)

CCSID	Description	z/OS	i	AIX	HP	Sun	NT	SCO	SGI	Linux
4948	Latin-2 Multilingual	X	C							
4951	Cyrillic Multilingual	X	C							
4952	Hebrew	X	C							
4953	Turkey Latin-5	X	C							
4960	Arabic	X	C							
4965	Greek		C							
5346	Windows Latin-2 (with Euro)	X								
5347	Windows Cyrillic (with Euro)	X								
5349	Windows Greek (with Euro)	X								
5350	Windows Turkey (with Euro)	X								
5351	Windows Hebrew (with Euro)	X								
5352	Windows Arabic (with Euro)	X								
5353	Windows Baltic Rim (with Euro)	X								
9056	Arabic (Storage Interchange)	X	C							
62208	Hebrew (Type 4)			X	X	X	X	X	X	X
62209	Hebrew (Type 10)		C	C	C	C	C	C	C	C
62210	Hebrew/Latin (ISO 8859-8) (Type 4)		C	X	X	C	C	C	C	C
62213	Hebrew (Type 5)		C	C	C	C	C	C	C	C
62215	Windows Hebrew (Type 4)		C	C	C	C	X	C	C	C
62218	Arabic (Type 4)		C	C	C	C	C	C	C	C
62220	Hebrew (Type 6)			X	X	X	X	X	C	C
62221	Hebrew (Type 6)		C	C	C	C	C	C	C	C
62222	Hebrew/Latin (ISO 8859-8) (Type 6)		C	X	X	C	C	C	C	C
62223	Windows Hebrew (Type 6)		C	C	C	C	X	C	C	C
62225	Arabic (Type 6)			C	C	C	C	C	C	C
62226	Arabic (Type 6)			X	C	C	C	C	C	C
62227	Arabic (ISO 8859-6) (Type 6)			X	X	C	C	C	C	C
62228	Windows Arabic (Type 6)		C	C	C	C	X	C	C	C
62230	Hebrew (Type 8)			X	X	X	X	X	C	C
62231	Hebrew (Type 8)			C	C	C	C	C	C	C
62232	Hebrew/Latin (ISO 8859-8) (Type 8)			X	X	C	C	C	C	C
62236	Hebrew (Type 10)			X	X	X	X	X	X	X

Table 152. CCSIDs for PC-Data and ISO Group 1a (Non-Latin-1 SBCS) Countries or Regions (continued)

CCSID	Description	z/OS	i	AIX	HP	Sun	NT	SCO	SGI	Linux
62238	ISO 8859-8 Hebrew/Latin (Type 10)		C	C	C	C	X	C	C	C
62239	Windows Hebrew (Type 10)		C	C	C	C	X	C	C	C
62241	Hebrew (Type 11)			X	X	X	X	X	X	X
62242	Hebrew (Type 11)			C	C	C	C	C	C	C
62243	Hebrew/Latin (ISO 8859-8) (Type 11)			X	X	C	C	C	C	C
62244	Windows Hebrew (Type 11)			C	C	C	X	C	C	C
62248	Arabic (Type 4)		C							

String Types:

4

Visual / Left-to-Right / Shaped / Symmetrical Swapping Off

5

Implicit / Left-to-Right / Unshaped / Symmetrical Swapping On

6

Implicit / Right-to-Left / Unshaped / Symmetrical Swapping On

7

Visual / Contextual / Unshaped / Symmetrical Swapping Off

8

Visual / Right-to-Left / Shaped / Symmetrical Swapping Off

9

Visual / Right-to-Left / Shaped / Symmetrical Swapping On

10

Implicit / Contextual-Left / Unshaped / Symmetrical Swapping On

11

Implicit / Contextual-Right / Unshaped / Symmetrical Swapping On

12

Implicit / Right-to-Left / Shaped / Symmetrical Swapping On

Table 153. SBCS CCSIDs for EBCDIC Group 2 (DBCS) Countries or Regions

CCSID	Description	z/OS	i	AIX	HP	Sun	NT	SCO	SGI	Linux
290	Japan Katakana (extended)	X	X	C	C	C	C	C	C	C
833	Korea (extended)	X	X	C	C	C	C	C	C	C
836	Simplified Chinese (extended)	X	X	C	C	C	C	C	C	C
838	Thailand (extended)	X	X	C	C	C	C	C	C	C
1027	Japan English (extended)	X	X	C	C	C	C	C	C	C
1130	Vietnam	X	X	C	C	C	C	C	C	C
1132	Lao	X	X							

Table 153. SBCS CCSIDs for EBCDIC Group 2 (DBCS) Countries or Regions (continued)

CCSID	Description	z/OS	i	AIX	HP	Sun	NT	SCO	SGI	Linux
1159	Traditional Chinese (extended with Euro)			C	C	C	C	C	C	C
1160	Thai (with Euro)	X	X	C	C	C	C	C	C	C
1164	Vietnam (with Euro)	X	X	C	C	C	C	C	C	C
5123	Japan English (with Euro)	X	X							
8482	Japan Katakana (extended with Euro)	X		C	C	C	C	C	C	C
9030	Thailand (extended)	X	X							
13121	Korea Windows	X	X							
13124	Traditional Chinese	X	X							
28709	Traditional Chinese (extended)	X	X	C	C	C	C	C	C	C

Table 154. SBCS CCSIDs for PC-Data Group 2 (DBCS) Countries or Regions

CCSID	Description	z/OS	i	AIX	HP	Sun	NT	SCO	SGI	Linux
367	Korea and Simplified Chinese EUC	X	C	X			C			
874	Thailand (extended)	X	C	X	X		X			
891	Korea (non-extended)	C	C							
895	Japan EUC - JISX201 Roman Set	C	C							
896	Japan EUC - JISX201 Katakana Set	C								
897	Japan (non-extended)	C	C							
903	Simplified Chinese (non-extended)	C	C							
904	Traditional Chinese (non-extended)	X	C							
1040	Korea (extended)	C	C							
1041	Japan (extended)	X	C							
1042	Simplified Chinese (extended)	C	C							
1043	Traditional Chinese (extended)	X	C							
1088	Korea (KS Code 5601-89)	X	C							
1114	Traditional Chinese (Big-5)	X	C							
1115	Simplified Chinese GB-Code	X	C							
1126	Korea Windows	X	C							

Table 154. SBCS CCSIDs for PC-Data Group 2 (DBCS) Countries or Regions (continued)

CCSID	Description	z/OS	i	AIX	HP	Sun	NT	SCO	SGI	Linux
1129	Vietnam	X	C	X						
1133	Lao ISO	X	C							
1162	Thailand (extended) (180 char) (with Euro)	X								
1163	ISO Vietnam (with Euro)	X								
1258	Vietnam	X	C			X				
4970	Thailand (extended)	X	C							
5210	Traditional Chinese	X	C							
9066	Thailand (extended)	X	C							

Table 155. DBCS CCSIDs for EBCDIC Group 2 (DBCS) Countries or Regions

CCSID	Description	z/OS	i	AIX	HP	Sun	NT	SCO	SGI	Linux
300	Japan - including 4370 user-defined characters (UDC)	X	X	C	C	C	C	C	C	C
834	Korea - including 1880 UDC	X	X	C	C	C	C	C	C	C
835	Traditional Chinese - including 6204 UDC	X	X	C	C	C	C	C	C	C
837	Simplified Chinese - including 1880 UDC	X	X	C	C	C	C	C	C	C
4396	Japan - including 1880 UDC	X	X	C	C	C	C	C	C	C
4930	Korea Windows	X	X	C	C	C	C	C	C	C
4933	Simplified Chinese	X	X	C	C	C	C	C	C	C
9027	Traditional Chinese (with Euro) - including 6204 UDC	C		C	C	C	C	C	C	C
16684	Japan (with Euro)	X	X	C	C	C	C	C	C	C

Table 156. DBCS CCSIDs for PC-Data Group 2 (DBCS) Countries or Regions

CCSID	Description	z/OS	i	AIX	HP	Sun	NT	SCO	SGI	Linux
301	Japan - including 1880 UDC	X	C	X	C	C	C	C	C	C
926	Korea - including 1880 UDC	C	C							
927	Traditional Chinese - including 6204 UDC	X	C	C	C	C	C	C	C	C
928	Simplified Chinese - including 1880 UDC	C	C							
941	Japan Windows	X	C	C	C	C	X	C	C	C
947	Traditional Chinese (Big-5)	X	C	X	C	C	X	C	C	C
951	Korea (KS Code 5601-89) - including 1880 UDC	X	C	C	C	C	X	C	C	C

Table 156. DBCS CCSIDs for PC-Data Group 2 (DBCS) Countries or Regions (continued)

CCSID	Description	z/OS	i	AIX	HP	Sun	NT	SCO	SGI	Linux
952	Japan (EUC) X208-1990 set	C								
953	Japan (EUC) X212-1990 set	C								
971	Korea (EUC) - including 188 UDC	X	C	X	X	X	C	C	C	C
1351	Japan HP-UX (J15)	X		C	X	C	C	C	C	C
1362	Korea Windows	X	C	C	C	C	X	C	C	C
1380	Simplified Chinese (GB-Code) - including 1880 UDC	X	C	C	C	C	X	X	C	C
1382	Simplified Chinese (EUC) - including 1360 UDC	X	C	X	X	X	C	X	C	C
1385	Traditional Chinese	X	C	C	C	C	X	C	C	C

Table 157. Mixed CCSIDs for EBCDIC Group 2 (DBCS) Countries or Regions

CCSID	Description	z/OS	i	AIX	HP	Sun	NT	SCO	SGI	Linux
930	Japan Katakana/Kanji (extended) - including 4370 UDC	X	X	C	C	C	C	C	C	C
933	Korea (extended) - including 1880 UDC	X	X	C	C	C	C	C	C	C
935	Simplified Chinese (extended) - including 1880 UDC	X	X	C	C	C	C	C	C	C
937	Traditional Chinese (extended) - including 4370 UDC	X	X	C	C	C	C	C	C	C
939	Japan English/Kanji (extended) - including 4370 UDC	X	X	C	C	C	C	C	C	C
1364	Korea (extended)	X	X	C	C	C	C	C	C	C
1371	Traditional Chinese (extended with Euro) - including 4370 UDC			C	C	C	C	C	C	C
1388	Simplified Chinese	X	X	C	C	C	C	C	C	C
1390	Japan Katakana/Kanji (extended with Euro) - including 4370 UDC	X		C	C	C	C	C	C	C
1399	Japan English (with Euro)	X	X						C	C
5026	Japan Katakana/Kanji (extended) - including 1880 UDC)	X	X	C	C	C	C	C	C	C

Table 157. Mixed CCSIDs for EBCDIC Group 2 (DBCS) Countries or Regions (continued)

CCSID	Description	z/OS	i	AIX	HP	Sun	NT	SCO	SGI	Linux
5035	Japan English/Kanji (extended) - including 1880 UDC	X	X	C	C	C	C	C	C	C

Table 158. Mixed CCSIDs for PC-Data Group 2 (DBCS) Countries or Regions

CCSID	Description	z/OS	i	AIX	HP	Sun	NT	SCO	SGI	Linux
932	Japan (non-extended) - including 1880 UDC	X	C	X	C	C	C	C	C	C
934	Korea (non-extended) including 1880 UDC		C							
936	Simplified Chinese (non-extended) - including 1880 UDC		C							
938	Traditional Chinese (non-extended) - including 6204 UDC)	X	C	C	C	C	C	C	C	C
942	Japan (extended) - including 1880 UDC	X	C	C	C	C	C	C	C	C
943	Japan NT	X	C	C	C	X	X	C	C	C
944	Korea (extended) - including 1880 UDC		C							
946	Simplified Chinese (extended) - including 1880 UDC		C							
948	Traditional Chinese (extended) - including 6204 UDC	X	C	C	C	C	C	C	C	C
949	Korea (KS Code 5601-89) - including 1880 UDC	X	C	C	C	C	C	C	C	C
950	Traditional Chinese (Big-5)	X	C	X	X	X	X	C	C	X
954	Japan (EUC)		C	X	X	X	C	X	C	X
956	Japan 2022 TCP		C							
957	Japan 2022 TCP		C							
958	Japan 2022 TCP		C							
959	Japan 2022 TCP		C							
964	Traditional Chinese (EUC)		C	X	X	X	C	C	C	C
965	Traditional Chinese 2022 TCP		C							
970	Korea EUC	X	C	X	X	X	C	C	X	X
1363	Korea Windows	X	C	C	C	C	X	C	C	C
1381	Simplified Chinese GB-Code	X	C	C	C	C	X	C	C	C

Table 158. Mixed CCSIDs for PC-Data Group 2 (DBCS) Countries or Regions (continued)

CCSID	Description	z/OS	i	AIX	HP	Sun	NT	SCO	SGI	Linux
1383	Simplified Chinese EUC	X	C	X	X	X	C	X	C	X
1386	Simplified Chinese	X	C	X	C	C	X	C	C	C
1392	Simplified Chinese GB18030		C							
5039	Japan HP-UX (J15)	X		C	X	C	C	C	C	C
5050	Japan (EUC)		C							
5052	Japan 2022 TCP		C							
5053	Japan 2022 TCP		C							
5054	Japan 2022 TCP		C							
5055	Japan 2022 TCP		C							
5307	Japan HP-UX (J15) HISTORICAL	X								
17354	Korea 2022 TCP		C							
25546	Korea 2022 TCP		C							
33722	Japan EUC		C							

Appendix F. Db2 for i catalog views

The views contained in a Db2 for i catalog are described in this section.

The database manager maintains a set of tables containing information about the data in each relational database. These tables are collectively known as the *catalog*. The *catalog tables* contain information about tables, user-defined functions, distinct types, parameters, procedures, packages, views, indexes, aliases, sequences, variables, constraints, triggers, XSR objects, and languages supported by Db2 for i. The catalog also contains information about all relational databases that are accessible from this system.

There are three classes of catalog views:

- IBM i catalog tables and views

The IBM i catalog tables and views are modeled after the ANS and ISO catalog views, but are not identical to the ANS and ISO catalog views. These tables and views are compatible with prior releases of Db2 for i.

These tables and views exist in schemas QSYS and QSYS2.

The catalog tables and views contain information about all tables, parameters, procedures, functions, distinct types, packages, XSR objects, views, indexes, aliases, sequences, variables, triggers, and constraints in the entire relational database. When an SQL schema is created, an additional subset of these views are created into the schema that only contain information about tables, packages, views, indexes, and constraints in that schema.

- ODBC and JDBC catalog views

The ODBC and JDBC catalog views are designed to satisfy ODBC and JDBC metadata API requests. For example, SQLCOLUMNS. These views are compatible with views on Db2 LUW Version 8. These views will be modified as ODBC or JDBC enhances or modifies their metadata APIs.

These views exist in schema SYSIBM.

- ANS and ISO catalog views

The ANS and ISO catalog views are designed to comply with the ANS and ISO SQL standard (the Information Schema catalog views). These views will be modified as the ANS and ISO standard is enhanced or modified.

There are several columns in these views that are reserved for future standard enhancements.

There are two versions of these views:

- The first version of these views exist in schema INFORMATION_SCHEMA¹⁶⁰. Only rows associated with objects to which the user has some privilege are included in the views. This version is compatible with the ANS and ISO SQL standard.

If you use of this set of catalog views to prevent users from seeing any information about objects to which they have no privilege, you should revoke privileges to the other catalog views from users and PUBLIC.

- The second version of these views exist in schema SYSIBM. All rows are included in these views whether or not the user has some privilege to the objects associated with rows in the views. These views are compatible with views on Db2 LUW Version 8 and will generally perform better than the ANS and ISO views in QSYS2.

¹⁶⁰ INFORMATION_SCHEMA is the ANS and ISO SQL standard schema name that contains catalog views. It is a synonym for QSYS2.

For example, assume that a user has the SELECT privilege to the QSYS2.TABLES and SYSIBM.TABLES catalog views but does not have any privilege to a table called WORK.EMPLOYEE. The following SQL statement will not return a result row:

```
SELECT *  
FROM QSYS2.TABLES  
WHERE TABLE_SCHEMA = 'WORK' AND TABLE_NAME = 'EMPLOYEE'
```

However, the following SQL statement will return a result row:

```
SELECT *  
FROM SYSIBM.TABLES  
WHERE TABLE_SCHEMA = 'WORK' AND TABLE_NAME = 'EMPLOYEE'
```

Note: Some of these views use special catalog functions as part of the view definition. These functions exist in SYSIBM and QSYS2. If these functions are used directly in applications, care should be taken because they may be incompatibly changed in future releases or fix packs.

Notes

Names in the Catalog: In general, all names stored in columns of a catalog table are undelimited and case sensitive. For example, assume the following table was created:

```
CREATE TABLE "colname"/"long_table_name"
              ("long_column_name" CHAR(10),
              INTCOL INTEGER)
```

If the following select statement is used to return information about the mapping between SQL names and system names, the following select statement could be used:

```
SELECT TABLE_NAME, SYSTEM_TABLE_NAME, COLUMN_NAME, SYSTEM_COLUMN_NAME
FROM QSYS2/SYSCOLUMNS
WHERE TABLE_NAME = 'long_table_name' AND
      TABLE_SCHEMA = 'colname'
```

The following rows would be returned:

TABLE_NAME	SYSTEM_TABLE_NAME	COLUMN_NAME	SYSTEM_COLUMN_NAME
long_table_name	"long0001"	long_column_name	LONG_00001
long_table_name	"long0001"	INTCOL	INTCOL

System Names in the Catalog: In general, the longer SQL column names should be used rather than the short system column names. The short system column names for IBM i catalog tables and views are explicitly maintained for compatibility with prior releases and other Db2 products. The short system column names for the ODBC and JDBC catalog views and the ANS and ISO catalog views are not explicitly maintained and may change between releases.

Null Values in the Catalog: If the information in a column is not applicable, the null value is returned. Using the table created above, the following select statement, which queries the NUMERIC_SCALE and the CHARACTER_MAXIMUM_LENGTH, would return the null value when the data was not applicable to the data type of the column.

```
SELECT COLUMN_NAME, NUMERIC_SCALE, CHARACTER_MAXIMUM_LENGTH
FROM QSYS2/SYSCOLUMNS
WHERE TABLE_NAME = 'long_table_name' AND
      TABLE_SCHEMA = 'colname'
```

The following rows would be returned:

COLUMN_NAME	NUMERIC_SCALE	CHARACTER_MAXIMUM_LENGTH
long_column_name	?	10
INTCOL	0	?

Because numeric scale is not valid for a character column, the null value is returned for NUMERIC_SCALE for the "long_column_name" column. Because character length is not valid for a numeric column, the null value is returned for CHARACTER_MAXIMUM_LENGTH for the INTCOL column.

Install and Backup Considerations: Certain catalog tables and any views created over the catalog tables and views should be regularly saved:

- The catalog table QSYS.QADBXRDBD contains relational database information. This table should be regularly saved.
- When an ILE external function or procedure or an SQL function or procedure is restored, information is automatically inserted into these catalog tables. This does not occur for non-ILE external functions and procedures. In order to backup the definitions of non-ILE external functions or procedures, ensure that the catalog tables SYSROUTINES and SYSPARMS are saved or ensure you have a backup of the SQL source statements that were used to create these functions and procedures.

- All catalog views in the QSYS2 or SYSIBM schemas are system objects. This means that any user views created over these catalog views must be deleted when the operating system is installed. All dependent objects must be deleted as well. To avoid this requirement, you can save views before installation and then restore them afterwards.
- Catalog tables in the QSYS library are also system objects. However, the catalog tables in the QSYS library are not deleted during installation. Hence, any views created over these tables are preserved throughout the installation process.

Granting Privileges to Catalog Views: Tables and views in the catalog are like any other database tables and views. If you have authorization, you can use SQL statements to look at data in the catalog views in the same way that you retrieve data from any other table. The tables and views in the catalogs are shipped with the SELECT privilege to PUBLIC. This privilege may be revoked and the SELECT privilege granted to individual users.

QSYS Catalog Tables: Most of the catalog views are based on the following tables in the QSYS library (sometimes called the database cross reference files). These tables are not shipped with the SELECT privilege to PUBLIC and should not be used directly:

QADBCCST	QADBPKG	QADBXSFLD
QADBFDEP	QADBXCSTLS	QADBXRIGB
QADBFCST	QADBXCSTLSD	QADBXRIGC
QADBIFLD	QADBXRDBD	QADBXRIGD
QADBKFLD	QADBXRREF	

Use of SELECT *: New columns are likely to be added to tables and views in the catalog as new functionality is implemented and as the ISO/ANSI standards evolve. For this reason, it is recommended that SELECT * not be used when accessing catalog tables and views unless your application is prepared to tolerate these new columns.

IBM i catalog tables and views

The IBM i catalog includes the views and tables in the QSYS2 schema displayed in this section.

Db2 for i name	Corresponding ANSI/ISO name	Description
“SYSCATALOGS” on page 1707	CATALOGS	Information about relational databases
“SYSCHKCST” on page 1708	CHECK_CONSTRAINTS	Information about check constraints
“SYSCOLAUTH” on page 1709	COLUMN_PRIVILEGES	Information about column privileges
“SYSCOLUMNS” on page 1710	COLUMNS	Information about column attributes
“SYSCOLUMNS2” on page 1718		Information about column attributes
“SYSCOLUMNSTAT” on page 1730		Information about column statistics
“SYSCONTROLS” on page 1733		Information about row permissions and column masks
“SYSCONTROLSDEP” on page 1735		Information about row permission and column mask dependencies
“SYSCST” on page 1736	TABLE_CONSTRAINTS	Information about all constraints
“SYSCSTCOL” on page 1738	CONSTRAINT_COLUMN_USAGE	Information about the columns referenced in a constraint
“SYSCSTDEP” on page 1739	CONSTRAINT_TABLE_USAGE	Information about constraint dependencies on tables
“SYSFIELDS” on page 1741		Information about field procedures
“SYSFUNCS” on page 1745	ROUTINES	Information about user-defined functions
“SYSHISTORYTABLES” on page 1750		Information about history tables
“SYSINDEXES” on page 1751		Information about indexes
“SYSINDEXSTAT” on page 1753		Information about index statistics
“SYSJARCONTENTS” on page 1761		Information about jars for Java routines
“SYSJAROBJECTS” on page 1762		Information about jars for Java routines
“SYSKEYCST” on page 1763	KEY_COLUMN_USAGE	Information about unique, primary, and foreign keys
“SYSKEYS” on page 1764		Information about index keys
“SYSMQTSTAT” on page 1765		Information about materialized query table statistics
“SYSPACKAGE” on page 1769		Information about packages
“SYSPACKAGEAUTH” on page 1771		Information about package privileges
“SYSPACKAGESTAT” on page 1772		Information about package statistics
“SYSPACKAGESTMTSTAT” on page 1778		Information about the SQL statements in packages
“SYSPARMS” on page 1780	PARAMETERS	Information about routine parameters
“SYSPARTITIONDISK” on page 1784		Information about partition disk usage
“SYSPARTITIONINDEXDISK” on page 1786		Information about index disk usage
“SYSPARTITIONINDEXES” on page 1788		Information about partition indexes
“SYSPARTITIONINDEXSTAT” on page 1795		Information about partition index statistics
“SYSPARTITIONMQTS” on page 1801		Information about partition materialized query tables
“SYSPARTITIONSTAT” on page 1805		Information about partition statistics
“SYSPERIODS” on page 1809		Information about periods

Db2 for i name	Corresponding ANSI/ISO name	Description
“SYSPROCS” on page 1810	ROUTINES	Information about procedures
“SYSPROGRAMSTAT” on page 1813		Information about programs, service programs, and modules that contain SQL statements
“SYSPROGRAMSTMTSTAT” on page 1822		Information about SQL statements embedded in programs, service programs, and modules
“SYSREFCST” on page 1824	REFERENTIAL_CONSTRAINTS	Information about referential constraints
“SYSROUTINEAUTH” on page 1825	ROUTINE_PRIVILEGES	Information about routine privileges
“SYSROUTINEDEP” on page 1826	ROUTINE_TABLE_USAGE	Information about function and procedure dependencies
“SYSROUTINES” on page 1827	ROUTINES	Information about functions and procedures
“SYSSCHEMAAUTH” on page 1833		Information about schema privileges
“SYSSCHEMAS” on page 1834		Information about schemas
“SYSSEQUENCEAUTH” on page 1835	USAGE_PRIVILEGES	Information about sequence privileges
“SYSSEQUENCES” on page 1836		Information about sequences
“SYSTABLEDEP” on page 1839		Information about materialized query table dependencies
“SYSTABLEINDEXSTAT” on page 1840		Information about table index statistics
“SYSTABAUTH” on page 1838	TABLE_PRIVILEGES	Information about table privileges
“SYSTABLES” on page 1845	TABLES	Information about tables and views
“SYSTABLESTAT” on page 1849		Information about table statistics
“SYSTRIGCOL” on page 1852	TRIGGER_COLUMN_USAGE	Information about columns used in a trigger
“SYSTRIGDEP” on page 1853	TRIGGER_TABLE_USAGE	Information about objects used in a trigger
“SYSTRIGGERS” on page 1854	TRIGGERS	Information about triggers
“SYSTRIGUPD” on page 1858	TRIGGERED_UPDATE_COLUMNS	Information about columns in the WHEN clause of a trigger
“SYSTYPES” on page 1859	USER_DEFINED_TYPES	Information about built-in data types and distinct types
“SYSUDTAUTH” on page 1863	UDT_PRIVILEGES	Information about type privileges
“SYSVARIABLEAUTH” on page 1864		Information about global variable privileges
“SYSVARIABLEDEP” on page 1865		Information about objects used in global variables
“SYSVARIABLES” on page 1866		Information about global variables
“SYSVIEWDEP” on page 1872	VIEW_TABLE_USAGE	Information about view dependencies on tables
“SYSVIEWS” on page 1874	VIEWS	Information about definition of a view
“SYSXSROBJECTAUTH” on page 1876	USAGE_PRIVILEGES	Information about XML schema privileges
“XSRANNOTATIONINFO” on page 1877		Information about annotations
“XSROBJECTCOMPONENTS” on page 1878		Information about components in an XML schema
“XSROBJECTHIERARCHIES” on page 1879		Information about XML schema document hierarchy relationships
“XSROBJECTS” on page 1880		Information about XML schemas

SYSCATALOGS

The SYSCATALOGS view contains one row for each relational database that a user can connect to. The following table describes the columns in the SYSCATALOGS view.

Table 159. SYSCATALOGS view

Column Name	System Column Name	Data Type	Description
CATALOG_NAME	LOCATION	VARCHAR(18)	Relational database name.
CATALOG_STATUS	RDBASPSTAT	CHAR(10)	Status of a relational database. ACTIVE The relational database is associated with an independent auxiliary storage pool (IASP) that is active, but not yet available. AVAILABLE The relational database is available. VARYOFF The relational database is associated with an independent auxiliary storage pool (IASP) that is varied off. VARYON The relational database is associated with an independent auxiliary storage pool (IASP) that is varied on, but not yet available. UNKNOWN The status of the relational database is unknown. The status of remote relational databases is always unknown.
CATALOG_TYPE	RDBTYPE	CHAR(7)	Relational database type. LOCAL The relational database is local to this system. MIRROR The relational database is defined for a Db2 Mirror relationship. REMOTE The relational database is on a remote system.
CATALOG_ASPGRP	RDBASPGRP	VARCHAR(10) Nullable	Independent auxiliary storage pool (IASP) name. Contains the null value if the relational database status is UNKNOWN.
CATALOG_ASPNUM	RDBASPNUM	VARCHAR(10) Nullable	Independent auxiliary storage pool (IASP) number. Contains the null value if the relational database status is UNKNOWN.
CATALOG_TEXT	RDBTEXT	VARGRAPHIC(50) CCSID 1200 Nullable	Relational database text description.

SYSCHKCST

The SYSCHKCST view contains one row for each check constraint in the SQL schema. The following table describes the columns in the SYSCHKCST view.

Table 160. SYSCHKCST view

Column Name	System Column Name	Data Type	Description
CONSTRAINT_SCHEMA	DBNAME	VARCHAR(128)	Name of the schema containing the constraint.
CONSTRAINT_NAME	RELNAME	VARCHAR(128)	Name of the constraint
CHECK_CLAUSE	CHECK	VARGRAPHIC(2000) CCSID 1200 Nullable	Text of the check constraint clause Contains the null value if the check clause cannot be expressed without truncation.
ROUNDING_MODE	DECFLTRND	CHAR(1) Nullable	The rounding mode for the check constraint: C ROUND_CEILING D ROUND_DOWN F ROUND_FLOOR G ROUND_HALF_DOWN E ROUND_HALF_EVEN H ROUND_HALF_UP U ROUND_UP
SYSTEM_CONSTRAINT_SCHEMA	SYS_CDNAME	CHAR(10)	Name of the system schema containing the constraint.
INSERT_ACTION	INS_ACTION	VARGRAPHIC(500) CCSID 1200 Nullable	If an insert violation action has been defined, contains the text of the ON INSERT clause. Otherwise, contains the null value.
UPDATE_ACTION	UPD_ACTION	VARGRAPHIC(500) CCSID 1200 Nullable	If an update violation action has been defined, contains the text of the ON UPDATE clause. Otherwise, contains the null value.

SYSCOLAUTH

The SYSCOLAUTH view contains one row for every privilege granted on a column. Note that this catalog view cannot be used to determine whether a user is authorized to a column because the privilege to use a column could be acquired through a group user profile or special authority (such as *ALLOBJ). Furthermore, the privilege to use a column is also acquired through privileges granted on the table.

The following table describes the columns in the SYSCOLAUTH view:

Table 161. SYSCOLAUTH view

Column Name	System Column Name	Data Type	Description
GRANTOR	GRANTOR	VARCHAR(128) Nullable	Reserved. Contains the null value.
GRANTEE	GRANTEE	VARCHAR(128)	The user profile to which the privilege is granted.
TABLE_SCHEMA	DBNAME	VARCHAR(128)	Name of the schema
TABLE_NAME	TBNAME	VARCHAR(128)	Name of the table
COLUMN_NAME	NAME	VARCHAR(128)	Name of the column
PRIVILEGE_TYPE	PRIVTYPE	VARCHAR(10)	The privilege granted: UPDATE The privilege to update the column. REFERENCES The privilege to reference the column in a referential constraint.
IS_GRANTABLE	GRANTABLE	VARCHAR(3)	Indicates whether the privilege is grantable to other users. NO The privilege is not grantable. YES The privilege is grantable.
AUTHORIZATION_LIST	AUTL	VARCHAR(10) Nullable	Contains the null value.
SYSTEM_TABLE_SCHEMA	SYS_DNAME	CHAR(10)	System name of the schema
SYSTEM_TABLE_NAME	SYS_TNAME	CHAR(10)	System name of the table or view
SYSTEM_COLUMN_NAME	SYS_CNAME	CHAR(10)	System name of the column

SYSCOLUMNS

The SYSCOLUMNS view contains one row for every column of each table and view in the SQL schema (including the columns of the SQL catalog).

The following table describes the columns in the SYSCOLUMNS view:

Table 162. SYSCOLUMNS view

Column name	System Column Name	Data Type	Description
COLUMN_NAME	NAME	VARCHAR(128)	Name of the column. This will be the SQL column name if one exists; otherwise, it will be the system column name.
TABLE_NAME	TBNAME	VARCHAR(128)	Name of the table or view that contains the column. This will be the SQL table or view name if one exists; otherwise, it will be the system table or view name.
TABLE_OWNER	TBCREATOR	VARCHAR(128)	The owner of the table or view.
ORDINAL_POSITION	COLNO	INTEGER	Numeric place of the column in the table or view, ordered from left to right.

Table 162. SYSCOLUMNS view (continued)

Column name	System Column Name	Data Type	Description
DATA_TYPE	COLTYPE	VARCHAR(8)	Type of column: BIGINT Big number INTEGER Large number SMALLINT Small number DECIMAL Packed decimal NUMERIC Zoned decimal FLOAT Floating point; FLOAT, REAL, or DOUBLE PRECISION DECFLOAT Decimal floating-point CHAR Fixed-length character string VARCHAR Varying-length character string CLOB Character large object string GRAPHIC Fixed-length graphic string VARG Varying-length graphic string DBCLOB Double-byte character large object string BINARY Fixed-length binary string VARBIN Varying-length binary string BLOB Binary large object string DATE Date TIME Time TIMESTMP Timestamp DATALINK Datalink ROWID Row ID XML XML DISTINCT Distinct type

Table 162. SYSCOLUMNS view (continued)

Column name	System Column Name	Data Type	Description
LENGTH	LENGTH	INTEGER	<p>The length attribute of the column; or, in the case of a decimal, numeric, or nonzero precision binary column, its precision:</p> <p>8 bytes BIGINT</p> <p>4 bytes INTEGER</p> <p>2 bytes SMALLINT</p> <p>Precision of number DECIMAL</p> <p>Precision of number NUMERIC</p> <p>8 bytes FLOAT, FLOAT(n) where n = 25 to 53, or DOUBLE PRECISION</p> <p>4 bytes FLOAT(n) where n = 1 to 24, or REAL</p> <p>8 bytes DECFLOAT(16)</p> <p>16 bytes DECFLOAT(34)</p> <p>Length of string CHAR</p> <p>Maximum length of string VARCHAR or CLOB</p> <p>Length of graphic string GRAPHIC</p> <p>Maximum length of graphic string VARGRAPHIC or DBCLOB</p> <p>Length of string BINARY</p> <p>Maximum length of binary string VARBIN or BLOB</p> <p>4 bytes DATE</p> <p>3 bytes TIME</p> <p>The integral part of $((p+1)/2)+7$ where p is the precision of the timestamp TIMESTAMP</p> <p>Maximum length of datalink URL and comment DATALINK</p> <p>40 bytes ROWID</p> <p>2147483647 bytes XML</p> <p>Same value as the source type DISTINCT</p>
NUMERIC_SCALE	SCALE	INTEGER Nullable	<p>Scale of numeric data.</p> <p>Contains the null value if the column is not decimal, numeric, or binary.</p>
IS_NULLABLE	NULLS	CHAR(1)	<p>If the column can contain null values:</p> <p>N No</p> <p>Y Yes</p>

Table 162. SYSCOLUMNS view (continued)

Column name	System Column Name	Data Type	Description
IS_UPDATABLE	UPDATES	CHAR(1)	If the column can be updated: N No Y Yes
LONG_COMMENT	REMARKS	VARGRAPHIC(2000) CCSID 1200 Nullable	A character string supplied with the COMMENT statement. Contains the null value if there is no long comment.
HAS_DEFAULT	DEFAULT	CHAR(1)	If the column has a default value (DEFAULT clause or null capable): N No Y Yes A The column has a ROWID data type and the GENERATED ALWAYS attribute. D The column has a ROWID data type and the GENERATED BY DEFAULT attribute. E The column is defined with the FOR EACH ROW ON UPDATE and the GENERATED ALWAYS attribute. F The column is defined with the FOR EACH ROW ON UPDATE and the GENERATED BY DEFAULT attribute. I The column is defined with the AS IDENTITY and GENERATED ALWAYS attributes. J The column is defined with the AS IDENTITY and GENERATED BY DEFAULT attributes. Q The column is defined with the GENERATED AS ROW BEGIN attribute. R The column is defined with the GENERATED AS ROW END attribute. X The column is defined with the GENERATED AS TRANSACTION START ID attribute. a The column is defined as a generated expression using a special register. c The column is defined as a generated expression using a global variable. d The column is defined as a generated expression using DATA CHANGE OPERATION. If the column is for a view, N is returned.
COLUMN_HEADING	LABEL	VARGRAPHIC(60) CCSID 1200 Nullable	A character string supplied with the LABEL statement (column headings) Contains the null value if there is no column heading.

Table 162. SYSCOLUMNS view (continued)

Column name	System Column Name	Data Type	Description
STORAGE	STORAGE	INTEGER	<p>The storage requirements for the column:</p> <p>8 bytes BIGINT</p> <p>4 bytes INTEGER</p> <p>2 bytes SMALLINT</p> <p>(Precision/2) + 1 DECIMAL</p> <p>Precision of number NUMERIC</p> <p>8 bytes FLOAT, FLOAT(n) where n = 25 to 53, or DOUBLE PRECISION</p> <p>4 bytes FLOAT(n) where n = 1 to 24, or REAL</p> <p>8 bytes DECFLOAT(16)</p> <p>16 bytes DECFLOAT(34)</p> <p>Length of string CHAR or BINARY</p> <p>Maximum length of string + 2 VARCHAR or VARBIN</p> <p>Maximum length of string + 29 CLOB or BLOB</p> <p>Length of string * 2 GRAPHIC</p> <p>Maximum length of string * 2 + 2 VARGRAPHIC</p> <p>Maximum length of string * 2 + 29 DBCLOB</p> <p>4 bytes DATE</p> <p>3 bytes TIME</p> <p>The integral part of $((p+1)/2)+7$ where p is the precision of the timestamp TIMESTAMP</p> <p>Maximum length of datalink URL and comment + 24 DATALINK</p> <p>42 bytes ROWID</p> <p>2147483647 bytes XML</p> <p>Same value as the source type DISTINCT</p> <p>Note: This column supplies the storage requirements for all data types.</p>
NUMERIC_PRECISION	PRECISION	INTEGER Nullable	<p>The precision of all numeric columns.</p> <p>Note: This column supplies the precision of all numeric data types, including decimal floating-point and single- and double-precision floating point. The NUMERIC_PRECISION_RADIX column indicates if the value in this column is in binary or decimal digits.</p> <p>Contains the null value if the column is not numeric.</p>

Table 162. SYSCOLUMNS view (continued)

Column name	System Column Name	Data Type	Description
CCSID	CCSID	INTEGER Nullable	The CCSID value for CHAR, VARCHAR, CLOB, DATE, TIME, TIMESTAMP, GRAPHIC, VARGRAPHIC, DBCLOB, XML, and DATALINK columns. Contains 65535 if the column is a BINARY, VARBIN, BLOB, or ROWID. Contains the null value if the column is a numeric data type.
TABLE_SCHEMA	DBNAME	VARCHAR(128)	The name of the SQL schema containing the table or view.
COLUMN_DEFAULT	DFTVALUE	VARGRAPHIC(2000) CCSID 1200 Nullable	The default value of a column, if one exists. If the default value of the column cannot be represented without truncation, then the value of the column is the string 'TRUNCATED'. The default value is stored in character form. The following special values also exist: CURRENT_DATE The default value is the current date. CURRENT_TIME The default value is the current time. CURRENT_TIMESTAMP The default value is the current timestamp. NULL The default value is the null value and DEFAULT NULL was explicitly specified. USER The default value is the current job user. special-register When column HAS_DEFAULT contains the value 'a', the name of the special register. global-variable When column HAS_DEFAULT contains the value 'c', the qualified name of the global variable. DATA CHANGE OPERATION When column HAS_DEFAULT contains the value 'd'. Contains the null value if: <ul style="list-style-type: none"> The column has no default value. For example, if the column has an IDENTITY attribute, is a row ID, or is a row change timestamp, row begin, row end, or transaction start ID column; or A DEFAULT value was not explicitly specified.
CHARACTER_MAXIMUM_LENGTH	CHARLEN	INTEGER Nullable	Maximum length of the string for binary, character, and graphic string and XML data types. Contains the null value if the column is not a string.
CHARACTER_OCTET_LENGTH	CHARBYTE	INTEGER Nullable	Number of bytes for binary, character, and graphic string and XML data types. Contains the null value if the column is not a string.
NUMERIC_PRECISION_RADIX	RADIX	INTEGER Nullable	Indicates if the precision specified in column NUMERIC_PRECISION is specified as a number of binary or decimal digits 2 Binary; floating-point precision is specified in binary digits. 10 Decimal; all other numeric types are specified in decimal digits. Contains the null value if the column is not numeric.

Table 162. SYSCOLUMNS view (continued)

Column name	System Column Name	Data Type	Description
DATETIME_PRECISION	DATPRC	INTEGER Nullable	The fractional part of a date, time, or timestamp. 0 For DATE and TIME data types 0-12 For TIMESTAMP data types (number of fractional seconds). Contains the null value if the column is not a date, time, or timestamp.
COLUMN_TEXT	LABELTEXT	VARGRAPHIC(50) CCSID 1200 Nullable	A character string supplied with the LABEL statement (column text) Contains the null value if the column has no column text.
SYSTEM_COLUMN_NAME	SYS_CNAME	CHAR(10)	The system name of the column
SYSTEM_TABLE_NAME	SYS_TNAME	CHAR(10)	The system name of the table or view
SYSTEM_TABLE_SCHEMA	SYS_DNAME	CHAR(10)	The system name of the schema
USER_DEFINED_TYPE_SCHEMA	TYPESHEMA	VARCHAR(128) Nullable	The name of the schema if this is a distinct type. Contains the null value if the column is not a distinct type.
USER_DEFINED_TYPE_NAME	TYPENAME	VARCHAR(128) Nullable	The name of the distinct type. Contains the null value if the column is not a distinct type.
IS_IDENTITY	IDENTITY	VARCHAR(3)	This column identifies whether the column is an identity column. NO The column is not an identity column. YES The column is an identity column.
IDENTITY_GENERATION	GENERATED	VARCHAR(10) Nullable	This column identifies whether the column is GENERATED ALWAYS or GENERATED BY DEFAULT. ALWAYS The column value is always generated. BY DEFAULT The column value is generated by default. Contains the null value if the column is not a ROWID, identity, row change timestamp, row begin, row end, transaction start ID, or generated expression.
IDENTITY_START	START	DECIMAL(31,0) Nullable	Starting value of the identity column. Contains the null value if the column is not an IDENTITY column.
IDENTITY_INCREMENT	INCREMENT	DECIMAL(31,0) Nullable	Increment value of the identity column. Contains the null value if the column is not an IDENTITY column.
IDENTITY_MINIMUM	MINVALUE	DECIMAL(31,0) Nullable	Minimum value of the identity column. Contains the null value if the column is not an IDENTITY column.
IDENTITY_MAXIMUM	MAXVALUE	DECIMAL(31,0) Nullable	Maximum value of the identity column. Contains the null value if the column is not an IDENTITY column.

Table 162. SYSCOLUMNS view (continued)

Column name	System Column Name	Data Type	Description
IDENTITY_CYCLE	CYCLE	VARCHAR(3) Nullable	<p>This column identifies whether the identity column values will continue to be generated after the minimum or maximum value has been reached.</p> <p>NO Values will not continue to be generated.</p> <p>YES Values will continue to be generated.</p> <p>Contains the null value if the column is not an IDENTITY column.</p>
IDENTITY_CACHE	CACHE	INTEGER Nullable	<p>Specifies the number of identity values that may be preallocated for faster access. Zero indicates that the values will not be preallocated.</p> <p>Contains the null value if the column is not an IDENTITY column.</p>
IDENTITY_ORDER	ORDER	VARCHAR(3) Nullable	<p>Specifies whether the identity values must be generated in order of the request.</p> <p>NO Values do not need to be generated in order of the request.</p> <p>YES Values must be generated in order of the request.</p> <p>Contains the null value if the column is not an IDENTITY column.</p>
COLUMN_EXPRESSION	EXPRESSION	DBCLOB(2097152) CCSID 1200 Nullable	<p>If the column is an expression, contains the expression.</p> <p>Contains the null value if the column is not an expression.</p>
HIDDEN	HIDDEN	CHAR(1)	<p>Specifies whether the column is included in an implicit column list.</p> <p>P Partially hidden.</p> <p>N Not hidden.</p>
HAS_FLDPROC	FLDPROC	CHAR(1)	<p>Specifies whether the column has a field procedure.</p> <p>N Column does not have a field procedure.</p> <p>Y Column has a field procedure.</p>

SYSCOLUMNS2

The SYSCOLUMNS2 view contains one row for every column of each table and view in the SQL schema (including the columns of the SQL catalog).

For information related to a single table or view, a query that uses SYSCOLUMNS2 will typically perform better than querying SYSCOLUMNS. SYSCOLUMNS2 also contains a few more column attributes than SYSCOLUMNS.

The following table describes the columns in the SYSCOLUMNS2 view:

Table 163. SYSCOLUMNS2 view

Column name	System Column Name	Data Type	Description
COLUMN_NAME	NAME	VARCHAR(128)	Name of the column. This will be the SQL column name if one exists; otherwise, it will be the system column name.
TABLE_NAME	TBNAME	VARCHAR(128)	Name of the table or view that contains the column. This will be the SQL table or view name if one exists; otherwise, it will be the system table or view name.
TABLE_OWNER	TBCREATOR	VARCHAR(128)	The owner of the table or view.
ORDINAL_POSITION	COLNO	INTEGER	Numeric place of the column in the table or view, ordered from left to right.

Table 163. SYSCOLUMNS2 view (continued)

Column name	System Column Name	Data Type	Description
DATA_TYPE	COLTYPE	VARCHAR(8)	Type of column: BIGINT Big number INTEGER Large number SMALLINT Small number DECIMAL Packed decimal NUMERIC Zoned decimal FLOAT Floating point; FLOAT, REAL, or DOUBLE PRECISION DECFLOAT Decimal floating-point CHAR Fixed-length character string VARCHAR Varying-length character string CLOB Character large object string GRAPHIC Fixed-length graphic string VARG Varying-length graphic string DBCLOB Double-byte character large object string BINARY Fixed-length binary string VARBIN Varying-length binary string BLOB Binary large object string DATE Date TIME Time TIMESTMP Timestamp DATALINK Datalink ROWID Row ID XML XML DISTINCT Distinct type

Table 163. SYSCOLUMNS2 view (continued)

Column name	System Column Name	Data Type	Description
LENGTH	LENGTH	INTEGER	<p>The length attribute of the column; or, in the case of a decimal, numeric, or nonzero precision binary column, its precision:</p> <p>8 bytes BIGINT</p> <p>4 bytes INTEGER</p> <p>2 bytes SMALLINT</p> <p>Precision of number DECIMAL</p> <p>Precision of number NUMERIC</p> <p>8 bytes FLOAT, FLOAT(n) where n = 25 to 53, or DOUBLE PRECISION</p> <p>4 bytes FLOAT(n) where n = 1 to 24, or REAL</p> <p>8 bytes DECFLOAT(16)</p> <p>16 bytes DECFLOAT(34)</p> <p>Length of string CHAR</p> <p>Maximum length of string VARCHAR or CLOB</p> <p>Length of graphic string GRAPHIC</p> <p>Maximum length of graphic string VARGRAPHIC or DBCLOB</p> <p>Length of string BINARY</p> <p>Maximum length of binary string VARBIN or BLOB</p> <p>4 bytes DATE</p> <p>3 bytes TIME</p> <p>The integral part of $((p+1)/2)+7$ where p is the precision of the timestamp TIMESTAMP</p> <p>Maximum length of datalink URL and comment DATALINK</p> <p>40 bytes ROWID</p> <p>2147483647 bytes XML</p> <p>Same value as the source type DISTINCT</p>
NUMERIC_SCALE	SCALE	INTEGER Nullable	<p>Scale of numeric data.</p> <p>Contains the null value if the column is not decimal, numeric, or binary.</p>
IS_NULLABLE	NULLS	CHAR(1)	<p>If the column can contain null values:</p> <p>N No</p> <p>Y Yes</p>

Table 163. SYSCOLUMNS2 view (continued)

Column name	System Column Name	Data Type	Description
IS_UPDATABLE	UPDATES	CHAR(1)	If the column can be updated: N No Y Yes
LONG_COMMENT	REMARKS	VARGRAPHIC(2000) CCSID 1200 Nullable	A character string supplied with the COMMENT statement. Contains the null value if there is no long comment.
HAS_DEFAULT	DEFAULT	CHAR(1)	If the column has a default value (DEFAULT clause or null capable): N No Y Yes A The column has a ROWID data type and the GENERATED ALWAYS attribute. D The column has a ROWID data type and the GENERATED BY DEFAULT attribute. E The column is defined with the FOR EACH ROW ON UPDATE and the GENERATED ALWAYS attribute. F The column is defined with the FOR EACH ROW ON UPDATE and the GENERATED BY DEFAULT attribute. I The column is defined with the AS IDENTITY and GENERATED ALWAYS attributes. J The column is defined with the AS IDENTITY and GENERATED BY DEFAULT attributes. Q The column is defined with the GENERATED AS ROW BEGIN attribute. R The column is defined with the GENERATED AS ROW END attribute. X The column is defined with the GENERATED AS TRANSACTION START ID attribute. a The column is defined as a generated expression using a special register. c The column is defined as a generated expression using a global variable. d The column is defined as a generated expression using DATA CHANGE OPERATION. If the column is for a view, N is returned.
COLUMN_HEADING	LABEL	VARGRAPHIC(60) CCSID 1200 Nullable	A character string supplied with the LABEL statement (column headings) Contains the null value if there is no column heading.

Table 163. SYSCOLUMNS2 view (continued)

Column name	System Column Name	Data Type	Description
STORAGE	STORAGE	INTEGER	<p>The storage requirements for the column:</p> <p>8 bytes BIGINT</p> <p>4 bytes INTEGER</p> <p>2 bytes SMALLINT</p> <p>(Precision/2) + 1 DECIMAL</p> <p>Precision of number NUMERIC</p> <p>8 bytes FLOAT, FLOAT(n) where n = 25 to 53, or DOUBLE PRECISION</p> <p>4 bytes FLOAT(n) where n = 1 to 24, or REAL</p> <p>8 bytes DECFLOAT(16)</p> <p>16 bytes DECFLOAT(34)</p> <p>Length of string CHAR or BINARY</p> <p>Maximum length of string + 2 VARCHAR or VARBIN</p> <p>Maximum length of string + 29 CLOB or BLOB</p> <p>Length of string * 2 GRAPHIC</p> <p>Maximum length of string * 2 + 2 VARGRAPHIC</p> <p>Maximum length of string * 2 + 29 DECLOB</p> <p>4 bytes DATE</p> <p>3 bytes TIME</p> <p>The integral part of ((p+1)/2)+7 where p is the precision of the timestamp TIMESTAMP</p> <p>Maximum length of datalink URL and comment + 24 DATALINK</p> <p>42 bytes ROWID</p> <p>2147483647 bytes XML</p> <p>Same value as the source type DISTINCT</p> <p>Note: This column supplies the storage requirements for all data types.</p>
NUMERIC_PRECISION	PRECISION	INTEGER Nullable	<p>The precision of all numeric columns.</p> <p>Note: This column supplies the precision of all numeric data types, including decimal floating-point and single- and double-precision floating point. The NUMERIC_PRECISION_RADIX column indicates if the value in this column is in binary or decimal digits.</p> <p>Contains the null value if the column is not numeric.</p>

Table 163. SYSCOLUMNS2 view (continued)

Column name	System Column Name	Data Type	Description
CCSID	CCSID	INTEGER Nullable	The CCSID value for CHAR, VARCHAR, CLOB, DATE, TIME, TIMESTAMP, GRAPHIC, VARGRAPHIC, DBCLOB, XML, and DATALINK columns. Contains 65535 if the column is a BINARY, VARBIN, BLOB, or ROWID. Contains the null value if the column is a numeric data type.
TABLE_SCHEMA	DBNAME	VARCHAR(128)	The name of the SQL schema containing the table or view.
COLUMN_DEFAULT	DFTVALUE	VARGRAPHIC(2000) CCSID 1200 Nullable	The default value of a column, if one exists. If the default value of the column cannot be represented without truncation, then the value of the column is the string 'TRUNCATED'. The default value is stored in character form. The following special values also exist: CURRENT_DATE The default value is the current date. CURRENT_TIME The default value is the current time. CURRENT_TIMESTAMP The default value is the current timestamp. NULL The default value is the null value and DEFAULT NULL was explicitly specified. USER The default value is the current job user. special-register When column HAS_DEFAULT contains the value 'a', the name of the special register. global-variable When column HAS_DEFAULT contains the value 'c', the qualified name of the global variable. DATA CHANGE OPERATION When column HAS_DEFAULT contains the value 'd'. Contains the null value if: <ul style="list-style-type: none"> The column has no default value. For example, if the column has an IDENTITY attribute, is a row ID, or is a row change timestamp, row begin, row end, or transaction start ID column; or A DEFAULT value was not explicitly specified.
CHARACTER_MAXIMUM_LENGTH	CHARLEN	INTEGER Nullable	Maximum length of the string for binary, character, and graphic string and XML data types. Contains the null value if the column is not a string.
CHARACTER_OCTET_LENGTH	CHARBYTE	INTEGER Nullable	Number of bytes for binary, character, and graphic string and XML data types. Contains the null value if the column is not a string.
NUMERIC_PRECISION_RADIX	RADIX	INTEGER Nullable	Indicates if the precision specified in column NUMERIC_PRECISION is specified as a number of binary or decimal digits 2 Binary; floating-point precision is specified in binary digits. 10 Decimal; all other numeric types are specified in decimal digits. Contains the null value if the column is not numeric.

Table 163. SYSCOLUMNS2 view (continued)

Column name	System Column Name	Data Type	Description
DATETIME_PRECISION	DATPRC	INTEGER Nullable	The fractional part of a date, time, or timestamp. 0 For DATE and TIME data types 0-12 For TIMESTAMP data types (number of fractional seconds). Contains the null value if the column is not a date, time, or timestamp.
COLUMN_TEXT	LABELTEXT	VARGRAPHIC(50) CCSID 1200 Nullable	A character string supplied with the LABEL statement (column text) Contains the null value if the column has no column text.
SYSTEM_COLUMN_NAME	SYS_CNAME	CHAR(10)	The system name of the column
SYSTEM_TABLE_NAME	SYS_TNAME	CHAR(10)	The system name of the table or view
SYSTEM_TABLE_SCHEMA	SYS_DNAME	CHAR(10)	The system name of the schema
USER_DEFINED_TYPE_SCHEMA	TYPESHEMA	VARCHAR(128) Nullable	The name of the schema if this is a distinct type. Contains the null value if the column is not a distinct type.
USER_DEFINED_TYPE_NAME	TYPENAME	VARCHAR(128) Nullable	The name of the distinct type. Contains the null value if the column is not a distinct type.
IS_IDENTITY	IDENTITY	VARCHAR(3)	This column identifies whether the column is an identity column. NO The column is not an identity column. YES The column is an identity column.
IDENTITY_GENERATION	GENERATED	VARCHAR(10) Nullable	This column identifies whether the column is GENERATED ALWAYS or GENERATED BY DEFAULT. ALWAYS The column value is always generated. BY DEFAULT The column value is generated by default. Contains the null value if the column is not a ROWID, identity, row change timestamp, row begin, row end, transaction start ID, or generated expression.
IDENTITY_START	START	DECIMAL(31,0) Nullable	Starting value of the identity column. Contains the null value if the column is not an IDENTITY column.
IDENTITY_INCREMENT	INCREMENT	DECIMAL(31,0) Nullable	Increment value of the identity column. Contains the null value if the column is not an IDENTITY column.
IDENTITY_MINIMUM	MINVALUE	DECIMAL(31,0) Nullable	Minimum value of the identity column. Contains the null value if the column is not an IDENTITY column.
IDENTITY_MAXIMUM	MAXVALUE	DECIMAL(31,0) Nullable	Maximum value of the identity column. Contains the null value if the column is not an IDENTITY column.

Table 163. SYSCOLUMNS2 view (continued)

Column name	System Column Name	Data Type	Description
IDENTITY_CYCLE	CYCLE	VARCHAR(3) Nullable	This column identifies whether the identity column values will continue to be generated after the minimum or maximum value has been reached. NO Values will not continue to be generated. YES Values will continue to be generated. Contains the null value if the column is not an IDENTITY column.
IDENTITY_CACHE	CACHE	INTEGER Nullable	Specifies the number of identity values that may be preallocated for faster access. Zero indicates that the values will not be preallocated. Contains the null value if the column is not an IDENTITY column.
IDENTITY_ORDER	ORDER	VARCHAR(3) Nullable	Specifies whether the identity values must be generated in order of the request. NO Values do not need to be generated in order of the request. YES Values must be generated in order of the request. Contains the null value if the column is not an IDENTITY column.
COLUMN_EXPRESSION	EXPRESSION	DBCLOB(2097152) CCSID 1200 Nullable	If the column is an expression, contains the expression. Contains the null value if the column is not an expression.
HIDDEN	HIDDEN	CHAR(1)	Specifies whether the column is included in an implicit column list. P Partially hidden. N Not hidden.
HAS_FLDPROC	FLDPROC	CHAR(1)	Specifies whether the column has a field procedure. N Column does not have a field procedure. Y Column has a field procedure.
INLINE_LENGTH	ALLOCATE	INTEGER Nullable	Specifies the allocated length (ALLOCATE) for a varying length column. Contains the null value if the column is not varying length.
NORMALIZE	NORMALIZE	CHAR(1) Nullable	Specifies whether the column data should be normalized when passed from the application. 0 Column should not be normalized. 1 Column should be normalized. Contains the null value if the column does not contain Unicode data.

Table 163. SYSCOLUMNS2 view (continued)

Column name	System Column Name	Data Type	Description
DATALINK_LINK_CONTROL	DL_LINKC	CHAR(1) Nullable	<p>Specifies whether a check will be performed to determine if the DATALINK column's linked files exist.</p> <p>0 No check will be performed.</p> <p>1 A check will be performed.</p> <p>Contains the null value if the data type of the column is not DATALINK.</p>
DATALINK_INTEGRITY	DL_INTEG	CHAR(1) Nullable	<p>Specifies the level of integrity of the link between the DATALINK value and the linked files.</p> <p>0 ALL</p> <p>Contains the null value if the data type of the column is not DATALINK or if the datalink has NO LINK CONTROL.</p>
DATALINK_READ_PERMISSION	DL_READP	CHAR(1) Nullable	<p>Specifies how permission to read the file specified in the DATALINK value is determined.</p> <p>0 FS</p> <p>1 DB</p> <p>Contains the null value if the data type of the column is not DATALINK or if the datalink has NO LINK CONTROL.</p>
DATALINK_WRITE_PERMISSION	DL_WRITEP	CHAR(1) Nullable	<p>Specifies how permission to write to the file specified in the DATALINK value is determined.</p> <p>0 FS</p> <p>1 BLOCKED</p> <p>Contains the null value if the data type of the column is not DATALINK or if the datalink has NO LINK CONTROL.</p>
DATALINK_RECOVERY	DL_RECOVER	CHAR(1) Nullable	<p>Specifies whether point in time recovery of the linked files of the DATALINK column is supported.</p> <p>0 NO</p> <p>Contains the null value if the data type of the column is not DATALINK or if the datalink has NO LINK CONTROL.</p>
DATALINK_UNLINK_CONTROL	DL_UNLINKC	CHAR(1) Nullable	<p>Specifies the action the DataLink File Manager will take when a file is unlinked.</p> <p>0 RESTORE</p> <p>1 DELETE</p> <p>Contains the null value if the data type of the column is not DATALINK or if the datalink has NO LINK CONTROL.</p>
DDS_TYPE	DDS_TYPE	CHAR(1) Nullable	<p>Specifies the Data Description Specification (DDS) data type for the column. See the following link for the list DDS data types: https://www.ibm.com/support/knowledgecenter/ssw_ibm_i_74/rzakb/ldata.htm</p>

Table 163. SYSCOLUMNS2 view (continued)

Column name	System Column Name	Data Type	Description
SECURE	SECURE	CHAR(1) Nullable	Specifies whether the column contains data that should be secured in a database monitor or plan cache. 0 The column does not contain data that needs to be secured in a database monitor or plan cache. 1 The column contains data that needs to be secured in a database monitor or plan cache.
DATE_FORMAT	DATFMT	CHAR(3) Nullable	Date format for the column. Contains the null value if this column is not a date.
DATE_SEPARATOR	DATSEP	CHAR(1) Nullable	Date separator for the column. Contains the null value if this column is not a date or if there is no separator value.
TIME_FORMAT	TIMFMT	CHAR(3) Nullable	Time format for the column. Contains the null value if this column is not a time.
TIME_SEPARATOR	TIMSEP	CHAR(1) Nullable	Time separator for the column. Contains the null value if this column is not a time or if there is no separator value.
REFERENCE_LIBRARY	REFFLD_LIB	VARCHAR(10) Nullable	Library for the reference field. Contains the null value if there is no reference information for this column.
REFERENCE_FILE	REFFLD_FIL	VARCHAR(10) Nullable	File for the reference field. Contains the null value if there is no reference information for this column.
REFERENCE_FORMAT	REFFLD_FMT	VARCHAR(10) Nullable	Record format name for the reference field. Contains the null value if there is no reference information for this column.
REFERENCE_FIELD	REFFLD	VARCHAR(10) Nullable	Reference field name Contains the null value if there is no reference information for this column.
EDIT_CODE	EDTCDE	CHAR(1) Nullable	The edit code for this column. Contains the null value if there is no edit code.
EDIT_CODE_FILL	EDTCDEFILL	CHAR(1) Nullable	Contains an * if the edit code uses asterisk fill. Any other character is the floating currency symbol. Contains the null value if there is no edit code or if there is no fill character.
EDIT_WORD	EDTWRD	VARCHAR(65) Nullable	The edit word for this column. Contains the null value if there is no edit word.
COLUMN_USAGE	USAGE	VARCHAR(5)	Usage for the column. BOTH The column can be used for both input and output. INPUT The column can be used for input only. This means the data can be read but not changed.
JOIN_REFERENCE	JREF	INTEGER Nullable	For columns whose names are specified in more than one physical file, this value identifies which physical file contains the field. Contains the null value if there is no join reference value.

Table 163. SYSCOLUMNS2 view (continued)

Column name	System Column Name	Data Type	Description
INTERNAL_FIELD_NAME	FIELD_I	VARCHAR(10) Nullable	Internal field name. The name of the physical format field. If this is a logical format, the name of the physical field on which the logical field is based. Contains the null value if there is no internal field name.

SYSCOLUMNS2_SESSION

The SYSCOLUMNS2_SESSION view contains one row for every column of each table and view in the SESSION (or QTEMP) schema.

The columns returned by the SYSCOLUMNS2_SESSION view are identical to the columns in the SYSCOLUMNS2 view. See [“SYSCOLUMNS2”](#) on page 1718.

SYSCOLUMNSTAT

The SYSCOLUMNSTAT view contains one row for every column in a table partition or table member that has a column statistics collection. If the table is a distributed table, the partitions that reside on other database nodes are not contained in this catalog view.

They are contained in the catalog views of the other database nodes. The following table describes the columns in the SYSCOLUMNSTAT view:

Table 164. SYSCOLUMNSTAT view

Column name	System Column Name	Data Type	Description
TABLE_SCHEMA	TABSCHEMA	VARCHAR(128)	Name of the SQL schema that contains the table.
TABLE_NAME	TABNAME	VARCHAR(128)	Name of the table.
TABLE_PARTITION	TABPART	VARCHAR(128)	Name of the table partition or member.
PARTITION_TYPE	PARTTYPE	CHAR(1)	The type of the table partitioning: blank The table is not partitioned. H This is data hash partitioning. R This is data range partitioning. D This is distributed database hash partitioning.
PARTITION_NUMBER	PARTNBR	INTEGER Nullable	The partition number of this partition. If the table is a distributed table, contains null.
NUMBER_DISTRIBUTED_PARTITIONS	DSTPARTS	INTEGER Nullable	If the table is a distributed table, contains the total number of partitions. If the table is not a distributed table, contains null.
NUMBER_COLUMN_NAMES	NBRCOLS	INTEGER	Number of column names in this collection. If only individual column statistics are wanted, only select rows where NUMBER_COLUMN_NAMES is one. Currently, only one name is returned.
COLUMN_NAME	COLNAME	VARCHAR(1280)	Name of the column(s). Up to 10 columns may be returned. Currently, only one name is returned.
NUMBER_DISTINCT_VALUES	COLCARD	BIGINT	Number of distinct values in the column. This is an estimated value determined by the statistics engine at the time that the column statistics were last collected. Contains -1 if statistics are not collected.
HIGH2KEY	HIGH2KEY	VARCHAR(254)	Not applicable for Db2 for i. Contains the empty string.
LOW2KEY	LOW2KEY	VARCHAR(254)	Not applicable for Db2 for i. Contains the empty string.
AVERAGE_COLUMN_LENGTH	AVGCOLLEN	INTEGER	Not applicable for Db2 for i. Will always be -1.
NUMBER_NULLS	NUMNULLS	BIGINT	The estimated number of NULL values. -1 if statistics are not collected.
SUB_COUNT	SUB_COUNT	SMALLINT	Not applicable for Db2 for i. Will always be -1.
SUB_DELIM_LENGTH	SUBDLENGTH	SMALLINT	Not applicable for Db2 for i. Will always be -1.
NUMBER_HISTOGRAM_RANGES	NQUANTILES	INTEGER	Number of histogram ranges available for this statistics collection. The actual histogram range values can be obtained using the List Statistics Collection Details (QDBSTLDS, QdbstListDetailStatistics) API. Contains -1 if statistics are not collected.
NUMBER_MOST_FREQUENT_VALUES	NMOSTFREQ	INTEGER	Number of most frequent values available. The actual most frequent values can be obtained using the List Statistics Collection Details (QDBSTLDS, QdbstListDetailStatistics) API. Contains -1 if statistics are not collected.

Table 164. SYSCOLUMNSTAT view (continued)

Column name	System Column Name	Data Type	Description
AVGDISTINCTPERPAGE	AVGDSTPAGE	DOUBLE Nullable	Not applicable for Db2 for i. Will always be NULL.
PAGEVARIANCERATIO	PVARRATIO	DOUBLE Nullable	Not applicable for Db2 for i. Will always be NULL.
STATISTICS_NAME	STATNAME	VARCHAR(128) Nullable	Unique name of this statistics collection for this table partition. NULL if statistics are not collected.
INTERNAL_STATISTICS_ID	STATID	VARCHAR(16) FOR BIT DATA Nullable	Internal statistics identifier of this statistics collection for this table partition. NULL if statistics are not collected.
STATISTIC_CREATED	STATCREATE	TIMESTAMP Nullable	Timestamp when the statistics collection was created. NULL if statistics are not collected.
STATISTIC_CREATOR	STATCUSER	VARCHAR(128) Nullable	User that created the statistic collection. *SYS if the system created the statistic collection. NULL if statistics are not collected.
STATISTIC_LAST_UPDATED	UPDATEDTS	TIMESTAMP Nullable	Timestamp when the statistics collection was last updated. NULL if statistics are not collected.
STATISTIC_UPDATER	STATUUSER	VARCHAR(128) Nullable	User that last updated the statistic collection. *SYS if the system automatically updated the statistic collection. NULL if statistics are not collected.
STATISTICS_SIZE	STATSIZE	BIGINT Nullable	Size of the statistics collection for this table partition. NULL if statistics are not collected.
AGING_MODE	AGING_MODE	VARCHAR(10)	Indicates whether the system can automatically age or remove statistics collections for this table partition. *SYS The statistic collection will be automatically refreshed or removed by the system when necessary. *USER The statistic collection will only be refreshed or removed when explicitly requested by the user.
AGING_STATUS	AGING_STS	CHAR(1) Nullable	Indicates how current the statistics collection is for this table partition. 0 There are no indications that the statistics data needs to be refreshed. 1 There are indications that the statistics data needs to be refreshed. NULL if statistics are not collected.
BLOCK_OPTION	BLKOPTION	CHAR(1)	Indicates whether automatic statistics collection create requests are allowed for this table partition. 0 Automatic system initiated statistics collections are not blocked. 1 Automatic system initiated statistics collections are blocked.
CURRENT_LAST_CHANGE	UPDATED	TIMESTAMP Nullable	Timestamp when the data in the table partition was last changed. NULL if statistics are not collected.
CURRENT_ROWS	CURROWS	BIGINT Nullable	Current number of valid rows in the table partition. NULL if statistics are not collected.

Table 164. SYSCOLUMNSTAT view (continued)

Column name	System Column Name	Data Type	Description
CURRENT_DELETED_ROWS	CURDELROWS	BIGINT Nullable	Current number of deleted rows in the table partition. NULL if statistics are not collected.
CURRENT_DATA_CHANGES	CURDATACHG	BIGINT Nullable	The number of inserts, updates, and deletes that have ever occurred to this table partition. NULL if statistics are not collected.
STATISTICS_ROWS	STATROWS	BIGINT Nullable	Number of valid rows in the table partition at the time the statistic was collected. NULL if statistics are not collected.
STATISTICS_DELETED_ROWS	STATDELROW	BIGINT Nullable	Number of deleted rows in the table partition at the time the statistic was collected. NULL if statistics are not collected.
STATISTICS_DATA_CHANGES	STATDATCHG	BIGINT Nullable	Number of inserts, updates, and deletes that had occurred to the table partition at the time the statistic was collected. NULL if statistics are not collected.
TRANSLATION_ATTRIBUTES	TRANSATRS	VARCHAR(10) Nullable	Indicates the type of translations that were used on data values when the statistic was collected. 0 Unique weight translation. 1 Shared weight translation. 9 No translation. If multiple columns are used in this collection, multiple translations are possible. Currently, only one translation is returned.
TRANSLATION_TABLES	TRANSTBLS	VARCHAR(210) Nullable	Qualified names of the translation tables, if translation tables were used on the statistic collection. The empty string is returned if no translation table was used. NULL if statistics are not collected. If multiple columns are used in this collection, multiple translation tables are possible. Currently, only one translation table is returned.
SYSTEM_TABLE_SCHEMA	SYS_DNAME	CHAR(10)	System schema name.
SYSTEM_TABLE_NAME	SYS_TNAME	CHAR(10)	System table name.
SYSTEM_TABLE_MEMBER	SYS_MNAME	CHAR(10)	System member name.
SYSTEM_COLUMN_NAME	SYS_CNAME	VARCHAR(100)	System column name. An array of up to 10 names are possible. Currently, only one name is returned.

SYSCONTROLS

The SYSCONTROLS view contains one row for each row permission or column mask defined by the CREATE PERMISSION or CREATE MASK statements.

The following table describes the columns in the SYSCONTROLS view:

Table 165. SYSCONTROLS view

Column Name	System Column Name	Data Type	Description
RCAC_SCHEMA	SCHEMA	VARCHAR(128)	Schema name of the row permission or column mask.
RCAC_NAME	NAME	VARCHAR(128)	Name of the row permission or column mask.
RCAC_OWNER	CREATOR	VARCHAR(128)	Creator of the row permission or column mask.
TABLE_SCHEMA	TBSHEMA	VARCHAR(128)	Schema name of the table for which the row permission or column mask is defined.
TABLE_NAME	TBNAME	VARCHAR(128)	Name of the table for which the row permission or column mask is defined.
TBCORRELATION	TBCORRNAME	VARCHAR(128)	The correlation name of the table for which the row permission or column mask is defined. If not specified, a value is generated.
COLUMN_NAME	COLNAME	VARCHAR(128)	Column name for which the column mask is defined. Contains a blank for a row permission.
SYSTEM_COLUMN_NAME	SYS_CNAME	CHAR(10)	The system name of the column. Contains a blank for a row permission
SYSTEM_TABLE_NAME	SYS_TNAME	CHAR(10)	The system name of the table.
SYSTEM_TABLE_SCHEMA	SYS_DNAME	CHAR(10)	The system name of the schema.
CONTROL_TYPE	CONTROLTYP	CHAR(1)	Indicates the type of access control: R Row permission M Column mask
ENFORCED	ENFORCED	CHAR(1)	Indicates the type of access enforced by the row permission. Column mask is always 'A': A All access
IMPLICIT	IMPLICIT	CHAR(1)	Indicates whether the row permission was implicitly created: N The row permission was not implicitly created or this is a column mask. Y Row permission was implicitly created.
ENABLE	ENABLE	CHAR(1)	Indicates whether the row permission or the column mask is enabled for access control: N Not enabled Y Enabled
CREATE_TIME	CREATEDTS	TIMESTAMP	Identifies the timestamp when the row permission or column mask was created.
LAST_ALTERED	ALTERDTS	TIMESTAMP Nullable	Identifies the timestamp when the row permission or column mask was last changed. Contains the null value if it has never been altered.
IASP_NUMBER	IASPNUMBER	SMALLINT	Specifies the independent auxiliary storage pool (IASP) number.

Table 165. SYSCONTROLS view (continued)

Column Name	System Column Name	Data Type	Description
LABEL	LABEL	VARGRAPHIC(50) CCSID 1200 Nullable	A character string provided by the LABEL statement. Contains the null value if a label does not exist.
LONG_COMMENT	REMARKS	VARGRAPHIC(2000) CCSID 1200 Nullable	A character string supplied with the COMMENT statement. Contains the null value if there is no long comment.
RULETEXT	RULETEXT	DBCLOB(2M) CCSID 1200	The source text of the search condition or expression portion of the CREATE PERMISSION or CREATE MASK statement.

SYSCONTROLSDEP

The SYSCONTROLSDEP view records the dependencies of row permissions and column masks.

The following table describes the columns in the SYSCONTROLSDEP view:

Table 166. SYSCONTROLSDEP view

Column Name	System Column Name	Data Type	Description
RCAC_SCHEMA	SCHEMA	VARCHAR(128)	Schema name of the row permission or column mask.
RCAC_NAME	NAME	VARCHAR(128)	Name of the row permission or column mask.
CONTROL_TYPE	CONTROLTYP	CHAR(1)	Indicates the type of access control: R Row permission M Column mask
OBJECT_SCHEMA	BSHEMA	VARCHAR(128)	Name of the schema that contains the object.
OBJECT_NAME	BNAME	VARCHAR(128)	Name of the object the row permission or column mask is dependent on.
OBJECT_TYPE	BTYPE	CHAR(24)	Indicates the object type of the object referenced in the row permission or column mask. COLUMN The object is a column in a table. FUNCTION The object is a function. MATERIALIZED QUERY TABLE The object is a materialized query table. SEQUENCE The object is a sequence. TABLE The object is a table. TYPE The object is a distinct type. VARIABLE The object is a variable. VIEW The object is a view.
COLUMN_NAME	BCOLNAME	VARCHAR(128)	Column name for the object when OBJECT_TYPE has a value of 'COLUMN'. In this case, OBJECT_NAME contains the table name for the column. Contains a blank if object is not a column.
SYSTEM_TABLE_NAME	SYS_TNAME	CHAR(10)	The system name of the table upon which the row permission or column mask is defined.
SYSTEM_TABLE_SCHEMA	SYS_DNAME	CHAR(10)	The system name of the schema of the table upon which the row permission or column mask is defined.
IASP_NUMBER	IASPNUMBER	SMALLINT	Specifies the independent auxiliary storage pool (IASP) number.
PARM_SIGNATURE	SIGNATURE	BLOB(3M) Nullable	This column identifies the routine signature. Contains the null value if the object is not a routine.

SYSCST

The SYSCST view contains one row for each constraint in the SQL schema.

The following table describes the columns in the SYSCST view:

Table 167. SYSCST view

Column Name	System Column Name	Data Type	Description
CONSTRAINT_SCHEMA	CDBNAME	VARCHAR(128)	Name of the schema containing the constraint.
CONSTRAINT_NAME	RELNAM	VARCHAR(128)	Name of the constraint.
CONSTRAINT_TYPE	TYPE	VARCHAR(11)	Constraint Type <ul style="list-style-type: none"> • CHECK • UNIQUE • PRIMARY KEY • FOREIGN KEY
TABLE_SCHEMA	TDBNAME	VARCHAR(128)	Name of the schema containing the table.
TABLE_NAME	TBNAME	VARCHAR(128)	Name of the table which the constraint is created over. This will be the SQL table name if it exists; otherwise, it will be the system table name.
IS_DEFERRABLE	ISDEFER	VARCHAR(3)	Indicates whether the constraint checking can be deferred. Will always be 'NO'.
INITIALLY_DEFERRED	INITDEFER	VARCHAR(3)	Indicates whether the constraint was defined as initially deferred. Will always be 'NO'.
SYSTEM_TABLE_NAME	SYS_TNAME	CHAR(10)	System name of the table.
SYSTEM_TABLE_SCHEMA	SYS_DNAME	CHAR(10)	System name of the schema containing the table.
CONSTRAINT_KEYS	COLCOUNT	SMALLINT Nullable	Specifies the number of key columns if this is a UNIQUE, PRIMARY KEY, or FOREIGN KEY constraint. Contains the null value if the constraint is a CHECK constraint.
IASP_NUMBER	IASPNUMBER	SMALLINT	Specifies the independent auxiliary storage pool (IASP) number.
CONSTRAINT_STATE	CST_STATE	VARCHAR(11)	Indicates whether the constraint is established or defined: <p>ESTABLISHED The referential constraint is established. The parent table exists.</p> <p>DEFINED The referential constraint is defined. The parent table does not exist.</p>
ENABLED	ENABLED	VARCHAR(3) Nullable	Indicates whether the constraint is enabled: <p>NO The constraint is disabled.</p> <p>YES The constraint is enabled.</p> <p>Contains the null value if the constraint is defined or is a unique constraint.</p>
CHECK_PENDING	CHECKFLAG	VARCHAR(3) Nullable	Indicates whether the constraint is in check pending state: <p>NO The constraint is not in check pending.</p> <p>YES The constraint is in check pending.</p> <p>Contains the null value if the constraint is defined, disabled, or is a unique constraint.</p>

Table 167. SYSCST view (continued)

Column Name	System Column Name	Data Type	Description
CONSTRAINT_TEXT	LABEL	VARGRAPHIC(50) CCSID 1200 Nullable	A character string provided with the LABEL statement. Contains the null value if there is no label.
LONG_COMMENT	REMARKS	VARGRAPHIC(2000) CCSID 1200 Nullable	A character string supplied with the COMMENT statement. Contains the null value if there is no long comment.
SYSTEM_CONSTRAINT_SCHEMA	SYS_CDNAME	CHAR(10)	Name of the system schema containing the constraint.

SYSCSTCOL

The SYSCSTCOL view records the columns on which constraints are defined. There is one row for every column in a unique, primary key, and check constraint and the referencing columns of a referential constraint.

The following table describes the columns in the SYSCSTCOL view:

Table 168. SYSCSTCOL view

Column Name	System Column Name	Data Type	Description
TABLE_SCHEMA	TDBNAME	VARCHAR(128)	Name of the SQL schema that contains the table the constraint is dependent on.
TABLE_NAME	TBNAME	VARCHAR(128)	Name of the table the constraint is dependent on. This is the SQL table name if it exists; otherwise, it is the system table name.
COLUMN_NAME	COLUMN	VARCHAR(128)	Column that the constraint was created over. This is the SQL column name if it exists; otherwise, it is the system column name.
CONSTRAINT_SCHEMA	CDBNAME	VARCHAR(128)	Name of the schema of the constraint.
CONSTRAINT_NAME	RELNAME	VARCHAR(128)	Name of the constraint.
SYSTEM_COLUMN_NAME	SYS_CNAME	CHAR(10)	System name of the column.
SYSTEM_TABLE_NAME	SYS_TNAME	CHAR(10)	System name of the table.
SYSTEM_TABLE_SCHEMA	SYS_DNAME	CHAR(10)	System name of the schema containing the table.
SYSTEM_CONSTRAINT_SCHEMA	SYS_CDNAME	CHAR(10)	Name of the system schema containing the constraint.

SYSCSTDEP

The SYSCSTDEP view records the tables on which constraints are defined.

The following table describes the columns in the SYSCSTDEP view:

Table 169. SYSCSTDEP view

Column Name	System Column Name	Data Type	Description
TABLE_SCHEMA	TDBNAME	VARCHAR(128)	Name of the SQL schema that contains the table on which the constraint is dependent
TABLE_NAME	TBNAME	VARCHAR(128)	Name of the table on which the constraint is dependent. This is the SQL table name if it exists otherwise it is the system table name.
CONSTRAINT_SCHEMA	CDBNAME	VARCHAR(128)	Name of the schema of the constraint.
CONSTRAINT_NAME	RELNAME	VARCHAR(128)	Name of the constraint.
SYSTEM_TABLE_NAME	SYS_TNAME	CHAR(10)	System name of the table.
SYSTEM_TABLE_SCHEMA	SYS_DNAME	CHAR(10)	System name of the schema containing the table.
IASP_NUMBER	IASPNUMBER	SMALLINT	Specifies the independent auxiliary storage pool (IASP) number.
SYSTEM_CONSTRAINT_SCHEMA	SYS_CDNAME	CHAR(10)	Name of the system schema containing the constraint.

SYSDUMMY1

The SYSDUMMY1 table contains exactly one row. It is used for SQL statements in which a table reference is required, but the contents of the table are not important.

The schema is SYSIBM.

The following table describes the column in the SYSDUMMY1 table:

Table 170. SYSDUMMY1 table

Column name	System Column Name	Data Type	Description
IBMREQD	IBMREQD	VARCHAR(1)	Always contains a value of Y.

SYSFIELDS

The SYSFIELDS view contains one row for every column that has a field procedure.

The column attributes in SYSFIELDS describe the internal column attributes defined by the field procedure. The following table describes the columns in the SYSFIELDS view:

Table 171. SYSFIELDS view

Column name	System Column Name	Data Type	Description
TABLE_SCHEMA	DBNAME	VARCHAR(128)	The name of the SQL schema containing the table.
TABLE_NAME	TBNAME	VARCHAR(128)	Name of the table that contains the column. This will be the SQL table name if one exists; otherwise, it will be the system table name.
COLUMN_NAME	NAME	VARCHAR(128)	Name of the column. This will be the SQL column name if one exists; otherwise, it will be the system column name.
ORDINAL_POSITION	COLNO	INTEGER	Numeric place of the column in the table, ordered from left to right.

Table 171. SYSFIELDS view (continued)

Column name	System Column Name	Data Type	Description
DATA_TYPE	COLTYPE	VARCHAR(8)	Type of column: BIGINT Big number INTEGER Large number SMALLINT Small number DECIMAL Packed decimal NUMERIC Zoned decimal FLOAT Floating point; FLOAT, REAL, or DOUBLE PRECISION DECFLOAT Decimal floating-point CHAR Fixed-length character string VARCHAR Varying-length character string CLOB Character large object string GRAPHIC Fixed-length graphic string VARG Varying-length graphic string DBCLOB Double-byte character large object string BINARY Fixed-length binary string VARBIN Varying-length binary string BLOB Binary large object string DATE Date TIME Time TIMESTAMP Timestamp DATALINK Datalink ROWID Row ID XML XML DISTINCT Distinct type

Table 171. SYSFIELDS view (continued)

Column name	System Column Name	Data Type	Description
LENGTH	LENGTH	INTEGER	<p>The length attribute of the column; or, in the case of a decimal, numeric, or nonzero precision binary column, its precision:</p> <p>8 bytes BIGINT</p> <p>4 bytes INTEGER</p> <p>2 bytes SMALLINT</p> <p>Precision of number DECIMAL</p> <p>Precision of number NUMERIC</p> <p>8 bytes FLOAT, FLOAT(n) where n = 25 to 53, or DOUBLE PRECISION</p> <p>4 bytes FLOAT(n) where n = 1 to 24, or REAL</p> <p>8 bytes DECFLOAT(16)</p> <p>16 bytes DECFLOAT(34)</p> <p>Length of string CHAR</p> <p>Maximum length of string VARCHAR or CLOB</p> <p>Length of graphic string GRAPHIC</p> <p>Maximum length of graphic string VARGRAPHIC or DBCLOB</p> <p>Length of string BINARY</p> <p>Maximum length of binary string VARBIN or BLOB</p> <p>4 bytes DATE</p> <p>3 bytes TIME</p> <p>The integral part of $((p+1)/2)+7$ where p is the precision of the timestamp TIMESTAMP</p> <p>Maximum length of datalink URL and comment DATALINK</p> <p>40 bytes ROWID</p> <p>2147483647 bytes XML</p> <p>Same value as the source type DISTINCT</p>
CHARACTER_MAXIMUM_LENGTH	CHARLEN	INTEGER Nullable	<p>Maximum length of the string for binary, character, and graphic string and XML data types.</p> <p>Contains the null value if the column is not a string.</p>
CHARACTER_OCTET_LENGTH	CHARBYTE	INTEGER Nullable	<p>Number of bytes for binary, character, and graphic string and XML data types.</p> <p>Contains the null value if the column is not a string.</p>
NUMERIC_SCALE	SCALE	INTEGER Nullable	<p>Scale of numeric data.</p> <p>Contains the null value if the column is not decimal, numeric, or binary.</p>

Table 171. SYSFIELDS view (continued)

Column name	System Column Name	Data Type	Description
NUMERIC_PRECISION	PRECISION	INTEGER Nullable	The precision of all numeric columns. Note: This column supplies the precision of all numeric data types, including decimal floating-point and single- and double-precision floating point. The NUMERIC_PRECISION_RADIX column indicates if the value in this column is in binary or decimal digits. Contains the null value if the column is not numeric.
NUMERIC_PRECISION_RADIX	RADIX	INTEGER Nullable	Indicates if the precision specified in column NUMERIC_PRECISION is specified as a number of binary or decimal digits 2 Binary; floating-point precision is specified in binary digits. 10 Decimal; all other numeric types are specified in decimal digits. Contains the null value if the column is not numeric.
CCSID	CCSID	INTEGER Nullable	The CCSID value for CHAR, VARCHAR, CLOB, DATE, TIME, TIMESTAMP, GRAPHIC, VARGRAPHIC, DBCLOB, XML, and DATALINK columns. Contains 65535 if the column is a BINARY, VARBIN, BLOB, or ROWID. Contains the null value if the column is a numeric data type.
DATETIME_PRECISION	DATPRC	INTEGER Nullable	The fractional part of a date, time, or timestamp. 0 For DATE and TIME data types 0-12 For TIMESTAMP data types (number of fractional seconds). Contains the null value if the column is not a date, time, or timestamp.
FIELD_PROC	FLDPROC	VARCHAR(279) Nullable	The name of the procedure.
PARMLIST	PARMLIST	DBCLOB(1M) CCSID 1200 Nullable	The parameter list following FIELDPROC in the statement that defined the field procedure with insignificant blanks removed.
EXITPARM	EXITPARM	BLOB(1M) Nullable	The parameter value block of the field procedure. This is the control block passed to the field procedure when it is invoked.
SYSTEM_COLUMN_NAME	SYS_CNAME	CHAR(10)	The system name of the column
SYSTEM_TABLE_NAME	SYS_TNAME	CHAR(10)	The system name of the table
SYSTEM_TABLE_SCHEMA	SYS_DNAME	CHAR(10)	The system name of the schema

SYSFUNCS

The SYSFUNCS view contains one row for each function created by the CREATE FUNCTION statement.

The following table describes the columns in the SYSFUNCS view:

Table 172. SYSFUNCS view

Column Name	System Column Name	Data Type	Description
SPECIFIC_SCHEMA	SPECSHEMA	VARCHAR(128)	Schema name of the routine (function) instance.
SPECIFIC_NAME	SPECNAME	VARCHAR(128)	Specific name of the routine instance.
ROUTINE_SCHEMA	FUNCSHEMA	VARCHAR(128)	Name of the SQL schema (schema) that contains the routine.
ROUTINE_NAME	FUNCNAME	VARCHAR(128)	Name of the routine.
ROUTINE_CREATED	RTNCREATE	TIMESTAMP	Identifies the timestamp when the routine was created.
ROUTINE_DEFINER	DEFINER	VARCHAR(128)	Name of the user that defined the routine.
ROUTINE_BODY	BODY	VARCHAR(8)	The type of the routine body: EXTERNAL This is an external routine. SQL This is an SQL routine.
EXTERNAL_NAME	EXTNAME	VARCHAR(279) Nullable	This column identifies the external program name. <ul style="list-style-type: none">For SQL functions or ILE service programs, the external program name is <i>schema-name/service-program-name(entry-point-name)</i>.For Java programs, the external program name is an optional jar-id followed by a <i>fully-qualified-class-name!method-name</i> or <i>fully-qualified-class-name.method-name</i>.For all other languages, the external program name is <i>schema-name/program-name</i>. Contains the null value if this is a system-generated function.
EXTERNAL_LANGUAGE	LANGUAGE	VARCHAR(8) Nullable	If this is an external routine, this column identifies the external program's language. C The external program is written in C. C++ The external program is written in C++. CL The external program is written in CL. COBOL The external program is written in COBOL. COBOLLE The external program is written in ILE COBOL. JAVA The external program is written in JAVA. PLI The external program is written in PL/I. RPG The external program is written in RPG. RPGLE The external program is written in ILE RPG. Contains the null value if this is not an external routine.

Table 172. SYSFUNCS view (continued)

Column Name	System Column Name	Data Type	Description
PARAMETER_STYLE	PARM_STYLE	VARCHAR(7) Nullable	<p>If this is an external routine, this column identifies the parameter style (calling convention).</p> <p>DB2SQL This is the DB2SQL calling convention.</p> <p>DB2GNRL This is the DB2GENERAL calling convention.</p> <p>GENERAL This is the GENERAL calling convention.</p> <p>JAVA This is the JAVA calling convention.</p> <p>NULLS This is the GENERAL WITH NULLS calling convention.</p> <p>SQL This is the SQL standard calling convention.</p> <p>Contains the null value if this is not an external routine.</p>
IS_DETERMINISTIC	DETERMINE	VARCHAR(3)	<p>This column identifies whether the routine is deterministic. That is, whether a call to the routine with the same arguments will always return the same result.</p> <p>NO The routine is not deterministic.</p> <p>YES The routine is global deterministic.</p> <p>STM The routine is statement deterministic.</p>
SQL_DATA_ACCESS	DATAACCESS	VARCHAR(8) Nullable	<p>This column identifies whether a routine contains SQL and whether it reads or modifies data.</p> <p>NONE The routine does not contain any SQL statements.</p> <p>CONTAINS The routine contains SQL statements.</p> <p>READS The routine possibly reads data from a table or view.</p> <p>MODIFIES The routine possibly modifies data in a table or view or issues SQL DDL statements.</p>
SQL_PATH	SQL_PATH	VARCHAR(3483) Nullable	<p>If this is an SQL routine, this column identifies the path.</p> <p>Contains the null value if this is an external routine.</p>
PARM_SIGNATURE	SIGNATURE	VARCHAR(16000)	This column identifies the routine signature.
NUMBER_OF_RESULTS	NUMRESULTS	SMALLINT Nullable	Identifies the number of results.
IN_PARMS	IN_PARMS	SMALLINT	Identifies the number of input parameters. 0 indicates that there are no input parameters.
LONG_COMMENT	REMARKS	VARGRAPHIC(2000) CCSID 1200 Nullable	<p>A character string supplied with the COMMENT statement.</p> <p>Contains the null value if there is no long comment.</p>
ROUTINE_DEFINITION	ROUTINEDEF	DBCLOB(2M) CCSID 13488 Nullable	<p>If this is an SQL routine, this column contains the SQL routine body.</p> <p>If this is an obfuscated routine, the text starts with the WRAPPED keyword and is followed by the encoded form of the statement text.</p> <p>Contains the null value if this is not an SQL routine.</p>

Table 172. SYSFUNCS view (continued)

Column Name	System Column Name	Data Type	Description
FUNCTION_ORIGIN	ORIGIN	CHAR(1)	<p>Identifies the type of function. If this is a procedure, this column contains a blank.</p> <p>B This is a built-in function (defined by Db2 for i).</p> <p>E This is a user-defined function.</p> <p>U This is a user-defined function that is based on another function.</p> <p>S This is a system-generated function.</p>
FUNCTION_TYPE	TYPE	CHAR(1)	<p>Identifies the form of the function. If this is a procedure, this column contains a blank.</p> <p>S This is a scalar function.</p> <p>C This is a column function.</p> <p>T This is a table function.</p>
EXTERNAL_ACTION	EXT_ACTION	CHAR(1) Nullable	<p>Identifies the whether the invocation of the function has external effects.</p> <p>E This function has external side effects.</p> <p>N This function does not have any external side effects.</p>
IS_NULL_CALL	NULL_CALL	VARCHAR(3) Nullable	<p>Identifies whether the function needs to be called if an input parameter is the null value.</p> <p>NO This function need not be called if an input parameter is the null value. If this is a scalar function, the result of the function is implicitly null if any of the operands are null. If this is a table function, the result of the function is an empty table if any of the operands are the null value.</p> <p>YES This function must be called even if an input operand is null.</p>
SCRATCH_PAD	SCRATCHPAD	INTEGER Nullable	<p>Identifies whether the address of a static memory area (scratch pad) is passed to the function.</p> <p>0 The function does not have a scratch pad.</p> <p>integer Indicates the size of the scratch pad passed to the function.</p>
FINAL_CALL	FINAL_CALL	VARCHAR(3) Nullable	<p>Indicates whether a final call to the function should be made to allow the function to clean up its work areas (scratch pads).</p> <p>NO No final call is made.</p> <p>YES A final call to the function is made when the statement is complete.</p>
PARALLELIZABLE	PARALLEL	VARCHAR(3) Nullable	<p>Identifies whether the function can be run in parallel.</p> <p>NO The function must be synchronous.</p> <p>YES The function can be run in parallel.</p>

Table 172. SYSFUNCS view (continued)

Column Name	System Column Name	Data Type	Description
DBINFO	DBINFO	VARCHAR(3) Nullable	Identifies whether information about the database is passed to the function. NO No database information is passed to the function. YES Information about the database is passed to the function.
SOURCE_SPECIFIC_SCHEMA	SRCSCHEMA	VARCHAR(128) Nullable	If this is sourced function and the source is user-defined, this column contains the name of the source schema. If this is a sourced function and the source is built-in, this column contains 'QSYS2'. Contains the null value if this is not a sourced function.
SOURCE_SPECIFIC_NAME	SRCNAME	VARCHAR(128) Nullable	If this is sourced function and the source is user-defined, this column contains the specific name of the source function name. Contains the null value if this is not a sourced function.
IS_USER_DEFINED_CAST	CAST_FUNC	VARCHAR(3) Nullable	Identifies whether this function is a cast function created when a distinct type was created. NO This function is not a cast function. YES This function is a cast function.
CARDINALITY	CARD	BIGINT Nullable	Specifies the cardinality for a table function. Contains the null value if the function is not a table function or if cardinality was not specified.
FENCED	FENCED	VARCHAR(3) Nullable	Identifies whether the function is fenced. NO The function is not fenced. YES The function is fenced.
IASP_NUMBER	IASPNUMBER	SMALLINT	Specifies the independent auxiliary storage pool (IASP) number.
ROUNDING_MODE	DECFLTRND	CHAR(1) Nullable	If this is an SQL function, identifies the DECFLOAT rounding mode. C ROUND_CEILING D ROUND_DOWN F ROUND_FLOOR G ROUND_HALF_DOWN E ROUND_HALF_EVEN H ROUND_HALF_UP U ROUND_UP Contains the null value if the function is not an SQL function.

Table 172. SYSFUNCS view (continued)

Column Name	System Column Name	Data Type	Description
INLINE	INLINE	VARCHAR(3) Nullable	Identifies whether the function can potentially be inlined. NO The function cannot be inlined. YES The function can be inlined. Contains the null value if the function is not an SQL function.
ROUTINE_TEXT	LABEL	VARGRAPHIC(50) CCSID 1200 Nullable	Contains the label for a routine. Contains the null value if a label does not exist.
SECURE	SECURE	CHAR(1)	Indicates whether the function is considered secure for row access control and column access control. N The function is not considered secure for row access control and column access control. Y The function is considered secure for row access control and column access control.
PIPELINED	PIPELINED	VARCHAR(3) Nullable	Identifies whether the table function is pipelined. NO The table function is not a pipelined table function. YES The table function is a pipelined function. Contains the null value if the routine is not a table function.

SYSHISTORYTABLES

The SYSHISTORYTABLES view contains one row for every history table, whether or not the history table is part of an established versioning relationship.

The following table describes the columns in the SYSHISTORYTABLES view:

Table 173. SYSHISTORYTABLES view

Column name	System Column Name	Data Type	Description
HISTORY_TABLE_SCHEMA	HSTDBNAME	VARCHAR(128)	Schema name of the history table.
HISTORY_TABLE_NAME	HSTTBNAME	VARCHAR(128)	Name of the history table.
VERSIONING_STATUS	VERSIONSTS	CHAR(1)	Status of versioning E A versioning relationship between the system-period temporal table and the history table has been established. The system-period temporal table is storing previous versions of modified rows in this history table. D A versioning relationship between this history table and the system-period temporal table has been defined but not established.
PERIOD_NAME	PERIODNAME	VARCHAR(128)	Name of the period.
TABLE_SCHEMA	DBNAME	VARCHAR(128) Nullable	Name of the SQL schema that contains the temporal table. Contains the null value if the system-period temporal table does not exist.
TABLE_NAME	TBNAME	VARCHAR(128) Nullable	Name of the temporal table. Contains the null value if the system-period temporal table does not exist.
SYSTEM_HISTORY_SCHEMA	SYSHSTLIB	CHAR(10)	System schema name of the history table.
SYSTEM_HISTORY_TABLE_NAME	SYSHSTNAME	CHAR(10)	System name of the history table.
SYSTEM_TABLE_SCHEMA	SYS_DNAME	CHAR(10) Nullable	System schema name of the temporal table. Contains the null value if the system-period temporal table does not exist.
SYSTEM_TABLE_NAME	SYS_TNAME	CHAR(10) Nullable	System name of the temporal table. Contains the null value if the system-period temporal table does not exist.

SYSINDEXES

The SYSINDEXES view contains one row for every index in the SQL schema created using the SQL CREATE INDEX statement, including indexes on the SQL catalog.

The following table describes the columns in the SYSINDEXES view:

Table 174. SYSINDEXES view

Column Name	System Column Name	Data Type	Description
INDEX_NAME	NAME	VARCHAR(128)	Name of the index. This will be the SQL index name if one exists; otherwise, it will be the system index name.
INDEX_OWNER	CREATOR	VARCHAR(128)	Owner of the index
TABLE_NAME	TBNAME	VARCHAR(128)	Name of the table on which the index is defined. This will be the SQL table name if one exists; otherwise, it will be the system table name.
TABLE_OWNER	TBCREATOR	VARCHAR(128)	Owner of the table
TABLE_SCHEMA	TBDBNAME	VARCHAR(128)	Name of the SQL schema that contains the table on which the index is defined
IS_UNIQUE	UNIQUERULE	CHAR(1)	If the index is unique: D No (duplicates are allowed) V Yes (duplicate NULL values are allowed) U Yes E Encoded vector index
COLUMN_COUNT	COLCOUNT	INTEGER	Number of columns in the key
INDEX_SCHEMA	DBNAME	VARCHAR(128)	Name of the SQL schema that contains the index
SYSTEM_INDEX_NAME	SYS_IXNAME	CHAR(10)	System index name
SYSTEM_INDEX_SCHEMA	SYS_IDNAME	CHAR(10)	System index schema name
SYSTEM_TABLE_NAME	SYS_TNAME	CHAR(10)	System table name
SYSTEM_TABLE_SCHEMA	SYS_DNAME	CHAR(10)	System table schema name
LONG_COMMENT	REMARKS	VARGRAPHIC(2000) CCSID 1200 Nullable	A character string supplied with the COMMENT statement. Contains the null value if there is no long comment.
IASP_NUMBER	IASPNUMBER	SMALLINT	Specifies the independent auxiliary storage pool (IASP) number.
INDEX_TEXT	LABEL	VARGRAPHIC(50) CCSID 1200	A character string supplied with the LABEL statement.
IS_SPANNING_INDEX	SPANNING	VARCHAR(3) Nullable	Indicates whether the index is built over multiple partitions or members: DISTRIBUTED The index is built over a distributed table. NO The index is not built over multiple partitions or members. YES The index is built over multiple partitions or members. Contains the null value if the base table is not a partitioned table.
INDEX_DEFINER	DEFINER	VARCHAR(128) Nullable	Name of the user that defined the index.

Table 174. SYSINDEXES view (continued)

Column Name	System Column Name	Data Type	Description
ROUNDING_MODE	DECFLTRND	CHAR(1) Nullable	Indicates the DECFLOAT rounding mode of the index: C ROUND_CEILING D ROUND_DOWN F ROUND_FLOOR G ROUND_HALF_DOWN E ROUND_HALF_EVEN H ROUND_HALF_UP U ROUND_UP Contains the null value if the index does not have an expression that references a DECFLOAT column, function, or constant.
INDEX_HAS_SEARCH_CONDITION	IXHASWHERE	CHAR(1)	If the index has a search condition: N The index does not have a search condition. Y The index has a search condition.
SEARCH_CONDITION_HAS_UDF	IXWHEREUDF	CHAR(1)	If the index search condition contains a user-defined function: N The index is not sparse or does not contain a user-defined function. Y The index is sparse and the search condition contains a UDF.
SEARCH_CONDITION	IXWHERECON	DBCLOB(2M) CCSID 1200 Nullable	If the index is sparse, contains the search condition. Contains the null value if the index is not sparse.
INDEX_HAS_INCLUDE_EXPRESSION	IXHASINCEX	CHAR(1)	If the index contains an INCLUDE clause: N The index is does not contain an INCLUDE clause. Y The index contains an INCLUDE clause.
INCLUDE_EXPRESSION	IXINCEXPR	DBCLOB(2M) CCSID 1200 Nullable	If the index has an INCLUDE clause, contains the list of INCLUDE expressions. Contains the null value if there is no include clause.
CREATED	CREATED	TIMESTAMP	The timestamp when the SQL index was created.

SYSINDEXSTAT

The SYSINDEXSTAT view contains one row for every SQL index partition.

Use this view when you want to see information for a specific SQL index or set of SQL indexes. The information is similar to that returned via Show Indexes in System i Navigator.

The following table describes the columns in the SYSINDEXSTAT view:

Table 175. SYSINDEXSTAT view

Column name	System Column Name	Data Type	Description
INDEX_SCHEMA	INDSCHEMA	VARCHAR(128)	Name of the SQL schema that contains the SQL index.
INDEX_NAME	INDNAME	VARCHAR(128)	Name of the SQL index.
INDEX_PARTITION	INDPART	VARCHAR(128)	Partition or member name of the SQL index.
INDEX_OWNER	INDOWNER	VARCHAR(128)	SQL index owner.
INDEX_TEXT	LABEL	VARGRAPHIC(50) CCSID 1200 Nullable	Text of the SQL index. Contains null if text does not exist for the SQL index.
TABLE_SCHEMA	TABSCHEMA	VARCHAR(128)	Name of the SQL schema that contains the table.
TABLE_NAME	TABNAME	VARCHAR(128)	Name of the table.
TABLE_PARTITION	TABPART	VARCHAR(128)	Name of the table partition or member.
INDEX_VALID	VALID	VARCHAR(3)	An indication or whether the SQL index is invalid and needs to be rebuilt: NO The SQL index is invalid. YES The SQL index is valid.
INDEX_CREATE_TIMESTAMP	INDCREATED	TIMESTAMP	The timestamp when the SQL index was created.
CREATE_TIMESTAMP	CREATED	TIMESTAMP	The timestamp when the SQL index partition was created.
LAST_BUILD_TIMESTAMP	LASTBUILD	TIMESTAMP Nullable	The timestamp when the SQL index was last rebuilt. Contains null if the SQL index has never been built.
LAST_QUERY_USE	LASTQRYUSE	TIMESTAMP Nullable	The timestamp of the last time the SQL index was used in a query since the last time the usage statistics were reset. If the SQL index has never been used in a query since the last time the usage statistics were reset, contains null.
LAST_STATISTICS_USE	LASTSTUSE	TIMESTAMP Nullable	The timestamp of the last time the SQL index was used by the optimizer for statistics since the last time the usage statistics were reset. If the SQL index has never been used for statistics since the last time the usage statistics were reset, contains null.
QUERY_USE_COUNT	QRYUSECNT	BIGINT	The number of times the SQL index was used in a query since the last time the usage statistics were reset. If the SQL index has never been used in a query since the last time the usage statistics were reset, contains 0.
QUERY_STATISTICS_COUNT	QRYSTCNT	BIGINT	The number of times the SQL index was used by the optimizer for statistics since the last time the usage statistics were reset. If the SQL index has never been used for statistics since the last time the usage statistics were reset, contains 0.
LAST_USED_TIMESTAMP	LASTUSED	TIMESTAMP Nullable	The timestamp of the last time the SQL index was used directly by an application for native record I/O or SQL operations. If the SQL index has never been used, contains null.

Table 175. SYSINDEXSTAT view (continued)

Column name	System Column Name	Data Type	Description
DAYS_USED_COUNT	DAYSUSED	INTEGER	The number of days the SQL index was used directly by an application for native record I/O or SQL operations since the last time the usage statistics were reset. If the SQL index has never been used since the last time the usage statistics were reset, contains 0.
LAST_RESET_TIMESTAMP	LASTRESET	TIMESTAMP Nullable	The timestamp of the last time the usage statistics were reset for the SQL index. For more information see the Change Object Description (CHGOBJD) command. If the SQL index's last used timestamp has never been reset, contains null.
NUMBER_KEY_COLUMNS	INDKEYS	BIGINT	Number of columns that define the SQL index key.
COLUMN_NAMES	COLNAMES	VARCHAR(1024)	A comma separated list of column names that define the SQL index key. If the length of all the column names exceeds 1024, '..' is returned at the end of the column value.
NUMBER_KEYS	NUMRIDS	BIGINT	Number of keys in the SQL index. If the SQL index is invalid, -1 is returned.
INDEX_SIZE	SIZE	BIGINT	Size (in bytes) of the binary tree or encoded vector index of the SQL index.
NUMBER_PAGES	PAGES	BIGINT Nullable	Number of pages in the SQL index. If the SQL index is invalid or is an encoded vector index, contains null.
LOGICAL_PAGE_SIZE	PAGE_SIZE	INTEGER Nullable	The logical page size of the index. If the index is an encoded vector index, contains null.
UNIQUE	UNIQUE	VARCHAR(21)	Indicates whether an SQL index is unique: UNIQUE The SQL index is a UNIQUE index. UNIQUE WHERE NOT NULL The SQL index is a UNIQUE WHERE NOT NULL index. FIFO The SQL index is a non-unique first-in-first-out (FIFO) index. LIFO The SQL index is a non-unique last-in-last-out (LIFO) index. FCFO The SQL index is a non-unique first-change-first-out (FCFO) index.
MAXIMUM_KEY_LENGTH	KEY_LENGTH	INTEGER Nullable	Maximum key length of an SQL index. If the SQL index is an encoded vector index, contains null.
UNIQUE_PARTIAL_KEY_VALUES	KEYCARDS	VARCHAR(96) Nullable	The unique partial key values for the SQL index. If the index is an encoded vector index, the first unique partial key value is the total number of unique values for the entire index key. The remaining unique partial key values returned are not applicable.
OVERFLOW_VALUES	OVERFLOW	INTEGER Nullable	The number of distinct key values that have overflowed the encoded vector index. If the SQL index is not an encoded vector index, contains null.
EVI_CODE_SIZE	CODE_SIZE	INTEGER Nullable	The size of the byte code of the encoded vector index. If the SQL index is not an encoded vector index, contains null.

Table 175. SYSINDEXSTAT view (continued)

Column name	System Column Name	Data Type	Description
SPARSE	SPARSE	VARCHAR(3)	<p>Indicates whether the SQL index contains keys for all the rows of its depended on table:</p> <p>NO The index contains keys for all the rows of its depended on table.</p> <p>YES The SQL index includes a WHERE clause and does not contain keys for all the rows of its depended on table.</p>
DERIVED_KEY	DERIVED	VARCHAR(3)	<p>Indicates whether the any key columns in the SQL index are expressions:</p> <p>NO No key columns of the SQL index are expressions.</p> <p>YES At least one key column is an expression.</p>
PARTITIONED	PARTITION	VARCHAR(3)	<p>Indicates whether the SQL index is partitioned or not partitioned:</p> <p>DISTRIBUTED The index is built over a distributed table.</p> <p>NO The SQL index is not partitioned (spans multiple partitions).</p> <p>YES The SQL index is not built over a partitioned table or built over a partitioned table and is partitioned (does not span multiple partitions).</p> <p>Contains the null value if the base table is not a partitioned table.</p>
ACCPH_TYPE	ACCPHTYPE	VARCHAR(4)	<p>Indicates the type of SQL index:</p> <p>1 TB The SQL index is a maximum 1 terabyte (*MAX1TB) binary radix index.</p> <p>4 GB The SQL index is a maximum 4 gigabyte (*MAX4GB) binary radix index.</p> <p>EVI The SQL index is an encoded vector index.</p>
SORT_SEQUENCE	SRTSEQ	VARCHAR(12)	<p>Indicates whether the SQL index uses a collating sequence:</p> <p>BY HEX VALUE The SQL index does not use a collating table.</p> <p>*LANGIDSHR The SQL index uses a shared weight collating sequence (SRTSEQ).</p> <p>*LANGIDUNQ The SQL index uses a unique weight collating sequence (SRTSEQ).</p> <p>ALTSEQ The SQL index uses an alternate collating sequence (ALTSEQ).</p>
LANGUAGE_IDENTIFIER	LANGID	CHAR(3) Nullable	The language ID of the SQL index. Contains null if the collating sequence is hex.
SORT_SEQUENCE_SCHEMA	SRTSEQSCH	CHAR(10) Nullable	Schema name of the sort sequence to use. Contains null if there is no sort sequence schema name.
SORT_SEQUENCE_NAME	SRTSEQNAM	CHAR(10) Nullable	Name of the sort sequence to use. Contains null if there is no sort sequence name.

Table 175. SYSINDEXSTAT view (continued)

Column name	System Column Name	Data Type	Description
ESTIMATED_BUILD_TIME	ESTBLDTIME	INTEGER	Estimated time (in seconds) required to rebuild the SQL index.
LAST_BUILD_TIME	LSTBLDTIME	INTEGER Nullable	Elapsed time (in seconds) the last time the index was built. Contains null if the last build information is not available.
LAST_BUILD_KEYS	LSTBLDKEYS	BIGINT Nullable	Number of keys the last time the index was built. Contains null if the last build information is not available.
LAST_BUILD_DEGREE	LSTBLDDEG	SMALLINT Nullable	Parallel degree the last time the index was built. Contains null if the last build information is not available.
LAST_BUILD_TYPE	LSTBLDTYPE	CHAR(1) Nullable	An indication of whether the last index build was a complete build or a build from the delayed maintenance keys: 0 The last rebuild of the index was from the delayed maintenance keys. 1 The last build or rebuild of the index was a complete build from the rows in the table. If the index has never been built, contains null.
LAST_INVALIDATION_TIMESTAMP	LSTINVAL	TIMESTAMP Nullable	An indication of when the index was last invalidated. If the index has never been invalidated, contains null.
LAST_INVALIDATION_REASON_CODE	LSTINVRC	SMALLINT Nullable	The reason code when the index was last invalidated. 1 User requested. LAST_INVALIDATION_REASON_TYPE contains additional information. 2 Create or build index 3 Load. LAST_INVALIDATION_REASON_TYPE contains additional information. 4 IPL 5 Runtime error. LAST_INVALIDATION_REASON_TYPE contains additional information. 6 Modify index 7 Journal failed to build the index 8 Marked index as fixable during runtime 9 Marked index as fixable during IPL 10 Change end of data If the index has never been invalidated, contains null.

Table 175. SYSINDEXSTAT view (continued)

Column name	System Column Name	Data Type	Description
LAST_INVALIDATION_REASON_TYPE	LSTINVRT	SMALLINT Nullable	<p>The reason type when the index was last invalidated.</p> <p>When LAST_INVALIDATION_REASON_CODE is 1, the following reason types can be returned:</p> <p>1 Reorganize</p> <p>2 Copy</p> <p>3 ALTER TABLE or CHGPF</p> <p>4 Converting new member</p> <p>5 Change to *FRCRBDAP</p> <p>6 Change to *UNIQUE</p> <p>160 Change to *REBLD</p> <p>When LAST_INVALIDATION_REASON_CODE is 3, the following reason types can be returned:</p> <p>769 Index was marked for invalidation but the system crashed before the invalidation occurred</p> <p>770 Index was associated with the overlaid data space header during a load</p> <p>773 Partial load</p> <p>774 Delayed maintenance mismatch</p> <p>775 Pad key mismatch</p> <p>777 Logical page size mismatch</p> <p>778 Index not restored. File might have been saved with ACCPTH(*NO) or index did not exist when file was saved.</p> <p>779 Index not restored. File might have been saved with ACCPTH(*NO) or index did not exist when file was saved.</p> <p>When LAST_INVALIDATION_REASON_CODE is 5, the following reason type can be returned:</p> <p>1025 Index out of sync with file</p> <p>If the index has never been invalidated, contains null.</p>
INDEX_HELD	HELD	VARCHAR(3)	<p>An indication of whether a pending rebuild of the SQL index is currently held by the user:</p> <p>NO A rebuild of the SQL index is not pending or is not held.</p> <p>YES A pending rebuild of the SQL index is held.</p>

Table 175. SYSINDEXSTAT view (continued)

Column name	System Column Name	Data Type	Description
MAINTENANCE	MAINT	VARCHAR(11) Nullable	The maintenance of the SQL index: REBUILD The SQL index is not maintained and is rebuilt at open time. DELAYED The SQL index maintenance is delayed until the index is opened. DO NOT WAIT The SQL index is immediately maintained. If the SQL index is an encoded vector index, contains null.
DELAYED_MAINT_KEYS	DLYKEYS	INTEGER Nullable	Number of keys that need to be inserted into the binary tree of a delayed maintenance index. If the SQL index is not a delayed maintenance index, contains null.
RECOVERY	RECOVERY	VARCHAR(10) Nullable	The recovery attribute of the SQL index: DURING IPL The SQL index is recovered, if necessary, at IPL. AFTER IPL The SQL index is recovered, if necessary, after IPL. NEXT OPEN The SQL index is recovered, if necessary, on the next open. If the SQL index is an encoded vector index, contains null.
ROUNDING_MODE	DECFLTRND	VARCHAR(8) Nullable	Indicates the DECFLOAT rounding mode of the index: CEILING ROUND_CEILING DOWN ROUND_DOWN FLOOR ROUND_FLOOR HALFDOWN ROUND_HALF_DOWN HALFEVEN ROUND_HALF_EVEN HALFUP ROUND_HALF_UP UP ROUND_UP Contains the null value if the index does not have an expression that references a DECFLOAT column, function, or constant.
DECFLOAT_WARNING	DECFLTWRN	VARCHAR(3) Nullable	Indicates whether DECFLOAT warnings are returned: NO DECFLOAT warnings are not returned. YES DECFLOAT warnings are returned. Contains the null value if the index does not have an expression that references a DECFLOAT column, function, or constant.
LOGICAL_READS	LGLREADS	BIGINT	Number of logical read operations for the SQL index since the last IPL.
SEQUENTIAL_READS	SEQREADS	BIGINT	Number of sequential read operations for the index since the last IPL.
RANDOM_READS	RANREADS	BIGINT	Number of random read operations for the index since the last IPL.

Table 175. SYSINDEXSTAT view (continued)

Column name	System Column Name	Data Type	Description
SEARCH_CONDITION	IXWHERECON	VARGRAPHIC(1024) CCSID 1200 Nullable	If an index is sparse, the search condition of the index. If the length of the search condition exceeds 1024, '...' is returned at the end of the column value. Contains null if the index is not sparse.
SEARCH_CONDITION_HAS_UDF	IXWHEREUDF	VARCHAR(3) Nullable	If an index is sparse, indicates whether the search condition of the index contains a user-defined function. Contains null if the index is not sparse. NO The index search condition does not contain a UDF. YES The index search condition contains a UDF.
KEEP_IN_MEMORY	KEEPINMEM	VARCHAR(3)	Indicates whether the index should be kept in memory: NO No memory preference. YES The index should be kept in memory, if possible.
MEDIA_PREFERENCE	MEDIAPREF	VARCHAR(3)	Indicates the media preference of the index: ANY No media preference. SSD The index should be allocated on Solid State Disk (SSD), if possible.
INCLUDE_EXPRESSION	IXINCEPR	VARGRAPHIC(1024) CCSID 1200 Nullable	Index INCLUDE expression. Contains null if the index does not have an INCLUDE expression.
OWNING_INDEX_SCHEMA	OWNINDSCH	VARCHAR(128)	Name of the schema of the object that owns the index.
OWNING_INDEX_NAME	OWNINDNAME	VARCHAR(128)	Name of the object that owns the index.
OWNING_INDEX_TYPE	OWNINDTYPE	VARCHAR(11)	The type of the object that owns the index: INDEX The owner is an SQL index. LOGICAL The owner is part of a logical file. PHYSICAL The owner is a part of a keyed physical file. PRIMARY KEY The owner is a primary key constraint. UNIQUE The owner is a unique constraint. FOREIGN KEY The owner is a foreign key constraint.
OWNING_INDEX_OWNER	OWNINDOWN	VARCHAR(128)	The owner of the object that owns the index.
OWNING_SYSTEM_INDEX_SCHEMA	OWNSYS_IDX	CHAR(10) Nullable	System index schema name of the owner of the index. Contains null if the owner is a constraint.
OWNING_SYSTEM_INDEX_NAME	OWNSYS_IXN	CHAR(10) Nullable	The system name of the owner of the index. Contains null if the owner is a constraint.
OWNING_INDEX_TEXT	OWNLABEL	VARGRAPHIC(50) CCSID 1200 Nullable	Text of the object that owns the index. Contains null if text does not exist for the object.
OWNING_INDEX_PARTITION	OWNINDMMBR	VARCHAR(128) Nullable	Partition or member name of the object that owns the index. Contains null if the owner is a constraint.
SYSTEM_INDEX_SCHEMA	SYS_IDXNAM	CHAR(10)	System index schema name.

Table 175. SYSINDEXSTAT view (continued)

Column name	System Column Name	Data Type	Description
SYSTEM_INDEX_NAME	SYS_IXNAME	CHAR(10)	System index name.
SYSTEM_TABLE_SCHEMA	SYS_DNAME	CHAR(10)	System table schema name.
SYSTEM_TABLE_NAME	SYS_TNAME	CHAR(10)	System table name.
SYSTEM_TABLE_MEMBER	SYS_MNAME	CHAR(10)	System member name.

SYSJARCONTENTS

The SYSJARCONTENTS table contains one row for each class defined by a jarid in the SQL schema.

The following table describes the columns in the SYSJARCONTENTS table.

Table 176. SYSJARCONTENTS table

Column Name	System Column Name	Data Type	Description
JARSCHEMA	JARSCHEMA	VARCHAR(128)	Name of the schema containing the jar_id.
JAR_ID	JAR_ID	VARCHAR(128)	Name of the jar_id.
CLASS	CLASS	VARCHAR(128)	Name of the class.
CLASS_SOURCE	CLASSSRC	DBCLOB(10485760) CCSID 13488 Nullable	Reserved. Contains the null value.
IASP_NUMBER	IASPNUMBER	SMALLINT	Specifies the independent auxiliary storage pool (IASP) number.

SYSJAROBJECTS

The SYSJAROBJECTS table contains one row for each jarid in the SQL schema.

The following table describes the columns in the SYSJAROBJECTS table.

Table 177. SYSJAROBJECTS table

Column Name	System Column Name	Data Type	Description
JARSCHEMA	JARSCHEMA	VARCHAR(128)	Name of the schema containing the jar_id.
JAR_ID	JAR_ID	VARCHAR(128)	Name of the jar_id.
DEFINER	DEFINER	VARCHAR(128)	Name of the owner of the jarid.
JAR_DATA	JAR_DATA	BLOB(104857600) Nullable	Byte-codes for the jar.
IASP_NUMBER	IASPNUMBER	SMALLINT	Specifies the independent auxiliary storage pool (IASP) number.
JAR_CREATED	CREATEDTS	TIMESTAMP	Jar created timestamp.
LAST_ALTERED	ALTEREDTS	TIMESTAMP Nullable	Reserved. Contains the null value.
DEBUG_MODE	DEBUG_MODE	CHAR(1)	Identifies whether the routine is debuggable. 0 The routine is not debuggable. 1 The routine is debuggable by the Unified Debugger. 2 The routine is debuggable by the system debugger. N The routine is disabled from being debugged by the Unified Debugger.
DEBUG_DATA	DEBUG_DATA	CLOB(1048576) Nullable	Reserved. Contains the null value.

SYSKEYCST

The SYSKEYCST view contains one or more rows for each UNIQUE KEY, PRIMARY KEY, or FOREIGN KEY in the SQL schema. There is one row for each column in every unique or primary key constraint and the referencing columns of a referential constraint.

The following table describes the columns in the SYSKEYCST view:

Table 178. SYSKEYCST view

Column Name	System Column Name	Data Type	Description
CONSTRAINT_SCHEMA	CDBNAME	VARCHAR(128)	Name of the schema containing the constraint.
CONSTRAINT_NAME	RELNAM	VARCHAR(128)	Name of the constraint.
TABLE_SCHEMA	TDBNAME	VARCHAR(128)	Name of the schema containing the table.
TABLE_NAME	TBNAME	VARCHAR(128)	Name of the table.
COLUMN_NAME	COLNAME	VARCHAR(128)	Name of the column.
ORDINAL_POSITION	COLSEQ	INTEGER	The position of the column within the key
COLUMN_POSITION	COLNO	INTEGER	The position of the column within the row
TABLE_OWNER	CREATOR	VARCHAR(128)	Owner of the table.
SYSTEM_COLUMN_NAME	SYS_CNAME	CHAR(10)	System name of the column.
SYSTEM_TABLE_NAME	SYS_TNAME	CHAR(10)	System name of the table.
SYSTEM_TABLE_SCHEMA	SYS_DNAME	CHAR(10)	System name of the schema containing the schema table.
SYSTEM_CONSTRAINT_SCHEMA	SYS_CDNAME	CHAR(10)	Name of the system schema containing the constraint.

SYSKEYS

The SYSKEYS view contains one row for every column of an index in the SQL schema, including the keys for the indexes on the SQL catalog.

The following table describes the columns in the SYSKEYS view:

Table 179. SYSKEYS view

Column Name	System Column Name	Data Type	Description
INDEX_NAME	IXNAME	VARCHAR(128)	Name of the index. This will be the SQL index name if one exists; otherwise, it will be the system index name.
INDEX_OWNER	IXCREATOR	VARCHAR(128)	Owner of the index
COLUMN_NAME	COLNAME	VARCHAR(128)	Name of the column of the key. This will be the SQL column name if one exists; otherwise, it will be the system column name.
COLUMN_POSITION	COLNO	INTEGER Nullable	Numeric position of the column in the row. Contains the null value if the key column is an expression.
ORDINAL_POSITION	COLSEQ	INTEGER	Numeric position of the column in the key
ORDERING	ORDERING	CHAR(1)	Order of the column in the key: A Ascending D Descending
INDEX_SCHEMA	IXDBNAME	VARCHAR(128)	Name of the schema containing the index.
SYSTEM_COLUMN_NAME	SYS_CNAME	CHAR(10)	System name of the column
SYSTEM_INDEX_NAME	SYS_IXNAME	CHAR(10)	System name of the index
SYSTEM_INDEX_SCHEMA	SYS_IDNAME	CHAR(10)	System name of the schema containing the index
COLUMN_IS_EXPRESSION	IXISEXP	CHAR(1)	If the key column is an expression: Y The key column is not an expression. N The key column is an expression.
EXPRESSION_HAS_UDF	IXEXPUDF	CHAR(1) Nullable	If the key column is an expression and the expression contains a user-defined function: N The key column is not an expression or the expression does not contain a user-defined function. Y The key column is an expression and the expression contains a UDF.
KEY_EXPRESSION	IXKEYEXP	DBCLOB(2097152) CCSID 1200 Nullable	If the key column is an expression, contains the expression. Contains the column name if the key column is not an expression.

SYSMQTSTAT

The SYSMQTSTAT view contains one row for every materialized table partition.

Use this view when you want to see information about a specified materialized query table or set of materialized query tables. The information is similar to that returned via Show Materialized Query Tables in System i Navigator.

The following table describes the columns in the SYSMQTSTAT view:

Table 180. SYSMQTSTAT view

Column name	System Column Name	Data Type	Description
MQT_SCHEMA	MQTSHEMA	VARCHAR(128)	Name of the SQL schema that contains the materialized query table.
MQT_NAME	MQTNAME	VARCHAR(128)	Name of the materialized query table.
MQT_PARTITION	MQTMEMBER	VARCHAR(128)	Partition or member name of the materialized query table.
MQT_OWNER	MQTOWNER	VARCHAR(128)	Materialized query table owner.
MQT_TEXT	LABEL	VARGRAPHIC(50) CCSID 1200 Nullable	Text of the materialized query table. Contains null if text does not exist for the materialized query table.
ENABLED	ENABLED	VARCHAR(3)	An indication of whether the materialized query table is enabled: NO The materialized query table is not enabled for use. YES The materialized query table is enabled for use by the database manager.
CREATE_TIMESTAMP	CREATED	TIMESTAMP	The timestamp when the materialized query table was created.
REFRESH_TIME	REFRESHDTS	TIMESTAMP Nullable	The timestamp when the materialized query table was last refreshed. Contains null if the materialized query table has never been refreshed.
LAST_QUERY_USE	LASTQRYUSE	TIMESTAMP Nullable	The timestamp of the last time the materialized query table was used in a query since the last time the usage statistics were reset. If the materialized query table has never been used in a query since the last time the usage statistics were reset, contains null.
LAST_STATISTICS_USE	LASTSTUSE	TIMESTAMP Nullable	The timestamp of the last time the materialized query table was used by the optimizer for statistics since the last time the usage statistics were reset. If the materialized query table has never been used for statistics since the last time the usage statistics were reset, contains null.
QUERY_USE_COUNT	QRYUSECNT	BIGINT	The number of times the materialized query table was used in a query since the last time the usage statistics were reset. If the materialized query table has never been used in a query since the last time the usage statistics were reset, contains 0.
QUERY_STATISTICS_COUNT	QRYSTCNT	BIGINT	The number of times the materialized query table was used by the optimizer for statistics since the last time the usage statistics were reset. If the materialized query table has never been used for statistics since the last time the usage statistics were reset, contains 0.
LAST_USED_TIMESTAMP	LASTUSED	TIMESTAMP Nullable	The timestamp of the last time the materialized query table was used directly by an application for native record I/O or SQL operations. If the materialized query table has never been used, contains null.

Table 180. SYSMQSTAT view (continued)

Column name	System Column Name	Data Type	Description
DAYS_USED_COUNT	DAYSUSED	INTEGER	The number of days the materialized query table was used directly by an application for native record I/O or SQL operations since the last time the usage statistics were reset. If the materialized query table has never been used since the last time the usage statistics were reset, contains 0.
LAST_RESET_TIMESTAMP	LASTRESET	TIMESTAMP Nullable	The timestamp of the last time the usage statistics were reset for the materialized query table. For more information see the Change Object Description (CHGOBJD) command. If the materialized query table's last used timestamp has never been reset, contains null.
NUMBER_ROWS	CARD	BIGINT	Number of rows in the materialized query table.
MQT_SIZE	SIZE	BIGINT	Size (in bytes) of the materialized query table.
LAST_CHANGE_TIMESTAMP	LASTCHG	TIMESTAMP Nullable	The timestamp of the last time the materialized query table was changed. If the materialized query table has never been changed since the last time the usage statistics were reset, contains null.
MAINTENANCE	MAINTAIN	VARCHAR(6)	Indicates the maintenance for the materialized query table: SYSTEM The materialized query table is system maintained. USER The materialized query table is user maintained.
INITIAL_DATA	INITIAL	VARCHAR(19)	Indicates the initial data for the materialized query table: INITIALLY DEFERRED Data is not inserted into the materialized query table when it is created. INITIALLY IMMEDIATE Data is inserted into the materialized query table when it is created.
REFRESH	REFRESH	VARCHAR(9)	Indicates when the data in the materialized query table can be refreshed: DEFERRED Data in the materialized query table can be refreshed at any time using the REFRESH TABLE statement. IMMEDIATE Data in the materialized query table is immediately refreshed.
ISOLATION	ISOLATION	VARCHAR(27)	Indicates the isolation level used to refresh the materialized query table: NO COMMIT The isolation level is NO COMMIT. UNCOMMITTED READ The isolation level is UNCOMMITTED READ. CURSOR STABILITY The isolation level is CURSOR STABILITY. CURSOR STABILITY KEEP LOCKS The isolation level is CURSOR STABILITY KEEP LOCKS. READ STABILITY The isolation level is READ STABILITY. REPEATABLE READ The isolation level is REPEATABLE READ.

Table 180. SYSMQTSTAT view (continued)

Column name	System Column Name	Data Type	Description
SORT_SEQUENCE	SRTSEQ	VARCHAR(12)	Indicates whether the materialize query table uses a collating sequence: BY HEX VALUE The materialize query table does not use a collating table. *LANGIDSHR The materialize query table uses a shared weight sort sequence (SRTSEQ). *LANGIDUNQ The materialize query table uses a unique weight sort sequence (SRTSEQ). ALTSEQ The materialize query table uses an alternate collating sequence (ALTSEQ).
LANGUAGE_IDENTIFIER	LANGID	CHAR(3) Nullable	The language ID of the materialize query table. Contains null if the sort sequence is hex.
SORT_SEQUENCE_SCHEMA	SRTSEQSCH	CHAR(10) Nullable	The sort sequence table system schema. Contains null if the sort sequence is hex.
SORT_SEQUENCE_NAME	SRTSEQNAME	CHAR(10) Nullable	The sort sequence table name. Contains null if the sort sequence is hex.
MQT_RESTORE_DEFERRED	MQTRSTDFR	VARCHAR(3)	An indication of whether a restore of the MQT is pending the restore of one of its dependents: NO The restore of the MQT is not deferred pending the restore of one of its dependent tables. YES The restore of the MQT is deferred pending the restore of one of its dependent tables.
ROUNDING_MODE	DECFLTRND	VARCHAR(8) Nullable	Indicates the DECFLOAT rounding mode of the materialized query table: CEILING ROUND_CEILING DOWN ROUND_DOWN FLOOR ROUND_FLOOR HALFDOWN ROUND_HALF_DOWN HALFEVEN ROUND_HALF_EVEN HALFUP ROUND_HALF_UP UP ROUND_UP Contains the null value if the materialized query table does not have an expression that references a DECFLOAT column, function, or constant.
DECFLOAT_WARNING	DECFLTWRN	VARCHAR(3) Nullable	Indicates whether DECFLOAT warnings are returned: NO DECFLOAT warnings are not returned. YES DECFLOAT warnings are returned. Contains the null value if the materialized query table does not have an expression that references a DECFLOAT column, function, or constant.
MQT_DEFINITION	MQTDEF	VARGRAPHIC(5000) CCSID 1200	The query of the materialized query table. If the length of the query exceeds 5000, '...' is returned at the end of the column value.

Table 180. SYSMQTSTAT view (continued)

Column name	System Column Name	Data Type	Description
SYSTEM_MQT_SCHEMA	SYS_MQDNAM	CHAR(10)	System materialized query table schema name.
SYSTEM_MQT_NAME	SYS_MQNAME	CHAR(10)	System materialized query table name.

SYSPACKAGE

The SYSPACKAGE view contains one row for each SQL package in the SQL schema.

The following table describes the columns in the SYSPACKAGE view:

Table 181. SYSPACKAGE view

Column Name	System Column Name	Data Type	Description
PACKAGE_CATALOG	LOCATION	VARCHAR(128)	Relational database name (RDBNAME) of the SQL package
PACKAGE_SCHEMA	COLLID	VARCHAR(128)	Name of the schema
PACKAGE_NAME	NAME	VARCHAR(128)	Name of the SQL package
PACKAGE_OWNER	OWNER	VARCHAR(128)	Owner of the SQL package
PACKAGE_CREATOR	CREATOR	VARCHAR(128)	Creator of the SQL package
CREATION_TIMESTAMP	TIMESTAMP	CHAR(26)	Timestamp of when the SQL package was created
DEFAULT_SCHEMA	QUALIFIER	VARCHAR(128)	Implicit name for unqualified tables, views, and indexes
PROGRAM_NAME	PROGNAME	VARCHAR(128)	Name of program the package was created from
PROGRAM_SCHEMA	LIBRARY	VARCHAR(128)	Name of schema containing the program
PROGRAM_CATALOG	RDB	VARCHAR(128)	Name of the relational database where the program resides
ISOLATION	ISOLATION	CHAR(2)	Isolation option specification. RR Repeatable Read (*RR) RS Read Stability (*ALL) CS Cursor Stability (*CS) UR Uncommitted Read (*CHG) NO None (*NONE)
QUOTE	QUOTE	CHAR(1)	Escape character specification. Y Quotation mark N Apostrophe
COMMA	COMMA	CHAR(1)	Comma option specification. Y Comma N Period
PACKAGE_TEXT	LABEL	VARCHAR(50)	A character string you supply with the LABEL statement.
LONG_COMMENT	REMARKS	VARCHAR(2000)	A character string supplied with the COMMENT statement. Contains the null value if there is no long comment.
CONSISTENCY_TOKEN	CONTOKEN	CHAR(8) FOR BIT DATA	Consistency token of package
SYSTEM_PACKAGE_NAME	SYS_NAME	CHAR(10)	System name of the package.
SYSTEM_PACKAGE_SCHEMA	SYS_DNAME	CHAR(10)	System name of the schema containing the package.
SYSTEM_DEFAULT_SCHEMA	SYS_DDNAME	CHAR(10)	System name of the implicit qualifier for unqualified table, views, indexes, and packages.
SYSTEM_PROGRAM_NAME	SYS_PNAME	CHAR(10)	System name of the program.
SYSTEM_PROGRAM_SCHEMA	SYS_PDNAME	CHAR(10)	System name of the schema containing the program

Table 181. SYSPACKAGE view (continued)

Column Name	System Column Name	Data Type	Description
IASP_NUMBER	IASPNUMBER	SMALLINT	Specifies the independent auxiliary storage pool (IASP) number.
ROUNDING_MODE	DECFLTRND	CHAR(1)	The rounding mode for the package: C ROUND_CEILING D ROUND_DOWN F ROUND_FLOOR G ROUND_HALF_DOWN E ROUND_HALF_EVEN H ROUND_HALF_UP U ROUND_UP
CONCURRENTACCESSRESOLUTION	CONCURRENT	CHAR(1)	Specifies the concurrent access resolution: blank Not specified W Wait for outcome U Use currently committed

SYSPACKAGEAUTH

The SYSPACKAGEAUTH view contains one row for every privilege granted on a package. Note that this catalog view cannot be used to determine whether a user is authorized to a package because the privilege to use a package could be acquired through a group user profile or special authority (such as *ALLOBJ).

The following table describes the columns in the SYSPACKAGEAUTH view:

Table 182. SYSPACKAGEAUTH view

Column Name	System Column Name	Data Type	Description
GRANTOR	GRANTOR	VARCHAR(128) Nullable	Reserved. Contains the null value.
GRANTEE	GRANTEE	VARCHAR(128)	The user profile to which the privilege is granted.
PACKAGE_SCHEMA	COLLID	VARCHAR(128)	Name of the schema
PACKAGE_NAME	NAME	VARCHAR(128)	Name of the SQL package
PRIVILEGE_TYPE	PRIVTYPE	VARCHAR(10)	The privilege granted: ALTER The privilege to alter the package. EXECUTE The privilege to execute the package.
IS_GRANTABLE	GRANTABLE	VARCHAR(3)	Indicates whether the privilege is grantable to other users. NO The privilege is not grantable. YES The privilege is grantable.
AUTHORIZATION_LIST	AUTL	VARCHAR(10) Nullable	If the privilege is granted through an authorization, contains the name of the authorization list. Contains the null value if the privilege is not granted through an authorization list.
SYSTEM_PACKAGE_SCHEMA	SYS_DNAME	CHAR(10)	System name of the schema containing the package
SYSTEM_PACKAGE_NAME	SYS_NAME	CHAR(10)	System name of the package

SYSPACKAGESTAT

The SYSPACKAGESTAT view contains one row for each SQL package in the SQL schema.

The following table describes the columns in the SYSPACKAGESTAT view:

Table 183. SYSPACKAGESTAT view

Column Name	System Column Name	Data Type	Description
PACKAGE_SCHEMA	COLLID	VARCHAR(128)	Name of the schema
PACKAGE_NAME	NAME	VARCHAR(128)	Name of the SQL package
PACKAGE_OWNER	OWNER	VARCHAR(128)	Owner of the SQL package
PACKAGE_CREATOR	CREATOR	VARCHAR(128)	Creator of the SQL package
CREATION_TIMESTAMP	TIMESTAMP	CHAR(26)	Timestamp of when the SQL package was created
DEFAULT_SCHEMA	QUALIFIER	VARCHAR(128)	Implicit name for unqualified tables, views, and indexes
ISOLATION	ISOLATION	CHAR(2)	Isolation option specification: RR Repeatable Read (*RR) RS Read Stability (*ALL) CS Cursor Stability (*CS) UR Uncommitted Read (*CHG) NC No Commit (*NONE)
CONCURRENTACCESSRESOLUTION	CONCURRENT	CHAR(1)	Specifies the concurrent access resolution: blank Not specified W Wait for outcome U Use currently committed
SECONDARY_SPACE_COUNT	PKG_SPACES	INTEGER	Number of spaces in the package.
PENDING_FULL	PENDFULL	VARCHAR(3) Nullable	Indicates whether the package is pending full. NO The package is not pending full. YES The package is pending full. Contains null for a DRDA package.
ADHOC_PACKAGE	ADHOC	VARCHAR(3) Nullable	Indicates whether the package is created for single use only statements. NO The package includes statements that are prepared once and executed many times. YES The package includes statements that are prepared once and executed one time. Package compression will be activated before a second secondary space is added to the package. Contains null for a DRDA package.
PACKAGE_TYPE	PKG_TYPE	VARCHAR(16)	Indicates the type of package. EXTENDED DYNAMIC The package is an extended dynamic package. DRDA The package is a DRDA package.
NUMBER_STATEMENTS	NBRSTMTS	INTEGER	Number of SQL statements in the package

Table 183. SYSPACKGESTAT view (continued)

Column Name	System Column Name	Data Type	Description
PACKAGE_USED_SIZE	PKSIZE	INTEGER	Number of bytes that are used for SQL statements and access plans in the package.
NUMBER_DUMMIES	NBRDUMMIES	INTEGER Nullable	Number of dummy statements in the package. Contains null for a DRDA package.
NUMBER_COMPRESSIONS	PGM_CMP	INTEGER Nullable	Number of times the package has been compressed. Contains null for a DRDA package.
STATEMENT_CONTENTION_COUNT	CONTENTION	BIGINT	Number of times contention occurred when attempting to store a new access plan.
EXTENDED_INDICATOR	EXTIND	VARCHAR(9)	Indicates the EXTIND attribute: *EXTIND Extended indicator support is enabled. *NOEXTIND Extended indicator support is not enabled.
C_NUL_REQUIRED	CNULRQD	VARCHAR(10)	Indicates the CNULRQD attribute: *CNULRQD C nuls are required. *NOCNULRQD C nuls are not required.
NAMING	NAMING	VARCHAR(4)	Indicates the NAMING attribute: *SYS This is system naming. *SQL This is SQL naming.
TARGET_RELEASE	TGTRLS	VARCHAR(6)	Indicates the target release of the package (VxRxMx).
EARLIEST_POSSIBLE_RELEASE	MINRLS	VARCHAR(6) Nullable	Indicates the earliest IBM i release that supports all the SQL statements in the package (VxRxMx). ANY The statements are valid on any supported IBM i release. VxRxMx The statement is valid on IBM i VxRxMx release or later. Contains null if the earliest release has not yet been determined.
RDB	RDB	VARCHAR(18)	Indicates the RDB specified for the package. rdb-name The name of the relational database. *NONE A relational database was not specified.
CONSISTENCY_TOKEN	CONTOKEN	VARBINARY(8) Nullable	Indicates the consistency token of the package. Contains null if the package is not a DRDA package.
ALLOW_COPY_DATA	ALWCPYDTA	VARCHAR(9)	Indicates the ALWCPYDTA attribute: *NO A copy of the data is not allowed. *OPTIMIZE A copy of the data is allowed whenever it might result in better performance. *YES A copy of the data is allowed, but only when necessary.

Table 183. SYSPACKGESTAT view (continued)

Column Name	System Column Name	Data Type	Description
LOB_FETCH_OPTIMIZATION	OPTLOB	VARCHAR(9)	Indicates the LOB optimization attribute: *OPTLOB The first FETCH for a cursor determines how the cursor will be used for LOB and XML result columns on all subsequent FETCHes. *NOPTLOB Any FETCH may retrieve a LOB or XML result column into either a locator or variable.
DECIMAL_POINT	DECPNT	VARCHAR(7)	Indicates the decimal point for numeric constants used in SQL statements. *PERIOD The decimal point is a period. *COMMA The decimal point is a comma.
SQL_STRING_DELIMITER	STRDLM	VARCHAR(9)	Indicates the character used as the string delimiter in the SQL statements. *APOSTSQL The string delimiter is an apostrophe ('). *QUOTESQL The string delimiter is a quote (").
DATE_FORMAT	DATFMT	VARCHAR(4)	Indicates the DATFMT attribute: *JOB The date format specified in the job at runtime is used. *USA The date format is *USA. *ISO The date format is *ISO. *EUR The date format is *EUR. *JIS The date format is *JIS. *MDY The date format is *MDY. *DMY The date format is *DMY. *YMD The date format is *YMD. *JUL The date format is *JUL.
DATE_SEPARATOR	DATSEP	CHAR(1)	Indicates the date separator.
TIME_FORMAT	TIMFMT	VARCHAR(4)	Indicates the TIMFMT attribute: *JOB The time format specified in the job at runtime is used. *USA The time format is *USA. *ISO The time format is *ISO. *EUR The time format is *EUR. *JIS The time format is *JIS. *HMS The date format is *HMS.
TIME_SEPARATOR	TIMSEP	CHAR(1)	Indicates the time separator.

Table 183. SYSPACKAGESTAT view (continued)

Column Name	System Column Name	Data Type	Description
DYNAMIC_DEFAULT_SCHEMA	DYNDFTCOL	VARCHAR(4) Nullable	<p>Indicates whether the value for DFTRBCOL should be used for implicit qualification on dynamic SQL statements:</p> <p>*NO The schema specified in DFTRBCOL is not used for dynamic SQL statements.</p> <p>*YES The schema specified in DFTRBCOL is used for dynamic SQL statements.</p> <p>Contains null if a default schema was not specified (DFTRBCOL).</p>
CURRENT_RULES	SQLCURRULE	VARCHAR(4)	<p>Indicates the SQLCURRULE attribute:</p> <p>*DB2 The semantics of all SQL statements will default to the rules established for Db2.</p> <p>*STD The semantics of all SQL statements will default to the rules established by the ISO and ANSI SQL standards.</p>
ALLOW_BLOCK	ALWBLK	VARCHAR(8)	<p>Indicates the ALWBLK attribute:</p> <p>*ALLREAD Rows are blocked for read-only cursors.</p> <p>*NONE Rows are not blocked for retrieval of data for cursors.</p> <p>*READ Records are blocked for read-only retrieval of data for cursors when:</p> <ul style="list-style-type: none"> *NONE is specified for the Commitment control (COMMIT) parameter. The cursor is declared with a FOR READ ONLY clause or there are no dynamic statements that could run a positioned UPDATE or DELETE statement for the cursor.
DELAY_PREPARE	DLYPRP	VARCHAR(4)	<p>Indicates the DLYPRP attribute:</p> <p>*NO Dynamic statement validation is performed when the dynamic statements are prepared.</p> <p>*YES Dynamic statement validation is delayed until the dynamic statements are used.</p>
USER_PROFILE	USRPRF	VARCHAR(7)	<p>Specifies the user profile used for authority checking:</p> <p>*USER The profile of the user running statements in the package is used.</p> <p>*OWNER The profiles of both the owner of the package and the user running statements in the package is used.</p> <p>*NAMING If the naming convention is *SQL, *OWNER is used. If the naming convention is *SYS, *USER is used.</p>

Table 183. SYSPACKGESTAT view (continued)

Column Name	System Column Name	Data Type	Description
DYNAMIC_USER_PROFILE	DYNUSRPRF	VARCHAR(6)	Specifies the user profile used for dynamic SQL statements: *USER Local dynamic SQL statements are run under the profile of the job or thread. Distributed dynamic SQL statements are run under the profile of the application server job. *OWNER Local dynamic SQL statements are run under the profile of the package's owner. Distributed dynamic SQL statements are run under the profile of the SQL package's owner.
SORT_SEQUENCE	SRTSEQ	VARCHAR(12)	Indicates whether the package uses a collating sequence: BY HEX VALUE The package does not use a collating table. *LANGIDSHR The package uses a shared weight sort sequence (SRTSEQ). *LANGIDUNQ The package uses a unique weight sort sequence (SRTSEQ). ALTSEQ The package uses an alternate collating sequence (ALTSEQ).
LANGUAGE_IDENTIFIER	LANGID	CHAR(3) Nullable	The language ID sort sequence. Contains null if the sort sequence is not *LANGIDSHR or *LANGIDUNQ.
SORT_SEQUENCE_SCHEMA	SRTSEQSCH	CHAR(10) Nullable	The sort sequence table system schema. Contains null if the sort sequence is hex.
SORT_SEQUENCE_NAME	SRTSEQNAME	CHAR(10) Nullable	The sort sequence table name. Contains null if the sort sequence is hex.
RDB_CONNECTION_METHOD	RDBCNMTH	VARCHAR(4)	Specifies the semantics used for CONNECT statements: *RUW CONNECT (Type 1) semantics are used to support remote unit of work. *DUW CONNECT (Type 2) semantics are used to support distributed unit of work.
DECRESULT_MAXIMUM_PRECISION	DECMAXPRC	SMALLINT	Specifies the maximum precision. 31 The maximum precision is 31. 63 The maximum precision is 63.
DECRESULT_MAXIMUM_SCALE	DECMAXSCL	SMALLINT	The maximum scale (number of decimal positions to the right of the decimal point) that should be returned for result data types.
DECRESULT_MINIMUM_DIVIDE_SCALE	DECMINDIV	SMALLINT	The minimum divide scale (number of decimal positions to the right of the decimal point) that should be returned for both intermediate and result data types.

Table 183. SYSPACKAGESTAT view (continued)

Column Name	System Column Name	Data Type	Description
DECFLOAT_ROUNDING_MODE	DECFLTRND	VARCHAR(8) Nullable	Indicates the DECFLOAT rounding mode: CEILING ROUND_CEILING DOWN ROUND_DOWN FLOOR ROUND_FLOOR HALFDOWN ROUND_HALF_DOWN HALFEVEN ROUND_HALF_EVEN HALFUP ROUND_HALF_UP UP ROUND_UP
DECFLOAT_WARNING	DECFLTWRN	VARCHAR(3)	Indicates whether DECFLOAT warnings are returned. NO DECFLOAT warnings are not returned. YES DECFLOAT warnings are returned.
SQLPATH	SQLPATH	VARCHAR(3483) Nullable	Identifies the SQL path. Contains the null value if an SQL path is not specified.
LAST_USED_TIMESTAMP	LASTUSED	TIMESTAMP Nullable	The timestamp of the last time the package was used. If the package has never been used, contains null.
DAYS_USED_COUNT	DAYSUSED	INTEGER	The number of days the package was used since the last time the usage statistics were reset. If the package has never been used since the last time the usage statistics were reset, contains 0.
LAST_RESET_TIMESTAMP	LASTRESET	TIMESTAMP Nullable	The timestamp of the last time the usage statistics were reset. If the statistics have never been reset, contains null.
SYSTEM_PACKAGE_NAME	SYS_NAME	CHAR(10)	System name of the package.
SYSTEM_PACKAGE_SCHEMA	SYS_DNAME	CHAR(10)	System name of the schema containing the package.
IASP_NUMBER	IASPNUMBER	INTEGER	Specifies the independent auxiliary storage pool (IASP) number.
SYSTEM_TIME_SENSITIVE	SYSTIME	VARCHAR(3) Nullable	Specifies whether the CURRENT TEMPORAL SYSTEM_TIME special register affects static and dynamic SQL statements in the package. YES Any references to system-period temporal tables are affected by the value of the CURRENT TEMPORAL SYSTEM_TIME special register. NO Any references to system-period temporal tables are not affected by the value of the CURRENT TEMPORAL SYSTEM_TIME special register. Contains null, which is treated like NO, if the package was created prior to 7.3.

SYSPACKAGESTMTSTAT

The SYSPACKAGESTMTSTAT view contains one row for each SQL statement in every SQL package.

The following table describes the columns in the SYSPACKAGESTMTSTAT view:

Table 184. SYSPACKAGESTMTSTAT view

Column Name	System Column Name	Data Type	Description
PACKAGE_SCHEMA	COLLID	VARCHAR(128)	Name of the schema.
PACKAGE_NAME	NAME	VARCHAR(128)	Name of the SQL package.
SPACE_NAME	SPCNAME	VARCHAR(10) Nullable	Generated space name within the package for extended dynamic packages. Contains the null value for DRDA packages which have only 1 internal space.
STATEMENT_NUMBER	STMTNBR	INTEGER	Number of this statement in the space.
STATEMENT_NAME	STMTNAME	VARCHAR(128) Nullable	Name of the statement. Contains the null value for DRDA packages.
NUMBER_TIMES_PREPARED	NBRPREP	INTEGER	Number of times this statement has been prepared.
NUMBER_TIMES_EXECUTED	NBREXEC	INTEGER	Number of times this statement has been executed. This value is not maintained for CALL, SET, or VALUES INTO statements.
ROWS_AFFECTED	ROWCNT	INTEGER	Total rows fetched, updated, inserted, or deleted for all executions of the statement. Contains 0 if the statement is not a FETCH, SET, VALUES INTO, UPDATE, INSERT, DELETE, or MERGE. Will contain 0 for a SET or VALUES INTO statement that is not implemented using a cursor.
COMPRESSES_SINCE_LAST_USED	CMPLU	INTEGER	Number of times the package has had storage compressed since this statement was last run. This value is used when processing the SQL_STMT_COMPRESS_MAX QAQQINI option to determine when to remove the space used for the QDT for a statement. Will always be 0 for DRDA packages.
PARAMETER_MARKER_CONVERTED	PMCNVT	CHAR(3)	For a dynamic statement, indicates whether literals were converted to parameter markers for statement reuse. YES Literals were converted to parameter markers. NO No conversion done or statement is not dynamic.
WITH_HOLD	WITHHOLD	CHAR(3) Nullable	Specifies the WITH HOLD option for statement: YES WITH HOLD clause specified. Contains the null value if the clause was not specified.
FETCH_ONLY	FETCHONLY	CHAR(3) Nullable	Specifies the FOR READ ONLY option for statement: YES FOR READ ONLY clause specified. Contains the null value if the clause was not specified.
CONCURRENTACCESSRESOLUTION	CONCURRENT	CHAR(1) Nullable	Specifies the concurrent access resolution for the statement: W Wait for outcome U Use currently committed S Skip locked data Contains the null value if concurrent access was not specified at the statement level.

Table 184. SYSPACKAGESTMTSTAT view (continued)

Column Name	System Column Name	Data Type	Description
NUMBER_REBUILDS	NBRREBLD	INTEGER	Number of times QDT or access plan has been rebuilt.
ISOLATION	ISOLATION	CHAR(2) Nullable	Isolation option specification: RR Repeatable Read (*RR) RS Read Stability (*ALL) CS Cursor Stability (*CS) UR Uncommitted Read (*CHG) NC No Commit (*NONE) Contains the null value if isolation level was not specified at the statement level.
NUMBER_ROWS_TO_OPTIMIZE	OPTRROWS	INTEGER Nullable	Number of rows specified on the OPTIMIZE FOR <i>n</i> ROWS clause. -1 means that the value *ALL was specified. Contains the null value if the clause was not specified.
NUMBER_ROWS_TO_FETCH	FETCHROWS	INTEGER Nullable	Number of rows specified on FETCH FIRST <i>n</i> ROWS clause. Contains the null value if the clause was not specified.
LAST_QDT_REBUILD_REASON	QDTRBLD	CHAR(2) Nullable	Reason code for last QDT rebuild. This corresponds to column QVC22 in the STRDBMON outfile when QQRID = 1000. Contains the null value if the statement does not use a QDT or has never had a QDT rebuilt.
STATEMENT_TEXT	STMTTEXT	DBCLOB(2M) CCSID(1200)	Text of the SQL statement.
SYSTEM_PACKAGE_NAME	SYS_NAME	CHAR(10)	System name of the package.
SYSTEM_PACKAGE_SCHEMA	SYS_DNAME	CHAR(10)	System name of the schema containing the package.
ACCESS_PLAN_LENGTH	AP_LENGTH	INTEGER	Number of bytes that are used for the QDT and access plan for the statement.

SYSPARMS

The SYSPARMS table contains one row for each parameter of a procedure created by the CREATE PROCEDURE statement or function created by the CREATE FUNCTION statement. The result of a scalar function and the result columns of a table function are also returned.

The following table describes the columns in the SYSPARMS table:

Table 185. SYSPARMS table

Column Name	System Column Name	Data Type	Description
SPECIFIC_SCHEMA	SPECSHEMA	VARCHAR(128)	Schema name of the routine instance.
SPECIFIC_NAME	SPECNAME	VARCHAR(128)	Specific name of the routine instance.
ORDINAL_POSITION	PARMNO	INTEGER	Numeric place of the parameter in the parameter list, ordered from left to right from 1 (leftmost parameter) to n (n th parameter). For scalar functions, the result of the function has a value of $n+1$. For table functions, the result columns are numbered from $n+1$ (leftmost result column) to $n+m$ (m th result column).
PARAMETER_MODE	PARMMODE	VARCHAR(5)	Type of the parameter: IN This is an input parameter. OUT This is an output parameter. INOUT This is an input/output parameter.
PARAMETER_NAME	PARMNAME	VARCHAR(128) Nullable	Name of the parameter. Contains the null value if the parameter does not have a name.

Table 185. SYSPARMS table (continued)

Column Name	System Column Name	Data Type	Description
DATA_TYPE	DATA_TYPE	VARCHAR(128)	Type of parameter: BIGINT Big number INTEGER Large number SMALLINT Small number DECIMAL Packed decimal NUMERIC Zoned decimal DOUBLE PRECISION Floating point; DOUBLE PRECISION REAL Floating point; REAL DECFLOAT Decimal floating-point CHARACTER Fixed-length character string CHARACTER VARYING Varying-length character string CHARACTER LARGE OBJECT Character large object string GRAPHIC Fixed-length graphic string GRAPHIC VARYING Varying-length graphic string DOUBLE-BYTE CHARACTER LARGE OBJECT Double-byte character large object string BINARY Fixed-length binary string BINARY VARYING Varying-length binary string BINARY LARGE OBJECT Binary large object string DATE Date TIME Time TIMESTAMP Timestamp DATALINK Datalink ROWID Row ID XML XML DISTINCT Distinct type ARRAY Array type
NUMERIC_SCALE	SCALE	INTEGER Nullable	Scale of numeric data. Contains the null value if the parameter is not decimal, numeric, or binary.
NUMERIC_PRECISION	PRECISION	INTEGER Nullable	The precision of all numeric parameters. Note: This column supplies the precision of all numeric data types, including decimal floating-point and single- and double-precision floating point. The NUMERIC_PRECISION_RADIX column indicates if the value in this column is in binary or decimal digits. Contains the null value if the parameter is not numeric.

Table 185. SYSPARMS table (continued)

Column Name	System Column Name	Data Type	Description
CCSID	CCSID	INTEGER Nullable	The CCSID value for CHAR, VARCHAR, CLOB, DATE, TIME, TIMESTAMP, GRAPHIC, VARGRAPHIC, DBCLOB, and DATALINK parameters. A CCSID of 0 indicates that the CCSID of the job at run time is used. XML parameters use the value of SQL_XML_DATA_CCSID from the QAQQINI file. Contains the null value if the parameter is numeric.
CHARACTER_MAXIMUM_LENGTH	CHARLEN	INTEGER Nullable	Maximum length of the string for binary, character, and graphic string and XML data types. Contains the null value if the parameter is not a string.
CHARACTER_OCTET_LENGTH	CHARBYTE	INTEGER Nullable	Number of bytes for binary, character, and graphic string and XML data types. Contains the null value if the parameter is not a string.
NUMERIC_PRECISION_RADIX	RADIX	INTEGER Nullable	Indicates if the precision specified in column NUMERIC_PRECISION is specified as a number of binary or decimal digits: 2 Binary; floating-point precision is specified in binary digits. 10 Decimal; all other numeric types are specified in decimal digits. Contains the null value if the parameter is not numeric.
DATETIME_PRECISION	DATPRC	INTEGER Nullable	The fractional part of a date, time, or timestamp. 0 For DATE and TIME data types 0-12 For TIMESTAMP data types (number of fractional seconds). Contains the null value if the parameter is not date, time, or timestamp.
IS_NULLABLE	NULLS	VARCHAR(3)	Indicates whether the parameter is nullable. NO The parameter does not allow nulls. YES The parameter does allow nulls.
LONG_COMMENT	REMARKS	VARGRAPHIC(2000) CCSID 1200 Nullable	A character string supplied with the COMMENT statement. Contains the null value if there is no long comment.
ROW_TYPE	ROWTYPE	CHAR(1) Nullable	Indicates the type of row. P Parameter. R If the function is a table function, this indicates a result column. Otherwise, the result before casting. C Result after casting.
DATA_TYPE_SCHEMA	TYPESHEMA	VARCHAR(128) Nullable	Schema of the data type if this is a distinct type. Contains the null value if the parameter is not a distinct type.
DATA_TYPE_NAME	TYPENAME	VARCHAR(128) Nullable	Name of the data type if this is a distinct type. Contains the null value if the parameter is not a distinct type.

Table 185. SYSPARMS table (continued)

Column Name	System Column Name	Data Type	Description
AS_LOCATOR	ASLOCATOR	VARCHAR(3)	Indicates whether the parameter was specified as a locator. NO The parameter was not specified as a locator. YES The parameter was specified as a locator.
IASP_NUMBER	IASPNUMBER	SMALLINT	Specifies the independent auxiliary storage pool (IASP) number.
NORMALIZE_DATA	NORMALIZE	VARCHAR(3) Nullable	Indicates whether the parameter value should be normalized or not. This attribute only applies to UTF-8 and UTF-16 data. NO The value should not be normalized. YES The value should be normalized.
DEFAULT	DEFAULT	DBCLOB(64K) CCSID 1200 Nullable	The expression string used to calculate the default value of a parameter, if one exists. If the default value is the null value, the expression string is the keyword NULL. Contains the null value if the parameter has no default.

SYSPARTITIONDISK

The SYSPARTITIONDISK view contains one row for every disk unit used to store data of every table partition or table member. If the table is a distributed table, the partitions that reside on other database nodes are not contained in this catalog view. They are contained in the catalog views of the other database nodes.

The following table describes the columns in the SYSPARTITIONDISK view:

Table 186. SYSPARTITIONDISK view

Column name	System Column Name	Data Type	Description
TABLE_SCHEMA	TABSCHEMA	VARCHAR(128)	Name of the SQL schema that contains the table.
TABLE_NAME	TABNAME	VARCHAR(128)	Name of the table.
TABLE_PARTITION	TABPART	VARCHAR(128)	Name of the table partition or member.
ASP_NUMBER	ASP_NUMBER	SMALLINT	Auxiliary Storage Pool (ASP) containing the partition.
DISK_TYPE	DISK_TYPE	VARCHAR(4)	Disk type number of the disk.
DISK_MODEL	DISK_MODEL	VARCHAR(4)	Model number of the disk.
UNIT_NUMBER	UNITNBR	SMALLINT	Unit number of the disk.
LOGICAL_MIRRORED_PAIR_STATUS	MIRRORPS	CHAR(1) Nullable	Indicates the status of a mirrored pair of disks: 0 Indicates that one mirrored unit of a mirrored pair is not active. 1 Indicates that both mirrored units of a mirrored pair are active. Contains null if the unit is not mirrored.
MIRRORED_UNIT_STATUS	MIRRORUS	CHAR(1) Nullable	Indicates the status of a mirrored unit: 1 Indicates that this mirrored unit of a mirrored pair is active (online with current data). 2 Indicates that this mirrored unit is being synchronized. 3 Indicates that this mirrored unit is suspended. Contains null if the unit is not mirrored.
UNIT_MEDIA_CAPACITY	UNITMCAP	BIGINT	Storage capacity (in bytes) of the unit.
UNIT_SPACE_AVAILABLE	UNITSPACE	BIGINT	Space (in bytes) available on the unit for use.
UNIT_SPACE_RESERVED_FOR_SYSTEM	UNITSRES	BIGINT	Space (in bytes) reserved on the unit for use by the system.
UNIT_SPACE_USED	UNITSUSED	BIGINT	Space (in bytes) on the unit used for the partition.
UNIT_TOTAL_ACCESS_TIME	UNITTATIME	INTEGER	The estimated time, in milliseconds, required to sequentially read the fixed-length data on the unit for the partition. The time is based on the amount of data on the unit and the average access time of the unit. The estimate assumes there will be no contention with other threads for the disk.
UNIT_TYPE	UNIT_TYPE	SMALLINT	Indicates the type of disk unit: 0 Not Solid State Disk (SSD). 1 Solid State Disk (SSD).

Table 186. SYSPARTITIONDISK view (continued)

Column name	System Column Name	Data Type	Description
DATA_SEGMENT_TYPE	SEGMENT	SMALLINT	Segment type of the disk. 0 Indicates that this segment is for fixed-length data. 1 Indicates that this segment is for variable-length data.
SYSTEM_TABLE_SCHEMA	SYS_DNAME	CHAR(10)	System schema name.
SYSTEM_TABLE_NAME	SYS_TNAME	CHAR(10)	System table name.
SYSTEM_TABLE_MEMBER	SYS_MNAME	CHAR(10)	System member name.

SYSPARTITIONINDEXDISK

The SYSPARTITIONINDEXDISK view contains one row for every disk unit used to store the index data of every table partition or table member. If the index is a distributed index, the partitions that reside on other database nodes are not contained in this catalog view. They are contained in the catalog views of the other database nodes.

The following table describes the columns in the SYSPARTITIONINDEXDISK view:

Table 187. SYSPARTITIONINDEXDISK view

Column name	System Column Name	Data Type	Description
TABLE_SCHEMA	TABSCHEMA	VARCHAR(128)	Name of the SQL schema that contains the table.
TABLE_NAME	TABNAME	VARCHAR(128)	Name of the table.
TABLE_PARTITION	TABPART	VARCHAR(128)	Name of the table partition or member.
PARTITION_TYPE	PARTTYPE	CHAR(1)	The type of the table partitioning: blank The table is not partitioned. H This is data hash partitioning. R This is data range partitioning. D This is distributed database hash partitioning.
PARTITION_NUMBER	PARTNBR	INTEGER Nullable	The partition number of this partition. If the table is a distributed table, contains null.
NUMBER_DISTRIBUTED_PARTITIONS	DSTPARTS	INTEGER Nullable	If the table is a distributed table, contains the total number of partitions. If the table is not a distributed table, contains null.
INDEX_SCHEMA	INDSCHEMA	VARCHAR(128)	Name of the SQL schema that contains the index, logical file, or constraint.
INDEX_NAME	INDNAME	VARCHAR(128)	Name of the index, logical file, or constraint.
INDEX_MEMBER	INDMEMBER	VARCHAR(128) Nullable	Name of the member of the index or logical file. If the index type is a constraint, the member name is null.
INDEX_TYPE	INDTYPE	VARCHAR(11)	The type of the index: INDEX The index is an SQL index. LOGICAL The index is part of a logical file. PHYSICAL The index is part of a keyed physical file. PRIMARY KEY The index is a primary key constraint. UNIQUE The index is a unique constraint. REFERENTIAL The index is a foreign key constraint.
PARTITIONED	PARTITION	CHAR(1)	Indicates whether the index is partitioned or not partitioned: 0 An SQL index is not partitioned (spans multiple partitions). 1 The index is not built over a partitioned table or built over a partitioned table and is partitioned (does not span multiple partitions or members). 2 The index is a logical file built over multiple partitions or members.

Table 187. SYSPARTITIONINDEXDISK view (continued)

Column name	System Column Name	Data Type	Description
ASP_NUMBER	ASP_NUMBER	SMALLINT	Auxiliary Storage Pool (ASP) containing the index.
DISK_TYPE	DISK_TYPE	VARCHAR(4)	Disk type number of the disk.
DISK_MODEL	DISK_MODEL	VARCHAR(4)	Model number of the disk.
UNIT_NUMBER	UNITNBR	SMALLINT	Unit number of the disk.
LOGICAL_MIRRORED_PAIR_STATUS	MIRRORPS	CHAR(1) Nullable	Indicates the status of a mirrored pair of disks: 0 Indicates that one mirrored unit of a mirrored pair is not active. 1 Indicates that both mirrored units of a mirrored pair are active. Contains null if the unit is not mirrored.
MIRRORED_UNIT_STATUS	MIRRORUS	CHAR(1) Nullable	Indicates the status of a mirrored unit: 1 Indicates that this mirrored unit of a mirrored pair is active (online with current data). 2 Indicates that this mirrored unit is being synchronized. 3 Indicates that this mirrored unit is suspended. Contains null if the unit is not mirrored.
UNIT_MEDIA_CAPACITY	UNITMCAP	BIGINT	Storage capacity (in bytes) of the unit.
UNIT_SPACE_AVAILABLE	UNITSPACE	BIGINT	Space (in bytes) available on the unit for use.
UNIT_SPACE_RESERVED_FOR_SYSTEM	UNITSRES	BIGINT	Space (in bytes) reserved on the unit for use by the system.
UNIT_SPACE_USED	UNITSUSED	BIGINT	Space (in bytes) on the unit used for the index.
UNIT_TYPE	UNIT_TYPE	SMALLINT	Indicates the type of disk unit: 0 Not Solid State Disk (SSD). 1 Solid State Disk (SSD).
SYSTEM_INDEX_SCHEMA	SYS_IDXNAME	CHAR(10)	System index schema name.
SYSTEM_INDEX_NAME	SYS_IXNAME	CHAR(10)	System index name.
SYSTEM_TABLE_SCHEMA	SYS_DNAME	CHAR(10)	System schema name.
SYSTEM_TABLE_NAME	SYS_TNAME	CHAR(10)	System table name.
SYSTEM_TABLE_MEMBER	SYS_MNAME	CHAR(10)	System member name.

SYSPARTITIONINDEXES

The SYSPARTITIONINDEXES view contains one row for every index built over a table partition or table member. If the table is a distributed table, the indexes over partitions that reside on other database nodes are not contained in this catalog view. They are contained in the catalog views of the other database nodes.

Use this view when you want to see index information for indexes built on a specified table or set of tables. The information is similar to that returned via Show Indexes in System i Navigator

The following table describes the columns in the SYSPARTITIONINDEXES view:

Table 188. SYSPARTITIONINDEXES view

Column name	System Column Name	Data Type	Description
TABLE_SCHEMA	TABSCHEMA	VARCHAR(128)	Name of the SQL schema that contains the table.
TABLE_NAME	TABNAME	VARCHAR(128)	Name of the table.
TABLE_PARTITION	TABPART	VARCHAR(128)	Name of the table partition or member.
INDEX_NAME	INDNAME	VARCHAR(128)	Name of the index, logical file, or constraint. If the index type indicates one or more temporary indexes, INDEX_NAME contains the number of maintained temporary indexes that currently exist on the table followed by the string 'MAINTAINED TEMPORARY INDEXES'.
INDEX_TYPE	INDTYPE	VARCHAR(11)	The type of the index: INDEX The index is an SQL index. LOGICAL The index is part of a logical file. PHYSICAL The index is a part of a keyed physical file. PRIMARY KEY The index is a primary key constraint. UNIQUE The index is a unique constraint. FOREIGN KEY The index is a foreign key constraint. TEMPORARY Indicates one or more temporary indexes exist on the table.
INDEX_SCHEMA	INDSCHEMA	VARCHAR(128) Nullable	Name of the SQL schema that contains the index, logical file, or constraint. Contains null if the row indicates one or more maintained temporary indexes.
INDEX_OWNER	INDOWNER	VARCHAR(128) Nullable	Index owner. Contains null if the row indicates one or more maintained temporary indexes.
SYSTEM_INDEX_SCHEMA	SYS_IXDNAM	CHAR(10) Nullable	System index schema name. Contains null unless the index type is INDEX or LOGICAL.
SYSTEM_INDEX_NAME	SYS_IXNAME	CHAR(10) Nullable	System index name. Contains null unless the index type is INDEX or LOGICAL.
INDEX_TEXT	LABEL	VARGRAPHIC(50) CCSID 1200 Nullable	Text of the index, logical file, or constraint. Contains null if text does not exist for the index.
INDEX_PARTITION	INDMEMBER	VARCHAR(128) Nullable	Partition or member name of the index. Contains null if the row indicates one or more maintained temporary indexes.

Table 188. SYSPARTITIONINDEXES view (continued)

Column name	System Column Name	Data Type	Description
INDEX_VALID	VALID	VARCHAR(3)	An indication or whether the index is invalid and needs to be rebuilt: NO The index is invalid. YES The index is valid.
CREATE_TIMESTAMP	CREATED	TIMESTAMP Nullable	The timestamp when the index was created. Contains null if the row indicates one or more maintained temporary indexes.
LAST_BUILD_TIMESTAMP	LASTBUILD	TIMESTAMP Nullable	The timestamp when the index was last rebuilt. Contains null if the row indicates one or more maintained temporary indexes.
LAST_QUERY_USE	LASTQRYUSE	TIMESTAMP Nullable	The timestamp of the last time the index was used in a query since the last time the usage statistics were reset. If the index has never been used in a query since the last time the usage statistics were reset or if the row indicates one or more maintained temporary indexes, contains null.
LAST_STATISTICS_USE	LASTSTUSE	TIMESTAMP Nullable	The timestamp of the last time the index was used by the optimizer for statistics since the last time the usage statistics were reset. If the index has never been used for statistics since the last time the usage statistics were reset or if the row indicates one or more maintained temporary indexes, contains null.
QUERY_USE_COUNT	QRYUSECNT	BIGINT	The number of times the index was used in a query since the last time the usage statistics were reset. If the index has never been used in a query since the last time the usage statistics were reset, contains 0.
QUERY_STATISTICS_COUNT	QRYSTCNT	BIGINT	The number of times the index was used by the optimizer for statistics since the last time the usage statistics were reset. If the index has never been used for statistics since the last time the usage statistics were reset, contains 0.
LAST_USED_TIMESTAMP		TIMESTAMP Nullable	The timestamp of the last time the index was used directly by an application for native record I/O or SQL operations. If the index has never been used or if the row indicates one or more maintained temporary indexes, contains null.
DAYS_USED_COUNT	DAYSUSED	INTEGER	The number of days the index was used directly by an application for native record I/O or SQL operations since the last time the usage statistics were reset. If the index has never been used since the last time the usage statistics were reset, contains 0.
LAST_RESET_TIMESTAMP	LASTRESET	TIMESTAMP Nullable	The timestamp of the last time the usage statistics were reset for the index. For more information see the Change Object Description (CHGOBJD) command. If the index's last used timestamp has never been reset, contains null.
NUMBER_KEY_COLUMNS	INDKEYS	BIGINT Nullable	Number of columns that define the index key. Contains null if the row indicates one or more maintained temporary indexes.
COLUMN_NAMES	COLNAMES	VARCHAR(1024) Nullable	A comma separated list of column names that define the index key. If the length of all the column names exceeds 1024, '..' is returned at the end of the column value. Contains null if the row indicates one or more maintained temporary indexes.
NUMBER_KEYS	NUMRIDS	BIGINT Nullable	Number of keys in the index. If the index is invalid or is an encoded vector index, -1 is returned. Contains null if the row indicates one or more maintained temporary indexes.
INDEX_SIZE	SIZE	BIGINT	Size (in bytes) of the binary tree or encoded vector index of the index.

Table 188. SYSPARTITIONINDEXES view (continued)

Column name	System Column Name	Data Type	Description
NUMBER_PAGES	PAGES	BIGINT Nullable	Number of pages in the index. If the index is invalid or is an encoded vector index, contains null.
LOGICAL_PAGE_SIZE	PAGE_SIZE	INTEGER Nullable	The logical page size of the index. If the index is an encoded vector index or if the row indicates one or more maintained temporary indexes, contains null.
UNIQUE	UNIQUE	VARCHAR(21) Nullable	Indicates whether an index is unique: UNIQUE The index is a UNIQUE index. UNIQUE WHERE NOT NULL The index is a UNIQUE WHERE NOT NULL index. FIFO The index is a non-unique first-in-first-out (FIFO) index. LIFO The index is a non-unique last-in-last-out (LIFO) index. FCFO The index is a non-unique first-change-first-out (FCFO) index. Contains null if the row indicates one or more maintained temporary indexes.
MAXIMUM_KEY_LENGTH	KEY_LENGTH	INTEGER Nullable	Maximum key length of an index. If the index is an encoded vector index, contains null.
UNIQUE_PARTIAL_KEY_VALUES	KEYCARDS	VARCHAR(96) Nullable	The unique partial key values for the index. If the index is an encoded vector index, the first unique partial key value is the total number of unique values for the entire index key. The remaining unique partial key values returned are not applicable. If the index is one or more maintained temporary indexes, contains null.
OVERFLOW_VALUES	OVERFLOW	INTEGER Nullable	The number of distinct key values that have overflowed the encoded vector index. If the index is not an encoded vector index, contains null.
EVI_CODE_SIZE	CODE_SIZE	INTEGER Nullable	The size of the byte code of the encoded vector index. If the index is not an encoded vector index, contains null.
SPARSE	SPARSE	VARCHAR(3) Nullable	Indicates whether the index contains keys for all the rows of its depended on table: NO The index contains keys for all the rows of its depended on table. YES The index is a select/omit logical file or an SQL index with a WHERE clause and does not contain keys for all the rows of its depended on table. Contains null if the row indicates one or more maintained temporary indexes.
DERIVED_KEY	DERIVED	VARCHAR(3) Nullable	Indicates whether the any key columns in the index are expressions: NO No key columns of the index are expressions. YES At least one key column is an expression. Contains null if the row indicates one or more maintained temporary indexes.

Table 188. SYSPARTITIONINDEXES view (continued)

Column name	System Column Name	Data Type	Description
PARTITIONED	PARTITION	VARCHAR(20) Nullable	Indicates whether the index is partitioned or not partitioned: NO An SQL index is not partitioned (spans multiple partitions). YES The index is not built over a partitioned table or built over a partitioned table and is partitioned (does not span multiple partitions or members). MULTI-MEMBER LOGICAL The index is a logical file built over multiple partitions or members. Contains null if the row indicates one or more maintained temporary indexes.
ACCPH_TYPE	ACCPHTYPE	VARCHAR(4) Nullable	Indicates the type of index: 1 TB The index is a maximum 1 terabyte (*MAX1TB) binary radix index. 4 GB The index is a maximum 4 gigabyte (*MAX4GB) binary radix index. EVI The index is an encoded vector index. Contains null if the row indicates one or more maintained temporary indexes.
SORT_SEQUENCE	SRTSEQ	VARCHAR(12) Nullable	Indicates whether the index uses a collating sequence: BY HEX VALUE The index does not use a collating table. *LANGIDSHR The index uses a shared weight sort sequence (SRTSEQ). *LANGIDUNQ The index uses a unique weight sort sequence (SRTSEQ). ALTSEQ The index uses an alternate collating sequence (ALTSEQ). Contains null if the row indicates one or more maintained temporary indexes.
LANGUAGE_IDENTIFIER	LANGID	CHAR(3) Nullable	The language ID of the index. Contains null if the sort sequence is hex or if the row indicates one or more maintained temporary indexes.
SORT_SEQUENCE_SCHEMA	SRTSEQSCH	CHAR(10) Nullable	Schema name of the sort sequence to use. Contains null if there is no schema name.
SORT_SEQUENCE_NAME	SRTSEQNAME	CHAR(10) Nullable	Name of the sort sequence to use. Contains null if there is no sort sequence name.
ESTIMATED_BUILD_TIME	ESTBLDTIME	INTEGER Nullable	Estimated time (in seconds) required to rebuild the index. Contains null if the row indicates one or more maintained temporary indexes.
LAST_BUILD_TIME	LSTBLDTIME	INTEGER Nullable	Elapsed time (in seconds) the last time the index was built. Contains null if the last build information is not available.
LAST_BUILD_KEYS	LSTBLDKEYS	BIGINT Nullable	Number of keys the last time the index was built. Contains null if the last build information is not available.
LAST_BUILD_DEGREE	LSTBLDDEG	SMALLINT Nullable	Parallel degree the last time the index was built. Contains null if the last build information is not available.

Table 188. SYSPARTITIONINDEXES view (continued)

Column name	System Column Name	Data Type	Description
LAST_BUILD_TYPE	LSTBLDTYPE	CHAR(1) Nullable	<p>An indication of whether the last index build was a complete build or a build from the delayed maintenance keys:</p> <p>0 The last rebuild of the index was from the delayed maintenance keys.</p> <p>1 The last build or rebuild of the index was a complete build from the rows in the table.</p> <p>If the index has never been built, contains null.</p>
LAST_INVALIDATION_TIMESTAMP	LSTINVAL	TIMESTAMP Nullable	<p>An indication of when the index was last invalidated. If the index has never been invalidated, contains null.</p>
LAST_INVALIDATION_REASON_CODE	LSTINVRC	SMALLINT Nullable	<p>The reason code when the index was last invalidated. Reason code values are listed in the SYSINDEXSTAT view.</p> <p>If the index has never been invalidated, contains null.</p>
LAST_INVALIDATION_REASON_TYPE	LSTINVRT	SMALLINT Nullable	<p>The reason type when the index was last invalidated. Reason type values are listed in the SYSINDEXSTAT view.</p> <p>If the index has never been invalidated, contains null.</p>
INDEX_HELD	HELD	VARCHAR(3)	<p>An indication or whether a pending rebuild of the index is currently held by the user:</p> <p>NO A rebuild of the index is not pending or is not held.</p> <p>YES A pending rebuild of the index is held.</p>
MAINTENANCE	MAINT	VARCHAR(11) Nullable	<p>The maintenance of the index:</p> <p>REBUILD The index is not maintained and is rebuilt at open time.</p> <p>DELAYED The index maintenance is delayed until the index is opened.</p> <p>DO NOT WAIT The index is immediately maintained.</p> <p>If the index is an encoded vector index or if the row indicates one or more maintained temporary indexes, contains null.</p>
DELAYED_MAINT_KEYS	DLYKEYS	INTEGER Nullable	<p>Number of keys that need to be inserted into the binary tree of a delayed maintenance index. If the index is not a delayed maintenance index, contains null.</p>
RECOVERY	RECOVERY	VARCHAR(10) Nullable	<p>The recovery attribute of the index:</p> <p>DURING IPL The index is recovered, if necessary, at IPL.</p> <p>AFTER IPL The index is recovered, if necessary, after IPL.</p> <p>NEXT OPEN The index is recovered, if necessary, on the next open.</p> <p>If the index is an encoded vector index or if the row indicates one or more maintained temporary indexes, contains null.</p>

Table 188. SYSPARTITIONINDEXES view (continued)

Column name	System Column Name	Data Type	Description
ROUNDING_MODE	DECFLTRND	VARCHAR(8) Nullable	Indicates the DECFLOAT rounding mode of the index: CEILING ROUND_CEILING DOWN ROUND_DOWN FLOOR ROUND_FLOOR HALFDOWN ROUND_HALF_DOWN HALFEVEN ROUND_HALF_EVEN HALFUP ROUND_HALF_UP UP ROUND_UP Contains the null value if the index does not have an expression that references a DECFLOAT column, function, or constant; or if the row indicates one or more maintained temporary indexes.
DECFLOAT_WARNING	DECFLTWRN	VARCHAR(3) Nullable	Indicates whether DECFLOAT warnings are returned: NO DECFLOAT warnings are not returned. YES DECFLOAT warnings are returned. Contains the null value if the index does not have an expression that references a DECFLOAT column, function, or constant; or if the row indicates one or more maintained temporary indexes.
LOGICAL_READS	LGLREADS	BIGINT Nullable	Number of logical read operations for the index since the last IPL. Contains null if the row indicates one or more maintained temporary indexes.
SEQUENTIAL_READS	SEQREADS	BIGINT	Number of sequential read operations for the index since the last IPL.
RANDOM_READS	RANREADS	BIGINT	Number of random read operations for the index since the last IPL.
SEARCH_CONDITION	IXWHERECON	VARGRAPHIC(1024) CCSID 1200 Nullable	If an index is sparse, the search condition of the index. If the length of the search condition exceeds 1024, '...' is returned at the end of the column value. Contains null if the index is not sparse.
SEARCH_CONDITION_HAS_UDF	IXWHEREUDF	VARCHAR(3) Nullable	If an index is sparse, indicates whether the search condition of the index contains a user-defined function. Contains null if the index is not sparse. NO The index search condition does not contain a UDF. YES The index search condition contains a UDF.
KEEP_IN_MEMORY	KEEPINMEM	VARCHAR(3)	Indicates whether the index should be kept in memory: NO No memory preference. YES The index should be kept in memory, if possible.
MEDIA_PREFERENCE	MEDIAPREF	VARCHAR(3)	Indicates the media preference of the index: ANY No media preference. SSD The index should be allocated on Solid State Disk (SSD), if possible.

Table 188. SYSPARTITIONINDEXES view (continued)

Column name	System Column Name	Data Type	Description
INCLUDE_EXPRESSION	IXINCEPR	VARGRAPHIC(1024) CCSID 1200 Nullable	Index INCLUDE expression. Contains null if the index does not have an INCLUDE expression.
SYSTEM_TABLE_SCHEMA	SYS_DNAME	CHAR(10)	System schema name.
SYSTEM_TABLE_NAME	SYS_TNAME	CHAR(10)	System table name.
SYSTEM_TABLE_MEMBER	SYS_MNAME	CHAR(10)	System member name.

SYSPARTITIONINDEXSTAT

The SYSPARTITIONINDEXSTAT view contains one row for every index built over a table partition or table member. Indexes that share another index's binary tree are not included. If the table is a distributed table, the indexes over partitions that reside on other database nodes are not contained in this catalog view. They are contained in the catalog views of the other database nodes.

The following table describes the columns in the SYSPARTITIONINDEXSTAT view:

Table 189. SYSPARTITIONINDEXSTAT view

Column name	System Column Name	Data Type	Description
TABLE_SCHEMA	TABSCHEMA	VARCHAR(128)	Name of the SQL schema that contains the table.
TABLE_NAME	TABNAME	VARCHAR(128)	Name of the table.
TABLE_PARTITION	TABPART	VARCHAR(128)	Name of the table partition or member.
PARTITION_TYPE	PARTTYPE	CHAR(1)	The type of the table partitioning: blank The table is not partitioned. H This is data hash partitioning. R This is data range partitioning. D This is distributed database hash partitioning.
PARTITION_NUMBER	PARTNBR	INTEGER Nullable	The partition number of this partition. If the table is a distributed table, contains null.
NUMBER_DISTRIBUTED_PARTITIONS	DSTPARTS	INTEGER Nullable	If the table is a distributed table, contains the total number of partitions. If the table is not a distributed table, contains null.
INDEX_SCHEMA	INDSCHEMA	VARCHAR(128)	Name of the SQL schema that contains the index, logical file, or constraint.
INDEX_NAME	INDNAME	VARCHAR(128)	Name of the index, logical file, or constraint.
INDEX_MEMBER	INDMEMBER	VARCHAR(128) Nullable	Name of the member of the index or logical file. If the index type is a constraint, the member name is null.
INDEX_TYPE	INDTYPE	VARCHAR(11)	The type of the index: INDEX The index is an SQL index. LOGICAL The index is part of a logical file. PHYSICAL The index is part of a keyed physical file. PRIMARY KEY The index is a primary key constraint. UNIQUE The index is a unique constraint. REFERENTIAL The index is a foreign key constraint.
NUMBER_KEY_COLUMNS	INDKEYS	BIGINT	Number of columns that define the index key.
COLUMN_NAMES	COLNAMES	VARCHAR(1024)	A comma separated list of column names that define the index key. If the length of all the column names exceeds 1024, '...' is returned at the end of the column value.
NUMBER_LEAF_PAGES	NLEAF	BIGINT	Not applicable for Db2 for i. Will always be -1.
NUMBER_LEVELS	NLEVELS	SMALLINT	Not applicable for Db2 for i. Will always be -1.
FIRSTKEYCARD	KEYCARD1	BIGINT	Number of distinct first key values. If the index is an encoded vector index, this is the total number of unique values for the entire index key.

Table 189. SYSPARTITIONINDEXSTAT view (continued)

Column name	System Column Name	Data Type	Description
FIRST2KEYCARD	KEYCARD2	BIGINT	Number of distinct keys using the first two columns of the index. If the index is an encoded vector index, -1 is returned.
FIRST3KEYCARD	KEYCARD3	BIGINT	Number of distinct keys using the first three columns of the index. If the index is an encoded vector index, -1 is returned.
FIRST4KEYCARD	KEYCARD4	BIGINT	Number of distinct keys using the first four columns of the index. If the index is an encoded vector index, -1 is returned.
FULLKEYCARD	KEYCARDF	BIGINT	Number of distinct full key values. If the index has more than 4 key columns or is an encoded vector index, -1 is returned.
CLUSTERRATIO	CLSRATIO	SMALLINT	Not applicable for Db2 for i. Will always be -1.
CLUSTERFACTOR	CLSFATOR	DOUBLE	Not applicable for Db2 for i. Will always be -1.
SEQUENTIAL_PAGES	SEQPAGES	BIGINT	Not applicable for Db2 for i. Will always be -1.
DENSITY	DENSITY	INTEGER	Not applicable for Db2 for i. Will always be -1.
PAGE_FETCH_PAIRS	FETCHPAIRS	VARCHAR(520)	Not applicable for Db2 for i. Will always be an empty string.
NUMBER_KEYS	NUMRIDS	BIGINT	Number of keys in the index. If the index is invalid or is an encoded vector index, -1 is returned.
NUMRIDS_DELETED	NUMRIDSFLT	BIGINT	Not applicable for Db2 for i. Will always be 0.
NUM_EMPTY_LEAFS	EMPTYLEAFS	BIGINT	Not applicable for Db2 for i. Will always be 0.
AVERAGE_RANDOM_FETCH_PAGES	AVGRNDFETCH	DOUBLE	Not applicable for Db2 for i. Will always be -1.
AVERAGE_RANDOM_PAGES	AVGRNDPAGE	DOUBLE	Not applicable for Db2 for i. Will always be -1.
AVERAGE_SEQUENCE_GAP	AVGSEQGAP	DOUBLE	Not applicable for Db2 for i. Will always be -1.
AVERAGE_SEQUENCE_FETCH_GAP	AVGSEQFGAP	DOUBLE	Not applicable for Db2 for i. Will always be -1.
AVERAGE_SEQUENCE_PAGES	AVGSEQPAGE	DOUBLE	Not applicable for Db2 for i. Will always be -1.
AVERAGE_SEQUENCE_FETCH_PAGES	AVGSEQFPAG	DOUBLE	Not applicable for Db2 for i. Will always be -1.
AVGPARTITION_CLUSTERRATIO	PCLSRATIO	SMALLINT	Not applicable for Db2 for i. Will always be -1.
AVGPARTITION_CLUSTERFACTOR	PCLSFATOR	DOUBLE	Not applicable for Db2 for i. Will always be -1.
AVGPARTITION_PAGE_FETCH_PAIRS	PFETCHPAIR	VARCHAR(520)	Not applicable for Db2 for i. Will always be an empty string.
DATAPARTITION_CLUSTERFACTOR	DCLSFATOR	DOUBLE	A statistic measuring the "clustering" of the index keys with regard to data partitions. It is a number between 0 and 1, with 1 representing perfect clustering and 0 representing no clustering.
INDCARD	INDCARD	BIGINT	Number of keys in the index. If the index is invalid or is an encoded vector index, -1 is returned.
INDEX_VALID	VALID	CHAR(1)	An indication of whether the index is invalid and needs to be rebuilt: 0 The index is invalid. 1 The index is valid. 2 The index was saved with STG(*FREE).
INDEX_HELD	HELD	CHAR(1)	An indication or whether a pending rebuild of the index is currently held by the user: 0 A rebuild of the index is not pending or is not held. 1 A pending rebuild of the index is held.

Table 189. SYSPARTITIONINDEXSTAT view (continued)

Column name	System Column Name	Data Type	Description
CREATE_TIMESTAMP	CREATED	TIMESTAMP	The timestamp when the index was created.
LAST_BUILD_TIMESTAMP	LASTBUILD	TIMESTAMP	The timestamp when the index was last rebuilt.
LAST_QUERY_USE	LASTQRYUSE	TIMESTAMP Nullable	The timestamp of the last time the index was used in a query since the last time the usage statistics were reset. If the index has never been used in a query since the last time the usage statistics were reset, contains null.
LAST_STATISTICS_USE	LASTSTUSE	TIMESTAMP Nullable	The timestamp of the last time the index was used by the optimizer for statistics since the last time the usage statistics were reset. If the index has never been used for statistics since the last time the usage statistics were reset, contains null.
QUERY_USE_COUNT	QRYUSECNT	BIGINT	The number of times the index was used in a query since the last time the usage statistics were reset. If the index has never been used in a query since the last time the usage statistics were reset, contains 0.
QUERY_STATISTICS_COUNT	QRYSTCNT	BIGINT	The number of times the index was used by the optimizer for statistics since the last time the usage statistics were reset. If the index has never been used for statistics since the last time the usage statistics were reset, contains 0.
LAST_USED_TIMESTAMP	LASTUSED	TIMESTAMP Nullable	The timestamp of the last time the index was used directly by an application for native record I/O or SQL operations. If the index has never been used, contains null.
DAYS_USED_COUNT	DAYSUSED	INTEGER	The number of days the index was used directly by an application for native record I/O or SQL operations since the last time the usage statistics were reset. If the index has never been used since the last time the usage statistics were reset, contains 0.
LAST_RESET_TIMESTAMP	LASTRESET	TIMESTAMP Nullable	The timestamp of the last time the usage statistics were reset for the index. For more information see the Change Object Description (CHGOBJD) command. If the index's last used timestamp has never been reset, contains null.
INDEX_SIZE	SIZE	BIGINT	Size (in bytes) of the binary tree or encoded vector index of the index.
ESTIMATED_BUILD_TIME	ESTBLDTIME	INTEGER	Estimated time (in seconds) required to rebuild the index.
LAST_BUILD_TIME	LSTBLDTIME	INTEGER Nullable	Elapsed time (in seconds) the last time the index was built. Contains null if the last build information is not available.
LAST_BUILD_KEYS	LSTBLDKEYS	BIGINT Nullable	Number of keys the last time the index was built. Contains null if the last build information is not available.
LAST_BUILD_DEGREE	LSTBLDDEG	SMALLINT Nullable	Parallel degree the last time the index was built. Contains null if the last build information is not available.
LAST_BUILD_TYPE	LSTBLDTYPE	CHAR(1) Nullable	An indication of whether the last index build was a complete build or a build from the delayed maintenance keys: 0 The last rebuild of the index was from the delayed maintenance keys. 1 The last build or rebuild of the index was a complete build from the rows in the table. If the index has never been built, contains null.
LAST_INVALIDATION_TIMESTAMP	LSTINVAL	TIMESTAMP Nullable	An indication of when the index was last invalidated. If the index has never been invalidated, contains null.

Table 189. SYSPARTITIONINDEXSTAT view (continued)

Column name	System Column Name	Data Type	Description
LAST_INVALIDATION_REASON_CODE	LSTINVRC	SMALLINT Nullable	The reason code when the index was last invalidated. Reason code values are listed in the SYSINDEXSTAT view. If the index has never been invalidated, contains null.
LAST_INVALIDATION_REASON_TYPE	LSTINVRT	SMALLINT Nullable	The reason type when the index was last invalidated. Reason type values are listed in the SYSINDEXSTAT view. If the index has never been invalidated, contains null.
DELAYED_MAINT_KEYS	DLYKEYS	INTEGER Nullable	Number of keys that need to be inserted into the binary tree of a delayed maintenance index. If the index is not a delayed maintenance index, contains null.
SPARSE	SPARSE	CHAR(1)	Indicates whether the index contains keys for all the rows of its depended on table: 0 The index contains keys for all the rows of its depended on table. 1 The index is a select/omit logical file or SQL index with a WHERE clause and does not contain keys for all the rows of its depended on table.
DERIVED_KEY	DERIVED	CHAR(1)	Indicates whether the any key columns in the index are expressions: 0 No key columns of the index are expressions. 1 At least one key column is an expression.
PARTITIONED	PARTITION	CHAR(1)	Indicates whether the index is partitioned or not partitioned: 0 An SQL index is not partitioned (spans multiple partitions). 1 The index is not built over a partitioned table or built over a partitioned table and is partitioned (does not span multiple partitions or members). 2 The index is a logical file built over multiple partitions or members.
ACCPH_TYPE	ACCPHTYPE	CHAR(1)	Indicates the type of index: 0 The index is a maximum 1 terabyte (*MAX1TB) binary radix index. 1 The index is a maximum 4 gigabyte (*MAX4GB) binary radix index. 2 The index is an encoded vector index.

Table 189. SYSPARTITIONINDEXSTAT view (continued)

Column name	System Column Name	Data Type	Description
UNIQUE	UNIQUE	CHAR(1)	Indicates whether an index is unique: 0 The index is a UNIQUE index. 1 The index is a UNIQUE WHERE NOT NULL index. 2 The index is a non-unique first-in-first-out (FIFO) index. 3 The index is a non-unique last-in-last-out (LIFO) index. 4 The index is a non-unique first-change-first-out (FCFO) index.
SRTSEQ_TYPE	SRTSEQ	CHAR(1)	Indicates whether the index uses a collating sequence: 0 The index does not use a collating table. 1 The index uses an alternate collating sequence (ALTSEQ). 2 The index uses a sort sequence (SRTSEQ).
LOGICAL_PAGE_SIZE	PAGE_SIZE	INTEGER Nullable	The logical page size of the index. If the index is an encoded vector index, contains null.
OVERFLOW_VALUES	OVERFLOW	INTEGER Nullable	The number of distinct key values that have overflowed the encoded vector index. If the index is not an encoded vector index, contains null.
EVI_CODE_SIZE	CODE_SIZE	INTEGER Nullable	The size of the byte code of the encoded vector index. If the index is not an encoded vector index, contains null.
LOGICAL_READS	LGLREADS	BIGINT	Number of logical read operations for the index since the last IPL.
PHYSICAL_READS	PHYREADS	BIGINT	Not applicable for Db2 for i. Will always be 0.
SEQUENTIAL_READS	SEQREADS	BIGINT	Number of sequential read operations for the index since the last IPL.
RANDOM_READS	RANREADS	BIGINT	Number of random read operations for the index since the last IPL.
SEARCH_CONDITION	IXWHERECON	VARGRAPHIC(1024) CCSID 1200	If an index is sparse, the search condition of the index. If the length of the search condition exceeds 1024, '...' is returned at the end of the column value.
KEEP_IN_MEMORY	KEEPINMEM	CHAR(1)	Indicates whether the index should be kept in memory: 0 No memory preference. 1 The index should be kept in memory, if possible.
MEDIA_PREFERENCE	MEDIAPREF	SMALLINT	Indicates the media preference of the index: 0 No media preference. 255 The index should be allocated on Solid State Disk (SSD), if possible.
INCLUDE_EXPRESSION	IXINCEPR	VARGRAPHIC(1024) CCSID 1200 Nullable	Index INCLUDE expression. Contains null if the index does not have an INCLUDE expression.
SYSTEM_TABLE_SCHEMA	SYS_DNAME	CHAR(10)	System schema name.

Table 189. SYSPARTITIONINDEXSTAT view (continued)

Column name	System Column Name	Data Type	Description
SYSTEM_TABLE_NAME	SYS_TNAME	CHAR(10)	System table name.
SYSTEM_TABLE_MEMBER	SYS_MNAME	CHAR(10)	System member name.

SYSPARTITIONMQTS

The SYSPARTITIONMQTS view contains one row for every materialized table built over a table partition or table member. If the table is a distributed table, the materialized tables over partitions that reside on other database nodes are not contained in this catalog view. They are contained in the catalog views of the other database nodes.

Use this view when you want to see materialized query table information for materialized tables built on a specified table or set of tables. The information is similar to that returned via Show Materialized Query Tables in System i Navigator.

The following table describes the columns in the SYSPARTITIONMQTS view:

Table 190. SYSPARTITIONMQTS view

Column name	System Column Name	Data Type	Description
TABLE_SCHEMA	TABSCHEMA	VARCHAR(128)	Name of the SQL schema that contains the table.
TABLE_NAME	TABNAME	VARCHAR(128)	Name of the table.
TABLE_PARTITION	TABPART	VARCHAR(128)	Name of the table partition or member.
MQT_NAME	MQTNAME	VARCHAR(128)	Name of the materialized query table.
MQT_SCHEMA	MQTSCHEMA	VARCHAR(128)	Name of the SQL schema that contains the materialized query table.
MQT_PARTITION	MQTMEMBER	VARCHAR(128)	Partition or member name of the materialized query table.
MQT_OWNER	MQTOWNER	VARCHAR(128)	Materialized query table owner.
SYSTEM_MQT_SCHEMA	SYS_MQDNAM	CHAR(10)	System materialized query table schema name.
SYSTEM_MQT_NAME	SYS_MQNAME	CHAR(10)	System materialized query table name.
ENABLED	ENABLED	VARCHAR(3)	An indication or whether the materialized query table is enabled: NO The materialized query table is not enabled for use. YES The materialized query table is enabled for use by the database manager.
CREATE_TIMESTAMP	CREATED	TIMESTAMP	The timestamp when the materialized query table was created.
REFRESH_TIME	REFRESHDTS	TIMESTAMP Nullable	The timestamp when the materialized query table was last refreshed. Contains null if the materialized query table has never been refreshed.
LAST_QUERY_USE	LASTQRYUSE	TIMESTAMP Nullable	The timestamp of the last time the materialized query table was used in a query since the last time the usage statistics were reset. If the materialized query table has never been used in a query since the last time the usage statistics were reset, contains null.
LAST_STATISTICS_USE	LASTSTUSE	TIMESTAMP Nullable	The timestamp of the last time the materialized query table was used by the optimizer for statistics since the last time the usage statistics were reset. If the materialized query table has never been used for statistics since the last time the usage statistics were reset, contains null.
QUERY_USE_COUNT	QRYUSECNT	BIGINT	The number of times the materialized query table was used in a query since the last time the usage statistics were reset. If the materialized query table has never been used in a query since the last time the usage statistics were reset, contains 0.
QUERY_STATISTICS_COUNT	QRYSTCNT	BIGINT	The number of times the materialized query table was used by the optimizer for statistics since the last time the usage statistics were reset. If the materialized query table has never been used for statistics since the last time the usage statistics were reset, contains 0.

Table 190. SYSPARTITIONMQTS view (continued)

Column name	System Column Name	Data Type	Description
LAST_USED_TIMESTAMP	LASTUSED	TIMESTAMP Nullable	The timestamp of the last time the materialized query table was used directly by an application for native record I/O or SQL operations. If the materialized query table has never been used, contains null.
DAYS_USED_COUNT	DAYSUSED	INTEGER	The number of days the materialized query table was used directly by an application for native record I/O or SQL operations since the last time the usage statistics were reset. If the materialized query table has never been used since the last time the usage statistics were reset, contains 0.
LAST_RESET_TIMESTAMP	LASTRESET	TIMESTAMP Nullable	The timestamp of the last time the usage statistics were reset for the materialized query table. For more information see the Change Object Description (CHGOBJD) command. If the materialized query table's last used timestamp has never been reset, contains null.
NUMBER_ROWS	CARD	BIGINT	Number of rows in the materialized query table.
MQT_SIZE	SIZE	BIGINT	Size (in bytes) of the materialized query table.
LAST_CHANGE_TIMESTAMP	LASTCHG	TIMESTAMP Nullable	The timestamp of the last time the materialized query table was changed. If the materialized query table has never been changed since the last time the usage statistics were reset, contains null.
MAINTENANCE	MAINTAIN	VARCHAR(6)	Indicates the maintenance for the materialized query table: SYSTEM The materialized query table is system maintained. USER The materialized query table is user maintained.
INITIAL_DATA	INITIAL	VARCHAR(19)	Indicates the initial data for the materialized query table: INITIALLY DEFERRED Data is not inserted into the materialized query table when it is created. INITIALLY IMMEDIATE Data is inserted into the materialized query table when it is created.
REFRESH	REFRESH	VARCHAR(9)	Indicates when the data in the materialized query table can be refreshed: DEFERRED Data in the materialized query table can be refreshed at any time using the REFRESH TABLE statement. IMMEDIATE Data in the materialized query table is immediately refreshed.
ISOLATION	ISOLATION	VARCHAR(27)	Indicates the isolation level used to refresh the materialized query table: NO COMMIT The isolation level is NO COMMIT. UNCOMMITTED READ The isolation level is UNCOMMITTED READ. CURSOR STABILITY The isolation level is CURSOR STABILITY. CURSOR STABILITY KEEP LOCKS The isolation level is CURSOR STABILITY KEEP LOCKS. READ STABILITY The isolation level is READ STABILITY. REPEATABLE READ The isolation level is REPEATABLE READ.

Table 190. SYSPARTITIONMQTS view (continued)

Column name	System Column Name	Data Type	Description
SORT_SEQUENCE	SRTSEQ	VARCHAR(12)	Indicates whether the materialize query table uses a collating sequence: BY HEX VALUE The materialize query table does not use a collating table. *LANGIDSHR The materialize query table uses a shared weight sort sequence (SRTSEQ). *LANGIDUNQ The materialize query table uses a unique weight sort sequence (SRTSEQ). ALTSEQ The materialize query table uses an alternate collating sequence (ALTSEQ).
LANGUAGE_IDENTIFIER	LANGID	CHAR(3) Nullable	The language ID of the materialize query table. Contains null if the sort sequence is hex.
SORT_SEQUENCE_SCHEMA	SRTSEQSCH	CHAR(10) Nullable	Schema name of the sort sequence to use. Contains null if there is no schema name.
SORT_SEQUENCE_NAME	SRTSEQNAM	CHAR(10) Nullable	Name of the sort sequence to use. Contains null if there is no sort sequence name.
MQT_RESTORE_DEFERRED	MQTRSTDFR	VARCHAR(3)	An indication of whether a restore of the MQT is pending the restore of one of its dependents: NO The restore of the MQT is not deferred pending the restore of one of its dependent tables. YES The restore of the MQT is deferred pending the restore of one of its dependent tables.
ROUNDING_MODE	DECFLTRND	VARCHAR(8) Nullable	Indicates the DECFLOAT rounding mode of the materialized query table: CEILING ROUND_CEILING DOWN ROUND_DOWN FLOOR ROUND_FLOOR HALFDOWN ROUND_HALF_DOWN HALFEVEN ROUND_HALF_EVEN HALFUP ROUND_HALF_UP UP ROUND_UP Contains the null value if the materialized query table does not have an expression that references a DECFLOAT column, function, or constant.
DECFLOAT_WARNING	DECFLTWRN	VARCHAR(3) Nullable	Indicates whether DECFLOAT warnings are returned: NO DECFLOAT warnings are not returned. YES DECFLOAT warnings are returned. Contains the null value if the materialized query table does not have an expression that references a DECFLOAT column, function, or constant.
MQT_DEFINITION	MQTDEF	VARGRAPHIC(5000) CCSID 1200	The query of the materialized query table. If the length of the query exceeds 5000, '...' is returned at the end of the column value.

Table 190. SYSPARTITIONMQTS view (continued)

Column name	System Column Name	Data Type	Description
MQT_TEXT	LABEL	VARGRAPHIC(50) CCSID 1200 Nullable	Text of the materialized query table. Contains null if text does not exist for the materialized query table.
SYSTEM_TABLE_SCHEMA	SYS_DNAME	CHAR(10)	System schema name.
SYSTEM_TABLE_NAME	SYS_TNAME	CHAR(10)	System table name.
SYSTEM_TABLE_MEMBER	SYS_MNAME	CHAR(10)	System member name.

SYSPARTITIONSTAT

The SYSPARTITIONSTAT view contains one row for every table partition or table member. If the table is a distributed table, the partitions that reside on other database nodes are not contained in this catalog view. They are contained in the catalog views of the other database nodes.

The following table describes the columns in the SYSPARTITIONSTAT view:

Table 191. SYSPARTITIONSTAT view

Column name	System Column Name	Data Type	Description
TABLE_SCHEMA	TABSCHEMA	VARCHAR(128)	Name of the SQL schema that contains the table.
TABLE_NAME	TABNAME	VARCHAR(128)	Name of the table.
TABLE_PARTITION	TABPART	VARCHAR(128)	Name of the table partition or member.
PARTITION_TYPE	PARTTYPE	CHAR(1)	The type of the table partitioning: blank The table is not partitioned. H This is data hash partitioning. R This is data range partitioning. D This is distributed database hash partitioning.
PARTITION_NUMBER	PARTNBR	INTEGER Nullable	The partition number of this partition. If the table is a distributed table, contains null.
NUMBER_DISTRIBUTED_PARTITIONS	DSTPARTS	INTEGER Nullable	If the table is a distributed table, contains the total number of partitions. If the table is not a distributed table, contains null.
NUMBER_ROWS	CARD	BIGINT	Number of valid rows in the table partition or member.
NUMBER_ROW_PAGES	NPAGES	BIGINT	Number of 64K pages in the partition's data.
NUMBER_PAGES	FPAGES	BIGINT	Same as NUMBER_ROW_PAGES.
OVERFLOW	OVERFLOW	BIGINT	The estimated number of rows that have overflowed to variable length segments. If the table does not contain variable length or LOB columns, contains 0.
CLUSTERED	CLUSTERED	CHAR(1) Nullable	Not applicable for Db2 for i. Will always be null.
ACTIVE_BLOCKS	ACTBLOCKS	BIGINT	Not applicable for Db2 for i. Will always be -1.
AVGCOMPRESSEDROWSIZE	ACROWSIZE	BIGINT	Not applicable for Db2 for i. Will always be -1.
AVGROWCOMPRESSIONRATIO	ACROWRATIO	REAL	Not applicable for Db2 for i. Will always be -1.
AVGROWSIZE	AVGROWSIZE	BIGINT	Average length (in bytes) of a row in this table. If the table has variable length or LOB columns, contains -1.
PCTROWSCOMPRESSED	PCTCROWS	REAL	Not applicable for Db2 for i. Will always be -1.
PCTPAGESSAVED	PCTPGSAVED	SMALLINT	Not applicable for Db2 for i. Will always be -1.
NUMBER_DELETED_ROWS	DELETED	BIGINT	Number of deleted rows in the table partition or member.
DATA_SIZE	SIZE	BIGINT	Total size (in bytes) of the data space in the partition or member.
VARIABLE_LENGTH_SIZE	VLSIZE	BIGINT	Size (in bytes) of the variable-length data space segments in the partition or member.
VARIABLE_LENGTH_SEGMENTS	VLSEGMENTS	BIGINT	The number of variable-length data space segments in the partition or member.
FIXED_LENGTH_EXTENTS	FLEXTENTS	BIGINT	Not applicable for Db2 for i. Will always be -1.

Table 191. SYSPARTITIONSTAT view (continued)

Column name	System Column Name	Data Type	Description
VARIABLE_LENGTH_EXTENTS	VLEXTENTS	BIGINT	Not applicable for Db2 for i. Will always be -1.
COLUMN_STATS_SIZE	CSTATSSIZE	BIGINT	Size (in bytes) of the column statistics in the partition or member.
MAINTAINED_TEMPORARY_INDEX_SIZE	MTISIZE	BIGINT	Size (in bytes) of all maintained temporary indexes over the partition or member.
NUMBER_DISTINCT_INDEXES	DISTINCTIX	INTEGER	The number of distinct indexes built over the partition or member. This does not include maintained temporary indexes.
OPEN_OPERATIONS	OPENS	BIGINT	Number of full opens of the partition or member since the last IPL.
CLOSE_OPERATIONS	CLOSES	BIGINT	Number of full closes of the partition or member since the last IPL.
INSERT_OPERATIONS	INSERTS	BIGINT	Number of insert operations for the partition or member since the last IPL.
BLOCKED_INSERT_OPERATIONS	BLKIOPS	BIGINT	Number of blocked insert operations for the partition or member since the last IPL.
BLOCKED_INSERT_ROWS	BLKIROW	BIGINT	Number of rows inserted with blocked insert operations for the partition or member since the last IPL.
UPDATE_OPERATIONS	UPDATES	BIGINT	Number of update operations for the partition or member since the last IPL.
DELETE_OPERATIONS	DELETES	BIGINT	Number of delete operations for the partition or member since the last IPL.
CLEAR_OPERATIONS	DSCLEAR	BIGINT	Number of clear operations (CLRPFM operations) for the partition or member since the last IPL.
COPY_OPERATIONS	DSCOPIES	BIGINT	Number of data space copy operations (certain CPYxxx operations) for the partition or member since the last IPL.
REORGANIZE_OPERATIONS	DSREORGS	BIGINT	Number of data space reorganize operations (non-interruptible RGZPFM operations) for the partition or member since the last IPL.
INDEX_BUILDS	DSINXBLDS	BIGINT	Number of creates or rebuilds of indexes that reference the partition or member since the last IPL. This does not include maintained temporary indexes.
LOGICAL_READS	LGLREADS	BIGINT	Number of logical read operations for the partition or member since the last IPL.
PHYSICAL_READS	PHYREADS	BIGINT	Number of physical read operations for the partition or member since the last IPL.
SEQUENTIAL_READS	SEQREADS	BIGINT	Number of sequential read operations for the partition or member since the last IPL.
RANDOM_READS	RANREADS	BIGINT	Number of random read operations for the partition or member since the last IPL.
CREATE_TIMESTAMP	CREATED	TIMESTAMP	Create timestamp of the partition or member.
LAST_CHANGE_TIMESTAMP	LASTCHG	TIMESTAMP	Timestamp of the last change that occurred to the partition or member.
LAST_SAVE_TIMESTAMP	LASTSAVE	TIMESTAMP Nullable	Timestamp of the last save of the partition or member. If the partition or member has never been saved, contains null.
LAST_RESTORE_TIMESTAMP	LASTRST	TIMESTAMP Nullable	Timestamp of the last restore of the partition or member. If the partition or member has never been restored, contains null.
LAST_USED_TIMESTAMP	LASTUSED	TIMESTAMP Nullable	Timestamp of the last time the partition or member was used directly by an application for native record I/O or SQL operations. If the partition or member has never been used, contains null.

Table 191. SYSPARTITIONSTAT view (continued)

Column name	System Column Name	Data Type	Description
DAYS_USED_COUNT	DAYSUSED	INTEGER	The number of days the partition or member was used directly by an application for native record I/O or SQL operations since the last time the usage statistics were reset. If the partition or member has never been used since the last time the usage statistics were reset, contains 0.
LAST_RESET_TIMESTAMP	LASTRESET	TIMESTAMP Nullable	The timestamp of the last time the usage statistics were reset for the table. For more information see the Change Object Description (CHGOBJD) command. If the partition or member's last used timestamp has never been reset, contains null.
NEXT_IDENTITY_VALUE	NEXTVALUE	DECIMAL(31,0) Nullable	The next identity value. In some cases, this value may be an estimate. If the table does not have an identity value, contains null.
LOWINCLUSIVE	LOWINCL	CHAR(1) Nullable	Indicates whether the low key value for the partition is inclusive. N The low key value is not inclusive. Y The low key value is inclusive. If the table is not partitioned by range, contains null.
LOWVALUE	LOWVALUE	VARGRAPHIC(1024) CCSID 1200 Nullable	A string representation of the low key value for a range partition. If the table is not partitioned by range, contains null.
HIGHINCLUSIVE	HIGHINCL	CHAR(1) Nullable	Indicates whether the high key value for the partition is inclusive. N The high key value is not inclusive. Y The high key value is inclusive. If the table is not partitioned by range, contains null.
HIGHVALUE	HIGHVALUE	VARGRAPHIC(1024) CCSID 1200 Nullable	A string representation of the high key value for a range partition. If the table is not partitioned by range, contains null.
NUMBER_PARTITIONING_KEYS	NBRPKEYS	INTEGER Nullable	The number of partitioning keys. If the table is not partitioned, contains null.
PARTITIONING_KEYS	PARTKEYS	VARCHAR(2880) Nullable	The list of partitioning keys. If the table is not partitioned, contains null.
KEEP_IN_MEMORY	KEEPINMEM	CHAR(1)	Indicates whether the partition should be kept in memory: 0 No memory preference. 1 The partition should be kept in memory, if possible.
MEDIA_PREFERENCE	MEDIAPREF	SMALLINT	Indicates the media preference of the partition: 0 No media preference. 255 The partition should be allocated on Solid State Disk (SSD), if possible.
LAST_SOURCE_UPDATE_TIMESTAMP	LASRSRCUPD	TIMESTAMP Nullable	Last source change timestamp to a source member. If the table is not a source file, contains null.
SOURCE_TYPE	SRCTYPE	VARCHAR(10) Nullable	Source type of a source member. If the table is not a source file, contains null.

Table 191. SYSPARTITIONSTAT view (continued)

Column name	System Column Name	Data Type	Description
VOLATILE	VOLATILE	CHAR(1)	Indicates whether the table is volatile. 0 Table is not volatile. 1 Table is volatile.
PARTITION_TEXT	LABEL	VARGRAPHIC(50) CCSID 1200 Nullable	Text of the partition. Contains null if text does not exist for the partition.
PARTIAL_TRANSACTION	PARTIALTX	CHAR(1)	Indicates whether the partition contains a partial transaction: N The partition does not contain a partial transaction. Y The partition was saved while active with a partial transaction. A subsequent restore of the partition contains the partial transaction. The user should apply changes from the journal to complete the transaction. R A rollback abnormally ended prior to completion. This left the partition with a partial set of rolled back rows.
APPLY_STARTING_RECEIVER_LIBRARY	APYRCVLIB	VARCHAR(10) Nullable	The library containing the starting journal receiver. Contains null if APPLY_STARTING_RECEIVER is null.
APPLY_STARTING_RECEIVER	APYRCVNAME	VARCHAR(10) Nullable	Indicates that the partition was saved and subsequently restored. If the table was journaled when the partition was saved, the starting journal receiver name will indicate the journal receiver to start with if APYJRNCHG is then used. Contains null if PARTIAL_TRANSACTION has a value of R. Once an APYJRNCHG is performed, the apply information is cleared.
SYSTEM_TABLE_SCHEMA	SYS_DNAME	CHAR(10)	System schema name.
SYSTEM_TABLE_NAME	SYS_TNAME	CHAR(10)	System table name.
SYSTEM_TABLE_MEMBER	SYS_MNAME	CHAR(10)	System member name.

SYSPERIODS

The SYSPERIODS view contains one row for every period defined for a temporal table in an SQL schema.

The following table describes the columns in the SYSPERIODS view:

Table 192. SYSPERIODS view

Column name	System Column Name	Data Type	Description
PERIOD_NAME	PERIODNAME	VARCHAR(128)	Name of the period.
TABLE_SCHEMA	DBNAME	VARCHAR(128)	Name of the SQL schema that contains the table.
TABLE_NAME	TBNAME	VARCHAR(128)	Name of the temporal table.
BEGIN_COLUMN_NAME	BGNCOLNAME	VARCHAR(128)	Period begin column name.
END_COLUMN_NAME	ENDCOLNAME	VARCHAR(128)	Period end column name
PERIOD_TYPE	PERIODTYPE	CHAR(1)	The type of period for this row: S System period
HISTORY_TABLE_SCHEMA	HSTDBNAME	VARCHAR(128) Nullable	Schema name of the history table. Contains the null value if versioning has not been added to the system-period temporal table.
HISTORY_TABLE_NAME	HSTTBNAME	VARCHAR(128) Nullable	Name of the history table. Contains the null value if versioning has not been added to the system-period temporal table.
ON_DELETE_ADD_EXTRA_ROW	ADD_ROW	VARCHAR(3) Nullable	Versioning defined with ON DELETE ADD EXTRA ROW. YES ON DELETE ADD EXTRA ROW was specified. NO ON DELETE ADD EXTRA ROW was not specified. Contains the null value if versioning has not been added to the system-period temporal table.
VERSIONING_STATUS	VERSIONSTS	CHAR(1) Nullable	Status of versioning E A versioning relationship between the system-period temporal table and the history table has been established. The history table is being used to store previous versions of the system-period temporal table's modified rows. D A versioning relationship between the system-period temporal table and the history table has been defined but not established. Operations on the system-period temporal table will be prevented until the versioning relationship is established or versioning of the system-period temporal table is removed. Contains the null value if versioning has not been added to the system-period temporal table.
SYSTEM_TABLE_SCHEMA	SYS_DNAME	CHAR(10)	System schema name of temporal table.
SYSTEM_TABLE_NAME	SYS_TNAME	CHAR(10)	System name of temporal table.
SYSTEM_HISTORY_TABLE_SCHEMA	SYSHSTLIB	CHAR(10) Nullable	System schema name of the history table. Contains the null value if versioning has not been added to the system-period temporal table.
SYSTEM_HISTORY_TABLE_NAME	SYSHSTNAME	CHAR(10) Nullable	System name of the history table. Contains the null value if versioning has not been added to the system-period temporal table.
SYSTEM_BEGIN_COLUMN_NAME	SYSBGNCOL	CHAR(10)	Period begin system column name.
SYSTEM_END_COLUMN_NAME	SYSENDCOL	CHAR(10)	Period end system column name

SYSPROCS

The SYSPROCS view contains one row for each procedure created by the CREATE PROCEDURE statement.

The following table describes the columns in the SYSPROCS view:

Table 193. SYSPROCS view

Column Name	System Column Name	Data Type	Description
SPECIFIC_SCHEMA	SPECSHEMA	VARCHAR(128)	Schema name of the routine (procedure) instance.
SPECIFIC_NAME	SPECNAME	VARCHAR(128)	Specific name of the routine instance.
ROUTINE_SCHEMA	PROCSHEMA	VARCHAR(128)	Name of the SQL schema (schema) that contains the routine.
ROUTINE_NAME	PROCNAME	VARCHAR(128)	Name of the routine.
ROUTINE_CREATED	RTNCREATE	TIMESTAMP	Identifies the timestamp when the routine was created.
ROUTINE_DEFINER	DEFINER	VARCHAR(128)	Name of the user that defined the routine.
ROUTINE_BODY	BODY	VARCHAR(8)	The type of the routine body: EXTERNAL This is an external routine. SQL This is an SQL routine.
EXTERNAL_NAME	EXTNAME	VARCHAR(279) Nullable	This column identifies the external program name. <ul style="list-style-type: none"> For ILE service programs, the external program name is <i>schema-name/service-program-name(entry-point-name)</i>. For REXX, the external program name is <i>schema-name/source-file-name(member-name)</i>. For Java programs, the external program name is an optional jar-id followed by a <i>fully-qualified-class-name!method-name</i> or <i>fully-qualified-class-name.method-name</i>. For all other languages, the external program name is <i>schema-name/program-name</i>.
EXTERNAL_LANGUAGE	LANGUAGE	VARCHAR(8) Nullable	If this is an external routine, this column identifies the external program's language. C The external program is written in C. C++ The external program is written in C++. CL The external program is written in CL. COBOL The external program is written in COBOL. COBOLLE The external program is written in ILE COBOL. FORTRAN The external program is written in FORTRAN. JAVA The external program is written in JAVA. PLI The external program is written in PL/I. REXX The external program is a REXX procedure. RPG The external program is written in RPG. RPGLE The external program is written in ILE RPG. Contains the null value if this is not an external routine.

Table 193. SYSPROCS view (continued)

Column Name	System Column Name	Data Type	Description
PARAMETER_STYLE	PARM_STYLE	VARCHAR(7) Nullable	<p>If this is an external routine, this column identifies the parameter style (calling convention).</p> <p>DB2GNRL This is the DB2GENERAL calling convention.</p> <p>DB2SQL This is the DB2SQL calling convention.</p> <p>GENERAL This is the GENERAL calling convention.</p> <p>JAVA This is the JAVA calling convention.</p> <p>NULLS This is the GENERAL WITH NULLS calling convention.</p> <p>SQL This is the SQL standard calling convention.</p> <p>Contains the null value if this is not an external routine.</p>
IS_DETERMINISTIC	DETERMINE	VARCHAR(3)	<p>This column identifies whether the routine is deterministic. That is, whether a call to the routine with the same arguments will always return the same result.</p> <p>NO The routine is not deterministic.</p> <p>YES The routine is deterministic.</p>
SQL_DATA_ACCESS	DATAACCESS	VARCHAR(8)	<p>This column identifies whether a routine contains SQL and whether it reads or modifies data.</p> <p>NONE The routine does not contain any SQL statements.</p> <p>CONTAINS The routine contains SQL statements.</p> <p>READS The routine possibly reads data from a table or view.</p> <p>MODIFIES The routine possibly modifies data in a table or view or issues SQL DDL statements.</p>
SQL_PATH	SQL_PATH	VARCHAR(3483) Nullable	<p>If this is an SQL routine, this column identifies the path.</p> <p>Contains the null value if this is not an SQL routine.</p>
PARM_SIGNATURE	SIGNATURE	VARCHAR(16000)	This column identifies the routine signature.
RESULT_SETS	RESULTS	SMALLINT	Identifies the maximum number of result sets returned. 0 indicates that there are no result sets.
IN_PARMs	IN_PARMs	SMALLINT	Identifies the number of input parameters. 0 indicates that there are no input parameters.
OUT_PARMs	OUT_PARMs	SMALLINT	Identifies the number of output parameters. 0 indicates that there are no output parameters.
INOUT_PARMs	INOUT_PARM	SMALLINT	Identifies the number of input/output parameters. 0 indicates that there are no input/output parameters.
LONG_COMMENT	REMARKS	VARGRAPHIC(2000) CCSID 1200 Nullable	<p>A character string supplied with the COMMENT statement.</p> <p>Contains the null value if there is no long comment.</p>
ROUTINE_DEFINITION	ROUTINEDEF	DBCLOB(2M) CCSID 13488 Nullable	<p>If this is an SQL routine, this column contains the SQL routine body.</p> <p>If this is an obfuscated routine, the text starts with the WRAPPED keyword and is followed by the encoded form of the statement text.</p> <p>Contains the null value if this is not an SQL routine.</p>

Table 193. SYSPROCS view (continued)

Column Name	System Column Name	Data Type	Description
DBINFO	DBINFO	VARCHAR(3) Nullable	Identifies whether information about the database is passed to the procedure. NO No database information is passed to the procedure. YES Information about the database is passed to the procedure.
COMMIT_ON_RETURN	CMTONRET	VARCHAR(3) Nullable	This column identifies whether the procedure commits on a successful return from the procedure. NO A commit is not performed on successful return from the procedure. YES A commit is performed on successful return from the procedure. AUT Procedure will commit or rollback autonomously.
IASP_NUMBER	IASPNUMBER	SMALLINT	Specifies the independent auxiliary storage pool (IASP) number.
NEW_SAVEPOINT_LEVEL	NEWSAVEPTL	VARCHAR(3) Nullable	This column identifies whether the routine starts a new savepoint level. NO A new savepoint level is not started. YES A new savepoint level is started.
ROUNDING_MODE	DECFLTRND	CHAR(1) Nullable	If this is an SQL procedure, identifies the DECFLOAT rounding mode. C ROUND_CEILING D ROUND_DOWN F ROUND_FLOOR G ROUND_HALF_DOWN E ROUND_HALF_EVEN H ROUND_HALF_UP U ROUND_UP Contains the null value if the procedure is not an SQL procedure.
ROUTINE_TEXT	LABEL	VARGRAPHIC(50) CCSID 1200 Nullable	Contains the label for a routine. Contains the null value if a label does not exist.
AUTONOMOUS	AUTONOMOUS	VARCHAR(3)	This column identifies whether the procedure is autonomous. NO The procedure is not autonomous. YES The procedure is autonomous.

SYSPROGRAMSTAT

The SYSPROGRAMSTAT view contains one row for each program, service program, and module that contains SQL statements.

The following table describes the columns in the SYSPROGRAMSTAT view:

Table 194. SYSPROGRAMSTAT view

Column Name	System Column Name	Data Type	Description
PROGRAM_SCHEMA	COLLID	VARCHAR(128)	Name of the schema.
PROGRAM_NAME	NAME	VARCHAR(128)	Name of the program, service program, or module. For an SQL procedure, function, or trigger, this is the SQL object name.
PROGRAM_TYPE	PGMTYPE	VARCHAR(128)	Type of the object *PGM The object is a program. *MODULE The object is a module. *SRVPGM The object is a service program.
MODULE_NAME	MODNAME	VARCHAR(10) Nullable	Module name for ILE program or service program. Contains the null value if this is not an ILE program or service program.
PROGRAM_OWNER	OWNER	VARCHAR(128)	Owner of the program, service program, or module
PROGRAM_CREATOR	CREATOR	VARCHAR(128)	Creator of the program, service program, or module
CREATION_TIMESTAMP	TIMESTAMP	TIMESTAMP	Timestamp of when the program, service program, or module was created
DEFAULT_SCHEMA	QUALIFIER	VARCHAR(128) Nullable	Implicit name for unqualified tables, views, and indexes. Contains null if a default schema was not specified (DFTRDBCOL) or if the program is an external procedure without SQL statements.
ISOLATION	ISOLATION	CHAR(2) Nullable	Isolation option specification: RR Repeatable Read (*RR) RS Read Stability (*ALL) CS Cursor Stability (*CS) UR Uncommitted Read (*CHG) NC No Commit (*NONE) Contains null if the program is an external procedure without SQL statements.
CONCURRENTACCESSRESOLUTION	CONCURRENT	CHAR(1) Nullable	Specifies the concurrent access resolution: blank Not specified W Wait for outcome U Use currently committed Contains null if the program is an external procedure without SQL statements.
NUMBER_STATEMENTS	NBRSTMTS	INTEGER	Number of SQL statements in the program, service program or module

Table 194. SYSPROGRAMSTAT view (continued)

Column Name	System Column Name	Data Type	Description
PROGRAM_USED_SIZE	PGMSIZE	INTEGER	Number of bytes that are used for SQL statements and access plans in the program, service program or module.
NUMBER_COMPRESSIONS	PGM_CMP Nullable	INTEGER Nullable	Number of times the program or service program has been compressed. Contains null for modules or if the program is an external procedure without SQL statements.
STATEMENT_CONTENTION_COUNT	CONTENTION	BIGINT Nullable	Number of times contention occurred when attempting to store a new access plan. Contains null for modules or if the program is an external procedure without SQL statements.
ORIGINAL_SOURCE_FILE	SOURCE	VARCHAR(128) Nullable	The fully qualified source file and member that was used to create the program or module. Contains null for SQL routines or if the program is an external procedure without SQL statements.
ORIGINAL_SOURCE_FILE_CCSID	SRC_CCSID	INTEGER Nullable	The CCSID of the source file that was used to create the program or module. Contains null for SQL routines or if the program is an external procedure without SQL statements.
ROUTINE_TYPE	RTNTYPE	VARCHAR(9) Nullable	Type of the routine. PROCEDURE This is a procedure. FUNCTION This is a function. TRIGGER This is a trigger. Contains null for modules or if the program or service program is not a procedure, function, or trigger. An external procedure will not be identified as PROCEDURE unless NUMBER_EXTERNAL_ROUTINES is greater than zero.
ROUTINE_BODY	BODY	VARCHAR(8) Nullable	The type of the routine body: EXTERNAL This is an external routine. SQL This is an SQL routine. Contains null for modules or if the program or service program is not a procedure or function.
FUNCTION_ORIGIN	ORIGIN	CHAR(1) Nullable	Identifies the type of function. If this is a procedure, this column contains a blank. B This is a built-in function (defined by Db2 for i). E This is a user-defined function. U This is a user-defined function that is sourced on another function. S This is a system-generated function. Contains null for modules or if the program or service program is not a procedure or function.

Table 194. SYSPROGRAMSTAT view (continued)

Column Name	System Column Name	Data Type	Description
FUNCTION_TYPE	TYPE	CHAR(1) Nullable	Identifies the form of the function. If this is a procedure, this column contains a blank. S This is a scalar function. C This is a column function. T This is a table function. Contains null for modules or if the program or service program is not a procedure, function, or trigger.
NUMBER_EXTERNAL_ROUTINES	NBEXTRTN	SMALLINT Nullable	Indicates the number of procedure and function definitions stored in the program or service program. Contains null for modules, triggers, or SQL routines.
EXTENDED_INDICATOR	EXTIND	VARCHAR(9) Nullable	Indicates the EXTIND attribute: *EXTIND Extended indicator support is enabled. *NOEXTIND Extended indicator support is not enabled. Contains null if the program is an external procedure without SQL statements.
C_NUL_REQUIRED	CNULRQD	VARCHAR(10) Nullable	Indicates the CNULRQD attribute: *CNULRQD C nuls are required. *NOCNULRQD C nuls are not required. Contains null if the program is an external procedure without SQL statements.
NAMING	NAMING	VARCHAR(4) Nullable	Indicates the NAMING attribute: *SYS This is system naming. *SQL This is SQL naming. Contains null if the program is an external procedure without SQL statements.
TARGET_RELEASE	TGTRLS	VARCHAR(6) Nullable	Indicates the target release of the program, service program, or module (VxRxMx). Contains null if the program is an external procedure without SQL statements.
EARLIEST_POSSIBLE_RELEASE	MINRLS	VARCHAR(6) Nullable	Indicates the earliest IBM i release that supports all the SQL statements in the program, service program, or module (VxRxMx). ANY The statements are valid on any supported IBM i release. VxRxMx The statement is valid on IBM i VxRxMx release or later. Contains null if the earliest release has not yet been determined or if the program is an external procedure without SQL statements.
RDB	RDB	VARCHAR(18) Nullable	Indicates the RDB specified for the program, service program, or module. rdb-name The name of the relational database. *NONE A relational database was not specified. Contains null if the program is an external procedure without SQL statements.

Table 194. SYSPROGRAMSTAT view (continued)

Column Name	System Column Name	Data Type	Description
CONSISTENCY_TOKEN	CONTOKEN	VARBINARY(8) Nullable	Indicates the consistency token of the program. Contains null if the program is an external procedure without SQL statements.
ALLOW_COPY_DATA	ALWCOPYDATA	VARCHAR(9) Nullable	Indicates the ALWCOPYDATA attribute: *NO A copy of the data is not allowed. *OPTIMIZE A copy of the data is allowed whenever it might result in better performance. *YES A copy of the data is allowed, but only when necessary. Contains null if the program is an external procedure without SQL statements.
CLOSE_SQL_CURSOR	CLOSESQLCSR	VARCHAR(10) Nullable	Indicates the CLOSESQLCSR attribute: *ENDACTGRP SQL cursors are closed and SQL prepared statements are implicitly discarded, and LOCK TABLE locks are released when the activation group ends. *ENDJOB SQL cursors are closed and SQL prepared statements are implicitly discarded, and LOCK TABLE locks are released when the job ends. *ENDMOD SQL cursors are closed and SQL prepared statements are implicitly discarded when the module is exited. LOCK TABLE locks are released when the first SQL program on the call stack ends. *ENDPGM SQL cursors are closed and SQL prepared statements are implicitly discarded when the program ends. LOCK TABLE locks are released when the first SQL program on the call stack ends. Contains null if the program is an external procedure without SQL statements.
LOB_FETCH_OPTIMIZATION	OPTLOB	VARCHAR(9)	Indicates the LOB optimization attribute: *OPTLOB The first FETCH for a cursor determines how the cursor will be used for LOB and XML result columns on all subsequent FETCHes. *NOPTLOB Any FETCH may retrieve a LOB or XML result column into either a locator or variable.
DECIMAL_POINT	DECPNT	VARCHAR(7)	Indicates the decimal point for numeric constants used in SQL statements. *PERIOD The decimal point is a period. *COMMA The decimal point is a comma.
SQL_STRING_DELIMITER	STRDLM	VARCHAR(9)	Indicates the character used as the string delimiter in the SQL statements. *APOSTSQL The string delimiter is an apostrophe ('). *QUOTESQL The string delimiter is a quote (").

Table 194. SYSPROGRAMSTAT view (continued)

Column Name	System Column Name	Data Type	Description
DATE_FORMAT	DATFMT	VARCHAR(4) Nullable	<p>Indicates the DATFMT attribute:</p> <p>*JOB The date format specified in the job at runtime is used.</p> <p>*USA The date format is *USA.</p> <p>*ISO The date format is *ISO.</p> <p>*EUR The date format is *EUR.</p> <p>*JIS The date format is *JIS.</p> <p>*MDY The date format is *MDY.</p> <p>*DMY The date format is *DMY.</p> <p>*YMD The date format is *YMD.</p> <p>*JUL The date format is *JUL.</p> <p>Contains null if the program is an external procedure without SQL statements.</p>
DATE_SEPARATOR	DATSEP	CHAR(1) Nullable	<p>Indicates the date separator.</p> <p>Contains null if the program is an external procedure without SQL statements.</p>
TIME_FORMAT	TIMFMT	VARCHAR(4) Nullable	<p>Indicates the TIMFMT attribute:</p> <p>*JOB The time format specified in the job at runtime is used.</p> <p>*USA The time format is *USA.</p> <p>*ISO The time format is *ISO.</p> <p>*EUR The time format is *EUR.</p> <p>*JIS The time format is *JIS.</p> <p>*HMS The date format is *HMS.</p> <p>Contains null if the program is an external procedure without SQL statements.</p>
TIME_SEPARATOR	TIMSEP	CHAR(1) Nullable	<p>Indicates the time separator.</p> <p>Contains null if the program is an external procedure without SQL statements.</p>
DYNAMIC_DEFAULT_SCHEMA	DYNDFTCOL	VARCHAR(4) Nullable	<p>Indicates whether the value for DFTRBCOL should be used for implicit qualification on dynamic SQL statements:</p> <p>*NO The schema specified in DFTDRBCOL is not used for dynamic SQL statements.</p> <p>*YES The schema specified in DFTDRBCOL is used for dynamic SQL statements.</p> <p>Contains null if a default schema was not specified (DFTRBCOL) or if the program is an external procedure without SQL statements.</p>

Table 194. SYSPROGRAMSTAT view (continued)

Column Name	System Column Name	Data Type	Description
CURRENT_RULES	SQLCURRULE	VARCHAR(4) Nullable	<p>Indicates the SQLCURRULE attribute:</p> <p>*DB2 The semantics of all SQL statements will default to the rules established for Db2.</p> <p>*STD The semantics of all SQL statements will default to the rules established by the ISO and ANSI SQL standards.</p> <p>Contains null if the program is an external procedure without SQL statements.</p>
ALLOW_BLOCK	ALWBLK	VARCHAR(8) Nullable	<p>Indicates the ALWBLK attribute:</p> <p>*ALLREAD Rows are blocked for read-only cursors.</p> <p>*NONE Rows are not blocked for retrieval of data for cursors.</p> <p>*READ Records are blocked for read-only retrieval of data for cursors when:</p> <ul style="list-style-type: none"> *NONE is specified for the Commitment control (COMMIT) parameter. The cursor is declared with a FOR READ ONLY clause or there are no dynamic statements that could run a positioned UPDATE or DELETE statement for the cursor. <p>Contains null if the program is an external procedure without SQL statements.</p>
DELAY_PREPARE	DLYPRP	VARCHAR(4) Nullable	<p>Indicates the DLYPRP attribute:</p> <p>*NO Dynamic statement validation is performed when the dynamic statements are prepared.</p> <p>*YES Dynamic statement validation is delayed until the dynamic statements are used.</p> <p>Contains null if the program is an external procedure without SQL statements.</p>
USER_PROFILE	USRPRF	VARCHAR(7) Nullable	<p>Specifies the user profile used for authority checking:</p> <p>*USER The profile of the user running the program is used.</p> <p>*OWNER The profiles of both the owner of the program and the user running the program is used.</p> <p>*NAMING If the naming convention is *SQL, *OWNER is used. If the naming convention is *SYS, *USER is used.</p> <p>Contains null if the program is an external procedure without SQL statements.</p>
DYNAMIC_USER_PROFILE	DYNUSRPRF	VARCHAR(6) Nullable	<p>Specifies the user profile used for dynamic SQL statements:</p> <p>*USER Local dynamic SQL statements are run under the profile of the job or thread. Distributed dynamic SQL statements are run under the profile of the application server job.</p> <p>*OWNER Local dynamic SQL statements are run under the profile of the program's owner. Distributed dynamic SQL statements are run under the profile of the SQL package's owner.</p> <p>Contains null if the program is an external procedure without SQL statements.</p>

Table 194. SYSPROGRAMSTAT view (continued)

Column Name	System Column Name	Data Type	Description
SORT_SEQUENCE	SRTSEQ	VARCHAR(12) Nullable	Indicates whether the program, service program, or module uses a collating sequence: BY HEX VALUE The SQL index does not use a collating table. *LANGIDSHR The SQL index uses a shared weight sort sequence (SRTSEQ). *LANGIDUNQ The SQL index uses a unique weight sort sequence (SRTSEQ). ALTSEQ The SQL index uses an alternate collating sequence (ALTSEQ). Contains null if the program is an external procedure without SQL statements.
LANGUAGE_IDENTIFIER	LANGID	CHAR(3) Nullable	The language ID sort sequence. Contains null if the sort sequence is not *LANGIDSHR or *LANGIDUNQ or if the program is an external procedure without SQL statements.
SORT_SEQUENCE_SCHEMA	SRTSEQSCH	CHAR(10) Nullable	The sort sequence table system schema. Contains null if the sort sequence is hex or if the program is an external procedure without SQL statements.
SORT_SEQUENCE_NAME	SRTSEQNAME	CHAR(10) Nullable	The sort sequence table name. Contains null if the sort sequence is hex or if the program is an external procedure without SQL statements.
RDB_CONNECTION_METHOD	RDBCNMTH	VARCHAR(4) Nullable	Specifies the semantics used for CONNECT statements: *RUW CONNECT (Type 1) semantics are used to support remote unit of work. *DUW CONNECT (Type 2) semantics are used to support distributed unit of work. Contains null if the program is an external procedure without SQL statements.
DECRESULT_MAXIMUM_PRECISION	DECMAXPRC	SMALLINT Nullable	Specifies the maximum precision. 31 The maximum precision is 31. 63 The maximum precision is 63. Contains null if the program is an external procedure without SQL statements.
DECRESULT_MAXIMUM_SCALE	DECMAXSCL	SMALLINT Nullable	The maximum scale (number of decimal positions to the right of the decimal point) that should be returned for result data types. Contains null if the program is an external procedure without SQL statements.
DECRESULT_MINIMUM_DIVIDE_SCALE	DECMINDIV	SMALLINT Nullable	The minimum divide scale (number of decimal positions to the right of the decimal point) that should be returned for both intermediate and result data types. Contains null if the program is an external procedure without SQL statements.

Table 194. SYSPROGRAMSTAT view (continued)

Column Name	System Column Name	Data Type	Description
DECFLOAT_ROUNDING_MODE	DECFLTRND	VARCHAR(8) Nullable	Indicates the DECFLOAT rounding mode: CEILING ROUND_CEILING DOWN ROUND_DOWN FLOOR ROUND_FLOOR HALFDOWN ROUND_HALF_DOWN HALFEVEN ROUND_HALF_EVEN HALFUP ROUND_HALF_UP UP ROUND_UP Contains null if the program is an external procedure without SQL statements.
DECFLOAT_WARNING	DECFLTWRN	VARCHAR(3) Nullable	Indicates whether DECFLOAT warnings are returned. NO DECFLOAT warnings are not returned. YES DECFLOAT warnings are returned. Contains null if the program is an external procedure without SQL statements.
SQLPATH	SQLPATH	VARCHAR(3483) Nullable	Identifies the SQL path. Contains the null value if an SQL path is not specified or if the program is an external procedure without SQL statements.
DBGVIEW	DBGVIEW	VARCHAR(9) Nullable	Specifies the type of source debug information: *NONE No debug. *SOURCE Debug view includes source and SQL INCLUDE statements. *STMT Debug view includes precompiler generated statements. *LIST Debug view includes the compiled listing. *LSTDBG Debug view includes the compiled listing of an OPM program. ALLOW Source debug allowed by the Unified Debugger. DISALLOW Source debug not allowed by the Unified Debugger. DISABLE Source debug not allowed by the Unified Debugger and the DEBUG MODE cannot be altered. Contains null if the program is an external procedure without SQL statements.

Table 194. SYSPROGRAMSTAT view (continued)

Column Name	System Column Name	Data Type	Description
DBGKEY	DBGKEY	VARCHAR(3) Nullable	Specifies the type of source debug information: NO No encryption key was specified on the debug encryption key (DBGENCKEY) parameter. YES A key was specified on the debug encryption key (DBGENCKEY) parameter. Contains null if DBGENCKEY is not supported or if the program is an external procedure without SQL statements.
LAST_USED_TIMESTAMP	LASTUSED	TIMESTAMP Nullable	The timestamp of the last time the program, service program, or module was used. Contains null if the program, service program, or module has never been used.
DAYS_USED_COUNT	DAYSUSED	INTEGER	The number of days the program, service program, or module was used since the last time the usage statistics were reset. If the program, service program, or module has never been used since the last time the usage statistics were reset, contains 0.
LAST_RESET_TIMESTAMP	LASTRESET	TIMESTAMP Nullable	The timestamp of the last time the usage statistics were reset. Contains null if the statistics have never been reset.
SYSTEM_PROGRAM_NAME	SYS_NAME	CHAR(10)	System name of the program, service program, or module.
SYSTEM_PROGRAM_SCHEMA	SYS_DNAME	CHAR(10)	System name of the schema containing the program, service program, or module.
IASP_NUMBER	IASPNUMBER	INTEGER	Specifies the independent auxiliary storage pool (IASP) number.
SYSTEM_TIME_SENSITIVE	SYSTIME	VARCHAR(3) Nullable	Specifies whether the CURRENT TEMPORAL SYSTEM_TIME special register affects static and dynamic SQL statements in the program. YES Any references to system-period temporal tables are affected by the value of the CURRENT TEMPORAL SYSTEM_TIME special register. NO Any references to system-period temporal tables are not affected by the value of the CURRENT TEMPORAL SYSTEM_TIME special register. Contains null, which is treated like NO, if the program was compiled prior to 7.3.

SYSPROGRAMSTMTSTAT

The SYSPROGRAMSTMTSTAT view contains one row for each embedded SQL statement in a program, module, or service program.

The following table describes the columns in the SYSPROGRAMSTMTSTAT view:

Table 195. SYSPROGRAMSTMTSTAT view

Column Name	System Column Name	Data Type	Description
PROGRAM_SCHEMA	COLLID	VARCHAR(128)	Name of the schema.
PROGRAM_NAME	NAME	VARCHAR(128)	Name of the program, service program, or module. For an SQL procedure, function, or trigger, this is the SQL object name.
PROGRAM_TYPE	PGMTYPE	VARCHAR(128)	Type of the object : *PGM The object is a program. *MODULE The object is a module. *SRVPGM The object is a service program.
MODULE_NAME	MODNAME	VARCHAR(10) Nullable	Module name for ILE program or service program. Contains the null value if this is not an ILE program or service program.
STATEMENT_NUMBER	STMTNBR	INTEGER	Statement number in program.
NUMBER_TIMES_EXECUTED	NBEXEC	INTEGER	Number of times this statement has been executed. This value is not maintained for CALL, SET, or VALUES INTO statements.
ROWS_AFFECTED	ROWCNT	INTEGER	Total rows fetched, updated, inserted, or deleted for all executions of the statement. Contains 0 if the statement is not a FETCH, SET, VALUES INTO, UPDATE, INSERT, DELETE, or MERGE. Will contain 0 for a SET or VALUES INTO statement that is not implemented using a cursor.
NUMBER_HOST_VARIABLES	NBRHV	INTEGER	Total number of host variables specified in the statement. This includes input and output host variables.
NUMBER_INPUT_HOST_VARIABLES	NBRIHV	INTEGER	Number of input host variables specified in the statement.
WITH_HOLD	WITHHOLD	CHAR(3) Nullable	Specifies the WITH HOLD option for statement: YES WITH HOLD clause specified. Contains the null value if the clause was not specified.
FETCH_ONLY	FETCHONLY	CHAR(3) Nullable	Specifies the FOR READ ONLY option for statement: YES FOR READ ONLY clause specified. Contains the null value if the clause was not specified.
CONCURRENTACCESSRESOLUTION	CONCURRENT	CHAR(1) Nullable	Specifies the concurrent access resolution for the statement: W Wait for outcome U Use currently committed S Skip locked data Contains the null value if concurrent access was not specified at the statement level.
NUMBER_REBUILDS	NBRREBLD	INTEGER	Number of times QDT or access plan has been rebuilt.

Table 195. SYSPROGRAMSTMTSTAT view (continued)

Column Name	System Column Name	Data Type	Description
ISOLATION	ISOLATION	CHAR(2) Nullable	Isolation option specification: RR Repeatable Read (*RR) RS Read Stability (*ALL) CS Cursor Stability (*CS) UR Uncommitted Read (*CHG) NC No Commit (*NONE) Contains the null value if isolation level was not specified at the statement level.
NUMBER_ROWS_TO_OPTIMIZE	OPTROWS	INTEGER Nullable	Number of rows specified on the OPTIMIZE FOR <i>n</i> ROWS clause. -1 means that the value *ALL was specified. Contains the null value if the clause was not specified.
NUMBER_ROWS_TO_FETCH	FETCHROWS	INTEGER Nullable	Number of rows specified on the FETCH FIRST <i>n</i> ROWS clause. Contains the null value if the clause was not specified.
LAST_QDT_REBUILD_REASON	QDTRBLD	CHAR(2) Nullable	Reason code for last QDT rebuild. This corresponds to column QVC22 in the STRDBMON outfile when QQRID = 1000. Contains the null value if the statement does not use a QDT or has never had a QDT rebuild.
STATEMENT_TEXT	STMTTEXT	DBCLOB(2M) CCSID(1200)	Text of the SQL statement.
SYSTEM_PROGRAM_NAME	SYS_NAME	CHAR(10)	System name of the program.
SYSTEM_PROGRAM_SCHEMA	SYS_DNAME	CHAR(10)	System name of the schema containing the program.
ACCESS_PLAN_LENGTH	AP_LENGTH	INTEGER	Number of bytes that are used for the QDT and access plan for the statement.
EARLIEST_POSSIBLE_RELEASE	MINRLS	VARCHAR(6)	The earliest IBM i release that supports this SQL statement (VxRxMx). ANY The statement is valid on any supported IBM i release. VxRxMx The statement is valid on IBM i VxRxMx release or later. Contains the null value if the earliest release is not known.
SQL_DB2_GROUP_LEVEL	SQL_LEVEL	INTEGER Nullable	The latest Db2 PTF Group level that SQL language syntax used in this statement is dependent on. Contains the null value if no SQL syntax in this statement was identified as being dependent on a Db2 PTF Group.
SERVICES_DB2_GROUP_LEVEL	SERV_LEVEL	INTEGER Nullable	The latest Db2 PTF Group level that a service referenced in this statement might be dependent on. This column contains a value if the SQL statement references an IBM i provided service or Db2 for i built-in function or built-in global variable. If the SQL statement includes unqualified references to objects whose names match IBM i provided services, this column considers the unqualified name as the IBM i service. Contains the null value if no built-in function, built-in global variable, or IBM i provided service in this statement was identified as being dependent on a Db2 PTF Group.

SYSREFCST

The SYSREFCST view contains one row for each foreign key in the SQL schema.

The following table describes the columns in the SYSREFCST view:

Table 196. SYSREFCST view

Column Name	System Column Name	Data Type	Description
CONSTRAINT_SCHEMA	CDBNAME	VARCHAR(128)	Name of the schema containing the constraint.
CONSTRAINT_NAME	RELNAME	VARCHAR(128)	Name of the constraint.
UNIQUE_CONSTRAINT_SCHEMA	UNQDBNAME	VARCHAR(128) Nullable	Name of the SQL schema containing the unique constraint referenced by the referential constraint. Contains the null value if the unique constraint does not exist. This is usually caused by restoring the table without its parent table.
UNIQUE_CONSTRAINT_NAME	UNQNAME	VARCHAR(128) Nullable	Name of the unique constraint referenced by the referential constraint. Contains the null value if the unique constraint does not exist. This is usually caused by restoring the table without its parent table.
MATCH_OPTION	MATCH	VARCHAR(7)	Match option. Will always be NONE.
UPDATE_RULE	UPDATE	VARCHAR(11)	Update Rule. <ul style="list-style-type: none"> • NO ACTION • RESTRICT
DELETE_RULE	DELETE	VARCHAR(11)	Delete Rule <ul style="list-style-type: none"> • NO ACTION • CASCADE • SET NULL • SET DEFAULT • RESTRICT
COLUMN_COUNT	COLCOUNT	INTEGER	Number of columns in the foreign key.
SYSTEM_CONSTRAINT_SCHEMA	SYS_CDNAME	CHAR(10)	Name of the system schema containing the constraint.
SYSTEM_UNIQUE_CONSTRAINT_SCHEMA	SYS_UDNAME	CHAR(10) Nullable	Name of the system schema containing the constraint. Contains the null value if the unique constraint does not exist. This is usually caused by restoring the table without its parent table.

SYSROUTINEAUTH

The SYSROUTINEAUTH view contains one row for every privilege granted on a routine. Note that this catalog view cannot be used to determine whether a user is authorized to a routine because the privilege to use a routine could be acquired through a group user profile or special authority (such as *ALLOBJ).

The following table describes the columns in the SYSROUTINEAUTH view:

Table 197. SYSROUTINEAUTH view

Column Name	System Column Name	Data Type	Description
GRANTOR	GRANTOR	VARCHAR(128) Nullable	Reserved. Contains the null value.
GRANTEE	GRANTEE	VARCHAR(128)	The user profile to which the privilege is granted.
ROUTINE_SCHEMA	RTNSHEMA	VARCHAR(128)	Name of the schema
ROUTINE_NAME	RTNNAME	VARCHAR(128)	Name of the routine
SPECIFIC_SCHEMA	SPECSHEMA	VARCHAR(128)	Specific name of the schema
SPECIFIC_NAME	SPECNAME	VARCHAR(128)	Specific name of the routine
PRIVILEGE_TYPE	PRIVTYPE	VARCHAR(10)	The privilege granted: ALTER The privilege to alter the routine. EXECUTE The privilege to execute the routine.
IS_GRANTABLE	GRANTABLE	VARCHAR(3)	Indicates whether the privilege is grantable to other users. NO The privilege is not grantable. YES The privilege is grantable.
AUTHORIZATION_LIST	AUTL	VARCHAR(10) Nullable	If the privilege is granted through an authorization, contains the name of the authorization list. Contains the null value if the privilege is not granted through an authorization list.

SYSROUTINEDEP

The SYSROUTINEDEP view records the dependencies of routines.

The following table describes the columns in the SYSROUTINEDEP view:

Table 198. SYSROUTINEDEP view

Column name	System Column Name	Data Type	Description
SPECIFIC_SCHEMA	SPECSHEMA	VARCHAR(128)	Schema name of the routine instance.
SPECIFIC_NAME	SPECNAME	VARCHAR(128)	Specific name of the routine instance.
OBJECT_CATALOG	BCATALOG	VARCHAR(128) Nullable Contains the null value if the relational database name was not specified.	Name of the relational database that contains the object.
OBJECT_SCHEMA	BSHEMA	VARCHAR(128)	Name of the SQL schema that contains the object.
OBJECT_NAME	BNAME	VARCHAR(128)	Name of the object the routine is dependent on.
OBJECT_TYPE	BTYPE	CHAR(24)	Indicates the object type of the object referenced in the routine: ALIAS The object is an alias. FUNCTION The object is a function. INDEX The object is an index. MATERIALIZED QUERY TABLE The object is a materialized query table. PROCEDURE The object is a procedure. SCHEMA The object is a schema. SEQUENCE The object is a sequence. TABLE The object is a table. If the object does not exist at the time the routine is created or the OBJECT_SCHEMA is *LIBL, TABLE may be returned even though the actual object used at run time may be an alias, materialized query table, or view. TYPE The object is a distinct type. VARIABLE The object is a variable. VIEW The object is a view.
PARAM_SIGNATURE	SIGNATURE	BLOB(3M) Nullable	This column identifies the routine signature. Contains the null value if the object is not a routine.
IASP_NUMBER	IASPNUMBER	SMALLINT	Specifies the independent auxiliary storage pool (IASP) number of the object.
NUMBER_OF_PARAMS	NUMPARMS	SMALLINT Nullable	Identifies the number of parameters. Contains the null value if the object is not a routine.

SYSROUTINES

The SYSROUTINES table contains one row for each procedure created by the CREATE PROCEDURE statement and each function created by the CREATE FUNCTION statement.

The following table describes the columns in the SYSROUTINES table:

Table 199. SYSROUTINES table

Column Name	System Column Name	Data Type	Description
SPECIFIC_SCHEMA	SPECSHEMA	VARCHAR(128)	Schema name of the routine instance.
SPECIFIC_NAME	SPECNAME	VARCHAR(128)	Specific name of the routine instance.
ROUTINE_SCHEMA	RTNSHEMA	VARCHAR(128)	Name of the SQL schema (schema) that contains the routine.
ROUTINE_NAME	RTNNAME	VARCHAR(128)	Name of the routine.
ROUTINE_TYPE	RTNTYPE	VARCHAR(9)	Type of the routine. PROCEDURE This is a procedure. FUNCTION This is a function.
ROUTINE_CREATED	RTNCREATE	TIMESTAMP	Identifies the timestamp when the routine was created.
ROUTINE_DEFINER	DEFINER	VARCHAR(128)	Name of the user that defined the routine.
ROUTINE_BODY	BODY	VARCHAR(8)	The type of the routine body: EXTERNAL This is an external routine. SQL This is an SQL routine.
EXTERNAL_NAME	EXTNAME	VARCHAR(279) Nullable	This column identifies the external program name. <ul style="list-style-type: none"> For SQL functions or ILE service programs, the external program name is <i>schema-name/service-program-name(entry-point-name)</i>. For REXX, the external program name is <i>schema-name/source-file-name(member-name)</i>. For Java programs, the external program name is an optional jar-id followed by a <i>fully-qualified-class-name/method-name</i> or <i>fully-qualified-class-name.method-name</i>. For all other languages, the external program name is <i>schema-name/program-name</i>. Contains the null value if this is a system-generated function.

Table 199. SYSROUTINES table (continued)

Column Name	System Column Name	Data Type	Description
EXTERNAL_LANGUAGE	LANGUAGE	VARCHAR(8) Nullable	<p>If this is an external routine, this column identifies the external program's language.</p> <p>C The external program is written in C.</p> <p>C++ The external program is written in C++.</p> <p>CL The external program is written in CL.</p> <p>COBOL The external program is written in COBOL.</p> <p>COBOLLE The external program is written in ILE COBOL.</p> <p>FORTRAN The external program is written in FORTRAN.</p> <p>JAVA The external program is written in JAVA.</p> <p>PLI The external program is written in PL/I.</p> <p>REXX The external program is a REXX procedure.</p> <p>RPG The external program is written in RPG.</p> <p>RPGLE The external program is written in ILE RPG.</p> <p>Contains the null value if this is not an external routine.</p>
PARAMETER_STYLE	PARM_STYLE	VARCHAR(7) Nullable	<p>If this is an external routine, this column identifies the parameter style (calling convention).</p> <p>DB2GNRL This is the DB2GENERAL calling convention.</p> <p>DB2SQL This is the DB2SQL calling convention.</p> <p>GENERAL This is the GENERAL calling convention.</p> <p>JAVA This is the JAVA calling convention.</p> <p>NULLS This is the GENERAL WITH NULLS calling convention.</p> <p>SQL This is the SQL standard calling convention.</p> <p>Contains the null value if this is not an external routine.</p>
IS_DETERMINISTIC	DETERMINE	VARCHAR(3)	<p>This column identifies whether the routine is deterministic. That is, whether a call to the routine with the same arguments will always return the same result.</p> <p>NO The routine is not deterministic.</p> <p>YES The routine is global deterministic.</p> <p>STM The routine is statement deterministic.</p>

Table 199. SYSROUTINES table (continued)

Column Name	System Column Name	Data Type	Description
SQL_DATA_ACCESS	DATAACCESS	VARCHAR(8) Nullable	This column identifies whether a routine contains SQL and whether it reads or modifies data. NONE The routine does not contain any SQL statements. CONTAINS The routine contains SQL statements. READS The routine possibly reads data from a table or view. MODIFIES The routine possibly modifies data in a table or view or issues SQL DDL statements.
SQL_PATH	SQL_PATH	VARCHAR(3483) Nullable	If this is an SQL routine, this column identifies the path. Contains the null value if this is not an SQL routine.
PARAM_SIGNATURE	SIGNATURE	VARCHAR(16000)	This column identifies the routine signature.
NUMBER_OF_RESULTS	NUMRESULTS	SMALLINT	Identifies the number of results.
MAX_DYNAMIC_RESULT_SETS	RESULTS	SMALLINT	Identifies the maximum number of result sets returned. 0 indicates that there are no result sets.
IN_PARAMS	IN_PARAMS	SMALLINT	Identifies the number of input parameters. 0 indicates that there are no input parameters.
OUT_PARAMS	OUT_PARAMS	SMALLINT	Identifies the number of output parameters. 0 indicates that there are no output parameters.
INOUT_PARAMS	INOUT_PARAM	SMALLINT	Identifies the number of input/output parameters. 0 indicates that there are no input/output parameters.
PARSE_TREE	PARSE_TREE	VARCHAR(1024) FOR BIT DATA	Identifies the parse tree of the CREATE FUNCTION or CREATE PROCEDURE statement. It is only used internally.
PARAM_ARRAY	PARAM_ARRAY	BLOB(4M)	If this is an external routine, this column identifies the parameter array built from the CREATE FUNCTION or CREATE PROCEDURE statement. It is only used internally.
LONG_COMMENT	REMARKS	VARGRAPHIC(2000) CCSID 1200 Nullable	A character string supplied with the COMMENT statement. Contains the null value if there is no long comment.
ROUTINE_DEFINITION	ROUTINEDEF	DBCLOB(2M) CCSID 13488 Nullable	If this is an SQL routine, this column contains the SQL routine body. If this is an obfuscated routine, the text starts with the WRAPPED keyword and is followed by the encoded form of the statement text. Contains the null value if this is not an SQL routine.
FUNCTION_ORIGIN	ORIGIN	CHAR(1)	Identifies the type of function. If this is a procedure, this column contains a blank. B This is a built-in function (defined by Db2 for i). E This is a user-defined function. U This is a user-defined function that is sourced on another function. S This is a system-generated function.

Table 199. SYSROUTINES table (continued)

Column Name	System Column Name	Data Type	Description
FUNCTION_TYPE	TYPE	CHAR(1)	Identifies the form of the function. If this is a procedure, this column contains a blank. S This is a scalar function. C This is a column function. T This is a table function.
EXTERNAL_ACTION	EXTACTION	CHAR(1) Nullable	Identifies whether the invocation of the function has external effects. E This function has external side effects. N This function does not have any external side effects. Contains the null value if the routine is a procedure.
IS_NULL_CALL	NULL_CALL	VARCHAR(3) Nullable	Identifies whether the function needs to be called if an input parameter is the null value. NO This function need not be called if an input parameter is the null value. If this is a scalar function, the result of the function is implicitly null if any of the operands are null. If this is a table function, the result of the function is an empty table if any of the operands are the null value. YES This function must be called even if an input operand is null. Contains the null value if the routine is a procedure.
SCRATCH_PAD	SCRATCHPAD	INTEGER Nullable	Identifies whether the address of a static memory area (scratch pad) is passed to the function. 0 The function does not have a scratch pad. integer Indicates the size of the scratch pad passed to the function. Contains the null value if the routine is a procedure.
FINAL_CALL	FINAL_CALL	VARCHAR(3) Nullable	Indicates whether a final call to the function should be made to allow the function to clean up its work areas (scratch pads). NO No final call is made. YES A final call to the function is made when the statement is complete. Contains the null value if the routine is a procedure.
PARALLELIZABLE	PARALLEL	VARCHAR(3) Nullable	Identifies whether the function can be run in parallel. NO The function must be synchronous. YES The function can be run in parallel. Contains the null value if the routine is a procedure.

Table 199. SYSROUTINES table (continued)

Column Name	System Column Name	Data Type	Description
DBINFO	DBINFO	VARCHAR(3) Nullable	Identifies whether information about the database is passed to the routine. NO No database information is passed to the routine. YES Information about the database is passed to the routine. Contains the null value if the routine is a procedure.
SOURCE_SPECIFIC_SCHEMA	SRCSCHEMA	VARCHAR(128) Nullable	If this is sourced function and the source is user-defined, this column contains the name of the source schema. If this is a sourced function and the source is built-in, this column contains 'QSYS2'. Contains the null value if the routine is not a sourced function.
SOURCE_SPECIFIC_NAME	SRCNAME	VARCHAR(128) Nullable	If this is sourced function and the source is user-defined, this column contains the specific name of the source function name. Contains the null value if the routine is not a sourced function.
IS_USER_DEFINED_CAST	CAST_FUNC	VARCHAR(3) Nullable	Identifies whether the this function is a cast function created when a distinct type was created. NO This function is not a cast function. YES This function is a cast function. Contains the null value if the routine is a procedure.
CARDINALITY	CARD	BIGINT Nullable	Specifies the cardinality for a table function. Contains the null value if the function is not a table function or if cardinality was not specified.
FENCED	FENCED	VARCHAR(3) Nullable	Identifies whether a function is fenced. NO The function is not fenced. YES The function is fenced. Contains the null value if the routine is a procedure.
COMMIT_ON_RETURN	CMTONRET	VARCHAR(3) Nullable	This column identifies whether the procedure commits on a successful return from the procedure. NO A commit is not performed on successful return from the procedure. YES A commit is performed on successful return from the procedure. AUT Procedure will commit or rollback autonomously. Contains the null value if the routine is a function.
IASP_NUMBER	IASPNUMBER	SMALLINT	Specifies the independent auxiliary storage pool (IASP) number.
NEW_SAVEPOINT_LEVEL	NEWSAVEPTL	VARCHAR(3) Nullable	This column identifies whether the routine starts a new savepoint level. NO A new savepoint level is not started. YES A new savepoint level is started.
LAST_ALTERED	ALTEREDTS	TIMESTAMP Nullable	Timestamp when routine was last altered. Contains null if the routine has never been altered.

Table 199. SYSROUTINES table (continued)

Column Name	System Column Name	Data Type	Description
DEBUG_MODE	DEBUG_MODE	CHAR(1)	Identifies whether the routine is debuggable. 0 The routine is not debuggable. 1 The routine is debuggable by the Unified Debugger. 2 The routine is debuggable by the system debugger. N The routine is disabled from being debugged by the Unified Debugger.
DEBUG_DATA	DEBUG_DATA	CLOB(1M) Nullable	Reserved. Contains the null value.
ROUNDING_MODE	DECFLTRND	CHAR(1) Nullable	If this is an SQL routine, identifies the DECFLOAT rounding mode. C ROUND_CEILING D ROUND_DOWN F ROUND_FLOOR G ROUND_HALF_DOWN E ROUND_HALF_EVEN H ROUND_HALF_UP U ROUND_UP Contains the null value if the routine is not an SQL routine.
ROUTINE_TEXT	LABEL	VARGRAPHIC(50) CCSID 1200 Nullable	Contains the label for a routine. Contains the null value if a label does not exist.
SECURE	SECURE	CHAR(1)	Indicates whether the routine is considered secure for row access control and column access control. N The routine is not considered secure for row access control and column access control. Y The routine is considered secure for row access control and column access control.
ROUTINE_ENVIRONMENT	RTN_ENV	BLOB(16M) Nullable	Contains internal environment information for a routine defined with default expressions. Contains the null value if this is a procedure or function with no default expressions.
ROUTINE_DEFAULT_QDT	RTNDFTQDT	BLOB(1M) Nullable	Contains internal structure for a routine defined with default expressions. Contains the null value if this is a procedure or function with no default expressions.
ROUTINE_BIND_OPTION	BINDOPT	DBCLOB(5000) CCSID 1200 Nullable	The additional bind options used when creating this routine. Contains the null value if no explicit bind options were specified.

SYSSCHEMAAUTH

The SYSSCHEMAAUTH view contains one row for every privilege granted on a schema. Note that this catalog view cannot be used to determine whether a user is authorized to a schema because the privilege to use a schema could be acquired through a group user profile or special authority (such as *ALLOBJ).

The following table describes the columns in the SYSSCHEMAAUTH view:

Table 200. SYSSCHEMAAUTH view

Column Name	System Column Name	Data Type	Description
GRANTOR	GRANTOR	VARCHAR(128) Nullable	Reserved. Contains the null value.
GRANTEE	GRANTEE	VARCHAR(128)	The user profile to which the privilege is granted.
SCHEMA_NAME	NAME	VARCHAR(128)	Name of the schema
PRIVILEGE_TYPE	PRIVTYPE	VARCHAR(10)	The privilege granted: CREATEIN The privilege to create objects in the schema. USAGE The privilege to use the schema.
IS_GRANTABLE	GRANTABLE	VARCHAR(3)	Indicates whether the privilege is grantable to other users. NO The privilege is not grantable. YES The privilege is grantable.
AUTHORIZATION_LIST	AUTL	VARCHAR(10) Nullable	If the privilege is granted through an authorization, contains the name of the authorization list. Contains the null value if the privilege is not granted through an authorization list.
SYSTEM_SCHEMA_NAME	SYS_NAME	CHAR(10)	System name of the schema

SYSSCHEMAS

The SYSSCHEMAS view contains one row for every schema in the relational database.

For information related to a single schema, a query that uses table function OBJECT_STATISTICS will perform much better than querying SYSSCHEMAS. For example:

```
SELECT *  
FROM TABLE (QSYS2.OBJECT_STATISTICS('MJATST', 'LIB')) AS A
```

The following table describes the columns in the SYSSCHEMAS view:

Table 201. SYSSCHEMAS view

Column Name	System Column Name	Data Type	Description
SCHEMA_NAME	NAME	VARCHAR(128)	Name of the SQL schema.
SCHEMA_OWNER	OWNER	VARCHAR(128)	Owner of the schema.
SCHEMA_CREATOR	CREATOR	VARCHAR(128)	Name of the user that created the schema.
CREATION_TIMESTAMP	TIMESTAMP	TIMESTAMP	Timestamp when the schema was created.
SCHEMA_SIZE	SIZE	DECIMAL(15,0)	Size of the schema (in bytes).
SCHEMA_TEXT	LABEL	VARGRAPHIC(50) CCSID 1200 Nullable	A character string supplied with the LABEL statement. Contains the null value if the schema has no text.
SYSTEM_SCHEMA_NAME	SYS_NAME	CHAR(10)	System schema name.
IASP_NUMBER	IASPNUMBER	SMALLINT	Specifies the independent auxiliary storage pool (IASP) number.

SYSSEQUENCEAUTH

The SYSSEQUENCEAUTH view contains one row for every privilege granted on a sequence. Note that this catalog view cannot be used to determine whether a user is authorized to a sequence because the privilege to use a sequence could be acquired through a group user profile or special authority (such as *ALLOBJ).

The following table describes the columns in the SYSSEQUENCEAUTH view:

Table 202. SYSSEQUENCEAUTH view

Column Name	System Column Name	Data Type	Description
GRANTOR	GRANTOR	VARCHAR(128) Nullable	Reserved. Contains the null value.
GRANTEE	GRANTEE	VARCHAR(128)	The user profile to which the privilege is granted.
SEQUENCE_SCHEMA	SEQSCHEMA	VARCHAR(128)	Name of the schema
SEQUENCE_NAME	SEQNAME	VARCHAR(128)	Name of the sequence
PRIVILEGE_TYPE	PRIVTYPE	VARCHAR(10)	The privilege granted: ALTER The privilege to alter the sequence. USAGE The privilege to use the sequence.
IS_GRANTABLE	GRANTABLE	VARCHAR(3)	Indicates whether the privilege is grantable to other users. NO The privilege is not grantable. YES The privilege is grantable.
AUTHORIZATION_LIST	AUTL	VARCHAR(10) Nullable	If the privilege is granted through an authorization, contains the name of the authorization list. Contains the null value if the privilege is not granted through an authorization list.
SYSTEM_SEQ_SCHEMA	SYSSSCHEMA	CHAR(10)	System name of the schema
SYSTEM_SEQ_NAME	SYSSNAME	CHAR(10)	System name of the sequence

SYSSEQUENCES

The SYSSEQUENCES view contains one row for every sequence object in the SQL schema.

The following table describes the columns in the SYSSEQUENCES view:

Table 203. SYSSEQUENCES view

Column name	System Column Name	Data Type	Description
SEQUENCE_SCHEMA	SEQSCHEMA	VARCHAR(128)	The name of the SQL schema containing the sequence.
SEQUENCE_NAME	SEQNAME	VARCHAR(128)	Name of the sequence.
MAXIMUM_VALUE	MAXVALUE	DECIMAL(63,0)	Maximum value of the sequence.
MINIMUM_VALUE	MINVALUE	DECIMAL(63,0)	Minimum value of the sequence.
INCREMENT	INCREMENT	INTEGER	Increment value of the sequence.
CYCLE_OPTION	CYCLE	VARCHAR(3)	Identifies whether the sequence values will continue to be generated after the minimum or maximum value has been reached. NO Values will not continue to be generated. YES Values will continue to be generated.
CACHE	CACHE	INTEGER	Specifies the number of sequence values that may be preallocated for faster access. Zero indicates that the values will not be preallocated.
ORDER	ORDER	VARCHAR(3)	Specifies whether the sequence values must be generated in order of the request. NO Values do not need to be generated in order of the request. YES Values must be generated in order of the request.
DATA_TYPE	DATA_TYPE	VARCHAR(128)	Type of sequence: BIGINT Big number INTEGER Large number SMALLINT Small number DECIMAL Packed decimal NUMERIC Zoned decimal DISTINCT Distinct type
NUMERIC_PRECISION	PRECISION	INTEGER	The precision of all numeric columns.
USER_DEFINED_TYPE_SCHEMA	TYPESHEMA	VARCHAR(128) Nullable	The name of the schema if this is a distinct type. Contains the null value if the sequence is not a distinct type.
USER_DEFINED_TYPE_NAME	TYPENAME	VARCHAR(128) Nullable	The name of the distinct type. Contains the null value if the sequence is not a distinct type.
START	START	DECIMAL(63,0)	Starting value of the sequence.
MAXASSIGNEDVAL	MAXASVAL	DECIMAL(63,0) Nullable	Last possible assigned sequence value. This value includes any values that were cached, but not used. Contains the null value when the sequence is created. Is not null after the first value is assigned.

Table 203. SYSSEQUENCES view (continued)

Column name	System Column Name	Data Type	Description
SEQUENCE_DEFINER	DEFINER	VARCHAR(128)	The authorization ID under which the sequence was created.
SEQUENCE_CREATED	CREATEDTS	TIMESTAMP	Timestamp when the sequence was created.
LAST_ALTERED_TIMESTAMP	ALTEREDTS	TIMESTAMP	Timestamp when the sequence was last altered.
SEQUENCE_TEXT	LABEL	VARGRAPHIC(50) CCSID 1200 Nullable	A character string supplied with the LABEL statement (sequence text). Contains the null value if the sequence has no sequence text.
LONG_COMMENT	REMARKS	VARGRAPHIC(2000) CCSID 1200 Nullable	A character string supplied with the COMMENT statement. Contains the null value if there is no long comment.
SYSTEM_SEQ_SCHEMA	SYSSSCHEMA	CHAR(10)	The system name of the schema
SYSTEM_SEQ_NAME	SYSSNAME	CHAR(10)	The system name of the sequence
IASP_NUMBER	IASPNUMBER	SMALLINT	Specifies the independent auxiliary storage pool (IASP) number.

SYSTABAUTH

The SYSTABAUTH view contains one row for every privilege granted on a table or view. Note that this catalog view cannot be used to determine whether a user is authorized to a table or view because the privilege to use a table or view could be acquired through a group user profile or special authority (such as *ALLOBJ).

The following table describes the columns in the SYSTABAUTH view:

Table 204. SYSTABAUTH view

Column Name	System Column Name	Data Type	Description
GRANTOR	GRANTOR	VARCHAR(128) Nullable	Reserved. Contains the null value.
GRANTEE	GRANTEE	VARCHAR(128)	The user profile to which the privilege is granted.
TABLE_SCHEMA	DBNAME	VARCHAR(128)	Name of the schema
TABLE_NAME	NAME	VARCHAR(128)	Name of the table
PRIVILEGE_TYPE	PRIVTYPE	VARCHAR(10)	The privilege granted: ALTER The privilege to alter the table. DELETE The privilege to delete rows from the table. INDEX The privilege to create an index on the table. INSERT The privilege to insert rows into the table. REFERENCES The privilege to reference the table in a referential constraint. SELECT The privilege to select rows from the table. UPDATE The privilege to update the table.
IS_GRANTABLE	GRANTABLE	VARCHAR(3)	Indicates whether the privilege is grantable to other users. NO The privilege is not grantable. YES The privilege is grantable.
AUTHORIZATION_LIST	AUTL	VARCHAR(10) Nullable	If the privilege is granted through an authorization, contains the name of the authorization list. Contains the null value if the privilege is not granted through an authorization list.
SYSTEM_TABLE_SCHEMA	SYS_DNAME	CHAR(10)	System name of the schema
SYSTEM_TABLE_NAME	SYS_TNAME	CHAR(10)	System name of the table or view

SYSTABLEDEP

The SYSTABLEDEP view records the dependencies of materialized query tables.

The following table describes the columns in the SYSTABLEDEP view:

Table 205. SYSTABLEDEP view

Column name	System Column Name	Data Type	Description
TABLE_SCHEMA	TABSCHEMA	VARCHAR(128)	Name of the SQL schema that contains the table, view or alias
TABLE_NAME	TABNAME	VARCHAR(128)	Name of the table, view or alias. This is the SQL table, view or alias name if it exists; otherwise, it is the system table, view or alias name.
OBJECT_SCHEMA	BSHEMA	VARCHAR(128)	Name of the SQL schema that contains the object.
OBJECT_NAME	BNAME	VARCHAR(128)	Name of the object the materialized query table is dependent on.
OBJECT_TYPE	BTYPE	CHAR(24)	Indicates the object type of the object referenced in the materialized query table: FUNCTION The object is a function. TABLE The object is a table. TYPE The object is a distinct type. VIEW The object is a view.
IASP_NUMBER	IASPNUMBER	SMALLINT	Specifies the independent auxiliary storage pool (IASP) number of the object.
SYSTEM_TABLE_SCHEMA	SYS_DNAME	CHAR(10)	System schema name
SYSTEM_TABLE_NAME	SYS_TNAME	CHAR(10)	System table name.
PARAM_SIGNATURE	SIGNATURE	BLOB(3M) Nullable	This column identifies the routine signature. Contains the null value if the object is not a routine.

SYSTABLEINDEXSTAT

The SYSTABLEINDEXSTAT view contains one row for every index that has at least one partition or member built over a table. If the index is over more than one partition or member, the statistics include all those partitions and members. If the table is a distributed table, the partitions that reside on other database nodes are not included. They are contained in the catalog views of the other database nodes.

The following table describes the columns in the SYSTABLEINDEXSTAT view:

Table 206. SYSTABLEINDEXSTAT view

Column name	System Column Name	Data Type	Description
TABLE_SCHEMA	TABSCHEMA	VARCHAR(128)	Name of the SQL schema that contains the table.
TABLE_NAME	TABNAME	VARCHAR(128)	Name of the table.
PARTITION_TYPE	PARTTYPE	CHAR(1)	The type of the table partitioning: blank The table is not partitioned. H This is data hash partitioning. R This is data range partitioning. D This is distributed database hash partitioning.
NUMBER_PARTITIONS	NBRPARTS	INTEGER	Number of partitions or members of the table.
NUMBER_DISTRIBUTED_PARTITIONS	DSTPARTS	INTEGER Nullable	If the table is a distributed table, contains the total number of partitions. If the table is not a distributed table, contains null.
INDEX_SCHEMA	INDSCHEMA	VARCHAR(128)	Name of the SQL schema that contains the index, logical file, or constraint.
INDEX_NAME	INDNAME	VARCHAR(128)	Name of the index, logical file, or constraint.
INDEX_TYPE	INDTYPE	VARCHAR(11)	The type of the index: INDEX The index is an SQL index. LOGICAL The index is part of a logical file. PRIMARY KEY The index is a primary key constraint. UNIQUE The index is a unique constraint. REFERENTIAL The index is a foreign key constraint.
NUMBER_KEY_COLUMNS	INDKEYS	BIGINT	Number of columns that define the index key.
COLUMN_NAMES	COLNAMES	VARCHAR(1024)	A comma separated list of column names that define the index key. If the length of all the column names exceeds 1024, '...' is returned at the end of the column value.
NUMBER_LEAF_PAGES	NLEAF	BIGINT	Not applicable for Db2 for i. Will always be -1.
NUMBER_LEVELS	NLEVELS	SMALLINT	Not applicable for Db2 for i. Will always be -1.
FIRSTKEYCARD	KEYCARD1	BIGINT	The total number of distinct first key values for all index partitions. If the index is an encoded vector index, this is the total number of unique values for the entire index key.
FIRST2KEYCARD	KEYCARD2	BIGINT	The total number of distinct keys using the first two columns for all index partitions. If the index is an encoded vector index, -1 is returned.
FIRST3KEYCARD	KEYCARD3	BIGINT	The total number of distinct keys using the first three columns for all index partitions. If the index is an encoded vector index, -1 is returned.

Table 206. SYSTABLEINDEXSTAT view (continued)

Column name	System Column Name	Data Type	Description
FIRST4KEYCARD	KEYCARD4	BIGINT	The total number of distinct keys using the first four columns for all index partitions. If the index is an encoded vector index, -1 is returned.
FULLKEYCARD	KEYCARDF	BIGINT	The total number of distinct full key values for all index partitions. If the index has more than 4 key columns or is an encoded vector index, -1 is returned.
CLUSTERRATIO	CLSRATIO	SMALLINT	Not applicable for Db2 for i. Will always be -1.
CLUSTERFACTOR	CLSFACTOR	DOUBLE	Not applicable for Db2 for i. Will always be -1.
SEQUENTIAL_PAGES	SEQPAGES	BIGINT	Not applicable for Db2 for i. Will always be -1.
DENSITY	DENSITY	INTEGER	Not applicable for Db2 for i. Will always be -1.
PAGE_FETCH_PAIRS	FETCHPAIRS	VARCHAR(520)	Not applicable for Db2 for i. Will always be -1.
NUMBER_KEYS	NUMRIDS	BIGINT	The total number of keys for all index partitions. If the index is invalid or is an encoded vector index, -1 is returned.
NUMRIDS_DELETED	NUMRIDSDEL	BIGINT	Not applicable for Db2 for i. Will always be 0.
NUM_EMPTY_LEAFS	EMPTYLEAFS	BIGINT	Not applicable for Db2 for i. Will always be 0.
AVERAGE_RANDOM_FETCH_PAGES	AVGRNDFETCH	DOUBLE	Not applicable for Db2 for i. Will always be -1.
AVERAGE_RANDOM_PAGES	AVGRNDPAGE	DOUBLE	Not applicable for Db2 for i. Will always be -1.
AVERAGE_SEQUENCE_GAP	AVGSEQGAP	DOUBLE	Not applicable for Db2 for i. Will always be -1.
AVERAGE_SEQUENCE_FETCH_GAP	AVGSEQFGAP	DOUBLE	Not applicable for Db2 for i. Will always be -1.
AVERAGE_SEQUENCE_PAGES	AVGSEQPAGE	DOUBLE	Not applicable for Db2 for i. Will always be -1.
AVERAGE_SEQUENCE_FETCH_PAGES	AVGSEQFPAGE	DOUBLE	Not applicable for Db2 for i. Will always be -1.
AVGPARTITION_CLUSTERRATIO	PCLSRATIO	SMALLINT	Not applicable for Db2 for i. Will always be -1.
AVGPARTITION_CLUSTERFACTOR	PCLSFACTOR	DOUBLE	Not applicable for Db2 for i. Will always be -1.
AVGPARTITION_PAGE_FETCH_PAIRS	PFETCHPAIR	VARCHAR(520)	Not applicable for Db2 for i. Will always be an empty string.
DATAPARTITION_CLUSTERFACTOR	DCLSFACTOR	DOUBLE	A statistic measuring the "clustering" of the index keys with regard to data partitions. It is a number between 0 and 1, with 1 representing perfect clustering and 0 representing no clustering.
INDCARD	INDCARD	BIGINT	Number of keys in the index. If the index is invalid or is an encoded vector index, -1 is returned.
INDEX_VALID	VALID	CHAR(1)	An indication of whether any index is invalid and needs to be rebuilt: 0 At least one partition or member for the index is invalid. 1 All partitions or members for the index are valid. 2 The index was saved with STG(*FREE).
INDEX_HELD	HELD	CHAR(1)	An indication of whether a pending rebuild of the index is currently held by the user: 0 No rebuilds are pending or held for any partition or member of the index. 1 A pending rebuild for at least one partition or member for the index is held.
CREATE_TIMESTAMP	CREATED	TIMESTAMP	Maximum timestamp when any partition or member of the index was created.
LAST_BUILD_TIMESTAMP	LASTBUILD	TIMESTAMP	Maximum timestamp when any partition or member of the index was last rebuilt.

Table 206. SYSTABLEINDEXSTAT view (continued)

Column name	System Column Name	Data Type	Description
LAST_QUERY_USE	LASTQRYUSE	TIMESTAMP Nullable	Maximum timestamp of the last time any partition or member of the index was used in a query since the last time the usage statistics were reset. If no partition or member of the index has ever been used in a query since the last time the usage statistics were reset, contains null.
LAST_STATISTICS_USE	LASTSTUSE	TIMESTAMP Nullable	Maximum timestamp of the last time any partition or member of the index was used by the optimizer for statistics since the last time the usage statistics were reset. If no partition or member of the index has ever been used for statistics since the last time the usage statistics were reset, contains null.
QUERY_USE_COUNT	QRYUSECNT	BIGINT	Total number of times any partition or member of the index was used in a query since the last time the usage statistics were reset. If no partition or member of the index has ever been used in a query since the last time the usage statistics were reset, contains 0.
QUERY_STATISTICS_COUNT	QRYSTCNT	BIGINT	Total number of times any partition or member of the index was used by the optimizer for statistics since the last time the usage statistics were reset. If no partition or member of the index has ever been used for statistics since the last time the usage statistics were reset, contains 0.
LAST_USED_TIMESTAMP	LASTUSED	TIMESTAMP Nullable	Maximum timestamp of the last time any partition or member of the index was used directly by an application for native record I/O or SQL operations. If no partition or member of the index has ever been used, contains null.
DAYS_USED_COUNT	DAYSUSED	INTEGER	Maximum number of days any partition or member of the index was used directly by an application for native record I/O or SQL operations since the last time the usage statistics were reset. If no partition or member of the index has ever been used since the last time the usage statistics were reset, contains 0.
LAST_RESET_TIMESTAMP	LASTRESET	TIMESTAMP Nullable	Maximum timestamp of the last time the usage statistics were reset for the index. For more information see the Change Object Description (CHGOBJD) command. If the index's last used timestamp has never been reset, contains null.
INDEX_SIZE	SIZE	BIGINT	Total size (in bytes) of the binary trees or encoded vector indexes of all partitions or members of the index.
ESTIMATED_BUILD_TIME	ESTBLDTIME	INTEGER	Maximum estimated time (in seconds) required to rebuild any partition or member of the index.
LAST_BUILD_TIME	LSTBLDTIME	INTEGER Nullable	Elapsed time (in seconds) the last time the index was built. Contains null if the last build information is not available.
LAST_BUILD_KEYS	LSTBLDKEYS	BIGINT Nullable	Number of keys the last time the index was built. Contains null if the last build information is not available.
LAST_BUILD_DEGREE	LSTBLDDEG	SMALLINT Nullable	Parallel degree the last time the index was built. Contains null if the last build information is not available.
DELAYED_MAINT_KEYS	DLYKEYS	INTEGER Nullable	Maximum number of keys that need to be inserted into the binary tree of any partition or member of a delayed maintenance index. If the index is not a delayed maintenance index, contains null.

Table 206. SYSTABLEINDEXSTAT view (continued)

Column name	System Column Name	Data Type	Description
SPARSE	SPARSE	CHAR(1)	<p>Indicates whether the index contains keys for all the rows of its depended on table:</p> <p>0 The index contains keys for all the rows of its depended on table.</p> <p>1 The index is a select/omit logical file and does not contain keys for all the rows of its depended on table.</p>
DERIVED_KEY	DERIVED	CHAR(1)	<p>Indicates whether the any key columns in the index are expressions:</p> <p>0 No key columns of the index are expressions.</p> <p>1 At least one key column is an expression. Currently, this is only possible in a DDS-created logical file or temporary index.</p>
PARTITIONED	PARTITION	CHAR(1)	<p>Indicates whether the index is partitioned or not partitioned:</p> <p>0 An SQL index is not partitioned (spans multiple partitions).</p> <p>1 The index is not built over a partitioned table or built over a partitioned table and is partitioned (does not span multiple partitions or members).</p> <p>2 The index is a logical file built over multiple partitions or members.</p>
ACCPH_TYPE	ACCPHTYPE	CHAR(1)	<p>Indicates the type of index:</p> <p>0 The index is a maximum 1 terabyte (*MAX1TB) binary radix index.</p> <p>1 The index is a maximum 4 gigabyte (*MAX4GB) binary radix index.</p> <p>2 The index is an encoded vector index.</p>
UNIQUE	UNIQUE	CHAR(1)	<p>Indicates whether an index is unique:</p> <p>0 The index is a UNIQUE index.</p> <p>1 The index is a UNIQUE WHERE NOT NULL index.</p> <p>2 The index is a non-unique first-in-first-out (FIFO) index.</p> <p>3 The index is a non-unique last-in-last-out (LIFO) index.</p> <p>4 The index is a non-unique first-change-first-out (FCFO) index.</p>
SRTSEQ_TYPE	SRTSEQ	CHAR(1)	<p>Indicates whether the index uses a collating sequence:</p> <p>0 The index does not use a collating table.</p> <p>1 The index uses an alternate collating sequence (ALTSEQ).</p> <p>2 The index uses a sort sequence (SRTSEQ).</p>

Table 206. SYSTABLEINDEXSTAT view (continued)

Column name	System Column Name	Data Type	Description
LOGICAL_PAGE_SIZE	PAGE_SIZE	INTEGER Nullable	The logical page size of the index. If the index is an encoded vector index, contains null.
OVERFLOW_VALUES	OVERFLOW	INTEGER Nullable	Maximum number of distinct key values that have overflowed any partition or member of the encoded vector index. If the index is not an encoded vector index, contains null.
EVI_CODE_SIZE	CODE_SIZE	INTEGER Nullable	The size of the byte code of the encoded vector index. If the index is not an encoded vector index, contains null.
LOGICAL_READS	LGLREADS	BIGINT	Total number of logical read operations for any partition or member of the index since the last IPL.
PHYSICAL_READS	PHYREADS	BIGINT	Not applicable for Db2 for i. Will always be 0.
SEQUENTIAL_READS	SEQREADS	BIGINT	Number of sequential read operations for the index since the last IPL.
RANDOM_READS	RANREADS	BIGINT	Number of random read operations for the index since the last IPL.
SEARCH_CONDITION	IXWHERECON	VARGRAPHIC(1024) CCSID 1200	If an index is sparse, the search condition of the index. If the length of the search condition exceeds 1024, '..!' is returned at the end of the column value.
KEEP_IN_MEMORY	KEEPINMEM	CHAR(1)	Indicates whether the index should be kept in memory: 0 No memory preference. 1 The index should be kept in memory, if possible.
MEDIA_PREFERENCE	MEDIAPREF	SMALLINT	Indicates the media preference of the index: 0 No media preference. 255 The index should be allocated on Solid State Disk (SSD), if possible.
INCLUDE_EXPRESSION	IXINCEXP	VARGRAPHIC(1024) CCSID 1200 Nullable	Index INCLUDE expression. Contains null if the index does not have an INCLUDE expression.
SYSTEM_TABLE_SCHEMA	SYS_DNAME	CHAR(10)	System schema name.
SYSTEM_TABLE_NAME	SYS_TNAME	CHAR(10)	System table name.

SYSTABLES

The SYSTABLES view contains one row for every table, view or alias in the SQL schema, including the tables and views of the SQL catalog.

The following table describes the columns in the SYSTABLES view:

Table 207. SYSTABLES view

Column name	System Column Name	Data Type	Description
TABLE_NAME	NAME	VARCHAR(128)	Name of the table, view or alias. This is the SQL table, view or alias name if it exists; otherwise, it is the system table, view or alias name.
TABLE_OWNER	CREATOR	VARCHAR(128)	Owner of the table, view or alias
TABLE_TYPE	TYPE	CHAR(1)	If the row describes a table, view, or alias: A Alias L Logical file M Materialized query table P Physical file T Table V View
COLUMN_COUNT	COLCOUNT	INTEGER	Number of columns in the table or view. Zero for an alias.
ROW_LENGTH	RECLENGTH ¹⁶¹	INTEGER	Maximum length of any record in the table. Zero for an alias.
TABLE_TEXT	LABEL	VARGRAPHIC(50) CCSID 1200	A character string provided with the LABEL statement.
LONG_COMMENT	REMARKS	VARGRAPHIC(2000) CCSID 1200 Nullable	A character string supplied with the COMMENT statement. Contains the null value if there is no long comment.
TABLE_SCHEMA	DBNAME	VARCHAR(128)	Name of the SQL schema that contains the table, view or alias
LAST_ALTERED_TIMESTAMP	ALTEREDTS	TIMESTAMP	Timestamp when the table was last altered or created.
SYSTEM_TABLE_NAME	SYS_TNAME	CHAR(10)	System table name.
SYSTEM_TABLE_SCHEMA	SYS_DNAME	CHAR(10)	System schema name
FILE_TYPE	FILETYPE	CHAR(1)	File type D Data file or alias S Source file
BASE_TABLE_CATALOG	LOCATION	VARCHAR(18) Nullable	For an alias, this is the name of the relational database that contains the table or view the alias is based on. Contains the null value if the table is not an alias.
BASE_TABLE_SCHEMA	TBDBNAME	VARCHAR(128) Nullable	For an alias, this is the name of the SQL schema that contains the table or view the alias is based on. Contains the null value if the table is not an alias.
BASE_TABLE_NAME	TBNAME	VARCHAR(128) Nullable	For an alias, this is the name of the table or view the alias is based on. Contains the null value if the table is not an alias.

Table 207. SYSTABLES view (continued)

Column name	System Column Name	Data Type	Description
BASE_TABLE_MEMBER	TBMEMBER	VARCHAR(10) Nullable	For an alias, this is the name of the file member the alias is based on. Contains *FIRST if this is an alias, but a member name was not specified. Contains the null value if the table is not an alias.
SYSTEM_TABLE	SYSTABLE	CHAR(1)	System table N The table is not a system table. Y The table is a system table.
SELECT_OMIT	SELECTOMIT	CHAR(1)	Select/omit logical file D The table is a dynamic select/omit logical file. N The table is not a select/omit logical file. Y The table is a select/omit logical file.
IS_INSERTABLE_INT	INSERTABLE	VARCHAR(3)	Identifies whether an INSERT is allowed on the table. NO An INSERT is not allowed on this table. YES An INSERT is allowed on this table.
IASP_NUMBER	IASPNUMBER	SMALLINT	Specifies the independent auxiliary storage pool (IASP) number.
ENABLED	ENABLED	VARCHAR(3) Nullable	Indicates whether the materialized query table is enabled for optimization: NO The materialized query table is not enabled for optimization. YES The materialized query table is enabled for optimization. Contains the null value if the table is not a materialized query table.
MAINTENANCE	MAINTAIN	VARCHAR(6) Nullable	Indicates whether the materialized query table is user or system maintained: USER The materialized query table is user maintained. Contains the null value if the table is not a materialized query table.
REFRESH	REFRESH	VARCHAR(9) Nullable	Indicates the materialized query table REFRESH option: DEFERRED The materialized query table is REFRESH DEFERRED. Contains the null value if the table is not a materialized query table.
REFRESH_TIME	REFRESHDTS	TIMESTAMP Nullable	Indicates the timestamp of the last materialized query table REFRESH: Contains the null value if the table is not a materialized query table or if the table has never been refreshed.
MQT_DEFINITION	MQTDEF	DBCLOB(2M) CCSID 13488 Nullable	Indicates the query expression of the materialized query table: Contains the null value if the table is not a materialized query table.

Table 207. SYSTABLES view (continued)

Column name	System Column Name	Data Type	Description
ISOLATION	ISOLATION	CHAR(2) Nullable	<p>Indicates the isolation level used for the <i>select-statement</i> when refreshing the materialized query table:</p> <p>RR Repeatable Read (*RR)</p> <p>RS Read Stability (*ALL)</p> <p>CS Cursor Stability (*CS)</p> <p>UR Uncommitted Read (*CHG)</p> <p>NC No Commit (*NONE)</p> <p>Contains the null value if the table is not a materialized query table.</p>
PARTITION_TABLE	PART_TABLE	VARCHAR(11)	<p>Indicates whether the table is a partitioned table:</p> <p>DISTRIBUTED The table is a distributed table.</p> <p>NO The table is not a partitioned table.</p> <p>YES The table is a partitioned table.</p>
TABLE_DEFINER	DEFINER	VARCHAR(128)	Name of the user that defined the table.
MQT_RESTORE_DEFERRED	MQTRSTDFR	CHAR(1)	<p>If the table is a materialized query table:</p> <p>Y The MQT is deferred as the result of a restore.</p> <p>N The MQT is not deferred.</p> <p>Contains the null value if the table is not a materialized query table.</p>
ROUNDING_MODE	DECFLTRND	CHAR(1)	<p>Indicates the DECFLOAT rounding mode of the materialized query table or view:</p> <p>C ROUND_CEILING</p> <p>D ROUND_DOWN</p> <p>F ROUND_FLOOR</p> <p>G ROUND_HALF_DOWN</p> <p>E ROUND_HALF_EVEN</p> <p>H ROUND_HALF_UP</p> <p>U ROUND_UP</p> <p>Contains the null value if the table is not a view or MQT, or if the materialized query table or view does not have an expression that references a DECFLOAT column, function, or constant.</p>

Table 207. SYSTABLES view (continued)

Column name	System Column Name	Data Type	Description
CONTROL	CONTROL	CHAR(1)	<p>Indicates whether the table is enforced by row or column access control:</p> <p>blank No access control enforcement.</p> <p>R The table is enforced by row access control.</p> <p>C The table is enforced by column access control.</p> <p>B The table is enforced by both row and column access control.</p>
TEMPORAL_TYPE	TEMPORALTY	CHAR(1)	<p>Indicates the type of temporal table:</p> <p>H History table for a system-period temporal table</p> <p>N Not a temporal table</p> <p>S System-period temporal table</p>

¹⁶¹ The length is the number of bytes passed in database buffers, not the internal storage length.

SYSTABLESTAT

The SYSTABLESTAT view contains one row for every table that has at least one partition or member. If the table has more than one partition or member, the statistics include all partitions and members. If the table is a distributed table, the partitions that reside on other database nodes are not included. They are contained in the catalog views of the other database nodes.

The following table describes the columns in the SYSTABLESTAT view:

Table 208. SYSTABLESTAT view

Column name	System Column Name	Data Type	Description
TABLE_SCHEMA	TABSHEMA	VARCHAR(128)	Name of the SQL schema that contains the table.
TABLE_NAME	TABNAME	VARCHAR(128)	Name of the table.
PARTITION_TYPE	PARTTYPE	CHAR(1)	The type of the table partitioning: blank The table is not partitioned. H This is data hash partitioning. R This is data range partitioning. D This is distributed database hash partitioning.
NUMBER_PARTITIONS	NBRPARTS	INTEGER	Number of partitions or members of the table.
NUMBER_DISTRIBUTED_PARTITIONS	DSTPARTS	INTEGER Nullable	If the table is a distributed table, contains the total number of partitions. If the table is not a distributed table, contains null.
NUMBER_ROWS	CARD	BIGINT	Number of valid rows in all partitions or members of the table.
NUMBER_ROW_PAGES	NPAGES	BIGINT	Number of 64K pages in all partitions or members of the table.
NUMBER_PAGES	FPAGES	BIGINT	Same as NUMBER_ROW_PAGES.
OVERFLOW	OVERFLOW	BIGINT	The estimated number of rows that have overflowed to variable length segments. If the table does not contain variable length or LOB columns, contains 0.
CLUSTERED	CLUSTERED	CHAR(1) Nullable	Not applicable for Db2 for i. Will always be null.
ACTIVE_BLOCKS	ACTBLOCKS	BIGINT	Not applicable for Db2 for i. Will always be -1.
AVGCOMPRESSEDROWSIZE	ACROWSIZE	BIGINT	Not applicable for Db2 for i. Will always be -1.
AVGROWCOMPRESSIONRATIO	ACROWRATIO	REAL	Not applicable for Db2 for i. Will always be -1.
AVGROWSIZE	AVGROWSIZE	BIGINT	Average length (in bytes) of a row in this table. If the table has variable length or LOB columns, contains -1.
PCTROWSCOMPRESSED	PCTCROWS	REAL	Not applicable for Db2 for i. Will always be -1.
PCTPAGESSAVED	PCTPGSAVED	SMALLINT	Not applicable for Db2 for i. Will always be -1.
NUMBER_DELETED_ROWS	DELETED	BIGINT	Number of deleted rows in all partitions or members of the table.
DATA_SIZE	SIZE	BIGINT	Total size (in bytes) of the data spaces in all partitions or members of the table.
VARIABLE_LENGTH_SIZE	VLSIZE	BIGINT	Size (in bytes) of the variable-length data space segments in all partitions or members of the table.
VARIABLE_LENGTH_SEGMENTS	VLSEGMENTS	BIGINT	The number of variable-length data space segments in all partitions or members of the table.
FIXED_LENGTH_EXTENTS	FLEXTENTS	BIGINT	Not applicable for Db2 for i. Will always be -1.
VARIABLE_LENGTH_EXTENTS	VLEXTENTS	BIGINT	Not applicable for Db2 for i. Will always be -1.

Table 208. SYSTABLESTAT view (continued)

Column name	System Column Name	Data Type	Description
COLUMN_STATS_SIZE	CSTATSSIZE	BIGINT	Size (in bytes) of the column statistics in all partitions or members of the table.
MAINTAINED_TEMPORARY_INDEX_SIZE	MTISIZE	BIGINT	Size (in bytes) of all maintained temporary indexes over any partitions or members of the table.
NUMBER_DISTINCT_INDEXES	DISTINCTIX	INTEGER	The number of distinct indexes built over any partitions or members of the table. This does not include maintained temporary indexes.
OPEN_OPERATIONS	OPENS	BIGINT	Number of full opens of all partitions or members of the table since the last IPL.
CLOSE_OPERATIONS	CLOSES	BIGINT	Number of full closes of all partitions or members of the table since the last IPL.
INSERT_OPERATIONS	INSERTS	BIGINT	Number of insert operations of all partitions or members of the table since the last IPL.
BLOCKED_INSERT_OPERATIONS	BLKIOPS	BIGINT	Number of blocked insert operations for the partition or member since the last IPL.
BLOCKED_INSERT_ROWS	BLKIROW	BIGINT	Number of rows inserted with blocked insert operations for the partition or member since the last IPL.
UPDATE_OPERATIONS	UPDATES	BIGINT	Number of update operations of all partitions or members of the table since the last IPL.
DELETE_OPERATIONS	DELETES	BIGINT	Number of delete operations of all partitions or members of the table since the last IPL.
CLEAR_OPERATIONS	DSCLEAR	BIGINT	Number of clear operations (CLRPFM operations) of all partitions or members of the table since the last IPL.
COPY_OPERATIONS	DSCOPIES	BIGINT	Number of data space copy operations (certain CPYxxx operations) of all partitions or members of the table since the last IPL.
REORGANIZE_OPERATIONS	DSREORGS	BIGINT	Number of data space reorganize operations (non-interruptible RGZPFM operations) of all partitions or members of the table since the last IPL.
INDEX_BUILDS	DSINXBlds	BIGINT	Number of creates or rebuilds of indexes that reference any partition or member of the table since the last IPL. This does not include maintained temporary indexes.
LOGICAL_READS	LGLREADS	BIGINT	Number of logical read operations of all partitions or members of the table since the last IPL.
PHYSICAL_READS	PHYREADS	BIGINT	Number of physical read operations of all partitions or members of the table since the last IPL.
SEQUENTIAL_READS	SEQREADS	BIGINT	Number of sequential read operations of all partitions or members of the table since the last IPL.
RANDOM_READS	RANREADS	BIGINT	Number of random read operations of all partitions or members of the table since the last IPL.
LAST_CHANGE_TIMESTAMP	LASTCHG	TIMESTAMP	Maximum timestamp of the last change that occurred to any partition or member of the table.
LAST_SAVE_TIMESTAMP	LASTSAVE	TIMESTAMP Nullable	Minimum timestamp of the last save of any partition or member of the table. If no partition or member has been saved, contains null.
LAST_RESTORE_TIMESTAMP	LASTRST	TIMESTAMP Nullable	Maximum timestamp of the last restore any partition or member of the table. If no partition or member has been restored, contains null.
LAST_USED_TIMESTAMP	LASTUSED	TIMESTAMP Nullable	Maximum timestamp of the last time any partition or member was used directly by an application for native record I/O or SQL operations. If no partition or member has ever been used, contains null.

Table 208. SYSTABLESTAT view (continued)

Column name	System Column Name	Data Type	Description
DAYS_USED_COUNT	DAYSUSED	INTEGER	Maximum number of days any partition or member was used directly by an application for native record I/O or SQL operations since the last time the usage statistics were reset. If no partition or member has been used since the last time the usage statistics were reset, contains 0.
LAST_RESET_TIMESTAMP	LASTRESET	TIMESTAMP Nullable	Maximum timestamp of the last time the usage statistics were reset for the table. For more information see the Change Object Description (CHGOBJD) command. If no partition or member's last used timestamp has ever been reset, contains null.
NUMBER_PARTITIONING_KEYS	NBRPKEYS	INTEGER Nullable	The number of partitioning keys. If the table is not partitioned, contains null.
PARTITIONING_KEYS	PARTKEYS	VARCHAR(2880) Nullable	The list of partitioning keys. If the table is not partitioned, contains null.
VOLATILE	VOLATILE	CHAR(1)	Indicates whether the table is volatile. 0 Table is not volatile. 1 Table is volatile.
SYSTEM_TABLE_SCHEMA	SYS_DNAME	CHAR(10)	System schema name.
SYSTEM_TABLE_NAME	SYS_TNAME	CHAR(10)	System table name.

SYSTRIGCOL

The SYSTRIGCOL view contains one row for each column either implicitly or explicitly referenced in the WHEN clause or the triggered SQL statements of a trigger.

The following table describes the columns in the SYSTRIGCOL view:

Table 209. SYSTRIGCOL view

Column Name	System Column Name	Data Type	Description
TRIGGER_SCHEMA	TRIGSCHEMA	VARCHAR(128)	Name of the schema containing the trigger.
TRIGGER_NAME	TRIGNAME	VARCHAR(128)	Name of the trigger.
TABLE_SCHEMA	TABSCHEMA	VARCHAR(128)	Name of the schema containing the table or view that contains the column that is referenced in the trigger.
TABLE_NAME	TABNAME	VARCHAR(128)	Name of the table or view that contains the column that is referenced in the trigger.
COLUMN_NAME	TABCOLUMN	VARCHAR(128)	Name of the column that is referenced in the trigger.
OBJECT_TYPE	BTYPE	CHAR(24)	Indicates the object type of the object that contains the column referenced in the trigger: FUNCTION The object is a function. MATERIALIZED QUERY TABLE The object is a materialized query table. TABLE The object is a table. VIEW The object is a view.
SYSTEM_TRIGGER_SCHEMA	SYS_TDNAME	CHAR(10)	System schema name.
SYSTEM_TABLE_SCHEMA	SYS_DNAME	CHAR(10) Nullable	System schema name of the table or view that contains the column that is referenced in the trigger. Contains the null value if the referenced table does not exist or if the referenced object is a table function.
SYSTEM_TABLE_NAME	SYS_TNAME	CHAR(10) Nullable	System table name of the table or view that contains the column that is referenced in the trigger. Contains the null value if the referenced table does not exist or if the referenced object is a table function.

SYSTRIGDEP

The SYSTRIGDEP view contains one row for each object referenced in the WHEN clause or the triggered SQL statements of a trigger.

The following table describes the columns in the SYSTRIGDEP view:

Table 210. SYSTRIGDEP view

Column Name	System Column Name	Data Type	Description
TRIGGER_SCHEMA	TRIGSCHEMA	VARCHAR(128)	Name of the schema containing the trigger.
TRIGGER_NAME	TRIGNAME	VARCHAR(128)	Name of the trigger.
OBJECT_SCHEMA	BSHEMA	VARCHAR(128)	Name of the schema containing the object referenced in the trigger.
OBJECT_NAME	BNAME	VARCHAR(128)	Name of the object referenced in the trigger.
OBJECT_TYPE	BTYPE	CHAR(24)	Indicates the object type of the object referenced in the trigger: ALIAS The object is an alias. FUNCTION The object is a function. INDEX The object is an index. MATERIALIZED QUERY TABLE The object is a materialized query table. PACKAGE The object is a package. PROCEDURE The object is a procedure. SCHEMA The object is a schema. SEQUENCE The object is a sequence. TABLE The object is a table. TYPE The object is a distinct type. VARIABLE The object is a variable. VIEW The object is a view.
PARAM_SIGNATURE	SIGNATURE	BLOB(3M) Nullable	This column identifies the routine signature. Contains the null value if the object is not a routine.
SYSTEM_TRIGGER_SCHEMA	SYS_TDNAME	CHAR(10)	System schema name.
SYSTEM_OBJECT_SCHEMA	SYS_DNAME	CHAR(10) Nullable	System schema name of the object referenced in the trigger. Contains the null value if the referenced object does not exist or if the referenced object is not an alias, index, materialized query table, table, or view.
SYSTEM_OBJECT_NAME	SYS_ONAME	CHAR(10) Nullable	System object name of the object referenced in the trigger. Contains the null value if the referenced object does not exist or if the referenced object is not an alias, index, materialized query table, table, or view.

SYSTRIGGERS

The SYSTRIGGERS view contains one row for each trigger in an SQL schema.

The following table describes the columns in the SYSTRIGGERS view:

Table 211. SYSTRIGGERS view

Column Name	System Column Name	Data Type	Description
TRIGGER_SCHEMA	TRIGSCHEMA	VARCHAR(128)	Name of the schema containing the trigger.
TRIGGER_NAME	TRIGNAME	VARCHAR(128)	Name of the trigger.
EVENT_MANIPULATION	TRIGEVENT	VARCHAR(6)	Indicates the event that causes the trigger to fire: DELETE Trigger fires on a DELETE. INSERT Trigger fires on a INSERT. UPDATE Trigger fires on a UPDATE. READ Trigger fires when a row is read. This is only valid for triggers created via the ADDPFTRG command. MULTI Trigger fires for multiple events. The EVENTUPDATE, EVENTDELETE, and EVENTINSERT columns define the events.
EVENT_OBJECT_SCHEMA	TABSCHEMA	VARCHAR(128)	Name of the schema containing the subject table or view of the trigger.
EVENT_OBJECT_TABLE	TABNAME	VARCHAR(128)	Name of the subject table or view of the trigger.
ACTION_ORDER	ORDERSEQNO	INTEGER	The ordinal position of this trigger in the list of triggers for the table or view. This indicates the order in which the trigger will be fired.
ACTION_CONDITION	CONDITION	DBCLOB(2097152) CCSID 13488 Nullable	Text of the WHEN clause for the trigger. Contains the null value if there is no WHEN clause or if this is an obfuscated trigger.
ACTION_STATEMENT	TEXT	DBCLOB(2097152) CCSID 13488 Nullable	Text of the SQL statements in the trigger action. If this is an obfuscated trigger, the text starts with the WRAPPED keyword and is followed by the encoded form of the statement text. Contains the null value if this is a trigger created via the ADDPFTRG command.
ACTION_ORIENTATION	GRANULAR	VARCHAR(9)	Indicates whether this is a ROW or STATEMENT trigger: ROW Trigger fires for each ROW. STATEMENT Trigger fires for each statement.
ACTION_TIMING	TRIGTIME	VARCHAR(7)	Indicates whether this is a BEFORE, AFTER, or INSTEAD OF trigger: BEFORE Trigger fires before the triggering event. AFTER Trigger fires after the triggering event. INSTEAD Trigger fires instead of the triggering event.
TRIGGER_MODE	TRIGMODE	VARCHAR(6)	Indicates the firing mode for the trigger: DB2SQL The trigger mode is DB2SQL. DB2ROW The trigger mode is DB2ROW.

Table 211. SYSTRIGGERS view (continued)

Column Name	System Column Name	Data Type	Description
ACTION_REFERENCE_OLD_ROW	OLD_ROW	VARCHAR(128) Nullable	Name of the OLD ROW correlation name. Contains the null value if an OLD ROW correlation name was not specified.
ACTION_REFERENCE_NEW_ROW	NEW_ROW	VARCHAR(128) Nullable	Name of the NEW ROW correlation name. Contains the null value if a NEW ROW correlation name was not specified.
ACTION_REFERENCE_OLD_TABLE	OLD_TABLE	VARCHAR(128) Nullable	Name of the OLD TABLE correlation name. Contains the null value if an OLD TABLE correlation name was not specified.
ACTION_REFERENCE_NEW_TABLE	NEW_TABLE	VARCHAR(128) Nullable	Name of the NEW TABLE correlation name. Contains the null value if a NEW TABLE correlation name was not specified.
SQL_PATH	SQL_PATH	VARCHAR(3483) Nullable	SQL path used when the trigger was created. Contains the null value if the trigger was created via the ADDPFTRG command.
CREATED	CREATE_DTS	TIMESTAMP	Timestamp when the trigger was created.
TRIGGER_PROGRAM_NAME	TRIGPGM	VARCHAR(128)	Name of the trigger program.
TRIGGER_PROGRAM_LIBRARY	TRIGPGMLIB	VARCHAR(128)	System name of the schema containing the trigger program.
OPERATIVE	OPERATIVE	VARCHAR(1)	Indicates whether the trigger is operative. A table or view that has a trigger that contains a reference to that same table or view in its <i>triggered-action</i> is self-referencing. If a self-referencing trigger is duplicated into another library, restored into another library, moved into another library, or renamed; the trigger is marked inoperative since the table references in the <i>triggered-action</i> are unchanged and still reference the original schema and table name. Y The trigger is operative. N The trigger is inoperative.
ENABLED	ENABLED	VARCHAR(1)	Indicates whether the trigger is enabled. Y The trigger is enabled. N The trigger is disabled.
THREADSAFE	THDSAFE	VARCHAR(8)	Indicates whether the trigger is thread safe. YES The trigger is thread safe. NO The trigger is not thread safe. UNKNOWN The thread safety of the trigger is unknown.
MULTITHREADED_JOB_ACTION	MLTTHDACN	VARCHAR(8)	Indicates the action to take when the trigger program is called in a multithreaded job. SYSVAL Use the QMLTTHDACN system value to determine the action to take. MSG Run the trigger program in a multithreaded job, but send a diagnostic message. NORUN Do not run the trigger program in a multithreaded job. RUN Run the trigger program in a multithreaded job.

Table 211. SYSTRIGGERS view (continued)

Column Name	System Column Name	Data Type	Description
ALLOW_REPEATED_CHANGE	ALWREPCHG	VARCHAR(8)	<p>Indicates the condition under which an update event fires the trigger.</p> <p>YES The trigger allows repeated changes to the same row.</p> <p>NO The trigger does not allow repeated changes to the same row.</p>
TRIGGER_UPDATE_CONDITION	TRGUPDCND	CHAR(8) Nullable	<p>Indicates whether an UPDATE trigger is always fired on an update event or only when a column value is actually changed.</p> <p>ALWAYS The trigger is always fired on an update event.</p> <p>CHANGE The trigger is only fired on an update event if a column value is actually changed.</p> <p>Contains the null value if the trigger is not an UPDATE trigger.</p>
TRIGGER_DEFINER	DEFINER	VARCHAR(128)	Name of the user that defined the trigger.
TRIGGER_TEXT	LABEL	VARGRAPHIC(50) CCSID 1200 Nullable	<p>A character string provided with the LABEL statement.</p> <p>Contains the null value if there is no label.</p>
LONG_COMMENT	REMARKS	VARGRAPHIC(2000) CCSID 13488 Nullable	<p>A character string supplied with the COMMENT statement.</p> <p>Contains the null value if there is no long comment.</p>
ROUNDING_MODE	DECFLTRND	CHAR(1) Nullable	<p>The rounding mode for the trigger:</p> <p>C ROUND_CEILING</p> <p>D ROUND_DOWN</p> <p>F ROUND_FLOOR</p> <p>G ROUND_HALF_DOWN</p> <p>E ROUND_HALF_EVEN</p> <p>H ROUND_HALF_UP</p> <p>U ROUND_UP</p> <p>Contains the null value if the trigger was created via the ADDPFTRG command.</p>
SYSTEM_TRIGGER_SCHEMA	SYS_TDNAME	CHAR(10)	System schema name.
SYSTEM_EVENT_OBJECT_SCHEMA	SYS_DNAME	CHAR(10)	System schema name of the schema containing the subject table or view of the trigger.
SYSTEM_EVENT_OBJECT_TABLE	SYS_TNAME	CHAR(10)	System table name of the table or view that contains the subject table or view of the trigger.
SECURE	SECURE	CHAR(1)	<p>Indicates whether the trigger is considered secure for row access control and column access control.</p> <p>N The trigger is not considered secure for row access control and column access control.</p> <p>Y The trigger is considered secure for row access control and column access control.</p>
LAST_ALTERED	ALTEREDTS	TIMESTAMP Nullable	Timestamp when the trigger was last altered. Contains the null value if the trigger has never been altered.

Table 211. SYSTRIGGERS view (continued)

Column Name	System Column Name	Data Type	Description
EVENTUPDATE	EVENT_U	CHAR(1)	Indicates whether an update event fires this trigger. Y Yes N No
EVENTINSERT	EVENT_I	CHAR(1)	Indicates whether an insert event fires this trigger. Y Yes N No
EVENTDELETE	EVENT_D	CHAR(1)	Indicates whether a delete event fires this trigger. Y Yes N No
MIRRORED	MIRRORED	CHAR(1)	Indicates whether the trigger will be fired on both nodes in a mirrored environment. Y Yes N No.
TRIGGER_BIND_OPTION	BINDOPT	DBCLOB(5000) CCSID 1200 Nullable	The additional bind options used when creating this trigger. Contains the null value if no explicit bind options were specified.

SYSTRIGUPD

The SYSTRIGUPD view contains one row for each column identified in the UPDATE column list, if any.

The following table describes the columns in the SYSTRIGUPD view:

Table 212. SYSTRIGUPD view

Column Name	System Column Name	Data Type	Description
TRIGGER_SCHEMA	TRIGSCHEMA	VARCHAR(128)	Name of the schema containing the trigger.
TRIGGER_NAME	TRIGNAME	VARCHAR(128)	Name of the trigger.
EVENT_OBJECT_SCHEMA	TABSCHEMA	VARCHAR(128)	Name of the schema containing the subject table of the trigger.
EVENT_OBJECT_TABLE	TABNAME	VARCHAR(128)	Name of the subject table of the trigger.
TRIGGERED_UPDATE_COLUMNS	TABCOLUMN	VARCHAR(128)	Name of a column specified in the UPDATE column list of the trigger.
SYSTEM_TRIGGER_SCHEMA	SYS_TDNAME	CHAR(10)	System schema name.
SYSTEM_EVENT_OBJECT_SCHEMA	SYS_DNAME	CHAR(10)	System schema name of the schema containing the subject table or view of the trigger.
SYSTEM_EVENT_OBJECT_TABLE	SYS_TNAME	CHAR(10)	System table name of the table or view that contains the subject table or view of the trigger.

SYSTYPES

The SYSTYPES table contains one row for each built-in data type and each distinct type and array type created by the CREATE TYPE statement.

The following table describes the columns in the SYSTYPES table:

Table 213. SYSTYPES table

Column Name	System Column Name	Data Type	Description
USER_DEFINED_TYPE_SCHEMA	TYPESHEMA	VARCHAR(128)	Schema name of the data type.
USER_DEFINED_TYPE_NAME	TYPENAME	VARCHAR(128)	Name of the data type.
USER_DEFINED_TYPE_DEFINER	DEFINER	VARCHAR(128)	Name of the user that created the data type.
SOURCE_SCHEMA	SRCSHEMA	VARCHAR(128) Nullable	The schema for the source data type of this data type. Contains the null value if this is a built-in data type.
SOURCE_TYPE	SRCTYPE	VARCHAR(128) Nullable	Name of the source data type of this data type. Contains the null value if this is a built-in data type.
SYSTEM_TYPE_SCHEMA	SYSTSHEMA	CHAR(10)	System schema name of the data type.
SYSTEM_TYPE_NAME	SYSTNAME	CHAR(10)	System name of the data type.
METATYPE	METATYPE	CHAR(1)	Indicates the type of data type. A Array data type. S System predefined data type. T User-defined distinct type.
TYPESRULES	TYPESRULES	CHAR(1)	Indicates the type rules for the user-defined type. S Strong typing. W Weak typing. blank Not applicable.

Table 213. SYSTYPES table (continued)

Column Name	System Column Name	Data Type	Description
LENGTH	LENGTH	INTEGER	<p>The length attribute of the data type; or, in the case of a decimal, numeric, or nonzero precision binary column, its precision. For an array data type, it is the length of a single array element:</p> <p>8 bytes BIGINT</p> <p>4 bytes INTEGER</p> <p>2 bytes SMALLINT</p> <p>Precision of number DECIMAL</p> <p>Precision of number NUMERIC</p> <p>8 bytes FLOAT, FLOAT(n) where n = 25 to 53, or DOUBLE PRECISION</p> <p>4 bytes FLOAT(n) where n = 1 to 24, or REAL</p> <p>8 bytes DECFLOAT(16)</p> <p>16 bytes DECFLOAT(34)</p> <p>Length of string CHARACTER</p> <p>Maximum length of string VARCHAR or CLOB</p> <p>Length of graphic string GRAPHIC</p> <p>Maximum length of graphic string VARGRAPHIC or DBCLOB</p> <p>Length of binary string BINARY</p> <p>Maximum length of binary string VARBINARY or BLOB</p> <p>4 bytes DATE</p> <p>3 bytes TIME</p> <p>The integral part of $((p+1)/2)+7$ where p is the precision of the timestamp TIMESTAMP</p> <p>Maximum length of datalink URL and comment DATALINK</p> <p>40 bytes ROWID</p> <p>2147483647 bytes XML</p> <p>Same value as the source type DISTINCT</p>
NUMERIC_SCALE	SCALE	SMALLINT Nullable	<p>Scale of numeric data.</p> <p>Contains the null value if the data type is not decimal, numeric, or binary.</p>
CCSID	CCSID	INTEGER Nullable	<p>The CCSID value for CHAR, VARCHAR, CLOB, DATE, TIME, TIMESTAMP, GRAPHIC, VARGRAPHIC, DBCLOB, XML, and DATALINK data types.</p> <p>Contains the null value if the data type is numeric.</p>

Table 213. SYSTYPES table (continued)

Column Name	System Column Name	Data Type	Description
STORAGE	STORAGE	INTEGER	<p>The storage requirements for the data type:</p> <p>8 bytes BIGINT</p> <p>4 bytes INTEGER</p> <p>2 bytes SMALLINT</p> <p>(Precision/2) + 1 DECIMAL</p> <p>Precision of number NUMERIC</p> <p>8 bytes FLOAT, FLOAT(n) where n = 25 to 53, or DOUBLE PRECISION</p> <p>4 bytes FLOAT(n) where n = 1 to 24, or REAL</p> <p>8 bytes DECFLOAT(16)</p> <p>16 bytes DECFLOAT(34)</p> <p>Length of string CHAR</p> <p>Maximum length of string + 2 VARCHAR</p> <p>Maximum length of string + 29 CLOB</p> <p>Length of string * 2 GRAPHIC</p> <p>Maximum length of string * 2 + 2 VARGRAPHIC</p> <p>Maximum length of string * 2 + 29 DECLOB</p> <p>Length of binary string BINARY</p> <p>Maximum length of binary string + 2 VARBINARY</p> <p>Maximum length of string + 29 BLOB</p> <p>4 bytes DATE</p> <p>3 bytes TIME</p> <p>The integral part of $((p+1)/2)+7$ where p is the precision of the timestamp TIMESTAMP</p> <p>Maximum length of datalink URL and comment + 24 DATALINK</p> <p>42 bytes ROWID</p> <p>2147483647 bytes + 29 XML</p> <p>Same value as the source type DISTINCT</p> <p>Note: This column supplies the storage requirements for all data types.</p>
NUMERIC_PRECISION	PRECISION	INTEGER Nullable	<p>The precision of all numeric data types.</p> <p>Note: This column supplies the precision of all numeric data types, including decimal floating-point and single- and double-precision floating point. The NUMERIC_PRECISION_RADIX column indicates if the value in this column is in binary or decimal digits.</p> <p>Contains the null value if the data type is not numeric.</p>

Table 213. SYSTYPES table (continued)

Column Name	System Column Name	Data Type	Description
CHARACTER_MAXIMUM_LENGTH	CHARLEN	INTEGER Nullable	Maximum length of the string for binary, character, and graphic string and XML data types. Contains the null value if the data type is not a string.
CHARACTER_OCTET_LENGTH	CHARBYTE	INTEGER Nullable	Number of bytes for binary, character, and graphic string and XML data types. Contains the null value if the data type is not a string.
ALLOCATE	ALLOCATE	INTEGER Nullable	Allocated length of the string for binary, varying-length character, varying-length graphic, and XML data types. Contains the null value if the data type is numeric or fixed-length, or an array data type.
NUMERIC_PRECISION_RADIX	RADIX	INTEGER Nullable	Indicates if the precision specified in column NUMERIC_PRECISION is specified as a number of binary or decimal digits: 2 Binary; floating-point precision is specified in binary digits. 10 Decimal; all other numeric types are specified in decimal digits. Contains the null value if the data type is not numeric.
DATETIME_PRECISION	DATPRC	INTEGER Nullable	The fractional part of a date, time, or timestamp. 0 For DATE and TIME data types 0-12 For TIMESTAMP data types (number of fractional seconds). Contains the null value if the data type is not date, time, or timestamp.
CREATE_TIME	CRTTIME	TIMESTAMP Nullable	Identifies the timestamp when the data type was created.
LONG_COMMENT	REMARKS	VARGRAPHIC(2000) CCSID 1200 Nullable	A character string supplied with the COMMENT statement. Contains the null value if there is no long comment.
IASP_NUMBER	IASPNUMBER	SMALLINT	Specifies the independent auxiliary storage pool (IASP) number of the data type.
LAST_ALTERED	ALTEREDTS	TIMESTAMP Nullable	Reserved. Contains the null value.
NORMALIZE_DATA	NORMALIZE	VARCHAR(3) Nullable	Indicates whether the parameter value should be normalized or not. This attribute only applies to UTF-8 and UTF-16 data. NO The value should not be normalized. YES The value should be normalized.
TYPE_TEXT	LABEL	VARGRAPHIC(50) CCSID 1200 Nullable	A character string supplied with the LABEL statement (type text). Contains the null value if the type has no text.
MAXIMUM_CARDINALITY	MAXCARD	BIGINT Nullable	The maximum cardinality of the array data type. Contains the null value if the type is not an array type.

SYSUDTAUTH

The SYSUDTAUTH view contains one row for every privilege granted on a type. Note that this catalog view cannot be used to determine whether a user is authorized to a type because the privilege to use a type could be acquired through a group user profile or special authority (such as *ALLOBJ).

The following table describes the columns in the SYSUDTAUTH view:

Table 214. SYSUDTAUTH view

Column Name	System Column Name	Data Type	Description
GRANTOR	GRANTOR	VARCHAR(128) Nullable	Reserved. Contains the null value.
GRANTEE	GRANTEE	VARCHAR(128)	The user profile to which the privilege is granted.
USER_DEFINED_TYPE_SCHEMA	UDT_SCHEMA	VARCHAR(128)	Name of the schema
USER_DEFINED_TYPE_NAME	UDT_NAME	VARCHAR(128)	Name of the type
PRIVILEGE_TYPE	PRIVTYPE	VARCHAR(10)	The privilege granted: ALTER The privilege to alter the type. USAGE The privilege to use the type.
IS_GRANTABLE	GRANTABLE	VARCHAR(3)	Indicates whether the privilege is grantable to other users. NO The privilege is not grantable. YES The privilege is grantable.
AUTHORIZATION_LIST	AUTL	VARCHAR(10) Nullable	If the privilege is granted through an authorization, contains the name of the authorization list. Contains the null value if the privilege is not granted through an authorization list.
SYSTEM_TYPE_SCHEMA	SYSTSCHEMA	CHAR(10)	System name of the schema
SYSTEM_TYPE_NAME	SYSTNAME	CHAR(10)	System name of the type

SYSVARIABLEAUTH

The SYSVARIABLEAUTH view contains one row for every privilege granted on a global variable. Note that this catalog view cannot be used to determine whether a user is authorized to a global variable because the privilege to use a global variable could be acquired through a group user profile or special authority (such as *ALLOBJ).

The following table describes the columns in the SYSVARIABLEAUTH view:

Table 215. SYSVARIABLEAUTH view

Column Name	System Column Name	Data Type	Description
GRANTOR	GRANTOR	VARCHAR(128) Nullable	Reserved. Contains the null value.
GRANTEE	GRANTEE	VARCHAR(128)	The user profile to which the privilege is granted.
VARIABLE_SCHEMA	VARSHEMA	VARCHAR(128)	Name of the schema
VARIABLE_NAME	VARNAME	VARCHAR(128)	Name of the global variable
PRIVILEGE_TYPE	PRIVTYPE	VARCHAR(10)	The privilege granted: ALTER The privilege to alter the global variable. READ The privilege to read the value of the global variable. WRITE The privilege to assign a value to the global variable.
IS_GRANTABLE	GRANTABLE	VARCHAR(3)	Indicates whether the privilege is grantable to other users. NO The privilege is not grantable. YES The privilege is grantable.
AUTHORIZATION_LIST	AUTL	VARCHAR(10) Nullable	If the privilege is granted through an authorization, contains the name of the authorization list. Contains the null value if the privilege is not granted through an authorization list.
SYSTEM_VAR_SCHEMA	SYSVSCHEMA	CHAR(10)	System name of the schema
SYSTEM_VAR_NAME	SYSVNAME	CHAR(10)	System name of the global variable

SYSVARIABLEDEP

The SYSVARIABLEDEP table records the dependencies of variables.

The following table describes the columns in the SYSVARIABLEDEP table:

Table 216. SYSVARIABLEDEP table

Column name	System Column Name	Data Type	Description
VARIABLE_SCHEMA	VARSCHEMA	VARCHAR(128)	Schema name of the variable.
VARIABLE_NAME	VARNAME	VARCHAR(128)	Name of the variable.
OBJECT_SCHEMA	BSCHEMA	VARCHAR(128)	Name of the SQL schema that contains the object.
OBJECT_NAME	BNAME	VARCHAR(128)	Name of the object the variable is dependent on.
OBJECT_TYPE	BTYPE	CHAR(24)	Indicates the object type of the object referenced in the variable: ALIAS The object is an alias. FUNCTION The object is a function. MATERIALIZED QUERY TABLE The object is a materialized query table. SCHEMA The object is a schema. SEQUENCE The object is a sequence. TABLE The object is a table. TYPE The object is a distinct type. VARIABLE The object is a variable. VIEW The object is a view.
IASP_NUMBER	IASPNUMBER	SMALLINT	Specifies the independent auxiliary storage pool (IASP) number of the object.
PARM_SIGNATURE	SIGNATURE	BLOB(3M) Nullable	This column identifies the routine signature. Contains the null value if the object is not a routine.

SYSVARIABLES

The SYSVARIABLES table contains one row for each global variable.

The following table describes the columns in the SYSVARIABLES table:

Table 217. SYSVARIABLES table

Column Name	System Column Name	Data Type	Description
VARIABLE_SCHEMA	VARSCHEMA	VARCHAR(128)	Schema name of the variable.
VARIABLE_NAME	VARNAME	VARCHAR(128)	Name of the variable.
SYSTEM_VAR_SCHEMA	SYSVSCHEMA	CHAR(10)	System schema name.
SYSTEM_VAR_NAME	SYSVNAME	CHAR(10)	System variable name.
VARIABLE_OWNER	OWNER	VARCHAR(128)	Authorization ID of the owner of the global variable.
VARIABLE_DEFINER	DEFINER	VARCHAR(128)	Name of the user that created the variable.
VARIABLE_CREATED	CREATDTS	TIMESTAMP	Identifies the timestamp when the variable was created.
SCOPE	SCOPE	CHAR(1)	Indicates the scope of the variable:. S Session
OWNER_TYPE	OWNER_TYPE	CHAR(1)	Indicates the owner of the variable: U The owner is an individual user S The variable is system owned.
USER_DEFINED_TYPE_SCHEMA	TYPESCHEMA	VARCHAR(128) Nullable	Schema of the data type if this is a distinct type. Contains the null value if the variable is not a distinct type.
USER_DEFINED_TYPE_NAME	TYPENAME	VARCHAR(128) Nullable	Name of the data type if this is a distinct type. Contains the null value if the variable is not a distinct type.

Table 217. SYSVARIABLES table (continued)

Column Name	System Column Name	Data Type	Description
DATA_TYPE	DATA_TYPE	VARCHAR(128)	Type of variable: BIGINT Big number INTEGER Large number SMALLINT Small number DECIMAL Packed decimal NUMERIC Zoned decimal FLOAT Floating point; FLOAT, REAL, or DOUBLE PRECISION DECFLOAT Decimal floating-point CHARACTER Fixed-length character string VARCHAR Varying-length character string CLOB Character large object string GRAPHIC Fixed-length graphic string VARGRAPHIC Varying-length graphic string DBCLOB Double-byte character large object string BINARY Fixed-length binary string VARBINARY Varying-length binary string BLOB Binary large object string DATE Date TIME Time TIMESTAMP Timestamp XML XML

Table 217. SYSVARIABLES table (continued)

Column Name	System Column Name	Data Type	Description
LENGTH	LENGTH	INTEGER	<p>The length attribute of the data type; or, in the case of a decimal, numeric, or nonzero precision binary variable, its precision:</p> <p>8 bytes BIGINT</p> <p>4 bytes INTEGER</p> <p>2 bytes SMALLINT</p> <p>Precision of number DECIMAL</p> <p>Precision of number NUMERIC</p> <p>8 bytes FLOAT, FLOAT(n) where n = 25 to 53, or DOUBLE PRECISION</p> <p>4 bytes FLOAT(n) where n = 1 to 24, or REAL</p> <p>8 bytes DECFLOAT(16)</p> <p>16 bytes DECFLOAT(34)</p> <p>Length of string CHARACTER</p> <p>Maximum length of string VARCHAR or CLOB</p> <p>Length of graphic string GRAPHIC</p> <p>Maximum length of graphic string VARGRAPHIC or DBCLOB</p> <p>Length of binary string BINARY</p> <p>Maximum length of binary string VARBINARY or BLOB</p> <p>4 bytes DATE</p> <p>3 bytes TIME</p> <p>The integral part of $((p+1)/2)+7$ where p is the precision of the timestamp TIMESTAMP</p> <p>2147483647 bytes XML</p> <p>Same value as the source type DISTINCT</p>
NUMERIC_SCALE	SCALE	INTEGER Nullable	<p>Scale of numeric data.</p> <p>Contains the null value if the data type is not decimal, numeric, or binary.</p>

Table 217. SYSVARIABLES table (continued)

Column Name	System Column Name	Data Type	Description
STORAGE	STORAGE	INTEGER	<p>The storage requirements for the variable:</p> <p>8 bytes BIGINT</p> <p>4 bytes INTEGER</p> <p>2 bytes SMALLINT</p> <p>(Precision/2) + 1 DECIMAL</p> <p>Precision of number NUMERIC</p> <p>8 bytes FLOAT, FLOAT(n) where n = 25 to 53, or DOUBLE PRECISION</p> <p>4 bytes FLOAT(n) where n = 1 to 24, or REAL</p> <p>8 bytes DECFLOAT(16)</p> <p>16 bytes DECFLOAT(34)</p> <p>Length of string CHAR</p> <p>Maximum length of string + 2 VARCHAR</p> <p>Maximum length of string + 29 CLOB</p> <p>Length of string * 2 GRAPHIC</p> <p>Maximum length of string * 2 + 2 VARGRAPHIC</p> <p>Maximum length of string * 2 + 29 DBCLOB</p> <p>Length of binary string BINARY</p> <p>Maximum length of binary string + 2 VARBINARY</p> <p>Maximum length of string + 29 BLOB</p> <p>4 bytes DATE</p> <p>3 bytes TIME</p> <p>The integral part of ((p+1)/2)+7 where p is the precision of the timestamp TIMESTAMP</p> <p>2147483647 +29 bytes XML</p> <p>Same value as the source type DISTINCT</p> <p>Note: This column supplies the storage requirements for all data types.</p>
NUMERIC_PRECISION	PRECISION	INTEGER Nullable	<p>The precision of all numeric data types.</p> <p>Note: This column supplies the precision of all numeric data types, including decimal floating-point and single-and double-precision floating point. The NUMERIC_PRECISION_RADIX column indicates if the value in this column is in binary or decimal digits.</p> <p>Contains the null value if the data type is not numeric.</p>
CCSID	CCSID	INTEGER Nullable	<p>The CCSID value for CHAR, VARCHAR, CLOB, DATE, TIME, TIMESTAMP, GRAPHIC, VARGRAPHIC, DBCLOB, XML, and DATALINK data types.</p> <p>Contains the null value if the data type is numeric.</p>

Table 217. SYSVARIABLES table (continued)

Column Name	System Column Name	Data Type	Description
CHARACTER_MAXIMUM_LENGTH	CHARLEN	INTEGER Nullable	Maximum length of the string for binary, character, and graphic string data types and the XML data type. Contains the null value if the data type is not a string or XML.
CHARACTER_OCTET_LENGTH	CHARBYTE	INTEGER Nullable	Number of bytes for binary, character, and graphic string data types and the XML data type. Contains the null value if the data type is not a string or XML.
NUMERIC_PRECISION_RADIX	RADIX	INTEGER Nullable	Indicates if the precision specified in column NUMERIC_PRECISION is specified as a number of binary or decimal digits: 2 Binary; floating-point precision is specified in binary digits. 10 Decimal; all other numeric types are specified in decimal digits. Contains the null value if the data type is not numeric.
DATETIME_PRECISION	DATPRC	INTEGER Nullable	The fractional part of a date, time, or timestamp. 0 For DATE and TIME data types 0-12 For TIMESTAMP data types (number of fractional seconds). Contains the null value if the data type is not date, time, or timestamp.
DEFAULT	DEFAULT	DBCLOB(2M) CCSID 1200	The expression used to calculate the initial value of the global variable when it is first referenced.
IASP_NUMBER	IASPNUMBER	SMALLINT	Specifies the independent auxiliary storage pool (IASP) number of the variable.
VARIABLE_TEXT	LABEL	VARGRAPHIC(50) CCSID 1200 Nullable	A character string supplied with the LABEL statement (type text). Contains the null value if the type has no text.
LONG_COMMENT	REMARKS	VARGRAPHIC(2000) CCSID 1200 Nullable	A character string supplied with the COMMENT statement. Contains the null value if there is no long comment.
DEFAULT_SCHEMA	QUALIFIER	VARCHAR(128) Nullable	Qualifier for unqualified tables and views.
SQL_PATH	SQL_PATH	VARCHAR(3483)	Identifies the path.
ROUNDING_MODE	DECFLTRND	CHAR(1) Nullable	Identifies the DECFLOAT rounding mode. C ROUND_CEILING D ROUND_DOWN F ROUND_FLOOR G ROUND_HALF_DOWN E ROUND_HALF_EVEN H ROUND_HALF_UP U ROUND_UP

Table 217. SYSVARIABLES table (continued)

Column Name	System Column Name	Data Type	Description
READONLY	READONLY	CHAR(1) Nullable	Indicates whether the variable may be modified or whether it is read-only. N Not read-only S Read-only because the global variable is maintained by the database manager.

SYSVIEWDEP

The SYSVIEWDEP view records the dependencies of views on tables, including the views of the SQL catalog.

The following table describes the columns in the SYSVIEWDEP view:

Table 218. SYSVIEWDEP view

Column name	System Column Name	Data Type	Description
VIEW_NAME	DNAME	VARCHAR(128)	Name of the view. This is the SQL view name if it exists; otherwise, it is the system view name.
VIEW_OWNER	DCREATOR	VARCHAR(128)	Owner of the view
OBJECT_NAME	ONAME	VARCHAR(128)	Name of the object the view is dependent on.
OBJECT_SCHEMA	OSHEMA	VARCHAR(128)	Name of the SQL schema that contains the object the view is dependent on.
OBJECT_TYPE	OTYPE	CHAR(24)	Type of object the view was based on: FUNCTION Function MATERIALIZED QUERY TABLE The object is a materialized query table. TABLE Table TYPE Distinct type VARIABLE The object is a variable. VIEW View
VIEW_SCHEMA	DDBNAME	VARCHAR(128)	Name of the schema of the view.
SYSTEM_VIEW_NAME	SYS_VNAME	CHAR(10)	System View name
SYSTEM_VIEW_SCHEMA	SYS_VDNAME	CHAR(10)	System View schema
SYSTEM_TABLE_NAME	SYS_TNAME	CHAR(10) Nullable	System Table name. Contains the null value if the object is a function or distinct type.
SYSTEM_TABLE_SCHEMA	SYS_DNAME	CHAR(10) Nullable	System Table schema. Contains the null value if the object is a function or distinct type.
TABLE_NAME	BNAME	VARCHAR(128) Nullable	Name of the table or view the view is dependent on. This is the SQL view name if it exists; otherwise, it is the system view name. Contains the null value if the object is a function or distinct type.
TABLE_OWNER	Bcreator	VARCHAR(128) Nullable	Owner of the table or view the view is dependent on. Contains the null value if the object is a function or distinct type.
TABLE_SCHEMA	BDBNAME	VARCHAR(128) Nullable	Name of the SQL schema that contains the table or view the view is dependent on. Contains the null value if the object is a function or distinct type.

Table 218. SYSVIEWDEP view (continued)

Column name	System Column Name	Data Type	Description
TABLE_TYPE	BTYPE	CHAR(1) Nullable	Type of object the view was based on: T Table P Physical file M Materialized query table V View L Logical file Contains the null value if the object is a function or distinct type.
IASP_NUMBER	IASPNUMBER	SMALLINT	Specifies the independent auxiliary storage pool (IASP) number.
PARAM_SIGNATURE	SIGNATURE	BLOB(3M) Nullable	This column identifies the routine signature. Contains the null value if the object is not a routine.

SYSVIEWS

The SYSVIEWS view contains one row for each view in the SQL schema, including the views of the SQL catalog.

The following table describes the columns in the SYSVIEWS view:

Table 219. SYSVIEWS view

Column Name	System Column Name	Data Type	Description
TABLE_NAME	NAME	VARCHAR(128)	Name of the view. This is the SQL view name if it exists; otherwise, it is the system view name.
VIEW_OWNER	CREATOR	VARCHAR(128)	Owner of the view
SEQNO	SEQNO	INTEGER	Sequence number of this row; will always be 1.
CHECK_OPTION	CHECK	CHAR(1)	The check option used on the view N No check option was specified Y The local option was specified C The cascaded option was specified
VIEW_DEFINITION	TEXT	VARGRAPHIC(5000) CCSID 1200 Nullable	The query expression portion of the CREATE VIEW statement. Contains the null value if the view definition cannot be contained in the column without truncation.
IS_UPDATABLE	UPDATES	CHAR(1)	Specifies if the view is updatable: Y The view is updatable N The view is not updatable
TABLE_SCHEMA	DBNAME	VARCHAR(128)	Name of the SQL schema that contains the view.
SYSTEM_VIEW_NAME	SYS_VNAME	CHAR(10)	System view name
SYSTEM_VIEW_SCHEMA	SYS_VDNAME	CHAR(10)	System view schema name
IS_INSERTABLE_INTO	INSERTABLE	VARCHAR(3)	Identifies whether an INSERT is allowed on the view. NO An INSERT is not allowed on this view. YES An INSERT is allowed on this view.
IASP_NUMBER	IASPNUMBER	SMALLINT	Specifies the independent auxiliary storage pool (IASP) number.
IS_DELETABLE	DELETES	CHAR(1) Nullable	Specifies if the view is deletable: Y The view is deletable N The view is read-only
VIEW_DEFINER	DEFINER	VARCHAR(128)	Name of the user that defined the view.

Table 219. SYSVIEWS view (continued)

Column Name	System Column Name	Data Type	Description
ROUNDING_MODE	DECFLTRND	CHAR(1) Nullable	<p>Indicates the DECFLOAT rounding mode of the view:</p> <p>C ROUND_CEILING</p> <p>D ROUND_DOWN</p> <p>F ROUND_FLOOR</p> <p>G ROUND_HALF_DOWN</p> <p>E ROUND_HALF_EVEN</p> <p>H ROUND_HALF_UP</p> <p>U ROUND_UP</p> <p>Contains the null value if the view does not have an expression that references a DECFLOAT column, function, or constant.</p>

SYSXSROBJECTAUTH

The SYSXSROBJECTAUTH view contains one row for every privilege granted on an XML schema. Note that this catalog view cannot be used to determine whether a user is authorized to a XML schema because the privilege to use a XML schema could be acquired through a group user profile or special authority (such as *ALLOBJ).

The following table describes the columns in the SYSXSROBJECTAUTH view:

Table 220. SYSXSROBJECTAUTH view

Column Name	System Column Name	Data Type	Description
GRANTOR	GRANTOR	VARCHAR(128) Nullable	Reserved. Contains the null value.
GRANTEE	GRANTEE	VARCHAR(128)	The user profile to which the privilege is granted.
XROBJECTSCHEMA	XRSHEMA	VARCHAR(128)	Name of the schema
XROBJECTNAME	XSRNAME	VARCHAR(128)	Name of the XML schema
PRIVILEGE_TYPE	PRIVTYPE	VARCHAR(10)	The privilege granted: ALTER The privilege to alter the XML schema. USAGE The privilege to use the XML schema.
IS_GRANTABLE	GRANTABLE	VARCHAR(3)	Indicates whether the privilege is grantable to other users. NO The privilege is not grantable. YES The privilege is grantable.
AUTHORIZATION_LIST	AUTL	VARCHAR(10) Nullable	If the privilege is granted through an authorization, contains the name of the authorization list. Contains the null value if the privilege is not granted through an authorization list.
SYSTEM_XSR_SCHEMA	SYSXSCHEMA	CHAR(10)	System name of the schema
SYSTEM_XSR_NAME	SYSXNAME	CHAR(10)	System name of the XML schema

XSRANNOTATIONINFO

The XSRANNOTATIONINFO table contains one row for each annotation in an XML schema to record the table and column information about the annotation.

The following table describes the columns in the XSRANNOTATIONINFO table:

Table 221. XSRANNOTATIONINFO table

Column name	System Column Name	Data Type	Description
XROBJECTID	OBJECTID	BIGINT	Internal identifier of the XML schema.
ANNOTATION_ID	ANNOID	INTEGER	Internal identifier of the XML schema annotation.
TABLE_SCHEMA	TABSCHEMA	VARCHAR(128)	Schema of the table to insert the data into.
TABLE_NAME	TABNAME	VARCHAR(128)	Table to insert the data into.
ROWSET	ROWSET	VARCHAR(1000)	Name of the rowset for this annotation.
COLUMN_NAME	COLNAME	VARCHAR(128)	Name of the column for this annotation.
DATA_TYPE	COLTYPE	INTEGER	Data type of the column for this annotation.
INSTANCE_TYPE	INSTTYPE	INTEGER	Type of data that will be provided by parser during decomposition: 2 decimal 4 long integer 5 integer 6 short integer 16 string 30 datetime 41 float 42 double
TRUNCATE	TRUNCATE	INTEGER	Indication of whether data can be truncated: 0 Data cannot be truncated 1 Data can be truncated
EXPRESSION	EXPRESSION	VARCHAR(1024) Nullable	Expression to be applied to data on insert by Db2.
CONDITION	CONDITION	VARCHAR(1024) Nullable	Condition to be applied before data is inserted by Db2.
CAST_EXPRESSION	CASTEXP	VARCHAR(20) Nullable	Cast expression to be applied when the column data is inserted by Db2 during decomposition.
IASP_NUMBER	IASPNUMBER	SMALLINT	Specifies the independent auxiliary storage pool (IASP) number.
ROWSET_ORDER	ORDER	INTEGER	RowSet order sequence. Default is 1.

XSROBJECTCOMPONENTS

The XSROBJECTCOMPONENTS table contains one row for each component (document) in an XML schema.

The following table describes the columns in the XSROBJECTCOMPONENTS table:

Table 222. XSROBJECTCOMPONENTS table

Column name	System Column Name	Data Type	Description
XSRCOMPONENTID	COMPID	BIGINT	Internal identifier of the XML schema document.
TARGETNAMESPACE	TGTNAMEPC	VARCHAR(1000) Nullable	String identifier for the target namespace.
SCHEMALOCATION	SCHEMALOC	VARCHAR(1000) Nullable	String identifier for the schema location.
COMPONENT	COMPONENT	BLOB(30M) Nullable	Contents of the XML schema document.
PROPERTIES	PROPERTIES	BLOB(5M) Nullable	Additional document property information for the XML schema document.
CREATED	CREATEDTS	TIMESTAMP	The time when the XSR_REGISTER stored procedure was executed for the XML schema.
STATUS	STATUS	CHAR(1)	Registration status of the XML schema: C Complete I Incomplete
IASP_NUMBER	IASPNUMBER	SMALLINT	Indicates the IASP where the catalog table is located.

XSROBJECTHIERARCHIES

The XSROBJECTHIERARCHIES table contains one row for each component (document) in an XML schema to record the XML schema document hierarchy relationship.

The following table describes the columns in the XSROBJECTHIERARCHIES table:

Table 223. XSROBJECTHIERARCHIES table

Column name	System Column Name	Data Type	Description
XSROBJECTID	OBJECTID	BIGINT	Internal identifier of the XML schema.
XSRCOMPONENTID	COMPID	BIGINT	Internal identifier of the XML schema document.
HTYPE	HTYPE	CHAR(1)	Hierarchy type: D Document P Primary document
TARGETNAMESPACE	TGTNAMEPC	VARCHAR(1000) Nullable	String identifier for the target namespace.
SCHEMALOCATION	SCHEMALOC	VARCHAR(1000) Nullable	String identifier for the schema location.
IASP_NUMBER	IASPNUMBER	SMALLINT	Specifies the independent auxiliary storage pool (IASP) number.

XSROBJECTS

The XSROBJECTS table contains one row for each registered XML schema.

The following table describes the columns in the XSROBJECTS table:

Table 224. XSROBJECTS table

Column name	System Column Name	Data Type	Description
XSROBJECTID	OBJECTID	BIGINT	Internal identifier of the XML schema.
XSROBJECTSCHEMA	XSRSCHEMA	VARCHAR(128)	Qualifier of the XML schema name.
XSROBJECTNAME	XSRNAME	VARCHAR(128)	Name of the XML schema
SYSTEM_XSR_SCHEMA	SYSXSCHEMA	CHAR(10)	System library name corresponding to the qualifier of the XML schema.
SYSTEM_XSR_NAME	SYSXNAME	CHAR(10)	System name of the XSROBJECT that correlates to the XML schema.
TARGETNAMESPACE	TGTNAMEPC	VARCHAR(1000) Nullable	String identifier for the target namespace.
SCHEMALOCATION	SCHEMALOC	VARCHAR(1000) Nullable	String identifier for the schema location.
XSR_OBJECT_TEXT	LABEL	VARGRAPHIC(50) CCSID 1200 Nullable	A character string supplied with the LABEL statement. Contains the null value if there is no label.
GRAMMAR	GRAMMAR	BLOB(250M) Nullable	The internal binary representation of the XML schema as the result of an XML_COMPLETE.
PROPERTIES	PROPERTIES	BLOB(5M) Nullable	Additional document property information for the XML schema document.
XSR_SCHEMA_DEFINER	DEFINER	VARCHAR(128)	Authorization ID under which the XML schema was created.
XSR_SCHEMA_OWNER	OWNER	VARCHAR(128)	Authorization ID that owns the XML schema.
XSR_SCHEMA_CREATED	CREATEDTS	TIMESTAMP	The time when the XML schema document was registered.
STATUS	STATUS	CHAR(1)	Registration status of the XML schema: C Complete I Incomplete
DECOMPOSITION	DECOMP	CHAR(1) Nullable	Indicates the decomposition status of the XSR object: Y Enabled N Not enabled
VERSION	VERSION	VARCHAR(128) Nullable	Indicates the version used during decomposition.
IASP_NUMBER	IASPNUMBER	SMALLINT	Indicates the IASP where the catalog table is located.
LONG_COMMENT	REMARKS	VARGRAPHIC(2000) CCSID 1200 Nullable	A character string supplied with the COMMENT statement. Contains the null value if there is no long comment.

ODBC and JDBC catalog views

The catalog includes the views and tables in the SYSIBM library displayed in this section.

View Name	Description
“SQLCOLPRIVILEGES” on page 1883	Information about privileges granted on columns
“SQLCOLUMNS” on page 1884	Information about column attributes
“SQLFOREIGNKEYS” on page 1894	Information about foreign keys
“SQLFUNCTIONCOLS” on page 1895	Information about function parameters
“SQLFUNCTIONS” on page 1904	Information about functions
“SQLPRIMARYKEYS” on page 1905	Information about primary keys
“SQLPROCEDURECOLS” on page 1906	Information about procedure parameters
“SQLPROCEDURES” on page 1915	Information about procedures
“SQLSCHEMAS” on page 1916	Information about schemas
“SQLSPECIALCOLUMNS” on page 1917	Information about columns of a table that can be used to uniquely identify a row
“SQLSTATISTICS” on page 1923	Statistical information about tables
“SQLTABLEPRIVILEGES” on page 1925	Information about privileges granted on tables
“SQLTABLES” on page 1926	Information about tables
“SQLTYPEINFO” on page 1927	Information about the types of tables
“SQLUDTS” on page 1935	Information about built-in data types and distinct types

SQLCOLPRIVILEGES

The SQLCOLPRIVILEGES view contains one row for every privilege granted on a column or a privilege granted on the column's table. Note that this catalog view cannot be used to determine whether a user is authorized to a column because the privilege to use a column could be acquired through a group user profile or special authority (such as *ALLOBJ).

The following table describes the columns in the view:

Table 225. SQLCOLPRIVILEGES view

Column Name	Data Type	Description
TABLE_CAT	VARCHAR(128)	Relational database name.
TABLE_SCHEM	VARCHAR(128)	Name of the SQL schema that contains the table.
TABLE_NAME	VARCHAR(128)	Table name.
COLUMN_NAME	VARCHAR(128)	Column name.
GRANTOR	VARCHAR(128) Nullable	Reserved. Contains the null value.
GRANTEE	VARCHAR(128)	The user profile to which the privilege is granted.
PRIVILEGE	VARCHAR(10)	The privilege granted: UPDATE The privilege to update the column. REFERENCES The privilege to reference the column in a referential constraint.
IS_GRANTABLE	VARCHAR(3)	Indicates whether the privilege is grantable to other users. NO The privilege is not grantable. YES The privilege is grantable.
DBNAME	VARCHAR(8) Nullable	Reserved. The column contains the null value.

SQLCOLUMNS

The SQLCOLUMNS view contains one row for every column in a table, view, or alias.

The following table describes the columns in the view:

Table 226. SQLCOLUMNS view

Column Name	Data Type	Description
TABLE_CAT	VARCHAR(128)	Relational database name.
TABLE_SCHEM	VARCHAR(128)	Name of the SQL schema that contains the table.
TABLE_NAME	VARCHAR(128)	Table name.
COLUMN_NAME	VARCHAR(128)	Column name.

Table 226. SQLCOLUMNS view (continued)

Column Name	Data Type	Description
DATA_TYPE	SMALLINT	The data type of the column:
		-5 BIGINT
		4 INTEGER
		5 SMALLINT
		3 DECIMAL
		2 NUMERIC
		8 DOUBLE PRECISION
		7 REAL
		-360 DECFLOAT
		1 CHARACTER
		-2 CHARACTER FOR BIT DATA or BINARY
		12 VARCHAR
		-3 VARCHAR FOR BIT DATA or VARBINARY
		-99 CLOB
		-95 GRAPHIC
		-96 VARGRAPHIC
		-350 DBCLOB
		-8 NCHAR
		-9 NVARCHAR
		-10 NCLOB
		-98 BLOB
		91 DATE
		92 TIME
		93 TIMESTAMP
		70 DATALINK
		-100 ROWID
		-370 XML
		17 DISTINCT

Table 226. SQLCOLUMNS view (continued)

Column Name	Data Type	Description
TYPE_NAME	VARCHAR(261)	The name of the data type of the column: BIGINT BIGINT INteger INTEGER SMALLINT SMALLINT DECIMAL DECIMAL NUMERIC NUMERIC FLOAT DOUBLE PRECISION REAL REAL DECFLOAT DECFLOAT CHARacter CHARACTER CHARacter FOR BIT DATA CHARACTER FOR BIT DATA VARCHAR VARCHAR VARCHAR FOR BIT DATA VARCHAR FOR BIT DATA CLOB CLOB GRAPHIC GRAPHIC VARGRAPHIC VARGRAPHIC DBCLOB DBCLOB NCHAR NCHAR NVARCHAR NVARCHAR NCLOB NCLOB BINARY BINARY VARBINARY VARBINARY BLOB BLOB DATE DATE TIME TIME TIMESTAMP TIMESTAMP DATALINK DATALINK ROWID ROWID XML XML Qualified Type Name DISTINCT
COLUMN_SIZE	INTEGER	The length of the column.
BUFFER_LENGTH	INTEGER	Indicates the length of the column in a buffer.

Table 226. SQLCOLUMNS view (continued)

Column Name	Data Type	Description	
DECIMAL_DIGITS	SMALLINT	Indicates the number of digits for a numeric column.	
	Nullable	Contains the null value if the object is not numeric or timestamp.	
NUM_PREC_RADIX	SMALLINT	Indicates the radix of a numeric column.	
	Nullable	Contains the null value if the object is not numeric.	
NULLABLE	SMALLINT	Indicates whether the column can contain the null value.	
		0	The column does not allow nulls.
		1	The column does allow nulls.
REMARKS	VARCHAR(2000)	A character string supplied with the COMMENT statement.	
	Nullable	Contains the null value if there is no long comment.	
COLUMN_DEF	VARCHAR(2000)	The default value of the column.	
	Nullable	Contains the null value if there is no default value.	

Table 226. SQLCOLUMNS view (continued)

Column Name	Data Type	Description
SQL_DATA_TYPE	SMALLINT	Indicates the SQL data type of the column.
		-5 BIGINT
		4 INTEGER
		5 SMALLINT
		3 DECIMAL
		2 NUMERIC
		8 DOUBLE PRECISION
		7 REAL
		-360 DECFLOAT
		1 CHARACTER
		-2 CHARACTER FOR BIT DATA or BINARY
		12 VARCHAR
		-3 VARCHAR FOR BIT DATA or VARBINARY
		-99 CLOB
		-95 GRAPHIC
		-96 VARGRAPHIC
		-350 DBCLOB
		-8 NCHAR
		-9 NVARCHAR
		-10 NCLOB
		-98 BLOB
		9 DATE
		9 TIME
		9 TIMESTAMP
		70 DATALINK
		-100 ROWID
		-370 XML
		17 DISTINCT

Table 226. SQLCOLUMNS view (continued)

Column Name	Data Type	Description
SQL_DATETIME_SUB	SMALLINT Nullable	The datetime subtype of the data type: 1 DATE 2 TIME 3 TIMESTAMP Contains the null value if the column is not a datetime data type.
CHAR_OCTET_LENGTH	INTEGER Nullable	Indicates the length in bytes of the column. Contains the null value if the column is not a string.
ORDINAL_POSITION	INTEGER	Indicates the ordinal position of the column in the table.
IS_NULLABLE	VARCHAR(3)	Indicates whether the column can contain the null value. NO The column is not nullable. YES The column is nullable.

Table 226. SQLCOLUMNS view (continued)

Column Name	Data Type	Description
JDBC_DATA_TYPE	SMALLINT	Indicates the JDBC data type of the column. -5 BIGINT 4 INTEGER 5 SMALLINT 3 DECIMAL 2 NUMERIC 8 DOUBLE PRECISION 7 REAL 1111 DECFLOAT 1 CHARACTER or GRAPHIC -15 NCHAR -2 CHARACTER FOR BIT DATA or BINARY 12 VARCHAR or VARGRAPHIC -9 NVARCHAR -3 VARCHAR FOR BIT DATA or VARBINARY 2005 CLOB or DBCLOB 2011 NCLOB 2004 BLOB 91 DATE 92 TIME 93 TIMESTAMP 70 DATALINK -8 ROWID 2009 XML 2001 DISTINCT
SCOPE_CATALOG	VARCHAR(128) Nullable	Reserved. Contains the null value.
SCOPE_SCHEMA	VARCHAR(128) Nullable	Reserved. Contains the null value.
SCOPE_TABLE	VARCHAR(128) Nullable	Reserved. Contains the null value.
SOURCE_DATA_TYPE	SMALLINT Nullable	The source data type if the data type of the column is a distinct type. For values see JDBC_DATA_TYPE. Contains the null value if the data type is not a distinct type.

Table 226. SQLCOLUMNS view (continued)

Column Name	Data Type	Description
DBNAME	VARCHAR(8) Nullable	Reserved. Contains the null value.
PSEUDO_COLUMN	SMALLINT	Indicates whether this is a ROWID, identity, row change timestamp, row begin, row end, transaction start ID, or generated expression column. 1 The column is not a ROWID, identity, row change timestamp, row begin, row end, transaction start ID, or generated expression column. 2 The column is a ROWID, identity, or row change timestamp, row begin, row end, transaction start ID, or generated expression column.
COLUMN_TEXT	VARCHAR(50) Nullable	The text of the column. Contains the null value if the column has no column text.
SYSTEM_COLUMN_NAME	CHAR(10)	The system name of the column.

Table 226. SQLCOLUMNS view (continued)

Column Name	Data Type	Description
I_DATA_TYPE	SMALLINT	Indicates the IBM i CLI data type of the column. 19 BIGINT 4 INTEGER 5 SMALLINT 3 DECIMAL 2 NUMERIC 8 DOUBLE PRECISION 7 REAL -360 DECFLOAT 1 CHARACTER -2 CHARACTER FOR BIT DATA or BINARY 12 VARCHAR -3 VARCHAR FOR BIT DATA or VARBINARY 14 CLOB 95 GRAPHIC or NCHAR 96 VARGRAPHIC or NVARCHAR 15 DBCLOB or NCLOB 13 BLOB 91 DATE 92 TIME 93 TIMESTAMP 16 DATALINK 1111 ROWID -370 XML 2001 DISTINCT
HIDDEN	CHAR(1)	Specifies whether the column is included in an implicit column list. P Partially hidden. N Not hidden.

Table 226. SQLCOLUMNS view (continued)

Column Name	Data Type	Description
HAS_DEFAULT	CHAR(1)	<p>If the column has a default value (DEFAULT clause or null capable):</p> <p>N No</p> <p>Y Yes</p> <p>A The column has a ROWID data type and the GENERATED ALWAYS attribute.</p> <p>D The column has a ROWID data type and the GENERATED BY DEFAULT attribute.</p> <p>E The column is defined with the FOR EACH ROW ON UPDATE and the GENERATED ALWAYS attribute.</p> <p>F The column is defined with the FOR EACH ROW ON UPDATE and the GENERATED BY DEFAULT attribute.</p> <p>I The column is defined with the AS IDENTITY and GENERATED ALWAYS attributes.</p> <p>J The column is defined with the AS IDENTITY and GENERATED BY DEFAULT attributes.</p> <p>Q The column is defined with the GENERATED AS ROW BEGIN attribute.</p> <p>R The column is defined with the GENERATED AS ROW END attribute.</p> <p>X The column is defined with the GENERATED AS TRANSACTION START ID attribute.</p> <p>a The column is defined as a generated expression using a special register.</p> <p>c The column is defined as a generated expression using a global variable.</p> <p>d The column is defined as a generated expression using DATA CHANGE OPERATION.</p> <p>If the column is for a view, N is returned.</p>
SOURCE_TYPE_NAME	VARCHAR(128) Nullable	<p>If the column data type is a user-defined type, the built-in data type name of its source type.</p> <p>Contains the null value if the column data type is not a user-defined type.</p>
SOURCE_SQL_DATA_TYPE	SMALLINT Nullable	<p>If the column data type is a user-defined type, the built-in SQL_DATA_TYPE of its source type. For values see SQL_DATA_TYPE.</p> <p>Contains the null value if the column data type is not a user-defined type.</p>
SOURCE_JDBC_DATA_TYPE	SMALLINT Nullable	<p>If the column data type is a user-defined type, the built-in JDBC_DATA_TYPE of its source type. For values see JDBC_DATA_TYPE.</p> <p>Contains the null value if the column data type is not a user-defined type.</p>

SQLFOREIGNKEYS

The SQLFOREIGNKEYS view contains one row for every referential constraint key on a table.

The following table describes the columns in the view:

Table 227. SQLFOREIGNKEYS view

Column Name	Data Type	Description
PKTABLE_CAT	VARCHAR(128)	Relational database name
PKTABLE_SCHEM	VARCHAR(128)	Name of the SQL schema containing the parent table.
PKTABLE_NAME	VARCHAR(128)	Parent table name.
PKCOLUMN_NAME	VARCHAR(128)	Parent key column name.
FKTABLE_CAT	VARCHAR(128)	Relational database name
FKTABLE_SCHEM	VARCHAR(128)	Name of the SQL schema containing the dependent table of the referential constraint.
FKTABLE_NAME	VARCHAR(128)	Dependent table name of the referential constraint.
FKCOLUMN_NAME	VARCHAR(128)	Dependent key name.
KEY_SEQ	SMALLINT	The position of the column within the key.
UPDATE_RULE	SMALLINT	Update Rule. 1 RESTRICT 3 NO ACTION
DELETE_RULE	SMALLINT	Delete Rule: 0 CASCADE 1 RESTRICT 2 SET NULL 3 NO ACTION 4 SET DEFAULT
FK_NAME	VARCHAR(128)	Name of the referential constraint
PK_NAME	VARCHAR(128)	Name of the unique constraint
DEFERRABILITY	SMALLINT	Indicates whether the constraint checking can be deferred. Will always be 7.
UNIQUE_OR_PRIMARY	CHAR(7)	Indicates the type of parent constraint: PRIMARY The parent constraint is a primary key. UNIQUE The parent constraint is a unique constraint.

SQLFUNCTIONCOLS

The SQLFUNCTIONCOLS view contains one row for every parameter of a function. The result of a scalar function and the result columns of a table function are also returned.

The following table describes the columns in the view:

Table 228. SQLFUNCTIONCOLS view

Column Name	Data Type	Description
FUNCTION_CAT	VARCHAR(128)	Relational database name
FUNCTION_SCHEM	VARCHAR(128)	Schema name of the function instance.
FUNCTION_NAME	VARCHAR(128)	Name of the function instance.
COLUMN_NAME	VARCHAR(128) Nullable	Name of a function parameter. Contains the null value if the parameter does not have a name.
COLUMN_TYPE	SMALLINT	Type of the parameter: 1 IN 4 RETURN value 5 Result column of a table function

Table 228. SQLFUNCTIONCOLS view (continued)

Column Name	Data Type	Description
DATA_TYPE	SMALLINT	The data type of the parameter:
		-5
		BIGINT
		4
		INTEGER
		5
		SMALLINT
		3
		DECIMAL
		2
		NUMERIC
		8
		DOUBLE PRECISION
		7
		REAL
		-360
		DECFLOAT
		1
		CHARACTER
		-2
		CHARACTER FOR BIT DATA or BINARY
		12
		VARCHAR
		-3
		VARCHAR FOR BIT DATA or VARBINARY
		-99
		CLOB
		-95
		GRAPHIC or
		-96
		VARGRAPHIC
		-350
		DBCLOB
		-8
		NCHAR
		-9
		NVARCHAR
		-10
		NCLOB
		-98
		BLOB
		91
		DATE
		92
		TIME
		93
		TIMESTAMP
		70
		DATALINK
		-100
		ROWID
		-370
		XML
		17
		DISTINCT
		50
		ARRAY

Table 228. SQLFUNCTIONCOLS view (continued)

Column Name	Data Type	Description
TYPE_NAME	VARCHAR(261)	The name of the data type of the parameter: BIGINT BIGINT INTEger INTEGER SMALLINT SMALLINT DECIMAL DECIMAL NUMERIC NUMERIC FLOAT DOUBLE PRECISION REAL REAL DECFLOAT DECFLOAT CHARacter CHARACTER CHARacter FOR BIT DATA CHARACTER FOR BIT DATA VARCHAR VARCHAR VARCHAR FOR BIT DATA VARCHAR FOR BIT DATA CLOB CLOB GRAPHIC GRAPHIC VARGRAPHIC VARGRAPHIC DBCLOB DBCLOB NCHAR NCHAR NVARCHAR NVARCHAR NCLOB NCLOB BINARY BINARY VARBINARY VARBINARY BLOB BLOB DATE DATE TIME TIME TIMESTAMP TIMESTAMP DATALINK DATALINK ROWID ROWID XML XML Qualified Type Name DISTINCT Array Type Name ARRAY
COLUMN_SIZE	INTEGER	Length of the parameter.

Table 228. SQLFUNCTIONCOLS view (continued)

Column Name	Data Type	Description
BUFFER_LENGTH	INTEGER	Indicates the length of the parameter in a buffer.
DECIMAL_DIGITS	SMALLINT Nullable	Scale of numeric or datetime data. Contains the null value if the parameter is not decimal, numeric, binary, time or timestamp.
NUM_PREC_RADIX	SMALLINT Nullable	Indicates if the precision specified in column NUMERIC_PRECISION is specified as a number of binary or decimal digits: 2 Binary; floating-point precision is specified in binary digits. 10 Decimal; all other numeric types are specified in decimal digits. Contains the null value if the parameter is not numeric.
NULLABLE	SMALLINT	Indicates whether the parameter is nullable. 0 The parameter does not allow nulls. 1 The parameter does allow nulls.
REMARKS	VARGRAPHIC(2000) CCSID 1200 Nullable	A character string supplied with the COMMENT statement. Contains the null value if there is no long comment.
COLUMN_DEF	DBCLOB(64K) CCSID 1200 Nullable	The expression string used to calculate the default value of a parameter, if one exists. If the default value is the null value, the expression string is the keyword NULL. Contains the null value if the parameter has no default.

Table 228. SQLFUNCTIONCOLS view (continued)

Column Name	Data Type	Description
SQL_DATA_TYPE	SMALLINT	The SQL data type of the parameter:
		-5
		BIGINT
		4
		INTEGER
		5
		SMALLINT
		3
		DECIMAL
		2
		NUMERIC
		8
		DOUBLE PRECISION
		7
		REAL
		-360
		DECFLOAT
		1
		CHARACTER
		-2
		CHARACTER FOR BIT DATA or BINARY
		12
		VARCHAR
		-3
		VARCHAR FOR BIT DATA or VARBINARY
		-99
		CLOB
		-95
		GRAPHIC
		-96
		VARGRAPHIC
		-350
		DBCLOB
		-8
		NCHAR
		-9
		NVARCHAR
		-10
		NCLOB
		-98
		BLOB
		9
		DATE
		9
		TIME
		9
		TIMESTAMP
		70
		DATALINK
		-100
		ROWID
		-370
		XML
		17
		DISTINCT
		50
		ARRAY

Table 228. SQLFUNCTIONCOLS view (continued)

Column Name	Data Type	Description
SQL_DATETIME_SUB	SMALLINT Nullable	The datetime subtype of the parameter: 1 DATE 2 TIME 3 TIMESTAMP Contains the null value if the data type is not a datetime data type.
CHAR_OCTET_LENGTH	INTEGER Nullable	Indicates the length in characters of the parameter. Contains the null value if the column is not a string.
ORDINAL_POSITION	INTEGER	Numeric place of the parameter in the parameter list, ordered from left to right. For scalar functions, the result of the function has a value of 0. For table functions, the result columns are numbered from 1 (leftmost result column) to <i>n</i> (nth result column).
IS_NULLABLE	VARCHAR(3)	Indicates whether the parameter is nullable. NO The parameter does not allow nulls. YES The parameter does allow nulls.
SPECIFIC_NAME	VARCHAR(128)	Specific name of the function instance

Table 228. SQLFUNCTIONCOLS view (continued)

Column Name	Data Type	Description
JDBC_DATA_TYPE	INTEGER	The JDBC data type of the parameter:
		-5 BIGINT
		4 INTEGER
		5 SMALLINT
		3 DECIMAL
		2 NUMERIC
		8 DOUBLE PRECISION
		7 REAL
		1111 DECFLOAT
		1 CHARACTER or GRAPHIC
		-15 NCHAR
		-2 CHARACTER FOR BIT DATA or BINARY
		12 VARCHAR or VARGRAPHIC
		-9 NVARCHAR
		-3 VARCHAR FOR BIT DATA or VARBINARY
		2005 CLOB or DBCLOB
		2011 NCLOB
		2004 BLOB
		91 DATE
		92 TIME
		93 TIMESTAMP
		70 ATALINK
		-8 ROWID
		2009 XML
		2001 DISTINCT
		2003 ARRAY

Table 228. SQLFUNCTIONCOLS view (continued)

Column Name	Data Type	Description
I_DATA_TYPE	INTEGER	Indicates the IBM i CLI data type of the parameter. 19 BIGINT 4 INTEGER 5 SMALLINT 3 DECIMAL 2 NUMERIC 8 DOUBLE PRECISION 7 REAL -360 DECFLOAT 1 CHARACTER -2 CHARACTER FOR BIT DATA or BINARY 12 VARCHAR -3 VARCHAR FOR BIT DATA or VARBINARY 14 CLOB 95 GRAPHIC or NCHAR 96 VARGRAPHIC or NVARCHAR 15 DBCLOB or NCLOB 13 BLOB 91 DATE 92 TIME 93 TIMESTAMP 16 DATALINK 1111 ROWID -370 XML 2001 DISTINCT 50 ARRAY
SOURCE_DATA_TYPE	SMALLINT Nullable	The source data type if the data type of the parameter is a distinct type. For values see JDBC_DATA_TYPE. Contains the null value if the data type is not a distinct type.
SOURCE_TYPE_NAME	VARCHAR(128) Nullable	If the parameter data type is a user-defined type, the built-in data type name of its source type. Contains the null value if the parameter data type is not a user-defined type.
SOURCE_SQL_DATA_TYPE	SMALLINT Nullable	If the parameter data type is a user-defined type, the built-in SQL_DATA_TYPE of its source type. For values see SQL_DATA_TYPE. Contains the null value if the parameter data type is not a user-defined type.

Table 228. SQLFUNCTIONCOLS view (continued)

Column Name	Data Type	Description
SOURCE_JDBC_DATA_TYPE	SMALLINT Nullable	If the parameter data type is a user-defined type, the built-in JDBC_DATA_TYPE of its source type. For values see JDBC_DATA_TYPE. Contains the null value if the parameter data type is not a user-defined type.
MAXIMUM_CARDINALITY	BIGINT Nullable	The maximum cardinality of the array data type. Contains the null value if the type is not an array type.

SQLFUNCTIONS

The SQLFUNCTIONS view contains one row for every function.

The following table describes the columns in the view:

Table 229. SQLFUNCTIONS view

Column Name	Data Type	Description
FUNCTION_CAT	VARCHAR(128)	Relational database name
FUNCTION_SCHEM	VARCHAR(128)	Name of the schema of the function instance.
FUNCTION_NAME	VARCHAR(128)	Name of the function.
REMARKS	VARGRAPHIC(2000) CCSID 1200 Nullable	A character string supplied with the COMMENT statement. Contains the null value if there is no long comment.
FUNCTION_TYPE	SMALLINT	Type of function: 1 Column or scalar function 2 Table function
SPECIFIC_NAME	VARCHAR(128)	Specific name of the function instance

SQLPRIMARYKEYS

The SQLPRIMARYKEYS view contains one row for every primary constraint key on a table.

The following table describes the columns in the view:

Table 230. SQLPRIMARYKEYS view

Column Name	Data Type	Description
TABLE_CAT	VARCHAR(128)	Relational database name
TABLE_SCHEM	VARCHAR(128)	Name of the schema containing the table with the primary key.
TABLE_NAME	VARCHAR(128)	Name of the table with the primary key.
COLUMN_NAME	VARCHAR(128)	Name of a primary key column.
KEY_SEQ	SMALLINT	The position of the column within the key.
PK_NAME	VARCHAR(128)	Name of the primary key constraint.

SQLPROCEDURECOLS

The SQLPROCEDURECOLS view contains one row for every parameter of a procedure.

The following table describes the columns in the view:

Table 231. SQLPROCEDURECOLS view

Column Name	Data Type	Description
PROCEDURE_CAT	VARCHAR(128)	Relational database name
PROCEDURE_SCHEM	VARCHAR(128)	Schema name of the procedure instance.
PROCEDURE_NAME	VARCHAR(128)	Name of the procedure instance.
COLUMN_NAME	VARCHAR(128) Nullable	Name of a procedure parameter. Contains the null value if the parameter does not have a name.
COLUMN_TYPE	SMALLINT	Type of the parameter: 1 IN 2 INOUT 4 OUT

Table 231. SQLPROCEDURECOLS view (continued)

Column Name	Data Type	Description
DATA_TYPE	SMALLINT	The data type of the parameter:
		-5
		BIGINT
		4
		INTEGER
		5
		SMALLINT
		3
		DECIMAL
		2
		NUMERIC
		8
		DOUBLE PRECISION
		7
		REAL
		-360
		DECFLOAT
		1
		CHARACTER
		-2
		CHARACTER FOR BIT DATA or BINARY
		12
		VARCHAR
		-3
		VARCHAR FOR BIT DATA or VARBINARY
		-99
		CLOB
		-95
		GRAPHIC
		-96
		VARGRAPHIC
		-350
		DBCLOB
		-8
		NCHAR
		-9
		NVARCHAR
		-10
		NCLOB
		-98
		BLOB
		91
		DATE
		92
		TIME
		93
		TIMESTAMP
		70
		DATALINK
		-100
		ROWID
		-370
		XML
		17
		DISTINCT
		50
		ARRAY

Table 231. SQLPROCEDURECOLS view (continued)

Column Name	Data Type	Description
TYPE_NAME	VARCHAR(261)	The name of the data type of the parameter: BIGINT BIGINT INTEger INTEGER SMALLINT SMALLINT DECIMAL DECIMAL NUMERIC NUMERIC FLOAT DOUBLE PRECISION REAL REAL DECFLOAT DECFLOAT CHARacter CHARACTER CHARacter FOR BIT DATA CHARACTER FOR BIT DATA VARCHAR VARCHAR VARCHAR FOR BIT DATA VARCHAR FOR BIT DATA CLOB CLOB GRAPHIC GRAPHIC VARGRAPHIC VARGRAPHIC DBCLOB DBCLOB NCHAR NCHAR NVARCHAR NVARCHAR NCLOB NCLOB BINARY BINARY VARBINARY VARBINARY BLOB BLOB DATE DATE TIME TIME TIMESTAMP TIMESTAMP DATALINK DATALINK ROWID ROWID XML XML Qualified Type Name DISTINCT Array Type Name ARRAY
COLUMN_SIZE	INTEGER	Length of the parameter.

Table 231. SQLPROCEDURECOLS view (continued)

Column Name	Data Type	Description
BUFFER_LENGTH	INTEGER	Indicates the length of the parameter in a buffer.
DECIMAL_DIGITS	SMALLINT Nullable	Scale of numeric or datetime data. Contains the null value if the parameter is not decimal, numeric, binary, time or timestamp.
NUM_PREC_RADIX	SMALLINT Nullable	Indicates if the precision specified in column NUMERIC_PRECISION is specified as a number of binary or decimal digits: 2 Binary; floating-point precision is specified in binary digits. 10 Decimal; all other numeric types are specified in decimal digits. Contains the null value if the parameter is not numeric.
NULLABLE	SMALLINT	Indicates whether the parameter is nullable. 0 The parameter does not allow nulls. 1 The parameter does allow nulls.
REMARKS	VARGRAPHIC(2000) CCSID 1200 Nullable	A character string supplied with the COMMENT statement. Contains the null value if there is no long comment.
COLUMN_DEF	DBCLOB(64K) CCSID(1200) Nullable	The expression string used to calculate the default value of a parameter, if one exists. If the default value is the null value, the expression string is the keyword NULL. Contains the null value if the parameter has no default.

Table 231. SQLPROCEDURECOLS view (continued)

Column Name	Data Type	Description
SQL_DATA_TYPE	SMALLINT	The SQL data type of the parameter:
		-5 BIGINT
		4 INTEGER
		5 SMALLINT
		3 DECIMAL
		2 NUMERIC
		8 DOUBLE PRECISION
		7 REAL
		-360 DECFLOAT
		1 CHARACTER
		-2 CHARACTER FOR BIT DATA or BINARY
		12 VARCHAR
		-3 VARCHAR FOR BIT DATA or VARBINARY
		-99 CLOB
		-95 GRAPHIC
		-96 VARGRAPHIC
		-350 DBCLOB
		-8 NCHAR
		-9 NVARCHAR
		-10 NCLOB
		-98 BLOB
		9 DATE
		9 TIME
		9 TIMESTAMP
		70 DATALINK
		-100 ROWID
		-370 XML
		17 DISTINCT
		50 ARRAY

Table 231. SQLPROCEDURECOLS view (continued)

Column Name	Data Type	Description
SQL_DATETIME_SUB	SMALLINT Nullable	The datetime subtype of the parameter: 1 DATE 2 TIME 3 TIMESTAMP Contains the null value if the data type is not a datetime data type.
CHAR_OCTET_LENGTH	INTEGER Nullable	Indicates the length in characters of the parameter. Contains the null value if the column is not a string.
ORDINAL_POSITION	INTEGER	Numeric place of the parameter in the parameter list, ordered from left to right.
IS_NULLABLE	VARCHAR(3)	Indicates whether the parameter is nullable. NO The parameter does not allow nulls. YES The parameter does allow nulls.
SPECIFIC_NAME	VARCHAR(128)	Specific name of the procedure instance.

Table 231. SQLPROCEDURECOLS view (continued)

Column Name	Data Type	Description
JDBC_DATA_TYPE	INTEGER	The JDBC data type of the parameter:
		-5 BIGINT
		4 INTEGER
		5 SMALLINT
		3 DECIMAL
		2 NUMERIC
		8 DOUBLE PRECISION
		7 REAL
		1111 DECFLOAT
		1 CHARACTER or GRAPHIC
		-15 NCHAR
		-2 CHARACTER FOR BIT DATA or BINARY
		12 VARCHAR or VARGRAPHIC
		-9 NVARCHAR
		-3 VARCHAR FOR BIT DATA or VARBINARY
		2005 CLOB or DBCLOB
		2011 NCLOB
		2004 BLOB
		91 DATE
		92 TIME
		93 TIMESTAMP
		70 ATALINK
		-8 ROWID
		2009 XML
		2001 DISTINCT
		2003 ARRAY

Table 231. SQLPROCEDURECOLS view (continued)

Column Name	Data Type	Description
I_DATA_TYPE	INTEGER	Indicates the IBM i CLI data type of the parameter. 19 BIGINT 4 INTEGER 5 SMALLINT 3 DECIMAL 2 NUMERIC 8 DOUBLE PRECISION 7 REAL -360 DECFLOAT 1 CHARACTER -2 CHARACTER FOR BIT DATA or BINARY 12 VARCHAR -3 VARCHAR FOR BIT DATA or VARBINARY 14 CLOB 95 GRAPHIC or NCHAR 96 VARGRAPHIC or NVARCHAR 15 DBCLOB or NCLOB 13 BLOB 91 DATE 92 TIME 93 TIMESTAMP 16 DATALINK 1111 ROWID -370 XML 2001 DISTINCT 50 ARRAY
SOURCE_TYPE_NAME	VARCHAR(128) Nullable	If the parameter data type is a user-defined type, the built-in data type name of its source type. Contains the null value if the parameter data type is not a user-defined type.
SOURCE_SQL_DATA_TYPE	SMALLINT Nullable	If the parameter data type is a user-defined type, the built-in SQL_DATA_TYPE of its source type. For values see SQL_DATA_TYPE. Contains the null value if the parameter data type is not a user-defined type.
SOURCE_JDBC_DATA_TYPE	SMALLINT Nullable	If the parameter data type is a user-defined type, the built-in JDBC_DATA_TYPE of its source type. For values see JDBC_DATA_TYPE. Contains the null value if the parameter data type is not a user-defined type.

Table 231. SQLPROCEDURECOLS view (continued)

Column Name	Data Type	Description
MAXIMUM_CARDINALITY	BIGINT	The maximum cardinality of the array data type.
	Nullable	Contains the null value if the type is not an array type.

SQLPROCEDURES

The SQLPROCEDURES view contains one row for every procedure.

The following table describes the columns in the view:

Table 232. SQLPROCEDURES view

Column Name	Data Type	Description
PROCEDURE_CAT	VARCHAR(128)	Relational database name
PROCEDURE_SCHEM	VARCHAR(128)	Name of the schema of the procedure instance.
PROCEDURE_NAME	VARCHAR(128)	Name of the procedure.
NUM_INPUT_PARAMS	INTEGER	Identifies the number of input parameters. 0 indicates that there are no input parameters.
NUM_OUTPUT_PARAMS	INTEGER	Identifies the number of output parameters. 0 indicates that there are no output parameters.
NUM_RESULT_SETS	SMALLINT	Identifies the maximum number of result sets returned. 0 indicates that there are no result sets.
REMARKS	VARGRAPHIC(2000) CCSID 1200 Nullable	A character string supplied with the COMMENT statement. Contains the null value if there is no long comment.
PROCEDURE_TYPE	SMALLINT	Reserved. Contains 0.
NUM_INOUT_PARAMS	INTEGER	Identifies the number of input/output parameters. 0 indicates that there are no input/output parameters.
SPECIFIC_NAME	VARCHAR(128)	Specific name of the procedure instance.

SQLSCHEMAS

The SQLSCHEMAS view contains one row for every schema.

The following table describes the columns in the view:

Table 233. SQLSCHEMAS view

Column Name	Data Type	Description
TABLE_CAT	VARCHAR(128)	Relational database name
TABLE_SCHEM	VARCHAR(128)	Name of the schema.
TABLE_NAME	VARCHAR(128) Nullable	Reserved. Contains the null value.
TABLE_TYPE	VARCHAR(128) Nullable	Reserved. Contains the null value.
REMARKS	VARGRAPHIC(2000) CCSID 1200 Nullable	Reserved. Contains the null value.
TYPE_CAT	VARCHAR(128) Nullable	Reserved. Contains the null value.
TYPE_SCHEM	VARCHAR(128) Nullable	Reserved. Contains the null value.
TYPE_NAME	VARCHAR(128) Nullable	Reserved. Contains the null value.
SELF_REFERENCING_COL_NAME	VARCHAR(128) Nullable	Reserved. Contains the null value.
REF_GENERATION	VARCHAR(128) Nullable	Reserved. Contains the null value.
DBNAME	VARCHAR(8) Nullable	Reserved. Contains the null value.
SCHEMA_TEXT	VARGRAPHIC(50) CCSID 1200 Nullable	A character string that describes the schema. Contains the empty string if there is no text.
SYSTEM_TABLE_SCHEMA	CHAR(10)	System schema name.

SQLSPECIALCOLUMNS

The SQLSPECIALCOLUMNS view contains one row for every column of a primary key, unique constraint, or unique index that can identify a row of the table.

The following table describes the columns in the view:

Table 234. SQLSPECIALCOLUMNS view

Column Name	Data Type	Description
SCOPE	SMALLINT	Reserved. Contains 0.
COLUMN_NAME	VARCHAR(128)	Column name

Table 234. SQLSPECIALCOLUMNS view (continued)

Column Name	Data Type	Description
DATA_TYPE	SMALLINT	The data type of the column:
		-5
		BIGINT
		4
		INTEGER
		5
		SMALLINT
		3
		DECIMAL
		2
		NUMERIC
		8
		DOUBLE PRECISION
		7
		REAL
		-360
		DECFLOAT
		1
		CHARACTER
		-2
		CHARACTER FOR BIT DATA
		12
		VARCHAR
		-3
		VARCHAR FOR BIT DATA
		40
		CLOB
		-95
		GRAPHIC
		-96
		VARGRAPHIC
		-350
		DBCLOB
		-8
		NCHAR
		-9
		NVARCHAR
		-10
		NCLOB
		-2
		BINARY
		-3
		VARBINARY
		30
		BLOB
		91
		DATE
		92
		TIME
		93
		TIMESTAMP
		70
		DATALINK
		-100
		ROWID
		17
		DISTINCT

Table 234. SQLSPECIALCOLUMNS view (continued)

Column Name	Data Type	Description
TYPE_NAME	VARCHAR(260)	The name of the data type of the parameter: BIGINT BIGINT INTEger INTEGER SMALLINT SMALLINT DECIMAL DECIMAL NUMERIC NUMERIC FLOAT DOUBLE PRECISION REAL REAL DECFLOAT DECFLOAT CHARacter CHARACTER CHARacter FOR BIT DATA CHARACTER FOR BIT DATA VARCHAR VARCHAR VARCHAR FOR BIT DATA VARCHAR FOR BIT DATA CLOB CLOB GRAPHIC GRAPHIC VARGRAPHIC VARGRAPHIC DBCLOB DBCLOB NCHAR NCHAR NVARCHAR NVARCHAR NCLOB NCLOB BINARY BINARY VARBINARY VARBINARY BLOB BLOB DATE DATE TIME TIME TIMESTAMP TIMESTAMP DATALINK DATALINK ROWID ROWID XML XML Qualified Type Name DISTINCT
COLUMN_SIZE	INTEGER	The length of the column.
BUFFER_LENGTH	INTEGER	Indicates the length of the column in a buffer.

Table 234. SQLSPECIALCOLUMNS view (continued)

Column Name	Data Type	Description
DECIMAL_DIGITS	SMALLINT	Indicates the number of digits for a numeric column.
	Nullable	Contains the null value if the column is not numeric.
PSEUDO_COLUMN	SMALLINT	Indicates whether this is a ROWID, identity, row change timestamp, row begin, row end, transaction start ID, or generated expression column.
		<p>1</p> <p>The column is not a ROWID, identity, row change timestamp, row begin, row end, transaction start ID, or generated expression column.</p> <p>2</p> <p>The column is a ROWID, identity, row change timestamp, row begin, row end, transaction start ID, or generated expression column.</p>
TABLE_CAT	VARCHAR(128)	Relational database name
TABLE_SCHEM	VARCHAR(128)	Name of the SQL schema that contains the table.
TABLE_NAME	VARCHAR(128)	Name of the table.
NULLABLE	SMALLINT	Indicates whether the column can contain the null value.
		<p>0</p> <p>The column is not nullable.</p> <p>1</p> <p>The column is nullable.</p>

Table 234. SQLSPECIALCOLUMNS view (continued)

Column Name	Data Type	Description
JDBC_DATA_TYPE	SMALLINT	Indicates the JDBC data type of the column.
		-5 BIGINT
		4 INTEGER
		5 SMALLINT
		3 DECIMAL
		2 NUMERIC
		8 DOUBLE PRECISION
		7 REAL
		1111 DECFLOAT
		1 CHARACTER or GRAPHIC
		-15 NCHAR
		-2 CHARACTER FOR BIT DATA or BINARY
		12 VARCHAR or VARGRAPHIC
		-9 NVARCHAR
		-3 VARCHAR FOR BIT DATA or VARBINARY
		2005 CLOB or DBCLOB
		2011 NCLOB
		2004 BLOB
		91 DATE
		92 TIME
		93 TIMESTAMP
		70 ATALINK
		-8 ROWID
		2009 XML
		2001 DISTINCT

Table 234. SQLSPECIALCOLUMNS view (continued)

Column Name	Data Type	Description
I_DATA_TYPE	SMALLINT	Indicates the IBM i CLI data type of the column. 19 BIGINT 4 INTEGER 5 SMALLINT 3 DECIMAL 2 NUMERIC 8 DOUBLE PRECISION 7 REAL -360 DECFLOAT 1 CHARACTER -2 CHARACTER FOR BIT DATA or BINARY 12 VARCHAR -3 VARCHAR FOR BIT DATA or VARBINARY 14 CLOB 95 GRAPHIC or NCHAR 96 VARGRAPHIC or NVARCHAR 15 DBCLOB or NCLOB 13 BLOB 91 DATE 92 TIME 93 TIMESTAMP 16 DATALINK 1111 ROWID -370 XML 2001 DISTINCT
SOURCE_TYPE_NAME	VARCHAR(128) Nullable	If the column data type is a user-defined type, the built-in data type name of its source type. Contains the null value if the column data type is not a user-defined type.
SOURCE_SQL_DATA_TYPE	SMALLINT Nullable	If the column data type is a user-defined type, the built-in SQL_DATA_TYPE of its source type. For values see SQL_DATA_TYPE. Contains the null value if the column data type is not a user-defined type.
SOURCE_JDBC_DATA_TYPE	SMALLINT Nullable	If the column data type is a user-defined type, the built-in JDBC_DATA_TYPE of its source type. For values see JDBC_DATA_TYPE. Contains the null value if the column data type is not a user-defined type.

SQLSTATISTICS

The SQLSTATISTICS view contains statistic information about a table.

The following table describes the columns in the view:

Table 235. SQLSTATISTICS view

Column Name	Data Type	Description
TABLE_CAT	VARCHAR(128)	Relational database name
TABLE_SCHEM	VARCHAR(128)	Name of the SQL schema of the table.
TABLE_NAME	VARCHAR(128)	Name of the table.
NON_UNIQUE	SMALLINT Nullable	Indicates whether an index prohibits duplicate keys on the table. Contains the null value if the TYPE is 0.
INDEX_QUALIFIER	VARCHAR(128) Nullable	Name of the schema of the index. Contains the null value if the TYPE is 0.
INDEX_NAME	VARCHAR(128) Nullable	Name of the index. Contains the null value if the TYPE is 0.
TYPE	SMALLINT	Indicates the type of information returned: 0 The number of rows in the table. 3 An index on the table.
ORDINAL_POSITION	SMALLINT Nullable	Indicates the ordinal position of the key in the index. Contains the null value if the TYPE is 0.
COLUMN_NAME	DBCLOB(2097152) CCSID 1200 Nullable	If the key column is an expression, contains the expression. Contains the column name if the key column is not an expression. Contains the null value if the TYPE is 0.
ASC_OR_DESC	CHAR(1) Nullable	Order of the column in the key: A Ascending D Descending Contains the null value if the TYPE is 0.
CARDINALITY	BIGINT Nullable	The number of valid rows in all partitions or members of the table. Contains the null value if the TYPE is 3.
PAGES	BIGINT Nullable	The number of 64K pages all partitions or members of the table. Contains the null value if the TYPE is 3.
FILTER_CONDITION	DBCLOB(2097152) CCSID 1200 Nullable	Indicates whether the index is a sparse index. search-condition This is an SQL index with a WHERE clause. empty-string This is a DDS-created select/omit index. Contains the null value if the TYPE is 0 or this is not a sparse index.

Table 235. SQLSTATISTICS view (continued)

Column Name	Data Type	Description
I_INDEXTYPE	INTEGER	Contains the type of the index. 0 The TYPE is 0. 1 The index is a PRIMARY KEY or keyed physical file. 2 The index is an SQL index. 3 The index is a keyed logical file. 4 The index is a UNIQUE or REFERENTIAL constraint.

SQLTABLEPRIVILEGES

The SQLTABLEPRIVILEGES view contains one row for every privilege granted on a table. Note that this catalog view cannot be used to determine whether a user is authorized to a table or view because the privilege to use a table or view could be acquired through a group user profile or special authority (such as *ALLOBJ).

The following table describes the columns in the view:

Table 236. SQLTABLEPRIVILEGES view

Column Name	Data Type	Description
TABLE_CAT	VARCHAR(128)	Relational database name
TABLE_SCHEM	VARCHAR(128)	Name of the SQL schema of the table.
TABLE_NAME	VARCHAR(128)	Name of the table.
GRANTOR	VARCHAR(128) Nullable	Reserved. Contains the null value.
GRANTEE	VARCHAR(128)	The user profile to which the privilege is granted.
PRIVILEGE	VARCHAR(10)	The privilege granted: ALTER The privilege to alter the table. DELETE The privilege to delete rows from the table. INDEX The privilege to create an index on the table. INSERT The privilege to insert rows into the table. REFERENCES The privilege to reference the table in a referential constraint. SELECT The privilege to select rows from the table. UPDATE The privilege to update the table.
IS_GRANTABLE	VARCHAR(3)	Indicates whether the privilege is grantable to other users. NO The privilege is not grantable. YES The privilege is grantable.
DBNAME	VARCHAR(8) Nullable	Reserved. Contains the null value.

SQLTABLES

The SQLTABLES view contains one row for every table, view, and alias.

The following table describes the columns in the view:

Table 237. SQLTABLES view

Column Name	Data Type	Description
TABLE_CAT	VARCHAR(128)	Relational database name
TABLE_SCHEM	VARCHAR(128)	Name of the schema containing the table.
TABLE_NAME	VARCHAR(128)	Name of the table.
TABLE_TYPE	VARCHAR(24)	Indicates the type of the table: ALIAS The table is an alias. MATERIALIZED QUERY TABLE The object is a materialized query table. SYSTEM TABLE The table is a system table. TABLE The table is an SQL table or physical file. VIEW The table is an SQL view or logical file.
REMARKS	VARGRAPHIC(2000) CCSID 1200 Nullable	A character string supplied with the COMMENT statement. Contains the null value if there is no long comment.
TYPE_CAT	VARCHAR(128) Nullable	Reserved. Contains the null value.
TYPE_SCHEM	VARCHAR(128) Nullable	Reserved. Contains the null value.
TYPE_NAME	VARCHAR(128) Nullable	Reserved. Contains the null value.
SELF_REFERENCING_ COLUMN_NAME	VARCHAR(128) Nullable	Reserved. Contains the null value.
REF_GENERATION	VARCHAR(128) Nullable	Reserved. Contains the null value.
DBNAME	VARCHAR(8) Nullable	Reserved. Contains the null value.
TABLE_TEXT	VARGRAPHIC(50) CCSID 1200	A character string provided with the LABEL statement.

SQLTYPEINFO

The SQLTYPEINFO table contains one row for every built-in data type.

The following table describes the columns in the table:

Table 238. SQLTYPEINFO table

Column Name	Data Type	Description
TYPE_NAME	VARCHAR(128)	Name of the built-in data type: BIGINT BIGINT INTEger INTEGER SMALLINT SMALLINT DECIMAL DECIMAL NUMERIC NUMERIC FLOAT DOUBLE PRECISION REAL REAL DECFLOAT DECFLOAT CHARacter CHARACTER CHARacter FOR BIT DATA CHARACTER FOR BIT DATA VARCHAR VARCHAR VARCHAR FOR BIT DATA VARCHAR FOR BIT DATA CLOB CLOB GRAPHIC GRAPHIC VARGRAPHIC VARGRAPHIC DBCLOB DBCLOB NCHAR NCHAR NVARCHAR NVARCHAR NCLOB NCLOB BINARY BINARY VARBINARY VARBINARY BLOB BLOB DATE DATE TIME TIME TIMESTAMP TIMESTAMP DATALINK DATALINK ROWID ROWID XML XML

Table 238. SQLTYPEINFO table (continued)

Column Name	Data Type	Description
DATA_TYPE	SMALLINT	The data type of the built-in data type: -5 BIGINT 4 INTEGER 5 SMALLINT 3 DECIMAL 2 NUMERIC 8 DOUBLE PRECISION 7 REAL -360 DECFLOAT 1 CHARACTER -2 CHARACTER FOR BIT DATA or BINARY 12 VARCHAR -3 VARCHAR FOR BIT DATA or VARBINARY -99 CLOB -95 GRAPHIC -96 VARGRAPHIC -350 DBCLOB -8 NCHAR -9 NVARCHAR -10 NCLOB -99 BLOB 91 DATE 92 TIME 93 TIMESTAMP 70 DATALINK -100 ROWID -370 XML 2001 DISTINCT
COLUMN_SIZE	INTEGER Nullable	The maximum length of the data type.
LITERAL_PREFIX	VARCHAR(128) Nullable	Indicates the prefix for a string literal. Contains the null value if the data type is not a string.

Table 238. SQLTYPEINFO table (continued)

Column Name	Data Type	Description
LITERAL_SUFFIX	VARCHAR(128) Nullable	Indicates the suffix for a string literal. Contains the null value if the data type is not a string.
CREATE_PARAMS	VARCHAR(128) Nullable	Indicates the parameters supported with the data type. length The parameter is a length. Returned for all string data types and DATALINK. precision,scale The parameters include precision and scale. Returned for the DECIMAL and NUMERIC data types. precision The parameters include precision. Returned for the DECFLOAT and TIMESTAMP data type. Contains the null value for all other data types.
NULLABLE	SMALLINT Nullable	Indicates whether the data type is nullable. 0 The data type does not allow nulls. 1 The data type does allow nulls.
CASE_SENSITIVE	SMALLINT Nullable	Indicates whether the data type is case sensitive. 0 The data type is not case sensitive. 1 The data type is case sensitive.
SEARCHABLE	SMALLINT Nullable	Indicates whether the data type can be used in a predicate. 0 The data type cannot be used in predicates. 2 The data type can be used in all predicates except the LIKE predicate. 3 The data type can be used in all predicates including the LIKE predicate.
UNSIGNED_ATTRIBUTE	SMALLINT Nullable	Indicates whether the numeric data type is signed or unsigned. 0 The data type is signed. 1 The data type is unsigned. Contains the null value if the data type is not numeric.
FIXED_PREC_SCALE	SMALLINT Nullable	Indicates whether the data type has a fixed precision and scale. 0 The data type does not have a fixed precision and scale. 1 The data type does have a fixed precision and scale. Contains the null value if the data type is not numeric.
AUTO_UNIQUE_VALUE	SMALLINT Nullable	Indicates whether the numeric data type is auto-incrementing: 0 The data type is not auto-incrementing. 1 The data type is auto-incrementing. Contains the null value if the data type is not numeric.
LOCAL_TYPE_NAME	VARCHAR(128) Nullable	Reserved. Contains the null value.
MINIMUM_SCALE	SMALLINT Nullable	Indicates the minimum scale of numeric data types. Contains the null value if the data type is not numeric.
MAXIMUM_SCALE	SMALLINT Nullable	Indicates the maximum scale of numeric data types. Contains the null value if the data type is not numeric.

Table 238. SQLTYPEINFO table (continued)

Column Name	Data Type	Description
SQL_DATA_TYPE	SMALLINT	Indicates the SQL data type value of the data type:
	Nullable	<p>-5 BIGINT</p> <p>4 INTEGER</p> <p>5 SMALLINT</p> <p>3 DECIMAL</p> <p>2 NUMERIC</p> <p>8 DOUBLE PRECISION</p> <p>7 REAL</p> <p>-360 DECFLOAT</p> <p>1 CHARACTER</p> <p>-2 CHARACTER FOR BIT DATA or BINARY</p> <p>12 VARCHAR</p> <p>-3 VARCHAR FOR BIT DATA or VARBINARY</p> <p>-99 CLOB</p> <p>-95 GRAPHIC</p> <p>-96 VARGRAPHIC</p> <p>-350 DBCLOB</p> <p>-8 NCHAR</p> <p>-9 NVARCHAR</p> <p>-10 NCLOB</p> <p>-98 BLOB</p> <p>9 DATE</p> <p>9 TIME</p> <p>9 TIMESTAMP</p> <p>70 DATALINK</p> <p>-100 ROWID</p> <p>-370 XML</p> <p>17 DISTINCT</p>

Table 238. SQLTYPEINFO table (continued)

Column Name	Data Type	Description
SQL_DATETIME_SUB	SMALLINT Nullable	The datetime subtype of the data type: 1 DATE 2 TIME 3 TIMESTAMP Contains the null value if the data type is not a datetime data type.
NUM_PREC_RADIX	INTEGER Nullable	Indicates if the precision specified in column NUMERIC_PRECISION is specified as a number of binary or decimal digits: 2 Binary; floating-point precision is specified in binary digits. 10 Decimal; all other numeric types are specified in decimal digits. Contains the null value if the parameter is not numeric.
INTERVAL_PRECISION	SMALLINT Nullable	Reserved. Contains the null value.

Table 238. SQLTYPEINFO table (continued)

Column Name	Data Type	Description
JDBC_DATA_TYPE	SMALLINT	The JDBC data type value of the data type: -5 BIGINT 4 INTEGER 5 SMALLINT 3 DECIMAL 2 NUMERIC 8 DOUBLE PRECISION 7 REAL 1111 DECFLOAT 1 CHARACTER or GRAPHIC -15 NCHAR -2 CHARACTER FOR BIT DATA or BINARY 12 VARCHAR or VARGRAPHIC -9 NVARCHAR -3 VARCHAR FOR BIT DATA or VARBINARY 2005 CLOB or DBCLOB 2011 NCLOB 2004 BLOB 91 DATE 92 TIME 93 TIMESTAMP 70 DATALINK -8 ROWID 2009 XML 2001 DISTINCT

Table 238. SQLTYPEINFO table (continued)

Column Name	Data Type	Description
I_DATA_TYPE	SMALLINT	Indicates the IBM i CLI data type of the data type.
		19 BIGINT
		4 INTEGER
		5 SMALLINT
		3 DECIMAL
		2 NUMERIC
		8 DOUBLE PRECISION
		7 REAL
		-360 DECFLOAT
		1 CHARACTER
		-2 CHARACTER FOR BIT DATA or BINARY
		12 VARCHAR
		-3 VARCHAR FOR BIT DATA or VARBINARY
		14 CLOB
		95 GRAPHIC or NCHAR
		96 VARGRAPHIC or NVARCHAR
		15 DBCLOB or NCLOB
		13 BLOB
		91 DATE
		92 TIME
		93 TIMESTAMP
		16 DATALINK
		1111 ROWID
		-370 XML
		2001 DISTINCT

SQLUDTS

The SQLUDTS view contains one row for every distinct type.

The following table describes the columns in the view:

Table 239. SQLUDTS view

Column Name	Data Type	Description
TYPE_CAT	VARCHAR(128)	Relational database name
TYPE_SCHEM	VARCHAR(128)	Name of the schema containing the user-defined type.
TYPE_NAME	VARCHAR(128)	Name of the user-defined type.
CLASS_NAME	VARCHAR(20)	Java class name of the user-defined type. java.math.BigInteger BIGINT java.lang.Integer INTEGER java.lang.Short SMALLINT java.math.BigDecimal DECIMAL java.sql.BigDecimal NUMERIC java.lang.Double DOUBLE PRECISION java.lang.Float REAL java.math.BigDecimal DECFLOAT java.lang.String CHARACTER byte[] CHARACTER FOR BIT DATA java.lang.String VARCHAR byte[] VARCHAR FOR BIT DATA java.sql.Clob CLOB java.lang.String GRAPHIC java.lang.String VARGRAPHIC java.sql.Clob DBCLOB byte[] BINARY byte[] VARBINARY java.sql.Blob BLOB java.sql.Date DATE java.sql.Time TIME java.sql.Timestamp TIMESTAMP java.net.URL DATALINK byte[] ROWID java.sql.SQLXML XML

Table 239. SQLUDTS view (continued)

Column Name	Data Type	Description
DATA_TYPE	SMALLINT	Reserved. Contains 2001.
BASE_TYPE	SMALLINT	The source data type of the user-defined data type: -5 BIGINT 4 INTEGER 5 SMALLINT 3 DECIMAL 2 NUMERIC 8 DOUBLE PRECISION 7 REAL 1111 DECFLOAT 1 CHARACTER or GRAPHIC -15 NCHAR -2 CHARACTER FOR BIT DATA or BINARY 12 VARCHAR or VARGRAPHIC -9 NVARCHAR -3 VARCHAR FOR BIT DATA or VARBINARY 2005 CLOB or DBCLOB 2011 NCLOB 2004 BLOB 91 DATE 92 TIME 93 TIMESTAMP 70 DATALINK 1111 ROWID 2009 XML
REMARKS	VARGRAPHIC(2000) CCSID 1200 Nullable	A character string supplied with the COMMENT statement. Contains the null value if there is no comment.

ANS and ISO catalog views

There are two versions of some of the ANS and ISO catalog views. The version documented is the normal set of ANS and ISO views. A second set of views have names that are limited to no more than 18 characters and other than the view names are not documented in this book.

The ANS and ISO catalog includes the following tables in the QSYS2 library:

View Name	Shorter View Name	Description
“SQL_FEATURES” on page 1965		Information about features supported by the database manager
“SQL_LANGUAGES” on page 1966	SQL_LANGUAGES_S	Information about the supported languages
“SQL_SIZING” on page 1967		Information about the limits supported by the database manager

The ANS and ISO catalog includes the following views and tables in the SYSIBM and QSYS2 libraries:

View Name	Shorter View Name	Description
“AUTHORIZATIONS” on page 1938		Information about authorization IDs
“CHARACTER_SETS” on page 1939	CHARACTER_SETS_S	Information about supported CCSIDs
“CHECK_CONSTRAINTS” on page 1940		Information about check constraints
“COLUMN_PRIVILEGES” on page 1941		Information about column privileges
“COLUMNS” on page 1942	COLUMNS_S	Information about columns
“INFORMATION_SCHEMA_CATALOG_NAME” on page 1947	CATALOG_NAME	Information about the relational database
“PARAMETERS” on page 1948	PARAMETERS_S	Information about procedure parameters
“REFERENTIAL_CONSTRAINTS” on page 1952	REF_CONSTRAINTS	Information about referential constraints
“ROUTINE_PRIVILEGES” on page 1962	RTNPRIV	Information about routine privileges
“ROUTINES” on page 1953	ROUTINES_S	Information about routines
“SCHEMATA” on page 1963	SCHEMATA_S	Statistical information about schemas
“SEQUENCES” on page 1964		Information about sequences
“TABLE_CONSTRAINTS” on page 1968		Information about constraints
“TABLE_PRIVILEGES” on page 1969		Information about table privileges
“TABLES” on page 1970	TABLES_S	Information about tables
“UDT_PRIVILEGES” on page 1971	UDTPRIV	Information about type privileges
“USAGE_PRIVILEGES” on page 1972	USAGEPRIV	Information about sequence and XML schema privileges
“USER_DEFINED_TYPES” on page 1973	UDT_S	Information about types
“VARIABLE_PRIVILEGES” on page 1977	VARPRIV	Information about global variable privileges
“VIEWS” on page 1978		Information about views

AUTHORIZATIONS

The AUTHORIZATIONS view contains one row for every authorization ID.

The following table describes the columns in the view:

Table 240. AUTHORIZATIONS view

Column Name	Data Type	Description
AUTHORIZATION_NAME	VARCHAR(128)	Authorization ID name
AUTHORIZATION_TYPE	VARCHAR(4)	The type of authorization ID. Contains 'USER'.
AUTHORIZATION_ATTR	VARCHAR(5)	The type of user profile. Contains 'USER' or 'GROUP'.
AUTHORIZATION_TEXT	VARCHAR(50)	The text description for the profile.

CHARACTER_SETS

The CHARACTER_SETS view contains one row for every CCSID supported.

The following table describes the columns in the view:

Table 241. CHARACTER_SETS view

Column Name	Data Type	Description
CHARACTER_SET_CATALOG	VARCHAR(128)	Relational database name
CHARACTER_SET_SCHEMA	VARCHAR(128)	The schema name of the character set. Contains 'SYSIBM'.
CHARACTER_SET_NAME	VARCHAR(128)	The character set name.
FORM_OF_USE	VARCHAR(128) Nullable	Reserved. Contains the null value.
NUMBER_OF_CHARACTERS	INTEGER Nullable	Reserved. Contains the null value.
DEFAULT_COLLATE_CATALOG	VARCHAR(128)	Reserved.
DEFAULT_COLLATE_SCHEMA	VARCHAR(128)	Reserved.
DEFAULT_COLLATE_NAME	VARCHAR(128)	Reserved.

CHECK_CONSTRAINTS

The CHECK_CONSTRAINTS view contains one row for every check constraint.

The following table describes the columns in the view:

Table 242. CHECK_CONSTRAINTS view

Column Name	Data Type	Description
CONSTRAINT_CATALOG	VARCHAR(128)	Relational database name
CONSTRAINT_SCHEMA	VARCHAR(128)	Name of the schema containing the constraint
CONSTRAINT_NAME	VARCHAR(128)	Name of the constraint
CHECK_CLAUSE	VARGRAPHIC(2000) CCSID 1200 Nullable	Text of the check constraint clause Contains the null value if the check clause cannot be contained in the column without truncation.

COLUMN_PRIVILEGES

The COLUMN_PRIVILEGES view contains one row for every privilege granted on a column. Note that this catalog view cannot be used to determine whether a user is authorized to a column because the privilege to use a column could be acquired through a group user profile or special authority (such as *ALLOBJ). Furthermore, the privilege to use a column is also acquired through privileges granted on the table.

The following table describes the columns in the view:

Table 243. COLUMN_PRIVILEGES view

Column Name	Data Type	Description
GRANTOR	VARCHAR(128) Nullable	Reserved. Contains the null value.
GRANTEE	VARCHAR(128)	The user profile to which the privilege is granted.
TABLE_CATALOG	VARCHAR(128)	Relational database name
TABLE_SCHEMA	VARCHAR(128)	Name of the SQL schema that contains the table.
TABLE_NAME	VARCHAR(128)	Name of the table.
COLUMN_NAME	VARCHAR(128)	Name of the column.
PRIVILEGE_TYPE	VARCHAR(10)	The privilege granted: UPDATE The privilege to update the column. REFERENCES The privilege to reference the column in a referential constraint.
IS_GRANTABLE	VARCHAR(3)	Indicates whether the privilege is grantable to other users. NO The privilege is not grantable. YES The privilege is grantable.

COLUMNS

The COLUMNS view contains one row for every column.

The following table describes the columns in the view:

Table 244. COLUMNS view

Column Name	Data Type	Description
TABLE_CATALOG	VARCHAR(128)	Relational database name
TABLE_SCHEMA	VARCHAR(128)	Name of the SQL schema containing the table or view
TABLE_NAME	VARCHAR(128)	Name of the table or view that contains the column
COLUMN_NAME	VARCHAR(128)	Name of the column
ORDINAL_POSITION	INTEGER	Numeric place of the column in the table or view, ordered from left to right
COLUMN_DEFAULT	VARGRAPHIC(2000) CCSID 1200 Nullable	<p>The default value of a column, if one exists. If the default value of the column cannot be represented without truncation, then the value of the column is the string 'TRUNCATED'. The default value is stored in character form. The following special values also exist:</p> <p>CURRENT_DATE The default value is the current date.</p> <p>CURRENT_TIME The default value is the current time.</p> <p>CURRENT_TIMESTAMP The default value is the current timestamp.</p> <p>NULL The default value is the null value and DEFAULT NULL was explicitly specified.</p> <p>USER The default value is the current job user.</p> <p>special-register When column HAS_DEFAULT contains the value 'a', the name of the special register.</p> <p>global-variable When column HAS_DEFAULT contains the value 'c', the qualified name of the global variable.</p> <p>DATA CHANGE OPERATION When column HAS_DEFAULT contains the value 'd'.</p> <p>Contains the null value if:</p> <ul style="list-style-type: none"> The column has no default value. For example, if the column has an IDENTITY attribute, is a row ID, or is a row change timestamp, row begin, row end, or transaction start ID column or A DEFAULT value was not explicitly specified.
IS_NULLABLE	VARCHAR(3)	<p>Indicates whether the column can contain null values:</p> <p>NO The column cannot contain null values.</p> <p>YES The column can contain null values.</p>

Table 244. COLUMNS view (continued)

Column Name	Data Type	Description
DATA_TYPE	VARCHAR(128)	Type of column: BIGINT Big number INTEGER Large number SMALLINT Small number DECIMAL Packed decimal NUMERIC Zoned decimal DOUBLE PRECISION Double-precision floating point REAL Single-precision floating point DECFLOAT Decimal floating-point CHARACTER Fixed-length character string CHARACTER VARYING Varying-length character string CHARACTER LARGE OBJECT Character large object string GRAPHIC Fixed-length graphic string GRAPHIC VARYING Varying-length graphic string DOUBLE-BYTE CHARACTER LARGE OBJECT Double-byte character large object string NATIONAL CHARACTER National character NATIONAL CHARACTER VARYING Varying-length national character NATIONAL CHARACTER LARGE OBJECT National character large object BINARY Fixed-length binary string BINARY VARYING Varying-length binary string BINARY LARGE OBJECT Binary large object string DATE Date TIME Time TIMESTAMP Timestamp DATALINK Datalink ROWID Row ID XML XML USER-DEFINED Distinct type
CHARACTER_MAXIMUM_LENGTH	INTEGER Nullable	Maximum length of the string for binary, character, and graphic string and XML data types. Contains the null value if the column is not a string.
CHARACTER_OCTET_LENGTH	INTEGER Nullable	Number of bytes for binary, character, and graphic string and XML data types. Contains the null value if the column is not a string.

Table 244. COLUMNS view (continued)

Column Name	Data Type	Description
NUMERIC_PRECISION	INTEGER Nullable	The precision of all numeric columns. Note: This column supplies the precision of all numeric data types, including single- and double-precision floating point and decimal floating-point. The NUMERIC_PRECISION_RADIX column indicates if the value in this column is in binary or decimal digits. Contains the null value if the column is not numeric.
NUMERIC_PRECISION_RADIX	INTEGER Nullable	Indicates if the precision specified in column NUMERIC_PRECISION is specified as a number of binary or decimal digits 2 Binary; floating-point precision is specified in binary digits. 10 Decimal; all other numeric types are specified in decimal digits. Contains the null value if the column is not numeric.
NUMERIC_SCALE	INTEGER Nullable	Scale of numeric data. Contains the null value if the column is not decimal, numeric, or binary.
DATETIME_PRECISION	INTEGER Nullable	The fractional part of a date, time, or timestamp. 0 For DATE and TIME data types 0-12 For TIMESTAMP data types (number of fractional seconds). Contains the null value if the column is not a date, time, or timestamp.
INTERVAL_TYPE	VARCHAR(128) Nullable	Reserved. Contains the null value.
INTERVAL_PRECISION	INTEGER Nullable	Reserved. Contains the null value.
CHARACTER_SET_CATALOG	VARCHAR(128) Nullable	Relational database name Contains the null value if the column is not a string.
CHARACTER_SET_SCHEMA	VARCHAR(128) Nullable	The schema name of the character set. Contains SYSIBM. Contains the null value if the column is not a string.
CHARACTER_SET_NAME	VARCHAR(128) Nullable	The character set name. Contains the null value if the column is not a string.
COLLATION_CATALOG	VARCHAR(128) Nullable	Relational database name Contains the null value if the column is not a string.
COLLATION_SCHEMA	VARCHAR(128) Nullable	The schema of the collation. Contains SYSIBM. Contains the null value if the column is not a string.
COLLATION_NAME	VARCHAR(128) Nullable	The collation name. Contains IBMDEFAULT. Contains the null value if the column is not a string.
DOMAIN_CATALOG	VARCHAR(128) Nullable	Reserved. Contains the null value.
DOMAIN_SCHEMA	VARCHAR(128) Nullable	Reserved. Contains the null value.
DOMAIN_NAME	VARCHAR(128) Nullable	Reserved. Contains the null value.
UDT_CATALOG	VARCHAR(128) Nullable	The relational database name if this is a distinct type. Contains the null value if this is not a distinct type.

Table 244. COLUMNS view (continued)

Column Name	Data Type	Description
UDT_SCHEMA	VARCHAR(128) Nullable	The name of the schema if this is a distinct type. Contains the null value if this is not a distinct type.
UDT_NAME	VARCHAR(128) Nullable	The name of the distinct type. Contains the null value if this is not a distinct type.
SCOPE_CATALOG	VARCHAR(128) Nullable	Reserved. Contains the null value.
SCOPE_SCHEMA	VARCHAR(128) Nullable	Reserved. Contains the null value.
SCOPE_NAME	VARCHAR(128) Nullable	Reserved. Contains the null value.
MAXIMUM_CARDINALITY	INTEGER Nullable	Reserved. Contains the null value.
DTD_IDENTIFIER	VARCHAR(128) Nullable	A unique internal identifier for the column.
IS_SELF_REFERENCING	VARCHAR(3)	Reserved. Contains 'NO'.
IS_IDENTITY	VARCHAR(3)	This column identifies whether the column is an identity column. NO The column is not an identity column. YES The column is an identity column.
IDENTITY_GENERATION	VARCHAR(10) Nullable	This column identifies whether the column is GENERATED ALWAYS or GENERATED BY DEFAULT. ALWAYS The column value is always generated. BY DEFAULT The column value is generated by default. Contains the null value if the column is not a ROWID, IDENTITY, or row change timestamp column.
IDENTITY_START	DECIMAL(31,0) Nullable	Starting value of the identity column. Contains the null value if the column is not an IDENTITY column.
IDENTITY_INCREMENT	DECIMAL(31,0) Nullable	Increment value of the identity column. Contains the null value if the column is not an IDENTITY column.
IDENTITY_MAXIMUM	DECIMAL(31,0) Nullable	Maximum value of the identity column. Contains the null value if the column is not an IDENTITY column.
IDENTITY_MINIMUM	DECIMAL(31,0) Nullable	Minimum value of the identity column. Contains the null value if the column is not an IDENTITY column.
IDENTITY_CYCLE	VARCHAR(3) Nullable	This column identifies whether the identity column values will continue to be generated after the minimum or maximum value has been reached. NO Values will not continue to be generated. YES Values will continue to be generated. Contains the null value if the column is not an IDENTITY column.
IS_GENERATED	VARCHAR(5)	Reserved. Contains 'NEVER'.
GENERATION_EXPRESSION	VARCHAR(128) Nullable	Reserved. Contains the null value.

Table 244. COLUMNS view (continued)

Column Name	Data Type	Description
IS_SYSTEM_TIME_PERIOD_START	VARCHAR(3)	This column identifies whether the column is a row begin column. NO The column is not a row begin column. YES The column is a row begin column.
IS_SYSTEM_TIME_PERIOD_END	VARCHAR(3)	This column identifies whether the column is a row end column. NO The column is not a row end column. YES The column is a row end column.
SYSTEM_TIME_PERIOD_TIMESTAMP_GENERATION	VARCHAR(6) Nullable	This column identifies the row begin or row end generation attribute. ALWAYS This column is a row begin or row end column that is GENERATED ALWAYS. Contains the null value if it is not a row begin or row end column.
IS_UPDATABLE	VARCHAR(3)	This column identifies whether the column is updatable. NO The column cannot be updated. YES The column can be updated.
DECLARED_DATA_TYPE	VARCHAR(128) Nullable	Reserved. Contains the null value.
DECLARED_NUMERIC_PRECISION	INTEGER Nullable	Reserved. Contains the null value.
DECLARED_NUMERIC_SCALE	INTEGER Nullable	Reserved. Contains the null value.

INFORMATION_SCHEMA_CATALOG_NAME

The INFORMATION_SCHEMA_CATALOG_NAME view contains one row for the relational database.

The following table describes the columns in the view:

Table 245. INFORMATION_SCHEMA_CATALOG_NAME view

Column Name	Data Type	Description
CATALOG_NAME	VARCHAR(128)	Relational database name

PARAMETERS

The PARAMETERS view contains one row for each parameter of a routine in the relational database.

The following table describes the columns in the view:

Table 246. PARAMETERS view

Column Name	Data Type	Description
SPECIFIC_CATALOG	VARCHAR(128)	Relational database name
SPECIFIC_SCHEMA	VARCHAR(128)	Schema name of the routine instance
SPECIFIC_NAME	VARCHAR(128)	Specific name of the routine instance
ORDINAL_POSITION	INTEGER	Numeric place of the parameter in the parameter list, ordered from left to right.
PARAMETER_MODE	VARCHAR(5)	The type of the parameter: IN This is an input parameter. OUT This is an output parameter. INOUT This is an input/output parameter.
IS_RESULT	VARCHAR(3)	Reserved. Contains 'NO'.
AS_LOCATOR	VARCHAR(3)	Indicates whether the parameter was specified as a locator. NO The parameter was not specified as a locator. YES The parameter was specified as a locator.
PARAMETER_NAME	VARCHAR(128) Nullable	The name of the parameter Contains the null value if the parameter does not have a name.
FROM_SQL_SPECIFIC_CATALOG	VARCHAR(128) Nullable	Reserved. Contains the null value.
FROM_SQL_SPECIFIC_SCHEMA	VARCHAR(128) Nullable	Reserved. Contains the null value.
FROM_SQL_SPECIFIC_NAME	VARCHAR(128) Nullable	Reserved. Contains the null value.
TO_SQL_SPECIFIC_CATALOG	VARCHAR(128) Nullable	Reserved. Contains the null value.
TO_SQL_SPECIFIC_SCHEMA	VARCHAR(128) Nullable	Reserved. Contains the null value.
TO_SQL_SPECIFIC_NAME	VARCHAR(128) Nullable	Reserved. Contains the null value.

Table 246. PARAMETERS view (continued)

Column Name	Data Type	Description
DATA_TYPE	VARCHAR(128) Nullable	Type of the parameter: BIGINT Big number INTEGER Large number SMALLINT Small number DECIMAL Packed decimal NUMERIC Zoned decimal DOUBLE PRECISION Floating point; DOUBLE PRECISION REAL Floating point; REAL DECFLOAT Decimal floating-point CHARACTER Fixed-length character string CHARACTER VARYING Varying-length character string CHARACTER LARGE OBJECT Character large object string GRAPHIC Fixed-length graphic string GRAPHIC VARYING Varying-length graphic string DOUBLE-BYTE CHARACTER LARGE OBJECT Double-byte character large object string NATIONAL CHARACTER National character NATIONAL CHARACTER VARYING Varying-length national character NATIONAL CHARACTER LARGE OBJECT National character large object BINARY Fixed-length binary string BINARY VARYING Varying-length binary string BINARY LARGE OBJECT Binary large object string DATE Date TIME Time TIMESTAMP Timestamp DATALINK Datalink ROWID Row ID XML XML USER-DEFINED Distinct type or array type
CHARACTER_MAXIMUM_LENGTH	INTEGER Nullable	Maximum length of the string for binary, character, and graphic string and XML data types. Contains the null value if the parameter is not a string.
CHARACTER_OCTET_LENGTH	INTEGER Nullable	Number of bytes for binary, character, and graphic string and XML data types. Contains the null value if the parameter is not a string.

Table 246. PARAMETERS view (continued)

Column Name	Data Type	Description
CHARACTER_SET_CATALOG	VARCHAR(128) Nullable	Relational database name Contains the null value if the column is not a string.
CHARACTER_SET_SCHEMA	VARCHAR(128) Nullable	The schema name of the character set. Contains 'SYSIBM'. Contains the null value if the column is not a string.
CHARACTER_SET_NAME	VARCHAR(128) Nullable	The character set name. Contains the null value if the column is not a string.
COLLATION_CATALOG	VARCHAR(128) Nullable	Relational database name Contains the null value if the column is not a string.
COLLATION_SCHEMA	VARCHAR(128) Nullable	The schema of the collation. SYSIBM is returned. Contains the null value if the column is not a string.
COLLATION_NAME	VARCHAR(128) Nullable	The collation name. IBMDEFAULT is returned. Contains the null value if the column is not a string.
NUMERIC_PRECISION	INTEGER Nullable	The precision of all numeric parameters. Note: This column supplies the precision of all numeric data types, including single- and double-precision floating point and decimal floating-point. The NUMERIC_PRECISION_RADIX column indicates if the value in this column is in binary or decimal digits. Contains the null value if the parameter is not numeric.
NUMERIC_PRECISION_RADIX	INTEGER Nullable	Indicates if the precision specified in column NUMERIC_PRECISION is specified as a number of binary or decimal digits: 2 Binary; floating-point precision is specified in binary digits. 10 Decimal; all other numeric types are specified in decimal digits. Contains the null value if the parameter is not numeric.
NUMERIC_SCALE	INTEGER Nullable	Scale of numeric data. Contains the null value if not decimal, numeric, or binary parameter.
DATETIME_PRECISION	INTEGER Nullable	The fractional part of a date, time, or timestamp. 0 For DATE and TIME data types 0-12 For TIMESTAMP data types (number of fractional seconds). Contains the null value if the parameter is not a date, time, or timestamp.
INTERVAL_TYPE	VARCHAR(128) Nullable	Reserved. Contains the null value.
INTERVAL_PRECISION	INTEGER Nullable	Reserved. Contains the null value.
UDT_CATALOG	VARCHAR(128) Nullable	The relational database name if this is a distinct type or array type.. Contains the null value if this is not a distinct type or array type.
UDT_SCHEMA	VARCHAR(128) Nullable	The name of the schema if this is a distinct type or array type. Contains the null value if this is not a distinct type or array type.
UDT_NAME	VARCHAR(128) Nullable	The name of the distinct type or array type. Contains the null value if this is not a distinct type or array type.
SCOPE_CATALOG	VARCHAR(128) Nullable	Reserved. Contains the null value.

Table 246. PARAMETERS view (continued)

Column Name	Data Type	Description
SCOPE_SCHEMA	VARCHAR(128) Nullable	Reserved. Contains the null value.
SCOPE_NAME	VARCHAR(128) Nullable	Reserved. Contains the null value.
MAXIMUM_CARDINALITY	BIGINT Nullable	The maximum cardinality of the array type if this parameter is an array type. Contains the null value if this parameter is not an array type.
DTD_IDENTIFIER	VARCHAR(128) Nullable	A unique internal identifier for the parameter.
DECLARED_DATA_TYPE	VARCHAR(128) Nullable	Reserved. Contains the null value.
DECLARED_NUMERIC_PRECISION	INTEGER Nullable	Reserved. Contains the null value.
DECLARED_NUMERIC_SCALE	INTEGER Nullable	Reserved. Contains the null value.
PARAMETER_DEFAULT	DBCLOB(64K) CCSID 1200 Nullable	The expression string used to calculate the default value of a parameter, if one exists. If the default value is the null value, the expression string is the keyword NULL. Contains the null value if the parameter has no default.

REFERENTIAL_CONSTRAINTS

The REFERENTIAL_CONSTRAINTS view contains one row for each referential constraint.

The following table describes the columns in the view:

Table 247. REFERENTIAL_CONSTRAINTS view

Column Name	Data Type	Description
CONSTRAINT_CATALOG	VARCHAR(128)	Relational database name
CONSTRAINT_SCHEMA	VARCHAR(128)	Name of the schema containing the constraint.
CONSTRAINT_NAME	VARCHAR(128)	Name of the constraint.
UNIQUE_CONSTRAINT_CATALOG	VARCHAR(128)	Relational database name containing the unique constraint referenced by the referential constraint.
UNIQUE_CONSTRAINT_SCHEMA	VARCHAR(128)	Name of the SQL schema containing the unique constraint referenced by the referential constraint.
UNIQUE_CONSTRAINT_NAME	VARCHAR(128)	Name of the unique constraint referenced by the referential constraint.
MATCH_OPTION	VARCHAR(7)	Reserved. Contains 'NONE'.
UPDATE_RULE	VARCHAR(11)	Update Rule. <ul style="list-style-type: none">• NO ACTION• RESTRICT
DELETE_RULE	VARCHAR(11)	Delete Rule <ul style="list-style-type: none">• NO ACTION• CASCADE• SET NULL• SET DEFAULT• RESTRICT
COLUMN_COUNT	INTEGER	Count of columns in the constraint.

ROUTINES

The ROUTINES view contains one row for each routine.

The following table describes the columns in the view:

Table 248. ROUTINES view

Column Name	Data Type	Description
SPECIFIC_CATALOG	VARCHAR(128)	Relational database name
SPECIFIC_SCHEMA	VARCHAR(128)	Schema name of the routine instance.
SPECIFIC_NAME	VARCHAR(128)	Specific name of the routine.
ROUTINE_CATALOG	VARCHAR(128)	Relational database name
ROUTINE_SCHEMA	VARCHAR(128)	Name of the SQL schema that contains the routine.
ROUTINE_NAME	VARCHAR(128)	Name of the routine.
ROUTINE_TYPE	VARCHAR(15)	Type of the routine. PROCEDURE This is a procedure. FUNCTION This is a function. INSTANCE METHOD This is a built-in data type function created for a distinct type.
MODULE_CATALOG	VARCHAR(128) Nullable	Reserved. Contains the null value.
MODULE_SCHEMA	VARCHAR(128) Nullable	Reserved. Contains the null value.
MODULE_NAME	VARCHAR(128) Nullable	Reserved. Contains the null value.
UDT_CATALOG	VARCHAR(128) Nullable	Relational database name. Contains the null value if this is not an INSTANCE METHOD.
UDT_SCHEMA	VARCHAR(128) Nullable	Name of the SQL schema that contains the distinct type related to this function. Contains the null value if this is not an INSTANCE METHOD.
UDT_NAME	VARCHAR(128) Nullable	Name of the distinct type name related to this function. Contains the null value if this is not an INSTANCE METHOD.

Table 248. ROUTINES view (continued)

Column Name	Data Type	Description
DATA_TYPE	VARCHAR(128) Nullable	Type of the result of the function: BIGINT Big number INTEGER Large number SMALLINT Small number DECIMAL Packed decimal NUMERIC Zoned decimal DOUBLE PRECISION Floating point; DOUBLE PRECISION REAL Floating point; REAL DECFLOAT Decimal floating-point CHARACTER Fixed-length character string CHARACTER VARYING Varying-length character string CHARACTER LARGE OBJECT Character large object string GRAPHIC Fixed-length graphic string GRAPHIC VARYING Varying-length graphic string DOUBLE-BYTE CHARACTER LARGE OBJECT Double-byte character large object string NATIONAL CHARACTER National character NATIONAL CHARACTER VARYING Varying-length national character NATIONAL CHARACTER LARGE OBJECT National character large object BINARY Fixed-length binary string BINARY VARYING Varying-length binary string BINARY LARGE OBJECT Binary large object string DATE Date TIME Time TIMESTAMP Timestamp DATALINK Datalink ROWID Row ID XML XML USER-DEFINED Distinct type or Array type Contains the null value if this is not a scalar function.
CHARACTER_MAXIMUM_LENGTH	INTEGER Nullable	Maximum length of the result string of the function for binary, character, and graphic string and XML data types. Contains the null value if this is not a scalar function or the parameter is not a string.

Table 248. ROUTINES view (continued)

Column Name	Data Type	Description
CHARACTER_OCTET_LENGTH	INTEGER Nullable	Number of bytes for the result string of the function for binary, character, and graphic string and XML data types. Contains the null value if this is not a scalar function or the parameter is not a string.
CHARACTER_SET_CATALOG	VARCHAR(128) Nullable	Relational database name of the result of the function. Contains the null value if this is not a scalar function or the result is not a string.
CHARACTER_SET_SCHEMA	VARCHAR(128) Nullable	The schema name of the character set of the result of the function. Contains 'SYSIBM'. Contains the null value if this is not a scalar function or the result is not a string.
CHARACTER_SET_NAME	VARCHAR(128) Nullable	The character set name of the result of the function. Contains the null value if this is not a scalar function or the result is not a string.
COLLATION_CATALOG	VARCHAR(128) Nullable	Relational database name of the result of the function. Contains the null value if this is not a scalar function or the result is not a string.
COLLATION_SCHEMA	VARCHAR(128) Nullable	The schema of the collation of the result of the function. SYSIBM is returned. Contains the null value if this is not a scalar function or the result is not a string.
COLLATION_NAME	VARCHAR(128) Nullable	The collation name of the result of the function. IBMDEFAULT is returned. Contains the null value if this is not a scalar function or the result is not a string.
NUMERIC_PRECISION	INTEGER Nullable	The precision of the result of the function. Note: This column supplies the precision of all numeric data types, including single- and double-precision floating point and decimal floating-point. The NUMERIC_PRECISION_RADIX column indicates if the value in this column is in binary or decimal digits. Contains the null value if this is not a scalar function or the result is not numeric.
NUMERIC_PRECISION_RADIX	INTEGER Nullable	Indicates if the precision specified in column NUMERIC_PRECISION is specified as a number of binary or decimal digits: 2 Binary; floating-point precision is specified in binary digits. 10 Decimal; all other numeric types are specified in decimal digits. Contains the null value if this is not a scalar function or the result is not numeric.
NUMERIC_SCALE	INTEGER Nullable	Scale of numeric result of the function. Contains the null value if this is not a scalar function or the result is not numeric.
DATETIME_PRECISION	INTEGER Nullable	The fractional part of a date, time, or timestamp result of the function. 0 For DATE and TIME data types 0-12 For TIMESTAMP data types (number of fractional seconds). Contains the null value if this is not a scalar function or the result is not a date, time, or timestamp.
INTERVAL_TYPE	VARCHAR(128) Nullable	Reserved. Contains the null value.
INTERVAL_PRECISION	INTEGER Nullable	Reserved. Contains the null value.

Table 248. ROUTINES view (continued)

Column Name	Data Type	Description
TYPE_UDT_CATALOG	VARCHAR(128) Nullable	The relational database name if the result of the function is a distinct type or array type. Contains the null value if this is not a scalar function or the result is not a distinct type or array type.
TYPE_UDT_SCHEMA	VARCHAR(128) Nullable	The name of the schema if the result of the function is a distinct type or array type. Contains the null value if this is not a scalar function or the result is not a distinct type or array type.
TYPE_UDT_NAME	VARCHAR(128) Nullable	The name of the distinct type if the result of the function is a distinct type or array type. Contains the null value if this is not a scalar function or the result is not a distinct type or array type.
SCOPE_CATALOG	VARCHAR(128) Nullable	Reserved. Contains the null value.
SCOPE_SCHEMA	VARCHAR(128) Nullable	Reserved. Contains the null value.
SCOPE_NAME	VARCHAR(128) Nullable	Reserved. Contains the null value.
MAXIMUM_CARDINALITY	BIGINT Nullable	The maximum cardinality of the array type if the result of the function is an array type. Contains the null value if this is not an array type.
DTD_IDENTIFIER	VARCHAR(128) Nullable	A unique internal identifier for the result of the function.
ROUTINE_BODY	VARCHAR(8)	The type of the routine body: EXTERNAL This is an external routine. SQL This is an SQL routine.
ROUTINE_DEFINITION	DBCLOB(2M) CCSID 13488 Nullable	If this is an SQL routine, this column contains the SQL routine body. If this is an obfuscated routine, the text starts with the WRAPPED keyword and is followed by the encoded form of the statement text. Contains the null value if this is not an SQL routine or if the routine body cannot be contained in this column without truncation.
EXTERNAL_NAME	VARCHAR(279) Nullable	If this is an external routine, this column identifies the external program name. <ul style="list-style-type: none"> For REXX, the external program name is <i>schema-name/source-file-name(member-name)</i>. For ILE service programs, the external program name is <i>schema-name/service-program-name(entry-point-name)</i>. For Java programs, the external program name is an optional jar-id followed by a <i>fully-qualified-class-name!method-name</i> or <i>fully-qualified-class-name.method-name</i>. For all other languages, the external program name is <i>schema-name/program-name</i>. Contains the null value if this is a system-generated function or a function sourced on a built-in function.

Table 248. ROUTINES view (continued)

Column Name	Data Type	Description
EXTERNAL_LANGUAGE	VARCHAR(8) Nullable	<p>If this is an external routine, this column identifies the external program's language.</p> <p>C The external program is written in C.</p> <p>C++ The external program is written in C++.</p> <p>CL The external program is written in CL.</p> <p>COBOL The external program is written in COBOL.</p> <p>COBOLLE The external program is written in ILE COBOL.</p> <p>FORTRAN The external program is written in FORTRAN.</p> <p>JAVA The external program is written in JAVA.</p> <p>PLI The external program is written in PL/I.</p> <p>REXX The external program is a REXX procedure.</p> <p>RPG The external program is written in RPG.</p> <p>RPGLE The external program is written in ILE RPG.</p> <p>Contains the null value if this is not an external routine.</p>
PARAMETER_STYLE	VARCHAR(18) Nullable	<p>If this is an external routine, this column identifies the parameter style (calling convention).</p> <p>DB2GENERAL This is the DB2GENERAL calling convention.</p> <p>DB2SQL This is the DB2SQL calling convention.</p> <p>GENERAL This is the GENERAL calling convention.</p> <p>JAVA This is the JAVA calling convention.</p> <p>GENERAL WITH NULLS This is the GENERAL WITH NULLS calling convention.</p> <p>SQL This is the SQL standard calling convention.</p> <p>Contains the null value if this is not an external routine.</p>
IS_DETERMINISTIC	VARCHAR(3)	<p>This column identifies whether the routine is deterministic. That is, whether a call to the routine with the same arguments will always return the same result.</p> <p>NO The routine is not deterministic.</p> <p>YES The routine is deterministic.</p>
SQL_DATA_ACCESS	VARCHAR(17)	<p>This column identifies whether a routine contains SQL and whether it reads or modifies data.</p> <p>NO SQL The routine does not contain any SQL statements.</p> <p>CONTAINS SQL The routine contains SQL statements.</p> <p>READS SQL DATA The routine possibly reads data from a table or view.</p> <p>MODIFIES SQL DATA The routine possibly modifies data in a table or view or issues SQL DDL statements.</p>

Table 248. ROUTINES view (continued)

Column Name	Data Type	Description
IS_NULL_CALL	VARCHAR(3) Nullable	Identifies whether the function needs to be called if an input parameter is the null value. NO This function need not be called if an input parameter is the null value. If this is a scalar function, the result of the function is implicitly null if any of the operands are null. If this is a table function, the result of the function is an empty table if any of the operands are the null value. YES This function must be called even if an input operand is null. Contains the null value if this is not a function.
SQL_PATH	VARCHAR(3483) Nullable	If this is an SQL routine, this column identifies the path. Contains the null value if this is not an SQL routine.
SCHEMA_LEVEL_ROUTINE	VARCHAR(3)	Reserved. Contains 'YES'.
MAX_DYNAMIC_RESULT_SETS	SMALLINT	Identifies the maximum number of result sets returned. 0 indicates that there are no result sets.
IS_USER_DEFINED_CAST	VARCHAR(3) Nullable	Identifies whether the this function is a cast function created when a distinct type was created. NO This function is not a cast function. YES This function is a cast function. Contains the null value if the routine is not a function.
IS_IMPLICITLY_INVOCABLE	VARCHAR(3) Nullable	Identifies whether the this function is a cast function created when a distinct type was created and can be implicitly invoked. NO This function is not a cast function. YES This function is a cast function and can be implicitly invoked. Contains the null value if the routine is not a function.
SECURITY_TYPE	VARCHAR(22) Nullable	Reserved. Contains 'IMPLEMENTATION DEFINED' if this is an external routine. Contains the null value if the routine is not an external routine.
TO_SQL_SPECIFIC_CATALOG	VARCHAR(128) Nullable	Reserved. Contains the null value.
TO_SQL_SPECIFIC_SCHEMA	VARCHAR(128) Nullable	Reserved. Contains the null value.
TO_SQL_SPECIFIC_NAME	VARCHAR(128) Nullable	Reserved. Contains the null value.
AS_LOCATOR	VARCHAR(3) Nullable	Indicates whether the result was specified as a locator. NO The parameter was not specified as a locator. YES The parameter was specified as a locator. Contains the null value if this is not a scalar function.
CREATED	TIMESTAMP	Identifies the timestamp when the routine was created.
LAST_ALTERED	TIMESTAMP Nullable	Timestamp when routine was last altered. Contains null if the routine has never been altered.
NEW_SAVEPOINT_LEVEL	VARCHAR(3) Nullable	Indicates whether the routine starts a new savepoint level. NO A new savepoint level is not started when the procedure is called. YES A new savepoint level is started when the procedure is called.

Table 248. ROUTINES view (continued)

Column Name	Data Type	Description
IS_UDT_DEPENDENT	VARCHAR(3)	Indicates whether the routine is dependent on a UDT. NO The routine is not dependent on a UDT. YES The routine is dependent on a UDT.
RESULT_CAST_FROM_DATA_TYPE	VARCHAR(128) Nullable	Type of the parameter: BIGINT Big number INTEGER Large number SMALLINT Small number DECIMAL Packed decimal NUMERIC Zoned decimal DOUBLE PRECISION Floating point; DOUBLE PRECISION REAL Floating point; REAL DECFLOAT Decimal floating-point CHARACTER Fixed-length character string CHARACTER VARYING Varying-length character string CHARACTER LARGE OBJECT Character large object string GRAPHIC Fixed-length graphic string GRAPHIC VARYING Varying-length graphic string DOUBLE-BYTE CHARACTER LARGE OBJECT Double-byte character large object string NATIONAL CHARACTER National character NATIONAL CHARACTER VARYING Varying-length national character NATIONAL CHARACTER LARGE OBJECT National character large object BINARY Fixed-length binary string BINARY VARYING Varying-length binary string BINARY LARGE OBJECT Binary large object string DATE Date TIME Time TIMESTAMP Timestamp DATALINK Datalink ROWID Row ID XML XML USER-DEFINED Distinct Type

Table 248. ROUTINES view (continued)

Column Name	Data Type	Description
RESULT_CAST_AS_LOCATOR	VARCHAR(3) Nullable	Indicates whether the result is cast from a locator. NO The result is not cast from a locator. YES The result is cast from a locator.
RESULT_CAST_CHAR_MAX_LENGTH	INTEGER Nullable	Maximum length of the string for binary, character, and graphic string and XML data types. Contains the null value if the parameter is not a string.
RESULT_CAST_CHAR_OCTET_LENGTH	INTEGER Nullable	Number of bytes for binary, character, and graphic string and XML data types. Contains the null value if the parameter is not a string.
RESULT_CAST_CHAR_SET_CATALOG	VARCHAR(128) Nullable	Relational database name Contains the null value if the column is not a string.
RESULT_CAST_CHAR_SET_SCHEMA	VARCHAR(128) Nullable	The schema name of the character set. Contains 'SYSIBM'. Contains the null value if the column is not a string.
RESULT_CAST_CHAR_SET_NAME	VARCHAR(128) Nullable	The character set name. Contains the null value if the column is not a string.
RESULT_CAST_COLLATION_CATALOG	VARCHAR(128) Nullable	Relational database name Contains the null value if the column is not a string.
RESULT_CAST_COLLATION_SCHEMA	VARCHAR(128) Nullable	The schema of the collation. SYSIBM is returned. Contains the null value if the column is not a string.
RESULT_CAST_COLLATION_NAME	VARCHAR(128) Nullable	The collation name. IBMDEFAULT is returned. Contains the null value if the column is not a string.
RESULT_CAST_NUMERIC_PRECISION	INTEGER Nullable	The precision of all numeric parameters. Note: This column supplies the precision of all numeric data types, including single- and double-precision floating point and decimal floating-point. The NUMERIC_PRECISION_RADIX column indicates if the value in this column is in binary or decimal digits. Contains the null value if the parameter is not numeric.
RESULT_CAST_NUMERIC_RADIX	INTEGER Nullable	Indicates if the precision specified in column NUMERIC_PRECISION is specified as a number of binary or decimal digits: 2 Binary; floating-point precision is specified in binary digits. 10 Decimal; all other numeric types are specified in decimal digits. Contains the null value if the parameter is not numeric.
RESULT_CAST_NUMERIC_SCALE	INTEGER Nullable	Scale of numeric data. Contains the null value if not decimal, numeric, or binary parameter.
RESULT_CAST_DATETIME_PRECISION	INTEGER Nullable	The fractional part of a date, time, or timestamp. 0 For DATE and TIME data types 0-12 For TIMESTAMP data types (number of fractional seconds). Contains the null value if the parameter is not a date, time, or timestamp.
RESULT_CAST_INTERVAL_TYPE	VARCHAR(128) Nullable	Reserved. Contains the null value.
RESULT_CAST_INTERVAL_PRECISION	INTEGER Nullable	Reserved. Contains the null value.

Table 248. ROUTINES view (continued)

Column Name	Data Type	Description
RESULT_CAST_TYPE_UDT_CATALOG	VARCHAR(128) Nullable	The relational database name if this is a distinct type. Contains the null value if this is not a distinct type.
RESULT_CAST_TYPE_UDT_SCHEMA	VARCHAR(128) Nullable	The name of the schema if this is a distinct type. Contains the null value if this is not a distinct type.
RESULT_CAST_TYPE_UDT_NAME	VARCHAR(128) Nullable	The name of the distinct type Contains the null value if this is not a distinct type.
RESULT_CAST_SCOPE_CATALOG	VARCHAR(128) Nullable	Reserved. Contains the null value.
RESULT_CAST_SCOPE_SCHEMA	VARCHAR(128) Nullable	Reserved. Contains the null value.
RESULT_CAST_SCOPE_NAME	VARCHAR(128) Nullable	Reserved. Contains the null value.
RESULT_CAST_MAX_CARDINALITY	INTEGER Nullable	Reserved. Contains the null value.
RESULT_CAST_DTD_IDENTIFIER	VARCHAR(128) Nullable	A unique internal identifier for the parameter.
DECLARED_DATA_TYPE	VARCHAR(128) Nullable	Reserved. Contains the null value.
DECLARED_NUMERIC_PRECISION	INTEGER Nullable	Reserved. Contains the null value.
DECLARED_NUMERIC_SCALE	INTEGER Nullable	Reserved. Contains the null value.
RESULT_CAST_FROM_DECLARED_DATA_TYPE	VARCHAR(128) Nullable	Reserved. Contains the null value.
RESULT_CAST_DECLARED_NUMERIC_PRECISION	INTEGER Nullable	Reserved. Contains the null value.
RESULT_CAST_DECLARED_NUMERIC_SCALE	INTEGER Nullable	Reserved. Contains the null value.

ROUTINE_PRIVILEGES

The ROUTINE_PRIVILEGES view contains one row for every privilege granted on a routine. Note that this catalog view cannot be used to determine whether a user is authorized to a routine because the privilege to use a routine could be acquired through a group user profile or special authority (such as *ALLOBJ).

The following table describes the columns in the view:

Table 249. ROUTINE_PRIVILEGES view

Column Name	Data Type	Description
GRANTOR	VARCHAR(128) Nullable	Reserved. Contains the null value.
GRANTEE	VARCHAR(128)	The user profile to which the privilege is granted.
SPECIFIC_CATALOG	VARCHAR(128)	Relational database name
SPECIFIC_SCHEMA	VARCHAR(128)	Schema name of the routine instance.
SPECIFIC_NAME	VARCHAR(128)	Specific name of the routine.
ROUTINE_CATALOG	VARCHAR(128)	Relational database name
ROUTINE_SCHEMA	VARCHAR(128)	Name of the SQL schema that contains the routine.
ROUTINE_NAME	VARCHAR(128)	Name of the routine.
PRIVILEGE_TYPE	VARCHAR(10)	The privilege granted: ALTER The privilege to alter the routine. EXECUTE The privilege to execute the routine.
IS_GRANTABLE	VARCHAR(3)	Indicates whether the privilege is grantable to other users. NO The privilege is not grantable. YES The privilege is grantable.

SCHEMATA

The SCHEMATA view contains one row for each schema.

The following table describes the columns in the view:

Table 250. SCHEMATA view

Column Name	Data Type	Description
CATALOG_NAME	VARCHAR(128)	Relational database name
SCHEMA_NAME	VARCHAR(128)	Name of the schema
SCHEMA_OWNER	VARCHAR(128)	Owner of the schema
DEFAULT_CHARACTER_SET_CATALOG	VARCHAR(128)	Relational database name
DEFAULT_CHARACTER_SET_SCHEMA	VARCHAR(128)	The schema name of the default character set. Contains 'SYSIBM'.
DEFAULT_CHARACTER_SET_NAME	VARCHAR(128)	The default character set name.
SQL_PATH	VARCHAR(4096)	Reserved. Contains the null value.
	Nullable	

SEQUENCES

The SEQUENCES view contains one row for each sequence.

The following table describes the columns in the view:

Table 251. SEQUENCES view

Column Name	Data Type	Description
SEQUENCE_CATALOG	VARCHAR(128)	Relational database name
SEQUENCE_SCHEMA	VARCHAR(128)	SQL schema that contains the sequence
SEQUENCE_NAME	VARCHAR(128)	Name of the sequence
DATA_TYPE	VARCHAR(128)	Type of the sequence
NUMERIC_PRECISION	INTEGER	The precision of the sequence type
NUMERIC_PRECISION_RADIX	INTEGER	Indicates if the precision specified in column NUMERIC_PRECISION is specified as a number of binary or decimal digits: 10 All sequence data types are specified in decimal digits.
NUMERIC_SCALE	INTEGER	All sequence data types use 0 scale
START_VALUE	DECIMAL(63,0)	Starting value of the sequence
MINIMUM_VALUE	DECIMAL(63,0)	Minimum value of the sequence
MAXIMUM_VALUE	DECIMAL(63,0)	Maximum value of the sequence
INCREMENT	INTEGER	Increment value of the sequence
CYCLE_OPTION	VARCHAR(3)	Identifies whether the sequence values will continue to be generated after the minimum or maximum value has been reached. NO Values will not continue to be generated YES Values will continue to be generated
DECLARED_DATA_TYPE	VARCHAR(128) Nullable	Reserved. Contains the null value.
DECLARED_NUMERIC_PRECISION	INTEGER Nullable	Reserved. Contains the null value.
DECLARED_NUMERIC_SCALE	INTEGER Nullable	Reserved. Contains the null value.

SQL_FEATURES

The SQL_FEATURES table contains one row for each feature supported by the database manager.

The following table describes the columns in the table:

Table 252. SQL_FEATURES table

Column Name	Data Type	Description
FEATURE_ID	VARCHAR(7) Nullable	ANS and ISO feature ID
FEATURE_NAME	VARCHAR(128)	The name of the ANS and ISO feature.
SUB_FEATURE_ID	VARCHAR(7) Nullable	ANS and ISO subfeature ID
SUB_FEATURE_NAME	VARCHAR(256)	The name of the ANS and ISO subfeature.
IS_SUPPORTED	VARCHAR(3)	Indicates whether the feature is supported: YES This feature is supported. NO This feature is not supported.
IS_VERIFIED_BY	VARCHAR(128) Nullable	Reserved. Contains the null value.
COMMENTS	VARCHAR(2000) Nullable	Reserved. Contains the null value.

SQL_LANGUAGES

The SQL_LANGUAGES table contains one row for every SQL language binding and programming language for which conformance is claimed.

The following table describes the columns in the SQL_LANGUAGES table:

Table 253. SQL_LANGUAGES table

Column Name	Data Type	Description
SQL_LANGUAGE_SOURCE	VARCHAR(254)	Name of the standard.
SQL_LANGUAGE_YEAR	VARCHAR(254)	Year in which the standard was approved.
SQL_LANGUAGE_CONFORMANCE	VARCHAR(254) Nullable	Level of conformance. 2 For the 1987 and 1989 standards, indicates that Level 2 conformance is claimed. ENTRY For the 1992 standard, indicates that Entry Level conformance is claimed. CORE For the 1999 standard, indicates that Core Level is conformance is claimed. Contains the null value if conformance is not yet claimed.
SQL_LANGUAGE_INTEGRITY	VARCHAR(254) Nullable	Support of the integrity feature. YES conformance is claimed to the integrity feature NO conformance is not claimed to the integrity feature Contains the null value if the standard does not have a separate integrity feature.
SQL_LANGUAGE_IMPLEMENTATION	VARCHAR(254) Nullable	Reserved. Contains the null value.
SQL_LANGUAGE_BINDING_STYLE	VARCHAR(254)	The style of binding of the SQL language EMBEDDED support for embedded SQL for the language in SQL_LANGUAGE_PROGRAMMING_LANG DIRECT DIRECT SQL is supported (for example Interactive SQL) CLI Support for CLI for the language in SQL_LANGUAGE_PROGRAMMING_LANG
SQL_LANGUAGE_PROGRAMMING_LANG	VARCHAR(254) Nullable	The language supported by EMBEDDED or CLI. C The C language is supported. COBOL The COBOL language is supported. PLI The PL/I language is supported. Contains the null value if the SQL_LANGUAGE_BINDING_STYLE is DIRECT.

SQL_SIZING

The SQL_SIZING table contains one row for each limit supported by the database manager.

The following table describes the columns in the table:

Table 254. SQL_SIZING table

Column Name	Data Type	Description
SIZING_ID	INTEGER	ANS and ISO sizing ID
SIZING_NAME	VARCHAR(128)	Name of the ANS and ISO sizing.
SUPPORTED_VALUE	DECIMAL(21) Nullable	Indicates the sizing limit. Contains the null value if the sizing limit is not applicable.
COMMENTS	VARCHAR(2000) Nullable	Reserved. Contains the null value.

TABLE_CONSTRAINTS

The TABLE_CONSTRAINTS view contains one row for each constraint.

The following table describes the columns in the view:

Table 255. TABLE_CONSTRAINTS view

Column Name	Data Type	Description
CONSTRAINT_CATALOG	VARCHAR(128)	Relational database name
CONSTRAINT_SCHEMA	VARCHAR(128)	Name of the schema containing the constraint.
CONSTRAINT_NAME	VARCHAR(128)	Name of the constraint.
TABLE_CATALOG	VARCHAR(128)	Relational database name
TABLE_SCHEMA	VARCHAR(128)	Name of the schema containing the table.
TABLE_NAME	VARCHAR(128)	Name of the table which the constraint is created over.
CONSTRAINT_TYPE	VARCHAR(11)	Constraint Type <ul style="list-style-type: none">• CHECK• UNIQUE• PRIMARY KEY• FOREIGN KEY
IS_DEFERRABLE	VARCHAR(3)	Indicates whether the constraint checking can be deferred. Contains 'NO'.
INITIALLY_DEFERRED	VARCHAR(3)	Indicates whether the constraint was defined as initially deferred. Contains 'NO'.

TABLE_PRIVILEGES

The TABLE_PRIVILEGES view contains one row for every privilege granted on a table. Note that this catalog view cannot be used to determine whether a user is authorized to a table because the privilege to use a table could be acquired through a group user profile or special authority (such as *ALLOBJ).

The following table describes the columns in the view:

Table 256. TABLE_PRIVILEGES view

Column Name	Data Type	Description
GRANTOR	VARCHAR(128) Nullable	Reserved. Contains the null value.
GRANTEE	VARCHAR(128)	The user profile to which the privilege is granted.
TABLE_CATALOG	VARCHAR(128)	Relational database name
TABLE_SCHEMA	VARCHAR(128)	Name of the SQL schema that contains the table.
TABLE_NAME	VARCHAR(128)	Name of the table.
PRIVILEGE_TYPE	VARCHAR(10)	The privilege granted: ALTER The privilege to alter the table. DELETE The privilege to delete rows from the table. INDEX The privilege to create an index on the table. INSERT The privilege to insert rows into the table. REFERENCES The privilege to reference the table in a referential constraint. SELECT The privilege to select rows from the table. UPDATE The privilege to update the table.
IS_GRANTABLE	VARCHAR(3)	Indicates whether the privilege is grantable to other users. NO The privilege is not grantable. YES The privilege is grantable.

TABLES

The TABLES view contains one row for each table, view, and alias.

The following table describes the columns in the view:

Table 257. TABLES view

Column Name	Data Type	Description
TABLE_CATALOG	VARCHAR(128)	Relational database name
TABLE_SCHEMA	VARCHAR(128)	Name of the SQL schema that contains the table, view or alias.
TABLE_NAME	VARCHAR(128)	Name of the table, view or alias.
TABLE_TYPE	VARCHAR(24)	Indicates the type of the table: ALIAS The table is an alias. BASE TABLE The table is an SQL table or physical file. MATERIALIZED QUERY TABLE The object is a materialized query table. VIEW The table is an SQL view or logical file.
SELF_REFERENCING_COLUMN_NAME	VARCHAR(128) Nullable	Reserved. Contains the null value.
REFERENCE_GENERATION	VARCHAR(128) Nullable	Reserved. Contains the null value.
USER_DEFINED_TYPE_CATALOG	VARCHAR(128) Nullable	Reserved. Contains the null value.
USER_DEFINED_TYPE_SCHEMA	VARCHAR(128) Nullable	Reserved. Contains the null value.
USER_DEFINED_TYPE_NAME	VARCHAR(128) Nullable	Reserved. Contains the null value.
IS_INSERTABLE_INTO	VARCHAR(3)	Identifies whether an INSERT is allowed on the table. NO An INSERT is not allowed on this table. YES An INSERT is allowed on this table.

UDT_PRIVILEGES

The UDT_PRIVILEGES view contains one row for every privilege granted on a type. Note that this catalog view cannot be used to determine whether a user is authorized to a type because the privilege to use a type could be acquired through a group user profile or special authority (such as *ALLOBJ).

The following table describes the columns in the view:

Table 258. UDT_PRIVILEGES view

Column Name	Data Type	Description
GRANTOR	VARCHAR(128) Nullable	Reserved. Contains the null value.
GRANTEE	VARCHAR(128)	The user profile to which the privilege is granted.
UDT_CATALOG	VARCHAR(128)	Relational database name
UDT_SCHEMA	VARCHAR(128)	Name of the SQL schema that contains the type.
UDT_NAME	VARCHAR(128)	Name of the type.
PRIVILEGE_TYPE	VARCHAR(10)	The privilege granted: ALTER The privilege to alter the type. USAGE The privilege to use the type.
IS_GRANTABLE	VARCHAR(3)	Indicates whether the privilege is grantable to other users. NO The privilege is not grantable. YES The privilege is grantable.

USAGE_PRIVILEGES

The USAGE_PRIVILEGES view contains one row for every privilege granted on a sequence or XML schema. Note that this catalog view cannot be used to determine whether a user is authorized to a sequence or XML schema because the privilege to use a sequence or XML schema could be acquired through a group user profile or special authority (such as *ALLOBJ).

The following table describes the columns in the view:

Table 259. USAGE_PRIVILEGES view

Column Name	Data Type	Description
GRANTOR	VARCHAR(128) Nullable	Reserved. Contains the null value.
GRANTEE	VARCHAR(128)	The user profile to which the privilege is granted.
OBJECT_CATALOG	VARCHAR(128)	Relational database name
OBJECT_SCHEMA	VARCHAR(128)	Name of the SQL schema that contains the object.
OBJECT_NAME	VARCHAR(128)	Name of the object.
OBJECT_TYPE	VARCHAR(10)	The type of the object: SEQUENCE The object is a sequence. XML SCHEMA The object is an XML schema.
PRIVILEGE_TYPE	VARCHAR(10)	The privilege granted: ALTER The privilege to alter the sequence or XML schema. USAGE The privilege to use the sequence or XML schema.
IS_GRANTABLE	VARCHAR(3)	Indicates whether the privilege is grantable to other users. NO The privilege is not grantable. YES The privilege is grantable.

USER_DEFINED_TYPES

The USER_DEFINED_TYPES view contains one row for each distinct type.

The following table describes the columns in the view¹⁶²:

Table 260. USER_DEFINED_TYPES view

Column Name	Data Type	Description
USER_DEFINED_TYPE_CATALOG	VARCHAR(128)	Relational database name
USER_DEFINED_TYPE_SCHEMA	VARCHAR(128)	Schema name of the distinct type
USER_DEFINED_TYPE_NAME	VARCHAR(128)	Name of the user that created the distinct type.
USER_DEFINED_TYPE_CATEGORY	VARCHAR(128)	Indicates the type of user-defined type. Contains 'DISTINCT'.
IS_INSTANTIABLE	VARCHAR(3)	Reserved. Contains 'YES'.
IS_FINAL	VARCHAR(3)	Reserved. Contains 'YES'.
ORDERING_FORM	VARCHAR(4)	Indicates what kind of predicates are allowed when this distinct type is a comparand: FULL All predicates are allowed. NONE No predicates are allowed
ORDERING_CATEGORY	VARCHAR(8)	Reserved. Contains 'MAP'.
ORDERING_ROUTINE_CATALOG	VARCHAR(128) Nullable	Relational database name Contains the null value if the ORDERING_FORM is 'NONE'.
ORDERING_ROUTINE_SCHEMA	VARCHAR(128) Nullable	Reserved. Contains 'SYSIBM'. Contains the null value if the ORDERING_FORM is 'NONE'.
ORDERING_ROUTINE_NAME	VARCHAR(128) Nullable	Reserved. Contains a data type name. Contains the null value if the ORDERING_FORM is 'NONE'.
REFERENCE_TYPE	VARCHAR(16) Nullable	Reserved. Contains the null value.

¹⁶² This view does not contain information about built-in data types.

Table 260. USER_DEFINED_TYPES view (continued)

Column Name	Data Type	Description
DATA_TYPE	VARCHAR(128) Nullable	Source data type of the distinct type: BIGINT Big number INTEGER Large number SMALLINT Small number DECIMAL Packed decimal NUMERIC Zoned decimal DOUBLE PRECISION Floating point; DOUBLE PRECISION REAL Floating point; REAL DECFLOAT Decimal floating-point CHARACTER Fixed-length character string CHARACTER VARYING Varying-length character string CHARACTER LARGE OBJECT Character large object string GRAPHIC Fixed-length graphic string GRAPHIC VARYING Varying-length graphic string DOUBLE-BYTE CHARACTER LARGE OBJECT Double-byte character large object string NATIONAL CHARACTER National character NATIONAL CHARACTER VARYING Varying-length national character NATIONAL CHARACTER LARGE OBJECT National character large object BINARY Fixed-length binary string BINARY VARYING Varying-length binary string BINARY LARGE OBJECT Binary large object string DATE Date TIME Time TIMESTAMP Timestamp DATALINK Datalink ROWID Row ID XML XML USER-DEFINED Distinct Type
CHARACTER_MAXIMUM_LENGTH	INTEGER Nullable	Maximum length of the distinct type for binary, character, and graphic string and XML data types. Contains the null value if the distinct type is not a string.
CHARACTER_OCTET_LENGTH	INTEGER Nullable	Number of bytes of the distinct type for binary, character, and graphic string and XML data types. Contains the null value if the distinct type is not a string.

Table 260. USER_DEFINED_TYPES view (continued)

Column Name	Data Type	Description
CHARACTER_SET_CATALOG	VARCHAR(128) Nullable	Relational database name of the distinct type. Contains the null value if the distinct type is not a string.
CHARACTER_SET_SCHEMA	VARCHAR(128) Nullable	The schema name of the character set of the distinct type. Contains 'SYSIBM'. Contains the null value if the distinct type is not a string.
CHARACTER_SET_NAME	VARCHAR(128) Nullable	The character set name of the distinct type. Contains the null value if the distinct type is not a string.
COLLATION_CATALOG	VARCHAR(128) Nullable	Relational database name of the distinct type. Contains the null value if the distinct type is not a string.
COLLATION_SCHEMA	VARCHAR(128) Nullable	The schema of the collation of the distinct type. SYSIBM is returned. Contains the null value if the distinct type is not a string.
COLLATION_NAME	VARCHAR(128) Nullable	The collation name of the distinct type. IBMDEFAULT is returned. Contains the null value if the distinct type is not a string.
NUMERIC_PRECISION	INTEGER Nullable	The precision of the distinct type. Note: This column supplies the precision of all numeric data types, including single- and double-precision floating point and decimal floating-point. The NUMERIC_PRECISION_RADIX column indicates if the value in this column is in binary or decimal digits. Contains the null value if the distinct type is not numeric.
NUMERIC_PRECISION_RADIX	INTEGER Nullable	Indicates if the precision specified in column NUMERIC_PRECISION is specified as a number of binary or decimal digits: 2 Binary; floating-point precision is specified in binary digits. 10 Decimal; all other numeric types are specified in decimal digits. Contains the null value if the distinct type is not numeric.
NUMERIC_SCALE	SMALLINT Nullable	Scale of numeric distinct type. Contains the null value if the distinct type is not decimal, numeric, or binary.
DATETIME_PRECISION	INTEGER Nullable	The fractional part of a date, time, or timestamp distinct type. 0 For DATE and TIME data types 0-12 For TIMESTAMP data types (number of fractional seconds). Contains the null value if the distinct type is not date, time, or timestamp.
INTERVAL_TYPE	VARCHAR(128) Nullable	Reserved. Contains the null value.
INTERVAL_PRECISION	INTEGER Nullable	Reserved. Contains the null value.
SOURCE_DTD_IDENTIFIER	VARCHAR(128) Nullable	A unique internal identifier for the source data type. Contains the null value if the distinct type is not sourced on another distinct type.
REF_DTD_IDENTIFIER	VARCHAR(256) Nullable	Reserved. Contains the null value.
DECLARED_DATA_TYPE	VARCHAR(128) Nullable	Reserved. Contains the null value.
DECLARED_NUMERIC_PRECISION	INTEGER Nullable	Reserved. Contains the null value.

Table 260. USER_DEFINED_TYPES view (continued)

Column Name	Data Type	Description
DECLARED_NUMERIC_SCALE	INTEGER Nullable	Reserved. Contains the null value.
MAXIMUM_CARDINALITY	BIGINT Nullable	The maximum cardinality of the array data type. Contains the null value if the type is not an array type.

VARIABLE_PRIVILEGES

The VARIABLE_PRIVILEGES view contains one row for every privilege granted on a global variable. Note that this catalog view cannot be used to determine whether a user is authorized to a global variable because the privilege to use a global variable could be acquired through a group user profile or special authority (such as *ALLOBJ).

The following table describes the columns in the view:

Table 261. VARIABLE_PRIVILEGES view

Column Name	Data Type	Description
GRANTOR	VARCHAR(128) Nullable	Reserved. Contains the null value.
GRANTEE	VARCHAR(128)	The user profile to which the privilege is granted.
VARIABLE_CATALOG	VARCHAR(128)	Relational database name
VARIABLE_SCHEMA	VARCHAR(128)	Name of the SQL schema that contains the global variable.
VARIABLE_NAME	VARCHAR(128)	Name of the global variable.
PRIVILEGE_TYPE	VARCHAR(10)	The privilege granted: ALTER The privilege to alter the global variable. READ The privilege to read the value of the global variable. WRITE The privilege to assign a value to the global variable.
IS_GRANTABLE	VARCHAR(3)	Indicates whether the privilege is grantable to other users. NO The privilege is not grantable. YES The privilege is grantable.

VIEWS

The VIEWS view contains one row for each view.

The following table describes the columns in the view:

Table 262. VIEWS view

Column Name	Data Type	Description
TABLE_CATALOG	VARCHAR(128)	Relational database name
TABLE_SCHEMA	VARCHAR(128)	Name of the SQL schema that contains the view.
TABLE_NAME	VARCHAR(128)	Name of the view.
VIEW_DEFINITION	DBCLOB(2M) CCSID 13488 Nullable	The query expression portion of the CREATE VIEW statement.
CHECK_OPTION	VARCHAR(8)	The check option used on the view NONE No check option was specified LOCAL The local option was specified CASCADED The cascaded option was specified
IS_UPDATABLE	VARCHAR(3)	Specifies if the view is updatable: YES The view is updatable NO The view is read-only

Appendix G. Text search argument syntax

A text search argument is specified when searching for terms in text documents. It consists of search parameters and one or more search terms. The SQL scalar text search functions that use text search arguments are CONTAINS and SCORE.

For information on CONTAINS and SCORE, see [“CONTAINS” on page 340](#) and [“SCORE” on page 560](#).

For more information on text search, see [OmniFind Text Search Server for DB2 for i](#)

Syntax

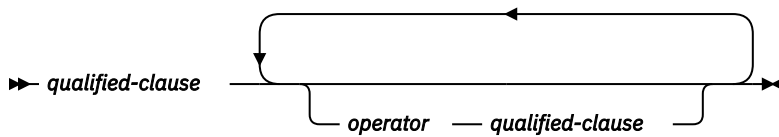

operator

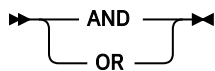

qualified-clause

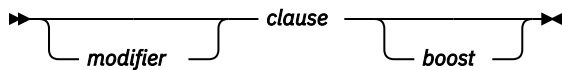

modifier

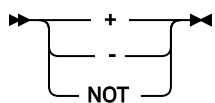

clause

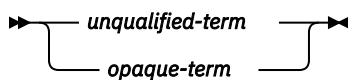

boost

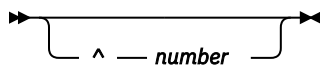

Description

A search argument is a term or sequence of terms, separated by white space, specified when searching in text documents. It consists of one or more search terms and various optional search parameters.

To perform a simple search, you can enter one or more terms. The search engine returns documents that contain all of those terms or variations of those terms. For example, if you perform a search on the term *king*, documents containing *king* are returned. By default, the search engine also returns variants of the search term. Thus, documents containing *kings* are also returned. Similarly, when you search on two terms, the search engine returns documents containing both terms. If you want the terms to be searched as an exact phrase, simply add quotation marks.

The more specific the search term you use, the more precise the results. However, you may also want to refine your searches by using one or more of the following options:

operator

Specifies whether the search for either or both *qualified clauses* on either side of the *operator* must be satisfied.

AND

The search for both *qualified clauses* on either side of the *operator* must be satisfied.

OR

The search for at least one of the *qualified clauses* on either side of the *operator* must be satisfied.

Similar to search conditions in SQL, parentheses can be used to determine which *qualified clauses* and *operators* are evaluated first. If parentheses are not specified, AND is applied before OR.

modifier

Each *clause* can have an occurrence modifier. If a *modifier* is not specified for a *clause*, the default is plus (+).

+

The *clause* is required in the document.

- or NOT

The *clause* must not be specified in the document.

?

The *clause* is optional in the document.

clause

Specifies a search string. In the search string, the question mark and asterisk have special meanings. Use a question mark (?) to represent any single character, and an asterisk (*) to represent a string of zero or more characters. If the search string contains multiple words that should be treated as a phrase, include quotation marks (") around the search string. Blanks within a *clause* are ignored.

unqualified-term

An unqualified term is simply a term or a phrase. A term can be a word, such as king; an exact word, such as "king"; or a word that includes a question mark (?) to represent any single character, and an asterisk (*) to represent a string of zero or more characters, such as king* or king?.

Similarly, a phrase can be a group of words, such as cabbages and kings; an exact phrase, such as "The King and I"; or a phrase that includes a wildcard, such as "all the king's ho*s'es" or "all the king's ?".

If a character in *clause* is one of the characters that has a special meaning in the syntax of the search argument, an escape character (\) can be used to indicate that the subsequent character should be treated as a regular character in the *clause*.

opaque-term

An opaque query term is so called because it is not parsed by the linguistic query parser; opaque terms are identified by their syntax. The opaque term used for text search queries that include XML markup is @xmlxp,, for example: @xmlxp:!/TagA/TagB[. contains("king")]'

boost

boost can be specified for each *clause*. *boost* provides a higher or lower importance to occurrences of the *clause*.

number

Specifies a decimal or integer constant that is greater than 0. If *boost* is not specified for a *clause*, the default boost value is 1.

Notes

Case sensitivity: Searches are not case sensitive, so a search in Spanish for the exact term "DOS" could return documents containing DOS or dos.

Examples: Simple text search

The CONTAINS and SCORE functions can be used to perform a simple text search for a single word or multiple words in a text search index.

The search engine ignores white space between characters. An empty search argument, or one that contains only blanks, does not match anything.

The following table shows some examples of simple text search requests.

Table 263. Simple text search examples

Search word types	Examples	Search results
Single word	king	Returns all documents that contain the word king or kings. The search is not case-sensitive.
Multiple words	king lear	Returns all documents that contain king and lear. The default operator is the logical operator AND.

The operators AND and + (plus sign) are implicit in every text search. For example, the text search for King Lear returns the same results as King AND Lear or King + Lear.

You must enter the logical operators NOT, AND, and OR in all uppercase.

Advanced text search operators

You can use advanced text search operators to refine the search results for the CONTAINS function and the SCORE function.

In the following table, the first column describes the operator that you can use in a text search. (You must enter the logical operators NOT, AND, and OR in all uppercase letters.) The second column shows a sample text search that you might enter. The third column describes the types of results that you might see from the example text search.

Table 264. Advanced search operators and complex text search examples

Operators	Examples	Search results
AND	"King Lear" AND "Othello" "King Lear" "Othello"	Either text search returns documents that contain both terms King Lear and Othello. The AND operator is the default conjunction operator. If no logical operator is between the two terms, the AND operator is used. For example, the text search King Lear is the same as the text search King AND Lear.
OR	"King Lear" OR Lear	Returns documents that contain either King Lear or just Lear. The OR operator links the two terms and finds a matching document if either of the terms exist in a document.
NOT	"King Lear" NOT "Norman Lear"	Returns documents that contain King Lear but not Norman Lear. The NOT operator cannot be used with only one term. For example, the following search will return no results: NOT "King Lear".
" " (Exact match)	First text search: "King Lear" Second text search: "king"	The first text search returns the exact phrase King Lear. The second text search returns only the word king and no other forms, such as kings or kingly.

Table 264. Advanced search operators and complex text search examples (continued)

Operators	Examples	Search results
* (Wildcard character)	<pre>test* te*t</pre>	Returns documents that can match possible combinations, such as test, tests, and tester, or test and text.
? (Wildcard character)	<pre>test? te?t</pre>	Returns documents that can match possible combinations, such as tests, or test and text.
^ (Score boost factor) <i>some word or phrase^number</i>	<p>First text search:</p> <pre>"King Lear"^4 "Richard III"</pre> <p>Second text search:</p> <pre>title: (software download)^5 pdf viewer -shipping</pre>	<p>The first text search forces documents with the phrase King Lear to appear higher in the list of search results.</p> <p>The second text search forces a document titled software download to appear higher in the list of results.</p> <p>Although a boost factor must be positive, the boost factor can be less than 1. For example, 0.2. The boost factor number has no limit.</p>
+ (Includes)	<pre>+Lear King</pre>	Returns all documents that contain Lear and King, which is the same as the text search Lear AND King.
- (Excludes)	<pre>"King Lear" -"Lear Jet"</pre>	Returns documents that contain King Lear but not Lear Jet.
()	<pre>(King OR Lear) AND plays</pre>	Returns documents that contain either King or Lear and plays. The parentheses ensure that plays is found and either term King or Lear is present.
\ (Escape character)	<pre>\(1+1\) :2</pre>	Returns documents that contain (1+1) :2. Use the \ to clear special characters that are part of the text search syntax. Special characters are + - && ! () { } [] ^ " * ? : \. If a special character is cleared, the special character is analyzed as part of the text search.

Example: Using the CONTAINS function and SCORE function

You can use the CONTAINS function or the SCORE function in the same query to search a text search index and to return if and how frequently the text document matches the search argument criteria.

The example in the following table uses data from the base table BOOKS with the columns ISBN (VARCHAR(20)), ABSTRACT (VARCHAR(10000)), and PRICE (INTEGER).

Table 265. The base table BOOKS

ISBN	ABSTRACT	PRICE
i1	"a b c"	7
i2	"a b d"	10
i3	"a e a"	8

You run the following query:

```
SELECT ISBN, SCORE(ABSTRACT, ' "b" ')  
FROM BOOKS  
WHERE CONTAINS (ABSTRACT, ' "b" ') = 1
```

This query returns the following two rows:

```
i1,    0.3  
i3,    0.4
```

The score values might differ depending on the content of the text column.

XML text search

Based on a subset of the XPath language with extensions for text search, XML text search allows you to index and search XML documents so that structural elements can be used separately or can be combined with free text in queries.

Structural elements are tag names, attribute names, and attribute values.

The following list highlights the key features of XML search:

XML structural search

By including special opaque terms in queries, you can search XML documents for structural elements (tag names, attribute names, and attribute values) and text that is scoped by those elements.

XML query tokenization

Free text in XML query terms is tokenized the same way that text in non-XML query terms is tokenized, except that (nested) opaque terms are not supported. Synonyms, wildcard characters, phrases, and lemmatization are supported.

Numeric values

Predicates that compare attribute values to number, date, or dateTime data types are supported.

Complete match

The = (equal sign) operator with a string argument in a predicate calls for an exact match of all tokens in the string with all tokens in the identified text span. The order is NOT significant.

No UIMA access

Unstructured Information Management Architecture (UIMA) is used for tokenization in XML search, but user-written annotators are not supported.

XML text search grammar

A subset of the XPath language, which is defined by an Extended Backus-Naur Form (EBNF) grammar, is supported by the XML search query parser. Queries that do not conform to the supported grammar are rejected by the query parser, which throws an exception.

The EBNF grammar has been simplified in the following ways by:

- Removing the largest-scale structures for specifying iteration and ranges
- Eliminating filter expressions
- Disallowing absolute pathnames in predicate expressions
- Recognizing only one axis (tag) and only in the forward direction

The following table shows the supported grammar in EBNF notation.

Symbol	Production
XMLQuery ::=	QueryPrefix NameSpaceDeclaration QueryString QueryPrefix QueryString
QueryPrefix ::=	@xmlxp:
QueryString ::=	" " PathExpr " "
PathExpr ::=	RelativePathExpr "/" RelativePathExpr? "//" RelativePathExpr

Table 266. Supported query grammar in EBNF notation (continued)	
RelativePathExpr ::=	StepExpr (("/" "//") StepExpr)*
StepExpr ::=	("." AbbrevForwardStep) Predicate?
AbbrevForwardStep ::=	"@"? (QName "*")
Predicate ::=	"[" PredicateExpr "]"
PredicateExpr ::=	Expr PredicateExpr ("and" "or") "(" PredicateExpr ")"
Expr ::=	ComparisonExpr ContainmentExpr
ComparisonExpr ::=	PathExpr ComparisonOp Literal
ComparisonOp ::=	"=" "<" ">" "!=" "<=" ">="
Literal ::=	StringLiteral NumericLiteral DateLiteral
ContainmentExpr ::=	PathExpr "contains" "(" StringLiteral)" PathExpr "excludes" "(" StringLiteral)"
StringLiteral ::=	"\" [^"]* \"\ \"\" [^']* \"\"
DateLiteral ::=	"xs:date(\"\" xmlDate \"\")" "xs:dateTime(\"\" xmlDateTime \"\")"
xmlDate ::=	yyyy "-" mm "-" dd
xmlDateTime ::=	yyyy "-" mm "-" dd [T] hh ":" mm ":" ss "." uuuuuu
NameSpaceDeclaration ::=	defaultNameSpace (NameSpacePrefixDeclaration)*
defaultNameSpace ::=	"declare default element namespace " StringLiteral ";"
NameSpacePrefixDeclaration ::=	"declare namespace" NameSpacePrefix "=" StringLiteral ";"
NameSpacePrefix ::=	[^":]+

For more information about QName, see <http://www.w3.org/TR/REC-xml-names/#NT-QName>.

The following information about XML search queries that use XPath notation might not be obvious from the EBNF grammar notations:

- **Names not normalized:** XML tag and attribute names are not normalized when they are indexed. The names are not changed to lowercase or modified in any way. Case is significant in XML tag and attribute names to get a match. Therefore, the strings that are used for XML tag and attribute names in queries must match exactly the names that appear in the source documents.
- **Free text normalization:** Free text in XML documents (text between tags, not inside a tag itself) and attribute values are normalized before indexing. Text in XML search queries (in *contains* or *excludes* operators, or in strings that are surrounded by quotation marks) is normalized, too. Features such as phrases, synonyms, wildcard characters, and lemmas are supported.
- **Operator precedence:** In XML search predicates, containment operators and comparison operators take precedence over logical operators, and all logical operators have the same precedence.

Containment operators are *contains* and *excludes*. Comparison operators are =, !=, <, >, <= and >=. Logical operators are "and" and "or." You can use parentheses to ensure the desired precedence.

- **Semantics:** In XML search predicates, the comparison operators can be applied only to attribute values and not to tags.

Examples: XPath text search

All valid XPath queries that are sent to the XML parser must be written in a subset of the XPath language using opaque terms. Opaque terms are not parsed by the linguistic text search parser.

The text search parser recognizes an opaque term by the syntax that is used in the text search. For example:

```
@xpath: 'query'
```

where *query* is the text shown in the examples in the following table.

Table 267. Examples of valid XPath queries

Query	Description
/sentences	Any document with a top-level tag called <i>sentences</i> .
//sentences	Any document with a tag at any level called <i>sentences</i> .
/sentence/paragraph	Any document with a top-level tag <i>sentence</i> having a direct child tag <i>paragraph</i> .
/sentence/paragraph/	Any document with a top-level tag <i>sentence</i> having a direct child tag <i>paragraph</i> .
/book/@author	Any document with a top-level <i>book</i> tag having an attribute <i>author</i> .
/book//@author	Any document with a top-level <i>book</i> tag having a descendant tag at any level with the attribute <i>author</i> .
/book[@author contains("barnes") and @title = "the lemon table"]	Any document with a top-level <i>book</i> tag with an <i>author</i> attribute containing "barnes" (normalized) and a <i>title</i> attribute that only contains the words "the," "lemon" and "table" (normalized in that order).
/book[@author contains("barnes") and (@title contains("lemon") or @title contains("flaubert"))]	Any document with a top-level <i>book</i> tag with the specified <i>author</i> attribute and either of the two specified <i>title</i> attributes.
/book[@publishDate > xs:date("2000-01-01")]	Top level tag is <i>book</i> and <i>book</i> has an attribute <i>PublishDate</i> that is greater than the date of 2000-01-01.
/book[purchaseTime > xs:dateTime("2009-05-20T13:00:00")]	Top level tag is <i>book</i> . <i>book</i> has a direct child <i>purchaseTime</i> that is a DateTime expression greater than 2009-05-20T13:00:00.

Table 267. Examples of valid XPath queries (continued)

Query	Description
<code>/program[. contains("hello, world.")]</code>	Any document with a top-level <i>program</i> tag containing both the tokens <i>hello</i> and <i>world</i> (normalized) in that order and in consecutive positions.
<code>/book[paragraph contains("foo")]//sentence</code>	Any document with a top-level <i>book</i> tag with a direct child tag <i>paragraph</i> containing "foo" and, referring to the <i>book</i> tag, having a descendant tag <i>sentence</i> at any level.
<code>/auto[@price < 30000.]</code>	Any document with a top-level <i>auto</i> tag having an attribute <i>price</i> with a numeric value that is less than 30000.
<code>//microbe[@size < 3.0e-06]</code>	Any document containing a <i>microbe</i> tag at any level with a <i>size</i> attribute with a value that is less than .000003.

Text search language options

The text search language option specifies which language rules to use when performing a text search.

If QUERYLANGUAGE is not specified, the default is the language value of the text search index that is used when the CONTAINS or SCORE function is invoked. If the language value of the text search index is AUTO, the default value for QUERYLANGUAGE is en_US. The following table shows the valid language codes that may be used in the QUERYLANGUAGE option.

Language code	Language
ar_AA	Arabic
cs_CZ	Czech
da_DK	Danish
de_CH	German (Switzerland)
de_DE	German (Germany)
el_GR	Greek
en_AU	English (Australia)
en_GB	English (United Kingdom)
en_US	English (United States)
es_ES	Spanish (Spain)
fi_FI	Finnish
fr_CA	French (Canada)
fr_FR	French (France)
it_IT	Italian
ja_JP	Japanese
ko_KR	Korean
nb_NO	Norwegian Bokmal
nl_NL	Dutch
nn_NO	Norwegian Nynorsk
pl_PL	Polish
pt_BR	Portuguese (Brazil)
pt_PT	Portuguese (Portugal)
ru_RU	Russian
sv_SE	Swedish
zh_CN	Simplified Chinese
zh_TW	Traditional Chinese

Appendix H. Terminology differences

Some terminology used in the ANSI and ISO standards differs from the terminology used in this book and other product books.

The following table is a cross reference of the SQL 2003 Core standard terms to Db2 SQL

Table 268. ANSI/ISO term to Db2 SQL term cross-reference

ANSI/ISO Term	Db2 SQL Term
literal	constant
comparison predicate	basic predicate
comparison predicate subquery	subquery in a basic predicate
degree of table/cursor	number of items in a select list
grouped table	result table created by a group-by or having clause
grouped view	result view created by a group-by or having clause
grouping column	column in a group-by clause
outer reference	correlated reference
query expression	fullselect
query specification	subselect
result specification	result
set function	aggregate function
table expression	<pre> graph LR A[→ from-clause →] --- B[where-clause] A --- C[→ group-by-clause →] A --- D[→ having-clause →] B --- C B --- D C --- D </pre>
target specification	host variable followed by an indicator variable
transaction	logical unit of work or unit of work
value expression	arithmetic expression

The following table is a cross reference of Db2 SQL terms to the SQL 2003 Core standard terms.

Table 269. Db2 SQL term to ANSI/ISO term cross-reference

Db2 SQL Term	ANSI/ISO Term
aggregate function	set function
arithmetic expression	value expression
basic predicate	comparison predicate
column in a group-by clause	grouping column
correlated reference	outer reference
	table expression
fullselect	query expression
host variable followed by an indicator variable	target specification
logical unit of work or unit of work	transaction
interactive SQL	direct SQL
number of items in a select list	degree of table/cursor
result	result specification
result table created by a group-by or having clause	grouped table
result view created by a group-by or having clause	grouped view
subquery in a basic predicate	comparison predicate subquery
subselect	query specification
subselect or fullselect in parenthesis	query term

Appendix I. Reserved schema names and reserved words

This topic describes the restrictions of certain names used by the database manager. In some cases, names are reserved and cannot be used by application programs. In other cases, certain names are not recommended for use by application programs though not prevented by the database manager.

Reserved schema names

This is the list of reserved schema names.

The following schema names are reserved:

- QSYS2
- SYSCAT
- SYSFUN
- SYSIBM
- SYSIBMADM
- SYSPROC
- SYSPUBLIC
- SYSSTAT
- SYSTEM

In addition, it is strongly recommended that schema names never begin with the Q prefix or SYS prefix, as Q and SYS are by convention used to indicate an area reserved by the system.

It is also recommended not to use SESSION as a schema name.

Reserved words

This is the list of currently reserved Db2 for i words.

Words may be added at any time. For a list of additional words that may become reserved in the future, see the IBM SQL and ANSI reserved words in the SQL Reference for Cross-Platform Development (<http://www.ibm.com/developerworks/data/library/techarticle/0206sqlref/0206sqlref.html>).

Table 270. SQL Reserved Words

ABSENT			
ACCORDING	CLUSTER	DBPARTITIONNAME	EXCEPTION
ACCTNG	COLLECT	DBPARTITIONNUM	EXCLUDING
ACTION	COLLECTION	DB2GENERAL	EXCLUSIVE
ACTIVATE	COLUMN	DB2GENRL	EXECUTE
ADD	COMMENT	DB2SQL	EXISTS
ALIAS	COMMIT	DEACTIVATE	EXIT
ALL	COMPACT	DEALLOCATE	EXTEND
ALLOCATE	COMPARISONS	DECLARE	EXTERNAL
ALLOW	COMPRESS	DEFAULT	EXTRACT
ALTER	CONCAT	DEFAULTS	FENCED
AND	CONCURRENT	DEFER	FETCH
ANY	CONDITION	DEFINE	FIELDPROC
APPEND	CONNECT	DEFINITION	FILE
APPLNAME	CONNECT_BY_ROOT	DELETE	FINAL
ARRAY	CONNECTION	DELETING	FIRST_VALUE
ARRAY_AGG	CONSTANT	DENSERANK	FOR
ARRAY_TRIM	CONSTRAINT	DENSE_RANK	FOREIGN
AS	CONTAINS	DESC	FORMAT
ASC	CONTENT	DESCRIBE	FREE
ASENSITIVE	CONTINUE	DESCRIPTOR	FREEPAGE
ASSOCIATE	COPY	DETACH	FROM
ATOMIC	COUNT	DETERMINISTIC	FULL
ATTACH	COUNT_BIG	DIAGNOSTICS	FUNCTION
ATTRIBUTES	CREATE	DISABLE	GBPCACHE
AUTHORIZATION	CREATEIN	DISALLOW	GENERAL
AUTONOMOUS	CROSS	DISCONNECT	GENERATED
BEFORE	CUBE	DISTINCT	GET
BEGIN	CUME_DIST	DO	GLOBAL
BETWEEN	CURRENT	DOCUMENT	GO
BINARY	CURRENT_DATE	DOUBLE	GOTO
BIND	CURRENT_PATH	DROP	GRANT
BIT	CURRENT_SCHEMA	DYNAMIC	GRAPHIC
BUFFERPOOL	CURRENT_SERVER	EACH	GROUP
BY	CURRENT_TIME	ELSE	HANDLER
CACHE	CURRENT_TIMESTAMP	ELSEIF	HASH
CALL	CURRENT_TIMEZONE	EMPTY	HASH_ROW
CALLED	CURRENT_USER	ENABLE	HASHED_VALUE
CARDINALITY	CURSOR	ENCODING	HAVING
CASE	CYCLE	ENCRYPTION	HINT
CAST	DATA	END	HOLD
CCSID	DATABASE	ENDING	HOUR
CHAR	DATAPARTITIONNAME	END-EXEC (COBOL only)	HOURS
CHARACTER	DATAPARTITIONNUM	ENFORCED	ID
CHECK	DATE	ERROR	IDENTITY
CL	DAY	ESCAPE	IF
CLOSE	DAYS	EVERY	IGNORE
	DBINFO	EXCEPT	IMMEDIATE

Table 271. SQL Reserved Words (continued)

IMPLICITLY			
IN	LOCALDATE	NULLS	PROGRAM
INCLUDE	LOCALTIME	NVARCHAR	PROGRAMID
INCLUDING	LOCALTIMESTAMP	OBID	QUERY
INCLUSIVE	LOCATION	OF	RANGE
INCREMENT	LOCATOR	OFFSET	RANK
INDEX	LOCK	OLD	RATIO_TO_REPORT
INDEXBP	LOCKSIZE	OLD_TABLE	RCDFMT
INDICATOR	LOG	OMIT	READ
INF	LOGGED	ON	READS
INFINITY	LONG	ONLY	RECOVERY
INHERIT	LOOP	OPEN	REFERENCES
INLINE	MAINTAINED	OPTIMIZE	REFERENCING
INNER	MASK	OPTION	REFRESH
INOUT	MATCHED	OR	REGEXP_LIKE
INSENSITIVE	MATERIALIZED	ORDER	RELEASE
INSERT	MAXVALUE	ORDINALITY	RENAME
INSERTING	MERGE	ORGANIZE	REPEAT
INTEGRITY	MICROSECOND	OUT	RESET
INTERPRET	MICROSECONDS	OUTER	RESIGNAL
INTERSECT	MINPCTUSED	OVER	RESTART
INTO	MINUTE	OVERLAY	RESULT
IS	MINUTES	OVERRIDING	RESULT_SET_LOCATOR
ISNULL	MINVALUE	PACKAGE	RETURN
ISOLATION	MIXED	PADDED	RETURNING
ITERATE	MODE	PAGE	RETURNS
JAVA	MODIFIES	PAGESIZE	REVOKE
JOIN	MONTH	PARAMETER	RID
JSON_ARRAY	MONTHS	PART	RIGHT
JSON_ARRAYAGG	NAMESPACE	PARTITION	ROLLBACK
JSON_EXISTS	NAN	PARTITIONED	ROLLUP
JSON_OBJECT	NATIONAL	PARTITIONING	ROUTINE
JSON_OBJECTAGG	NCHAR	PARTITIONS	ROW
JSON_QUERY	NCLOB	PASSING	ROWNUMBER
JSON_TABLE	NESTED	PASSWORD	ROW_NUMBER
JSON_VALUE	NEW	PATH	ROWS
KEEP	NEW_TABLE	PCTFREE	RRN
KEY	NEXTVAL	PERCENT_RANK	RUN
LABEL	NO	PERCENTILE_CONT	SAVEPOINT
LAG	NOCACHE	PERCENTILE_DISC	SBCS
LANGUAGE	NOCYCLE	PERIOD	SCHEMA
LAST_VALUE	NODENAME	PERMISSION	SCRATCHPAD
LATERAL	NODENUMBER	PIECESIZE	SCROLL
LEAD	NOMAXVALUE	PIPE	SEARCH
LEAVE	NOMINVALUE	PLAN	SECOND
LEFT	NONE	POSITION	SECONDS
LEVEL2	NOORDER	PREPARE	SECQTY
LIKE	NORMALIZED	PREVVAL	SECURED
LIMIT	NOT	PRIMARY	SELECT
LINKTYPE	NOTNULL	PRIOR	SENSITIVE
LISTAGG	NTH_VALUE	PRIQTY	SEQUENCE
LOCAL	NTILE	PRIVILEGES	SESSION
	NULL	PROCEDURE	SESSION_USER

Table 272. SQL Reserved Words (continued)

SET	TAG	USER	XMLATTRIBUTES
SIGNAL	THEN	USERID	XMLCAST
SIMPLE	THREADSAFE	USING	XMLCOMMENT
SKIP	TIME	VALUE	XMLCONCAT
SNAN	TIMESTAMP	VALUES	XMLDOCUMENT
SOME	TO	VARIABLE	XMLELEMENT
SOURCE	TRANSACTION	VARIANT	XMLFOREST
SPECIFIC	TRANSFER	VCAT	XMLGROUP
SQL	TRIGGER	VERSION	XMLNAMESPACES
SQLID	TRIM	VERSIONING	XMLPARSE
SQLIND_DEFAULT	TRIM_ARRAY	VIEW	XMLPI
SQLIND_UNASSIGNED	TRUNCATE	VOLATILE	XMLROW
STACKED	TYPE	WAIT	XMLSERIALIZE
START	UNDO	WHEN	XMLTABLE
STARTING	UNION	WHENEVER	XMLTEXT
STATEMENT	UNIQUE	WHERE	XMLVALIDATE
STATIC	UNIT	WHILE	XSLTRANSFORM
STOGROUP	UNNEST	WITH	XSROBJECT
SUBSTRING	UNTIL	WITHIN	YEAR
SUMMARY	UPDATE	WITHOUT	YEARS
SYNONYM	UPDATING	WRAPPED	YES
SYSTEM_TIME	URI	WRAPPER	ZONE
SYSTEM_USER	USAGE	WRITE	
TABLE	USE	WRKSTNNAME	
TABLESPACE		XMLAGG	
TABLESPACES			

Appendix J. Related information

The publications listed here provide additional information about topics described or referred to in this guide.

These manuals are listed with their full titles and order numbers. When these manuals are referred to in this guide, a shortened version of the title is used.

- [Backup and recovery](#)

The manual contains information about planning a backup and recovery strategy, the different types of media available to save and restore procedures, and disk recovery procedures. It also describes how to install the system again from backup.

- [ILE COBOL Programmer's Guide](#) 

This guide provides information needed to design, write, test, and maintain COBOL programs on the IBM i products.

- [ILE RPG Programmer's Guide](#) 

This guide provides information you need to design, write, test, and maintain ILE RPG programs on the IBM i products.

- [REXX/400 Programmer's Guide](#) 

This guide provides information you need to design, write, test, and maintain REXX/400 programs on the IBM i products.

- [CL programming](#)

This guide provides a wide-ranging discussion of the programming topics, including a general discussion of objects and libraries, CL programming, controlling flow and communicating between programs, working with objects in CL programs, and creating CL programs. Other topics include predefined and impromptu messages and handling, defining and creating user-defined commands and menus, application testing, including debug mode, breakpoints, traces, and display functions.

- [Database file management](#)

This book provides information about using files in application programs.

- [Database programming](#)

This book provides a detailed description of the IBM i database organization, including information about how to create, describe, and update database files on the system.

- [Distributed database programming](#)

Provides information about preparing and managing an IBM i product in a distributed relational database using the Distributed Relational Database Architecture (DRDA). Describes planning, setting up, programming, administering, and operating a distributed relational database on more than one IBM i product in a like-system environment.

- [Security reference](#)

This guide provides information about system security concepts, planning for security, and setting up security on the system. It also gives information about protecting the system and data from being used by people who do not have the proper authorization, protecting the data from intentional or unintentional damage or destruction, keeping security up-to-date, and setting up security on the system.

- [SQL programming](#)

This book provides an overview of how to design, write, run, and test Db2 for i statements. It also describes interactive Structured Query Language (SQL).

- [SQL XML programming](#)

This book provides information about using the XML data type with SQL. It includes examples of using functions and procedures to generate XML and to retrieve all or part of an XML document.

- [Embedded SQL programming](#)

This book provides examples of how to write SQL statements in ILE C, ILE C++, COBOL, ILE COBOL, RPG, ILE RPG, REXX, and PL/I programs.

- [Database performance and query optimization](#)

This book provides information about optimizing the performance of your queries using available tools and techniques.

- [IDDU Use](#) 

This book describes how to use IBM i interactive data definition utility (IDDU) to describe data dictionaries, files, and records to the system.

- [SQL call level interfaces \(ODBC\)](#)

This book describes how to use X/Open SQL Call Level Interface to access SQL functions directly through procedure calls to a service program provided by Db2 for i.

- [IBM i Access category in the IBM i Information Center](#)

This information describes how to set up and run ODBC applications on a client using IBM i Access ODBC. Included in this document are chapters on performance, examples, and configuring specific applications to run with IBM i Access ODBC.

- [IBM Toolbox for Java](#)

This book describes how to set up and run JDBC applications on a client using IBM Toolbox for Java. Included in this document are chapters on performance, examples, and configuring specific applications to run with IBM Toolbox for Java.

- [IBM Developer Kit for Java](#)

This information provides the details you need to design, write, test, and maintain JAVA programs on the IBM i product. The book also contains information about the IBM Developer Kit for Java JDBC driver.

- [DB2 Multisystem](#)

This book describes the fundamental concepts of distributed relational database files, nodegroups, and partitioning. The book provides the information you need to create and use database files that are partitioned across multiple systems. Information is provided on how to configure the systems, how to create the files, and how the files can be used in applications.

Notices

This information was developed for products and services offered in the U.S.A.

IBM may not offer the products, services, or features discussed in this document in other countries. Consult your local IBM representative for information on the products and services currently available in your area. Any reference to an IBM product, program, or service is not intended to state or imply that only that IBM product, program, or service may be used. Any functionally equivalent product, program, or service that does not infringe any IBM intellectual property right may be used instead. However, it is the user's responsibility to evaluate and verify the operation of any non-IBM product, program, or service.

IBM may have patents or pending patent applications covering subject matter described in this document. The furnishing of this document does not grant you any license to these patents. You can send license inquiries, in writing, to:

IBM Director of Licensing
IBM Corporation
North Castle Drive
Armonk, NY 10504-1785
U.S.A.

For license inquiries regarding double-byte (DBCS) information, contact the IBM Intellectual Property Department in your country or send inquiries, in writing, to:

Intellectual Property Licensing
Legal and Intellectual Property Law
IBM Japan Ltd.
1623-14, Shimotsuruma, Yamato-shi
Kanagawa 242-8502 Japan

The following paragraph does not apply to the United Kingdom or any other country where such provisions are inconsistent with local law: INTERNATIONAL BUSINESS MACHINES CORPORATION PROVIDES THIS PUBLICATION "AS IS" WITHOUT WARRANTY OF ANY KIND, EITHER EXPRESS OR IMPLIED, INCLUDING, BUT NOT LIMITED TO, THE IMPLIED WARRANTIES OF NON-INFRINGEMENT, MERCHANTABILITY OR FITNESS FOR A PARTICULAR PURPOSE. Some states do not allow disclaimer of express or implied warranties in certain transactions, therefore, this statement may not apply to you.

This information could include technical inaccuracies or typographical errors. Changes are periodically made to the information herein; these changes will be incorporated in new editions of the publication. IBM may make improvements and/or changes in the product(s) and/or the program(s) described in this publication at any time without notice.

Any references in this information to non-IBM Web sites are provided for convenience only and do not in any manner serve as an endorsement of those Web sites. The materials at those Web sites are not part of the materials for this IBM product and use of those Web sites is at your own risk.

IBM may use or distribute any of the information you supply in any way it believes appropriate without incurring any obligation to you.

Licensees of this program who wish to have information about it for the purpose of enabling: (i) the exchange of information between independently created programs and other programs (including this one) and (ii) the mutual use of the information which has been exchanged, should contact:

IBM Corporation
Software Interoperability Coordinator, Department YBWA
3605 Highway 52 N
Rochester, MN 55901
U.S.A.

Such information may be available, subject to appropriate terms and conditions, including in some cases, payment of a fee.

The licensed program described in this document and all licensed material available for it are provided by IBM under terms of the IBM Customer Agreement, IBM International Program License Agreement or any equivalent agreement between us.

Any performance data contained herein was determined in a controlled environment. Therefore, the results obtained in other operating environments may vary significantly. Some measurements may have been made on development-level systems and there is no guarantee that these measurements will be the same on generally available systems. Furthermore, some measurements may have been estimated through extrapolation. Actual results may vary. Users of this document should verify the applicable data for their specific environment.

Information concerning non-IBM products was obtained from the suppliers of those products, their published announcements or other publicly available sources. IBM has not tested those products and cannot confirm the accuracy of performance, compatibility or any other claims related to non-IBM products. Questions on the capabilities of non-IBM products should be addressed to the suppliers of those products.

All statements regarding IBM's future direction or intent are subject to change or withdrawal without notice, and represent goals and objectives only.

This information is for planning purposes only. The information herein is subject to change before the products described become available.

This information contains examples of data and reports used in daily business operations. To illustrate them as completely as possible, the examples include the names of individuals, companies, brands, and products. All of these names are fictitious and any similarity to the names and addresses used by an actual business enterprise is entirely coincidental.

COPYRIGHT LICENSE:

This information contains sample application programs in source language, which illustrate programming techniques on various operating platforms. You may copy, modify, and distribute these sample programs in any form without payment to IBM, for the purposes of developing, using, marketing or distributing application programs conforming to the application programming interface for the operating platform for which the sample programs are written. These examples have not been thoroughly tested under all conditions. IBM, therefore, cannot guarantee or imply reliability, serviceability, or function of these programs. The sample programs are provided "AS IS", without warranty of any kind. IBM shall not be liable for any damages arising out of your use of the sample programs.

Each copy or any portion of these sample programs or any derivative work, must include a copyright notice as follows:

© (your company name) (year). Portions of this code are derived from IBM Corp. Sample Programs.

© Copyright IBM Corp. _enter the year or years_.

Programming interface information

This Db2 for i SQL Reference publication documents intended Programming Interfaces that allow the customer to write programs to obtain the services of IBM i.

Trademarks

IBM, the IBM logo, and ibm.com are trademarks or registered trademarks of International Business Machines Corp., registered in many jurisdictions worldwide. Other product and service names might be trademarks of IBM or other companies. A current list of IBM trademarks is available on the Web at "[Copyright and trademark information](http://www.ibm.com/legal/copytrade.shtml)" at www.ibm.com/legal/copytrade.shtml.

Adobe, the Adobe logo, PostScript, and the PostScript logo are either registered trademarks or trademarks of Adobe Systems Incorporated in the United States, and/or other countries.

Linux is a registered trademark of Linus Torvalds in the United States, other countries, or both.

Microsoft, Windows, Windows NT, and the Windows logo are trademarks of Microsoft Corporation in the United States, other countries, or both.

Java and all Java-based trademarks and logos are trademarks of Oracle, Inc. in the United States, other countries, or both.

Other product and service names might be trademarks of IBM or other companies.

Terms and conditions

Permissions for the use of these publications is granted subject to the following terms and conditions.

Personal Use: You may reproduce these publications for your personal, noncommercial use provided that all proprietary notices are preserved. You may not distribute, display or make derivative works of these publications, or any portion thereof, without the express consent of IBM.

Commercial Use: You may reproduce, distribute and display these publications solely within your enterprise provided that all proprietary notices are preserved. You may not make derivative works of these publications, or reproduce, distribute or display these publications or any portion thereof outside your enterprise, without the express consent of IBM.

Except as expressly granted in this permission, no other permissions, licenses or rights are granted, either express or implied, to the publications or any information, data, software or other intellectual property contained therein.

IBM reserves the right to withdraw the permissions granted herein whenever, in its discretion, the use of the publications is detrimental to its interest or, as determined by IBM, the above instructions are not being properly followed.

You may not download, export or re-export this information except in full compliance with all applicable laws and regulations, including all United States export laws and regulations.

IBM MAKES NO GUARANTEE ABOUT THE CONTENT OF THESE PUBLICATIONS. THE PUBLICATIONS ARE PROVIDED "AS-IS" AND WITHOUT WARRANTY OF ANY KIND, EITHER EXPRESSED OR IMPLIED, INCLUDING BUT NOT LIMITED TO IMPLIED WARRANTIES OF MERCHANTABILITY, NON-INFRINGEMENT, AND FITNESS FOR A PARTICULAR PURPOSE.

Index

Special Characters

- _ (underscore) in LIKE predicate [216](#)
- (subtraction) [160](#)
- ? (question mark) [1297](#)
- .NET [4](#)
- ' (apostrophe) [46](#), [115](#), [117](#)
- " (quotation mark) [46](#)
- * (asterisk)
 - in subselect [725](#)
- * (multiply) [160](#)
- ** (exponentiation) [160](#)
- *ALL (read stability) precompiler option [25](#)
- *APOST precompiler option [119](#)
- *CHG (uncommitted read) precompiler option [26](#)
- *CNULRQD precompiler option [96](#), [1308](#), [1540](#), [1565](#)
- *CS (cursor stability) precompiler option [26](#)
- *DMY date and time format [76](#)
- *EUR date and time format [76](#), [77](#)
- *HMS date and time format [77](#)
- *ISO date and time format [76](#), [77](#)
- *JIS date and time format [76](#), [77](#)
- *JUL date and time format [76](#)
- *MDY date and time format [76](#)
- *NC (no commit) precompiler option [26](#)
- *NOCNULRQD precompiler option [96](#), [1308](#), [1540](#), [1565](#)
- *NONE (no commit) precompiler option [26](#)
- *QUOTE precompiler option [119](#)
- *RR (repeatable read) precompiler option [25](#)
- *RS (read stability) precompiler option [25](#)
- *UR (uncommitted read) precompiler option [26](#)
- *USA date and time format [76](#), [77](#)
- *YMD date and time format [76](#)
- / (divide) [160](#)
- % (percent) in LIKE predicate [216](#)
- + (addition) [160](#)
- || (concatenation operator) [164](#)

A

- ABS function [302](#)
- ABSVAL function [302](#)
- access plan and packages [12](#)
- ACOS function [303](#)
- ACTIVATE NOT LOGGED INITIALLY
 - ALTER TABLE statement [892](#)
- activation group
 - threads [22](#)
- ADD check-constraint clause
 - ALTER TABLE statement [884](#)
- ADD COLUMN clause
 - in ALTER TABLE statement [870](#)
- ADD materialized query clause
 - ALTER TABLE statement [889](#)
- ADD PARTITION
 - ALTER TABLE statement [887](#)
- ADD unique-constraint clause

- ADD unique-constraint clause (*continued*)
 - ALTER TABLE statement [882](#)
- ADD_MONTHS
 - function [304](#)
- ADO [3](#)
- advanced text search operators
 - CONTAINS function [1982](#)
 - SCORE function [1982](#)
- AFTER clause
 - in FETCH statement [1304](#)
- aggregate function
 - equivalent term [1992](#)
- alias
 - description [60](#)
 - dropping [1286](#)
- ALIAS clause
 - COMMENT statement [935](#)
 - CREATE ALIAS statement [961](#)
 - DROP statement [1286](#)
 - LABEL statement [1403](#)
- alias-name
 - description [48](#)
 - in CREATE ALIAS statement [962](#)
 - in DROP statement [1286](#)
 - in LABEL statement [1403](#)
- ALL clause
 - clause of subselect [725](#)
 - DISCONNECT statement [1278](#)
 - GRANT (function or procedure privileges) statement [1352](#)
 - GRANT (package privileges) statement [1357](#)
 - GRANT (schema privileges) statement [1360](#)
 - GRANT (sequence privileges) statement [1363](#)
 - GRANT (type privileges) statement [1375](#)
 - GRANT (variable privileges) statement [1378](#)
 - GRANT (XML schema privileges) statement [1380](#)
 - in USING clause
 - DESCRIBE statement [1260](#)
 - DESCRIBE TABLE statement [1276](#)
 - PREPARE statement [1431](#)
- keyword
 - AVG function [262](#)
 - COUNT function [264](#)
 - COUNT_BIG function [265](#)
 - MAX function [281](#)
 - MIN function [283](#)
 - STDDEV function [291](#)
 - STDDEV_POP function [291](#)
 - STDDEV_SAMP function [292](#)
 - SUM function [293](#)
 - VAR function [294](#)
 - VAR_POP function [294](#)
 - VAR_SAMP function [295](#)
 - VARIANCE function [294](#)
 - VARIANCE_SAMP function [295](#)
- quantified predicate [202](#)
- RELEASE statement [1447](#)

ALL clause (*continued*)
 REVOKE (function or procedure privileges) statement [1456](#)
 REVOKE (Global variable privileges) statement [1471](#)
 REVOKE (package privileges) statement [1459](#)
 REVOKE (schema privileges) statement [1461](#)
 REVOKE (sequence privileges) statement [1463](#)
 REVOKE (table or view privileges) statement [1466](#)
 REVOKE (type privileges) statement [1469](#)
 REVOKE (XML schema privileges) statement [1473](#)
 ALL PRIVILEGES clause
 GRANT (function or procedure privileges) statement [1352](#)
 GRANT (package privileges) statement [1357](#)
 GRANT (schema privileges) statement [1360](#)
 GRANT (sequence privileges) statement [1363](#)
 GRANT (table or view privileges) statement [1367](#)
 GRANT (type privileges) statement [1375](#)
 GRANT (variable privileges) statement [1378](#)
 GRANT (XML schema privileges) statement [1380](#)
 REVOKE (function or procedure privileges) statement [1456](#)
 REVOKE (package privileges) statement [1459](#)
 REVOKE (schema privileges) statement [1461](#)
 REVOKE (sequence privileges) statement [1463](#)
 REVOKE (table or view privileges) statement [1466](#)
 REVOKE (type privileges) statement [1469](#)
 REVOKE (variable privileges) statement [1471](#)
 REVOKE (XML schema privileges) statement [1473](#)
 ALL SQL clause
 DISCONNECT statement [1278](#)
 RELEASE statement [1447](#)
 ALLOCATE clause
 CREATE TABLE statement [1122](#)
 ALLOCATE CURSOR statement [805](#)
 ALLOCATE DESCRIPTOR statement [806](#)
 ALLOW PARALLEL clause
 in CREATE FUNCTION (external scalar) [985](#)
 in CREATE FUNCTION (external table) [1005](#)
 in CREATE FUNCTION (SQL scalar) [1027](#)
 in CREATE FUNCTION (SQL table) [1040](#)
 ALLOW READ clause
 in LOCK TABLE statement [1408](#)
 ALTER clause
 GRANT (function or procedure privileges) statement [1352](#)
 GRANT (package privileges) statement [1358](#)
 GRANT (sequence privileges) statement [1364](#)
 GRANT (table or view privileges) statement [1367](#)
 GRANT (type privileges) statement [1375](#)
 GRANT (variable privileges) statement [1378](#)
 GRANT (XML schema privileges) statement [1381](#)
 REVOKE (function or procedure privileges) statement [1456](#)
 REVOKE (package privileges) statement [1459](#)
 REVOKE (sequence privileges) statement [1463](#)
 REVOKE (table or view privileges) statement [1466](#)
 REVOKE (type privileges) statement [1469](#)
 REVOKE (variable privileges) statement [1471](#)
 REVOKE (XML schema privileges) statement [1473](#)
 ALTER COLUMN clause
 ALTER TABLE statement [879](#)
 ALTER FUNCTION (external scalar) statement [808](#)
 ALTER FUNCTION (external table) statement [813](#)
 ALTER FUNCTION (SQL scalar) statement [818](#)
 ALTER FUNCTION (SQL table) statement [826](#)
 ALTER MASK statement [834](#)
 ALTER materialized query clause
 ALTER TABLE statement [890](#)
 ALTER PARTITION
 ALTER TABLE statement [887](#)
 ALTER PERMISSION statement [836](#)
 ALTER PROCEDURE (external) statement [838](#)
 ALTER PROCEDURE (SQL) statement [843](#)
 ALTER SEQUENCE statement [853](#)
 ALTER TABLE statement [858](#), [909](#)
 ALTER TRIGGER statement [910](#)
 ALWBLK clause
 in SET OPTION statement [1511](#)
 ALWCPYDTA clause
 in SET OPTION statement [1512](#)
 ambiguous reference [136](#)
 AND
 truth table [228](#)
 ANTILOG function [306](#)
 ANY clause
 in USING clause
 DESCRIBE statement [1260](#)
 DESCRIBE TABLE statement [1276](#)
 PREPARE statement [1431](#)
 quantified predicate [202](#)
 application process [17](#)
 application program
 SQLCA
 C [1663](#)
 COBOL [1663](#)
 ILE RPG [1665](#)
 PL/I [1663](#)
 RPG/400 [1664](#)
 SQLDA
 C [1681](#)
 COBOL [1683](#)
 description [1667](#)
 ILE COBOL [1683](#)
 ILE RPG [1685](#)
 PL/I [1684](#)
 application requester [35](#), [1650](#)
 application server [35](#)
 application servers [1650](#)
 application-directed distributed unit of work [39](#)
 arithmetic
 decimal floating-point [163](#)
 arithmetic expression
 equivalent term [1992](#)
 arithmetic operators [160](#)
 ARRAY clause
 SET RESULT SETS statement [1527](#)
 ARRAY constructor [173](#)
 ARRAY element specification [174](#)
 array type
 assignment [101](#)
 comparisons [106](#)
 array types
 data types
 description [82](#)
 ARRAY_AGG function [260](#)
 ARRAY_MAX_CARDINALITY function [307](#)
 ARRAY_TRIM function [308](#)

- array-type-name
 - description [48](#)
 - in CREATE TYPE (array) statement [1181](#)
- AS clause
 - clause of subselect [726](#)
 - CREATE VIEW statement [1200](#), [1201](#)
 - FROM clause of UPDATE [1554](#)
 - in FROM clause of DELETE [1252](#)
- AS LOCATOR clause
 - CREATE PROCEDURE (external) [1071](#)
 - in CREATE FUNCTION (external scalar) [977](#)
 - in CREATE FUNCTION (external table) [997](#), [998](#)
 - in CREATE FUNCTION (sourced) [1012](#)
 - in DECLARE PROCEDURE statement [1241](#)
- AS result table
 - in CREATE TABLE statement [1137](#)
 - in DECLARE GLOBAL TEMPORARY TABLE statement [1230](#)
- ASC clause
 - CREATE INDEX statement [1050](#)
 - in OLAP specification [187](#)
 - of select-statement [766](#)
- ASCII function [309](#)
- ASENSITIVE clause
 - in DECLARE CURSOR statement [1208](#)
- ASIN function [310](#)
- assignment
 - array type [101](#)
 - binary strings [95](#)
 - character strings [95](#)
 - conversion rules [96](#)
 - DataLink [98](#)
 - date and time values [97](#)
 - distinct type [100](#)
 - graphic strings [95](#)
 - LOB Locators [101](#)
 - numbers [92](#)
 - Row ID [99](#)
 - strings [94](#)
 - XML [98](#)
- assignment-clause
 - UPDATE statement [1555](#)
- assignment-statement [1580](#)
- ASSOCIATE LOCATORS statement [913](#)
- asterisk (*)
 - in COUNT function [264](#)
 - in COUNT_BIG function [265](#)
 - in subselect [725](#)
- ATAN2 function [313](#)
- ATANH function [312](#)
- authorization
 - description [15](#)
 - privileges [16](#)
 - to create in a schema [16](#)
- authorization ID
 - description [61](#)
- authorization-name
 - definition [48](#)
 - description [62](#)
 - in CONNECT (type 1) statement [953](#)
 - in CONNECT (type 2) statement [958](#)
 - in CREATE SCHEMA statement [1095](#)
 - in GRANT (function or procedure privileges) statement [1354](#)

- authorization-name (*continued*)
 - in GRANT (package privileges) statement [1358](#)
 - in GRANT (schema privileges) statement [1361](#)
 - in GRANT (sequence privileges) statement [1364](#)
 - in GRANT (table or view privileges) statement [1368](#)
 - in GRANT (type privileges) statement [1375](#)
 - in GRANT (variable privileges) statement [1378](#)
 - in GRANT (XML schema privileges) statement [1381](#)
 - in REVOKE (function or procedure privileges) statement [1458](#)
 - in REVOKE (package privileges) statement [1460](#)
 - in REVOKE (schema privileges) statement [1462](#)
 - in REVOKE (sequence privileges) statement [1464](#)
 - in REVOKE (table or view privileges) statement [1467](#)
 - in REVOKE (type privileges) statement [1470](#)
 - in REVOKE (variable privileges) statement [1472](#)
 - in REVOKE (XML schema privileges) statement [1474](#)
- AUTHORIZATIONS view [1938](#)
- automatic summary table
 - in ALTER TABLE statement [890](#), [891](#)
 - in CREATE TABLE statement [1149](#)
- AVG function [262](#)

B

- base table [4](#)
- BASE_TABLE function [680](#)
- basic operations in SQL [91](#)
- basic predicate
 - equivalent term [1992](#)
- BEFORE clause
 - in FETCH statement [1304](#)
- BEGIN DECLARE SECTION statement [918](#), [919](#)
- BETWEEN predicate [204](#)
- bibliography [1999](#)
- big integers [67](#)
- BIGINT
 - data type for ALTER TABLE [871](#)
 - data type for CREATE FUNCTION (external scalar) [975](#)
 - data type for CREATE FUNCTION (external table) [995](#)
 - data type for CREATE FUNCTION (sourced) [1011](#)
 - data type for CREATE PROCEDURE (external) [1070](#)
 - data type for CREATE PROCEDURE (SQL) [1086](#)
 - data type for CREATE TABLE [1118](#)
 - data type for CREATE TYPE [1187](#)
 - data type for DECLARE GLOBAL TEMPORARY TABLE [1223](#)
 - data type for DECLARE PROCEDURE [1240](#)
- BIGINT data type [67](#)
- BIGINT function [314](#)
- BINARY
 - data type [72](#)
 - data type for ALTER TABLE [871](#)
 - data type for CREATE FUNCTION (external scalar) [975](#)
 - data type for CREATE FUNCTION (external table) [995](#)
 - data type for CREATE FUNCTION (sourced) [1011](#)
 - data type for CREATE PROCEDURE (external) [1070](#)
 - data type for CREATE PROCEDURE (SQL) [1086](#)
 - data type for CREATE TABLE [1121](#)
 - data type for CREATE TYPE [1187](#)
 - data type for DECLARE GLOBAL TEMPORARY TABLE [1223](#)
 - DECLARE PROCEDURE statement [1240](#)
- binary data string

- binary data string (*continued*)
 - constants [117](#)
- BINARY function [316](#)
- binary string
 - assignment [95](#)
 - description [72](#)
- bind [2](#)
- BINDOPT clause
 - in SET OPTION statement [1512](#)
- bit data [70](#)
- BIT_LENGTH function [319](#)
- BITAND function [317](#)
- BITANDNOT function [317](#)
- BITNOT function [317](#)
- BITOR function [317](#)
- BITXOR function [317](#)
- BLOB
 - data type [72](#)
 - data type for ALTER TABLE [871](#)
 - data type for CREATE FUNCTION (external scalar) [975](#)
 - data type for CREATE FUNCTION (external table) [995](#)
 - data type for CREATE FUNCTION (sourced) [1011](#)
 - data type for CREATE PROCEDURE (external) [1070](#)
 - data type for CREATE PROCEDURE (SQL) [1086](#)
 - data type for CREATE TABLE [1121](#)
 - data type for CREATE TYPE [1187](#)
 - data type for DECLARE GLOBAL TEMPORARY TABLE [1223](#)
 - DECLARE PROCEDURE statement [1240](#)
- BLOB function [320](#)
- BOTH clause
 - in USING clause
 - DESCRIBE statement [1260](#)
 - DESCRIBE TABLE statement [1276](#)
 - PREPARE statement [1431](#)
- BSON_TO_JSON
 - scalar function [321](#)
- built-in data type
 - ALTER SEQUENCE statement [855](#)
 - CREATE SEQUENCE statement [1100](#)
 - CREATE TYPE statement [1187](#)
 - CREATE VARIABLE statement [1195](#)
- built-in function [148](#)
- built-in-type
 - description [1118](#)
 - in CREATE TABLE [1118](#)
 - in DECLARE GLOBAL TEMPORARY TABLE statement [1223](#)

C

- C
 - application program
 - host variable [146](#)
 - host structure arrays [147](#)
 - host variable [140](#)
 - SQLCA (SQL communication area) [1663](#)
 - SQLDA (SQL descriptor area) [1681](#)
- CACHE clause
 - CREATE SEQUENCE statement [1101](#)
 - in ALTER TABLE statement [881](#)
- call level interface (CLI) [3](#)
- CALL statement [920](#), [926](#), [1584](#)
- CALLED ON NULL INPUT clause
 - CREATE PROCEDURE (external) [1074](#)
 - in CREATE FUNCTION (external scalar) [982](#)
 - in CREATE FUNCTION (external table) [1001](#)
 - in CREATE FUNCTION (SQL scalar) [1026](#)
 - in CREATE FUNCTION (SQL table) [1039](#)
 - in CREATE PROCEDURE (SQL) [1088](#)
- calling
 - procedures, external [920](#)
- CARDINALITY
 - GET DESCRIPTOR statement [1315](#)
 - SET DESCRIPTOR statement [1499](#)
- CARDINALITY clause
 - in CREATE FUNCTION (external table) [1006](#)
 - in CREATE FUNCTION (SQL table) [1041](#)
- CARDINALITY function [322](#)
- CASCADE clause
 - DROP statement [1289–1291](#)
 - in DROP COLUMN of ALTER TABLE statement [882](#)
 - in DROP constraint of ALTER TABLE statement [886](#)
- CASCADE delete rule
 - description [7](#)
 - in ALTER TABLE statement [884](#)
 - in CREATE TABLE statement [1140](#)
- CASCADED CHECK OPTION clause
 - CREATE VIEW statement [1201](#)
- CASE expression [175](#)
- CASE statement [1586](#)
- CAST specification [177](#)
- cast-function
 - ALTER TABLE statement [873](#)
 - CREATE TABLE statement [1124](#)
 - DECLARE GLOBAL TEMPORARY TABLE statement [1224](#)
- catalog [17](#), [1701](#)
- catalog table
 - SQL_FEATURES [1965](#)
 - SQL_LANGUAGES [1966](#)
 - SQL_SIZING [1967](#)
 - SQLTYPEINFO [1927](#)
 - SYSCONTROLS [1733](#)
 - SYSCONTROLSDEP [1735](#)
 - SYSPARMS [1780](#)
 - SYSROUTINES [1827](#)
 - SYSTYPES [1859](#)
 - SYSVARIABLEDEP [1865](#)
 - SYSVARIABLES [1866](#)
 - XSRANNOTATIONINFO [1877](#)
 - XSROBJECTCOMPONENTS [1878](#)
 - XSROBJECTHIERARCHIES [1879](#)
 - XSROBJECTS [1880](#)
- catalog view
 - AUTHORIZATIONS [1938](#)
 - CHARACTER_SETS [1939](#)
 - CHECK_CONSTRAINTS [1940](#)
 - COLUMN_PRIVILEGES [1941](#)
 - COLUMNS [1942](#)
 - description [1701](#)
 - INFORMATION_SCHEMA_CATALOG_NAME [1947](#)
 - PARAMETERS [1948](#)
 - REFERENTIAL_CONSTRAINTS [1952](#)
 - ROUTINE_PRIVILEGES [1962](#)
 - ROUTINES [1953](#)
 - SCHEMATA [1963](#)
 - SEQUENCES [1964](#)

catalog view (*continued*)

[SQLCOLPRIVILEGES 1883](#)
[SQLCOLUMNS 1884](#)
[SQLFOREIGNKEYS 1894](#)
[SQLFUNCTIONCOLS 1895](#)
[SQLFUNCTIONS 1904](#)
[SQLPRIMARYKEYS 1905](#)
[SQLPROCEDURECOLS 1906](#)
[SQLPROCEDURES 1915](#)
[SQLSCHEMAS 1916](#)
[SQLSPECIALCOLUMNS 1917](#)
[SQLSTATISTICS 1923](#)
[SQLTABLEPRIVILEGES 1925](#)
[SQLTABLES 1926](#)
[SQLUDTS 1935](#)
[SYSCATALOGS 1707](#)
[SYSCHKCST 1708](#)
[SYSCOLAUTH 1709](#)
[SYSCOLUMNS 1710](#)
[SYSCOLUMNS2 1718](#)
[SYSCOLUMNS2_SESSION 1729](#)
[SYSCOLUMNSTAT 1730](#)
[SYSCST 1736](#)
[SYSCSTCOL 1738](#)
[SYSCSTDEP 1739](#)
[SYSFIELDS 1741](#)
[SYSFUNCS 1745](#)
[SYSHISTORYTABLES 1750](#)
[SYSINDEXES 1751](#)
[SYSINDEXSTAT 1753](#)
[SYSJARCONTENTS 1761](#)
[SYSJAROBJECTS 1762](#)
[SYSKEYCST 1763](#)
[SYSKEYS 1764](#)
[SYSMQTSTAT 1765](#)
[SYSPACKAGE 1769](#)
[SYSPACKAGEAUTH 1771](#)
[SYSPACKAGESTAT 1772](#)
[SYSPACKAGESTMTSTAT 1778](#)
[SYSPARTITIONDISK 1784](#)
[SYSPARTITIONINDEXDISK 1786](#)
[SYSPARTITIONINDEXES 1788](#)
[SYSPARTITIONINDEXSTAT 1795](#)
[SYSPARTITIONMQTS 1801](#)
[SYSPARTITIONSTAT 1805](#)
[SYSPERIODS 1809](#)
[SYSPROCS 1810](#)
[SYSPROGRAMSTAT 1813](#)
[SYSPROGRAMSTMTSTAT 1822](#)
[SYSREFCST 1824](#)
[SYSROUTINEAUTH 1825](#)
[SYSROUTINEDEP 1826](#)
[SYSSCHEMAAUTH 1833](#)
[SYSSCHEMAS 1834](#)
[SYSSEQUENCEAUTH 1835](#)
[SYSSEQUENCES 1836](#)
[SYSTABAUTH 1838](#)
[SYSTABLEDEP 1839](#)
[SYSTABLEINDEXSTAT 1840](#)
[SYSTABLES 1845](#)
[SYSTABLESTAT 1849](#)
[SYSTRIGCOL 1852](#)
[SYSTRIGDEP 1853](#)
[SYSTRIGGERS 1854](#)

catalog view (*continued*)

[SYSTRIGUPD 1858](#)
[SYSUDTAUTH 1863](#)
[SYSVARIABLEAUTH 1864](#)
[SYSVIEWDEP 1872](#)
[SYSVIEWS 1874](#)
[SYSXSROBJECTAUTH 1876](#)
[TABLE_CONSTRAINTS 1968](#)
[TABLE_PRIVILEGES 1969](#)
[TABLES 1970](#)
[UDT_PRIVILEGES 1971](#)
[USAGE_PRIVILEGES 1972](#)
[USER_DEFINED_TYPES 1973](#)
[VARIABLE_PRIVILEGES 1977](#)
[VIEWS 1978](#)
CATALOG_NAME
 GET DIAGNOSTICS statement [1334](#)
 SIGNAL statement [1543](#)
CCSID (coded character set identifier)
 default [32](#)
 definition [32](#)
 specifying
 in SQLDATA [1680](#)
 in SQLNAME [1680](#)
 values [1687](#), [1699](#)
CCSID clause
 CREATE FUNCTION (sourced) [1011](#)
 CREATE PROCEDURE (external) [1070](#)
 CREATE PROCEDURE (SQL) [1086](#)
 CREATE TABLE statement [1122](#), [1123](#)
 data type for ALTER TABLE [871](#)
 data type for CREATE FUNCTION (external scalar) [975](#)
 data type for CREATE FUNCTION (external table) [995](#)
 data type for CREATE TYPE [1187](#)
 data type for DECLARE GLOBAL TEMPORARY TABLE [1223](#)
 DECLARE PROCEDURE statement [1240](#)
 DECLARE VARIABLE statement [1248](#)
CDRA (Character Data Representation Architecture) [32](#)
CEIL function [323](#)
CEILING function [323](#)
CHAR
 data type for ALTER TABLE [871](#)
 data type for CREATE FUNCTION (external scalar) [975](#)
 data type for CREATE FUNCTION (external table) [995](#)
 data type for CREATE FUNCTION (sourced) [1011](#)
 data type for CREATE PROCEDURE (external) [1070](#)
 data type for CREATE PROCEDURE (SQL) [1086](#)
 data type for CREATE TABLE [1119](#)
 data type for CREATE TYPE [1187](#)
 data type for DECLARE GLOBAL TEMPORARY TABLE [1223](#)
 data type for DECLARE PROCEDURE [1240](#)
 function [324](#)
CHAR_LENGTH function [330](#)
character conversion
 character set [29](#)
 code page [29](#)
 code point [29](#)
 coded character set [29](#)
 combining characters [30](#)
 encoding scheme [29](#)
 normalization [30](#)
 substitution character [29](#)

- character conversion (*continued*)
 - surrogates [30](#)
 - Unicode [29](#)
- Character Data Representation Architecture (CDRA) [32](#)
- character data string
 - bit data [70](#)
 - comparison [102](#)
 - constants [115](#)
 - empty [69](#)
 - mixed data [70](#)
 - SBCS data [70](#)
- character set [29](#)
- character string
 - assignment [95](#)
 - definition [69](#)
- CHARACTER_LENGTH function [330](#)
- CHARACTER_SETS view [1939](#)
- check
 - ALTER TABLE statement [884](#)
- CHECK clause
 - ALTER TABLE statement [878](#), [884](#)
 - CREATE TABLE statement [1131](#), [1141](#)
- check constraint
 - effect on insert [1394](#)
 - effect on update [1558](#)
- check constraints
 - delete rules [1254](#)
- CHECK OPTION clause
 - CREATE VIEW statement [1201](#)
 - effect on update [1558](#)
- CHECK_CONSTRAINTS view [1940](#)
- check-condition
 - in CHECK clause of ALTER TABLE statement [884](#)
- CHR function [331](#)
- CLASS_ORIGIN
 - GET DIAGNOSTICS statement [1335](#)
 - RESIGNAL statement [1623](#)
 - SIGNAL statement [1543](#), [1630](#)
- class-id
 - description [50](#)
- CLIENT ACCTNG special register [123](#)
- CLIENT APPLNAME special register [123](#)
- CLIENT PROGRAMID special register [123](#)
- CLIENT USERID special register [124](#)
- CLIENT WRKSTNNAME special register [124](#)
- CLIENT_HOST global variable [232](#)
- CLIENT_IPADDR global variable [233](#)
- CLIENT_PORT global variable [234](#)
- CLOB
 - data type for ALTER TABLE [871](#)
 - data type for CREATE FUNCTION (external scalar) [975](#)
 - data type for CREATE FUNCTION (external table) [995](#)
 - data type for CREATE FUNCTION (sourced) [1011](#)
 - data type for CREATE PROCEDURE (external) [1070](#)
 - data type for CREATE PROCEDURE (SQL) [1086](#)
 - data type for CREATE TABLE [1119](#)
 - data type for CREATE TYPE [1187](#)
 - data type for DECLARE GLOBAL TEMPORARY TABLE [1223](#)
 - DECLARE PROCEDURE statement [1240](#)
- CLOB function [332](#)
- CLOSE statement [928](#), [929](#)
- closed state of cursor [1423](#)
- CLOSECURSOR clause
 - CLOSECURSOR clause (*continued*)
 - in SET OPTION statement [1512](#)
- CNULIGN clause
 - in SET OPTION statement [1513](#)
- CNULRQD clause
 - in SET OPTION statement [1513](#)
- COALESCE function [337](#)
- COBOL
 - application program
 - host structure arrays [147](#)
 - host variable [140](#), [146](#)
 - integers [67](#)
 - varying-length string variables [69](#)
 - SQLCA (SQL communication area) [1663](#)
 - SQLDA (SQL descriptor area) [1683](#)
- code page [29](#)
- code point [29](#)
- collating sequence
 - ICU [33](#)
 - interfaces [34](#), [35](#)
- collection
 - in SQL path [57](#)
- collection (see schema)
 - description [4](#)
- column
 - definition [4](#)
 - length attribute [69](#), [72](#)
 - name
 - in a result [727](#)
 - qualified [133](#)
 - system column name [4](#)
- COLUMN clause
 - COMMENT statement [935](#)
 - LABEL statement [1403](#)
- column function [148](#), [259](#)
- column in a group-by clause
 - equivalent term [1992](#)
- column view
 - SYSCOLAUTH [1709](#)
- COLUMN_NAME
 - GET DIAGNOSTICS statement [1335](#)
 - SIGNAL statement [1543](#)
- COLUMN_PRIVILEGES view [1941](#)
- column-name
 - definition [48](#)
 - in ADD PRIMARY clause of ALTER TABLE statement [882](#)
 - in ADD UNIQUE clause of ALTER TABLE statement [882](#)
 - in ALTER TABLE statement [871](#), [879](#)
 - in CREATE INDEX statement [1049](#)
 - in CREATE TABLE statement [1118](#), [1139](#), [1140](#)
 - in CREATE VIEW statement [1200](#)
 - in DECLARE GLOBAL TEMPORARY TABLE statement [1223](#)
 - in DROP COLUMN of ALTER TABLE statement [882](#)
 - in FOREIGN KEY clause of ALTER TABLE statement [883](#)
 - in INSERT statement [1391](#)
 - in LABEL statement [1403](#)
 - in MERGE statement [1415](#)
 - in REFERENCES clause of ALTER TABLE statement [883](#)
 - in UPDATE statement [1555](#)
- COLUMNS view [1942](#)
- combining characters
 - CREATE TABLE statement [1123](#)
- COMMAND_FUNCTION

COMMAND_FUNCTION (*continued*)
 GET DIAGNOSTICS statement [1330](#)
 COMMAND_FUNCTION_CODE
 GET DIAGNOSTICS statement [1330](#)
 comment
 in catalog table [930](#)
 SQL 44, [803](#)
 COMMENT statement
 name qualification [133](#)
 COMMIT
 effect on SET TRANSACTION [1538](#)
 COMMIT clause
 in SET OPTION statement [1513](#)
 COMMIT ON RETURN clause
 CREATE PROCEDURE (external) [1077](#)
 CREATE PROCEDURE (SQL) [1089](#)
 commit point [940](#)
 COMMIT statement [940](#), [942](#)
 commitment definition [17](#)
 common table expression
 CREATE VIEW statement [1201](#)
 definition [778](#)
 recursive [779](#)
 select statement [778](#)
 COMPARE_DECFLOAT function [338](#)
 comparison
 array type values [106](#)
 compatibility rules [91](#)
 conversion rules [103](#)
 DataLink [105](#)
 date and time values [104](#)
 distinct type values [105](#)
 numbers [101](#)
 predicate
 equivalent term [1991](#)
 predicate subquery
 equivalent term [1991](#)
 Row ID [105](#)
 strings [102](#)
 comparisons
 XML [105](#)
 compatibility
 data types [91](#)
 rules [91](#)
 COMPILEOPT clause
 in SET OPTION statement [1514](#)
 composite key [5](#)
 compound statement [943](#)
 compound-statement [1588](#)
 CONCAT (concatenation operator) [164](#)
 CONCAT function [339](#)
 concatenation operator (CONCAT) [164](#)
 concurrency
 with LOCK TABLE statement [1408](#)
 concurrent-access-resolution-clause
 in DELETE statement [1254](#)
 in MERGE statement [1417](#)
 in PREPARE statement [1432](#)
 in UPDATE statement [1557](#)
 CONDITION_IDENTIFIER
 GET DIAGNOSTICS statement [1335](#)
 CONDITION_NUMBER
 GET DIAGNOSTICS statement [1335](#)
 CONNECT
 differences, type 1 and type 2 [1654](#)
 CONNECT (type 1) statement [952](#), [956](#)
 CONNECT (type 2) statement [957](#), [960](#)
 CONNECT BY clause [742](#)
 CONNECT_BY_ISCYCLE pseudo column [745](#)
 CONNECT_BY_ISLEAF pseudo column [745](#)
 CONNECT_BY_ROOT unary operator [746](#)
 connected state [40](#)
 connection
 changing with SET CONNECTION [1485](#)
 ending [1447](#)
 releasing [1447](#)
 SQL 38
 connection states
 activation group [40](#)
 CONNECT (Type 2) statement [38](#)
 distributed unit of work [39](#)
 remote unit of work [37](#)
 CONNECTION_NAME
 GET DIAGNOSTICS statement [1333](#)
 constant
 DECLARE GLOBAL TEMPORARY TABLE statement [1225](#)
 in ALTER TABLE statement [872](#), [873](#)
 in CREATE TABLE statement [1125](#)
 in LABEL statement [1406](#)
 constants
 binary string [117](#)
 character string [115](#)
 datetime [118](#)
 decimal [114](#)
 decimal floating-point [114](#)
 floating point [114](#)
 graphic string [116](#)
 hexadecimal [115](#), [117](#)
 integer [114](#)
 UCS-2 [117](#)
 UTF-16 [117](#)
 CONSTRAINT clause
 COMMENT statement [935](#)
 in ALTER TABLE statement [877](#), [882](#)–[884](#)
 in CREATE TABLE statement [1130](#), [1139](#), [1141](#)
 LABEL statement [1403](#)
 CONSTRAINT_CATALOG
 GET DIAGNOSTICS statement [1335](#)
 SIGNAL statement [1543](#)
 CONSTRAINT_NAME
 GET DIAGNOSTICS statement [1335](#)
 SIGNAL statement [1543](#)
 CONSTRAINT_SCHEMA
 GET DIAGNOSTICS statement [1335](#)
 SIGNAL statement [1543](#)
 constraint-name
 description [48](#)
 in ALTER TABLE statement [877](#), [882](#), [884](#)
 in CONSTRAINT clause of ALTER TABLE statement [883](#)
 in CREATE TABLE statement [1130](#), [1139](#), [1141](#)
 in DROP CHECK clause of ALTER TABLE statement [886](#)
 in DROP CONSTRAINT clause of ALTER TABLE statement [886](#)
 in DROP FOREIGN KEY clause of ALTER TABLE statement [886](#)
 in DROP UNIQUE clause of ALTER TABLE statement [886](#)
 constraints

constraints (*continued*)
 check constraint [5](#)
 referential constraint [5](#)
 unique constraint [5](#)

CONTAINS function
 example [1983](#)

CONTAINS SQL clause
 CREATE PROCEDURE (external) [1074](#)
 in CREATE FUNCTION (external scalar) [981](#)
 in CREATE FUNCTION (external table) [1000](#)
 in CREATE FUNCTION (SQL scalar) [1025](#)
 in CREATE FUNCTION (SQL table) [1039](#)
 in CREATE PROCEDURE (SQL) [1088](#)
 in DECLARE PROCEDURE [1243](#)
 NO SQL clause
 in CREATE FUNCTION (external scalar) [981](#)

CONTINUE clause
 WHENEVER statement [1567](#)

control characters [44](#)

conversion of numbers
 conversion rule for comparisons [96](#)
 scale and precision [93](#)

CORR
 aggregate function [263](#)

correlated reference
 equivalent term [1992](#)

CORRELATION
 aggregate function [263](#)

correlation clause [730](#)

correlation name
 defining [133](#)
 description [49](#)
 FROM clause
 of subselect [732](#)
 qualifying a column name [133](#)

correlation-name
 in DELETE statement [1252](#)
 in UPDATE statement [1554](#)

COS function [343](#)

COSH function [344](#)

COT function [345](#)

COUNT
 GET DESCRIPTOR statement [1313](#)
 SET DESCRIPTOR statement [1499](#)

COUNT function [264](#)

COUNT_BIG function [265](#)

COVAR
 aggregate function [266](#)

COVAR_POP
 aggregate function [266](#)

COVAR_SAMP
 aggregate function [267](#)

COVARIANCE
 aggregate function [266](#)

COVARIANCE_SAMP
 aggregate function [267](#)

CREATE ALIAS statement [12](#), [961](#), [964](#)

CREATE FUNCTION (external scalar) statement [970](#), [989](#)

CREATE FUNCTION (external table) statement [990](#)

CREATE FUNCTION (sourced) statement [1008](#)

CREATE FUNCTION (SQL scalar) [1021](#)

CREATE FUNCTION (SQL scalar) statement [1018](#)

CREATE FUNCTION (SQL table) [1035](#)

CREATE FUNCTION (SQL table) statement [1032](#)

CREATE INDEX statement [1045](#)

CREATE MASK statement [1054](#)

CREATE PERMISSION statement [1060](#)

CREATE PROCEDURE (external) statement [1065](#)

CREATE PROCEDURE (SQL) statement [1080](#), [1092](#)

CREATE SCHEMA statement [1093](#), [1097](#)

CREATE SEQUENCE statement [1098](#)

CREATE TABLE statement [1105](#)

CREATE TRIGGER statement [1160](#)

CREATE TYPE (array) statement [1179](#)

CREATE TYPE (distinct) statement [1184](#)

CREATE VARIABLE statement [1192](#)

CREATE VIEW statement [11](#), [1198](#), [1205](#)

CREATE_WRAPPED procedure [712](#)

CREATEIN clause
 GRANT (schema privileges) statement [1360](#)

CREATIN clause
 REVOKE (schema privileges) statement [1461](#)

CROSS JOIN clause
 in FROM clause [740](#)

CS (cursor stability) [26](#)

CUBE [753](#)

CUME_DIST
 in OLAP specification [186](#)

CURDATE function [346](#)

CURRENT
 in GET DIAGNOSTICS [1328](#), [1602](#)

CURRENT clause
 in DISCONNECT statement [1278](#)
 in FETCH statement [1304](#)
 in RELEASE statement [1447](#)

CURRENT CLIENT_ACCTNG special register [123](#)

CURRENT CLIENT_APPLNAME special register [123](#)

CURRENT CLIENT_PROGRAMID special register [123](#)

CURRENT CLIENT_USERID special register [124](#)

CURRENT CLIENT_WRKSTNAME special register [124](#)

current connection state [39](#)

CURRENT DATE special register [125](#)

CURRENT DEBUG MODE special register [125](#)

current decfloat rounding mode special register
 SET CURRENT DECFLOAT ROUNDING MODE [1490](#)

CURRENT DECFLOAT ROUNDING MODE special register [126](#)

CURRENT DEGREE special register [127](#)

current implicit XMLPARSE OPTION special register
 SET CURRENT IMPLICIT XMLPARSE OPTION [1495](#)

CURRENT IMPLICIT XMLPARSE OPTION special register [127](#)

current path special register
 SET PATH [1524](#)
 SET SCHEMA [1530](#)

CURRENT PATH special register [128](#), [1525](#)

CURRENT SCHEMA special register [129](#)

CURRENT SERVER special register [129](#)

CURRENT TEMPORAL SYSTEM_TIME special register [129](#),
[732](#)

CURRENT TIME special register [130](#)

CURRENT TIMESTAMP special register [131](#)

CURRENT TIMEZONE special register [131](#)

CURRENT USER special register [131](#), [1525](#)

CURRENT_DATE
 ALTER TABLE statement [872](#), [873](#)
 CREATE TABLE statement [1124](#), [1125](#)
 DECLARE GLOBAL TEMPORARY TABLE statement [1224](#),
[1225](#)

CURRENT_DATE special register [125](#)

CURRENT_PATH special register [128](#)
 CURRENT_SCHEMA special register [129](#)
 CURRENT_SERVER special register [129](#)
 CURRENT_TIME
 ALTER TABLE statement [872](#), [873](#)
 CREATE TABLE statement [1124](#), [1125](#)
 DECLARE GLOBAL TEMPORARY TABLE statement [1224](#),
 [1225](#)
 CURRENT_TIME special register [130](#)
 CURRENT_TIMESTAMP
 ALTER TABLE statement [872](#), [873](#)
 CREATE TABLE statement [1124](#), [1125](#)
 DECLARE GLOBAL TEMPORARY TABLE statement [1224](#),
 [1225](#)
 CURRENT_TIMESTAMP special register [131](#)
 CURRENT_TIMEZONE special register [131](#)
 cursor
 active set [1421](#)
 closed by error
 FETCH statement [1307](#)
 UPDATE [1560](#)
 closed state [1423](#)
 closing [928](#)
 current row [1307](#)
 defining [1207](#)
 deletable [1210](#)
 moving position [1303](#)
 positions for open [1307](#)
 preparing [1421](#)
 read-only [1211](#)
 updatable [1211](#)
 cursor stability [26](#)
 CURSOR_NAME
 GET DIAGNOSTICS statement [1335](#)
 SIGNAL statement [1543](#)
 cursor-name
 description [49](#)
 in CLOSE statement [928](#)
 in DECLARE CURSOR statement [1208](#)
 in DELETE statement [1253](#)
 in FETCH statement [1305](#)
 in OPEN statement [1421](#)
 in SET RESULT SETS statement [1527](#)
 in UPDATE statement [1556](#)
 CURTIME function [347](#)
 CYCLE clause
 CREATE SEQUENCE statement [1101](#)
 in ALTER TABLE statement [881](#)
 of recursive common-table-expression [780](#)

D

DATA
 GET DESCRIPTOR statement [1315](#)
 SET DESCRIPTOR statement [1499](#)
 data access classification [1647](#)
 DATA DICTIONARY clause
 CREATE SCHEMA statement [1096](#)
 data representation
 in DRDA [41](#)
 data type
 array types [82](#)
 binary string [72](#)
 character string [69](#)

data type (*continued*)
 DataLink [81](#)
 datetime [74](#), [75](#)
 description [65](#), [1118](#)
 distinct types [82](#)
 in SQLDA [1668](#)
 large object (LOB) [73](#)
 numeric [66](#)
 result columns [728](#)
 Row ID [82](#)
 user-defined types (UDTs) [82](#)
 data type for CREATE FUNCTION (SQL scalar) [1021](#)
 data type for CREATE FUNCTION (SQL table) [1035](#)
 data-type
 CREATE PROCEDURE (external) [1071](#)
 in ALTER FUNCTION (SQL scalar) [823](#)
 in ALTER FUNCTION (SQL table) [831](#)
 in ALTER PROCEDURE (SQL) [850](#)
 in ALTER TABLE [871](#)
 in ALTER TABLE statement [871](#), [879](#)
 in CAST specification [179](#)
 in CREATE FUNCTION (external scalar) [977](#)
 in CREATE FUNCTION (external table) [998](#)
 in CREATE FUNCTION (sourced) [1011](#), [1012](#)
 in CREATE FUNCTION (SQL scalar) [1024](#)
 in CREATE FUNCTION (SQL table) [1038](#)
 in CREATE PROCEDURE (SQL) [1086](#)
 in CREATE TABLE [1118](#)
 in DECLARE GLOBAL TEMPORARY TABLE [1223](#)
 in DECLARE GLOBAL TEMPORARY TABLE statement
 [1223](#)
 in DECLARE PROCEDURE statement [1240](#)
 DATABASE
 function [348](#)
 database manager limits [1639–1642](#)
 DataLink
 assignment [98](#)
 comparison [105](#)
 data type
 description [81](#)
 limits [1639](#)
 DATALINK
 data type for CREATE FUNCTION (sourced) [1011](#)
 data type for CREATE PROCEDURE (SQL) [1086](#)
 data type for CREATE TABLE [1121](#)
 DECLARE PROCEDURE statement [1240](#)
 datalink-options
 in ALTER TABLE statement [878](#)
 in CREATE TABLE statement [1131](#)
 in DECLARE GLOBAL TEMPORARY TABLE statement
 [1229](#)
 DATAPARTITIONNAME function [349](#)
 DATAPARTITIONNUM function [350](#)
 date
 duration [167](#)
 strings [76](#)
 DATE
 arithmetic operations [168](#)
 assignment [97](#)
 data type [74](#)
 data type for CREATE TABLE [1121](#)
 function [351](#)
 date and time
 arithmetic operations [168](#), [171](#)

date and time (*continued*)
 assignments [97](#)
 comparisons [104](#)
 data types
 string representation [76](#)
 default date format [76](#)
 default time format [78](#)
 format
 day/month/year [76](#)
 EUR [76](#), [77](#)
 hours/minutes/seconds [77](#)
 ISO [76](#), [77](#)
 JIS [76](#), [77](#)
 Julian [76](#)
 month/day/year [76](#)
 unformatted Julian [76](#)
 USA [76](#), [77](#)
 year/month/day [76](#)
 datetime
 constants [118](#)
 data types
 description [74](#), [75](#)
 limits [1639](#)
 DATETIME_INTERVAL_CODE
 GET DESCRIPTOR statement [1315](#)
 SET DESCRIPTOR statement [1500](#)
 DATFMT clause
 in SET OPTION statement [1514](#)
 DATSEP clause
 in SET OPTION statement [1515](#)
 DAY function [353](#)
 DAYNAME function [354](#)
 DAYOFMONTH function [355](#)
 DAYOFWEEK function [356](#)
 DAYOFWEEK_ISO function [357](#)
 DAYOFYEAR function [358](#)
 DAYS function [359](#)
 DB2_AUTHENTICATION_TYPE
 GET DIAGNOSTICS statement [1333](#)
 DB2_AUTHORIZATION_ID
 GET DIAGNOSTICS statement [1333](#)
 DB2_BASE_CATALOG_NAME
 GET DESCRIPTOR statement [1315](#)
 DB2_BASE_COLUMN_NAME
 GET DESCRIPTOR statement [1315](#)
 DB2_BASE_SCHEMA_NAME
 GET DESCRIPTOR statement [1315](#)
 DB2_BASE_TABLE_NAME
 GET DESCRIPTOR statement [1315](#)
 DB2_CCSDID
 GET DESCRIPTOR statement [1315](#)
 SET DESCRIPTOR statement [1500](#)
 DB2_COLUMN_CATALOG_NAME
 GET DESCRIPTOR statement [1315](#)
 DB2_COLUMN_GENERATED
 GET DESCRIPTOR statement [1315](#)
 DB2_COLUMN_GENERATION_TYPE
 GET DESCRIPTOR statement [1316](#)
 DB2_COLUMN_HIDDEN
 GET DESCRIPTOR statement [1316](#)
 DB2_COLUMN_NAME
 GET DESCRIPTOR statement [1316](#)
 DB2_COLUMN_ROW_CHANGE
 GET DESCRIPTOR statement [1316](#)

 DB2_COLUMN_SCHEMA_NAME
 GET DESCRIPTOR statement [1317](#)
 DB2_COLUMN_TABLE_NAME
 GET DESCRIPTOR statement [1317](#)
 DB2_COLUMN_UPDATABILITY
 GET DESCRIPTOR statement [1317](#)
 DB2_CONNECTION_METHOD
 GET DIAGNOSTICS statement [1333](#)
 DB2_CONNECTION_NUMBER
 GET DIAGNOSTICS statement [1333](#)
 DB2_CONNECTION_STATE
 GET DIAGNOSTICS statement [1333](#)
 DB2_CONNECTION_STATUS
 GET DIAGNOSTICS statement [1334](#)
 DB2_CONNECTION_TYPE
 GET DIAGNOSTICS statement [1334](#)
 DB2_CORRELATION_NAME
 GET DESCRIPTOR statement [1317](#)
 DB2_CURSOR_HOLDABILITY
 GET DESCRIPTOR statement [1313](#)
 DB2_CURSOR_NAME
 GET DESCRIPTOR statement [1317](#)
 DB2_CURSOR_RETURNABILITY
 GET DESCRIPTOR statement [1313](#)
 DB2_CURSOR_SCROLLABILITY
 GET DESCRIPTOR statement [1314](#)
 DB2_CURSOR_SENSITIVITY
 GET DESCRIPTOR statement [1314](#)
 DB2_CURSOR_UPDATABILITY
 GET DESCRIPTOR statement [1314](#)
 DB2_DIAGNOSTIC_CONVERSION_ERROR
 GET DIAGNOSTICS statement [1330](#)
 DB2_DYN_QUERY_MGMT
 GET DIAGNOSTICS statement [1334](#)
 DB2_ENCRYPTION_TYPE
 GET DIAGNOSTICS statement [1334](#)
 DB2_ERROR_CODE1
 GET DIAGNOSTICS statement [1335](#)
 DB2_ERROR_CODE2
 GET DIAGNOSTICS statement [1335](#)
 DB2_ERROR_CODE3
 GET DIAGNOSTICS statement [1336](#)
 DB2_ERROR_CODE4
 GET DIAGNOSTICS statement [1336](#)
 DB2_GET_DIAGNOSTICS_DIAGNOSTICS
 GET DIAGNOSTICS statement [1330](#)
 DB2_INTERNAL_ERROR_POINTER
 GET DIAGNOSTICS statement [1336](#)
 DB2_LABEL
 GET DESCRIPTOR statement [1317](#)
 DB2_LAST_ROW
 GET DIAGNOSTICS statement [1330](#)
 DB2_LINE_NUMBER
 GET DIAGNOSTICS statement [1336](#)
 DB2_MAX_ITEMS
 GET DESCRIPTOR statement [1314](#)
 DB2_MESSAGE_ID
 GET DIAGNOSTICS statement [1336](#)
 DB2_MESSAGE_ID1
 GET DIAGNOSTICS statement [1336](#)
 DB2_MESSAGE_ID2
 GET DIAGNOSTICS statement [1336](#)
 DB2_MESSAGE_KEY
 GET DIAGNOSTICS statement [1336](#)

DB2_MODULE_DETECTING_ERROR
 GET DIAGNOSTICS statement [1336](#)
 DB2_NUMBER_CONNECTIONS
 GET DIAGNOSTICS statement [1330](#)
 DB2_NUMBER_FAILING_STATEMENTS
 GET DIAGNOSTICS statement [1336](#)
 DB2_NUMBER_PARAMETER_MARKERS
 GET DIAGNOSTICS statement [1330](#)
 DB2_NUMBER_RESULT_SETS
 GET DIAGNOSTICS statement [1330](#)
 DB2_NUMBER_ROWS
 GET DIAGNOSTICS statement [1330](#)
 DB2_NUMBER_SUCCESSFUL_
 GET DIAGNOSTICS statement [1331](#)
 DB2_OFFSET
 GET DIAGNOSTICS statement [1336](#)
 DB2_ORDINAL_TOKEN_n
 GET DIAGNOSTICS statement [1336](#)
 DB2_PARAMETER_NAME
 GET DESCRIPTOR statement [1317](#)
 DB2_PARTITION_NUMBER
 GET DIAGNOSTICS statement [1336](#)
 DB2_PRODUCT_ID
 GET DIAGNOSTICS statement [1334](#)
 DB2_REASON_CODE
 GET DIAGNOSTICS statement [1336](#)
 DB2_RELATIVE_COST_ESTIMATE
 GET DIAGNOSTICS statement [1331](#)
 DB2_RESULT_SET_LOCATOR
 GET DESCRIPTOR statement [1317](#)
 DB2_RESULT_SET_ROWS
 GET DESCRIPTOR statement [1317](#)
 DB2_RESULT_SETS_COUNT
 GET DESCRIPTOR statement [1314](#)
 DB2_RETURN_STATUS
 GET DIAGNOSTICS statement [1331](#)
 DB2_RETURNED_SQLCODE
 GET DIAGNOSTICS statement [1336](#)
 DB2_ROW_COUNT_SECONDARY
 GET DIAGNOSTICS statement [1331](#)
 DB2_ROW_LENGTH
 GET DIAGNOSTICS statement [1331](#)
 DB2_ROW_NUMBER
 GET DIAGNOSTICS statement [1337](#)
 DB2_SERVER_CLASS_NAME
 GET DIAGNOSTICS statement [1334](#)
 DB2_SERVER_NAME
 GET DIAGNOSTICS statement [1334](#)
 DB2_SQL_ATTR_CONCURRENCY
 GET DIAGNOSTICS statement [1331](#)
 DB2_SQL_ATTR_CURSOR_CAPABILITY
 GET DIAGNOSTICS statement [1331](#)
 DB2_SQL_ATTR_CURSOR_HOLD
 GET DIAGNOSTICS statement [1331](#)
 DB2_SQL_ATTR_CURSOR_ROWSET
 GET DIAGNOSTICS statement [1332](#)
 DB2_SQL_ATTR_CURSOR_SCROLLABLE
 GET DIAGNOSTICS statement [1332](#)
 DB2_SQL_ATTR_CURSOR_SENSITIVITY
 GET DIAGNOSTICS statement [1332](#)
 DB2_SQL_ATTR_CURSOR_TYPE
 GET DIAGNOSTICS statement [1332](#)
 DB2_SQL_NESTING_LEVEL
 GET DIAGNOSTICS statement [1332](#)
 DB2_SQLERRD_SET
 GET DIAGNOSTICS statement [1337](#)
 DB2_SQLERRD1
 GET DIAGNOSTICS statement [1337](#)
 DB2_SQLERRD2
 GET DIAGNOSTICS statement [1337](#)
 DB2_SQLERRD3
 GET DIAGNOSTICS statement [1337](#)
 DB2_SQLERRD4
 GET DIAGNOSTICS statement [1337](#)
 DB2_SQLERRD5
 GET DIAGNOSTICS statement [1337](#)
 DB2_SQLERRD6
 GET DIAGNOSTICS statement [1337](#)
 DB2_SYSTEM_COLUMN_NAME
 GET DESCRIPTOR statement [1317](#)
 DB2_TOKEN_COUNT
 GET DIAGNOSTICS statement [1337](#)
 DB2_TOKEN_STRING
 GET DIAGNOSTICS statement [1337](#)
 DB2GENERAL clause
 CREATE PROCEDURE (external) [1073](#)
 DECLARE PROCEDURE [1242](#)
 in CREATE FUNCTION (external scalar) [980](#)
 in CREATE FUNCTION (external table) [999](#)
 DBCLOB
 data type for ALTER TABLE [871](#)
 data type for CREATE FUNCTION (external scalar) [975](#)
 data type for CREATE FUNCTION (external table) [995](#)
 data type for CREATE FUNCTION (sourced) [1011](#)
 data type for CREATE PROCEDURE (external) [1070](#)
 data type for CREATE PROCEDURE (SQL) [1086](#)
 data type for CREATE TABLE [1120](#)
 data type for CREATE TYPE [1187](#)
 data type for DECLARE GLOBAL TEMPORARY TABLE [1223](#)
 DECLARE PROCEDURE statement [1240](#)
 function [360](#)
 DBCS (double-byte character set)
 description [72](#)
 truncated during assignment [97](#)
 DBGVIEW clause
 in SET OPTION statement [1515](#)
 DBINFO clause
 CREATE PROCEDURE (external) [1075](#)
 in CREATE FUNCTION (external scalar) [982](#)
 in CREATE FUNCTION (external table) [1001](#)
 DBPARTITIONNAME function [366](#)
 DBPARTITIONNUM function [367](#)
 DEALLOCATE DESCRIPTOR statement [1206](#)
 DEBUG MODE clause
 CREATE FUNCTION (SQL scalar) [1026](#)
 CREATE PROCEDURE (external) [1075](#)
 CREATE PROCEDURE (SQL) [1088](#)
 DECFLOAT
 data type for CREATE FUNCTION (external scalar) [975](#)
 data type for CREATE FUNCTION (external table) [995](#)
 data type for CREATE FUNCTION (sourced) [1011](#)
 data type for CREATE PROCEDURE (external) [1070](#)
 data type for CREATE PROCEDURE (SQL) [1086](#)
 data type for CREATE TABLE [1119](#)
 data type for CREATE TYPE [1187](#)
 data type for DECLARE GLOBAL TEMPORARY TABLE [1223](#)

DECFLOAT (*continued*)
 data type for DECLARE PROCEDURE [1240](#)
 DECFLOAT function [368](#)
 DECFLOAT_FORMAT
 function [370](#)
 DECFLOAT_SORTKEY function [372](#)
 DECFLTRND clause
 in SET OPTION statement [1516](#)
 decimal
 constants [114](#)
 data type [67](#)
 numbers [67](#)
 DECIMAL
 data type for ALTER TABLE [871](#)
 data type for CREATE FUNCTION (external scalar) [975](#)
 data type for CREATE FUNCTION (external table) [995](#)
 data type for CREATE FUNCTION (sourced) [1011](#)
 data type for CREATE PROCEDURE (external) [1070](#)
 data type for CREATE PROCEDURE (SQL) [1086](#)
 data type for CREATE TABLE [1118](#)
 data type for CREATE TYPE [1187](#)
 data type for DECLARE GLOBAL TEMPORARY TABLE [1223](#)
 data type for DECLARE PROCEDURE [1240](#)
 decimal data
 arithmetic [161](#)
 decimal floating-point
 constants [114](#)
 numbers [68](#)
 DECIMAL function [373](#)
 decimal point
 default decimal point [118](#)
 declaration
 inserting into a program [1385](#)
 DECLARE CURSOR statement [1207](#), [1209](#), [1214](#)
 DECLARE GLOBAL TEMPORARY TABLE statement [1215](#), [1235](#)
 DECLARE PROCEDURE statement [1236](#), [1245](#)
 DECLARE STATEMENT statement [1246](#), [1247](#)
 DECLARE statements
 BEGIN DECLARE SECTION statement [918](#)
 END DECLARE SECTION statement [1295](#)
 DECLARE VARIABLE statement [1248](#), [1250](#)
 DECMPT clause
 in SET OPTION statement [1516](#)
 DECRESULT clause
 in SET OPTION statement [1517](#)
 DECRYPT_BIN function [376](#)
 DECRYPT_BINARY function [376](#)
 DECRYPT_BIT function [376](#)
 DECRYPT_CHAR function [376](#)
 DECRYPT_DB function [376](#)
 DEFAULT
 in CALL statement [923](#), [1585](#)
 in SET variable statement [1540](#)
 in UPDATE statement [1556](#)
 DEFAULT clause
 ALTER TABLE statement [871](#)
 CREATE TABLE statement [1123](#)
 in DECLARE GLOBAL TEMPORARY TABLE statement [1223](#)
 in INSERT statement [1392](#)
 in MERGE statement [1415](#)
 default date format [75](#), [76](#)
 default decimal point [118](#)
 default decimal separator character
 description [68](#)
 default schema
 name qualification [58](#)
 default time format [75](#), [78](#)
 DEFAULT VALUES
 in INSERT statement [1391](#)
 degree
 of table
 equivalent term [1991](#)
 DEGREES function [379](#)
 DELETE
 performance [1255](#)
 DELETE clause
 GRANT (table or view privileges) statement [1367](#)
 in ON DELETE clause of ALTER TABLE statement [884](#)
 in ON DELETE clause of CREATE TABLE statement [1140](#)
 REVOKE (table or view privileges) statement [1466](#)
 DELETE ROWS
 ALTER TABLE statement [887](#)
 delete rules
 check constraints [1254](#)
 referential constraint [8](#)
 referential integrity [1254](#)
 triggers [1254](#)
 DELETE statement [1251](#), [1257](#)
 delete-connected table [8](#)
 deleting SQL objects [1280](#)
 delimited identifier
 in system names [46](#)
 DENSE_RANK
 in OLAP specification [186](#)
 dependent row [6](#)
 dependent table [6](#)
 derived table [730](#)
 DESC clause
 CREATE INDEX statement [1050](#)
 in OLAP specification [187](#)
 of select-statement [766](#)
 descendent row [6](#)
 descendent table [6](#)
 DESCRIBE CURSOR statement
 description [1264](#)
 variables
 SQLD [1264](#)
 SQLDABC [1264](#)
 SQLDAID [1264](#)
 SQLN [1264](#)
 SQLVAR [1264](#)
 DESCRIBE INPUT statement
 description [1267](#)
 variables
 SQLD [1266](#)
 SQLDABC [1266](#)
 SQLDAID [1266](#)
 SQLN [1265](#)
 SQLVAR [1266](#)
 DESCRIBE PROCEDURE statement
 description [1273](#)
 variables
 SQLD [1272](#)
 SQLDABC [1272](#)
 SQLDAID [1271](#)

DESCRIBE PROCEDURE statement (*continued*)
 variables (*continued*)
 SQLN [1271](#)
 SQLVAR [1272](#)

DESCRIBE statement
 variables
 SQLD [1259](#)
 SQLDABC [1259](#)
 SQLDAID [1259](#)
 SQLN [1259](#)
 SQLVAR [1259](#)

DESCRIBE TABLE statement
 description [1277](#)
 variables
 SQLD [1275](#)
 SQLDABC [1275](#)
 SQLDAID [1275](#)
 SQLN [1275](#)
 SQLVAR [1275](#)

descriptor-name
 description [49](#)
 in CALL statement [924](#)
 in DESCRIBE statement [1259](#)
 in EXECUTE statement [1298](#)
 in FETCH statement [1305](#)
 in OPEN statement [1422](#)
 in PREPARE statement [1430](#)

designator
 table [135](#), [424](#), [545](#), [557](#)

DETACH PARTITION
 ALTER TABLE statement [889](#)

detecting and processing error and warning conditions
 SQL-procedure-statement [1579](#)

DETERMINISTIC clause
 CREATE PROCEDURE (external) [1073](#)
 in CREATE FUNCTION (external scalar) [981](#)
 in CREATE FUNCTION (external table) [1000](#)
 in CREATE FUNCTION (SQL scalar) [1024](#)
 in CREATE FUNCTION (SQL table) [1038](#)
 in CREATE PROCEDURE (SQL) [1087](#)
 in DECLARE PROCEDURE [1243](#)

DFTRDBCOL clause
 in SET OPTION statement [1517](#)

DIFFERENCE function [380](#)

DIGITS function [381](#)

dirty read [28](#)

DISALLOW PARALLEL clause
 in CREATE FUNCTION (external scalar) [985](#)
 in CREATE FUNCTION (external table) [1005](#)
 in CREATE FUNCTION (SQL scalar) [1027](#)
 in CREATE FUNCTION (SQL table) [1040](#)

DISCONNECT statement
 DISCONNECT [1279](#)

disconnecting SQL objects [1278](#)

DISTINCT
 AVG function [262](#)
 COUNT function [264](#)
 COUNT_BIG function [265](#)
 MAX function [281](#)
 MIN function [283](#)
 STDDEV function [291](#)
 STDDEV_POP function [291](#)
 STDDEV_SAMP function [292](#)
 SUM function [293](#)

DISTINCT (*continued*)
 VAR function [294](#)
 VAR_POP function [294](#)
 VAR_SAMP function [295](#)
 VARIANCE function [294](#)
 VARIANCE_SAMP function [295](#)

DISTINCT clause
 subselect [725](#)

DISTINCT predicate [205](#)

distinct type
 assignment [100](#)
 comparisons [105](#)

DISTINCT TYPE clause
 COMMENT statement [930](#)

distinct types
 data types
 description [82](#)

distinct-type
 data type for ALTER SEQUENCE [855](#)
 data type for ALTER TABLE [871](#)
 data type for CREATE FUNCTION (external scalar) [975](#)
 data type for CREATE FUNCTION (external table) [995](#)
 data type for CREATE FUNCTION (sourced) [1011](#)
 data type for CREATE PROCEDURE (external) [1070](#)
 data type for CREATE PROCEDURE (SQL) [1086](#)
 data type for CREATE SEQUENCE [1100](#)
 data type for CREATE TABLE [1122](#)
 data type for CREATE TYPE [1187](#)
 data type for CREATE VARIABLE [1195](#)
 data type for DECLARE GLOBAL TEMPORARY TABLE [1223](#)
 DECLARE PROCEDURE statement [1240](#)
 in DECLARE GLOBAL TEMPORARY TABLE statement [1223](#)

distinct-type-name
 description [49](#)
 in CREATE TYPE statement [1186](#)

distributed data
 CONNECT statement [1654](#)

distributed relational database
 application requester [35](#)
 application server [35](#)
 application-directed distributed unit of work [39](#)
 considerations for using [1650](#), [1652–1654](#)
 data representation considerations [41](#)
 distributed unit of work [39](#)
 remote unit of work [37](#)
 use of extensions to IBM SQL on unlike application servers [1650](#), [1652–1654](#)

distributed relational database architecture (DRDA) [35](#)

distributed tables
 definition [5](#)
 syntax [1144](#)

distributed unit of work
 mixed environment [1644](#)

division by zero [176](#)

division operator [160](#)

DLCOMMENT function [382](#)

DLLINKTYPE function [383](#)

DLURLCOMPLETE function [384](#)

DLURLPATH function [385](#)

DLURLPATHONLY function [386](#)

DLURLSCHEME function [387](#)

DLURLSERVER function [388](#)

- DLVALUE function [389](#)
- DLYPRP clause
 - in SET OPTION statement [1517](#)
- dormant connection state [39](#)
- DOUBLE
 - function [391](#)
- DOUBLE PRECISION
 - data type for ALTER TABLE [871](#)
 - data type for CREATE FUNCTION (external scalar) [975](#)
 - data type for CREATE FUNCTION (external table) [995](#)
 - data type for CREATE FUNCTION (sourced) [1011](#)
 - data type for CREATE PROCEDURE (external) [1070](#)
 - data type for CREATE PROCEDURE (SQL) [1086](#)
 - data type for CREATE TABLE [1119](#)
 - data type for CREATE TYPE [1187](#)
 - data type for DECLARE GLOBAL TEMPORARY TABLE [1223](#)
 - data type for DECLARE PROCEDURE [1240](#)
- DOUBLE_PRECISION function [391](#)
- double-byte character
 - in COMMENT statement [938](#)
 - in LIKE predicates [217](#)
 - truncated during assignment [96](#)
- double-byte character set (DBCS)
 - truncated during assignment [97](#)
- double-precision floating point [68](#)
- DRDA (Distributed Relational Database Architecture) [35](#)
- DROP CHECK clause
 - ALTER TABLE statement [886](#)
- DROP COLUMN clause
 - ALTER TABLE statement [881](#)
- DROP CONSTRAINT clause
 - ALTER TABLE statement [886](#)
- DROP DEFAULT clause
 - ALTER TABLE statement [881](#)
- DROP FIELDPROC clause
 - ALTER TABLE statement [881](#)
- DROP FOREIGN KEY clause
 - ALTER TABLE statement [886](#)
- DROP GENERATED clause
 - ALTER TABLE statement [881](#)
- DROP IDENTITY clause
 - ALTER TABLE statement [881](#)
- DROP materialized query clause
 - ALTER TABLE statement [891](#)
- DROP NOT NULL clause
 - ALTER TABLE statement [881](#)
- DROP PARTITION
 - ALTER TABLE statement [887](#)
- DROP PARTITIONING
 - ALTER TABLE statement [886](#)
- DROP PRIMARY KEY clause
 - ALTER TABLE statement [886](#)
- DROP ROW CHANGE TIMESTAMP clause
 - ALTER TABLE statement [881](#)
- DROP statement [1280](#), [1294](#)
- DROP UNIQUE clause
 - ALTER TABLE statement [886](#)
- duplicate rows with UNION [772](#)
- duration
 - date [167](#)
 - labeled [166](#)
 - time [167](#)
 - timestamp [167](#)

- dynamic select [801](#)
- dynamic SQL
 - defined [800](#)
 - description [2](#)
 - execution
 - EXECUTE IMMEDIATE statement [1301](#)
 - EXECUTE statement [1296](#)
 - in USING clause of DESCRIBE statement [1258](#)
 - obtaining input information with
 - DESCRIBE INPUT [1265](#)
 - obtaining statement information with
 - DESCRIBE [1258](#)
 - obtaining table information with
 - DESCRIBE TABLE [1274](#)
 - preparation and execution [801](#)
 - PREPARE statement [1427](#)
 - SQLDA (SQL descriptor area) [1667](#)
 - statements allowed [1644](#)
 - use of SQL path [57](#)
- DYNAMIC_FUNCTION
 - GET DESCRIPTOR statement [1314](#)
 - GET DIAGNOSTICS statement [1332](#)
- DYNAMIC_FUNCTION_CODE
 - GET DESCRIPTOR statement [1314](#)
 - GET DIAGNOSTICS statement [1332](#)
- DYNDFTCOL clause
 - in SET OPTION statement [1517](#)
- DYNUSRPRF clause
 - in SET OPTION statement [1518](#)

E

- EBNF grammar [1985](#)
- Embedded SQL for Java (SQLJ) [3](#)
- empty character string [69](#)
- ENCODED VECTOR clause
 - CREATE INDEX statement [1048](#)
- encoding scheme [29](#)
- ENCRYPT function [396](#)
- ENCRYPT_AES function [393](#)
- ENCRYPT_RC2 function [396](#)
- ENCRYPT_TDES function [399](#)
- END DECLARE SECTION statement [1295](#)
- ending
 - unit of work [940](#), [1475](#)
- equivalent terms [1991](#)
- error
 - closes cursor [1423](#)
 - during UPDATE [1560](#)
 - FETCH statement [1307](#)
- escape character in SQL
 - delimited identifier [46](#)
- ESCAPE clause of LIKE predicate [218](#)
- evaluation order [172](#)
- EVENTF clause
 - in SET OPTION statement [1518](#)
- EXCEPT clause
 - of fullselect [772](#)
- EXCLUDING clause
 - in CREATE TABLE statement [1134](#), [1136](#)
 - in DECLARE GLOBAL TEMPORARY TABLE statement [1231](#)
- EXCLUSIVE
 - ALLOW READ clause

EXCLUSIVE (*continued*)
 ALLOW READ clause (*continued*)
 LOCK TABLE statement [1408](#)
 IN EXCLUSIVE MODE clause
 LOCK TABLE statement [1408](#)
 exclusive locks [25](#)
 EXCLUSIVE MODE clause
 in LOCK TABLE statement [1408](#)
 executable statement [800](#)
 EXECUTE clause
 GRANT (function or procedure privileges) statement [1352](#)
 GRANT (package privileges) statement [1358](#)
 REVOKE (function or procedure privileges) statement [1456](#)
 REVOKE (package privileges) statement [1459](#)
 EXECUTE IMMEDIATE statement [1301](#)
 EXECUTE statement [1296](#), [1300](#)
 EXISTS predicate [207](#)
 EXP function [402](#)
 exponentiation operator [160](#)
 exposed name [732](#)
 expression
 ARRAY constructor [173](#)
 ARRAY element specification [174](#)
 CASE expression [175](#)
 CAST specification [177](#)
 date and time operands [166](#)
 decimal floating-point operands [162](#)
 decimal operands [161](#)
 distinct type operands [164](#)
 floating-point operands [162](#)
 grouping [751](#)
 in CALL statement [922](#), [923](#), [1585](#)
 in EXECUTE IMMEDIATE statement [1301](#)
 in INSERT statement [1392](#)
 in MERGE statement [1415](#)
 in PREPARE statement [1433](#)
 in statement [1540](#)
 in subselect [726](#)
 in UPDATE statement [1555](#)
 in VALUES INTO statement [1564](#)
 integer operands [160](#), [161](#)
 numeric operands [161](#)
 OLAP specifications [182](#)
 precedence of operation [172](#)
 scalar fullselect [166](#)
 scalar subselect [166](#)
 sequence reference [194](#)
 with arithmetic operators [160](#)
 with concatenation operator [164](#)
 without operators [160](#)
 XMLCAST specification [198](#)
 extended dynamic SQL
 description [2](#)
 external
 function [970](#), [990](#)
 EXTERNAL ACTION clause
 in CREATE FUNCTION (external scalar) [983](#)
 in CREATE FUNCTION (external table) [1003](#)
 in CREATE FUNCTION (SQL scalar) [1025](#)
 in CREATE FUNCTION (SQL table) [1039](#)
 EXTERNAL clause
 CREATE PROCEDURE (external) [1076](#)

EXTERNAL clause (*continued*)
 in CREATE FUNCTION (external scalar) [986](#)
 in CREATE FUNCTION (external table) [1005](#)
 in DECLARE PROCEDURE [1244](#)
 EXTERNAL NAME clause
 CREATE PROCEDURE (external) [1076](#)
 in CREATE FUNCTION (external scalar) [986](#)
 in CREATE FUNCTION (external table) [1005](#)
 in DECLARE PROCEDURE [1244](#)
 external-program-name
 description [49](#)
 EXTIND clause
 in SET OPTION statement [1518](#)
 EXTRACT
 function [403](#)

F

FENCED clause
 CREATE PROCEDURE (external) [1074](#)
 in CREATE FUNCTION (external scalar) [984](#)
 in CREATE FUNCTION (external table) [1003](#)
 in CREATE FUNCTION (SQL scalar) [1026](#)
 in CREATE FUNCTION (SQL table) [1040](#)
 in CREATE PROCEDURE (SQL) [1089](#)
 FETCH clause
 of select-statement [768](#)
 FETCH statement [1303](#), [1309](#)
 fetch-clause
 in DELETE statement [1253](#)
 in UPDATE statement [1557](#)
 FIELDPROC
 in ALTER TABLE statement [878](#), [880](#)
 in CREATE TABLE statement [1131](#), [1228](#)
 file reference
 variable [144](#), [145](#)
 FINAL CALL clause
 in CREATE FUNCTION (external scalar) [984](#)
 in CREATE FUNCTION (external table) [1004](#)
 FINAL TABLE clause
 in FROM clause [735](#)
 FIRST clause
 in FETCH statement [1304](#)
 FIRST_VALUE
 in OLAP specification [188](#)
 FLOAT
 data type for ALTER TABLE [871](#)
 data type for CREATE FUNCTION (external scalar) [975](#)
 data type for CREATE FUNCTION (external table) [995](#)
 data type for CREATE FUNCTION (sourced) [1011](#)
 data type for CREATE PROCEDURE (external) [1070](#)
 data type for CREATE PROCEDURE (SQL) [1086](#)
 data type for CREATE TABLE [1119](#)
 data type for CREATE TYPE [1187](#)
 data type for DECLARE GLOBAL TEMPORARY TABLE [1223](#)
 data type for DECLARE PROCEDURE [1240](#)
 FLOAT function [407](#)
 floating point
 constants [114](#)
 numbers [67](#)
 FLOOR function [408](#)
 FOR BIT DATA clause
 ALTER TABLE [871](#)

FOR BIT DATA clause (*continued*)

CREATE FUNCTION (external scalar) [975](#)
CREATE FUNCTION (external table) [995](#)
CREATE FUNCTION (sourced) [1011](#)
CREATE PROCEDURE (external) [1070](#)
CREATE PROCEDURE (SQL) [1086](#)
CREATE TABLE statement [1122](#)
CREATE TYPE [1187](#)
DECLARE GLOBAL TEMPORARY TABLE [1223](#)
DECLARE PROCEDURE statement [1240](#)
DECLARE VARIABLE statement [1248](#)

FOR clause

CREATE ALIAS statement [962](#)

FOR COLUMN clause

ALTER TABLE statement [871](#)
CREATE INDEX statement [1050](#)
CREATE TABLE statement [1118](#)
CREATE VIEW statement [1200](#)
in DECLARE GLOBAL TEMPORARY TABLE statement [1223](#)

FOR FETCH ONLY clause

of select-statement [785](#)

FOR MIXED DATA clause

ALTER TABLE [871](#)
CREATE FUNCTION (external scalar) [975](#)
CREATE FUNCTION (external table) [995](#)
CREATE FUNCTION (sourced) [1011](#)
CREATE PROCEDURE (external) [1070](#)
CREATE PROCEDURE (SQL) [1086](#)
CREATE TABLE statement [1122](#)
CREATE TYPE [1187](#)
DECLARE GLOBAL TEMPORARY TABLE [1223](#)
DECLARE PROCEDURE statement [1240](#)
DECLARE VARIABLE statement [1248](#)

FOR READ ONLY clause

of select-statement [785](#)

FOR ROWS clause

FETCH statement [1306](#)
SET RESULT SETS statement [1528](#)

FOR SBCS DATA clause

ALTER TABLE [871](#)
CREATE FUNCTION (external scalar) [975](#)
CREATE FUNCTION (external table) [995](#)
CREATE FUNCTION (sourced) [1011](#)
CREATE PROCEDURE (external) [1070](#)
CREATE PROCEDURE (SQL) [1086](#)
CREATE TABLE statement [1122](#)
CREATE TYPE [1187](#)
DECLARE GLOBAL TEMPORARY TABLE [1223](#)
DECLARE PROCEDURE statement [1240](#)
DECLARE VARIABLE statement [1248](#)

FOR statement [1596](#)

FOR UPDATE OF clause

of select-statement [784](#)

foreign key [6](#)

FOREIGN KEY clause

of ALTER TABLE statement [883](#)
of CREATE TABLE statement [1139](#)

FREE LOCATOR statement [1310](#)

FROM clause

correlation-clause [1252](#)
DELETE statement [1252](#)
joined-table [738](#)
of subselect [730](#)

FROM clause (*continued*)

PREPARE statement [1433](#)
REVOKE (function or procedure privileges) statement [1458](#)
REVOKE (package privileges) statement [1460](#)
REVOKE (schema privileges) statement [1462](#)
REVOKE (sequence privileges) statement [1464](#)
REVOKE (table or view privileges) statement [1467](#)
REVOKE (type privileges) statement [1470](#)
REVOKE (variable privileges) statement [1472](#)
REVOKE (XML schema privileges) statement [1474](#)

FULL JOIN clause

in FROM clause [739](#)

FULL OUTER JOIN clause

in FROM clause [739](#)

fullselect

equivalent term [1992](#)
in assignment-statement [1581](#)
in CREATE VIEW statement [724](#)
in SET variable statement [1540](#)
used in CREATE VIEW statement [1201](#)
used in INSERT statement [1393](#)

function

aggregate

ARRAY_AGG [260](#)
AVG [262](#)
CORR [263](#)
CORRELATION [263](#)
COUNT [264](#)
COUNT_BIG [265](#)
COVAR [266](#)
COVAR_POP [266](#)
COVAR_SAMP [267](#)
COVARIANCE [266](#)
COVARIANCE_SAMP [267](#)
GROUPING [268](#)
JSON_ARRAYAGG [269](#)
JSON_OBJECTAGG [274](#)
LISTAGG [278](#)
MAX [281](#)
MEDIAN [282](#)
MIN [283](#)
PERCENTILE_CONT [284](#)
PERCENTILE_DISC [286](#)
REGR_AVGX [288](#)
REGR_AVGY [288](#)
REGR_COUNT [288](#)
REGR_ICPT [288](#)
REGR_INTERCEPT [288](#)
REGR_R2 [288](#)
REGR_SLOPE [288](#)
REGR_SXX [288](#)
REGR_SXY [288](#)
REGR_SYY [288](#)
regression functions [288](#)
STDDEV [291](#)
STDDEV_POP [291](#)
STDDEV_SAMP [292](#)
SUM [293](#)
VAR [294](#)
VAR_POP [294](#)
VAR_SAMP [295](#)
VARIANCE [294](#)
VARIANCE_SAMP [295](#)

function (*continued*)

aggregate (*continued*)

- [XMLAGG 296](#)
- best fit [151](#)
- built-in [148](#)
- column [148](#), [259](#)
- commenting [936](#)
- creating [965](#), [970](#), [990](#), [1008](#), [1018](#), [1032](#)
- dropping [1287](#)
- extending a built-in function [968](#)
- external [148](#), [970](#), [990](#)
- granting [1353](#)
- input parameters [967](#)
- invocation [157](#)
- labeling [1404](#)
- locators [967](#)
- name restrictions [966](#)
- nesting [301](#)
- obfuscating [641](#), [712](#)
- overriding a built-in function [968](#)
- resolution [150](#)
- revoking [1457](#)

scalar

- [ABS 302](#)
- [ABSVAL 302](#)
- [ACOS 303](#)
- [ADD_MONTHS 304](#)
- [ANTILOG 306](#)
- [ARRAY_MAX_CARDINALITY 307](#)
- [ARRAY_TRIM 308](#)
- [ASCII 309](#)
- [ASIN 310](#)
- [ATAN 311](#)
- [ATAN2 313](#)
- [ATANH 312](#)
- [BIGINT 314](#)
- [BINARY 316](#)
- [BIT_LENGTH 319](#)
- [BITAND 317](#)
- [BITANDNOT 317](#)
- [BITNOT 317](#)
- [BITOR 317](#)
- [BITXOR 317](#)
- [BLOB 320](#)
- [BSON_TO_JSON 321](#)
- [CARDINALITY 322](#)
- [CEIL 323](#)
- [CEILING 323](#)
- [CHAR 324](#)
- [CHAR_LENGTH 330](#)
- [CHARACTER_LENGTH 330](#)
- [CHR 331](#)
- [CLOB 332](#)
- [COALESCE 337](#)
- [COMPARE_DECFLOAT 338](#)
- [CONCAT 339](#)
- [CONTAINS 340](#)
- [COS 343](#)
- [COSH 344](#)
- [COT 345](#)
- [CURDATE 346](#)
- [CURTIME 347](#)
- [DATABASE 348](#)
- [DATAPARTITIONNAME 349](#)

function (*continued*)

scalar (*continued*)

- [DATAPARTITIONNUM 350](#)
- [DATE 351](#)
- [DAY 353](#)
- [DAYNAME 354](#)
- [DAYOFMONTH 355](#)
- [DAYOFWEEK 356](#)
- [DAYOFWEEK_ISO 357](#)
- [DAYOFYEAR 358](#)
- [DAYS 359](#)
- [DBCLOB 360](#)
- [DBPARTITIONNAME 366](#)
- [DBPARTITIONNUM 367](#)
- [DECFLOAT 368](#)
- [DECFLOAT_FORMAT 370](#)
- [DECFLOAT_SORTKEY 372](#)
- [DECIMAL 373](#)
- [DECRYPT_BIN 376](#)
- [DECRYPT_BINARY 376](#)
- [DECRYPT_BIT 376](#)
- [DECRYPT_CHAR 376](#)
- [DECRYPT_DB 376](#)
- [DEGREES 379](#)
- [DIFFERENCE 380](#)
- [DIGITS 381](#)
- [DLCOMMENT 382](#)
- [DLLINKTYPE 383](#)
- [DLURLCOMPLETE 384](#)
- [DLURLPATH 385](#)
- [DLURLPATHONLY 386](#)
- [DLURLSCHEME 387](#)
- [DLURLSERVER 388](#)
- [DLVALUE 389](#)
- [DOUBLE 391](#)
- [DOUBLE_PRECISION 391](#)
- [ENCRYPT 396](#)
- [ENCRYPT_AES 393](#)
- [ENCRYPT_RC2 396](#)
- [ENCRYPT_TDES 399](#)
- [EXP 402](#)
- [EXTRACT 403](#)
- [FLOAT 407](#)
- [FLOOR 408](#)
- [GENERATE_UNIQUE 409](#)
- [GET_BLOB_FROM_FILE 410](#)
- [GET_CLOB_FROM_FILE 411](#)
- [GET_DBCLOB_FROM_FILE 412](#)
- [GET_XML_FILE 413](#)
- [GETHINT 414](#)
- [GRAPHIC 415](#)
- [GREATEST 421](#)
- [HASH 422](#)
- [HASH_MD5 422](#)
- [HASH_ROW 424](#)
- [HASH_SHA1 422](#)
- [HASH_SHA256 422](#)
- [HASH_SHA512 422](#)
- [HASH_VALUES 425](#)
- [HASHED_VALUE 426](#)
- [HEX 427](#)
- [HEXTORAW 428](#)
- [HOUR 429](#)
- [IDENTITY_VAL_LOCAL 430](#)

function (continued)

scalar (continued)

[IFNULL 434](#)
[INSERT 435](#)
[INSTR 437](#)
[INTEGER 438](#)
[JSON_ARRAY 444](#)
[JSON_OBJECT 448](#)
[JSON_QUERY 452](#)
[JSON_TO_BSON 457](#)
[JSON_VALUE 458](#)
[JULIAN_DAY 462](#)
[LAND 463](#)
[LAST_DAY 464](#)
[LCASE 465](#)
[LEAST 466](#)
[LEFT 467](#)
[LENGTH 469](#)
[LN 471](#)
[LNOT 472](#)
[LOCATE 473](#)
[LOCATE_IN_STRING 475](#)
[LOG 477](#)
[LOG10 477](#)
[LOR 478](#)
[LOWER 479](#)
[LPAD 480](#)
[LTRIM 483](#)
[MAX 485](#)
[MAX_CARDINALITY 486](#)
[MICROSECOND 487](#)
[MIDNIGHT_SECONDS 488](#)
[MIN 489](#)
[MINUTE 490](#)
[MOD 491](#)
[MONTH 493](#)
[MONTHNAME 494](#)
[MONTHS_BETWEEN 495](#)
[MOREREAD 497](#)
[MOREREADCLOB 499](#)
[MORERECEIVE 501](#)
[MORERECEIVECLOB 503](#)
[MQSEND 505](#)
[MULTIPLY_ALT 507](#)
[NEXT_DAY 509](#)
[NODENAME 366](#)
[NODENUMBER 367](#)
[NORMALIZE_DECFLOAT 511](#)
[NOW 512](#)
[NULLIF 513](#)
[NVL 514](#)
[OCTET_LENGTH 515](#)
[OVERLAY 516](#)
[PARTITION 426](#)
[PI 519](#)
[POSITION 520](#)
[POSSTR 522](#)
[POW 524](#)
[POWER 524](#)
[QUANTIZE 525](#)
[QUARTER 527](#)
[RADIANS 528](#)
[RAISE_ERROR 529](#)
[RAND 530](#)

function (continued)

scalar (continued)

[RANDOM 530](#)
[REAL 531](#)
[REGEXP_COUNT 533](#)
[REGEXP_EXTRACT 539](#)
[REGEXP_INSTR 535](#)
[REGEXP_MATCH_COUNT 533](#)
[REGEXP_REPLACE 537](#)
[REGEXP_SUBSTR 539](#)
[REPEAT 541](#)
[REPLACE 543](#)
[RID 545](#)
[RIGHT 546](#)
[ROUND 548](#)
[ROUND_TIMESTAMP 550](#)
[ROWID 553](#)
[RPAD 554](#)
[RRN 557](#)
[RTRIM 558](#)
[SCORE 560](#)
[SECOND 563](#)
[SIGN 565](#)
[SIN 566](#)
[SINH 567](#)
[SMALLINT 568](#)
[SOUNDEX 569](#)
[SPACE 570](#)
[SQRT 571](#)
[STRIP 572](#)
[STRLEFT 573](#)
[STRPOS 574](#)
[STRIGHT 575](#)
[SUBSTR 576](#)
[SUBSTRING 578](#)
[SYS_CONNECT_BY_PATH 749](#)
[TABLE_NAME 580](#)
[TABLE_SCHEMA 581](#)
[TAN 582](#)
[TANH 583](#)
[TIME 584](#)
[TIMESTAMP 585](#)
[TIMESTAMP_FORMAT 587](#)
[TIMESTAMP_ISO 592](#)
[TIMESTAMPDIFF 593](#)
[TO_CHAR 596](#)
[TO_CLOB 597](#)
[TO_DATE 598](#)
[TO_NUMBER 599](#)
[TO_TIMESTAMP 600](#)
[TOTALORDER 601](#)
[TRANSLATE 602](#)
[TRIM 604](#)
[TRIM_ARRAY 606](#)
[TRUNC_TIMESTAMP 609](#)
[TRUNCATE 607](#)
[UCASE 610](#)
[UPPER 611](#)
[VALUE 612](#)
[VARBINARY 613](#)
[VARBINARY_FORMAT 614](#)
[VARCHAR 616](#)
[VARCHAR_BIT_FORMAT 621](#)
[VARCHAR_FORMAT 622](#)

function (*continued*)

scalar (*continued*)

VARCHAR_FORMAT_BINARY
630
VARCHAR_FORMAT_BIT [630](#)
VARGRAPHIC [631](#)
VERIFY_GROUP_FOR_USER [637](#)
WEEK [639](#)
WEEK_ISO [640](#)
WRAP [641](#)
XMLATTRIBUTES [298](#), [643](#)
XMLCOMMENT [644](#)
XMLCONCAT [645](#)
XMLDOCUMENT [647](#)
XMLELEMENT [648](#)
XMLFOREST [651](#)
XMLNAMESPACES [654](#)
XMLPARSE [656](#)
XMLPI [657](#)
XMLROW [658](#)
XMLSERIALIZE [660](#)
XMLTEXT [664](#)
XMLVALIDATE [665](#)
XOR [669](#)
XSLTRANSFORM [670](#)
YEAR [675](#)
ZONED [676](#)

sourced [148](#), [1008](#)

specific name [967](#)

SQL [148](#), [1018](#), [1032](#)

table

BASE_TABLE [680](#)
JSON_TABLE [682](#)
M_QREADALL [692](#)
M_QREADALLCLOB [694](#)
M_QRECEIVEALL [696](#)
M_QRECEIVEALLCLOB [699](#)
XMLTABLE [702](#)

types [148](#)

user-defined [148](#)

FUNCTION clause

ALTER FUNCTION (external scalar) statement [811](#)
ALTER FUNCTION (external table) statement [816](#)
ALTER FUNCTION (SQL scalar) statement [822](#)
ALTER FUNCTION (SQL table) statement [830](#)
COMMENT statement [930](#), [935](#)
DROP statement [1286](#)
GRANT (function or procedure privileges) statement
[1352](#)
LABEL statement [1403](#)
REVOKE (function or procedure privileges) statement
[1456](#)

function invocation

syntax [149](#)

function reference

syntax [149](#)

function resolution [57](#)

function-name

description [50](#)
in ALTER FUNCTION (external scalar) statement [811](#)
in ALTER FUNCTION (external table) statement [816](#)
in ALTER FUNCTION (SQL scalar) statement [822](#)
in ALTER FUNCTION (SQL table) statement [830](#)
in CREATE FUNCTION (external scalar) [976](#)

function-name (*continued*)

in CREATE FUNCTION (external table) [996](#)
in CREATE FUNCTION (sourced) [1011](#)
in CREATE FUNCTION (SQL scalar) [1023](#)
in CREATE FUNCTION (SQL table) [1037](#)
in DROP statement [1286](#)

functions

description [148](#)

G

GENERAL clause

CREATE PROCEDURE (external) [1073](#)
DECLARE PROCEDURE [1242](#)
in CREATE FUNCTION (external scalar) [980](#)
GENERAL WITH NULLS clause
CREATE PROCEDURE (external) [1073](#)
DECLARE PROCEDURE [1242](#)
in CREATE FUNCTION (external scalar) [980](#)

GENERATE_UNIQUE function [409](#)

GENERATED

in ALTER TABLE statement [874](#)
in CREATE TABLE statement [1125](#)
in DECLARE GLOBAL TEMPORARY TABLE statement
[1225](#)

GET DESCRIPTOR statement

description [1323](#)

GET DIAGNOSTICS statement

description [1348](#), [1605](#)

GET_BLOB_FROM_FILE function [410](#)

GET_CLOB_FROM_FILE function [411](#)

GET_DBCLOB_FROM_FILE function [412](#)

GET_XML_FILE function [413](#)

GETHINT function [414](#)

GLOBAL DETERMINISTIC clause

in CREATE FUNCTION (external scalar) [981](#)
in CREATE FUNCTION (external table) [1000](#)
in CREATE FUNCTION (SQL scalar) [1024](#)
in CREATE FUNCTION (SQL table) [1038](#)

global variable

CLIENT_HOST [232](#)
CLIENT_IPADDR [233](#)
CLIENT_PORT [234](#)
JOB_NAME [235](#)
PACKAGE_NAME [236](#)
PACKAGE_SCHEMA [237](#)
PACKAGE_VERSION [238](#)
PROCESS_ID [239](#)
ROUTINE_SCHEMA [240](#)
ROUTINE_SPECIFIC_NAME [241](#)
ROUTINE_TYPE [242](#)
SERVER_MODE_JOB_NAME [243](#)
THREAD_ID [244](#)

global variables [139](#)

GO TO clause

WHENEVER statement [1567](#)

GOTO statement [1606](#)

grand-total [753](#)

GRANT (Fnction or Procedure Privileges) statement [1356](#)

GRANT (function or procedure privileges) statement [1349](#)

GRANT (package privileges) statement [1357](#), [1359](#)

GRANT (schema privileges) statement [1360](#)

GRANT (sequence privileges) statement [1363](#), [1365](#)

GRANT (table or view privileges) statement [1366](#), [1367](#), [1373](#)
 GRANT (type privileges) statement [1374](#), [1376](#)
 GRANT (variable privileges) statement [1377](#), [1379](#)
 GRANT (XML schema privileges) statement [1380](#), [1382](#)
 GRAPHIC
 data type for ALTER TABLE [871](#)
 data type for CREATE FUNCTION (external scalar) [975](#)
 data type for CREATE FUNCTION (external table) [995](#)
 data type for CREATE FUNCTION (sourced) [1011](#)
 data type for CREATE PROCEDURE (external) [1070](#)
 data type for CREATE PROCEDURE (SQL) [1086](#)
 data type for CREATE TABLE [1120](#)
 data type for CREATE TYPE [1187](#)
 data type for DECLARE GLOBAL TEMPORARY TABLE [1223](#)
 data type for DECLARE PROCEDURE [1240](#)
 function [415](#)
 graphic constant
 hexadecimal [116](#)
 graphic data string
 Unicode data [72](#)
 graphic string
 assignment [95](#)
 constants [116](#)
 definition [71](#)
 GREATEST
 scalar function [421](#)
 GROUP BY clause
 of subselect [751](#)
 results with subselect [727](#)
 GROUPING
 aggregate function [268](#)
 grouping sets [752](#)
 GROUPING SETS [752](#)

H

HASH function [422](#)
 hash partitions
 ALTER TABLE statement [887](#)
 HASH_MD5 function [422](#)
 HASH_ROW function [424](#)
 HASH_SHA1 function [422](#)
 HASH_SHA256 function [422](#)
 HASH_SHA512 function [422](#)
 HASH_VALUES function [425](#)
 HASHED_VALUE function [426](#)
 HAVING clause
 of subselect [764](#)
 results with subselect [727](#)
 held connection state [39](#)
 HEX function [427](#)
 hexadecimal constants [115](#), [117](#)
 HEXTORAW
 function [428](#)
 hierarchical query [741](#)
 hierarchical-query-clause [742](#)
 HOLD clause
 COMMIT statement [940](#)
 ROLLBACK statement [1476](#)
 HOLD LOCATOR statement [1383](#), [1384](#)
 host identifier [47](#)
 host structure

host structure (*continued*)
 description [146](#)
 host structure arrays
 description [147](#)
 host variable
 DECLARE VARIABLE statement [1248](#)
 description [50](#), [140](#)
 indicator variable [142](#)
 host variable followed by an indicator variable
 equivalent term [1992](#)
 host-identifier
 in host variable [50](#)
 host-label
 description [50](#)
 in WHENEVER statement [1567](#)
 host-structure-array
 in FETCH statement [1306](#)
 in INSERT statement [1393](#)
 in SET RESULT SETS statement [1527](#)
 host-variable
 in DECLARE VARIABLE statement [1248](#)
 HOUR function [429](#)

I

ICU [33](#)
 identifiers
 in SQL
 delimited [46](#)
 description [46](#)
 host [47](#)
 ordinary [46](#)
 system [46](#)
 limits [44](#), [55](#), [56](#), [1635](#)
 IDENTITY
 in ALTER TABLE statement [874](#), [880](#)
 in CREATE TABLE statement [1126](#)
 in DECLARE GLOBAL TEMPORARY TABLE statement [1226](#)
 IDENTITY_VAL_LOCAL function [430](#)
 IF statement [1608](#)
 IFNULL function [434](#)
 ILE RPG
 SQLCA (SQL communication area) [1665](#)
 SQLDA (SQL descriptor area) [1685](#)
 IMMEDIATE
 EXECUTE IMMEDIATE statement [1301](#), [1302](#)
 IN ASP clause
 CREATE SCHEMA statement [1095](#)
 IN clause
 CREATE PROCEDURE (external) [1070](#)
 DECLARE PROCEDURE statement [1240](#)
 in ALTER PROCEDURE (SQL) [850](#)
 in CREATE PROCEDURE (SQL) [1086](#)
 IN EXCLUSIVE clause
 in LOCK TABLE statement [1408](#)
 in FETCH statement [1303](#)
 IN predicate [208](#)
 IN SHARE MODE clause
 in LOCK TABLE statement [1408](#)
 INCFILE clause
 in SET OPTION statement [1518](#)
 INCLUDE clause
 CREATE INDEX statement [1050](#)

INCLUDE statement [1385](#), [1386](#), [1610](#)
 INCLUDING clause
 in CREATE TABLE statement [1134](#), [1136](#)
 in DECLARE GLOBAL TEMPORARY TABLE statement [1231](#)
 INCREMENT BY clause
 ALTER TABLE statement [881](#)
 CREATE SEQUENCE statement [1100](#)
 index
 dropping [1287](#), [1289](#)
 INDEX clause
 COMMENT statement [930](#), [936](#)
 CREATE INDEX statement [1045](#)
 DROP statement [1287](#)
 GRANT (table or view privileges) statement [1368](#)
 LABEL statement [1404](#)
 RENAME statement [1450](#)
 REVOKE (table or view privileges) statement [1466](#)
 TRANSFER OWNERSHIP statement [1546](#)
 index-name
 description [50](#)
 in CREATE INDEX statement [1048](#)
 in DROP statement [1287](#)
 in LABEL statement [1404](#)
 in RENAME statement [1450](#)
 in TRANSFER OWNERSHIP statement [1546](#)
 indicator
 array [146](#)
 variable [146](#), [1301](#)
 INDICATOR
 GET DESCRIPTOR statement [1317](#)
 SET DESCRIPTOR statement [1500](#)
 infix operators [160](#)
 INFORMATION_SCHEMA [1701](#)
 INFORMATION_SCHEMA_CATALOG_NAME view [1947](#)
 INHERIT SPECIAL REGISTERS clause
 in CREATE FUNCTION (external scalar) [982](#)
 in CREATE FUNCTION (external table) [1001](#)
 in CREATE FUNCTION (SQL scalar) [1026](#)
 in CREATE FUNCTION (SQL table) [1040](#)
 in CREATE PROCEDURE (external) [1074](#)
 in CREATE PROCEDURE (SQL) [1088](#)
 INNER JOIN clause
 in FROM clause [739](#)
 INOUT clause
 CREATE PROCEDURE (external) [1071](#)
 DECLARE PROCEDURE statement [1240](#)
 in ALTER PROCEDURE (SQL) [850](#)
 in CREATE PROCEDURE (SQL) [1086](#)
 INPUT SEQUENCE clause
 in ORDER BY [766](#)
 INSENSITIVE clause
 in DECLARE CURSOR statement [1208](#)
 INSERT clause
 GRANT (table or view privileges) statement [1368](#)
 REVOKE (table or view privileges) statement [1466](#)
 INSERT function [435](#)
 insert rule with referential constraint [7](#)
 insert rules
 check constraint [1394](#)
 INSERT statement [1387](#), [1398](#)
 INSTR
 function [437](#)
 INTEGER

INTEGER (*continued*)
 data type for ALTER TABLE [871](#)
 data type for CREATE FUNCTION (external scalar) [975](#)
 data type for CREATE FUNCTION (external table) [995](#)
 data type for CREATE FUNCTION (sourced) [1011](#)
 data type for CREATE PROCEDURE (external) [1070](#)
 data type for CREATE PROCEDURE (SQL) [1086](#)
 data type for CREATE TABLE [1118](#)
 data type for CREATE TYPE [1187](#)
 data type for DECLARE GLOBAL TEMPORARY TABLE [1223](#)
 data type for DECLARE PROCEDURE [1240](#)
 integer constants [114](#)
 INTEGER data type [67](#)
 INTEGER function [438](#)
 interactive entry of SQL statements [802](#)
 interactive SQL [3](#)
 INTERPRET [440](#)
 INTERSECT clause
 of fullselect [772](#)
 INTO clause
 in FETCH statement [1305–1307](#)
 in PREPARE statement [1430](#)
 in SELECT INTO statement [1483](#)
 in VALUES INTO statement [1564](#)
 INTO DESCRIPTOR clause
 FETCH statement [1305](#)
 INTO keyword
 CALL statement [923](#)
 DESCRIBE CURSORE statement [1264](#)
 DESCRIBE INPUT statement [1265](#)
 DESCRIBE PROCEDURE statement [1271](#)
 DESCRIBE statement [1259](#)
 DESCRIBE TABLE statement [1275](#)
 EXECUTE statement [1297](#)
 INSERT statement [1391](#)
 INTO SQL DESCRIPTOR clause
 in FETCH statement [1305](#)
 IS clause
 COMMENT statement [938](#)
 LABEL statement [1406](#)
 IS JSON
 predicate [210](#)
 isolation level
 comparison [26](#)
 CS [26](#)
 cursor stability [26](#)
 description [23](#)
 interfaces [23](#), [24](#)
 NC [26](#)
 no commit [26](#)
 read stability
 phantom rows [25](#)
 repeatable read [25](#)
 RR [25](#)
 RS [25](#)
 set using SET TRANSACTION [1536](#)
 uncommitted read (UR) [26](#)
 ISOLATION LEVEL clause
 SET TRANSACTION statement [1536](#)
 isolation-clause
 in DELETE statement [1253](#)
 in INSERT statement [1393](#)
 in MERGE statement [1416](#)

isolation-clause (*continued*)
 in SELECT INTO statement [1483](#)
 in UPDATE statement [1557](#)
ITERATE statement [1613](#)

J

jar-name
 description [50](#)
JAVA clause
 CREATE PROCEDURE (external) [1073](#)
 DECLARE PROCEDURE [1242](#)
 in CREATE FUNCTION (external scalar) [980](#)
Java Database Connectivity (JDBC) [3](#)
JOB_NAME global variable [235](#)
JOIN clause
 in FROM clause [739](#)
JSON path [214](#)
JSON_ARRAY
 scalar function [444](#)
JSON_ARRAYAGG
 aggregate function [269](#)
JSON_EXISTS
 predicate [212](#)
JSON_OBJECT
 scalar function [448](#)
JSON_OBJECTAGG
 aggregate function [274](#)
JSON_QUERY
 scalar function [452](#)
JSON_TABLE
 function [682](#)
JSON_TO_BSON
 scalar function [457](#)
JSON_VALUE
 scalar function [458](#)
JULIAN_DAY function [462](#)

K

KEEP IN MEMORY clause
 ALTER TABLE statement [895](#)
 CREATE INDEX statement [1052](#)
 CREATE TABLE statement [1143](#), [1234](#)
KEEP LOCKS [787](#)
key
 ALTER TABLE statement [882](#)
 composite [5](#)
 CREATE TABLE statement [1139](#)
 foreign [6](#)
 parent [6](#)
 primary [6](#)
 primary index [6](#)
 unique [5](#)
 unique index [6](#)
KEY_MEMBER
 GET DESCRIPTOR statement [1317](#)
KEY_TYPE
 GET DESCRIPTOR statement [1314](#)

L

LABEL statement [1399](#), [1407](#)

labeled duration [166](#)
LABELS
 in catalog tables [1399](#)
 in USING clause
 DESCRIBE statement [1260](#)
 DESCRIBE TABLE statement [1276](#)
 PREPARE statement [1430](#)

LAG

 in OLAP specification [186](#)
LAND function [463](#)
LANGID clause
 in SET OPTION statement [1518](#)
LANGUAGE clause
 CREATE PROCEDURE (external) [1072](#)
 in CREATE FUNCTION (external scalar) [979](#)
 in CREATE FUNCTION (external table) [998](#)
 in CREATE FUNCTION (SQL scalar) [1024](#)
 in CREATE FUNCTION (SQL table) [1038](#)
 in CREATE PROCEDURE (SQL) [1087](#)
 in DECLARE PROCEDURE statement [1241](#)

large integers [67](#)

large object (LOB)

 data type [73](#)
 description [73](#)
 file reference variable [145](#)
 locator [73](#)
 locator variable [144](#)

LAST clause

 in FETCH statement [1304](#)

LAST_DAY

 function [464](#)

LAST_VALUE

 in OLAP specification [188](#)

lateral correlation [137](#)

LCASE function [465](#)

LEAD

 in OLAP specification [186](#)

LEAST

 scalar function [466](#)

LEAVE statement [1615](#)

LEFT EXCEPTION JOIN clause

 in FROM clause [740](#)

LEFT function [467](#)

LEFT JOIN clause

 in FROM clause [739](#)

LEFT OUTER JOIN clause

 in FROM clause [739](#)

LENGTH

 GET DESCRIPTOR statement [1318](#)

 SET DESCRIPTOR statement [1500](#)

LENGTH function [469](#)

LEVEL

 GET DESCRIPTOR statement [1318](#)

 SET DESCRIPTOR statement [1500](#)

LEVEL pseudo column [745](#)

LIKE clause

 in CREATE TABLE statement [1134](#)

 in DECLARE GLOBAL TEMPORARY TABLE statement [1229](#)

LIKE predicate [216](#)

LIMIT clause [768](#)

limits

 database manager [1639–1642](#)

 DataLink [1639](#)

- limits (*continued*)
 - datetime [1639](#)
 - identifier [55](#), [56](#), [1635](#)
 - in SQL [1635](#)
 - JSON [1638](#)
 - numeric [1636](#), [1637](#)
 - string [1637](#), [1638](#)
 - XML [1638](#)
- LISTAGG
 - aggregate function [278](#)
- literal
 - constant
 - equivalent term [1991](#)
- literals [114](#)
- LN function [471](#)
- LNOT function [472](#)
- LOB
 - data type [73](#)
 - description [73](#)
 - file reference variable [145](#)
 - locator [73](#)
 - locator variable [144](#)
- LOB Locators
 - assignment [101](#)
- LOCAL CHECK OPTION clause
 - CREATE VIEW statement [1202](#)
- LOCATE function [473](#)
- LOCATE_IN_STRING
 - function [475](#)
- locator
 - declaring variable [144](#)
 - description [73](#)
 - FREE LOCATOR statement [1310](#)
 - HOLD LOCATOR statement [1383](#)
- LOCK TABLE statement [1408](#), [1409](#)
- locking
 - COMMIT statement [940](#)
 - during UPDATE [1561](#)
 - LOCK TABLE statement [1408](#)
 - table spaces [1408](#)
- locks
 - exclusive [25](#)
 - share [25](#)
- LOG function [477](#)
- LOG10 function [477](#)
- logical operator [228](#)
- LONG VARBINARY
 - data type for CREATE TABLE [1156](#)
- LONG VARCHAR
 - data type for CREATE TABLE [1156](#)
- LONG VARGRAPHIC
 - data type for CREATE TABLE [1156](#)
- LOOP statement [1616](#)
- LOR function [478](#)
- LOWER function [479](#)
- LPAD function [480](#)
- LTRIM function [483](#)

M

- mask
 - dropping [1287](#)
- MASK clause
 - COMMENT statement [936](#)
- MASK clause (*continued*)
 - DROP statement [1287](#)
 - LABEL statement [1404](#)
- mask-name
 - description [50](#)
 - in ALTER MASK statement [834](#)
 - in CREATE MASK statement [1054](#)
 - in DROP statement [1287](#)
 - in LABEL statement [1404](#)
- materialized query definition
 - in CREATE TABLE statement [1148](#)
- materialized query table
 - in ALTER TABLE statement [890](#), [891](#)
 - in CREATE TABLE statement [1149](#)
- MAX
 - aggregate function [281](#)
 - scalar function [485](#)
- MAX_CARDINALITY function [486](#)
- MAXVALUE clause
 - CREATE SEQUENCE statement [1101](#)
 - in ALTER TABLE statement [881](#)
- media preference
 - ALTER TABLE statement [895](#)
 - CREATE INDEX statement [1051](#)
 - CREATE TABLE statement [1143](#)
- media-preference clause
 - in DECLARE GLOBAL TEMPORARY TABLE statement [1234](#)
- MEDIAN
 - aggregate function [282](#)
- memory preference
 - ALTER TABLE statement [895](#)
 - CREATE INDEX statement [1052](#)
 - CREATE TABLE statement [1143](#), [1234](#)
- MERGE statement [1410](#)
- MESSAGE_LENGTH
 - GET DIAGNOSTICS statement [1337](#)
- MESSAGE_OCTET_LENGTH
 - GET DIAGNOSTICS statement [1337](#)
- MESSAGE_TEXT
 - GET DIAGNOSTICS statement [1337](#)
 - SIGNAL statement [1543](#)
- method-id
 - description [50](#)
- MICROSECOND function [487](#)
- MIDNIGHT_SECONDS function [488](#)
- MIN
 - aggregate function [283](#)
 - scalar function [489](#)
- MINUTE function [490](#)
- MINVALUE clause
 - CREATE SEQUENCE statement [1101](#)
 - in ALTER TABLE statement [881](#)
- mixed data
 - description [70](#)
 - in LIKE predicates [217](#)
 - in string assignments [96](#)
- MOD function [491](#)
- MODE
 - IN EXCLUSIVE MODE clause
 - LOCK TABLE statement [1408](#)
 - IN SHARE MODE clause
 - LOCK TABLE statement [1408](#)
- MODIFIES SQL DATA clause

MODIFIES SQL DATA clause (*continued*)
 CREATE PROCEDURE (external) [1074](#)
 in CREATE FUNCTION (external scalar) [982](#)
 in CREATE FUNCTION (external table) [1000](#)
 in CREATE FUNCTION (SQL scalar) [1025](#)
 in CREATE FUNCTION (SQL table) [1039](#)
 in CREATE PROCEDURE (SQL) [1088](#)
 in DECLARE PROCEDURE [1243](#)
 MONITOR clause
 in SET OPTION statement [1519](#)
 MONTH function [493](#)
 MONTHNAME function [494](#)
 MONTHS_BETWEEN function [495](#)
 MORE
 GET DIAGNOSTICS statement [1332](#)
 MQREAD function [497](#)
 MQREADALL function [692](#)
 MQREADALLCLOB function [694](#)
 MQREADCLOB function [499](#)
 MQRECEIVE function [501](#)
 MQRECEIVEALL function [696](#)
 MQRECEIVEALLCLOB function [699](#)
 MQRECEIVECLOB function [503](#)
 MQSEND function [505](#)
 multiplication operator [160](#)
 MULTIPLY_ALT
 scalar function [507](#)

N

name
 exposed [732](#)
 for SQL statements [1246](#)
 in INCLUDE statement [1385](#)
 subselect [726](#)
 NAME
 GET DESCRIPTOR statement [1318](#)
 name qualification
 default schema [58](#)
 Name scoping [1575](#)
 named columns join
 in JOIN clause [739](#)
 NAMES
 in USING clause
 DESCRIBE statement [1259](#)
 DESCRIBE TABLE statement [1276](#)
 PREPARE statement [1430](#)
 NAMING clause
 in SET OPTION statement [1519](#)
 naming conventions in SQL [48](#)
 NC (no commit) [26](#)
 NCHAR
 data type for CREATE TABLE [1120](#)
 NCLOB
 data type for CREATE TABLE [1120](#)
 nested programs [1568](#)
 nested table expression [730](#)
 NEW TABLE clause
 in FROM clause [735](#)
 NEXT clause
 in FETCH statement [1304](#)
 NEXT_DAY
 function [509](#)
 nextval-expression

nextval-expression (*continued*)
 in sequence reference [194](#)
 NO ACTION delete rule
 in ALTER TABLE statement [884](#)
 in CREATE TABLE statement [1140](#)
 NO ACTION update rule
 in ALTER TABLE statement [884](#)
 in CREATE TABLE statement [1141](#)
 NO CACHE clause
 in ALTER TABLE statement [881](#)
 no commit [26](#)
 NO COMMIT clause
 SET TRANSACTION statement [1536](#)
 NO CYCLE clause
 in ALTER TABLE statement [881](#)
 NO DBINFO clause
 CREATE PROCEDURE (external) [1075](#)
 in CREATE FUNCTION (external scalar) [982](#)
 in CREATE FUNCTION (external table) [1001](#)
 NO EXTERNAL ACTION clause
 in CREATE FUNCTION (external scalar) [983](#)
 in CREATE FUNCTION (external table) [1003](#)
 in CREATE FUNCTION (SQL scalar) [1025](#)
 in CREATE FUNCTION (SQL table) [1039](#)
 NO FINAL CALL clause
 in CREATE FUNCTION (external scalar) [984](#)
 in CREATE FUNCTION (external table) [1004](#)
 NO ORDER clause
 in ALTER TABLE statement [881](#)
 NO SCRATCHPAD clause
 in CREATE FUNCTION (external scalar) [985](#)
 in CREATE FUNCTION (external table) [1005](#)
 NO SCROLL clause
 in DECLARE CURSOR statement [1209](#)
 NO SQL clause
 CREATE PROCEDURE (external) [1074](#)
 in CREATE FUNCTION (external table) [1000](#)
 in DECLARE PROCEDURE [1243](#)
 NOCYCLE [742](#)
 nodegroup
 definition [5](#)
 in CREATE TABLE statement [1144](#)
 nodegroup-name [51](#)
 NODENAME function [366](#)
 NODENUMBER function [367](#)
 NONE clause
 SET RESULT SETS statement [1528](#)
 nonexecutable statement [800](#), [801](#)
 nonrepeatable read [28](#)
 normalization
 CREATE TABLE statement [1123](#)
 NORMALIZE_DECFLOAT function [511](#)
 NOT DETERMINISTIC clause
 CREATE PROCEDURE (external) [1073](#)
 in CREATE FUNCTION (external scalar) [981](#)
 in CREATE FUNCTION (external table) [1000](#)
 in CREATE FUNCTION (SQL scalar) [1024](#)
 in CREATE FUNCTION (SQL table) [1038](#)
 in CREATE PROCEDURE (SQL) [1087](#)
 NOT FENCED clause
 CREATE PROCEDURE (external) [1074](#)
 in CREATE FUNCTION (external scalar) [984](#)
 in CREATE FUNCTION (external table) [1003](#)
 in CREATE FUNCTION (SQL scalar) [1026](#)

NOT FENCED clause (*continued*)
 in CREATE FUNCTION (SQL table) [1040](#)
 in CREATE PROCEDURE (SQL) [1089](#)

NOT FOUND clause
 WHENEVER statement [1567](#)

NOT LOGGED clause
 in DECLARE GLOBAL TEMPORARY TABLE statement [1233](#)

NOT LOGGED INITIALLY
 ALTER TABLE statement [892](#)
 CREATE TABLE statement [1143](#)

NOT NULL clause
 ALTER TABLE statement [877](#)
 CREATE TABLE statement [1130](#)
 in DECLARE GLOBAL TEMPORARY TABLE statement [1229](#)

NOT PARTITIONED clause
 CREATE INDEX statement [1050](#)

NOT VOLATILE
 ALTER TABLE statement [895](#)
 CREATE TABLE statement [1143](#)

NOW function [512](#)

NTH_VALUE
 in OLAP specification [188](#)

NTILE
 in OLAP specification [186](#)

NUL-terminated string variables allowed [69](#)

NULL
 in CALL statement [923](#)
 in CAST specification [179](#)
 in SET variable statement [1540](#)
 in UPDATE statement [1556](#)
 in VALUES INTO statement [1564](#)
 in XMLCAST specification [198](#)
 keyword SET NULL delete rule
 description [7](#)
 in ALTER TABLE statement [884](#)
 in CREATE TABLE statement [1140](#)
 keyword SET NULL update rule
 in ALTER TABLE statement [884](#)

NULL clause
 ALTER TABLE statement [872](#)
 in CALL statement [922](#)
 in INSERT statement [1393](#)
 in MERGE statement [1415](#)

NULL predicate [220](#)

null value in SQL
 assignment [92](#)
 defined [66](#)
 in grouping expressions [751](#)
 in result columns [727](#)
 specified by indicator variable [142](#)

null value, SQL
 assigned to variable [1483](#)

NULLABLE
 GET DESCRIPTOR statement [1318](#)

NULLIF function [513](#)

NULLS FIRST
 in CREATE TABLE statement [1145](#)

NULLS FIRST clause
 in OLAP specification [187](#)

NULLS LAST
 in CREATE TABLE statement [1145](#)

NULLS LAST clause
 in OLAP specification [187](#)

NUMBER
 GET DIAGNOSTICS statement [1333](#)
 number of hash partitions
 in CREATE TABLE statement [1147](#)
 number of items in a select list
 equivalent term [1992](#)
 numbers
 default decimal separator character [68](#)
 precision [67](#)
 numeric
 assignments [92](#)
 comparisons [101](#)
 data type [66](#)
 data types
 default decimal separator character [68](#)
 string representation [68](#)
 limits [1636](#), [1637](#)

NUMERIC
 data type for ALTER TABLE [871](#)
 data type for CREATE FUNCTION (external scalar) [975](#)
 data type for CREATE FUNCTION (external table) [995](#)
 data type for CREATE FUNCTION (sourced) [1011](#)
 data type for CREATE PROCEDURE (external) [1070](#)
 data type for CREATE PROCEDURE (SQL) [1086](#)
 data type for CREATE TABLE [1119](#)
 data type for CREATE TYPE [1187](#)
 data type for DECLARE GLOBAL TEMPORARY TABLE [1223](#)
 data type for DECLARE PROCEDURE [1240](#)

NVARCHAR
 data type for CREATE TABLE [1120](#)

NVL function [514](#)

O

obfuscating
 function [641](#), [712](#)
 procedure [641](#), [712](#)
 trigger [641](#), [712](#)

object table [135](#)

OCTET_LENGTH
 GET DESCRIPTOR statement [1318](#)

OCTET_LENGTH function [515](#)

OFFSET clause
 of select-statement [767](#)

offset-clause
 in DELETE statement [1253](#)
 in UPDATE statement [1557](#)

OLAP specifications [182](#)

OLE DB [3](#)

ON clause
 CREATE INDEX statement [1048](#)

ON COMMIT clause
 in DECLARE GLOBAL TEMPORARY TABLE statement [1233](#)

ON PACKAGE clause
 GRANT (package privileges) statement [1358](#)
 REVOKE (package privileges) statement [1459](#)

ON ROLLBACK clause
 in DECLARE GLOBAL TEMPORARY TABLE statement [1233](#)

ON SCHEMA clause

- ON SCHEMA clause (*continued*)
 - GRANT (schema privileges) statement [1361](#)
 - REVOKE (schema privileges) statement [1461](#)
- ON SEQUENCE clause
 - GRANT (sequence privileges) statement [1364](#)
 - REVOKE (sequence privileges) statement [1463](#)
- ON TABLE clause
 - GRANT (table or view privileges) statement [1368](#)
 - REVOKE (table or view privileges) statement [1467](#)
- ON TYPE clause
 - GRANT (type privileges) statement [1375](#)
 - REVOKE (type privileges) statement [1470](#)
- ON VARIABLE clause
 - GRANT (variable privileges) statement [1378](#)
 - REVOKE (variable privileges) statement [1472](#)
- opaque terms [1987](#)
- open state of cursor [1307](#)
- OPEN statement [1421](#), [1426](#)
- operand
 - date and time [166](#)
 - decimal [161](#)
 - decimal floating-point [162](#)
 - distinct type [164](#)
 - floating point [162](#)
 - integer [160](#), [161](#)
 - numeric [161](#)
- operation
 - assignment [91](#), [95](#), [97](#), [98](#)
 - comparison [101](#), [106](#)
 - description [91](#)
- operators
 - arithmetic [160](#)
- OPTIMIZE clause [786](#)
- OPTLOB clause
 - in SET OPTION statement [1519](#)
- OR
 - truth table [228](#)
- OR REPLACE
 - in CREATE TABLE statement [1117](#)
- OR REPLACE clause
 - in CREATE ALIAS statement [961](#)
 - in CREATE FUNCTION (external scalar) [976](#)
 - in CREATE FUNCTION (external table) [996](#)
 - in CREATE FUNCTION (SQL scalar) [1023](#)
 - in CREATE FUNCTION (SQL table) [1036](#)
 - in CREATE PROCEDURE (external) [1070](#)
 - in CREATE PROCEDURE (SQL) [1086](#)
 - in CREATE SEQUENCE statement [1100](#)
 - in CREATE TRIGGER statement [1165](#)
 - in CREATE VARIABLE statement [1195](#)
 - in CREATE VIEW statement [1199](#)
- ORDER BY clause
 - of select-statement [765](#)
- ORDER clause
 - CREATE SEQUENCE statement [1102](#)
 - in ALTER TABLE statement [881](#)
- ORDER OF clause
 - in OLAP specification [188](#)
 - in ORDER BY [766](#)
- order of evaluation [172](#)
- order-by-clause
 - in DELETE statement [1253](#)
 - in OLAP specification [187](#)
 - in UPDATE statement [1557](#)

- ordinary identifier
 - in SQL [46](#)
 - in system names [46](#)
- OUT clause
 - CREATE PROCEDURE (external) [1070](#)
 - DECLARE PROCEDURE statement [1240](#)
 - in ALTER PROCEDURE (SQL) [850](#)
 - in CREATE PROCEDURE (SQL) [1086](#)
- outer join [739](#)
- outer reference
 - equivalent term [1991](#)
- OUTPUT clause
 - in SET OPTION statement [1519](#)
- OVERLAY function [516](#)
- OVRDBF (Override with Data Base file) [59](#)
- ownership [16](#)

P

- package
 - description [12](#)
 - dropping [1287](#)
 - in DRDA [36](#)
- PACKAGE clause
 - COMMENT statement [930](#)
 - DROP statement [1287](#)
 - LABEL statement [1404](#)
- package view
 - SYSPACKAGE [1769](#)
 - SYSPACKAGEAUTH [1771](#)
 - SYSPACKAGESTAT [1772](#)
 - SYSPACKAGESTMTSTAT [1778](#)
- PACKAGE_NAME global variable [236](#)
- PACKAGE_SCHEMA global variable [237](#)
- PACKAGE_VERSION global variable [238](#)
- package-name
 - in DROP statement [1287](#)
 - in LABEL statement [1404](#)
 - in REVOKE (package privileges) statement [1459](#)
- PAGESIZE clause
 - CREATE INDEX statement [1050](#)
- PARAMETER clause
 - COMMENT statement [936](#)
- parameter marker
 - in EXECUTE statement [1297](#)
 - in OPEN statement [1422](#)
 - in PREPARE statement [1434](#)
 - replacement [1298](#), [1424](#)
 - rules [1434](#)
 - typed [1434](#)
 - untyped [1434](#)
 - usage in expressions, predicates and functions [1434](#)
- PARAMETER_MODE
 - GET DESCRIPTOR statement [1318](#)
 - GET DIAGNOSTICS statement [1337](#)
- PARAMETER_NAME
 - GET DIAGNOSTICS statement [1337](#)
- PARAMETER_ORDINAL_POSITION
 - GET DESCRIPTOR statement [1318](#)
 - GET DIAGNOSTICS statement [1338](#)
- PARAMETER_SPECIFIC_CATALOG
 - GET DESCRIPTOR statement [1318](#)
- PARAMETER_SPECIFIC_NAME
 - GET DESCRIPTOR statement [1318](#)

- PARAMETER_SPECIFIC_SCHEMA
 - GET DESCRIPTOR statement [1318](#)
- parameter-marker
 - in CAST specification [179](#)
 - in XMLCAST specification [198](#)
 - typed parameter marker [179](#), [198](#)
- parameter-name
 - CREATE PROCEDURE (external) [1071](#)
 - description [51](#)
 - in ALTER FUNCTION (SQL scalar) [823](#)
 - in ALTER FUNCTION (SQL table) [831](#)
 - in ALTER PROCEDURE (SQL) [850](#)
 - in CREATE PROCEDURE (SQL) [1086](#)
 - in DECLARE PROCEDURE [1240](#)
- PARAMETERS view [1948](#)
- parent key [6](#)
- parent row [6](#)
- parent table [6](#)
- parentheses
 - with EXCEPT [773](#)
 - with INTERSECT [773](#)
 - with UNION [773](#)
- partition by hash
 - in CREATE TABLE statement [1147](#)
- partition by range
 - in CREATE TABLE statement [1145](#)
- PARTITION function [426](#)
- partition name
 - ALTER TABLE statement [887](#)
 - in CREATE TABLE statement [1145](#)
- partition-by-clause
 - in OLAP specification [187](#)
- PARTITIONED clause
 - CREATE INDEX statement [1050](#)
- partitioning clause
 - ALTER TABLE statement [886](#)
- partitioning key
 - definition [5](#)
 - in CREATE TABLE statement [1144](#), [1145](#), [1147](#)
- password
 - in CONNECT (type 1) statement [953](#)
 - in CONNECT (type 2) statement [958](#)
- path
 - function resolution [151](#)
- PERCENT_RANK
 - in OLAP specification [187](#)
- PERCENTILE_CONT
 - aggregate function [284](#)
- PERCENTILE_DISC
 - aggregate function [286](#)
- period specification
 - FROM clause [733](#)
- permission
 - dropping [1287](#)
- PERMISSION clause
 - COMMENT statement [936](#)
 - DROP statement [1287](#)
 - LABEL statement [1404](#)
- permission-name
 - description [51](#)
 - in ALTER PERMISSION statement [836](#)
 - in CREATE PERMISSION statement [1060](#)
 - in DROP statement [1287](#)
 - in LABEL statement [1404](#)
- phantom row [28](#)
- PI function [519](#)
- PIPE statement [1618](#)
- PL/I
 - application program
 - varying-length string variables [69](#)
 - host structure arrays [147](#)
 - host variable [140](#), [146](#)
 - SQLCA (SQL communication area) [1663](#)
 - SQLDA (SQL descriptor area) [1684](#)
- POSITION function [520](#)
- POSSTR function [522](#)
- POW function [524](#)
- POWER function [524](#)
- precedence
 - level [172](#)
 - operation [172](#)
- PRECISION
 - GET DESCRIPTOR statement [1318](#)
 - SET DESCRIPTOR statement [1500](#)
- precision of a number [66](#)
- predicate
 - basic [200](#)
 - BETWEEN [204](#)
 - description [199](#)
 - DISTINCT [205](#)
 - EXISTS [207](#)
 - IN [208](#)
 - IS JSON [210](#)
 - JSON_EXISTS [212](#)
 - LIKE [216](#)
 - NULL [220](#)
 - quantified [202](#)
 - REGEXP_LIKE [221](#)
 - trigger event [227](#)
- prefix operator [160](#)
- PREPARE statement [1427](#), [1444](#)
- prepared SQL statement
 - dynamically prepared by PREPARE [1427](#), [1443](#)
 - executing [1296](#), [1300](#)
 - identifying by DECLARE [1246](#)
 - obtaining information
 - by INTO with PREPARE [1260](#)
 - with DESCRIBE [1258](#)
 - with SQLDA [1667](#)
 - obtaining input information
 - with DESCRIBE INPUT [1265](#)
 - SQLDA provides information [1667](#)
 - statements allowed [1644](#)
- PRESERVE ROWS
 - ALTER TABLE statement [887](#)
- prevval-expression
 - in sequence reference [194](#)
- primary index [6](#)
- primary key [6](#)
- PRIMARY KEY clause
 - ALTER TABLE statement [877](#), [882](#)
 - CREATE TABLE statement [1130](#), [1139](#)
- PRIOR clause
 - in FETCH statement [1304](#)
- PRIOR unary operator [747](#)
- privileges
 - description [15](#)
- procedure

procedure (*continued*)

- choosing parameter data types [1064](#)
- commenting [937](#)
- CREATE_WRAPPED [712](#)
- creating [1064](#), [1065](#), [1080](#)
- defining [1236](#)
- dropping [1289](#)
- granting [1354](#)
- labeling [1405](#)
- locators [1064](#)
- obfuscating [641](#), [712](#)
- obtaining information
 - with DESCRIBE PROCEDURE [1268](#)
- RELEASE statement [1447](#)
- revoking [1458](#)
- ROLLBACK [1475](#)
- signature [1064](#)
- specific name [1064](#)

PROCEDURE clause

- ALTER PROCEDURE (external) statement [841](#)
- ALTER PROCEDURE (SQL) statement [849](#)
- COMMENT statement [930](#)
- DROP statement [1288](#)

Procedure resolution [63](#)

procedure-name

- CREATE PROCEDURE (external) [1070](#)
- description [51](#)
- in ALTER PROCEDURE (external) statement [841](#)
- in ALTER PROCEDURE (SQL) statement [849](#)
- in CALL statement [921](#)
- in CREATE PROCEDURE (SQL) [1086](#)
- in DECLARE PROCEDURE [1240](#)
- in DROP statement [1288](#)

procedures

- SET CONNECTION statement [1485](#)
- XDBDECOMPXML [714](#)
- XSR_ADDSCHEMADOC [716](#)
- XSR_COMPLETE [718](#)
- XSR_REGISTER [720](#)
- XSR_REMOVE [722](#)

PROCESS_ID global variable [239](#)

PROGRAM TYPE MAIN clause

- CREATE PROCEDURE (external) [1075](#)
- in CREATE FUNCTION (external scalar) [984](#)
- in CREATE FUNCTION (external table) [1004](#)
- in CREATE PROCEDURE (SQL) [1089](#)
- in DECLARE PROCEDURE [1243](#)

PROGRAM TYPE SUB clause

- CREATE PROCEDURE (external) [1075](#)
- in CREATE FUNCTION (external scalar) [984](#)
- in CREATE FUNCTION (external table) [1004](#)
- in CREATE PROCEDURE (SQL) [1089](#)
- in DECLARE PROCEDURE [1243](#)

program view

- SYSPROGRAMSTAT [1813](#)
- SYSPROGRAMSTMTSTAT [1822](#)

pseudo column

- CONNECT_BY_ISCYCLE [745](#)
- CONNECT_BY_ISLEAF [745](#)
- LEVEL [745](#)

PUBLIC clause

- GRANT (table or view privileges) statement [1368](#)
- in GRANT (function or procedure privileges) statement [1354](#)

PUBLIC clause (*continued*)

- in GRANT (package privileges) statement [1358](#)
- in GRANT (schema privileges) statement [1361](#)
- in GRANT (sequence privileges) statement [1364](#)
- in GRANT (type privileges) statement [1375](#)
- in GRANT (variable privileges) statement [1378](#)
- in GRANT (XML schema privileges) statement [1381](#)
- in REVOKE (table or view privileges) statement [1467](#)
- REVOKE (function or procedure privileges) statement [1458](#)
- REVOKE (package privileges) statement [1460](#)
- REVOKE (schema privileges) statement [1462](#)
- REVOKE (sequence privileges) statement [1464](#)
- REVOKE (type privileges) statement [1470](#)
- REVOKE (variable privileges) statement [1472](#)
- REVOKE (XML schema privileges) statement [1474](#)

Q

qualification of column names [133](#)

qualifier

- reserved [1993](#)

quantified predicate [202](#)

QUANTIZE function [525](#)

QUARTER function [527](#)

query

- expression
 - equivalent term [1991](#)
- specification
 - equivalent term [1991](#)

question mark (?) [1297](#)

R

RADIANS function [528](#)

RAISE_ERROR function [529](#)

RAND function [530](#)

RANDOM function [530](#)

range partitions

- ALTER TABLE statement [887](#)

RANK

- in OLAP specification [186](#)

RATIO_TO_REPORT

- in OLAP specification [188](#)

RCDFMT clause

- CREATE INDEX statement [1051](#)
- CREATE TABLE statement [1143](#)
- CREATE VIEW statement [1203](#)
- in DECLARE GLOBAL TEMPORARY TABLE statement [1233](#)

RDBCNNMTH clause

- in SET OPTION statement [1519](#)

READ clause

- GRANT (variable privileges) statement [1378](#)
- REVOKE (variable privileges) statement [1471](#)

READ COMMITTED clause

- SET TRANSACTION statement [1536](#)

read stability [25](#)

READ UNCOMMITTED clause

- SET TRANSACTION statement [1536](#)

read-only-clause [785](#)

READS SQL DATA clause

- CREATE PROCEDURE (external) [1074](#)

READS SQL DATA clause (*continued*)
 in CREATE FUNCTION (external scalar) [981](#)
 in CREATE FUNCTION (external table) [1000](#)
 in CREATE FUNCTION (SQL scalar) [1025](#)
 in CREATE FUNCTION (SQL table) [1039](#)
 in CREATE PROCEDURE (SQL) [1088](#)
 in DECLARE PROCEDURE [1243](#)

REAL
 data type for ALTER TABLE [871](#)
 data type for CREATE FUNCTION (external scalar) [975](#)
 data type for CREATE FUNCTION (external table) [995](#)
 data type for CREATE FUNCTION (sourced) [1011](#)
 data type for CREATE PROCEDURE (external) [1070](#)
 data type for CREATE PROCEDURE (SQL) [1086](#)
 data type for CREATE TABLE [1119](#)
 data type for CREATE TYPE [1187](#)
 data type for DECLARE GLOBAL TEMPORARY TABLE [1223](#)
 data type for DECLARE PROCEDURE [1240](#)

REAL function [531](#)

recovery [17](#)

recursive
 common table expression [779](#)
 query [779](#)
 view [1199](#)

RECURSIVE clause
 CREATE VIEW statement [1199](#)

REFERENCES clause
 ALTER TABLE statement [878](#), [883](#)
 CREATE TABLE statement [1131](#), [1140](#)
 GRANT (table or view privileges) statement [1368](#)
 REVOKE (table or view privileges) statement [1466](#), [1467](#)

referential constraint [5](#), [6](#)

referential cycle [6](#)

referential integrity
 delete rules [1254](#)
 update rules [1558](#)

REFERENTIAL_CONSTRAINTS view [1952](#)

referential-constraint clause
 of ALTER TABLE statement [883](#)
 of CREATE TABLE statement [1139](#)

REFRESH TABLE statement [1445](#), [1446](#)

REGEXP_COUNT function [533](#)

REGEXP_EXTRACT function [539](#)

REGEXP_INSTR function [535](#)

REGEXP_LIKE predicate [221](#)

REGEXP_MATCH_COUNT function [533](#)

REGEXP_REPLACE function [537](#)

REGEXP_SUBSTR function [539](#)

REGR_AVGX
 aggregate function [288](#)

REGR_AVGY
 aggregate function [288](#)

REGR_COUNT
 aggregate function [288](#)

REGR_ICPT
 aggregate function [288](#)

REGR_INTERCEPT
 aggregate function [288](#)

REGR_R2
 aggregate function [288](#)

REGR_SLOPE
 aggregate function [288](#)

REGR_SXX (*continued*)
 aggregate function [288](#)

REGR_SXY
 aggregate function [288](#)

REGR_SYY
 aggregate function [288](#)

regression functions
 aggregate function [288](#)

related information [1999](#)

relational database [1](#)

RELATIVE clause
 in FETCH statement [1212](#), [1304](#)

RELEASE SAVEPOINT statement [1449](#)

RELEASE statement [1447](#), [1448](#)

release-pending connection state [39](#)

remote unit of work
 mixed environment [1644](#)

RENAME statement [1450](#), [1452](#)

renaming SQL objects [1450](#)

REPEAT function [541](#)

REPEAT statement [1620](#)

repeatable read [25](#)

REPEATABLE READ clause
 SET TRANSACTION statement [1536](#)

REPLACE clause
 in ALTER FUNCTION (SQL scalar) [823](#)
 in ALTER FUNCTION (SQL table) [831](#)
 in ALTER PROCEDURE (SQL) [850](#)

REPLACE function [543](#)

reserved
 qualifiers [1993](#)
 schema names [1993](#)
 words [1993](#)

reserved words [46](#), [1993](#)

RESET clause
 CONNECT (type 1) statement [953](#)
 CONNECT (type 2) statement [958](#)

RESIGNAL statement [1622](#)

RESTART clause
 in ALTER TABLE statement [881](#)

RESTRICT clause
 DROP statement [1287](#), [1289–1291](#)
 in ALTER FUNCTION (external scalar) [812](#)
 in ALTER FUNCTION (external table) [817](#)
 in ALTER FUNCTION (SQL scalar) [823](#)
 in ALTER FUNCTION (SQL table) [831](#)
 in DROP COLUMN of ALTER TABLE statement [882](#)
 in DROP constraint of ALTER TABLE statement [886](#)

RESTRICT delete rule
 description [7](#)
 in ALTER TABLE statement [884](#)
 in CREATE TABLE statement [1140](#)

RESTRICT update rule
 in ALTER TABLE statement [884](#)
 in CREATE TABLE statement [1141](#)

result
 equivalent term [1992](#)

result columns of subselect [728](#)

RESULT SETS clause
 CREATE PROCEDURE (external) [1074](#)
 in CREATE PROCEDURE (SQL) [1088](#)
 in DECLARE PROCEDURE [1241](#)

result specification
 equivalent term [1991](#)

- result table
 - temporary [1212](#)
- result table created by a group-by or having clause
 - equivalent term [1992](#)
- result view created by a group-by or having clause
 - equivalent term [1992](#)
- result-expression
 - in CASE specification [175](#)
- RETURN statement [1626](#)
- RETURN_STATUS
 - GET DIAGNOSTICS statement [1331](#)
- RETURNED_LENGTH
 - GET DESCRIPTOR statement [1319](#)
- RETURNED_OCTET_LENGTH
 - GET DESCRIPTOR statement [1319](#)
- RETURNED_SQLSTATE
 - GET DIAGNOSTICS statement [1338](#)
- RETURNS clause
 - in ALTER FUNCTION (SQL scalar) [823](#)
 - in ALTER FUNCTION (SQL table) [831](#)
 - in CREATE FUNCTION (external scalar) [977](#)
 - in CREATE FUNCTION (external table) [997](#)
 - in CREATE FUNCTION (SQL scalar) [1024](#)
 - in CREATE FUNCTION (SQL table) [1038](#)
- RETURNS NULL ON NULL INPUT clause
 - in CREATE FUNCTION (external scalar) [982](#)
 - in CREATE FUNCTION (external table) [1001](#)
 - in CREATE FUNCTION (SQL scalar) [1026](#)
 - in CREATE FUNCTION (SQL table) [1039](#)
- REVOKE (function or procedure privileges) statement [1453](#), [1458](#)
- REVOKE (package privileges) statement [1459](#), [1460](#)
- REVOKE (schema privileges) statement [1461](#)
- REVOKE (sequence privileges) statement [1463](#), [1464](#)
- REVOKE (table or view privileges) statement [1465](#)
- REVOKE (type privileges) statement [1469](#), [1470](#)
- REVOKE (variable privileges) statement [1471](#)
- REVOKE (XML schema privileges) statement [1473](#), [1474](#)
- REXX
 - host variable [140](#)
- RID function [545](#)
- RIGHT EXCEPTION JOIN clause
 - in FROM clause [740](#)
- RIGHT function [546](#)
- RIGHT JOIN clause
 - in FROM clause [739](#)
- RIGHT OUTER JOIN clause
 - in FROM clause [739](#)
- rollback
 - definition [19](#), [20](#)
 - description [19](#), [20](#)
- ROLLBACK
 - effect on SET TRANSACTION [1538](#)
- ROLLBACK statement [1475](#), [1478](#)
- ROLLUP [753](#)
- ROUND function [548](#)
- ROUND_TIMESTAMP function [550](#)
- routine [12](#)
- routine view
 - SYSROUTINEAUTH [1825](#)
- ROUTINE_CATALOG
 - GET DIAGNOSTICS statement [1338](#)
- ROUTINE_NAME
 - GET DIAGNOSTICS statement [1338](#)
- ROUTINE_PRIVILEGES view [1962](#)
- ROUTINE_SCHEMA
 - GET DIAGNOSTICS statement [1338](#)
- ROUTINE_SCHEMA global variable [240](#)
- ROUTINE_SPECIFIC_NAME global variable [241](#)
- ROUTINE_TYPE global variable [242](#)
- ROUTINES view [1953](#)
- row
 - deleting [1251](#)
 - dependent [6](#)
 - descendent [6](#)
 - inserting [1387](#)
 - parent [6](#)
 - self-referencing [6](#)
- ROW BEGIN
 - in ALTER TABLE statement [880](#)
- row change expression [193](#)
- ROW clause
 - in UPDATE statement [1555](#)
- ROW END
 - in ALTER TABLE statement [880](#)
- Row ID
 - assignment [99](#)
 - comparison [105](#)
 - data type
 - description [82](#)
- ROW_COUNT
 - GET DIAGNOSTICS statement [1333](#)
- ROW_NUMBER
 - in OLAP specification [187](#)
- row-fullselect
 - in SET variable statement [1540](#)
 - in UPDATE statement [1556](#)
 - in VALUES INTO statement [1564](#)
- row-storage-area
 - in FETCH statement [1307](#)
- row-value-expression [199](#)
- ROWID
 - data type for ALTER TABLE [871](#)
 - data type for CREATE FUNCTION (external scalar) [975](#)
 - data type for CREATE FUNCTION (external table) [995](#)
 - data type for CREATE FUNCTION (sourced) [1011](#)
 - data type for CREATE PROCEDURE (external) [1070](#)
 - data type for CREATE PROCEDURE (SQL) [1086](#)
 - data type for CREATE TABLE [1122](#)
 - data type for CREATE TYPE [1187](#)
 - DECLARE PROCEDURE statement [1240](#)
- ROWID function [553](#)
- ROWS clause
 - INSERT statement [1393](#)
- RPAD function [554](#)
- RPG
 - application program
 - host variable [146](#)
 - varying-length string variables not allowed [69](#)
 - host structure arrays [147](#)
 - host variable [140](#)
 - integers [67](#)
- RPG/400
 - SQLCA (SQL communication area) [1664](#)
- RR (repeatable read) [25](#)
- RRN function [557](#)
- RS (read stability) [25](#)
- RTRIM function [558](#)

- rules
 - names in SQL [48](#)
 - schema name generation [1096](#)
 - system name generation [1156](#)
 - table name generation [1157](#)
- run-time authorization ID
 - description [61](#)

S

- savepoint
 - RELEASE SAVEPOINT statement [1449](#)
 - ROLLBACK statement [1475](#)
 - SAVEPOINT statement [1479](#)
- SAVEPOINT LEVEL clause
 - CREATE PROCEDURE (external) [1077](#)
 - CREATE PROCEDURE (SQL) [1089](#)
- SAVEPOINT statement [1479](#), [1480](#)
- savepoint-name
 - in RELEASE SAVEPOINT statement [1449](#)
 - in SAVEPOINT statement [1479](#)
- SBCS data [70](#)
- scalar function [149](#), [301](#)
- scalar-fullselect
 - definition [166](#)
- scalar-subselect
 - definition [166](#)
- SCALE
 - GET DESCRIPTOR statement [1319](#)
 - SET DESCRIPTOR statement [1500](#)
- scale of data
 - comparisons in SQL [101](#)
 - conversion of numbers in SQL [93](#)
 - determined by SQLLEN variable [1673](#)
 - in results of arithmetic operations [161](#)
 - in SQL [67](#)
- schema
 - description [4](#)
 - dropping [1289](#)
- SCHEMA clause
 - DROP statement [1289](#)
- schema name generation
 - rules [1096](#)
- schema view
 - SYSCHEMAAUTH [1833](#)
- SCHEMA_NAME
 - GET DIAGNOSTICS statement [1339](#)
 - SIGNAL statement [1543](#)
- schema-name
 - definition [51](#)
 - in CREATE SCHEMA statement [1094](#)
 - in DROP statement [1289](#)
 - in REVOKE (schema privileges) statement [1461](#)
 - reserved names [1993](#)
- SCHEMATA view [1963](#)
- SCORE function
 - example [1983](#)
- SCRATCHPAD clause
 - in CREATE FUNCTION (external scalar) [985](#)
 - in CREATE FUNCTION (external table) [1005](#)
- SCROLL clause
 - in DECLARE CURSOR statement [1209](#)
- SEARCH BREADTH FIRST clause
 - of recursive common-table-expression [779](#)
- search condition
 - description [228](#)
 - in JOIN clause [738](#)
 - order of evaluation [229](#)
 - with DELETE [1252](#)
 - with HAVING [764](#)
 - with UPDATE [1556](#)
 - with WHERE [750](#)
- SEARCH DEPTH FIRST clause
 - of recursive common-table-expression [779](#)
- search-condition
 - in CASE specification [175](#)
 - in UPDATE statement [1556](#)
- searched-when-clause
 - in CASE specification [175](#)
- SECOND function [563](#)
- SELECT clause
 - as syntax component [725](#)
 - GRANT (table or view privileges) statement [1368](#)
 - REVOKE (table or view privileges) statement [1467](#)
- SELECT INTO statement [1482](#), [1484](#)
- select list
 - application [727](#)
 - notation [725](#)
- SELECT statement
 - fullselect [771](#)
 - subselect [724](#)
- select-statement
 - in DECLARE CURSOR statement [1210](#)
- self-referencing row [6](#)
- self-referencing table [6](#)
- SENSITIVE clause
 - in DECLARE CURSOR statement [1208](#)
- sequence
 - dropping [1289](#)
- SEQUENCE clause
 - COMMENT statement [937](#)
 - DROP statement [1289](#)
 - LABEL statement [1405](#)
- sequence reference
 - NEXT VALUE [194](#)
 - PREVIOUS VALUE [194](#)
- sequence view
 - SYSSEQUENCEAUTH [1835](#)
 - SYSXSROBJECTAUTH [1876](#)
- sequence-name
 - description [52](#)
 - in ALTER SEQUENCE statement [854](#)
 - in CREATE SEQUENCE statement [1100](#)
 - in DROP statement [1289](#)
 - in LABEL statement [1405](#)
 - in REVOKE (sequence privileges) statement [1463](#)
 - in sequence reference [194](#)
- sequences [14](#)
- SEQUENCES view [1964](#)
- SERIALIZABLE clause
 - SET TRANSACTION statement [1537](#)
- SERVER_MODE_JOB_NAME global variable [243](#)
- SERVER_NAME
 - GET DIAGNOSTICS statement [1339](#)
- server-name
 - description [52](#)
 - in CONNECT (type 1) statement [952](#)
 - in CONNECT (type 2) statement [957](#)

server-name (*continued*)
 in DISCONNECT statement [1278](#)
 in RELEASE statement [1447](#)
 in SET CONNECTION statement [1485](#)
 SESSION_USER special register [132](#), [1525](#)
 SET clause
 UPDATE statement [1555](#)
 SET CONNECTION statement [1485](#), [1487](#)
 SET CURRENT DEBUG MODE statement [1488](#)
 SET CURRENT DECFLOAT ROUNDING MODE statement [1490](#)
 SET CURRENT DEGREE statement [1492](#)
 SET CURRENT IMPLICIT XMLPARSE OPTION statement [1495](#)
 SET CURRENT TEMPORAL SYSTEM_TIME statement [1497](#)
 SET DATA TYPE clause
 ALTER TABLE statement [879](#)
 SET DEFAULT delete rule
 description [7](#)
 in ALTER TABLE statement [884](#)
 in CREATE TABLE statement [1140](#)
 SET DEFAULT update rule
 in ALTER TABLE statement [884](#)
 SET default-clause
 ALTER TABLE statement [880](#)
 SET DESCRIPTOR statement
 description [1502](#)
 SET ENCRYPTION PASSWORD statement [1503](#)
 set function
 equivalent term [1991](#)
 SET GENERATED ALWAYS clause
 ALTER TABLE statement [880](#)
 SET GENERATED BY DEFAULT clause
 ALTER TABLE statement [880](#)
 SET IMPLICITLY HIDDEN clause
 ALTER TABLE statement [880](#)
 SET NOT HIDDEN clause
 ALTER TABLE statement [880](#)
 SET NOT NULL clause
 ALTER TABLE statement [880](#)
 SET NULL delete rule
 description [7](#)
 in ALTER TABLE statement [884](#)
 in CREATE TABLE statement [1140](#)
 SET NULL update rule
 in ALTER TABLE statement [884](#)
 set operation [773](#)
 SET OPTION statement [1505](#), [1523](#)
 SET PATH statement [1524](#)
 SET RESULT SETS statement [1527](#), [1529](#)
 SET SCHEMA statement [1530](#)
 SET SESSION AUTHORIZATION statement
 restrictions [1534](#)
 scope [1535](#)
 SET TRANSACTION statement [1536](#), [1538](#)
 SET variable statement [1539](#)
 SHARE
 IN SHARE MODE clause
 LOCK TABLE statement [1408](#)
 share locks [25](#)
 SHARE MODE clause
 in LOCK TABLE statement [1408](#)
 shift-in character
 not truncated by assignments [96](#)
 SIGN function [565](#)
 SIGNAL statement [1542](#), [1629](#)
 simple-when-clause
 in CASE specification [175](#)
 SIN function [566](#)
 single row select [1482](#)
 single-byte character
 in LIKE predicates [217](#)
 single-precision floating-point [67](#)
 SINH function [567](#)
 SKIP LOCKED DATA [789](#)
 small integers [67](#)
 SMALLINT
 data type for ALTER TABLE [871](#)
 data type for CREATE FUNCTION (external scalar) [975](#)
 data type for CREATE FUNCTION (external table) [995](#)
 data type for CREATE FUNCTION (sourced) [1011](#)
 data type for CREATE PROCEDURE (external) [1070](#)
 data type for CREATE PROCEDURE (SQL) [1086](#)
 data type for CREATE TABLE [1118](#)
 data type for CREATE TYPE [1187](#)
 data type for DECLARE GLOBAL TEMPORARY TABLE [1223](#)
 data type for DECLARE PROCEDURE [1240](#)
 SMALLINT data type [67](#)
 SMALLINT function [568](#)
 SOME quantified predicate [202](#)
 sort sequence [33](#)
 sort-key-expression
 in OLAP specification [187](#)
 SOUNDEX function [569](#)
 sourced
 function [1008](#)
 SPACE function [570](#)
 special register
 CLIENT ACCTNG [123](#)
 CLIENT APPLNAME [123](#)
 CLIENT PROGRAMID [123](#)
 CLIENT USERID [124](#)
 CLIENT WRKSTNNAME [124](#)
 CURRENT CLIENT_ACCTNG [123](#)
 CURRENT CLIENT_APPLNAME [123](#)
 CURRENT CLIENT_PROGRAMID [123](#)
 CURRENT CLIENT_USERID [124](#)
 CURRENT CLIENT_WRKSTNNAME [124](#)
 CURRENT DATE [125](#)
 CURRENT DEBUG MODE [125](#)
 CURRENT DECFLOAT ROUNDING MODE [126](#)
 CURRENT DEGREE [127](#)
 CURRENT IMPLICIT XMLPARSE OPTION [127](#)
 CURRENT PATH [128](#)
 CURRENT SCHEMA [129](#)
 CURRENT SERVER [129](#)
 CURRENT TEMPORAL SYSTEM_TIME [129](#)
 CURRENT TIME [130](#)
 CURRENT TIMESTAMP [131](#)
 CURRENT TIMEZONE [131](#)
 CURRENT USER [131](#)
 CURRENT_DATE [125](#)
 CURRENT_PATH [128](#)
 CURRENT_SERVER [129](#)
 CURRENT_TIME [130](#)
 CURRENT_TIMESTAMP [131](#)
 CURRENT_TIMEZONE [131](#)
 in CALL statement [924](#)

- special register (*continued*)
 - SESSION_USER [132](#)
 - SYSTEM_USER [132](#)
 - USER [132](#)
- SPECIFIC clause
 - COMMENT statement [936](#), [937](#)
 - CREATE PROCEDURE (external) [1077](#)
 - DROP statement [1287](#), [1289](#)
 - GRANT statement [1353](#), [1354](#)
 - in CREATE FUNCTION (external scalar) [981](#)
 - in CREATE FUNCTION (external table) [1000](#)
 - in CREATE FUNCTION (sourced) [1013](#)
 - in CREATE FUNCTION (Sourced) [1016](#)
 - in CREATE FUNCTION (SQL scalar) [1024](#)
 - in CREATE FUNCTION (SQL table) [1038](#)
 - in CREATE PROCEDURE (SQL) [1087](#)
 - in DECLARE PROCEDURE [1242](#)
 - LABEL statement [1404](#), [1405](#)
 - REVOKE statement [1457](#), [1458](#)
- SPECIFIC_NAME
 - GET DIAGNOSTICS statement [1339](#)
- specific-name
 - description [52](#)
 - in COMMENT statement [936](#), [937](#)
 - in CREATE FUNCTION (Sourced) [1016](#)
 - in DROP statement [1287](#), [1289](#)
 - in GRANT statement [1353](#), [1354](#)
 - in LABEL statement [1404](#), [1405](#)
 - in REVOKE statement [1457](#), [1458](#)
- SQL
 - function [1018](#), [1032](#)
- SQL (structured query language)
 - dynamic SQL [2](#)
 - extended dynamic SQL [2](#)
 - static SQL [2](#)
- SQL (Structured Query language)
 - interactive SQL facility [3](#)
- SQL (Structured Query Language)
 - .NET [4](#)
 - assignment operation [91](#)
 - assignments and comparisons [91](#)
 - binary strings [72](#)
 - bind [2](#)
 - call level interface (CLI) [3](#)
 - character strings [69](#)
 - characters [43](#)
 - comparison operation [91](#)
 - constants [114](#)
 - data types [65](#)
 - dates and times [74](#), [75](#)
 - dynamic
 - statements allowed [1644](#)
 - Embedded SQL for Java (SQLJ) [3](#)
 - escape character [46](#)
 - identifiers [46](#)
 - Java Database Connectivity (JDBC) [3](#)
 - large object (LOB) [73](#)
 - limits [1635](#)
 - naming conventions [48](#)
 - null value [66](#)
 - numbers [66](#)
 - OLE DB [3](#)
 - Open Database Connectivity (ODBC) [3](#)
 - tokens [44](#)
- SQL (Structured Query Language) (*continued*)
 - variable names used [48](#)
- SQL clause
 - CREATE PROCEDURE (external) [1072](#)
 - DECLARE PROCEDURE [1241](#)
 - in CREATE FUNCTION (external scalar) [979](#)
 - in CREATE FUNCTION (external table) [999](#)
- SQL conditions [1572](#)
- SQL control statements [1569](#)
- SQL cursors [1573](#)
- SQL labels [1574](#)
- SQL parameters [1571](#)
- SQL path
 - function resolution [151](#)
 - SET PATH [1524](#)
 - SET SCHEMA [1530](#)
- SQL procedural language [1569](#)
- SQL server mode
 - threads [22](#)
- SQL statement
 - CREATE FUNCTION (external scalar) [989](#)
 - CREATE FUNCTION (sourced) [1008](#)
 - CREATE FUNCTION (SQL table) [1032](#)
 - CREATE PROCEDURE (external) [1065](#)
 - CREATE PROCEDURE (SQL) [1080](#)
- SQL statements
 - ALLOCATE CURSOR [805](#)
 - ALLOCATE DESCRIPTOR [806](#)
 - ALTER FUNCTION (external scalar) [808](#)
 - ALTER FUNCTION (external table) [813](#)
 - ALTER FUNCTION (SQL scalar) [818](#)
 - ALTER FUNCTION (SQL table) [826](#)
 - ALTER MASK [834](#)
 - ALTER PERMISSION [836](#)
 - ALTER PROCEDURE (external) [838](#)
 - ALTER PROCEDURE (SQL) [843](#)
 - ALTER SEQUENCE [853](#)
 - ALTER TABLE [858](#), [909](#)
 - ALTER TRIGGER [910](#)
 - ASSOCIATE LOCATORS [913](#)
 - BEGIN DECLARE SECTION [918](#), [919](#)
 - CALL [920](#), [926](#)
 - characteristics [1643](#)
 - CLOSE [928](#), [929](#)
 - COMMENT [930](#), [939](#)
 - COMMIT [940](#), [942](#)
 - compound statement [943](#)
 - CONNECT (type 1) [952](#), [956](#)
 - CONNECT (type 2) [957](#), [960](#)
 - CONNECT differences [1654](#)
 - CREATE ALIAS [961](#), [964](#)
 - CREATE FUNCTION (external scalar) [970](#)
 - CREATE FUNCTION (external table) [990](#)
 - CREATE FUNCTION (SQL scalar) [1018](#)
 - CREATE INDEX [1045](#)
 - CREATE MASK [1054](#)
 - CREATE PERMISSION [1060](#)
 - CREATE PROCEDURE (SQL) [1092](#)
 - CREATE SCHEMA [1093](#), [1097](#)
 - CREATE SEQUENCE [1098](#)
 - CREATE TABLE [1105](#)
 - CREATE TRIGGER [1160](#)
 - CREATE TYPE (array) [1179](#)
 - CREATE TYPE (distinct) [1184](#)

SQL statements (*continued*)

CREATE VARIABLE [1192](#)
 CREATE VIEW [1198, 1205](#)
 data access classification [1647](#)
 DEALLOCATE DESCRIPTOR [1206](#)
 DECLARE CURSOR [1207, 1214](#)
 DECLARE GLOBAL TEMPORARY TABLE [1215](#)
 DECLARE GLOBAL TEMPORARY TABLE statement [1235](#)
 DECLARE PROCEDURE [1236, 1245](#)
 DECLARE STATEMENT [1246, 1247](#)
 DECLARE VARIABLE [1248, 1250](#)
 DELETE [1251, 1257](#)
 DESCRIBE [1258, 1262](#)
 DESCRIBE CURSOR [1263, 1264](#)
 DESCRIBE CURSOR statement [1264](#)
 DESCRIBE INPUT [1265, 1267](#)
 DESCRIBE INPUT statement [1267](#)
 DESCRIBE PROCEDURE [1268, 1273](#)
 DESCRIBE PROCEDURE statement [1273](#)
 DESCRIBE TABLE [1274, 1277](#)
 DESCRIBE TABLE statement [1277](#)
 DISCONNECT [1278, 1279](#)
 DROP [1280, 1294](#)
 END DECLARE SECTION [1295](#)
 EXECUTE [1296, 1300](#)
 EXECUTE IMMEDIATE [1301, 1302](#)
 EXECUTE IMMEDIATE statement [1302](#)
 FETCH [1303, 1309](#)
 FREE LOCATOR [1310](#)
 GET DESCRIPTOR [1311, 1323](#)
 GET DIAGNOSTICS [1324, 1348, 1605](#)
 GRANT (function or procedure privileges) [1349, 1356](#)
 GRANT (package privileges) [1357, 1359](#)
 GRANT (schema privileges) [1360](#)
 GRANT (sequence privileges) [1363, 1365](#)
 GRANT (table or view privileges) [1366, 1373](#)
 GRANT (type privileges) [1374, 1376](#)
 GRANT (variable privileges) [1377, 1379](#)
 GRANT (XML schema privileges) [1380, 1382](#)
 HOLD LOCATOR [1383, 1384](#)
 INCLUDE [1385, 1386](#)
 INSERT [1387, 1398](#)
 LABEL [1399, 1407](#)
 LOCK TABLE [1408, 1409](#)
 MERGE [1410](#)
 names for [1246](#)
 OPEN [1421, 1426](#)
 PREPARE [1427, 1444](#)
 prepared [2](#)
 REFRESH TABLE [1445, 1446](#)
 RELEASE [1447, 1448](#)
 RELEASE SAVEPOINT [1449](#)
 RENAME [1450, 1452](#)
 REVOKE (function or procedure privileges) [1453, 1458](#)
 REVOKE (package privileges) [1459, 1460](#)
 REVOKE (schema privileges) [1461](#)
 REVOKE (sequence privileges) [1463, 1464](#)
 REVOKE (table or view privileges) [1465](#)
 REVOKE (type privileges) [1469, 1470](#)
 REVOKE (variable privileges) [1471](#)
 REVOKE (XML schema privileges) [1473, 1474](#)
 ROLLBACK [1475, 1478](#)
 SAVEPOINT [1479, 1480](#)
 SELECT [1481](#)

SQL statements (*continued*)

SELECT INTO [1482, 1484](#)
 SET CONNECTION [1485, 1487](#)
 SET CURRENT DEBUG MODE [1488](#)
 SET CURRENT DECFLOAT ROUNDING MODE [1490](#)
 SET CURRENT DEGREE [1492](#)
 SET CURRENT IMPLICIT XMLPARSE OPTION [1495](#)
 SET CURRENT TEMPORAL SYSTEM_TIME [1497](#)
 SET DESCRIPTOR [1498, 1502](#)
 SET ENCRYPTION PASSWORD [1503](#)
 SET OPTION [1505, 1523](#)
 SET PATH [1524](#)
 SET RESULT SETS [1527, 1529](#)
 SET SCHEMA [1530](#)
 SET SESSION AUTHORIZATION [1533, 1535](#)
 SET TRANSACTION [1536, 1538](#)
 SET variable [1539](#)
 SIGNAL [1542](#)
 SQL control statements [1569](#)
 SQL procedural language [1569](#)
 SQL-control-statement
 assignment-statement [1580](#)
 CALL statement [1584](#)
 CASE statement [1586](#)
 compound-statement [1588](#)
 FOR statement [1596](#)
 GET DIAGNOSTICS statement [1598](#)
 GOTO statement [1606](#)
 IF statement [1608](#)
 INCLUDE statement [1610](#)
 ITERATE statement [1613](#)
 LEAVE statement [1615](#)
 LOOP statement [1616](#)
 PIPE statement [1618](#)
 REPEAT statement [1620](#)
 RESIGNAL statement [1622](#)
 RETURN statement [1626](#)
 SIGNAL statement [1629](#)
 WHILE statement [1633](#)
 SQL-procedure-statement [1576](#)
 TAG [1545](#)
 TRANSFER OWNERSHIP [1546](#)
 TRUNCATE [1549](#)
 UPDATE [1552, 1562](#)
 VALUES [1563](#)
 VALUES INTO [1564](#)
 WHENEVER [1567, 1568](#)
 SQL_FEATURES table [1965](#)
 SQL_LANGUAGES table [1966](#)
 SQL_SIZING table [1967](#)
 SQL-descriptor-name
 description [52](#)
 in ALLOCATE DESCRIPTOR statement [806](#)
 in CALL statement [923](#)
 in DEALLOCATE DESCRIPTOR statement [1206](#)
 in DESCRIBE CURSOR statement [1263](#)
 in DESCRIBE INPUT statement [1265](#)
 in DESCRIBE PROCEDURE statement [1271](#)
 in DESCRIBE statement [1258](#)
 in DESCRIBE TABLE statement [1275](#)
 in EXECUTE statement [1297](#)
 in FETCH statement [1305, 1306](#)
 in GET DESCRIPTOR statement [1313](#)
 in OPEN statement [1298, 1422](#)

SQL-descriptor-name (*continued*)
 in PREPARE statement [1430](#)
 in SET DESCRIPTOR statement [1499](#)
 SQL-label
 description [53](#)
 SQL-parameter-name
 description [53](#)
 SQL-procedure-statement [1576](#)
 SQL-variable-name
 description [53](#)
 SQLCA (SQL communication area)
 C [1663](#)
 COBOL [1663](#)
 contents [1657](#)
 description [1657](#)
 entry changed by UPDATE [1560](#)
 ILE RPG [1665](#)
 PL/I [1663](#)
 RPG/400 [1664](#)
 SQLCA (SQL communication area) clause
 INCLUDE statement [1385](#)
 SQLCA clause
 in SET OPTION statement [1520](#)
 SQLCODE [803](#)
 SQLCOLPRIVILEGES view [1883](#)
 SQLCOLUMNS view [1884](#)
 SQLCURRULE clause
 in SET OPTION statement [1520](#)
 SQLD field of SQLDA [1259](#), [1264](#), [1266](#), [1272](#), [1275](#), [1669](#)
 SQLDA (SQL descriptor area)
 C [1681](#)
 COBOL [1683](#)
 contents [1667](#)
 ILE COBOL [1683](#)
 ILE RPG [1685](#)
 PL/I [1684](#)
 SQLDA (SQL descriptor area) clause
 INCLUDE statement [1385](#)
 SQLDABC field of SQLDA [1259](#), [1264](#), [1266](#), [1272](#), [1275](#),
[1668](#)
 SQLDAID field of SQLDA [1259](#), [1264](#), [1266](#), [1271](#), [1275](#),
[1668](#)
 SQLDATA field of SQLDA [1680](#)
 SQLDATALEN field of SQLDA [1674](#)
 SQLERRMC field of SQLCA
 values for CONNECT [1662](#)
 values for SET CONNECTION [1662](#)
 SQLERROR clause
 WHENEVER statement [1567](#)
 SQLFOREIGNKEYS view [1894](#)
 SQLFUNCTIONCOLS view [1895](#)
 SQLFUNCTIONS view [1904](#)
 SQLIND field of SQLDA [1673](#)
 SQLLEN field of SQLDA [1673](#), [1677](#)
 SQLLONGLEN field of SQLDA [1674](#)
 SQLN field of SQLDA [1259](#), [1264](#), [1265](#), [1271](#), [1275](#), [1668](#)
 SQLNAME field of SQLDA [1673](#), [1674](#), [1680](#)
 SQLPATH clause
 in SET OPTION statement [1520](#)
 SQLPRIMARYKEYS view [1905](#)
 SQLPROCEDURECOLUMNS view [1906](#)
 SQLPROCEDURES view [1915](#)
 SQLSCHEMAS view [1916](#)
 SQLSPECIALCOLUMNS view [1917](#)
 SQLSTATE
 description [803](#)
 SQLSTATISTICS view [1923](#)
 SQLTABLEPRIVILEGES view [1925](#)
 SQLTABLES view [1926](#)
 SQLTYPE
 unsupported [1680](#)
 SQLTYPE field of SQLDA [1673](#), [1677](#)
 SQLTYPEINFO table [1927](#)
 SQLUDTS view [1935](#)
 SQLVAR field of SQLDA
 number of occurrences [1670](#)
 SQLvariables [1571](#)
 SQLWARNING clause
 WHENEVER statement [1567](#)
 SQRT function [571](#)
 SRTSEQ clause
 in SET OPTION statement [1520](#)
 STACKED
 in GET DIAGNOSTICS [1328](#), [1602](#)
 standards option
 interfaces [xx](#)
 START WITH clause
 CREATE SEQUENCE statement [1100](#)
 STATEMENT DETERMINISTIC clause
 in CREATE FUNCTION (external scalar) [981](#)
 in CREATE FUNCTION (external table) [1000](#)
 in CREATE FUNCTION (SQL scalar) [1024](#)
 in CREATE FUNCTION (SQL table) [1038](#)
 statement string [1301](#)
 statement-name
 description [53](#)
 in DECLARE CURSOR statement [1210](#)
 in DECLARE STATEMENT statement [1246](#)
 in DESCRIBE INPUT statement [1265](#)
 in DESCRIBE statement [1258](#)
 in EXECUTE statement [1297](#)
 in PREPARE statement [1429](#)
 states
 SQL connection [39](#)
 STATIC DISPATCH clause
 in CREATE FUNCTION (external scalar) [982](#)
 in CREATE FUNCTION (external table) [1001](#)
 in CREATE FUNCTION (SQL scalar) [1026](#)
 in CREATE FUNCTION (SQL table) [1040](#)
 static select [801](#)
 static SQL
 use of SQL path [57](#)
 STDDEV function [291](#)
 STDDEV_POP function [291](#)
 STDDEV_SAMP function [292](#)
 string
 assignment [94](#)
 columns [69](#)
 constant
 binary [117](#)
 character [115](#)
 graphic [116](#)
 hexadecimal [115](#), [117](#)
 in INCLUDE statement [1386](#)
 limitations on use of [74](#)
 limits [1637](#), [1638](#)
 variable
 CLOB [69](#)

- string (*continued*)
 - variable (*continued*)
 - DBCLOB [71](#)
 - fixed-length [69](#)
 - varying-length [69](#)
- string delimiter [44](#), [115](#), [117](#)
- STRIP function [572](#)
- STRLEFT function [573](#)
- STRPOS function [574](#)
- STRRIGHT function [575](#)
- SUBCLASS_ORIGIN
 - GET DIAGNOSTICS statement [1339](#)
 - RESIGNAL statement [1623](#)
 - SIGNAL statement [1543](#), [1630](#)
- subnormal numbers [68](#)
- subquery
 - description [137](#), [771](#)
 - in HAVING clause [764](#)
- subquery in a basic predicate
 - equivalent term [1992](#)
- subselect
 - equivalent term [1992](#)
- substitution character [29](#)
- SUBSTMTS
 - GET DIAGNOSTICS statement [1331](#)
- SUBSTR function [576](#)
- SUBSTRING function [578](#)
- subtraction operator [160](#)
- SUM function [293](#)
- super groups [752](#)
- surrogates [30](#)
- synonym for qualifying a column name [133](#)
- SYS_CONNECT_BY_PATH function [749](#)
- SYSCATALOGS view [1707](#)
- SYSCHKCST view [1708](#)
- SYSCOLAUTH view [1709](#)
- SYSCOLUMNS view [1710](#)
- SYSCOLUMNS2 view [1718](#)
- SYSCOLUMNS2_SESSION view [1729](#)
- SYSCOLUMNSTAT view [1730](#)
- SYSCONTROLS view [1733](#)
- SYSCONTROLSDEP view [1735](#)
- SYSCST view [1736](#)
- SYSCSTCOL view [1738](#)
- SYSCSTDEP view [1739](#)
- SYSDUMMY1 table [1740](#)
- SYSFIELDS view [1741](#)
- SYSFUNCS view [1745](#)
- SYSHISTORYTABLES view [1750](#)
- SYSINDEXES view [1751](#)
- SYSINDEXSTAT view [1753](#)
- SYSJARCONTENTS view [1761](#)
- SYSJAROBJECTS view [1762](#)
- SYSKEYCST view [1763](#)
- SYSKEYS view [1764](#)
- SYSMQTSTAT view [1765](#)
- SYSPACKAGE view [1769](#)
- SYSPACKAGEAUTH view [1771](#)
- SYSPACKAGESTAT view [1772](#)
- SYSPACKAGESTMTSTAT view [1778](#)
- SYSPARMS table [1780](#)
- SYSPARTITIONDISK view [1784](#)
- SYSPARTITIONINDEXDISK view [1786](#)
- SYSPARTITIONINDEXES view [1788](#)
- SYSPARTITIONINDEXSTAT view [1795](#)
- SYSPARTITIONMQTS view [1801](#)
- SYSPARTITIONSTAT view [1805](#)
- SYSPERIODS view [1809](#)
- SYSPROCS view [1810](#)
- SYSPROGRAMSTAT view [1813](#)
- SYSPROGRAMSTMTSTAT view [1822](#)
- SYSREFCST view [1824](#)
- SYSROUTINEAUTH view [1825](#)
- SYSROUTINEDEP view [1826](#)
- SYSROUTINES table [1827](#)
- SYSSCHEMAAUTH view [1833](#)
- SYSSCHEMAS view [1834](#)
- SYSSEQUENCEAUTH view [1835](#)
- SYSSEQUENCES view [1836](#)
- SYSTABAUTH view [1838](#)
- SYSTABLEDEP view [1839](#)
- SYSTABLEINDEXSTAT view [1840](#)
- SYSTABLES view [1845](#)
- SYSTABLESTAT view [1849](#)
- system column name [4](#), [11](#), [1050](#), [1118](#), [1200](#), [1223](#), [1260](#), [1276](#)
- system identifier [46](#)
- SYSTEM NAME clause
 - RENAME statement [1450](#)
- system name generation
 - rules [1156](#)
- SYSTEM NAMES
 - in USING clause
 - DESCRIBE statement [1259](#)
 - DESCRIBE TABLE statement [1276](#)
 - PREPARE statement [1430](#)
- system path [1525](#)
- system schema name [1094](#)
- system table name [4](#)
- SYSTEM_USER special register [1525](#)
- SYSTEM_USER special register [132](#)
- system-column-name
 - description [53](#)
 - in ALTER TABLE statement [871](#)
 - in CREATE INDEX statement [1050](#)
 - in CREATE TABLE statement [1118](#)
 - in CREATE VIEW statement [1200](#)
 - in DECLARE GLOBAL TEMPORARY TABLE statement [1223](#)
- system-object-name
 - definition [53](#)
- system-schema-name
 - definition [53](#)
 - in CREATE SCHEMA statement [1094](#)
- SYSTIME clause
 - in SET OPTION statement [1521](#)
- SYSTRIGCOL view [1852](#)
- SYSTRIGDEP view [1853](#)
- SYSTRIGGERS view [1854](#)
- SYSTRIGUPD view [1858](#)
- SYSTYPES table [1859](#)
- SYSUDTAUTH view [1863](#)
- SYSVARIABLEAUTH view [1864](#)
- SYSVARIABLEDEP table [1865](#)
- SYSVARIABLES table [1866](#)
- SYSVIEWDEP view [1872](#)
- SYSVIEWS view [1874](#)
- SYSXSROBJECTAUTH view [1876](#)

T

table

- altering [858](#)
- creating [1105](#)
- declared temporary [1215](#)
- definition [4](#)
- dependent [6](#)
- descendent [6](#)
- designator [135](#), [424](#), [545](#), [557](#)
- distributed [5](#)
- dropping [1289](#), [1290](#)
- obtaining information
 - with DESCRIBE CURSOR [1263](#)
 - with DESCRIBE TABLE [1274](#)
- parent [6](#)
- primary key [6](#)
- self-referencing [6](#)
- system table name [4](#)
- temporary [1423](#)

TABLE clause

- COMMENT statement [937](#)
- DROP statement [1289](#)
- LABEL statement [1405](#)
- RENAME statement [1450](#)
- TRANSFER OWNERSHIP statement [1546](#)

table expression

- equivalent term [1991](#)

table function

- FROM clause
 - of subselect [732](#)

table name generation

- rules [1157](#)

table reference [730](#)

table view

- SYSTABAOTH [1838](#)

TABLE_CONSTRAINTS view [1968](#)

TABLE_NAME

- function [580](#)
- GET DIAGNOSTICS statement [1339](#)
- SIGNAL statement [1543](#)

TABLE_PRIVILEGES view [1969](#)

TABLE_SCHEMA

- function [581](#)

table-name

- description [53](#)
- in ALTER TABLE statement [870](#)
- in CREATE ALIAS statement [962](#)
- in CREATE INDEX statement [1048](#)
- in CREATE TABLE statement [1118](#), [1140](#)
- in DECLARE GLOBAL TEMPORARY TABLE statement [1222](#)
- in DELETE statement [1252](#)
- in DROP statement [1289](#)
- in GRANT (table or view privileges) statement [1368](#)
- in INSERT statement [1391](#)
- in LABEL statement [1406](#)
- in LOCK TABLE statement [1408](#)
- in MERGE statement [1412](#)
- in REFERENCES clause of ALTER TABLE statement [883](#)
- in REFRESH TABLE statement [1445](#)
- in RENAME statement [1450](#)
- in REVOKE (table or view privileges) statement [1467](#)
- in TRANSFER OWNERSHIP statement [1546](#)

table-name (*continued*)

- in TRUNCATE statement [1549](#)
- in UPDATE statement [1554](#)

TABLES view [1970](#)

TAG statement [1545](#)

TAN function [582](#)

TANH function [583](#)

target specification

- equivalent term [1991](#)

temporary

- result table [1212](#)

temporary tables in OPEN [1423](#)

TEXT clause

- LABEL statement [1403](#)

Text search

- argument syntax [1979](#), [1989](#)

text search examples

- CONTAINS function [1981](#)
- SCORE function [1981](#)

TGTRLS clause

- in SET OPTION statement [1521](#)

thread safety [22](#)

THREAD_ID global variable [244](#)

time

- arithmetic operations [170](#)
- duration [167](#)
- strings [76](#)

TIME

- assignment [97](#)
- data type [75](#)
- data type for CREATE TABLE [1121](#)
- function [584](#)

timestamp

- arithmetic operations [171](#)
- duration [167](#)
- strings [79](#)

TIMESTAMP

- assignment [98](#)
- data type [75](#)
- data type for CREATE TABLE [1121](#)
- function [585](#)

TIMESTAMP_FORMAT

- function [587](#)

TIMESTAMP_ISO

- function [592](#)

TIMESTAMPDIFF

- function [593](#)

TIMFMT clause

- in SET OPTION statement [1521](#)

TIMSEP clause

- in SET OPTION statement [1522](#)

TO_CHAR

- function [596](#)

TO_CLOB function [597](#)

TO_DATE

- function [598](#)

TO_NUMBER

- function [599](#)

TO_TIMESTAMP

- function [600](#)

tokens in SQL [44](#)

TOTALORDER function [601](#)

transaction

- equivalent term [1991](#)

TRANSACTION START ID
 in ALTER TABLE statement [880](#)
 TRANSACTION_ACTIVE
 GET DIAGNOSTICS statement [1333](#)
 TRANSACTIONS_COMMITTED
 GET DIAGNOSTICS statement [1333](#)
 TRANSACTIONS_ROLLED_BACK
 GET DIAGNOSTICS statement [1333](#)
 TRANSFER OWNERSHIP statement [1546](#)
 transition table [1167](#)
 transition variable [1167](#)
 TRANSLATE function [602](#)
 trigger
 altering [910](#)
 creating [1160](#)
 delete rules [1254](#)
 dropping [1290](#)
 obfuscating [641](#), [712](#)
 RELEASE statement [1447](#)
 ROLLBACK [1475](#)
 SET CONNECTION statement [1485](#)
 setting isolation level [1537](#)
 update rules [1558](#)
 TRIGGER clause
 COMMENT statement [930](#), [937](#)
 DROP statement [1290](#)
 LABEL statement [1406](#)
 trigger event predicate [227](#)
 TRIGGER_CATALOG
 GET DIAGNOSTICS statement [1340](#)
 TRIGGER_NAME
 GET DIAGNOSTICS statement [1340](#)
 TRIGGER_SCHEMA
 GET DIAGNOSTICS statement [1340](#)
 trigger-name
 description [53](#)
 in ALTER TRIGGER statement [911](#)
 in DROP statement [1290](#)
 in LABEL statement [1406](#)
 TRIM function [604](#)
 TRIM_ARRAY function [606](#)
 TRUNC_TIMESTAMP function [609](#)
 TRUNCATE function [607](#)
 TRUNCATE statement [1549](#)
 truncation of numbers [92](#)
 truth table [228](#)
 truth valued logic [228](#)
 type
 creating [1178](#)
 dropping [1290](#)
 in DROP statement [1290](#)
 TYPE
 GET DESCRIPTOR statement [1319](#)
 SET DESCRIPTOR statement [1500](#)
 TYPE clause
 COMMENT statement [937](#)
 DROP statement [1290](#)
 LABEL statement [1406](#)
 type view
 SYSUDTAUTH [1863](#)
 type-name
 in REVOKE (type privileges) statement [1470](#)
 typed parameter marker [179](#), [198](#)

U

UCASE function [610](#)
 UCS-2 graphic constant
 hexadecimal [117](#)
 UDF (user-defined function)
 external [148](#)
 sourced [148](#)
 SQL [148](#)
 UDT_PRIVILEGES view [1971](#)
 unary
 minus [160](#)
 plus [160](#)
 unary operator
 CONNECT_BY_ROOT [746](#)
 PRIOR [747](#)
 uncommitted read [26](#)
 unconnected state [40](#)
 undefined reference [136](#)
 Unicode [29](#)
 Unicode data
 description [72](#)
 Unicode graphic
 description [72](#)
 UNION ALL clause
 of fullselect [772](#)
 UNION clause
 of fullselect [772](#)
 with duplicate rows [772](#)
 UNIQUE clause
 ALTER TABLE statement [878](#), [882](#)
 CREATE INDEX statement [1048](#)
 CREATE TABLE statement [1131](#), [1139](#)
 in SAVEPOINT statement [1479](#)
 unique constraint [5](#)
 unique index
 update rules [1558](#)
 unique key [5](#)
 UNIT clause
 ALTER TABLE statement [895](#)
 CREATE INDEX statement [1051](#)
 CREATE TABLE statement [1143](#)
 DECLARE GLOBAL TEMPORARY TABLE statement [1234](#)
 unit of work
 COMMIT [940](#)
 ending
 closes cursors [1423](#)
 COMMIT [940](#)
 referring to prepared statements [1427](#)
 ROLLBACK [1475](#)
 UNNAMED
 GET DESCRIPTOR statement [1319](#)
 UPDATE
 in ON UPDATE clause of ALTER TABLE statement [884](#)
 in ON UPDATE clause of CREATE TABLE statement [1141](#)
 UPDATE clause
 GRANT (table or view privileges) statement [1368](#)
 REVOKE (table or view privileges) statement [1467](#)
 update rules
 check constraint [1558](#)
 checking of unique constraints [1558](#)
 effect of commitment control [1558](#)
 referential integrity [1558](#)
 trigger [1558](#)

- update rules (*continued*)
 - views with WITH CHECK OPTION [1558](#)
- UPDATE statement [1552](#), [1562](#)
- UPPER function [611](#)
- UR (uncommitted read) [26](#)
- USAGE clause
 - GRANT (schema privileges) statement [1361](#)
 - GRANT (sequence privileges) statement [1364](#)
 - GRANT (type privileges) statement [1375](#)
 - GRANT (XML schema privileges) statement [1381](#)
 - REVOKE (schema privileges) statement [1461](#)
 - REVOKE (sequence privileges) statement [1463](#)
 - REVOKE (type privileges) statement [1470](#)
 - REVOKE (XML schema privileges) statement [1473](#)
- USAGE_PRIVILEGES view [1972](#)
- USE AND KEEP EXCLUSIVE LOCKS [787](#)
- USE CURRENTLY COMMITTED [789](#)
- USER clause
 - ALTER TABLE statement [872](#), [873](#)
 - CONNECT (type 1) statement [953](#)
 - CONNECT (type 2) statement [958](#)
 - CREATE TABLE statement [1125](#)
 - DECLARE GLOBAL TEMPORARY TABLE statement [1225](#)
- USER special register [132](#)
- USER_DEFINED_TYPE_CATALOG
 - GET DESCRIPTOR statement [1319](#)
 - SET DESCRIPTOR statement [1500](#)
- USER_DEFINED_TYPE_CODE
 - GET DESCRIPTOR statement [1319](#)
- USER_DEFINED_TYPE_NAME
 - GET DESCRIPTOR statement [1319](#)
 - SET DESCRIPTOR statement [1501](#)
- USER_DEFINED_TYPE_SCHEMA
 - GET DESCRIPTOR statement [1319](#)
 - SET DESCRIPTOR statement [1501](#)
- USER_DEFINED_TYPES view [1973](#)
- user-defined function
 - external [148](#)
 - sourced [148](#)
 - SQL [148](#)
- user-defined type
 - description [11](#)
- user-defined types (UDTs)
 - data types
 - description [82](#)
- USING clause
 - CONNECT (type 1) statement [953](#)
 - CONNECT (type 2) statement [958](#)
 - DESCRIBE statement [1259](#)
 - DESCRIBE TABLE statement [1276](#)
 - EXECUTE statement [1297](#)
 - in CREATE TABLE statement [1134](#)
 - in DECLARE GLOBAL TEMPORARY TABLE statement [1231](#)
 - OPEN statement [1422](#)
 - PREPARE statement [1430](#)
- USING DESCRIPTOR clause
 - CALL statement [924](#)
 - EXECUTE statement [1298](#)
 - OPEN statement [1422](#)
- USING keyword
 - DESCRIBE CURSOR statement [1263](#)
 - DESCRIBE INPUT statement [1265](#)
 - DESCRIBE PROCEDURE statement [1271](#)

- USING keyword (*continued*)
 - DESCRIBE statement [1258](#)
 - DESCRIBE TABLE statement [1275](#)
 - in JOIN clause [739](#)
 - PREPARE statement [1430](#)
- USRPRF clause
 - in SET OPTION statement [1522](#)
- UTF-16 graphic constant
 - hexadecimal [117](#)
- UTF-8 (universal coded character set)
 - description [70](#)

V

- value expression
 - equivalent term [1991](#)
- VALUE function [612](#)
- VALUES clause
 - INSERT statement [1392](#), [1393](#)
 - MERGE statement [1415](#)
- VALUES INTO statement [1564](#)
- VALUES statement [1563](#)
- VAR function [294](#)
- VAR_POP function [294](#)
- VAR_SAMP function [295](#)
- VARBINARY
 - data type [72](#)
 - data type for ALTER TABLE [871](#)
 - data type for CREATE FUNCTION (external scalar) [975](#)
 - data type for CREATE FUNCTION (external table) [995](#)
 - data type for CREATE FUNCTION (sourced) [1011](#)
 - data type for CREATE PROCEDURE (external) [1070](#)
 - data type for CREATE PROCEDURE (SQL) [1086](#)
 - data type for CREATE TABLE [1121](#)
 - data type for CREATE TYPE [1187](#)
 - data type for DECLARE GLOBAL TEMPORARY TABLE [1223](#)
 - DECLARE PROCEDURE statement [1240](#)
- VARBINARY function [613](#)
- VARBINARY_FORMAT
 - function [614](#)
- VARCHAR
 - data type for ALTER TABLE [871](#)
 - data type for CREATE FUNCTION (external scalar) [975](#)
 - data type for CREATE FUNCTION (external table) [995](#)
 - data type for CREATE FUNCTION (sourced) [1011](#)
 - data type for CREATE PROCEDURE (external) [1070](#)
 - data type for CREATE PROCEDURE (SQL) [1086](#)
 - data type for CREATE TABLE [1119](#)
 - data type for CREATE TYPE [1187](#)
 - data type for DECLARE GLOBAL TEMPORARY TABLE [1223](#)
 - data type for DECLARE PROCEDURE [1240](#)
 - function [616](#)
- VARCHAR_BIT_FORMAT
 - function [621](#)
- VARCHAR_FORMAT
 - function [622](#)
- VARCHAR_FORMAT_BINARY
 - function [630](#)
- VARCHAR_FORMAT_BIT
 - function [630](#)
- VARGRAPHIC
 - data type for ALTER TABLE [871](#)

VARGRAPHIC (continued)

- data type for CREATE FUNCTION (external scalar) [975](#)
- data type for CREATE FUNCTION (external table) [995](#)
- data type for CREATE FUNCTION (sourced) [1011](#)
- data type for CREATE PROCEDURE (external) [1070](#)
- data type for CREATE PROCEDURE (SQL) [1086](#)
- data type for CREATE TABLE [1120](#)
- data type for CREATE TYPE [1187](#)
- data type for DECLARE GLOBAL TEMPORARY TABLE [1223](#)
- data type for DECLARE PROCEDURE [1240](#)
- function [631](#)

variable

- description
 - in Java [143](#)
- dropping [1290](#)
- file reference [144](#), [145](#)
- in CALL statement [921](#)
- in CONNECT (type 1) statement [952](#), [953](#)
- in CONNECT (type 2) statement [957](#), [958](#)
- in DESCRIBE CURSOR statement [1263](#)
- in DESCRIBE PROCEDURE statement [1270](#)
- in DESCRIBE TABLE statement [1274](#)
- in DISCONNECT statement [1278](#)
- in EXECUTE IMMEDIATE statement [1301](#)
- in EXECUTE statement [1297](#)
- in FETCH statement [1305](#)
- in FREE LOCATOR statement [1310](#)
- in HOLD LOCATOR statement [1383](#)
- in INSERT statement [1393](#)
- in OPEN statement [1422](#)
- in PREPARE statement [1433](#)
- in RELEASE statement [1447](#)
- in SELECT INTO statement [1483](#)
- in SET CONNECTION statement [1485](#)
- in VALUES INTO statement [1564](#)
- LOB file reference [145](#)
- LOB locator [144](#)
- SELECT INTO statement [1483](#)
- statement string [1301](#)
- substitution for parameter markers [1297](#)
- XML file reference [145](#)
- XML locator [144](#)

VARIABLE clause

- COMMENT statement [938](#)
- DROP statement [1290](#)
- LABEL statement [1406](#)

variable view

- SYSVARIABLEAUTH [1864](#)

VARIABLE_PRIVILEGES view [1977](#)

variable-name

- description [54](#)
- in CREATE VARIABLE statement [1195](#)
- in DROP statement [1290](#)
- in REVOKE (variable privileges) statement [1472](#)

VARIANCE function [294](#)

VARIANCE_SAMP function [295](#)

VERIFY_GROUP_FOR_USER function [637](#)

view

- catalog [1701](#)
- creating [1198](#)
- deletable [1203](#)
- dropping [1291](#)
- insertable [1204](#)

view (continued)

- read-only [1204](#)
- recursive [1199](#)
- updatable [1203](#)
- updating with WITH CHECK OPTION views [1558](#)

VIEW clause

- CREATE VIEW statement [1198](#)
- DROP statement [1291](#)
- TRANSFER OWNERSHIP statement [1547](#)

view-name

- description [54](#)
- in CREATE ALIAS statement [962](#)
- in CREATE VIEW statement [1200](#)
- in DELETE statement [1252](#)
- in DROP statement [1291](#)
- in GRANT (table or view privileges) statement [1368](#)
- in INSERT statement [1391](#)
- in LABEL statement [1406](#)
- in MERGE statement [1412](#)
- in RENAME statement [1450](#)
- in REVOKE (table or view privileges) statement [1467](#)
- in TRANSFER OWNERSHIP statement [1547](#)
- in UPDATE statement [1554](#)

VIEWS view [1978](#)

VOLATILE

- ALTER TABLE statement [895](#)
- CREATE TABLE statement [1143](#)

W

WAIT FOR OUTCOME [789](#)

WEEK function [639](#)

WEEK_ISO function [640](#)

WHENEVER statement [1567](#), [1568](#)

WHERE clause

- DELETE statement [1252](#)
- of subselect [750](#)
- UPDATE statement [1556](#)

WHERE CURRENT OF clause

- DELETE statement [1253](#)
- UPDATE statement [1556](#)

WHERE NOT NULL clause

- in CREATE INDEX statement [1048](#)

WHILE statement [1633](#)

WITH CASCADED CHECK OPTION clause

- CREATE VIEW statement [1201](#)

WITH CHECK OPTION clause

- CREATE VIEW statement [1201](#)
- effect on update [1558](#)

WITH CHECK OPTION clause of CREATE VIEW statement

- UPDATE rules [1558](#)

WITH clause

- DELETE statement [1253](#)
- MERGE statement [1416](#)
- UPDATE statement [1393](#), [1557](#)

WITH DATA DICTIONARY clause

- CREATE SCHEMA statement [1096](#)

WITH DEFAULT clause

- CREATE TABLE statement [1123](#)
- in DECLARE GLOBAL TEMPORARY TABLE statement [1223](#)

WITH DISTINCT VALUES clause

- CREATE INDEX statement [1050](#)

WITH EMPTY TABLE

- WITH EMPTY TABLE (*continued*)
 - ALTER TABLE statement [892](#)
- WITH EXTENDED INDICATORS clause
 - in DECLARE CURSOR statement [1210](#)
- WITH GRANT OPTION clause
 - in GRANT (function or procedure privileges) statement [1354](#)
 - in GRANT (package privileges) statement [1358](#)
 - in GRANT (schema privileges) statement [1361](#)
 - in GRANT (sequence privileges) statement [1364](#)
 - in GRANT (table or view privileges) statement [1368](#)
 - in GRANT (type privileges) statement [1375](#)
 - in GRANT (variable privileges) statement [1378](#)
 - in GRANT (XML schema privileges) statement [1381](#)
- WITH HOLD clause
 - in DECLARE CURSOR statement [1209](#)
 - in FOR statement [1596](#)
- WITH LOCAL CHECK OPTION clause
 - CREATE VIEW statement [1202](#)
- WITH NO HOLD clause
 - in DECLARE CURSOR statement [1209](#)
- WITH REPLACE clause
 - in DECLARE GLOBAL TEMPORARY TABLE statement [1233](#)
- WITH RETURN clause
 - in DECLARE CURSOR statement [1209](#)
 - in SET RESULT SETS statement [1527](#)
- WITHOUT EXTENDED INDICATORS clause
 - in DECLARE CURSOR statement [1210](#)
- WITHOUT RETURN clause
 - in DECLARE CURSOR statement [1209](#)
- words
 - reserved [46](#), [1993](#)
- WORK clause
 - in COMMIT statement [940](#)
 - ROLLBACK statement [1475](#)
- WRAP function [641](#)
- WRITE clause
 - GRANT (variable privileges) statement [1378](#)
 - REVOKE (variable privileges) statement [1472](#)

X

- XDBDECOMPXML procedure [714](#)
- XML
 - assignment [98](#)
 - comparisons [105](#)
 - data type for ALTER TABLE [871](#)
 - data type for CREATE PROCEDURE (external) [1070](#)
 - data type for CREATE PROCEDURE (SQL) [1086](#)
 - data type for CREATE TABLE [1122](#)
 - data type for DECLARE GLOBAL TEMPORARY TABLE [1223](#)
 - DECLARE PROCEDURE statement [1240](#)
 - file reference variable [145](#)
 - limits [1638](#)
 - locator variable [144](#)
- XML search
 - text search grammar [1985](#)
- XML text search
 - features [1985](#)
- XMLAGG function [296](#)
- XMLATTRIBUTES function [298](#), [643](#)
- XMLCAST specification [198](#)

- XMLCOMMENT function [644](#)
- XMLCONCAT function [645](#)
- XMLDOCUMENT function [647](#)
- XMLELEMENT function [648](#)
- XMLFOREST function [651](#)
- XMLNAMESPACES function [654](#)
- XMLPARSE function [656](#)
- XMLPI function [657](#)
- XMLROW function [658](#)
- XMLSERIALIZE function [660](#)
- XMLTABLE function [702](#)
- XMLTEXT function [664](#)
- XMLVALIDATE function [665](#)
- XOR function [669](#)
- XPath language [1985](#)
- XPath queries
 - examples [1987](#)
 - opaque terms [1987](#)
- XSLTRANSFORM function [670](#)
- XSR object
 - dropping [1291](#)
- XSR_ADDSCHEMADOC procedure [716](#)
- XSR_COMPLETE procedure [718](#)
- XSR_REGISTER procedure [720](#)
- XSR_REMOVE procedure [722](#)
- XSRANNOTATIONINFO table [1877](#)
- XSROBJECT clause
 - COMMENT statement [930](#), [938](#)
 - DROP statement [1291](#)
 - LABEL statement [1406](#)
 - REVOKE (XML schema privileges) statement [1474](#)
- xsrobject-name
 - description [54](#)
 - in DROP statement [1291](#)
- XSROBJECTCOMPONENTS table [1878](#)
- XSROBJECTHIERARCHIES table [1879](#)
- XSROBJECTS table [1880](#)

Y

- YEAR function [675](#)

Z

- ZONED function [676](#)



Product Number: 5770-SS1