

IBM IMS Solution Packs Data Sensor

User's Guide



Note:

Before using this information and the product it supports, read the information in [“Notices” on page 177.](#)

10th Edition (August 2023)

This edition applies to the Database Sensor component that is delivered with Version 2.2 of IBM IMS Database Solution Pack for z/OS (program number 5655-DSP), Version 2.1 of IBM IMS Database Utility Solution for z/OS (program number 5698-DUL), Version 2.1 of IBM IMS Fast Path Solution Pack for z/OS (program number 5698-FPP), and the Recovery Sensor component that is delivered with Version 2.1 of IBM IMS Recovery Solution Pack for z/OS (program number 5655-ISR) and to all subsequent versions and releases until otherwise indicated in new editions.

This edition replaces SC19-3283-08.

© **Copyright International Business Machines Corporation 2011, 2023.**

US Government Users Restricted Rights – Use, duplication or disclosure restricted by GSA ADP Schedule Contract with IBM Corp.

Contents

- About this information..... vii**
- Part 1. Introduction to Data Sensor..... 1**
 - Chapter 1. Data Sensor overview..... 3
 - What's new in Data Sensor?..... 3
 - What does Data Sensor do?..... 7
 - Data Sensor components..... 8
 - Database Sensor features and benefits (FF and FP DB Sensors)..... 9
 - Database Sensor process flow (FF and FP DB Sensors)..... 10
 - Data Sensor terminology.....12
 - Service updates and support information..... 13
 - Product Documentation and updates.....13
 - Accessibility features..... 14
 - Chapter 2. Installing Data Sensor..... 15
- Part 2. Using FF Stand-alone Database Sensor..... 17**
 - Chapter 3. Overview of FF Stand-alone DB Sensor..... 19
 - Chapter 4. Considerations for collecting sensor data from full-function databases..... 21
 - Chapter 5. Running FF Stand-alone DB Sensor..... 23
 - Chapter 6. FF Stand-alone DB Sensor JCL and control statements.....25
 - EXEC and DD statements for FF Stand-alone DB Sensor.....25
 - Format of the BBESIN control statement..... 27
 - GLOBAL command keywords for FF Stand-alone DB Sensor..... 28
 - DATABASE command keywords for FF Stand-alone DB Sensor..... 33
 - JCL examples for FF Stand-alone DB Sensor..... 33
 - Chapter 7. Output from FF Stand-alone DB Sensor.....37
 - Runtime Summary report from FF Stand-alone DB Sensor..... 37
 - Sensor Data Statistics report from FF Stand-alone Database Sensor..... 38
 - Chapter 8. Setting site default values for FF Stand-alone DB Sensor.....45
 - Creating a site default table for FF Stand-alone DB Sensor..... 45
 - EXEC and DD statements for the FF Site Default Generation utility..... 47
 - Keywords for the FF Site Default Generation utility..... 48
 - Output from the FF Site Default Generation utility..... 49
 - Chapter 9. Printing sensor data by using the FF DB Sensor Printing utility..... 51
 - Printing a Sensor Data Statistics report 51
 - FF DB Sensor Printing utility JCL and control statements..... 52
 - EXEC and DD statements for the FF DB Sensor Printing utility..... 52
 - Format of the BBESPRIN control statement.....53
 - GLOBAL command keywords for the FF DB Sensor Printing utility.....54
 - DATABASE command keywords for the FF DB Sensor Printing utility..... 54
 - Output from the FF DB Sensor Printing utility..... 54

Runtime Summary report from the FF DB Sensor Printing utility.....	54
Sensor Data Statistics report from the FF DB Sensor Printing utility.....	55
Part 3. Using FP Stand-alone Database Sensor.....	61
Chapter 10. Overview of FP Stand-alone DB Sensor.....	63
Chapter 11. Considerations for FP Stand-alone DB Sensor.....	65
Chapter 12. Running FP Stand-alone DB Sensor.....	67
Chapter 13. FP Stand-alone DB Sensor JCL and control statements.....	69
EXEC and DD statements for FP Stand-alone DB Sensor.....	69
Format of the HFPSYSIN control statement.....	75
GLOBAL command keywords for FP Stand-alone DB Sensor.....	76
DATABASE command keywords for FP Stand-alone DB Sensor.....	79
JCL examples for FP Stand-alone DB Sensor.....	80
Chapter 14. Output from FP Stand-alone DB Sensor.....	83
Runtime Summary report from FP Stand-alone DB Sensor.....	83
Processing report from FP Stand-alone DB Sensor.....	84
Sensor Data Statistics report from FP Stand-alone Database Sensor.....	84
Chapter 15. Setting site default values for FP Stand-alone DB Sensor.....	93
Creating a site default table for FP Stand-alone DB Sensor.....	93
EXEC and DD statements for the FP Site Default Generation utility.....	95
Keywords for the FP Site Default Generation utility.....	98
Output from the FP Site Default Generation utility.....	99
Chapter 16. Printing sensor data by using the FP DB Sensor Printing utility.....	101
Printing a Sensor Data Statistics report	101
FP DB Sensor Printing utility JCL and control statements.....	102
EXEC and DD statements for the FP DB Sensor Printing utility.....	102
Format of the HFSPRIN control statement.....	103
GLOBAL command keyword for the FP DB Sensor Printing utility.....	104
DATABASE command keywords for the FP DB Sensor Printing utility.....	104
Output from the FP DB Sensor Printing utility.....	104
Runtime Summary report from the FP DB Sensor Printing utility.....	104
Sensor Data Statistics report from the FP DB Sensor Printing utility.....	105
Part 4. Using Stand-alone Recovery Sensor.....	115
Chapter 17. Overview of Recovery Sensor.....	117
Chapter 18. Running Recovery Sensor.....	119
Chapter 19. Recovery Sensor JCL and control statements.....	121
EXEC and DD statements for Recovery Sensor.....	121
Format of the IROSIN control statement.....	123
GLOBAL command keywords for Recovery Sensor.....	125
DATABASE command keywords for Recovery Sensor.....	125
CA command keywords for Recovery Sensor.....	126
JCL examples for Recovery Sensor.....	126
Chapter 20. Output from Recovery Sensor.....	127
Runtime summary report from Recovery Sensor.....	127

Part 5. Troubleshooting.....	129
Chapter 21. Messages and codes.....	131
Data Sensor return codes.....	131
FF DB Sensor messages.....	132
FP DB Sensor messages.....	155
Recovery Sensor messages (IRO).....	155
Chapter 22. Gathering diagnostic information.....	159
Chapter 23. Diagnostics Aid for FF Stand-alone DB Sensor.....	161
How to run FF DB Sensor Diagnostics Aid with JCL.....	161
FF DB Sensor Diagnostics Aid APAR status reports.....	162
DB Sensor Load Module APAR Status report.....	162
DB Sensor Macro APAR Status report.....	162
FF DB Sensor Diagnostic Aid messages and codes.....	163
FF DB Sensor Diagnostics Aid return codes.....	163
FF DB Sensor Diagnostics Aid abend codes.....	163
FF DB Sensor Diagnostics Aid messages.....	163
Chapter 24. Diagnostics Aid for FP Stand-alone DB Sensor.....	167
How to run FP DB Sensor Diagnostics Aid with JCL.....	167
FP DB Sensor Diagnostics Aid APAR status reports.....	168
DB Sensor Load Module APAR Status report.....	168
DB Sensor Macro APAR Status report.....	168
FP DB Sensor Diagnostics Aid messages and codes.....	169
FP DB Sensor Diagnostics Aid return codes.....	169
FP DB Sensor Diagnostics Aid abend codes.....	169
FP DB Sensor Diagnostics Aid messages.....	169
Part 6. Reference.....	173
Chapter 25. How to read syntax diagrams.....	175
Notices.....	177
Index.....	181

About this information

Data Sensor is a general term that represents any of the data collection components provided by and used by many IMS Tools products. Data Sensor is a component of IBM® IMS Database Solution Pack for z/OS®, IBM IMS Database Utility Solution for z/OS, IBM IMS Fast Path Solution Pack for z/OS, and IBM IMS Recovery Solution Pack for z/OS.

These topics provide instructions for using Data Sensor. These topics are designed to help database administrators perform these tasks:

- Install and operate Data Sensor
- Customize your Data Sensor environment
- Diagnose and recover from Data Sensor problems
- Use Data Sensor with other IMS Tools products and components

To use these topics, you should have a working knowledge of:

- The z/OS operating system
- ISPF
- SMP/E

Always refer to the IMS Tools Product Documentation web page for complete product documentation resources:

<https://www.ibm.com/support/pages/node/712955>

The IMS Tools Product Documentation web page includes:

- Links to [IBM Documentation](#) for the user guides ("HTML")
- PDF versions of the user guides ("PDF")
- Program Directories for IMS Tools products
- Technical notes from IBM Software Support, referred to as "Tech notes"
- White papers that describe product business scenarios and solutions

Part 1. Introduction to Data Sensor

Data Sensor is a general term that represents any of the data collection components provided by and used by many IMS Tools products.

Data Sensors are components of IBM IMS Database Solution Pack for z/OS, IBM IMS Database Utility Solution for z/OS, IBM IMS Fast Path Solution Pack for z/OS, and IBM IMS Recovery Solution Pack for z/OS.

The following topics provide an overview of the Data Sensor, its main concepts and modules, and how to get started.

Topics:

- [Chapter 1, “Data Sensor overview,” on page 3](#)
- [Chapter 2, “Installing Data Sensor,” on page 15](#)

Chapter 1. Data Sensor overview

Data Sensor is a general term that represents any of the data collection components provided by and used by many IMS Tools products. Data Sensor collects statistics from IMS database environments and stores the data in a central repository that is provided by IMS Tools Knowledge Base. The stored data can be used by Autonomics Director, Policy Services, and IMS Administration Foundation or Management Console for database analysis, tuning purposes, and evaluations required by the autonomics process.

Topics:

- [“What's new in Data Sensor?” on page 3](#)
- [“What does Data Sensor do?” on page 7](#)
- [“Data Sensor components” on page 8](#)
- [“Database Sensor features and benefits \(FF and FP DB Sensors\)” on page 9](#)
- [“Database Sensor process flow \(FF and FP DB Sensors\)” on page 10](#)
- [“Data Sensor terminology” on page 12](#)
- [“Service updates and support information” on page 13](#)
- [“Product Documentation and updates” on page 13](#)
- [“Accessibility features” on page 14](#)

What's new in Data Sensor?

This topic summarizes the technical changes for this edition.

New and changed information is indicated by a vertical bar (|) to the left of a change. Editorial changes that have no technical significance are not noted.

Revision markers follow these general conventions:

- Only technical changes are marked; style and grammatical changes are not marked.
- If part of an element, such as a paragraph, syntax diagram, list item, task step, or figure is changed, the entire element is marked with revision markers, even though only part of the element might have changed.
- If a topic is changed by more than 50%, the entire topic is marked with revision markers (so it might seem to be a new topic, even though it is not).

Revision markers do not necessarily indicate all the changes made to the information because deleted text and graphics cannot be marked with revision markers.

SC19-3283-09 (August 2023)

Description	Related APARs
<p>FF Stand-alone DB Sensor: A new keyword, SENSOR_DBINFO, is added. This keyword is for the GLOBAL command of the FF Stand-alone DB Sensor. Use this keyword to collect information about space utilization in database data sets from the system catalog and VTOC without scanning the databases.</p> <p>The following topics are added or updated:</p> <ul style="list-style-type: none">• “GLOBAL command keywords for FF Stand-alone DB Sensor” on page 28• “Runtime Summary report from FF Stand-alone DB Sensor” on page 37• “Sensor Data Statistics report from FF Stand-alone Database Sensor” on page 38• “Keywords for the FF Site Default Generation utility” on page 48• “Output from the FF Site Default Generation utility” on page 49• “Sensor Data Statistics report from the FF DB Sensor Printing utility” on page 55• New messages: BBE1434E, BBE1435I• Modified messages: BBE1331I, BBE1332I, BBE1446E, BBE3217E	PH55586

SC19-3283-08 (June 2023)

Description	Related APARs
<p>FF Stand-alone DB Sensor: The following new keywords are added.</p> <ul style="list-style-type: none">• SEGMENT_STAT: GLOBAL command keyword for FF Stand-alone DB Sensor. Specifies whether to collect data elements that are related to the segment occurrence count at the database level.• SEGSTAT_REPORT: GLOBAL command keyword for the FF DB Sensor Printing utility. Specifies whether to include, in the report, latest sensor data that are related to the segment occurrence count at the database level. <p>The following topics are added or updated:</p> <ul style="list-style-type: none">• Chapter 4, “Considerations for collecting sensor data from full-function databases,” on page 21• “GLOBAL command keywords for FF Stand-alone DB Sensor” on page 28• “Runtime Summary report from FF Stand-alone DB Sensor” on page 37• “Sensor Data Statistics report from FF Stand-alone Database Sensor” on page 38• “Keywords for the FF Site Default Generation utility” on page 48• “Output from the FF Site Default Generation utility” on page 49• “GLOBAL command keywords for the FF DB Sensor Printing utility” on page 54• “DATABASE command keywords for the FF DB Sensor Printing utility” on page 54• “Runtime Summary report from the FF DB Sensor Printing utility” on page 54• “Sensor Data Statistics report from the FF DB Sensor Printing utility” on page 55• New messages: BBE1331I, BBE1351I, BBE1433E, BBE1454E, BBE1487E, BBE1488E• Modified messages: BBE1446E, BBE1482E, BBE3217E	PH52476

SC19-3283-07 (October 2022)

Description	Related APARs
Stand-alone Recovery Sensor: Recovery Sensor checks whether all the libraries concatenated to STEPLIB are APF-registered (whether STEPLIB is APF-authorized). If the STEPLIB is not APF-authorized, it issues message IRO4017A and terminates with a return code of 8.	PH49839

SC19-3283-06 (July 2022)

Description	Related APARs
Documentation updates to support IMS Administration Foundation, which activates the IMS administration web-browser interface of IBM Unified Management Server for z/OS to enable the management IMS systems and resources.	N/A

SC19-3283-05 (May 2022)

Description	Related APARs
Updated the explanation section and the system action section of message BBE1323I.	N/A

SC19-3283-04 (April 2021)

Description	Related APARs
Information to support APAR PH29916 is added to Chapter 4, “ Considerations for collecting sensor data from full-function databases ,” on page 21.	PH29916
Information to support APAR PH01390 is added to the following topics: <ul style="list-style-type: none">“EXEC and DD statements for FF Stand-alone DB Sensor” on page 25“GLOBAL command keywords for FF Stand-alone DB Sensor” on page 28“Runtime Summary report from FF Stand-alone DB Sensor” on page 37“Keywords for the FF Site Default Generation utility” on page 48“Output from the FF Site Default Generation utility” on page 49	PH01390
Information to support APAR PH02047 is added to “ GLOBAL command keywords for FF Stand-alone DB Sensor ” on page 28.	PH02047
BBE messages are added or modified to support APARs PI79036, PI93606, PH00451, PH01390, and PH29916. See “ FF DB Sensor messages ” on page 132.	PI79036, PI93606, PH00451, PH01390, and PH29916
Information to support APAR PI70018 is added to the following topics: <ul style="list-style-type: none">“EXEC and DD statements for FP Stand-alone DB Sensor” on page 69“GLOBAL command keywords for FP Stand-alone DB Sensor” on page 76“Runtime Summary report from FP Stand-alone DB Sensor” on page 83“Processing report from FP Stand-alone DB Sensor” on page 84“EXEC and DD statements for the FP Site Default Generation utility” on page 95“Keywords for the FP Site Default Generation utility” on page 98“Output from the FP Site Default Generation utility” on page 99	PI70018

SC19-3283-03 (October 2016)

Description	Related APARs
Information for Recovery Sensor is described in Part 4, "Using Stand-alone Recovery Sensor," on page 115.	N/A

SC19-3283-02 (September 2016)

Description	Related APARs
Information to support APAR PI59655 is added to the following topics: <ul style="list-style-type: none">• "GLOBAL command keywords for FP Stand-alone DB Sensor" on page 76• "Keywords for the FP Site Default Generation utility" on page 98	PI59655
Information to support APAR PI63567 is added to the following topics: <ul style="list-style-type: none">• "GLOBAL command keywords for FF Stand-alone DB Sensor" on page 28• "Keywords for the FF Site Default Generation utility" on page 48	PI63567
Updated several topics to support IBM IMS Database Utility Solution for z/OS.	N/A

SC19-3283-01 (December 2014)

Description	Related APARs
Information to support APAR PM50736 is added to the following topics: <ul style="list-style-type: none">• "EXEC and DD statements for FP Stand-alone DB Sensor" on page 69• "GLOBAL command keywords for FP Stand-alone DB Sensor" on page 76• "DATABASE command keywords for FP Stand-alone DB Sensor" on page 79	PM50736
Information to support APAR PM55324 is added to "Creating a site default table for FP Stand-alone DB Sensor" on page 93.	PM55324
Information to support APAR PM73363 is added to "GLOBAL command keywords for FP Stand-alone DB Sensor" on page 76.	PM73363
Information to support APAR PM76414 is added to the following topics: <ul style="list-style-type: none">• "GLOBAL command keywords for FP Stand-alone DB Sensor" on page 76• "DATABASE command keywords for FP Stand-alone DB Sensor" on page 79	PM76414
Information to support APAR PM79336 is added to "EXEC and DD statements for FP Stand-alone DB Sensor" on page 69.	PM79336
Information to support APAR PI05155 and PI06811 is added to the following topics: <ul style="list-style-type: none">• "Sensor Data Statistics report from FP Stand-alone Database Sensor" on page 84• "Sensor Data Statistics report from the FP DB Sensor Printing utility" on page 105	PI05155 and PI06811
Information to support APAR PI08979 is added to "GLOBAL command keywords for FF Stand-alone DB Sensor" on page 28.	PI08979

Description	Related APARs
Information to support APAR PI06716 is added to the following topics: <ul style="list-style-type: none"> • “EXEC and DD statements for FP Stand-alone DB Sensor” on page 69 • “Sensor Data Statistics report from FP Stand-alone Database Sensor” on page 84 • “Sensor Data Statistics report from the FP DB Sensor Printing utility” on page 105 	PI06716
Documentation updates are made to the following topics: <ul style="list-style-type: none"> • “Database Sensor features and benefits (FF and FP DB Sensors)” on page 9 • “DATABASE command keywords for the FF DB Sensor Printing utility” on page 54 • “DATABASE command keywords for the FP DB Sensor Printing utility” on page 104 • “BBE1451E” on page 147 	N/A

What does Data Sensor do?

Data Sensor components collect statistics from an IMS database environment and store them as sensor data in an IMS Tools Knowledge Base repository.

Sensor data is the information collected by a Data Sensor component when, at an instance in time, it scans one or more IMS database environments and measures the specified conditions (or states) occurring in those environments.

The stored data can be used by Autonomics Director, Policy Services, and IMS Administration Foundation or Management Console for database analysis, tuning purposes, and evaluations required by the autonomics process.

Data Sensor also prints the stored data in a report, and stores the report in the Output repository of IMS Tools Knowledge Base.

Data Sensor components

All Data Sensors are provided as stand-alone components that must be configured and run as a separate job.

Some Data Sensors are integrated with IMS Tools products and are run and controlled at the product level.

IMS Tools provides three Data Sensor components:

- Full-Function Database Sensor (stand-alone and integrated)
- Fast Path Database Sensor (stand-alone and integrated)
- Recovery Sensor (stand-alone only)

The Fast Path and Full-Function Database Sensor components function in an IMS Tools space management and reorganization domain and capture statistics about the characteristics and organization of data in each database. Information is also collected from the system catalog, VSAM catalog, and Volume Table of Contents (VTOC).

The Recovery Sensor component functions in an IMS Tools recovery domain and captures information from the content of DBRC RECON data sets. Data is gathered about individual databases, HALDB partitions, Fast Path areas, and change accumulation groups.

Sensor data and autonomics

The data that is stored in the Sensor Data repository of IMS Tools Knowledge Base is used in Autonomics Director jobs to monitor and maintain the health, performance, and recoverability of the database. In the Autonomics Director jobs, the policy evaluation process of Policy Services is internally called.

Policy Services uses a policy definition to evaluate the sensor data against the threshold values specified for this condition. Policy Services can then provide a response to any events that exceed the threshold limits. The response can consist of sending warning notifications to administrators and making a recommendation to the IMS Tools product to take a specific corrective action.

When the jobs end, you can use IMS Administration Foundation or Management Console to view graphical visualization and charting of sensor data, the exceptions that were detected by the policy evaluations, and recommendations for resolving the exceptions.

Autonomics Director, IMS Administration Foundation, IMS Tools Knowledge Base, and Policy Services are components of IBM IMS Tools Base for z/OS. For more information about these tools, see the following information:

- *IMS Tools Base Autonomics Director User's Guide*
- *IMS Tools Base Configuration Guide*
- *IMS Tools Base IMS Tools Knowledge Base User's Guide*
- *IMS Tools Base Policy Services User's Guide*
- *Management Console User's Guide*
- *Unified Management Server User Guide*

Data Sensor components

Data Sensor consists of several components.

FF Database Sensor, FP Database Sensor, and Recovery Sensor

Data Sensor components are delivered in IMS Tools solution packs; IMS Database Solution Pack, IMS Database Utility Solution, IMS Fast Path Solution Pack, and IMS Recovery Solution Pack.

- Data Sensor that can be used for full-function databases is delivered with IMS Database Solution Pack and IMS Database Utility Solution, and the component is referred to as *Full-Function Database Sensor* (also referred to as *FF DB Sensor*).
- Data Sensor that can be used for DEDBs is delivered with IMS Fast Path Solution Pack, and the component is referred to as *Fast Path Database Sensor* (also referred to as *FP DB Sensor*).
- Data Sensor that is delivered with IMS Recovery Solution Pack is referred to as *Recovery Sensor*. Recovery Sensor can collect statistics from the content of DBRC RECON data sets.

Stand-alone Data Sensor and Integrated Data Sensor

You can run a Data Sensor job as a stand-alone job, or you can include the FF DB Sensor or FP DB Sensor process in the jobs of IMS Database Reorganization Expert, IMS High Performance Image Copy, IMS High Performance Pointer Checker, and IMS High Performance Fast Path Utilities.

The following terms are used to distinguish the two forms of execution:

- Data Sensor that runs as a stand-alone job is referred to as *Stand-alone Data Sensor*.
- Data Sensor that runs within other IMS Tools product jobs is referred to as *Integrated Data Sensor*.

The *IMS Solution Packs: Data Sensor User's Guide* provides information about using Stand-alone Data Sensors.

For information about using Integrated Data Sensors, see the following information:

- *IMS Database Reorganization Expert User's Guide*
- *IMS High Performance Image Copy User's Guide*
- *IMS High Performance Pointer Checker User's Guide*

- *IMS FP Solution Pack: IMS High Performance Fast Path Utilities User's Guide*

Throughout this information, the term *Data Sensor* includes Stand-alone Data Sensor and Integrated Data Sensor except where distinction among them need to be made.

DB Sensor Site Default Generation utilities (FF and FP DB Sensors)

You can use the Site Default Generation utilities to set your own default values for the Stand-alone DB Sensor runtime options.

The FF DB Sensor Site Default Generation utility is provided for FF Stand-alone DB Sensor, and the FP DB Sensor Site Default Generation utility is provided for FP Stand-alone DB Sensor.

DB Sensor Printing utilities (FF and FP DB Sensors)

You can use the DB Sensor Printing utilities to print the data element values that are stored in the IMS Tools KB Sensor Data repository in the Sensor Data Statistics report. By using this utility, you can analyze the most recent database statistics data.

The FF DB Sensor Printing utility is provided to process sensor data of full-function databases and DEDBs. The FP DB Sensor Printing utility is provided to process sensor data of DEDBs.

Restriction: To process sensor data of DEDBs with the FF DB Sensor Printing utility, you must install IMS Fast Path Solution Pack.

Database Sensor features and benefits (FF and FP DB Sensors)

DB Sensor offers several unique features that you can use to improve your database monitoring and maintenance tasks.

Provides flexible methods for collecting sensor data

DB Sensor runs as a z/OS batch job. You can run a DB Sensor job as a stand-alone job, or you can include DB Sensor processing in the jobs of certain tools that are included in IMS Database Solution Pack, IMS Database Utility Solution, and IMS Fast Path Solution Pack. Consequently, you can collect sensor data while running a tool to accomplish a different task.

Supports various types of IMS databases and conditions

DB Sensor supports various types of IMS databases and their conditions:

- DB Sensor supports the full-function databases including High Availability Large Databases (HALDB) and DEDBs.
- DB Sensor can process databases whether they are online or offline. DB Sensor can collect the most recent statistics about the databases.

Collects various aspects of database utilization

DB Sensor scans a database, analyzes the state of database space utilization, and collects statistics. DB Sensor calculates data element values from the statistics and stores them in the IMS Tools Knowledge Base Sensor Data repository as sensor data.

The data elements represent the following aspects of database and they can be used to determine whether you need to reorganize or re-create the database:

- Root segments distribution and synonyms
- Database records
- IMS segment occurrence and free space
- IMS segments fragmentation (split segments)
- Estimated I/O occurrences
- Usage of overflow area
- Usage of DEDB IOVF and DOVF
- Usage of DEDB SDEP
- DEDB UOW distribution
- Data set space information (for example, used space compared to allowable size, data set size, free space, extensions, and CI and CA splits)

- DEDB definition information

Prints sensor data

When DB Sensor stores the sensor data in the Sensor Data repository, it prints the data element values in the Sensor Data Statistics report. This report can be stored in the Output repository of IMS Tools Knowledge Base. You can use this report to determine the state of database immediately after you run DB Sensor or at a later time for historical analysis.

Integrates with IMS Tools Base components and common tools

DB Sensor integrates with the capabilities provided by IMS Tools Base, IMS Administration Foundation, and Management Console.

- When Policy Services evaluates the sensor data, you can receive notifications and recommendations from Policy Services if one or more data element values exceed the threshold values. The policy evaluation of Policy Services can be invoked through Autonomics Director and IMS Database Reorganization Expert.
- You can analyze the sensor data by viewing the charts that are provided by IMS Administration Foundation and Management Console. Sensor data that is displayed in graphical form helps you to identify and predict trends based on database statistics.
- Stand-alone DB Sensor and Integrated DB Sensor jobs (runs within IMS HP Image Copy, IMS HP Pointer Checker, and IMS HP Fast Path Utilities jobs) can be submitted automatically by Autonomics Director.
- When DB Sensor stores sensor data in the Sensor Data repository, it sends a notification to Autonomics Director. You can set Autonomics Director to automatically start evaluating policies by calling Policy Services upon receiving the notification.

Database Sensor process flow (FF and FP DB Sensors)

DB Sensor accesses IMS databases to collect database statistics and interacts with IMS Tools KB to store the collected statistics data in the Sensor Data repository. Optionally, DB Sensor can send a notification to Autonomics Director after storing the collected data in the IMS Tools KB repository.

Stand-alone DB Sensor process flow

The following figure illustrates the process flow for Stand-alone DB Sensor.

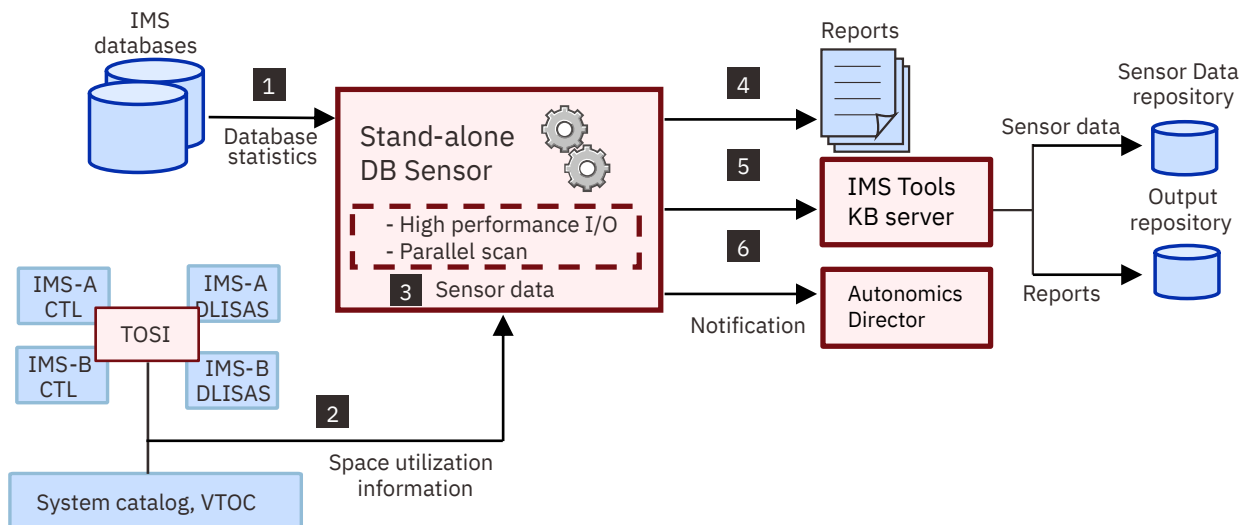

Figure 1. Stand-alone DB Sensor process flow

The following steps match the numbers in the figure:

1. DB Sensor scans IMS databases and collects statistics about the organization of the data in the databases.

To improve performance, DB Sensor adopts parallel scanning and high performance I/O techniques to scan the database data sets.

2. FF DB Sensor also obtains the space utilization information about the database data sets from the system catalog and VTOC. If the databases are online and if they are VSAM files, DB Sensor obtains the current VSAM statistics by using IMS Tools Online System Interface (TOSI).
3. DB Sensor organizes the statistics into sensor data.
4. DB Sensor generates reports. The reports contain data element values.
5. DB Sensor stores the sensor data in the IMS Tools KB Sensor Data repository.

DB Sensor also stores the reports in the IMS Tools KB Output repository.

6. DB Sensor notifies Autonomics Director that the sensor data is stored in the Sensor Data repository.

Note: If you specify ITKBSRVR=*NO for FF Stand-alone DB Sensor, steps “5” on page 11 and “6” on page 11 are bypassed.

Integrated DB Sensor process flow

The following figure illustrates the process flow for Integrated DB Sensor.

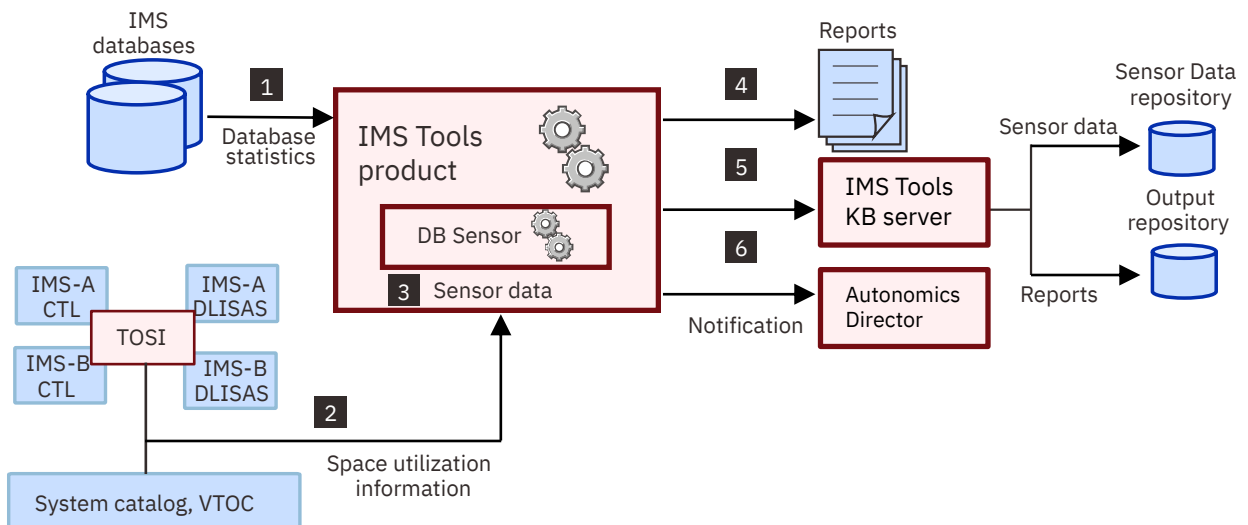

Figure 2. Integrated DB Sensor process flow

The process flow for Integrated DB Sensor is similar to the process flow for Stand-alone DB Sensor. The only differences are steps “1” on page 11 and “6” on page 11.

The following steps match the numbers in the figure:

1. The parent IMS Tools product program reads the database data sets.
2. FF DB Sensor also obtains space utilization information about the database data sets from the system catalog and VTOC. If the databases are online and if they are VSAM files, DB Sensor obtains the current VSAM statistics by using IMS Tools Online System Interface (TOSI).
3. DB Sensor organizes the statistics into sensor data.
4. DB Sensor generates reports. The reports contain data element values.
5. DB Sensor stores sensor data in the IMS Tools KB Sensor Data repository.
DB Sensor also stores the reports in the IMS Tools KB Output repository.
6. DB Sensor notifies Autonomics Director that the sensor data is stored in the Sensor Data repository.

Note: The notification is not sent when the parent product is IMS Database Reorganization Expert. The notification is typically sent to Autonomics Director to request a policy evaluation of the sensor data,

but policy evaluation can be performed within IMS Database Reorganization Expert jobs; therefore, the notification to Autonomics Director is not sent.

Data Sensor terminology

These topics include several unique terms that you should understand before you begin to use Data Sensor.

Unique terms used in this information

Data elements

Sensor data is stored in the Sensor Data repository as a group (or a set) of records made up of data elements.

A data element consists of a data element tag and a data element value pair.

Stand-alone Data Sensor

Stand-alone Data Sensor refers to Data Sensor that runs as a stand-alone job.

Integrated Data Sensor

Integrated Data Sensor refers to the Data Sensor process that runs within other IMS Tools product jobs.

Sensor data

Sensor data refers to statistics data that is collected by Data Sensor.

Sensor data for space management and reorganization domains includes information about the characteristics of the organization of the data in the database as well as information from the system catalog, VSAM catalog, and disk Volume Table of Contents (VTOC).

Sensor data for recovery domains includes information from the content of DBRC RECON data sets.

Product short names

These topics use the following abbreviations for product short names.

Table 1. Product short names

Short name	Product name
Autonomics Director	Autonomics Director component of IBM IMS Tools Base for z/OS 1.6 (5655-V93) or later
IMS	<ul style="list-style-type: none">• IBM IMS 15.1 Database Manager (5635-A06) or later• IMS Database Value Unit Edition 15.1 (5655-DS5) or later
IMS Administration Foundation	IBM IMS Administration Foundation for z/OS, which is delivered with IBM IMS Tools Base 1.7 (5655-V93) or later and extends the features of IBM Unified Management Server for z/OS 1.1 (5698-UM1).
IMS Database Reorganization Expert	IBM IMS Database Reorganization Expert for z/OS 4.1 (5655-S35)
IMS Database Solution Pack	IBM IMS Database Solution Pack for z/OS 2.2 (5655-DSP) or later
IMS Database Utility Solution	IBM IMS Database Utility Solution for z/OS 2.1 (5698-DUL) or later
IMS Fast Path Solution Pack	IBM IMS Fast Path Solution Pack for z/OS 2.1 (5698-FPP) or later
IMS HP Fast Path Utilities	IMS High Performance Fast Path Utilities of IBM IMS Fast Path Solution Pack for z/OS

Table 1. Product short names (continued)

Short name	Product name
IMS HP Image Copy	IBM IMS High Performance Image Copy for z/OS 4.2 (5655-N45)
IMS HP Pointer Checker	IBM IMS High Performance Pointer Checker for z/OS 3.1 (5655-U09)
IMS Recovery Solution Pack	IBM IMS Recovery Solution Pack for z/OS 2.1 (5655-ISR) or later
IMS Tools Base	IBM IMS Tools Base for z/OS 1.6 (5655-V93) or later
IMS Tools Knowledge Base, IMS Tools KB, or ITKB	IMS Tools Knowledge Base component of IBM IMS Tools Base for z/OS
IMS Tools Online System Interface or TOSI	IMS Tools Online System Interface of IBM IMS Tools Base for z/OS
Management Console	IBM Management Console for IMS and Db2® for z/OS 1.1 (5655-TAC)
Policy Services	Policy Services component of IBM IMS Tools Base for z/OS

Service updates and support information

Service updates and support information for this product, including software fix packs, PTFs, frequently asked questions (FAQs), technical notes, troubleshooting information, and downloads, are available from the web.

To find service updates and support information, see the following website:

- [IBM Support: IMS Database Solution Pack for z/OS](#)
- [IBM Support: IMS Database Utility Solution for z/OS](#)
- [IBM Support: IMS Fast Path Solution Pack for z/OS](#)
- [IBM Support: IMS Recovery Solution Pack for z/OS](#)

Product Documentation and updates

IMS Tools information is available at multiple places on the web. You can receive updates to IMS Tools information automatically by registering with the IBM My Notifications service.

Information on the web

Always refer to the IMS Tools Product Documentation web page for complete product documentation resources:

<https://www.ibm.com/support/pages/node/712955>

The IMS Tools Product Documentation web page includes:

- Links to [IBM Documentation](#) for the user guides ("HTML")
- PDF versions of the user guides ("PDF")
- Program Directories for IMS Tools products
- Technical notes from IBM Software Support, referred to as "Tech notes"
- White papers that describe product business scenarios and solutions

IBM Redbooks® publications that cover IMS Tools are available from the following web page:

<http://www.redbooks.ibm.com>

The IBM Information Management System website shows how IT organizations can maximize their investment in IMS databases while staying ahead of today's top data management challenges:

<https://www.ibm.com/software/data/ims>

Receiving documentation updates automatically

To automatically receive emails that notify you when new technote documents are released, when existing product documentation is updated, and when new product documentation is available, you can register with the IBM My Notifications service. You can customize the service so that you receive information about only those IBM products that you specify.

To register with the My Notifications service:

1. Go to <https://www.ibm.com/support/mynotifications>
2. Enter your IBM ID and password, or create one by clicking **register now**.
3. When the My Notifications page is displayed, click **Subscribe** to select those products that you want to receive information updates about. The IMS Tools option is located under **Software > Information Management**.
4. Click **Continue** to specify the types of updates that you want to receive.
5. Click **Submit** to save your profile.

How to send your comments

Your feedback is important in helping us provide the most accurate and highest quality information. If you have any comments about this or any other IMS Tools information, you can take one of the following actions:

- Click the Feedback button at the top of the IBM Documentation topic that you are commenting on.
- Click the Contact Us tab at the bottom of any IBM Documentation topic.
- Send an email to ibmdocs@us.ibm.com. Be sure to include the book title, topic or section title, specific text, and your comment.

To help us respond quickly and accurately, include as much information as you can about the content you are commenting on, where we can find it, and what your suggestions for improvement might be.

Accessibility features

Accessibility features help a user who has a physical disability, such as restricted mobility or limited vision, to use a software product successfully.

The major accessibility features in Data Sensor enable users to:

- Use assistive technologies such as screen readers and screen magnifier software. Consult the assistive technology documentation for specific information when using it to access z/OS interfaces.
- Customize display attributes such as color, contrast, and font size.
- Operate specific or equivalent features by using only the keyboard. Refer to the following publications for information about accessing ISPF interfaces:
 - *z/OS ISPF User's Guide, Volume 1*
 - *z/OS TSO/E Primer*
 - *z/OS TSO/E User's Guide*

These guides describe how to use ISPF, including the use of keyboard shortcuts or function keys (PF keys), include the default settings for the PF keys, and explain how to modify their functions.

Chapter 2. Installing Data Sensor

Data Sensor is delivered with IMS Database Solution Pack, IMS Database Utility Solution, IMS Fast Path Solution Pack, and IMS Recovery Solution Pack. Before you install Data Sensor, make sure that your environment meets the installation requirements.

Data Sensor is delivered with the following products:

- IMS Database Solution Pack
- IMS Database Utility Solution
- IMS Fast Path Solution Pack
- IMS Recovery Solution Pack

For installation requirements, see the topics about installation requirements in the following information:

- *IMS Database Solution Pack: Overview and Customization*
- *IMS Database Utility Solution: Overview and Customization*
- *IMS Fast Path Solution Pack: Overview and Customization*
- *IMS Recovery Solution Pack: Overview and Customization*

Important: To run Data Sensor, you must install IMS Tools Base and then configure IMS Tools Online System Interface, IMS Tools Knowledge Base, and Autonomics Director.

- If you plan to use Integrated Data Sensor only in IMS Database Reorganization Expert jobs, the minimum requirements are installation and configuration of IMS Database Reorganization Expert. For more information, see the *IMS Database Reorganization Expert User's Guide*.
- If you plan to use FF Stand-alone DB Sensor only to obtain sensor data through reports, you do not need to configure IMS Tools Knowledge Base.

Part 2. Using FF Stand-alone Database Sensor

Full-function Stand-alone DB Sensor (also referred to as FF Stand-alone DB Sensor) can collect statistics of IMS full-function databases.

The following topics explain how to use FF Stand-alone DB Sensor.

Topics:

- [Chapter 3, “Overview of FF Stand-alone DB Sensor,” on page 19](#)
- [Chapter 4, “Considerations for collecting sensor data from full-function databases,” on page 21](#)
- [Chapter 5, “Running FF Stand-alone DB Sensor,” on page 23](#)
- [Chapter 6, “FF Stand-alone DB Sensor JCL and control statements,” on page 25](#)
- [Chapter 7, “Output from FF Stand-alone DB Sensor,” on page 37](#)
- [Chapter 8, “Setting site default values for FF Stand-alone DB Sensor,” on page 45](#)
- [Chapter 9, “Printing sensor data by using the FF DB Sensor Printing utility,” on page 51](#)

Chapter 3. Overview of FF Stand-alone DB Sensor

You can use FF Stand-alone DB Sensor to collect sensor data from IMS full-function databases.

FF Stand-alone DB Sensor runs as a batch job step of z/OS.

FF Stand-alone DB Sensor scans database data sets and collects database statistics. Then it organizes the statistics into sensor data and, if the name of IMS Tools KB server is provided, it stores the sensor data in the IMS Tools KB Sensor Data repository in the form of records that are comprised of data elements. FF Stand-alone DB Sensor also prints the data element values in the Sensor Data Statistics report and stores the report in the Output repository of IMS Tools KB. When FF Stand-alone DB Sensor completes storing the sensor data in the repository, it notifies the Autonomics Director server that the sensor data is stored.

FF Stand-alone DB Sensor supports the following database organizations:

- HDAM
- HIDAM
- PHDAM
- PHIDAM
- HISAM
- SHISAM

FF Stand-alone DB Sensor also supports the following index databases:

- HIDAM primary index
- PHIDAM primary index
- Secondary index
- HALDB partitioned secondary index

For HALDB, FF Stand-alone DB Sensor processes only the active side (A or M side) of data sets.

Restriction: FF Stand-alone DB Sensor does not support HALDB partitions when the partition is under online reorganization processing or online reorganization suspended, that is, when OLR cursor active.

FF Stand-alone DB Sensor can process online IMS databases.

One FF Stand-alone DB Sensor job can process multiple databases and partitions.

For a list of the data elements that are collected by FF Stand-alone DB Sensor, see the topics about data elements in the *IMS Tools Base Policy Services User's Guide*.

Chapter 4. Considerations for collecting sensor data from full-function databases

Certain considerations apply when collecting sensor data from full-function databases.

Collecting sensor data from a database that is being updated

DB Sensor can collect sensor data from an online database or from a database that is being updated by batch jobs.

However, when the database data set is VSAM, due to file system limitations, the following data element values reflect the database status of when the file was opened. Consequently, the values do not reflect the latest database status.

- DB_RBA_HIGH_USED
- DB_RBA_HIGH_ALLOC
- DB_UNUSED_BYTES
- DB_PCT_UNUSED_BYTES
- DB_PCT_OF_MAX_DS_SIZE
- DB_PCT_BYTES_SEG (See Note “1” on page 21)
- DB_PCT_BYTES_FREE_SPACE (See Note “1” on page 21)
- DB_NUM_DBDS_BLOCKS (See Note “1” on page 21)
- DB_NUM_CI_SPLIT
- DB_PCT_NUM_CI_SPLIT
- DB_NUM_CA_SPLIT
- DB_PCT_NUM_CA_SPLIT
- DBX_NUM_IPS_DB (See Note “2” on page 22)
- DBX_NUM_IPS
- DBX_NUM_IPS_PRIM (See Note “2” on page 22)
- DBX_NUM_IPS_OVFL
- DBX_PCT_IPS_OVFL
- DBX_RBA_HIGH_USED
- DBX_RBA_HIGH_ALLOC
- DBX_UNUSED_BYTES
- DBX_PCT_UNUSED_BYTES
- DBX_PCT_OF_MAX_DS_SIZE
- DBX_NUM_DBDS_BLOCKS
- DBX_NUM_CI_SPLIT
- DBX_PCT_NUM_CI_SPLIT
- DBX_NUM_CA_SPLIT
- DBX_PCT_NUM_CA_SPLIT

Notes:

1. For DB_PCT_BYTES_SEG, DB_PCT_BYTES_FREE_SPACE, and DB_NUM_DBDS_BLOCKS, if the database data set is a VSAM KSDS (HISAM or SHISAM), data element values do not reflect the latest status. For VSAM ESDS data sets and VSAM linear data sets (OSAM LDS), which include HDAM, HIDAM, PHDAM, and PHIDAM, these data element values always reflect the latest status.

2. DBX_NUM_IPS_DB and DBX_NUM_IPS_PRIM are collected only when GLOBAL command keyword SEGMENT_STAT=YES is specified in the BBESIN control statement.

To obtain the latest values, consider running DB Sensor as follows:

- For a database that is being updated by batch jobs, run DB Sensor after the batch jobs are complete.
- For an online database, stop the database updates by issuing the /STOP or the /DBR command, or specify the IMS Tools Online System Interface XCF group name for the DB Sensor process. If you specify the XCF group name, DB Sensor uses IMS Tools Online System Interface to collect the latest VSAM statistics and then sets the data element values based on the collected statistics.

Restriction: For VSAM data sets that use SHAREOPTION(1,3), the file system does not permit DB Sensor to collect sensor data while the database is being updated.

Chapter 5. Running FF Stand-alone DB Sensor

To run FF Stand-alone DB Sensor, code DB Sensor JCL statements and submit the job.

Before you begin

Ensure that the following components are available:

- If you want to store sensor data or reports in the IMS Tools KB repositories, ensure that the IMS Tools KB server and all the repositories, including the Sensor Data repository, are available.
- If you want to run DB Sensor for online databases to retrieve the latest VSAM statistics, make IMS Tools Online System Interface configuration available.
- If you want to run DB Sensor and a policy evaluation by using the Autonomics Director scheduling calendar, start the Autonomics Director servers.

To make these components available, see the following information:

- *IMS Tools Base Configuration Guide*
- *IMS Tools Base IMS Tools Common Services User's Guide*
- *IMS Tools Base Autonomics Director User's Guide*

Tip: Stand-alone DB Sensor provides the Site Default Generation utility. You can use this utility to set your own default values for your site. See Chapter 8, [“Setting site default values for FF Stand-alone DB Sensor,”](#) on page 45 for information about setting default values.

Procedure

1. Write the EXEC and the DD statements.

See [“EXEC and DD statements for FF Stand-alone DB Sensor”](#) on page 25 for information about the format of the EXEC statement and the input and the output DD statements.

2. Specify the GLOBAL command and keywords in the BBESIN DD.

The GLOBAL command controls the behavior of the job.

See [“GLOBAL command keywords for FF Stand-alone DB Sensor”](#) on page 28 for information about the keywords that can be specified for the GLOBAL command.

3. Specify the DATABASE commands and keywords in the BBESIN DD.

The DATABASE command specifies the database to process.

See [“DATABASE command keywords for FF Stand-alone DB Sensor”](#) on page 33 for information about the keywords that can be specified for the DATABASE command.

4. Submit the job.

Ensure that the return code is 0. If the return code is other than 0, check the write-to-operator (WTO) messages or the messages that are printed in the Runtime Summary report, and take the appropriate actions by referring to the troubleshooting information.

Chapter 6. FF Stand-alone DB Sensor JCL and control statements

Input for FF Stand-alone DB Sensor consists of JCL statements that satisfy the JCL requirements and that conform to the required control statement format.

Topics:

- [“EXEC and DD statements for FF Stand-alone DB Sensor” on page 25](#)
- [“Format of the BBESIN control statement” on page 27](#)
- [“GLOBAL command keywords for FF Stand-alone DB Sensor” on page 28](#)
- [“DATABASE command keywords for FF Stand-alone DB Sensor” on page 33](#)
- [“JCL examples for FF Stand-alone DB Sensor” on page 33](#)

EXEC and DD statements for FF Stand-alone DB Sensor

You must include the EXEC statement and appropriate DD statements in your FF Stand-alone DB Sensor JCL.

Subsections:

- [“EXEC statement” on page 25](#)
- [“DD statement summary” on page 25](#)
- [“DD statements for input” on page 26](#)
- [“DD statements for output” on page 27](#)

EXEC statement

The EXEC statement must be in the following format:

```
//STEP EXEC PGM=BBESENSR,PARM='IMSPLEX=imsplex,DBRCGRP=dbrcgrp'
```

where:

PGM

Specifies the FF Stand-alone DB Sensor program, which is BBESENSR.

PARM

Specifies the parameters. For information about specifying the PARM parameter, see *IMS System Programming APIs*.

DD statement summary

The following table summarizes the DD statements for FF Stand-alone Database Sensor.

Table 2. BBESENSR DD statements

DD name	Use	Required or optional	Format
STEPLIB	Input	Required	RECFM=U
BBESIN	Input	Required	RECFM=FB,LRECL=80
<i>database ddname</i>	Input	Required	
IMS	Input	Optional	RECFM=FB,LRECL=80

Table 2. BBESNSR DD statements (continued)

DD name	Use	Required or optional	Format
IMSDALIB	Input	Optional	RECFM=U
RECONx	Input	Optional	VSAM
BBESPRT	Output	Required	RECFM=FBA,LRECL=133
SYSUDUMP or SYSABEND	Output	Optional	RECFM=FBA,LRECL=133

DD statements for input

Specify the following input DD statements:

STEPLIB DD

This required DD statement specifies the following load module libraries. All of these libraries must be APF-authorized.

- IMS Database Solution Pack product load module library or IMS Database Utility Solution product load module library (SHPSLMDO data set, which includes DB Sensor)
- DB Sensor site default library
- IMS RESLIB, IMS user exit library (randomizer), and DFSMDA members
- SCI exit library for parallel RECON access (if used)
- IMS Tools Base product library (SHKTLOAD, SGLXLOAD, and SFOILOAD data sets)

Notes:

- The SFOILOAD data set is required when you specify the TOSIXCFGRP keyword on the BBESIN control statement.
- The SGLXLOAD data set is required when you specify the IMSCATHLQ keyword on the BBESIN control statement.

BBESIN DD

This required DD statement specifies the input data set that contains the input control statements to specify the DB Sensor runtime options.

For details about the control statement format, commands, and keywords, see the following topics:

- [“Format of the BBESIN control statement” on page 27](#)
- [“GLOBAL command keywords for FF Stand-alone DB Sensor” on page 28](#)
- [“DATABASE command keywords for FF Stand-alone DB Sensor” on page 33](#)

database ddname DD

This required DD statement specifies the name of the database data set to process. The DD name must match the DD name in the DBD.

You must specify this DD statement except in the following cases:

- If the database is a HALDB database, you do not need to specify this DD statement. The name of the database data set is obtained from the RECONx data sets, and this DD is allocated dynamically.
- If the database is a non-HALDB database, you can omit this DD statement if one of the following conditions is met:
 - The data set will be allocated dynamically by the IMS DFSMDA macro.
 - The DFSMDA member is included in the STEPLIB DD or the IMSDALIB DD.

Restriction: You cannot specify the following resources for this DD:

- An image copy data set
- An ILDS of a HALDB

- A HALDB partition that is being processed by OLR

IMS DD

This DD statement specifies the DBDLIB data set. APF-authorization is not required for the DBDLIB data set. You can omit this DD statement when you specify the IMSCATHLQ keyword on the BBESIN control statement.

IMSDALIB DD

This optional DD statement specifies the DFSMDA member modules. Specify this DD statement only if you do not want to APF-authorize the DFSMDA members data set. If both IMSDALIB and STEPLIB contain the DFSMDA members, IMSDALIB is used.

RECONx DD

These DD statements specify the RECON1, RECON2, and RECON3 data sets when DBRC is used (DBRC=YES specification in BBESIN DD). You can omit these DD statements if the DFSMDA member is included in the STEPLIB DD or the IMSMDALIB DD.

DD statements for output

Specify the following output DD statements:

BBESPRT DD

This required DD statement specifies the output data set for the FF Stand-alone DB Sensor reports.

If you omit this DD statement, it is allocated dynamically with SYSOUT=* and the reports are printed in the SYSOUT data set.

For details about the FF Stand-alone Database Sensor reports that are generated in the BBESPRT data set, see [Chapter 7, “Output from FF Stand-alone DB Sensor,” on page 37](#).

SYSUDUMP DD (or SYSABEND DD)

This optional DD statement defines the output for a system ABEND dump routine. Specify this DD statement if you want to generate a dump.

Format of the BBESIN control statement

The BBESIN control statement defines the user description of the GLOBAL command and the DATABASE command, both of which control the behavior of the DB Sensor process.

The commands and their keywords must be specified in the BBESIN data set. This data set usually resides in the input stream. However, it can also be defined as a sequential data set or as a member of a partitioned data set. It must contain 80-byte, fixed-length records. BLKSIZE, if coded, must be a multiple of 80.

The following example shows the correct syntax for the control statement in the BBESIN data set.

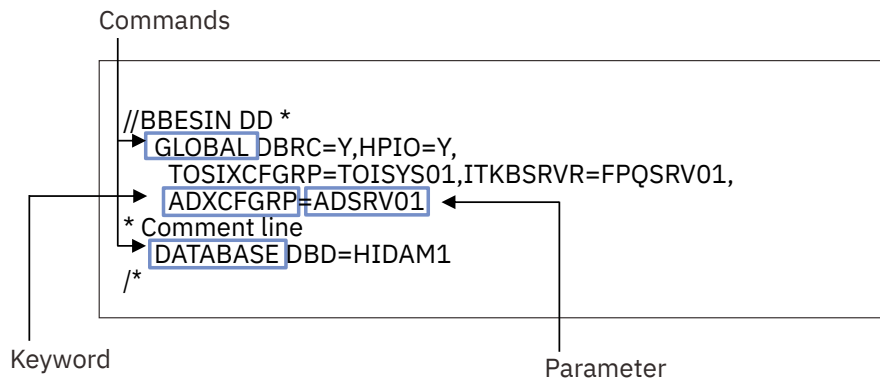

Figure 3. Format of the BBESIN control statement

A BBESIN control statement must conform to the following format:

GLOBAL command

- Only one GLOBAL command can be specified.
- The GLOBAL command keywords and their parameters follow the GLOBAL command.
- A GLOBAL command keyword and its parameter must be connected with an equal sign (=).
- Each GLOBAL command keyword and value pair must be separated by a comma.
- Multiple keyword and parameter pairs can be specified.

Keyword and parameter pairs can span more than one line; type a comma as a continuation character at the end of the first line, and continue the next keyword and parameter pair on the next line.

- A line that starts with an asterisk (*) is treated as a comment line.
- The first column must be blank.

DATABASE command

- One or more DATABASE commands can be specified.
- The DATABASE command keywords and their parameters follow the DATABASE command.
- A DATABASE command keyword and its parameter must be connected with an equal sign (=).
- Each DATABASE command keyword and value pair must be separated by a comma.
- Multiple keyword and parameter pairs can be specified.

Keyword and parameter pairs can span more than one line; type a comma as a continuation character at the end of the first line, and continue the next keyword and parameter pair on the next line.

- A line that starts with an asterisk (*) is treated as a comment line.
- The first column must be blank.

GLOBAL command keywords for FF Stand-alone DB Sensor

The GLOBAL command keywords control the behavior of the job. You must specify the GLOBAL command and its keywords in the BBESIN DD.

The following syntax diagram shows the GLOBAL command keywords for FF Stand-alone DB Sensor.

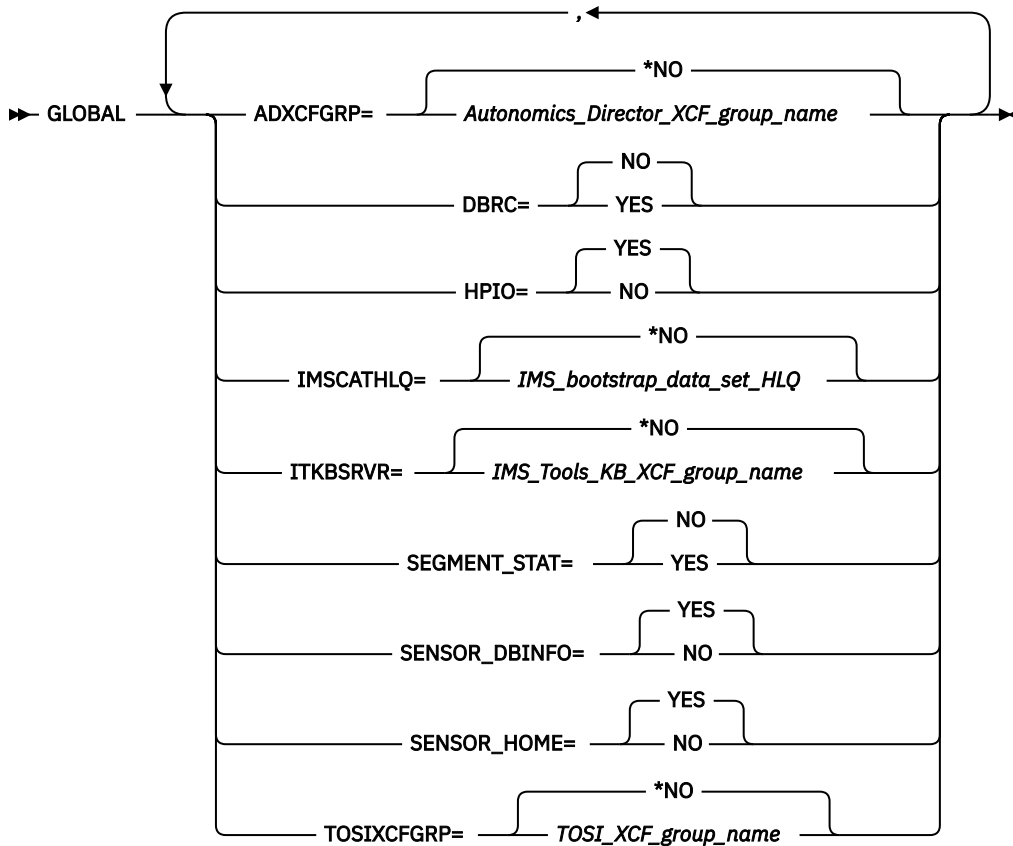

ADXCFGRP=

This keyword specifies whether to send notification to Autonomics Director. The notification is used as a trigger by Autonomics Director to schedule a policy evaluation. If you omit this keyword, ADXCFGRP=*NO is used as the default value.

Important: If you want Autonomics Director to schedule a policy evaluation, you must specify the name of the Autonomics Director XCF group with this keyword.

Autonomics_Director_XCF_group_name

FF Stand-alone DB Sensor sends sensor data notification to Autonomics Director after storing sensor data in the Sensor Data repository of IMS Tools KB.

If you specify the Autonomics Director XCF group, you must specify DBRC=YES and ITKBSRVR=IMS_Tools_KB_XCF_group_name.

***NO**

FF Stand-alone DB Sensor does not send sensor data notification to Autonomics Director.

DBRC=

This keyword specifies whether to activate DBRC. If you omit this keyword, DBRC=NO is used as the default value.

YES

Activates DBRC. When you specify DBRC=YES, FF Stand-alone DB Sensor stores sensor data in the Sensor Data repository by using the RECON ID (locale) that is associated with the RECONx data set names.

Requirements:

- To specify DBRC=YES, you must specify the RECONx DD statements or specify a DFSMDA member in the STEPLIB or IMSDALIB data set. For more information about specifying a DFSMDA member, see the topic about the DFSMDA macro in *IMS System Definition*.
- If the database is a HALDB, you must specify DBRC=YES.

NO

Does not activate DBRC. FF Stand-alone DB Sensor stores sensor data in the Sensor Data repository without using a RECON ID.

HPIO=

This keyword specifies whether to use the High Performance I/O (HPIO) technique to scan the database data set. If you omit this keyword, HPIO=YES is used as the default value.

YES

Uses the HPIO technique.

NO

Does not use the HPIO technique.

IMSCATHLQ=

This keyword specifies whether to obtain the information about the database structure (DBD) from the IMS directory instead of from the DBD library. If you specify the IMS bootstrap data set HLQ (IMS system data set HLQ) for this keyword, FF Stand-alone DB Sensor obtains the DBD from the IMS directory. This keyword is an optional keyword. If you omit this keyword, IMSCATHLQ=*NO is used as the default value.

IMS_bootstrap_data_set_HLQ

Specify the high-level qualifier (HLQ) of the IMS bootstrap data set.

***NO**

FF Stand-alone DB Sensor obtains the DB structure information from the DBD library that is specified in the IMS DD statement. In this case, IMS DD is required.

ITKBSRVR=

This keyword specifies the IMS Tools KB XCF group name (IMS Tools KB server name). The sensor data and the DB Sensor reports are stored in the IMS Tools Knowledge Base repositories that are managed by this IMS Tools KB server. If you omit this keyword, ITKBSRVR=*NO is used as the default value.

Important: If you want to analyze sensor charts on IMS Administration Foundation or Management Console or schedule a policy evaluation by using Autonomics Director, you must specify the name of the IMS Tools KB XCF group with this keyword.

IMS_Tools_KB_XCF_group_name

FF Stand-alone DB Sensor stores sensor data and reports in the IMS Tools Knowledge Base repositories.

***NO**

FF Stand-alone DB Sensor does not store sensor data or reports in the IMS Tools Knowledge Base repositories. If you specify ITKBSRVR=*NO, sensor data is available only through the Sensor Data Statistics report that is generated in the BBESPRT data set.

SEGMENT_STAT=

This keyword specifies whether to collect data elements that are related to the segment occurrence count at the database level. This keyword is an optional keyword. If you omit this keyword, SEGMENT_STAT=NO is used as the default value.

YES

Collects the following additional data elements, which are related to the segment occurrence count at the database level, and stores them in the Sensor Data repository of IMS Tools KB. For HALDBs, this keyword is ignored if not all partitions of the HALDB are specified. For the definitions of these data elements, see the topics about data elements in the *IMS Tools Base Policy Services User's Guide*.

- DB_NUM_SEG_DB
- DB_NUM_SEG_DSGnn_DB (nn: 01-10)
- DB_NUM_SEG_PART
- DB_NUM_SEG_DSGnn_PART (nn: 01-10)
- DB_NUM_DELSEG_DB

- DB_NUM_SEG_PRIM_DB
- DB_NUM_SEG_OVFL_DB
- DB_NUM_SEG_SC_DB
- DB_NUM_SEG_SC
- DB_NUM_SEG_SC_PRIM
- DB_NUM_SEG_SC_OVFL
- DB_NUM_DELSEG_SC
- DB_NUM_DELSEG_SC_PRIM
- DB_NUM_DELSEG_SC_OVFL
- DB_NUM_SEGTYPE
- DB_SEG_SC
- DB_SEG_LEVEL
- DB_SEG_DSG
- DB_SEG_NAME
- DB_FLAG_SEG_LEN_TYPE
- DBX_NUM_IPS_DB
- DBX_NUM_IPS_PRIM
- DBX_SEG_NAME

NO

Does not collect the data elements that are related to the segment occurrence count at the database level.

SENSOR_DBINFO=

This keyword specifies whether to scan databases and collect statistics about data organization in the databases. If you omit this keyword, SENSOR_DBINFO=YES is used as the default value.

YES

Scans databases and collects statistics for data elements related to data organization. Also collects space utilization information about the database data sets from the system catalog and VTOC. The collected data elements are stored in the Sensor Data repository of IMS Tools KB.

NO

Does not scan databases nor collect statistics about data organization but collects space utilization information about the database data sets from the system catalog and VTOC, and stores data elements in the Sensor Data repository of IMS Tools KB. When SENSOR_DBINFO=NO is set, neither SENSOR_HOME=YES nor SEGMENT_STAT=YES can be specified.

For information about the data elements to be collected, see the following topics in the *IMS Tools Base Policy Services User's Guide*:

- Data elements related to index
- Data elements related to database data set space
- Data elements related to data set CI/CA splits

SENSOR_HOME=

This keyword specifies whether to collect the data elements that are related to root segment distribution. If you omit this keyword, SENSOR_HOME=YES is used as the default value.

YES

Collects the following data elements and stores them in the Sensor Data repository of IMS Tools KB:

- DB_NUM_ROOT_NOHOME
- DB_PCT_NUM_ROOT_NOHOME

- DB_AVG_LEN_SYNONYM_CHAIN

Restrictions:

- If the key compression option of the Segment Edit/Compression exit routine is specified for the root segment, these data elements are not collected even when SENSOR_HOME=YES is specified.
- If you specified RMNAME=(*rand,rap,0,bytes*) or if you omitted the third operand of the RMNAME parameter in the DBD macro, the number of root addressable area (RAA) blocks is defined as zero in the HDAM or PHDAM DBD. In this case, these data elements are not collected even if SENSOR_HOME=YES is specified.

NO

Does not collect the data elements that are related to root segment distribution.

Considerations for SENSOR_HOME and the policy evaluation process:

The data elements that are additionally collected when SENSOR_HOME=YES are useful factors for determining the need of database reorganization.

DB_NUM_ROOT_NOHOME and DB_PCT_NUM_ROOT_NOHOME show how many root segments are placed in the different block from the blocks in which their RAP (Root Anchor Points) are placed. If the number of DB_PCT_NUM_ROOT_NOHOME is large, extra I/O operations can occur for reading root segments. If the number of DB_PCT_NUM_ROOT_NOHOME is large and if you reorganize the database, the amount of I/O might be decreased because the root segments will be moved into the home blocks.

DB_AVG_LEN_SYNONYM_CHAIN shows how many roots segments are assigned to the same RAP by a randomizer. If the number of DB_AVG_LEN_SYNONYM_CHAIN is large, extra I/O operations can occur for reading root segments. To improve this situation, change the randomizing parameters, such as increasing RAA blocks or the number of RAPs, or changing the randomizer, and then reconstruct the database.

If you specify SENSOR_HOME=NO, Policy Services and Autonomics Director cannot evaluate these factors, and they might not provide adequate information about the state of the database and the actions that you must take. Consider specifying SENSOR_HOME=YES unless you have performance concerns.

When you specify SENSOR_HOME=YES, a randomizer is called to collect data for these data elements. Consequently, when SENSOR_HOME=YES is specified, the CPU time and the elapsed time increase compared to when SENSOR_HOME=NO is specified.

TOSIXCFGRP=

This keyword specifies whether to retrieve the latest VSAM statistics of the online database. If you specify the IMS Tools Online System Interface XCF group name, FF Stand-alone DB Sensor requests IMS Tools Online System Interface to retrieve the latest VSAM statistics of the IMS online database.

This keyword is an optional keyword. If you omit this keyword, TOSIXCFGRP=*NO is used as the default value. Because this keyword is effective for online databases, you can omit this keyword when you process offline databases.

Important: If you want to collect the most recent sensor data for an online database, you must specify the name of the IMS Tools Online System Interface XCF group with this keyword.

IMS_Tools_Online_System_Interface_XCF_group_name

Specify the IMS Tools Online System Interface XCF group name in TOIxxxxx format.

See Chapter 4, “[Considerations for collecting sensor data from full-function databases,](#)” on page 21 for considerations that apply when collecting sensor data from a database that is being updated.

***NO**

Does not retrieve the latest VSAM statistics of IMS online database.

```

// JOB ...
//SENSOR EXEC PGM=BBESENSR
//STEPLIB DD DISP=SHR,DSN=... .
// DD DISP=SHR,DSN=IMS11.SDFSRESL
//
//:
//IMS DD DISP=SHR,DSN=IMS11.DBDLIB
//RECON1 DD DISP=SHR,DSN=SYS01.RECON1
//RECON2 DD DISP=SHR,DSN=SYS01.RECON2
//RECON3 DD DISP=SHR,DSN=SYS01.RECON3
//BBESIN DD *
GLOBAL DBRC=Y,HPIO=Y,
TOSIXCFGRP=TOISYS01,ITKBSRVR=FPQSRV01,
ADXCFGRP=ADSRV01
DATABASE DBD=HIDAM1
/*
/*-----
/* Specify all DDs that belong to the DBD.
/* If the data set names are defined by DFSMDA, the DDs are not needed.
/*-----
//HDAMDD1 DD DISP=SHR,DSN=HIDAMDB.HIDAMDD1.OSAM
//PINDEX1 DD DISP=SHR,DSN=PINDEX.PINDEX1.VSAM
//HDAMDD2 DD DISP=SHR,DSN=HIDAMDB.HIDAMDD2.OSAM

```

Figure 4. FF Stand-alone DB Sensor JCL example: Processing a database

Processing multiple databases

The following JCL example is for processing an HDAM database that has three database data sets and a secondary index that has a primary data set and an overflow data set.

```

// JOB ...
//SENSOR EXEC PGM=BBESENSR
//STEPLIB DD DISP=SHR,DSN=... .
// DD DISP=SHR,DSN=IMS11.SDFSRESL
//
//:
//IMS DD DISP=SHR,DSN=IMS11.DBDLIB
//RECON1 DD DISP=SHR,DSN=SYS01.RECON1
//RECON2 DD DISP=SHR,DSN=SYS01.RECON2
//RECON3 DD DISP=SHR,DSN=SYS01.RECON3
//BBESIN DD *
GLOBAL DBRC=Y,HPIO=Y,
TOSIXCFGRP=TOISYS01,ITKBSRVR=FPQSRV01,
ADXCFGRP=ADSRV01
DATABASE DBD=HDAM1
DATABASE DBD=SINDEX1
/*
/*-----
/* Specify all DDs that belong to the DBD
/* If the data set names are defined by DFSMDA, the DDs are not needed.
/*-----
//HDAM11 DD DISP=SHR,DSN=HDAMDB.HDAM11.OSAM
//HDAM12 DD DISP=SHR,DSN=HDAMDB.HDAM12.OSAM
//HDAM13 DD DISP=SHR,DSN=HDAMDB.HDAM13.OSAM
//SINDEX1P DD DISP=SHR,DSN=SINDEX.PRIMARY.VSAM
//SINDEX1O DD DISP=SHR,DSN=SINDEX.OVERFLW.VSAM

```

Figure 5. FF Stand-alone DB Sensor JCL example: Processing multiple databases

Processing a HALDB partition

The following JCL example is for processing one HALDB partition.

```

// JOB ...
//SENSOR EXEC PGM=BBESENSR
//STEPLIB DD DISP=SHR,DSN=...
// DD DISP=SHR,DSN=IMS11.SDFSRESL
//
//IMS DD DISP=SHR,DSN=IMS11.DBDLIB
//RECON1 DD DISP=SHR,DSN=SYS01.RECON1
//RECON2 DD DISP=SHR,DSN=SYS01.RECON2
//RECON3 DD DISP=SHR,DSN=SYS01.RECON3
//BBESIN DD *
GLOBAL DBRC=Y,HPIO=Y,
TOSIXCFGRP=TOISYS01,ITKBSRVR=FPQSRV01,
ADXCFGRP=ADSRV01
DATABASE DBD=PHIDAM1,PART=PHDM1A
/*
/*-----
/* In case of HALDB, DDs are not needed because DB Sensor processes
/* the data sets that are defined in the RECON.

```

Figure 6. FF Stand-alone DB Sensor JCL example: Processing a HALDB partition

Processing all HALDB partitions

The following JCL example is for processing all PHDAM partitions.

```

// JOB ...
//SENSOR EXEC PGM=BBESENSR
//STEPLIB DD DISP=SHR,DSN=...
// DD DISP=SHR,DSN=IMS11.SDFSRESL
//
//IMS DD DISP=SHR,DSN=IMS11.DBDLIB
//RECON1 DD DISP=SHR,DSN=SYS01.RECON1
//RECON2 DD DISP=SHR,DSN=SYS01.RECON2
//RECON3 DD DISP=SHR,DSN=SYS01.RECON3
//BBESIN DD *
GLOBAL DBRC=Y,HPIO=Y,
TOSIXCFGRP=TOISYS01,ITKBSRVR=FPQSRV01,
ADXCFGRP=ADSRV01
DATABASE DBD=PHDAM1,PART=*ALL
/*
/*-----
/* In case of HALDB, DDs are not needed because DB Sensor processes
/* the data sets that are defined in the RECON.

```

Figure 7. FF Stand-alone DB Sensor JCL example: Processing all HALDB partitions

Chapter 7. Output from FF Stand-alone DB Sensor

FF Stand-alone DB Sensor generates several reports.

Topics:

- “Runtime Summary report from FF Stand-alone DB Sensor” on page 37
- “Sensor Data Statistics report from FF Stand-alone Database Sensor” on page 38

Runtime Summary report from FF Stand-alone DB Sensor

The Runtime Summary report contains summary information about the DB Sensor job.

This report contains the following information:

- IMS and z/OS version and release
- Control statement echo back
- DB Sensor results and, if any, error messages

Sample report

The following figure shows an example of the Runtime Summary report.

```
IMS DATABASE SOLUTION PACK FOR z/OS          "RUNTIME SUMMARY REPORT"          PAGE: 1
5655-DSP                                     DATE: 08/25/2023  TIME: 00.23.12      BBESNSR - V2.R2

"SYSTEM ENVIRONMENT"
  OPERATING SYSTEM : z/OS  V02.04.00
  IMS LEVEL        : VER 15 REL 10

"CONTROL STATEMENTS"
0.....1.....2.....3.....4.....5.....6.....7.....8
1234567890123456789012345678901234567890123456789012345678901234567890

GLOBAL HPIO=YES,DBRC=YES,SEGMENT_STAT=YES
DATABASE DBD=HDAMDB1

"RUNTIME OPTIONS"

KEYWORD          RUNTIME OPTIONS FOR THIS STEP
-----
ADXCFGRP         *NO
DBRC             YES
HPIO             YES
ITKBSVR         FPQbbbb
TOSIXCFGRP      *NO
SENSOR_DBINFO    YES
SENSOR_HOME     YES
SEGMENT_STAT    YES
IMSCATHLQ       *NO
```

Figure 8. Runtime Summary report (FF Stand-alone DB Sensor)

Report field descriptions

This report provides the following information:

SYSTEM ENVIRONMENT

This part shows the following system environment information:

OPERATING SYSTEM

The version of z/OS.

IMS LEVEL

The IMS version and release level of the specified IMS.RESLIB.

CONTROL STATEMENTS

This part shows an echo of the control statements that you specified in the BBESIN data set.

RUNTIME OPTIONS

This part shows the options that were applied in the run.

Sensor Data Statistics report from FF Stand-alone Database Sensor

After DB Sensor stores sensor data, DB Sensor generates a Sensor Data Statistics report. This report is printed in the BBESPRT data set.

This report contains the data element names and their values. For the definitions of these data elements, see the topics about data elements in the *IMS Tools Base Policy Services User's Guide*.

The following figures show an example of the Sensor Data Statistics report when SEGMENT_STAT=YES is specified.

Note: The heading information in the report is different based on the database type.

- For non-HALDBs, the report header displays "SENSOR DATA STATISTICS REPORT".
- For HALDBs,
 - When SEGMENT_STAT=YES is specified, the report header displays "SENSOR DATA STATISTICS REPORT - HALDB" and "SENSOR DATA STATISTICS REPORT - HALDB PARTITION".
 - When SEGMENT_STAT=NO is specified, only "SENSOR DATA STATISTICS REPORT - HALDB PARTITION" header is displayed.

Database Statistics (DBD: PHIMDB1 , DBTYPE: PHIDAM)

=====
Segment Statistics for Database
=====

Segment statistics summary

Data Element Name	Value
DB_FLAG_SEGMENT_STAT	Y
DB_NUM_SEGTYPE	255
DB_NUM_SEG_DB	1,713
DB_NUM_SEG_DSG01_DB	1,713

Segment definition and statistics per segment type

Data Element Name	Value
DB_SEG_SC	1
DB_SEG_LEVEL	1
DB_SEG_DSG	A
DB_SEG_NAME	ROOT
DB_NUM_SEG_SC_DB	17
DB_FLAG_SEG_LEN_TYPE	VC
DB_SEG_SC	2
DB_SEG_LEVEL	2
DB_SEG_DSG	A
DB_SEG_NAME	D001
DB_NUM_SEG_SC_DB	336
DB_FLAG_SEG_LEN_TYPE	V
DB_SEG_SC	3
DB_SEG_LEVEL	2
DB_SEG_DSG	A
DB_SEG_NAME	D002
DB_NUM_SEG_SC_DB	243
DB_FLAG_SEG_LEN_TYPE	V
DB_SEG_SC	4
DB_SEG_LEVEL	3
DB_SEG_DSG	A
DB_SEG_NAME	D003
DB_NUM_SEG_SC_DB	112
DB_FLAG_SEG_LEN_TYPE	V
DB_SEG_SC	5
DB_SEG_LEVEL	2
DB_SEG_DSG	A
DB_SEG_NAME	D004
DB_NUM_SEG_SC_DB	408
DB_FLAG_SEG_LEN_TYPE	V

Database Statistics (DBD: PHIMDB1 , DBTYPE: PHIDAM)

=====
Segment Statistics for Index
=====

Segment statistics summary

Data Element Name	Value
DBX_FLAG_SEGMENT_STAT	Y
DBX_SEG_NAME	n/a
DBX_NUM_IPS_DB	18

Partition Statistics (DBD: PHIMDB1 , Partition: PHIM1A , DBTYPE: PHIDAM , ACTIVE DBDS= A-J)

=====
Database Record Statistics
=====

Data Element Name	Value
DB_FLAG_SENSOR_DBINFO	Y
DB_NUM_ROOT	17
DB_AVG_DBREC_LENGTH	13,216.82

Partition Statistics (DBD: PHIMDB1 , Partition: PHIM1A , DBTYPE: PHIDAM , ACTIVE DBDS= A-J)

=====
Physical I/O Statistics
=====

Data Element Name	Value
DB_ESTIMATED_DBREC_IO	20.18
DB_ESTIMATED_ROOT_IO	n/a

Figure 9. Sensor Data Statistics report when SEGMENT_STAT=YES (FF Stand-alone DB Sensor) (Part 1 of 5)

Partition Statistics (DBD: PHIMDB1 , Partition: PHIM1A , DBTYPE: PHIDAM , ACTIVE DBDS= A-J)

=====
Segment Statistics for Partition
=====

Segment statistics summary

Data Element Name	Value
DB_FLAG_SEGMENT_STAT	Y
DB_NUM_SEGTYPE	255
DB_NUM_SEG_PART	1,713
DB_NUM_SEG_DSG01_PART	1,713

Segment definition and statistics per segment type

Data Element Name	Value
DB_SEG_SC	1
DB_SEG_LEVEL	1
DB_SEG_DSG	A
DB_SEG_NAME	ROOT
DB_NUM_SEG_SC	17
DB_FLAG_SEG_LEN_TYPE	VC
DB_SEG_SC	2
DB_SEG_LEVEL	2
DB_SEG_DSG	A
DB_SEG_NAME	D001
DB_NUM_SEG_SC	336
DB_FLAG_SEG_LEN_TYPE	V
DB_SEG_SC	3
DB_SEG_LEVEL	2
DB_SEG_DSG	A
DB_SEG_NAME	D002
DB_NUM_SEG_SC	243
DB_FLAG_SEG_LEN_TYPE	V
DB_SEG_SC	4
DB_SEG_LEVEL	3
DB_SEG_DSG	A
DB_SEG_NAME	D003
DB_NUM_SEG_SC	112
DB_FLAG_SEG_LEN_TYPE	V
DB_SEG_SC	5
DB_SEG_LEVEL	2
DB_SEG_DSG	A
DB_SEG_NAME	D004
DB_NUM_SEG_SC	408
DB_FLAG_SEG_LEN_TYPE	V

Partition Statistics (DBD: PHIMDB1 , Partition: PHIM1A , DBTYPE: PHIDAM , ACTIVE DBDS= A-J)

=====
Index Space Utilization Statistics
=====

Data Element Name	Value
DBX_NUM_IPS	18
DBX_NUM_IPS_OVFL	n/a
DBX_PCT_IPS_OVFL	n/a

Partition Statistics (DBD: PHIMDB1 , Partition: PHIM1A , DBTYPE: PHIDAM , ACTIVE DBDS= A-J)

=====
Segment Statistics for Index
=====

Segment statistics summary

Data Element Name	Value
DBX_FLAG_SEGMENT_STAT	Y
DBX_SEG_NAME	n/a
DBX_NUM_IPS	18
DBX_NUM_IPS_PRIM	n/a
DBX_NUM_IPS_OVFL	n/a

Figure 10. Sensor Data Statistics report when SEGMENT_STAT=YES (FF Stand-alone DB Sensor) (Part 2 of 5)

Data Set Statistics (DBD: PHIMDB1 , Partition: PHIM1A , DBTYPE: PHIDAM , Primary Index Data Set)

=====
Volume/Extent Statistics
=====

Data set definition and environment information

Data Element Name	Value
DBX_FLAG_SPACE_TYPE	T
DBX_NUM_PRI_SPACE	1
DBX_NUM_SEC_SPACE	1
DBX_FLAG_SMS	Y
DBX_MAX_EXT_DS	251
DBX_MAX_EXT_VOL	123

Data set usage information

Data Element Name	Value
DBX_NUM_EXT	1
DBX_NUM_VOL	1
DBX_NUM_UNUSED_VOL	0
DBX_NUM_UNUSED_VOL_SER	0
DBX_NUM_UNUSED_VOL_CAND	0

Remaining available data set extent estimation

Data Element Name	Value
DBX_AVAIL_EXT_LESS_100	N
DBX_NUM_AVAIL_EXT	n/a
DBX_AVAIL_EXT_LIMIT	n/a

Remark: If DBX_NUM_UNUSED_VOL_CAND is not zero, more extents than those indicated by DBX_NUM_AVAIL_EXT might be available.

Data Set Statistics (DBD: PHIMDB1 , Partition: PHIM1A , DBTYPE: PHIDAM , Primary Index Data Set)

=====
Data Set Space Usage Statistics
=====

Data Element Name	Value
DBX_BLOCK_SIZE	512
DBX_NUM_DBDS_BLOCKS	49
DBX_MAX_DS_SIZE	4G
DBX_PCT_OF_MAX_DS_SIZE	0%
DBX_RBA_HIGH_ALLOC	25,088
DBX_RBA_HIGH_USED	25,088
DBX_UNUSED_BYTES	24,576
DBX_PCT_UNUSED_BYTES	98%

Data Set Statistics (DBD: PHIMDB1 , Partition: PHIM1A , DBTYPE: PHIDAM , Primary Index Data Set)

=====
Index Statistics
=====

Data Element Name	Value
DBX_NUM_CI_SPLIT	0
DBX_PCT_NUM_CI_SPLIT	0%
DBX_NUM_CA_SPLIT	0
DBX_PCT_NUM_CA_SPLIT	0%
DBX_LRECL_SIZE	16

Data Set Statistics (DBD: PHIMDB1 , Partition: PHIM1A , DBTYPE: PHIDAM , Primary Index Data Set)

=====
Segment Statistics for Index
=====

Segment statistics summary

Data Element Name	Value
DBX_FLAG_SEGMENT_STAT	Y
DBX_SEG_NAME	n/a
DBX_NUM_IPS	18
DBX_NUM_IPS_PRIM	n/a
DBX_NUM_IPS_OVFL	n/a

Figure 11. Sensor Data Statistics report when SEGMENT_STAT=YES (FF Stand-alone DB Sensor) (Part 3 of 5)

Data Set Statistics (DBD: PHIMDB1 , Partition: PHIM1A , DBTYPE: PHIDAM , DSG: A)

=====
Volume/Extent Statistics
=====

Data set definition and environment information
=====

Data Element Name	Value
DB_FLAG_SPACE_TYPE	C
DB_NUM_PRI_SPACE	2
DB_NUM_SEC_SPACE	1
DB_FLAG_SMS	Y
DB_MAX_EXT_DS	251
DB_MAX_EXT_VOL	123

Data set usage information
=====

Data Element Name	Value
DB_NUM_EXT	1
DB_NUM_VOL	1
DB_NUM_UNUSED_VOL	0
DB_NUM_UNUSED_VOL_SER	0
DB_NUM_UNUSED_VOL_CAND	0

Remaining available data set extent estimation
=====

Data Element Name	Value
DB_AVAIL_EXT_LESS_100	N
DB_NUM_AVAIL_EXT	n/a
DB_AVAIL_EXT_LIMIT	n/a

Remark: If DB_NUM_UNUSED_VOL_CAND is not zero, more extents than those indicated by DB_NUM_AVAIL_EXT might be available.

Data Set Statistics (DBD: PHIMDB1 , Partition: PHIM1A , DBTYPE: PHIDAM , DSG: A)

=====
Data Set Space Usage Statistics
=====

Data Element Name	Value
DB_BLOCK_SIZE	1,024
DB_NUM_DBDS_BLOCKS	261
DB_MAX_DS_SIZE	4G
DB_PCT_OF_MAX_DS_SIZE	0%
DB_RBA_HIGH_ALLOC	1,013,760
DB_RBA_HIGH_USED	267,264
DB_UNUSED_BYTES	746,496
DB_PCT_UNUSED_BYTES	74%

Figure 12. Sensor Data Statistics report when SEGMENT_STAT=YES (FF Stand-alone DB Sensor) (Part 4 of 5)

Data Set Statistics (DBD: PHIMDB1 , Partition: PHIM1A , DBTYPE: PHIDAM , DSG: A)

=====
IMS Space Utilization Statistics
=====

Data Element Name	Value
DB_BYTES_SEG	224,686
DB_BYTES_FREE_SPACE	37,208
DB_BYTES_UNIDENTIFIED	42
DB_PCT_BYTES_FREE_SPACE	14%
DB_PCT_BYTES_SEG	84%
DB_NUM_SEG	1,713
DB_NUM_VLSEG	1,713
DB_NUM_VLSEG_SPLIT	0
DB_PCT_NUM_VLSEG_SPLIT	0%
DB_NUM_UNIDENTIFIED	10
DB_AVG_NUM_UNIDENTIFIED	.04
DB_NUM_FSE	246
DB_AVG_NUM_FSE	.94
DB_NUM_FSE_MIN	176
DB_NUM_FSE_MAX	0
DB_AVG_NUM_NOREUSE_FSE	.27
DB_PCT_NUM_NOREUSE_FSE	28%
DB_AVG_NUM_FRAGD_FSE	.94
DB_PCT_NUM_FRAGD_FSE	100%
DB_NUM_PTR	4,672
DB_NUM_PTR_DIFF_BLK	1,976
DB_PCT_NUM_PTR_DIFF_BLK	42%

Data Set Statistics (DBD: PHIMDB1 , Partition: PHIM1A , DBTYPE: PHIDAM , DSG: A)

=====
Segment Statistics for Data Set
=====

Segment statistics summary

Data Element Name	Value
DB_FLAG_SEGMENT_STAT	Y
DB_NUM_SEG	1,713

Segment definition and statistics per segment type

Data Element Name	Value
DB_SEG_SC	1
DB_SEG_LEVEL	1
DB_SEG_DSG	A
DB_SEG_NAME	ROOT
DB_NUM_SEG_SC	17
DB_FLAG_SEG_LEN_TYPE	VC
DB_SEG_SC	2
DB_SEG_LEVEL	2
DB_SEG_DSG	A
DB_SEG_NAME	D001
DB_NUM_SEG_SC	336
DB_FLAG_SEG_LEN_TYPE	V
DB_SEG_SC	3
DB_SEG_LEVEL	2
DB_SEG_DSG	A
DB_SEG_NAME	D002
DB_NUM_SEG_SC	243
DB_FLAG_SEG_LEN_TYPE	V
DB_SEG_SC	4
DB_SEG_LEVEL	3
DB_SEG_DSG	A
DB_SEG_NAME	D003
DB_NUM_SEG_SC	112
DB_FLAG_SEG_LEN_TYPE	V
DB_SEG_SC	5
DB_SEG_LEVEL	2
DB_SEG_DSG	A
DB_SEG_NAME	D004
DB_NUM_SEG_SC	408
DB_FLAG_SEG_LEN_TYPE	V

Figure 13. Sensor Data Statistics report when SEGMENT_STAT=YES (FF Stand-alone DB Sensor) (Part 5 of 5)

Chapter 8. Setting site default values for FF Stand-alone DB Sensor

Use the FF Stand-alone DB Sensor Site Default Generation utility (FF Site Default Generation utility) to set your own default values for the Stand-alone DB Sensor runtime options.

You can use the FF Site Default Generation utility to create a *site default table* (BBESCTLO). A site default table contains the BBESIN control statement keywords and parameters that will be applied at run time. You can also use this utility to print the keywords and their parameters that are defined in the site default table to a report.

Topics:

- [“Creating a site default table for FF Stand-alone DB Sensor” on page 45](#)
- [“EXEC and DD statements for the FF Site Default Generation utility” on page 47](#)
- [“Keywords for the FF Site Default Generation utility” on page 48](#)
- [“Output from the FF Site Default Generation utility” on page 49](#)

Creating a site default table for FF Stand-alone DB Sensor

To generate a site default table, code the FF Site Default Generation utility JCL, run the job, and assemble and link-edit the source code.

About this task

The following figure shows the steps for creating the site default table. The numbers in the figure match the numbers in the procedure steps.

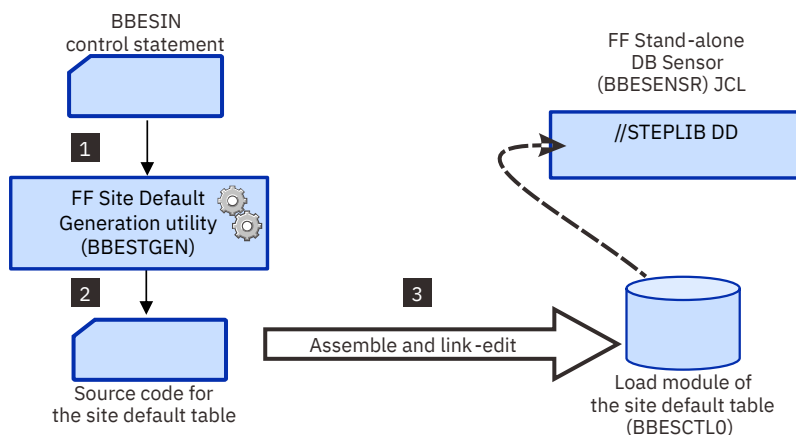

Figure 14. Steps for creating a site default table (FF Stand-alone DB Sensor)

Procedure

1. Write the EXEC and the DD statements.

For the format of the EXEC statement and the list of DD statements, see [“EXEC and DD statements for the FF Site Default Generation utility” on page 47](#).

2. Run the FF Site Default Generation utility (BBESTGEN) job step to create the source code for BBESCTLO.

Ensure that the return code is 0. Also check the Site Default report to ensure that the options that you specified are set in the BBESCTLO.

See the following topics for more information:

- For a description of the keywords and parameters that you can specify, see [“Keywords for the FF Site Default Generation utility” on page 48.](#)
- For a sample of the Site Default report, see [“Output from the FF Site Default Generation utility” on page 49.](#)

3. Assemble and link-edit the BBESCTLO source code.

To create the site default table, assemble and link the SYSPUNCH data set that is generated by BBESTGEN.

Example

The following example shows how to specify the FF Site Default Generation utility JCL to create source code for BBESCTLO.

```
//BBESDFL1 JOB ....
//*
//DBSTGEN PROC HLQ='HPS'
//*-----
//* CREATE SOURCE CODE OF SITE DEFAULT TABLE
//*-----
//G EXEC PGM=BBESTGEN,PARM='GEN'
//STEPLIB DD DISP=SHR,DSN=&HLQ..SHPSLMD0 DB Solution Pack load module library
//SYSPUNCH DD DISP=(NEW,PASS,DELETE),DSN=&&SOURCE,
// DCB=(RECFM=FB,BLKSIZE=800),SPACE=(TRK,(1,1)),UNIT=SYSDA
//SYSPRINT DD SYSOUT=*
//SYSUDUMP DD DUMMY
//*-----
//* ASSEMBLE & LINK ==> SITE DEFAULT TABLE MODULE (BBESCTLO)
//*-----
//ASM EXEC PGM=ASMA90,COND=(4,LT,G),
// PARM='OBJECT,NODECK,LIST,XREF(SHORT)'
//SYSLIN DD DISP=(,PASS),UNIT=SYSDA,SPACE=(CYL,(5,5,0)),
// DCB=(BLKSIZE=400),DSN=&&OBJECT
//SYSUT1 DD DISP=(,DELETE),UNIT=SYSDA,SPACE=(CYL,(10,5))
//SYSPUNCH DD DUMMY
//SYSPRINT DD SYSOUT=*
//SYSIN DD DISP=(OLD,DELETE,DELETE),DSN=&&SOURCE
//*
//L EXEC PGM=IEWL,COND=(4,LT,ASM),REGION=4096K,
// PARM='LIST,REFR,REUS,AMODE=31,RMODE=ANY'
//SYSPRINT DD SYSOUT=*
//SYSLIN DD DISP=(OLD,DELETE,DELETE),DSN=&OBJECT
//*
// PEND
//*
//*-----*
//* BBESTGEN (PARM='GEN') - DB SENSOR SITE DEFAULT GENERATION UTILITY*
//*-----*
//GO EXEC DBSTGEN,HLQ=HPS
//*-----*
//* SPECIFY SITE DEFAULT VALUES *
//*-----*
//G.BBESIN DD *
GLOBAL DBRC=YES,
ITKBSRVR=ITKB001
//*
//L.SYSLMOD DD DISP=SHR,DSN=HPS.TABLELIB(BBESCTLO)
```

Figure 15. JCL for creating the site default table (FF Site Default Generation utility)

What to do next

When you code the DB Sensor JCL to run a Database Sensor job, you must concatenate the load module library in which BBESCTLO resides to the STEPLIB DD of the DB Sensor JCL.

You can always check the options that are set in the site default table by running the FF Site Default Generation utility with the PARM='REPORT' option. When you specify this option, the utility prints the keywords and their parameters that are set in the site default table in the Site Default report.

The following example shows how to print the keywords and the parameters that are defined in BBESCTLO.

```
//BBESDFL2 JOB ....
//*
//*-----
//* PRINT SITE DEFAULT TABLE
//*-----
//REPORT EXEC PGM=BBESTGEN, PARM='REPORT'
//STEPLIB DD DISP=SHR, DSN=HPS.TABLELIB
//STEPLIB DD DISP=SHR, DSN=HPS.SHPSLMD0 DB Solution Pack load module library
//SYSPRINT DD SYSOUT=*
//SYSUDUMP DD DUMMY
```

Figure 16. JCL for printing the contents of the site default table (FF Site Default Generation utility)

EXEC and DD statements for the FF Site Default Generation utility

You must include the EXEC statement and appropriate DD statements in your FF Site Default Generation utility JCL.

Subsections:

- [“EXEC statement” on page 47](#)
- [“DD statement summary” on page 47](#)
- [“DD statements for input” on page 48](#)
- [“DD statements for output” on page 48](#)

EXEC statement

The EXEC statement must be in the following format:

```
//STEP EXEC PGM=BBESTGEN, PARM='parameter'
```

where:

PGM

Specifies the FF Site Default Generation program, which is BBESTGEN.

PARM

Specifies the function to run. Specify either of the following values:

GEN

Generates a site default table.

REPORT

Reports the contents of the site default table.

DD statement summary

The following table summarizes the DD statements for the FF Site Default Generation utility.

DD name	Use	Format	When EXEC PARM='GEN'	When EXEC PARM='REPORT'
STEPLIB	Input	RECFM=U	Required	Required
BBESIN	Input	RECFM=FB LRECL=80	Required	Not applicable

Table 3. BBESTGEN DD statements (continued)

DD name	Use	Format	When EXEC PARM='GEN'	When EXEC PARM='REPORT'
SYSPRINT	Output	RECFM=FBA LRECL=133	Required	Required
SYSPUNCH	Output	RECFM=FB LRECL=80	Required	Not applicable
SYSABEND or SYSUDUMP	Output	RECFM=FBA LRECL=133	Optional	Optional

DD statements for input

Specify the following input DD statements:

STEPLIB DD

This required DD statement specifies the load module library of DB Sensor. You do not need to APF-authorize this library.

When you specify PARM='REPORT' on the EXEC statement, you must also specify the library that contains the site default table module (BBESCTLO).

BBESIN DD

This DD statement is required when you specify PARM='GEN' on the EXEC statement. This DD statement specifies the BBESIN data set that contains the BBESIN control statement.

DD statements for output

Specify the following output DD statements:

SYSPRINT DD

This required DD statement specifies the output data set for the FF Site Default Generation utility reports.

SYSPUNCH DD

This DD statement is required when you specify PARM='GEN' on the EXEC statement. This DD statement specifies the output data set in which the source code for the site default table is generated.

SYSABEND DD or SYSUDUMP DD

This optional DD statement specifies the output data set to generate a dump.

Keywords for the FF Site Default Generation utility

When you create a site default table, you must specify the command, keywords, and parameters in the BBESIN data set and provide the data set to the FF Site Default Generation utility.

The format of the BBESIN data set is the same as the format that you specify for FF Stand-alone DB Sensor JCL. You can use the BBESIN data set that you use for an FF Stand-alone DB Sensor job.

In the site default table, you can set the keywords and their parameters only for the GLOBAL command. If you specify the keywords for the DATABASE command, the FF Site Default Generation utility ignores the DATABASE command keywords.

You can set the following keywords and parameters in the BBESIN data set:

Table 4. Keywords for the FF Site Default Generation utility

Keyword	DB Sensor default value
ADXCFCGRP	*NO
DBRC	NO
HPIO	YES
IMSCATHLQ	*NO
ITKBSRVR	*NO
SEGMENT_STAT	NO
SENSOR_DBINFO	YES
SENSOR_HOME	YES
TOSIXCFCGRP	*NO

Requirement: To create a site default table, you must specify at least one keyword and parameter pair for the GLOBAL command.

Output from the FF Site Default Generation utility

Each FF Site Default Generation utility job generates a Site Default report.

The following figure shows an example of the Site Default report.

```

IMS DATABASE SOLUTION PACK FOR z/OS                "SITE DEFAULT REPORT"
5655-DSP                                           DATE: 08/25/2023  TIME: 22.58.03
                                                    PAGE:      1
                                                    BBESTGEN - V2.R2

"CONTROL STATEMENTS"

0.....1.....2.....3.....4.....5.....6.....7.....8
1234567890123456789012345678901234567890123456789012345678901234567890

  GLOBAL DBRC=YES,
         ITKBSRVR=ITKB001
BBE1321I SOURCE CODE FOR THE SITE DEFAULT TABLE (BBESCTLO) WAS GENERATED

"RUNTIME OPTIONS"

KEYWORD      SITE DEFAULT VALUE
-----
ADXCFCGRP    *NO
DBRC         YES
HPIO        YES
ITKBSRVR     ITKB001
TOSIXCFCGRP  *NO
SENSOR_DBINFO  YES
SENSOR_HOME  YES
SEGMENT_STAT NO
IMSCATHLQ    *NO

The above values are used as defaults when DB Sensor runs in stand-alone mode.

```

Figure 17. Site Default report (FF Site Default Generation utility)

Chapter 9. Printing sensor data by using the FF DB Sensor Printing utility

Use the FF DB Sensor Printing utility (BBESPRNT) to print the sensor data that is stored in the IMS Tools KB Sensor Data repository.

The FF DB Sensor Printing utility reads sensor data for the specified database, partition, or area from the IMS Tools KB Sensor Data repository and prints a Sensor Data Statistics report in the BBESPRNT data set.

The BBESPRNT program is distributed in IMS Database Solution Pack and IMS Database Utility Solution. It can process sensor data that is collected from full-function databases. If you specify the product load module library of IMS Fast Path Solution Pack, the BBESPRNT program also processes sensor data that is collected from DEDBs. If you have both IMS Database Solution Pack and IMS Fast Path Solution Pack or IMS Database Utility Solution and IMS Fast Path Solution Pack, you can retrieve sensor data from full-function databases and DEDBs by using BBESPRNT JCL.

Topics:

- [“Printing a Sensor Data Statistics report ” on page 51](#)
- [“FF DB Sensor Printing utility JCL and control statements” on page 52](#)
- [“Output from the FF DB Sensor Printing utility” on page 54](#)

Printing a Sensor Data Statistics report

To print a Sensor Data Statistics report, code the FF DB Sensor Printing utility JCL and run the job.

Procedure

1. Write the EXEC and the DD statements.

For the format of the EXEC statement and the list of DD statements, see [“EXEC and DD statements for the FF DB Sensor Printing utility” on page 52](#).

2. Specify the GLOBAL command, the DATABASE command, and their keywords in the BBESPRIN DD.

See the following topics for more information:

- For information about the keyword that can be specified for the GLOBAL command, see [“GLOBAL command keywords for the FF DB Sensor Printing utility” on page 54](#).
- For information about the keywords that can be specified for the DATABASE command, see [“DATABASE command keywords for the FF DB Sensor Printing utility” on page 54](#).

3. Run the FF DB Sensor Printing utility (BBESPRNT) job step to print the report.

Ensure that the return code is 0.

For a sample of the Sensor Data Statistics report, see [“Sensor Data Statistics report from the FF DB Sensor Printing utility” on page 55](#).

Example

The following example shows how to specify the FF DB Sensor Printing utility JCL.

```

//BBESPRNT JOB CLASS=A
//PGM1 EXEC PGM=BBESPRNT
//STEPLIB DD DISP=SHR,DSN=db_solution_pack_load_module_library
// DD DISP=SHR,DSN=IMS_Tools_Base_load_module_library
//RECON1 DD DISP=SHR,DSN=recon1_data_set_name
//BBESPRNT DD SYSOUT=*
//BBESOUT DD SYSOUT=*
//BBESPRIN DD *
GLOBAL ITKBSRVR=FPQSVRDM
DATABASE DBD=DEVICEDB
/*

```

Figure 18. FF DB Sensor Printing utility JCL

FF DB Sensor Printing utility JCL and control statements

Input for the FF DB Sensor Printing utility consists of JCL statements that satisfy the JCL requirements and that conform to the required control statement format.

EXEC and DD statements for the FF DB Sensor Printing utility

You must include the EXEC statement and appropriate DD statements in your FF DB Sensor Printing utility JCL.

Subsections:

- [“EXEC statement” on page 52](#)
- [“DD statement summary” on page 52](#)
- [“DD statements for input” on page 52](#)
- [“DD statements for output” on page 53](#)

EXEC statement

The EXEC statement must be in the following format:

```
//STEP EXEC PGM=BBESPRNT
```

where PGM specifies the FF DB Sensor Printing program, which is BBESPRNT.

DD statement summary

The following table summarizes the DD statements for the FF DB Sensor Printing utility.

Table 5. BBESPRNT DD statements

DD name	Use	Required or optional	Format
STEPLIB	Input	Required	RECFM=U
RECON1	Input	Optional	
BBESPRIN	Input	Required	RECFM=FB,LRECL=80
BBESOUT	Output	Required	RECFM=FBA,LRECL=133
BBESPRT	Output	Required	RECFM=FBA,LRECL=133

DD statements for input

Specify the following input DD statements:

STEPLIB DD

This required DD statement specifies the load module library of DB Sensor. You do not need to APF-authorize this library.

RECON1 DD

Specify the RECON1 data set name that was used when sensor data was stored. If you do not specify the correct name, the utility cannot find the sensor data.

BBESPRIN DD

This DD statement is required. This DD statement specifies the BBESPRIN data set that contains the BBESPRIN control statement.

DD statements for output

Specify the following output DD statements:

BBESOUT DD

This required DD statement specifies the output data set for the FF DB Sensor Printing utility reports and messages. If you omit BBESOUT DD, this DD is allocated dynamically with SYSOUT=* and the reports and messages are printed in the SYSOUT data set.

BBESPRT DD

This required DD statement specifies the output data set for the FF DB Sensor Printing utility reports. If you omit BBESPRT DD, this DD is allocated dynamically with SYSOUT=* and the reports are printed in the SYSOUT data set.

Format of the BBESPRIN control statement

The BBESPRIN control statement defines the user description of the GLOBAL command and the DATABASE command, both of which control the behavior of the FF DB Sensor Printing utility process.

You must specify the commands and their keywords in the BBESPRIN data set. This data set usually resides in the input stream. However, it can also be defined as a sequential data set or as a member of a partitioned data set. It must contain 80-byte, fixed-length records. BLKSIZE, if coded, must be a multiple of 80.

A BBESPRIN control statement must conform to the following format:

GLOBAL command

- Only one GLOBAL command can be specified.
- The GLOBAL command keywords and their parameters follow the GLOBAL command.
- A GLOBAL command keyword and its parameter must be connected with an equal sign (=).
- A line that starts with an asterisk (*) is treated as a comment line.
- The first column must be blank.

DATABASE command

- Only one DATABASE command can be specified.
- The DATABASE command keywords and their parameters follow the DATABASE command.
- A DATABASE command keyword and its parameter must be connected with an equal sign (=).
- Each DATABASE command keyword and value pair must be separated by a comma.
- Multiple keyword and parameter pairs can be specified.

Keyword and parameter pairs can span more than one line; type a comma as a continuation character at the end of the first line, and continue the next keyword and parameter pair on the next line.

- A line that starts with an asterisk (*) is treated as a comment line.
- The first column must be blank.

GLOBAL command keywords for the FF DB Sensor Printing utility

The GLOBAL command keywords control the behavior of the job. You must specify the GLOBAL command and its keywords in the BBESPRIN DD.

ITKBSRVR=

This keyword specifies the IMS Tools KB XCF group name (IMS Tools KB server name). The sensor data is retrieved from the IMS Tools Knowledge Base repositories that are managed by this IMS Tools KB server.

SEGSTAT_REPORT=

This keyword specifies whether to include, in the report, the latest sensor data related to segment occurrence count at the database level, which is collected and stored when SEGMENT_STAT=YES is specified for a FF Stand-alone DB Sensor job. This keyword is an optional keyword. If you omit this keyword, SEGSTAT_REPORT=NO is used as the default value.

YES

Reads the latest sensor data that was collected during a FF Stand-alone DB Sensor job with the SEGMENT_STAT=YES option, and prints a Sensor Data Statistics report that includes segment occurrence count (at the database level).

NO

Reads the latest sensor data and prints a Sensor Data Statistics report. Segment occurrence count (at the database level) is not printed even if sensor data was collected with SEGMENT_STAT=YES.

DATABASE command keywords for the FF DB Sensor Printing utility

The DATABASE command keywords specify the database to process. You must specify the DATABASE command and its keywords in the BBESPRIN DD.

The FF DB Sensor Printing utility generates a report about the latest sensor data that is collected from the target resource (database, partition, or area) that is specified by the DATABASE command.

DBD=

This required keyword specifies the DBD name that you want to retrieve sensor data from. You can specify only one DBD name.

PART=

This keyword specifies the HALDB partition name. This keyword must be specified if the database to be processed is a HALDB and if SEGSTAT_REPORT=NO is applied. When SEGSTAT_REPORT=YES is specified, do not specify this keyword.

IAREA=

This keyword specifies the DEDB area name. Specify this keyword only if the database to be processed is a DEDB. You can specify only one area name.

Output from the FF DB Sensor Printing utility

An FF DB Sensor Printing utility job generates a Runtime Summary report and a Sensor Data Statistics report.

Runtime Summary report from the FF DB Sensor Printing utility

The Runtime Summary report contains summary information about the FF DB Sensor Printing utility job. This report is printed in the BBESOUT data set.

Sample report

The following figure shows an example of the Runtime Summary report.

```
"CONTROL STATEMENTS"
0.....1.....2.....3.....4.....5.....6.....7.....8
1234567890123456789012345678901234567890123456789012345678901234567890

GLOBAL ITKBSRVR=FPQSVRDM
DATABASE DBD=DEVICEDB

"RUNTIME OPTIONS"

KEYWORD          RUNTIME OPTIONS FOR THIS STEP
-----
ITKBSRVR         FPQSVRDM
SEGSTAT_REPORT  NO
DBD              DEVICEDB
PART
IAREA

"MESSAGES"
BBE1381I SENSOR DATA READING STARTED FOR DATABASE DEVICEDB
BBE1385I SENSOR DATA LOCALE=RECON ID:$IVP      , RECON DATA SET NAME=TEMPDS.IVP.RECON1
BBE1382I SENSOR DATA READING ENDED FOR DATABASE DEVICEDB, RSI=00C7F425AB17545940000000012B0000
BBE1383I SENSOR DATA STATISTICS REPORT GENERATION STARTED FOR DATABASE DEVICEDB
BBE1384I SENSOR DATA STATISTICS REPORT GENERATION ENDED FOR DATABASE DEVICEDB
```

Figure 19. Runtime Summary report (FF DB Sensor Printing utility)

Report field descriptions

This report provides the following information:

CONTROL STATEMENTS

This part shows an echo of the control statements that you specified in the BBESPRIN data sets. If any errors were found while FF DB Sensor Printing utility reads the control statements, error messages are also displayed in this part.

RUNTIME OPTIONS

This part shows what options were applied in the run.

MESSAGES

This part shows the processing messages.

Sensor Data Statistics report from the FF DB Sensor Printing utility

The Sensor Data Statistics report contains the value of sensor data. This report is printed in the BBESPRT data set.

This report contains the data element names and their values. For the definitions of these data elements, see the topics about data elements in *IMS Tools Base Policy Services User's Guide*.

The following figures show an example of the Sensor Data Statistics report when SEGSTAT_REPORT=YES is specified.

Database Statistics (DBD: PHIMDB1 , DBTYPE: PHIDAM, Collected on 08/05/2023 03.03.54)

=====
Segment Statistics for Database
=====

Segment statistics summary

Data Element Name	Value
DB_FLAG_SEGMENT_STAT	Y
DB_NUM_SEGTYPE	255
DB_NUM_SEG_DB	1,713
DB_NUM_SEG_DSG01_DB	1,713

Segment definition and statistics per segment type

Data Element Name	Value
DB_SEG_SC	1
DB_SEG_LEVEL	1
DB_SEG_DSG	A
DB_SEG_NAME	ROOT
DB_NUM_SEG_SC_DB	17
DB_FLAG_SEG_LEN_TYPE	VC
DB_SEG_SC	2
DB_SEG_LEVEL	2
DB_SEG_DSG	A
DB_SEG_NAME	D001
DB_NUM_SEG_SC_DB	336
DB_FLAG_SEG_LEN_TYPE	V
DB_SEG_SC	3
DB_SEG_LEVEL	2
DB_SEG_DSG	A
DB_SEG_DSG	A
DB_SEG_NAME	D002
DB_NUM_SEG_SC_DB	243
DB_FLAG_SEG_LEN_TYPE	V
DB_SEG_SC	4
DB_SEG_LEVEL	3
DB_SEG_DSG	A
DB_SEG_NAME	D003
DB_NUM_SEG_SC_DB	112
DB_FLAG_SEG_LEN_TYPE	V
DB_SEG_SC	5
DB_SEG_LEVEL	2
DB_SEG_DSG	A
DB_SEG_NAME	D004
DB_NUM_SEG_SC_DB	408
DB_FLAG_SEG_LEN_TYPE	V

Database Statistics (DBD: PHIMDB1 , DBTYPE: PHIDAM, Collected on 08/05/2023 03.03.54)

=====
Segment Statistics for Index
=====

Segment statistics summary

Data Element Name	Value
DBX_FLAG_SEGMENT_STAT	Y
DBX_SEG_NAME	n/a
DBX_NUM_IPS_DB	18

Partition Statistics (DBD: PHIMDB1 , Partition: PHIM1A , DBTYPE: PHIDAM, Collected on 08/05/2023 03.03.54)

=====
Database Record Statistics
=====

Data Element Name	Value
DB_FLAG_SENSOR_DBINFO	Y
DB_NUM_ROOT	17
DB_AVG_DBREC_LENGTH	13,216.82

Partition Statistics (DBD: PHIMDB1 , Partition: PHIM1A , DBTYPE: PHIDAM, Collected on 08/05/2023 03.03.54)

=====
Physical I/O Statistics
=====

Data Element Name	Value
DB_ESTIMATED_DBREC_IO	20.18
DB_ESTIMATED_ROOT_IO	n/a

Figure 20. Sensor Data Statistics report when SEGSTAT_REPORT=YES (FF DB Sensor Printing utility) (Part 1 of 5)

Partition Statistics (DBD: PHIMDB1 , Partition: PHIM1A , DBTYPE: PHIDAM, Collected on 08/05/2023 03.03.54)

=====
Segment Statistics for Partition
=====

Segment statistics summary

Data Element Name	Value
DB_FLAG_SEGMENT_STAT	Y
DB_NUM_SEGTYPE	255
DB_NUM_SEG_PART	1,713
DB_NUM_SEG_DSG01_PART	1,713

Segment definition and statistics per segment type

Data Element Name	Value
DB_SEG_SC	1
DB_SEG_LEVEL	1
DB_SEG_DSG	A
DB_SEG_NAME	ROOT
DB_NUM_SEG_SC	17
DB_FLAG_SEG_LEN_TYPE	VC
DB_SEG_SC	2
DB_SEG_LEVEL	2
DB_SEG_DSG	A
DB_SEG_NAME	D001
DB_NUM_SEG_SC	336
DB_FLAG_SEG_LEN_TYPE	V
DB_SEG_SC	3
DB_SEG_LEVEL	2
DB_SEG_DSG	A
DB_SEG_NAME	D002
DB_NUM_SEG_SC	243
DB_FLAG_SEG_LEN_TYPE	V
DB_SEG_SC	4
DB_SEG_LEVEL	3
DB_SEG_DSG	A
DB_SEG_NAME	D003
DB_NUM_SEG_SC	112
DB_FLAG_SEG_LEN_TYPE	V
DB_SEG_SC	5
DB_SEG_LEVEL	2
DB_SEG_DSG	A
DB_SEG_NAME	D004
DB_NUM_SEG_SC	408
DB_FLAG_SEG_LEN_TYPE	V

Partition Statistics (DBD: PHIMDB1 , Partition: PHIM1A , DBTYPE: PHIDAM, Collected on 08/05/2023 03.03.54)

=====
Index Space Utilization Statistics
=====

Data Element Name	Value
DBX_NUM_IPS	18
DBX_NUM_IPS_OVFL	n/a
DBX_PCT_IPS_OVFL	n/a

Partition Statistics (DBD: PHIMDB1 , Partition: PHIM1A , DBTYPE: PHIDAM, Collected on 08/05/2023 03.03.54)

=====
Segment Statistics for Index
=====

Segment statistics summary

Data Element Name	Value
DBX_FLAG_SEGMENT_STAT	Y
DBX_SEG_NAME	n/a
DBX_NUM_IPS	18
DBX_NUM_IPS_PRIM	n/a
DBX_NUM_IPS_OVFL	n/a

Figure 21. Sensor Data Statistics report when SEGSTAT_REPORT=YES (FF DB Sensor Printing utility) (Part 2 of 5)

Data Set Statistics (DBD: PHIMDB1 , Partition: PHIM1A , DBTYPE: PHIDAM, Primary Index Data Set, Collected on 08/05/2023 03.03.54)

=====
Volume/Extent Statistics
=====

Data set definition and environment information

Data Element Name	Value
DBX_FLAG_SPACE_TYPE	T
DBX_NUM_PRI_SPACE	1
DBX_NUM_SEC_SPACE	1
DBX_FLAG_SMS	Y
DBX_MAX_EXT_DS	251
DBX_MAX_EXT_VOL	123

Data set usage information

Data Element Name	Value
DBX_NUM_EXT	1
DBX_NUM_VOL	1
DBX_NUM_UNUSED_VOL	0
DBX_NUM_UNUSED_VOL_SER	0
DBX_NUM_UNUSED_VOL_CAND	0

Remaining available data set extent estimation

Data Element Name	Value
DBX_AVAIL_EXT_LESS_100	N
DBX_NUM_AVAIL_EXT	n/a
DBX_AVAIL_EXT_LIMIT	n/a

Remark: If DBX_NUM_UNUSED_VOL_CAND is not zero, more extents than those indicated by DBX_NUM_AVAIL_EXT might be available.

Data Set Statistics (DBD: PHIMDB1 , Partition: PHIM1A , DBTYPE: PHIDAM, Primary Index Data Set, Collected on 08/05/2023 03.03.54)

=====
Data Set Space Usage Statistics
=====

Data Element Name	Value
DBX_BLOCK_SIZE	512
DBX_NUM_DBDS_BLOCKS	49
DBX_MAX_DS_SIZE	4G
DBX_PCT_OF_MAX_DS_SIZE	0%
DBX_RBA_HIGH_ALLOC	25,088
DBX_RBA_HIGH_USED	25,088
DBX_UNUSED_BYTES	24,576
DBX_PCT_UNUSED_BYTES	98%

Data Set Statistics (DBD: PHIMDB1 , Partition: PHIM1A , DBTYPE: PHIDAM, Primary Index Data Set, Collected on 08/05/2023 03.03.54)

=====
Index Statistics
=====

Data Element Name	Value
DBX_NUM_CI_SPLIT	0
DBX_PCT_NUM_CI_SPLIT	0%
DBX_NUM_CA_SPLIT	0
DBX_PCT_NUM_CA_SPLIT	0%
DBX_LRECL_SIZE	16

Data Set Statistics (DBD: PHIMDB1 , Partition: PHIM1A , DBTYPE: PHIDAM, Primary Index Data Set, Collected on 08/05/2023 03.03.54)

=====
Segment Statistics for Index
=====

Segment statistics summary

Data Element Name	Value
DBX_FLAG_SEGMENT_STAT	Y
DBX_SEG_NAME	n/a
DBX_NUM_IPS	18
DBX_NUM_IPS_PRIM	n/a
DBX_NUM_IPS_OVFL	n/a

Figure 22. Sensor Data Statistics report when SEGSTAT_REPORT=YES (FF DB Sensor Printing utility) (Part 3 of 5)

Data Set Statistics (DBD: PHIMDB1 , Partition: PHIM1A , DBTYPE: PHIDAM, DSG: A, Collected on 08/05/2023 03.03.54)

=====
Volume/Extent Statistics
=====

Data set definition and environment information

Data Element Name	Value
DB_FLAG_SPACE_TYPE	C
DB_NUM_PRI_SPACE	2
DB_NUM_SEC_SPACE	1
DB_FLAG_SMS	Y
DB_MAX_EXT_DS	251
DB_MAX_EXT_VOL	123

Data set usage information

Data Element Name	Value
DB_NUM_EXT	1
DB_NUM_VOL	1
DB_NUM_UNUSED_VOL	0
DB_NUM_UNUSED_VOL_SER	0
DB_NUM_UNUSED_VOL_CAND	0

Remaining available data set extent estimation

Data Element Name	Value
DB_AVAIL_EXT_LESS_100	N
DB_NUM_AVAIL_EXT	n/a
DB_AVAIL_EXT_LIMIT	n/a

Remark: If DB_NUM_UNUSED_VOL_CAND is not zero, more extents than those indicated by DB_NUM_AVAIL_EXT might be available.

Data Set Statistics (DBD: PHIMDB1 , Partition: PHIM1A , DBTYPE: PHIDAM, DSG: A, Collected on 08/05/2023 03.03.54)

=====
Data Set Space Usage Statistics
=====

Data Element Name	Value
DB_BLOCK_SIZE	1,024
DB_NUM_DBDS_BLOCKS	261
DB_MAX_DS_SIZE	4G
DB_PCT_OF_MAX_DS_SIZE	0%
DB_RBA_HIGH_ALLOC	1,013,760
DB_RBA_HIGH_USED	267,264
DB_UNUSED_BYTES	746,496
DB_PCT_UNUSED_BYTES	74%

Data Set Statistics (DBD: PHIMDB1 , Partition: PHIM1A , DBTYPE: PHIDAM, DSG: A, Collected on 08/05/2023 03.03.54)

=====
IMS Space Utilization Statistics
=====

Data Element Name	Value
DB_BYTES_SEG	224,686
DB_BYTES_FREE_SPACE	37,208
DB_BYTES_UNIDENTIFIED	42
DB_PCT_BYTES_FREE_SPACE	14%
DB_PCT_BYTES_SEG	84%
DB_NUM_SEG	1,713
DB_NUM_VLSEG	1,713
DB_NUM_VLSEG_SPLIT	0
DB_PCT_NUM_VLSEG_SPLIT	0%
DB_NUM_UNIDENTIFIED	10
DB_AVG_NUM_UNIDENTIFIED	.04
DB_NUM_FSE	246
DB_AVG_NUM_FSE	.94
DB_NUM_FSE_MIN	176
DB_NUM_FSE_MAX	0
DB_AVG_NUM_NOREUSE_FSE	.27
DB_PCT_NUM_NOREUSE_FSE	28%
DB_AVG_NUM_FRAGD_FSE	.94
DB_PCT_NUM_FRAGD_FSE	100%
DB_NUM_PTR	4,672
DB_NUM_PTR_DIFF_BLK	1,976
DB_PCT_NUM_PTR_DIFF_BLK	42%

Figure 23. Sensor Data Statistics report when SEGSTAT_REPORT=YES (FF DB Sensor Printing utility) (Part 4 of 5)

Data Set Statistics (DBD: PHIMDB1 , Partition: PHIM1A , DBTYPE: PHIDAM, DSG: A, Collected on 08/05/2023 03.03.54)

=====
Segment Statistics for Data Set
=====

Segment statistics summary

Data Element Name	Value
DB_FLAG_SEGMENT_STAT	Y
DB_NUM_SEG	1,713

Segment definition and statistics per segment type

Data Element Name	Value
DB_SEG_SC	1
DB_SEG_LEVEL	1
DB_SEG_DSG	A
DB_SEG_NAME	ROOT
DB_NUM_SEG_SC	17
DB_FLAG_SEG_LEN_TYPE	VC
DB_SEG_SC	2
DB_SEG_LEVEL	2
DB_SEG_DSG	A
DB_SEG_NAME	D001
DB_NUM_SEG_SC	336
DB_FLAG_SEG_LEN_TYPE	V
DB_SEG_SC	3
DB_SEG_LEVEL	2
DB_SEG_DSG	A
DB_SEG_NAME	D002
DB_NUM_SEG_SC	243
DB_FLAG_SEG_LEN_TYPE	V
DB_SEG_SC	4
DB_SEG_LEVEL	3
DB_SEG_DSG	A
DB_SEG_NAME	D003
DB_NUM_SEG_SC	112
DB_FLAG_SEG_LEN_TYPE	V
DB_SEG_SC	5
DB_SEG_LEVEL	2
DB_SEG_DSG	A
DB_SEG_NAME	D004
DB_NUM_SEG_SC	408
DB_FLAG_SEG_LEN_TYPE	V

Figure 24. Sensor Data Statistics report when SEGSTAT_REPORT=YES (FF DB Sensor Printing utility) (Part 5 of 5)

Part 3. Using FP Stand-alone Database Sensor

Fast Path Stand-alone DB Sensor (also referred to as FP Stand-alone DB Sensor) can collect statistics of DEDBs.

The following topics explain how to use FP Stand-alone DB Sensor.

Topics:

- [Chapter 10, “Overview of FP Stand-alone DB Sensor,” on page 63](#)
- [Chapter 11, “Considerations for FP Stand-alone DB Sensor,” on page 65](#)
- [Chapter 12, “Running FP Stand-alone DB Sensor,” on page 67](#)
- [Chapter 13, “FP Stand-alone DB Sensor JCL and control statements,” on page 69](#)
- [Chapter 14, “Output from FP Stand-alone DB Sensor,” on page 83](#)
- [Chapter 15, “Setting site default values for FP Stand-alone DB Sensor,” on page 93](#)
- [Chapter 16, “Printing sensor data by using the FP DB Sensor Printing utility,” on page 101](#)

Chapter 10. Overview of FP Stand-alone DB Sensor

You can use FP Stand-alone DB Sensor to collect sensor data from DEDBs.

FP Stand-alone DB Sensor runs as a batch job step of z/OS.

FP Stand-alone DB Sensor scans DEDB area data sets and collects database statistics. Then it organizes the statistics into sensor data, and stores the sensor data in the IMS Tools KB Sensor Data repository in the form of records that are comprised of data elements. When FP Stand-alone DB Sensor completes storing the sensor data in the repository, it notifies the Autonomics Director server that the sensor data is stored.

During the job, FP Stand-alone DB Sensor prints the data element values in the Sensor Data Statistics report. It also prints the keywords and their parameters that were applied at run time in the Runtime Summary report. These reports can be stored in the Output repository of IMS Tools KB.

FP Stand-alone DB Sensor has the following characteristics:

- FP Stand-alone DB Sensor can process both offline DEDB areas and online DEDB areas.
- One FP Stand-alone DB Sensor job can process multiple DEDB area data sets. The maximum number of area data sets is 2048.
- FP Stand-alone DB Sensor uses high performance I/O techniques to reduce the amount of time that is required to scan area data sets.

For a list of the data elements that are collected by FP Stand-alone DB Sensor, see the topics about data elements in the *IMS Tools Base Policy Services User's Guide*.

Chapter 11. Considerations for FP Stand-alone DB Sensor

The following considerations apply when you use FP Stand-alone DB Sensor to collect sensor data from online DEDB areas or when you want to verify database integrity while collecting sensor data.

Processing online DEDB areas

FP Stand-alone DB Sensor can collect sensor data from online DEDB areas. However, because it does not have exclusive access to the DEDB areas, the data element values might be collected while the online DEDB areas are being updated. Such data element values, except for the data elements that are related to area definition, might not reflect the accurate status of the DEDB areas.

To collect the sensor data that accurately reflects the status of DEDB areas, use either of the following methods:

- Quiesce the DEDB areas or take the DEDB areas offline, then run FP Stand-alone DB Sensor.
- Use Integrated DB Sensor in an Online Pointer Checker utility job of IMS High Performance Fast Path Utilities. For details, see the *IMS FP Solution Pack: IMS High Performance Fast Path Utilities User's Guide*.

Verifying database integrity while collecting sensor data

FP Stand-alone DB Sensor collects sensor data and stores them in the Sensor Data repository of IMS Tools KB without verifying database integrity.

To collect and store sensor data only when database integrity is verified, use Integrated DB Sensor in IMS High Performance Fast Path Utilities jobs or in IMS High Performance Image Copy jobs. For details, see the following information:

- *IMS FP Solution Pack: IMS High Performance Fast Path Utilities User's Guide*
- *IMS High Performance Image Copy User's Guide*

Chapter 12. Running FP Stand-alone DB Sensor

To run FP Stand-alone DB Sensor, code DB Sensor JCL statements and submit the job.

Before you begin

Before you submit your DB Sensor job, ensure that the IMS Tools KB server and all the repositories, including the Sensor Data repository, are available.

Optionally, start the Autonomics Director servers if you want to run DB Sensor and a policy evaluation by using the Autonomics Director scheduling calendar. To start Autonomics Director servers, see the *IMS Tools Base Autonomics Director User's Guide*.

Tip: Stand-alone DB Sensor provides the Site Default Generation utility. You can use this utility to set your own default values for your site. See [Chapter 15, “Setting site default values for FP Stand-alone DB Sensor,”](#) on page 93 for information about setting default values.

Procedure

1. Write the EXEC and the DD statements.

See [“EXEC and DD statements for FP Stand-alone DB Sensor”](#) on page 69 for information about the format of the EXEC statement and the input and the output DD statements.

2. Specify the GLOBAL command and keywords in the HFPSYSIN DD.

The GLOBAL command controls the behavior of the job.

See [“GLOBAL command keywords for FP Stand-alone DB Sensor”](#) on page 76 for information about the keywords that can be specified for the GLOBAL command.

3. Specify the DATABASE command and keywords in the HFPSYSIN DD.

The DATABASE command specifies the DEDB areas to process.

See [“DATABASE command keywords for FP Stand-alone DB Sensor”](#) on page 79 for information about the keywords that can be specified for the DATABASE command.

4. Submit the job.

Ensure that the return code is 0. If the return code is other than 0, check the write-to-operator (WTO) messages or the messages that are printed in the HFPPRINT data set, and take the appropriate actions by referring to the troubleshooting information.

Chapter 13. FP Stand-alone DB Sensor JCL and control statements

Input for FP Stand-alone DB Sensor consists of JCL statements that satisfy the JCL requirements and that conform to the required control statement format.

Topics:

- [“EXEC and DD statements for FP Stand-alone DB Sensor” on page 69](#)
- [“Format of the HFPSYSIN control statement” on page 75](#)
- [“GLOBAL command keywords for FP Stand-alone DB Sensor” on page 76](#)
- [“DATABASE command keywords for FP Stand-alone DB Sensor” on page 79](#)
- [“JCL examples for FP Stand-alone DB Sensor” on page 80](#)

EXEC and DD statements for FP Stand-alone DB Sensor

You must include the EXEC statement and appropriate DD statements in your FP Stand-alone DB Sensor JCL.

Subsections:

- [“EXEC statement” on page 69](#)
- [“DD statement summary” on page 69](#)
- [“DD statements for input” on page 70](#)
- [“DD statements for output” on page 74](#)
- [“DD statements for input and output” on page 74](#)

EXEC statement

The EXEC statement must be in the following format:

```
//STEP EXEC PGM=HFPSNSR,PARM='IMSPLEX=imsplex,DBRCGRP=dbrcgrp,GSGNAME=gsgname'
```

where:

PGM

Specifies the FP Stand-alone DB Sensor program, which is HFPSNSR.

PARM

Specifies the parameters. For information about specifying the PARM parameter, see *IMS System Programming APIs*.

DD statement summary

The following table summarizes the DD statements for FP Stand-alone Database Sensor.

Table 6. HFPSNSR DD statements

DD name	Use	Required or optional	Format
STEPLIB	Input	Required	PDS
HFPSYSIN	Input	Required	LRECL=80
<i>area ddname</i>	Input	Required	VSAM

Table 6. HFPSNSR DD statements (continued)

DD name	Use	Required or optional	Format
IMSACB, IMSACBA, or IMSACBB	Input	Required when IMSCATHLQ=*NO	PDS
IMSDALIB	Input	Optional	PDS
MODSTAT	Input	Optional	PS
MODSTAT2	Input	Optional	PS
OLCSTAT	Input	Optional	PS
RECONx	Input	Optional	KSDS
HFPAPARM	Input	Optional	LRECL=80
HFPAUOWC	Input	Optional	LRECL=80
HFPSVRT	Output	Required	LRECL=133
HFPPRINT	Output	Required	SYSOUT
itttSMSG	Output	Optional	LRECL=133
itttWKnn	Input and output	Optional	

DD statements for input

Specify the following input DD statements:

STEPLIB DD

This required DD statement specifies the following load module libraries. All of these libraries must be APF-authorized.

- IMS Fast Path Solution Pack product load module library (including DB Sensor)
- DB Sensor site default library
- IMS RESLIB and DFSMDA members
- SCI exit library for parallel RECON access
- IMS Tools Base product library

HFPSYSIN DD

This required DD statement specifies the input data set that contains the input control statement to specify the DB Sensor runtime options.

For details about the control statement format, commands, and keywords, see the following topics:

- [“Format of the HFPSYSIN control statement” on page 75](#)
- [“GLOBAL command keywords for FP Stand-alone DB Sensor” on page 76](#)
- [“DATABASE command keywords for FP Stand-alone DB Sensor” on page 79](#)

area ddname DD

This required DD statement specifies the name of the area data set to process. The DD name must match the area name in the DBD.

You must specify this DD statement except when DBRC=Y is specified or when the DFSMDA member is included in the STEPLIB DD or the IMSDALIB DD library.

IMSACB DD

This optional DD statement specifies the library that contains the DMB for the database. The IMSACB DD statements (IMSACB, IMSACBA, IMSACBB, MODSTAT, MODSTAT2, and OLCSTAT) can be used

to identify the active ACB library. When both OLCSTAT or MODSTAT and MODSTAT2 are found, FP Stand-alone DB Sensor checks the time stamp and determines which one is the latest.

DB Sensor determines the active IMSACB library according to the following rules:

1. Check the IMSACB DD statement in the JCL statement.
2. Check the OLCSTAT DD statement in the JCL statement.
3. Check the MODSTAT and MODSTAT2 DD statements in the JCL statement.
4. Allocate the OLCSTAT data set dynamically and check the OLCSTAT member.
5. Allocate the MODSTAT and MODSTAT2 data sets dynamically and check the MODSTAT and MODSTAT2 members.

If you specify the IMSCATHLQ keyword, IMSACB DD statements are not used. The IMS directory is used instead of the ACB library.

IMSACBA DD

This DD statement specifies the library that contains the DMB for the database. This statement must be provided if MODSTAT and MODSTAT2, or the OLCSTAT DD statement is specified.

IMSACBB DD

This DD statement specifies the library that contains the DMB for the database. This statement must be provided if MODSTAT and MODSTAT2, or the OLCSTAT DD statement is specified.

IMSDALIB DD

This optional DD statement specifies the DFSMDA member modules. Specify this DD statement only if you do not want to APF-authorize the DFSMDA members data set. If both IMSDALIB and STEPLIB contain the DFSMDA members, IMSDALIB is used.

MODSTAT DD

This optional DD statement specifies the MODSTAT data set. When this statement is specified, the IMSACBA and IMSACBB DD statements must be specified instead of the ACBLIB DD statement.

If this statement is not specified in the JCL statement when the data set is required, the data set is allocated dynamically by using a DFSMDA member. You can build the DFSMDA member for the MODSTAT library by using a TYPE=DATABASE statement of the DFSMDA macro.

MODSTAT2 DD

This optional DD statement specifies the MODSTAT2 data set. When this statement is specified, the IMSACBA and IMSACBB DD statements must be specified instead of the ACBLIB DD statement.

If this statement is not specified in the JCL statement when the data set is required, the data set is allocated dynamically by using a DFSMDA member. You can build the DFSMDA member for the MODSTAT2 library by using a TYPE=DATABASE statement of the DFSMDA macro.

OLCSTAT DD

This optional DD statement specifies the OLCSTAT data set. When this statement is specified, the IMSACBA and IMSACBB DD statements must be specified instead of the ACBLIB DD statement.

If this statement is not specified in the JCL statement when the data set is required, the data set is allocated dynamically by using a DFSMDA member. You can build the DFSMDA member for the OLCSTAT library by using a TYPE=DATABASE statement of the DFSMDA macro.

RECONx DD

These DD statements specify the RECON1, RECON2, and RECON3 data sets when DBRC is used (DBRC=YES specification in HFPSYSIN DD). You can omit these DD statements if the DFSMDA member is included in the STEPLIB DD or the IMSDALIB DD.

HFPAPARM DD

This DD statement is an optional DD statement that contains execution control parameters.

If you want the Online Space Management utility to obtain values for the RBASEFS keyword, the RDOVFFS keyword, or both from the Sensor Data repository, specify a valid value for these keywords with this DD statement.

The HFPAPARM DD statement can be coded as a sequential data set or as a PDS member. LRECL=80 is required for the DCB of this data set. The HFPAPARM keywords must be written on one line. It can be coded as follows:

```
//HFPAPARM DD *
  ARDIGIT=5 RBASEFS=30 RDOVFFS=50 RGROUP=IMS1
/*
```

You can specify the keywords that are listed in the following table.

Table 7. HFPAPARM keywords

Keyword	Description
ARDIGIT	This keyword specifies the digit of the area number field for the UOW group definition records that are defined in the HFPAUOWC file. The value can be 3 or 5. The default value is 3. If the HFPAUOWC file is not specified in the JCL statement, this keyword is ignored.
RBASEFS	<p>This keyword defines the value for data element DB_THRESHOLD_RBASEFS. The defined value is read by the Online Space Management utility and used as the RBASEFS keyword value in the reorganization process during the Online Expert Reorganization utility process.</p> <p>The value specifies the criterion to select UOWs to reorganize. It specifies the percentage of free space in each RAP CI. If a RAP CI contains free space that is greater than the specified percentage, and the RAP CI also uses overflow CIs, the UOW is selected as a candidate for the reorganization.</p> <p>Specify an integer value in the range of 0 - 100. The maximum value 100 has a special meaning; if RBASEFS=100 is specified, the RBASEFS condition is not used to select an initial set of UOWs.</p>
RDOVFFS	<p>This keyword defines the value for data element DB_THRESHOLD_RDOVFFS. The defined value is read by the Online Space Management utility and used as the RDOVFFS keyword value in the reorganization process during the Online Expert Reorganization utility process.</p> <p>The value specifies the criterion to select UOWs to reorganize. It specifies the percentage of free space in the dependent overflow area in each UOW. If the free space percentage in the dependent overflow area in a UOW is greater than the specified percentage, and the UOW also uses IOVF CIs, the UOW is selected as a candidate for the reorganization.</p> <p>Specify an integer value in the range of 0 - 100. The maximum value 100 has a special meaning; if RDOVFFS=100 is specified, the RDOVFFS condition is not used to select an initial set of UOWs.</p>
RGROUP	This keyword sets the group identifier for the statistics that are collected and stored in a sensor data record set. The keyword value is set for the DB_SENSOR_DATA_GROUP_ID data element. This keyword has no default value. If this keyword is not specified, the DB_SENSOR_DATA_GROUP_ID data element is not included in the sensor data record set.

HFPAUOWC DD

This DD statement is optional. Each record in the data set specifies a range of UOW numbers of an area, which defines a UOW group of the area. The information about the UOW group is recorded in a sensor data record set in the order that is specified in the HFPAUOWC data set, even if the UOW ranges overlap or are in reverse order. When you specify UOW ranges of multiple areas, the records must be in ascending order of their area number.

The data set can reside in the JCL input stream. The data set can also be defined as a sequential data set or as a member of a partitioned data set. If a data set is specified, the data set must have the following attributes: DSORG = PS, RECFM = FB, LRECL = 80, BLKSIZE = a multiple of 80.

If the data set is empty and SENSOR_UOW=YES is specified, all UOWs of the area are regarded as the target UOW range. If SENSOR_UOW=NO is specified, this DD statement is ignored.

The following two types of records are supported:

ARDIGIT=3 (default)

The area number is specified by a 3-digit decimal number.

ARDIGIT=5

The area number is specified by a 5-digit decimal number.

You must use one of these record types for all records in the data set. The type of the record must match the specification of the ARDIGIT parameter for the utility that uses the data set. The number of digits of the area number field ("AREA# IN DBD") in the record must have the same number of digits as the ARDIGIT value.

The ARDIGIT parameter is specified in the HFPAPARM data set.

The following table summarizes the UOW group definition record layout when the ARDIGIT parameter is 3.

Table 8. UOW group definition record layout when ARDIGIT is 3

Field description	COBOL usage
AREA number defined in DBD	9(3)
Start UOW number	9(7)
Stop UOW number	9(7)

The following table summarizes the UOW group definition record layout when the ARDIGIT parameter is 5.

Table 9. UOW group definition record layout when ARDIGIT is 5

Field description	COBOL usage
AREA number defined in DBD	9(5)
Start UOW number	9(7)
Stop UOW number	9(7)

Area number defined in DBD

Is the area number of the DEDB database that contains the target UOW range. This field contains a right-aligned 3- or 5-digit number, with leading zeros if necessary.

Start UOW number

Specifies the UOW number that is used to start processing. This field contains a right-aligned 7-digit number, with leading zeros if necessary.

Stop UOW number

Specifies the UOW number that is used to stop processing. This field contains a right-aligned 7-digit number, with leading zeros if necessary.

The following examples show the UOW group definition records:

UOW group definition records when ARDIGIT is 3:

```
001000000000000001 UOW 0-1
001000000200000003 UOW 2-3
```

UOW group definition records when ARDIGIT is 5:

```
00001000000000000001 UOW 0-1
00001000000200000003 UOW 2-3
```

DD statements for output

Specify the following output DD statements:

HFPSRT DD

This required DD statement specifies the output data set for the FP Stand-alone DB Sensor reports. You can specify NULLFILE or DUMMY for this data set.

If you omit this DD statement, it is allocated dynamically with SYSOUT=* and the reports are printed in the SYSOUT data set.

For details about the FP Stand-alone Database Sensor reports that are generated in the HFPSRT data set, see [Chapter 14, “Output from FP Stand-alone DB Sensor,” on page 83](#).

HFPPRINT DD

This required DD statement specifies the processing log output data set, which contains the processing messages that are issued by FP Stand-alone DB Sensor. You can specify NULLFILE or DUMMY for this data set.

If you omit this DD statement, it is allocated dynamically with SYSOUT=* and the reports are printed in the SYSOUT data set.

itttMSG DD

These optional DD statements specify an output data set for storing DFSORT messages. For the naming rules for the DD names, see the description of the *itttWKnn* DD.

When this statement is not specified in the JCL statement, FP Stand-alone DB Sensor dynamically allocates the data set by using SYSOUT=*

DD statements for input and output

Specify the following input and output DD statement:

itttWKnn DD

These optional DD statements specify intermediate storage data sets that are used by DFSORT. For more information about coding the SORTWKnn DD statements, see the *DFSORT Application Programming Guide*. Allocating twice the space that is used by the SORTIN data set is usually adequate for each work data set.

The naming rules for the ddnames conform to the following rules:

i:

A, B, and C

If SENSOR_DBREC=YES is specified.

The thousands digit of the area number of the area to be analyzed, or the thousands digit of *n* for *n*-th input thread subtask.

A, D, G, and J:

If the number of areas to be processed or *n* is 999 or less.

B, E, H, and K:

If the number of areas to be processed or *n* is 1000 - 1999.

C, F, I, and L:

If the number of areas to be processed or *n* is 2000 - 2048.

Note: When a subtask ends processing an area, it starts processing the next area. For this reason, the *n*-th input thread subtask does not always process the *n*-th input data set.

ttt

The hundreds, tenths, and units digits of the area number of the area to be processed, or those of *n*.

nn

The number of the SORT work data sets. This value must be 01 - 03.

If this statement is not specified in the JCL statement when these data sets are necessary, FP Stand-alone Database Sensor allocates them dynamically.

Format of the HFPSYSIN control statement

The HFPSYSIN control statement defines the user description of the GLOBAL command and the DATABASE command, both of which control the behavior of the DB Sensor process.

The commands and their keywords must be specified in the HFPSYSIN data set. This data set usually resides in the input stream. However, it can also be defined as a sequential data set or as a member of a partitioned data set. It must contain 80-byte, fixed-length records. BLKSIZE, if coded, must be a multiple of 80.

The following example shows the correct syntax for the control statement in the HFPSYSIN data set.

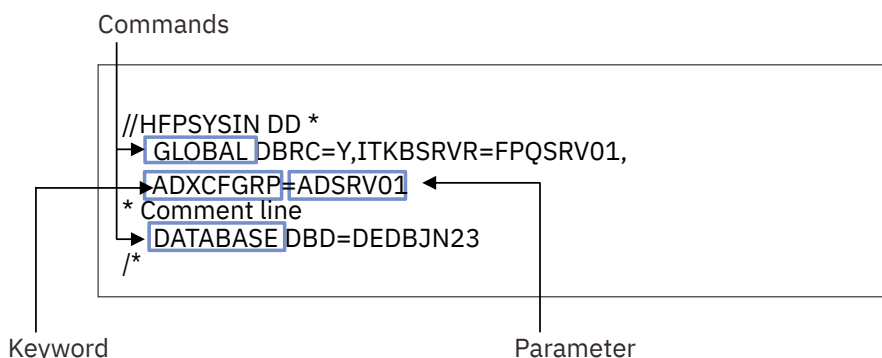

Figure 25. Format of the HFPSYSIN control statement

An HFPSYSIN control statement must conform to the following format:

GLOBAL command

- Only one GLOBAL command can be specified.
- The GLOBAL command keywords and their parameters follow the GLOBAL command.
- A GLOBAL command keyword and its parameter must be connected with an equal sign (=).
- Each GLOBAL command keyword and value pair must be separated by a comma.
- Multiple keyword and parameter pairs can be specified.

Keyword and parameter pairs can span more than one line; type a comma as a continuation character at the end of the first line, and continue the next keyword and parameter pair on the next line.

- A line that starts with an asterisk (*) is treated as a comment line.

DATABASE command

- Only one DATABASE command can be specified.
- The DATABASE command keywords and their parameters follow the DATABASE command.
- A DATABASE command keyword and its parameter must be connected with an equal sign (=).
- Each DATABASE command keyword and value pair must be separated by a comma.
- Multiple keyword and parameter pairs can be specified.

Keyword and parameter pairs can span more than one line; type a comma as a continuation character at the end of the first line, and continue the next keyword and parameter pair on the next line.

- A line that starts with an asterisk (*) is treated as a comment line.

GLOBAL command keywords for FP Stand-alone DB Sensor

The GLOBAL command keywords control the behavior of the job. You must specify the GLOBAL command and its keywords in the HFPSYSIN DD.

The following syntax diagram shows the GLOBAL command keywords for FP Stand-alone DB Sensor.

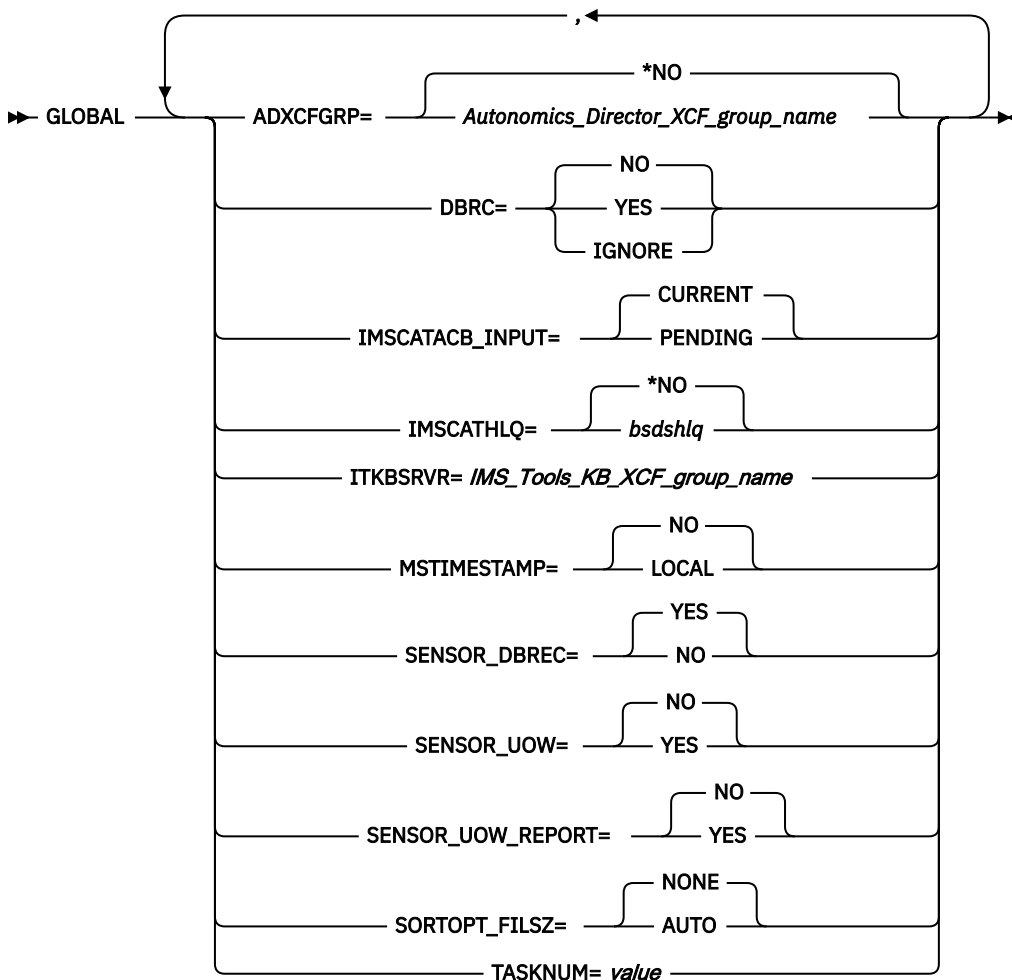

ADXCFGRP=

This keyword specifies whether to send notification to Autonomics Director. The notification is used as a trigger by Autonomics Director to schedule a policy evaluation. If you omit this keyword, ADXCFGRP=*NO is used as the default value.

Important: If you want Autonomics Director to schedule a policy evaluation, you must specify the name of the Autonomics Director XCF group with this keyword.

Autonomics_Director_XCF_group_name

FP Stand-alone DB Sensor sends sensor data notification to Autonomics Director after storing sensor data in the Sensor Data repository of IMS Tools KB.

If you specify the Autonomics Director XCF group, you must specify DBRC=YES.

*NO

FP Stand-alone DB Sensor does not send sensor data notification to Autonomics Director.

DBRC=

This keyword specifies whether to activate DBRC. If you omit this keyword, DBRC=NO is used as the default value.

YES

Activates DBRC. When you specify DBRC=YES, FP Stand-alone DB Sensor stores sensor data in the Sensor Data repository by using the RECON ID (locale) that is associated with the RECONx data set names.

Requirement: To specify DBRC=YES, you must specify the RECONx DD statements or specify a DFSMDA member in the STEPLIB or IMSDALIB data set. For more information about specifying a DFSMDA member, see the topic about the DFSMDA macro in *IMS System Definition*.

NO

Does not activate DBRC. FP Stand-alone DB Sensor stores sensor data in the Sensor Data repository without using a RECON ID.

Exception: When DBRC=FORCE is set for IMS, DBRC is activated even if DBRC=NO is specified in DB Sensor JCL.

IGNORE

Does not activate DBRC. FP Stand-alone DB Sensor stores sensor data in the Sensor Data repository without using a RECON ID. Even when DBRC=FORCE is set for IMS, DBRC is not activated if DBRC=IGNORE is specified in DB Sensor JCL.

IMSCATACB_INPUT=

This keyword specifies whether to retrieve the currently active ACB definition or the pending ACB definition from the IMS directory. IMSCATACB_INPUT keyword is effective only when IMSCATHLQ=*bsdshlq* option is specified for the GLOBAL command. If you omit this keyword, IMSCATACB_INPUT=CURRENT is used as the default value.

CURRENT

FP Stand-alone DB Sensor retrieves the currently active ACB member from the IMS directory data sets.

PENDING

FP Stand-alone DB Sensor retrieves the pending ACB member from the staging data set.

IMSCATHLQ=

This keyword specifies the high-level qualifier of the IMS directory bootstrap data set, which is an extension of the IMS catalog. You must enable the IMS catalog and the IMS management of ACBs when you specify the high-level qualifier of the IMS directory bootstrap data set. If you omit this keyword, IMSCATHLQ=*NO is used as the default value.

bsdshlq

FP Stand-alone DB Sensor reads the ACB from the IMS directory instead of the ACB library by using the IMS Tools Catalog Interface. *bsdshlq* specifies the high-level qualifier of the IMS directory bootstrap data set.

***NO**

FP Stand-alone DB Sensor reads the ACB from the ACB library.

ITKBSRVR=

This keyword specifies the IMS Tools KB XCF group name (IMS Tools KB server name). The sensor data and the DB Sensor reports are stored in the IMS Tools Knowledge Base repositories that are managed by this IMS Tools KB server. This keyword is a required keyword, and you must supply an IMS Tools KB XCF group name.

MSTIMESTAMP=

This keyword specifies whether to include the timestamp with the messages. If you omit this keyword, MSTIMESTAMP=NO is used as the default value.

LOCAL

Includes a local timestamp in the messages.

NO

Does not include a timestamp in the messages.

SENSOR_DBREC=

This keyword specifies whether to collect the data elements that are related to database records and root segment distribution. If you omit this keyword, SENSOR_DBREC=YES is used as the default value.

YES

Collects the following data elements and stores them in the Sensor Data repository of IMS Tools KB:

- DB_MAX_DBREC_LENGTH
- DB_MIN_DBREC_LENGTH
- DB_PCT_NUM_DBREC_IOVF
- DB_MAX_LEN_SYNONYM_CHAIN
- DB_AVG_DBREC_IO
- DB_MAX_DBREC_IO
- DB_AVG_ROOT_IO
- DB_MAX_ROOT_IO

NO

Does not collect the data elements that are related to database records and root segment distribution.

Considerations for SENSOR_DBREC and the policy evaluation process:

If you specify SENSOR_DBREC=NO, Policy Services and Autonomics Director cannot evaluate the factors that are collected when SENSOR_DBREC=YES is specified, and they might not provide adequate information about the state of the area and the actions that you must take. Consider specifying SENSOR_DBREC=YES unless you have performance concerns.

When you specify SENSOR_DBREC=YES, the CPU time and the elapsed time increase compared to when SENSOR_DBREC=NO is specified.

Even if you specify SENSOR_DBREC=NO, rough estimations of the number of I/Os that are required to read database records and root segments are calculated and stored in the Sensor Data repository. These values are stored as DB_ESTIMATED_DB_REC_IO and DB_ESTIMATED_ROOT_IO data elements, and are collected regardless of the SENSOR_DBREC keyword specification.

SENSOR_UOW=

This keyword specifies whether to store the data elements that are related to unit of work (UOW). If you omit this keyword, SENSOR_UOW=NO is used as the default value.

The data elements that will be stored differ by the HFPAUOWC DD specification as follows:

- If you specify the HFPAUOWC DD statement, data elements are collected at the UOW group level (data elements that begin with DEBUG.)
- If you do not specify the HFPAUOWC DD statement, data elements are collected at the UOW level (data elements that begin with DBU.)

YES

Collects the data elements that are related to UOWs and stores them in the Sensor Data repository of IMS Tools KB. When you specify SENSOR_UOW=YES, you must also specify SENSOR_DBREC=YES.

Note: When you specify the HFPAUOWC DD statement, the data elements that begin with DEBUG_ are collected. When you do not specify the HFPAUOWC DD statement, the data elements that begin with DBU_ are collected.

NO

Does not collect the data elements that are related to UOW.

Considerations for SENSOR_UOW and the policy evaluation process:

If you specify SENSOR_UOW=YES, FP Stand-alone DB Sensor collects data elements for each UOW or UOW group. When you process many UOWs or UOW groups, be aware that the number of data elements that will be stored in the IMS Tools KB Sensor Data repository can be large. Processing large number of data elements might increase elapsed time and require more storage space in the repository.

SENSOR_UOW_REPORT=

This keyword specifies whether to print the sensor data that is related to UOW in the HFPSRT data set. If you omit this keyword, SENSOR_UOW_REPORT=NO is used as the default value.

YES

Prints the sensor data that is related to UOW in the HFPSRT data set. When you specify SENSOR_UOW_REPORT=YES, you must also specify SENSOR_UOW=YES.

NO

Does not print the sensor data that is related to UOW in the HFPSRT data set.

Considerations for SENSOR_UOW_REPORT:

When you specify the HFPAUOWC DD statement, the SENSOR_UOW=YES keyword, and the SENSOR_UOW_REPORT=YES keyword, the data elements that are related to UOW are collected at the UOW group level and are printed in the Sensor Data Statistics report.

When you specify the SENSOR_UOW=YES keyword and the SENSOR_UOW_REPORT=YES keyword without an HFPAUOWC DD statement, the data elements that are related to UOW are collected at the UOW level and are printed in the Sensor Data Statistics report; however, the amount of data can be large and might require additional time to print the Sensor Data Statistics report.

SORTOPT_FILSZ=

This keyword specifies that FP Stand-alone DB Sensor adds the FILSZ parameter to the SORT control statement.

AUTO

FP Stand-alone DB Sensor uses the size of the areas and segment definitions to estimate the number of records to sort and adds the FILSZ parameter (FILSZ=Ennnnnnnn) to the SORT control statement.

Specify SORTOPT_FILSZ=AUTO if you received message ICE046A when DFSORT sorted the internal records of FP Stand-alone DB Sensor.

NONE

FP Stand-alone DB Sensor does not add the FILSZ parameter to the SORT control statement.

Even if you specify SORTOPT_FILSZ=NONE, if FP Stand-alone DB Sensor can calculate the actual number of records to sort before the sort program is run, FP Stand-alone DB Sensor adds the FILSZ parameter to the SORT control statement.

TASKNUM=

This keyword specifies the number of tasks that can run in parallel to process the areas. You can specify an integer value in the range of 1 - 200. If the value is larger than the number of input areas, DB Sensor replaces this value with the number of input areas. If you omit this keyword, TASKNUM=4 is used as the default value.

DATABASE command keywords for FP Stand-alone DB Sensor

The DATABASE command keywords specify the DEDB areas to process. You must specify the DATABASE command and its keywords in the HFPSYSIN DD.

You can specify only one DATABASE command.

The following syntax diagram shows the DATABASE command keywords for FP Stand-alone DB Sensor.

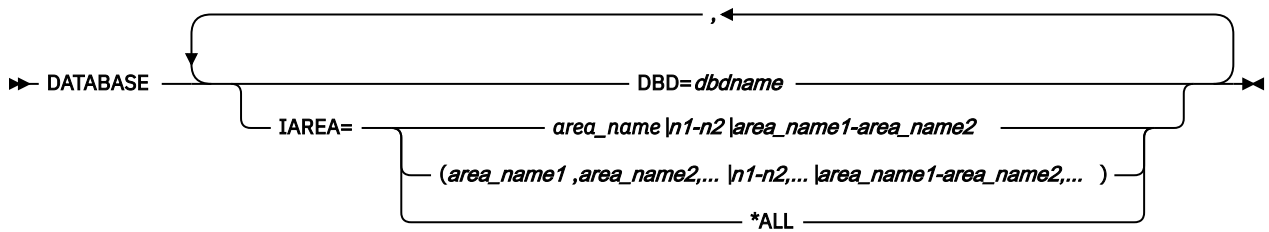

DBD=

This keyword specifies the DBD that contains the areas to be processed. The DBD name must correspond to the member in the IMSACB library.

IAREA=

This keyword specifies the DEDB area names. If you omit this keyword, IAREA=*ALL is used as the default value.

area_name

FP Stand-alone DB Sensor processes the specified areas. You can specify multiple areas by surrounding the area names with parentheses and using a comma to delimit each area name. When you specify the HFP AUOWC DD and if you want to process multiple areas, specify the area names in ascending order of their area number.

You can also use certain wildcard characters to specify areas. These wildcard characters are the asterisk (*), which represents 0 - 8 characters, and the percent sign (%), which represents any single character. For example, IAREA=area* matches area, area1, area1234, and so on; IAREA=area% matches area1, area2, and so on.

n1-n2

FP Stand-alone DB Sensor processes the areas that are found in the specified range. Specify the range of areas by area numbers. *n1* and *n2* are area numbers, which are decimal numbers assigned sequentially to the areas within a database. The value for *n1* and *n2* can be in the range of 1 - 2048. *n2* must be equal to or greater than *n1*. At least one area must exist in the specified range.

area_name1-area_name2

FP Stand-alone DB Sensor processes the areas that are found in the specified range. *area_name1* and *area_name2* must be specified in alphabetical order. At least one area must exist in the specified range.

***ALL**

FP Stand-alone DB Sensor processes all the areas of the DEDB.

JCL examples for FP Stand-alone DB Sensor

Use these JCL examples to help you code JCL statements for FP Stand-alone DB Sensor.

Subsections:

- [“Processing all the areas of a DEDB” on page 80](#)
- [“Processing multiple areas of a DEDB” on page 81](#)

Processing all the areas of a DEDB

The following JCL example is for processing all the areas of a DEDB.

```

//HFP      EXEC PGM=HFPSNSR
//STEPLIB DD DISP=SHR,DSN=HPFP.SHFPLMD0
//          DD DISP=SHR,DSN=IMSVS.SDFSRESL
//          DD DISP=SHR,DSN=IMSVS.PGMLIB
//          DD DISP=SHR,DSN=ITB.SHKTLOAD
//IMSACB  DD DISP=SHR,DSN=IMSVS.ACBLIB
//IMSDALIB DD DISP=SHR,DSN=IMSVS.MDALIB1
//HFPSVRT DD SYSOUT=*
//HFPPRINT DD SYSOUT=*
//HFPSYSIN DD *
          GLOBAL DBRC=YES,
              ITKBSRVR=FPQSRV01,
              ADXCFGRP=ADSRV01
          DATABASE
              DBD=DEDBJN23,
              IAREA=*ALL
/*
//

```

Figure 26. FP Stand-alone DB Sensor JCL example: Processing all areas of a DEDB

Processing multiple areas of a DEDB

The following JCL example is for processing multiple areas of a DEDB.

```

//HFP      EXEC PGM=HFPSNSR
//STEPLIB DD DISP=SHR,DSN=HPFP.SHFPLMD0
//          DD DISP=SHR,DSN=IMSVS.SDFSRESL
//          DD DISP=SHR,DSN=IMSVS.PGMLIB
//          DD DISP=SHR,DSN=ITB.SHKTLOAD
//IMSACB  DD DISP=SHR,DSN=IMSVS.ACBLIB
//IMSDALIB DD DISP=SHR,DSN=IMSVS.MDALIB1
//HFPSVRT DD SYSOUT=*
//HFPPRINT DD SYSOUT=*
//HFPSYSIN DD *
          GLOBAL DBRC=YES,
              ITKBSRVR=FPQSRV01,
              ADXCFGRP=ADSRV01
          DATABASE
              DBD=DEDBJN23,
              IAREA=(AREA1, AREA2, AREA5)
/*
//

```

Figure 27. FP Stand-alone DB Sensor JCL example: Processing multiple areas of a DEDB

HFPSYSIN

This part shows an echo of the control statements that you specified in the HFPSYSIN data set.

PROCESSING INFORMATION

This part shows the parameters on the EXEC statement and the GLOBAL command keywords and their parameters that were applied at run time.

Processing report from FP Stand-alone DB Sensor

The Processing report contains the keywords and parameters that were applied in the DB Sensor job.

The keywords and parameters in the report are determined by the keywords and parameters in HFPSYSIN, the site default options, and the system default values.

Sample report

The following figure shows an example of the Processing report.

```
IMS HPFP UTILITIES - DB SENSOR                "Processing report"                PAGE: 1
5698-FPP V2R1                                2022-10-30 15:57:52
DB SENSOR STARTED DATE: 2022-10-30 TIME: 15:57:52 ENDED DATE: 2022-10-30 TIME: 15:57:53
DATABASE PROCESSING OPTION
- DBD : DEDBJN22
- IAREA : (DB22AR0)
- IMSACB : HPFPU.ACBLIB
PROCESSING INFORMATION
- DBRC=NO IS SPECIFIED. - EEQE DETECTION IS NOT PERFORMED.
```

Figure 29. Processing report (FP Stand-alone DB Sensor)

Report field descriptions

This report provides the following information:

DATABASE PROCESSING OPTION

This part shows the keywords and parameters that the command process used.

IMSACB shows the name of the data set that is assigned to the DD statement. If you specify IMSCATHLQ= *bsdshlq*, either IMS CATALOG (CURRENT) or IMS CATALOG (PENDING) is printed instead of the data set name.

PROCESSING INFORMATION

This part shows the information messages that were issued during the command processing.

Restriction: When data sets IMSACB, NEWACB, OLDACB, or all three are specified as concatenated, only the name of the first data set is printed in the report.

Sensor Data Statistics report from FP Stand-alone Database Sensor

The Sensor Data Statistics report contains the names and the values of the data elements that were collected in the DB Sensor job.

For the definitions of these data elements, see the topics about data elements in *IMS Tools Base Policy Services User's Guide*.

The following figures show an example of the Sensor Data Statistics report.

DBD NAME: DEDBJN23, AREA NAME: DB23AR0 , AREA NUMBER: 1

=====
AREA DEFINITION
=====

Data Element Name	Value
DB_AREAEDEF_CISIZE	4,096
DB_AREAEDEF_UOW1	20
DB_AREAEDEF_UOW2	10
DB_AREAEDEF_ROOT1	1,500
DB_AREAEDEF_ROOT2	1,000
DB_AREAEDEF_NUM_SDEP_CIS	10,000

=====
FREE SPACE PERCENTAGE STATISTICS
=====

Data Element Name	Value
DB_PCT_BYTES_FS_RAA	50%
DB_PCT_BYTES_FS_DOVF	50%
DB_PCT_BYTES_FS_IOVF	50%
DB_PCT_BYTES_FS_SDEP	50%

=====
OVERFLOW USAGE STATISTICS
=====

Data Element Name	Value
DB_PCT_NUM_UOW_USE_DOVF	50%
DB_AVG_NUM_DOVFCI_BY_UOW	678.99
DB_MAX_NUM_DOVFCI_BY_UOW	9,999
DB_PCT_NUM_UOW_USE_IOVF	50%
DB_NUM_UOW_USE_IOVF	9,999
DB_AVG_NUM_IOVFCI_BY_UOW	678.99
DB_MAX_NUM_IOVFCI_BY_UOW	9,999
DB_MIN_NUM_IOVFCI_BY_UOW	9,999
DB_PCT_NUM_IOVFCI_USED	50%
DB_PCT_NUM_RAPCI_OVFL	50%

=====
SEGMENT OCCURRENCE STATISTICS
=====

Data Element Name	Value
DB_NUM_SEG	12,345,678

Figure 30. Sensor Data Statistics report (FP Stand-alone DB Sensor) (Part 1 of 2)

DBD NAME: DEDBJN23, AREA NAME: DB23AR0 , AREA NUMBER: 1

```
=====
DATABASE RECORD STATISTICS
=====
```

Data Element Name	Value
DB_NUM_ROOT	111,111
DB_AVG_DBREC_LENGTH	111.00
DB_MAX_DBREC_LENGTH	111,111
DB_MIN_DBREC_LENGTH	111,111
DB_PCT_NUM_DBREC_IOVF	50%

```
=====
RANDOMIZING STATISTICS
=====
```

Data Element Name	Value
DB_AVG_LEN_SYNONYM_CHAIN	1.11
DB_MAX_LEN_SYNONYM_CHAIN	99,999

```
=====
PHYSICAL I/O STATISTICS
=====
```

Data Element Name	Value
DB_ESTIMATED_DBREC_IO	1.25
DB_ESTIMATED_ROOT_IO	1.25
DB_AVG_DBREC_IO	678.99
DB_MAX_DBREC_IO	99,999
DB_AVG_ROOT_IO	678.99
DB_MAX_ROOT_IO	99,999

```
=====
UOW STATISTICS INFORMATION
=====
```

Data Element Name	Value
DB_FLAG_UOW_DATA	N
DB_FLAG_UOW_GROUP_DATA	N
DB_THRESHOLD_RBSEFS	30%
DB_THRESHOLD_RDOVFFS	50%
DB_NUM_UOW_RFS_COND	50
DB_PCT_NUM_UOW_RFS_COND	10%

Figure 31. Sensor Data Statistics report (FP Stand-alone DB Sensor) (Part 2 of 2)

The following figures show another example of the Sensor Data Statistics report. In this report, logical pages 3 and 4 contain data element values for the first UOW in the area that is specified by the IAREA keyword. This report is printed if both of the following conditions are met:

- SENSOR_UOW=YES is specified
- HFPAUOWC DD statement is not specified

In actual reports, data element values for other UOWs are printed in the subsequent pages.

DBD NAME: DEDBJN23, AREA NAME: DB23AR0 , AREA NUMBER: 1

=====
AREA DEFINITION
=====

Data Element Name	Value
DB_AREAEDEF_CISIZE	4,096
DB_AREAEDEF_UOW1	20
DB_AREAEDEF_UOW2	10
DB_AREAEDEF_ROOT1	1,500
DB_AREAEDEF_ROOT2	1,000
DB_AREAEDEF_NUM_SDEP_CIS	10,000

=====
FREE SPACE PERCENTAGE STATISTICS
=====

Data Element Name	Value
DB_PCT_BYTES_FS_RAA	50%
DB_PCT_BYTES_FS_DOVF	50%
DB_PCT_BYTES_FS_IOVF	50%
DB_PCT_BYTES_FS_SDEP	52%

=====
OVERFLOW USAGE STATISTICS
=====

Data Element Name	Value
DB_PCT_NUM_UOW_USE_DOVF	50%
DB_AVG_NUM_DOVFCI_BY_UOW	678.99
DB_MAX_NUM_DOVFCI_BY_UOW	9,999
DB_PCT_NUM_UOW_USE_IOVF	50%
DB_NUM_UOW_USE_IOVF	9,999
DB_AVG_NUM_IOVFCI_BY_UOW	678.99
DB_MAX_NUM_IOVFCI_BY_UOW	9,999
DB_MIN_NUM_IOVFCI_BY_UOW	9,999
DB_PCT_NUM_IOVFCI_USED	50%
DB_PCT_NUM_RAPCI_OVFL	50%

=====
SEGMENT OCCURRENCE STATISTICS
=====

Data Element Name	Value
DB_NUM_SEG	12,345,678

Figure 32. Sensor Data Statistics report when SENSOR_UOW=YES (without HFPAUOWC DD, FP Stand-alone DB Sensor) (Part 1 of 4)

DBD NAME: DEDBJN23, AREA NAME: DB23AR0 , AREA NUMBER: 1

=====

DATABASE RECORD STATISTICS

=====

Data Element Name	Value
DB_NUM_ROOT	111,111
DB_AVG_DBREC_LENGTH	111.00
DB_MAX_DBREC_LENGTH	111,111
DB_MIN_DBREC_LENGTH	111,111
DB_PCT_NUM_DBREC_IOVF	50%

=====

RANDOMIZING STATISTICS

=====

Data Element Name	Value
DB_AVG_LEN_SYNONYM_CHAIN	1.11
DB_MAX_LEN_SYNONYM_CHAIN	99,999

=====

PHYSICAL I/O STATISTICS

=====

Data Element Name	Value
DB_ESTIMATED_DBREC_IO	1.25
DB_ESTIMATED_ROOT_IO	1.25
DB_AVG_DBREC_IO	678.99
DB_MAX_DBREC_IO	99,999
DB_AVG_ROOT_IO	678.99
DB_MAX_ROOT_IO	99,999

=====

UOW STATISTICS INFORMATION

=====

Data Element Name	Value
DB_FLAG_UOW_DATA	Y
DB_FLAG_UOW_GROUP_DATA	N
DB_THRESHOLD_RBSEFS	30%
DB_THRESHOLD_RDOVFFS	50%
DB_NUM_UOW_RFS_COND	50
DB_PCT_NUM_UOW_RFS_COND	10%

=====

REPOSITORY GROUP INFORMATION

=====

Data Element Name	Value
DB_SENSOR_DATA_GROUP_ID	IMS1

Figure 33. Sensor Data Statistics report when SENSOR_UOW=YES (without HFP AUOWC DD, FP Stand-alone DB Sensor) (Part 2 of 4)

DBD NAME: DEDBJN23, AREA NAME: DB23AR0 , AREA NUMBER: 1, UOW NUMBER: 0

=====

FREE SPACE PERCENTAGE STATISTICS

=====

Data Element Name	Value
DBU_PCT_BYTES_FS_RAA	80%
DBU_PCT_BYTES_FS_DOVF	80%
DBU_PCT_BYTES_FS_IOVF	95%
DBU_PCT_USABLE_RAAFS	80%
DBU_PCT_USABLE_DOVFFS	80%
DBU_PCT_USABLE_IOVFFS	95%
DBU_PCT_RAP_ROOTSZFS	0%
DBU_MAX_PCT_BYTES_RAPFS	0%
DBU_FLAG_UOW_USING_OVFL	Y
DBU_FLAG_UOW_USING_IOVF	Y

=====

OVERFLOW USAGE STATISTICS

=====

Data Element Name	Value
DBU_NUM_DOVFCT_BY_UOW	10
DBU_NUM_IOVFCT_BY_UOW	3
DBU_PCT_NUM_RAPCT_OVFL	100%

=====

DATABASE RECORD STATISTICS

=====

Data Element Name	Value
DBU_NUM_ROOT	120
DBU_AVG_DBREC_LENGTH	106.00
DBU_MAX_DBREC_LENGTH	582
DBU_MIN_DBREC_LENGTH	102
DBU_PCT_NUM_DBREC_IOVF	18%

Figure 34. Sensor Data Statistics report when SENSOR_UOW=YES (without HFFPAUOWC DD, FP Stand-alone DB Sensor) (Part 3 of 4)

DBD NAME: DEDBJN23, AREA NAME: DB23AR0 , AREA NUMBER: 1, UOW NUMBER: 0

=====

RANDOMIZING STATISTICS

=====

Data Element Name	Value
DBU_AVG_LEN_SYN_CHAIN	120.00
DBU_MAX_LEN_SYN_CHAIN	120

=====

PHYSICAL I/O STATISTICS

=====

Data Element Name	Value
DBU_AVG_DBREC_IO	7.06
DBU_MAX_DBREC_IO	13
DBU_AVG_ROOT_IO	7.06
DBU_MAX_ROOT_IO	13

Figure 35. Sensor Data Statistics report when SENSOR_UOW=YES (without HFFPAUOWC DD, FP Stand-alone DB Sensor) (Part 4 of 4)

The following figures show another example of the Sensor Data Statistics report. In this report, logical pages 3 and 4 contain data element values for a UOW group that is specified by the HFFPAUOWC DD statement. This report is printed if both of the following conditions are met:

- SENSOR_UOW=YES is specified
- HFFPAUOWC DD statement is specified

In actual reports, if multiple UOW groups are specified, data element values for other UOW groups are printed in the subsequent pages.

DBD NAME: DEDBJN23, AREA NAME: DB23AR0 , AREA NUMBER: 1

```
=====
AREA DEFINITION
=====
```

Data Element Name	Value
DB_AREAEDEF_CISIZE	4,096
DB_AREAEDEF_UOW1	20
DB_AREAEDEF_UOW2	10
DB_AREAEDEF_ROOT1	1,500
DB_AREAEDEF_ROOT2	1,000
DB_AREAEDEF_NUM_SDEP_CIS	10,000

```
=====
FREE SPACE PERCENTAGE STATISTICS
=====
```

Data Element Name	Value
DB_PCT_BYTES_FS_RAA	50%
DB_PCT_BYTES_FS_DOVF	50%
DB_PCT_BYTES_FS_IOVF	50%
DB_PCT_BYTES_FS_SDEP	52%

```
=====
OVERFLOW USAGE STATISTICS
=====
```

Data Element Name	Value
DB_PCT_NUM_UOW_USE_DOVF	50%
DB_AVG_NUM_DOVFCI_BY_UOW	678.99
DB_MAX_NUM_DOVFCI_BY_UOW	9,999
DB_PCT_NUM_UOW_USE_IOVF	50%
DB_NUM_UOW_USE_IOVF	9,999
DB_AVG_NUM_IOVFCI_BY_UOW	678.99
DB_MAX_NUM_IOVFCI_BY_UOW	9,999
DB_MIN_NUM_IOVFCI_BY_UOW	9,999
DB_PCT_NUM_IOVFCI_USED	50%
DB_PCT_NUM_RAPCI_OVFL	50%

```
=====
SEGMENT OCCURRENCE STATISTICS
=====
```

Data Element Name	Value
DB_NUM_SEG	12,345,678

Figure 36. Sensor Data Statistics report when SENSOR_UOW=YES (with HFPAUOWC DD, FP Stand-alone DB Sensor) (Part 1 of 4)

DBD NAME: DEDBJN23, AREA NAME: DB23AR0 , AREA NUMBER: 1

```

=====
DATABASE RECORD STATISTICS
=====
Data Element Name          Value
-----
DB_NUM_ROOT                111,111
DB_AVG_DBREC_LENGTH        111.00
DB_MAX_DBREC_LENGTH        111,111
DB_MIN_DBREC_LENGTH        111,111
DB_PCT_NUM_DBREC_IOVF      50%

=====
RANDOMIZING STATISTICS
=====
Data Element Name          Value
-----
DB_AVG_LEN_SYNONYM_CHAIN    1.11
DB_MAX_LEN_SYNONYM_CHAIN    99,999

=====
PHYSICAL I/O STATISTICS
=====
Data Element Name          Value
-----
DB_ESTIMATED_DBREC_IO       1.25
DB_ESTIMATED_ROOT_IO        1.25
DB_AVG_DBREC_IO              678.99
DB_MAX_DBREC_IO              99,999
DB_AVG_ROOT_IO               678.99
DB_MAX_ROOT_IO               99,999

=====
UOW STATISTICS INFORMATION
=====
Data Element Name          Value
-----
DB_FLAG_UOW_DATA            N
DB_FLAG_UOW_GROUP_DATA      Y
DB_NUM_UOW_GROUPS            2
DB_THRESHOLD_RBASEFS        30%
DB_THRESHOLD_RDOVFFS        50%
DB_NUM_UOW_RFS_COND         50
DB_PCT_NUM_UOW_RFS_COND     10%

=====
REPOSITORY GROUP INFORMATION
=====
Data Element Name          Value
-----
DB_SENSOR_DATA_GROUP_ID     IMS1
    
```

Figure 37. Sensor Data Statistics report when SENSOR_UOW=YES (with HFP AUOWC DD, FP Stand-alone DB Sensor) (Part 2 of 4)

DBD NAME: DEDBJN23, AREA NAME: DB23AR0 , AREA NUMBER: 1, UOW GROUP (STARTUOW: 10001, STOPUOW: 20000)

=====

FREE SPACE PERCENTAGE STATISTICS

=====

Data Element Name	Value
DEBUG_PCT_BYTES_FS_RAA	80%
DEBUG_PCT_BYTES_FS_DOVF	80%
DEBUG_PCT_BYTES_FS_IOVF	95%
DEBUG_PCT_USABLE_RAAFS	80%
DEBUG_PCT_USABLE_DOVFFS	80%
DEBUG_PCT_USABLE_IOVFFS	95%
DEBUG_PCT_RAP_ROOTSZFS	0%

=====

OVERFLOW USAGE STATISTICS

=====

Data Element Name	Value
DEBUG_PCT_NUM_UOW_DOVF	80%
DEBUG_AVG_NUM_DOVFCCI	5
DEBUG_MAX_NUM_DOVFCCI	10
DEBUG_PCT_NUM_UOW_IOVF	80%
DEBUG_AVG_NUM_IOVFCCI	10
DEBUG_MAX_NUM_IOVFCCI	50
DEBUG_PCT_NUM_RAPCI_OVFL	100%

=====

DATABASE RECORD USAGE STATISTICS

=====

Data Element Name	Value
DEBUG_NUM_ROOT	120
DEBUG_AVG_DBREC_LENGTH	106.00
DEBUG_MAX_DBREC_LENGTH	582
DEBUG_MIN_DBREC_LENGTH	102
DEBUG_PCT_NUM_DBREC_IOVF	18%

Figure 38. Sensor Data Statistics report when SENSOR_UOW=YES (with HFP AUOWC DD, FP Stand-alone DB Sensor) (Part 3 of 4)

DBD NAME: DEDBJN23, AREA NAME: DB23AR0 , AREA NUMBER: 1, UOW GROUP (STARTUOW: 10001, STOPUOW: 20000)

=====

RANDOMIZING STATISTICS

=====

Data Element Name	Value
DEBUG_AVG_LEN_SYN_CHAIN	120.00
DEBUG_MAX_LEN_SYN_CHAIN	120

=====

PHYSICAL I/O STATISTICS

=====

Data Element Name	Value
DEBUG_AVG_DBREC_IO	7.06
DEBUG_MAX_DBREC_IO	13
DEBUG_AVG_ROOT_IO	7.06
DEBUG_MAX_ROOT_IO	13

Figure 39. Sensor Data Statistics report when SENSOR_UOW=YES (with HFP AUOWC DD, FP Stand-alone DB Sensor) (Part 4 of 4)

Chapter 15. Setting site default values for FP Stand-alone DB Sensor

Use the FP Stand-alone DB Sensor Site Default Generation utility (FP Site Default Generation utility) to set your own default values for the Stand-alone DB Sensor runtime options.

You can use the FP Site Default Generation utility to create a *site default table* (HFPSTL0). A site default table contains the HFPSYSIN control statement keywords and parameters that will be applied at run time. You can also use this utility to print the keywords and their parameters that are defined in the site default table to a report.

Topics:

- [“Creating a site default table for FP Stand-alone DB Sensor” on page 93](#)
- [“EXEC and DD statements for the FP Site Default Generation utility” on page 95](#)
- [“Keywords for the FP Site Default Generation utility” on page 98](#)
- [“Output from the FP Site Default Generation utility” on page 99](#)

Creating a site default table for FP Stand-alone DB Sensor

To generate a site default table, code the FP Site Default Generation utility JCL, run the job, and assemble and link-edit the source code.

About this task

The following figure shows the steps for creating the site default table. The numbers in the figure match the numbers in the procedure steps.

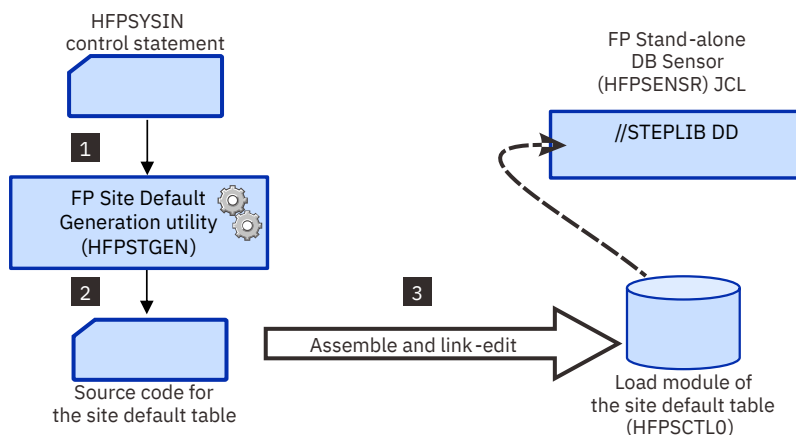

Figure 40. Steps for creating a site default table (FP Stand-alone DB Sensor)

Procedure

1. Write the EXEC and the DD statements.

For the format of the EXEC statement and the list of DD statements, see [“EXEC and DD statements for the FP Site Default Generation utility” on page 95](#).

2. Run the FP Site Default Generation utility (HFPSTGEN) job step to create the source code for HFPSTL0.

Ensure that the return code is 0. Also check the Site and System Default report to ensure that the options that you specified are set in the HFPSTL0.

See the following topics for more information:

- For a description of the keywords and parameters that you can specify, see [“Keywords for the FP Site Default Generation utility” on page 98.](#)
- For a sample of the Site and System Default report, see [“Output from the FP Site Default Generation utility” on page 99.](#)

3. Assemble and link-edit the HFPSTL0 source code.

To create the site default table, assemble and link the SYSPUNCH data set that is generated by HFPSTGEN.

Example

The following example shows how to specify the FP Site Default Generation utility JCL to create source code for HFPSTL0.

This sample JCL is provided in the IMS FP Solution Pack product sample JCL data set (SHFPJCL0).

```
//HFPSTL0 JOB
//*-----*
//* JOB NAME = HFPSTL0 *
//*-----*
//* LICENSED MATERIALS - PROPERTY OF IBM *
//* *
//* 5655-W14 *
//* *
//* COPYRIGHT IBM CORP. 2011, 2013 *
//* *
//* THE SOURCE CODE FOR THIS PROGRAM IS NOT PUBLISHED OR *
//* OTHERWISE DIVESTED OF ITS TRADE SECRETS, IRRESPECTIVE *
//* OF WHAT HAS BEEN DEPOSITED WITH THE U.S. COPYRIGHT OFFICE. *
//* *
//*-----*
//*
/*=====
/* Description: This JCL generates a site default module,
/* HFPSTL0, which can be used by FP Stand-alone
/* DB Sensor.
/*
/*=====
/*
/* A) Make the following global changes for this job:
/*
/* 1. Modify the job statement to suit your environment.
/*
/* 2. Substitute your dsname high level qualifier (HLQ) for
/* IMS FP Solution Pack data sets for the string
/* "$hfphlq.SHFPLMD0".
/* 'change $hfphlq.SHFPLMD0 your_hfp_hlq.SHFPLMD0 all'
/*
/* 3. Substitute your dsname high level qualifier (HLQ) for your
/* user library to store the site default module (HFPSTL0)
/* for the string "$hfphlq.userlib".
/* 'change $hfphlq.userlib your_userlib all'
/*
/* 4. Substitute your group-name or unit number for UNIT
/* parameters for the group-name "$sysda", if applicable.
/* 'change $sysda your_sysda all'
/*
/* B) Specify commands and keywords to define the site
/* default values on HFPCRE.HFPSYSIN DD statement.
/*
/* C) Submit the job.
/*
/* D) Confirm all return codes are zero.
/*
/* E) Concatenate your_userlib TO JOBLIB OR STEPLIB.
/*
/*=====
```

Figure 41. JCL for creating the site default table (FP Site Default Generation utility) (Part 1 of 2)

```

/*
//SITEMOD PROC
/*
//HFPCRE EXEC PGM=HFPSTGEN, PARM='GEN', REGION=2M
//STEPLIB DD DISP=SHR, DSN=$hfphlq.SHFPLMD0
//SYSPRINT DD SYSOUT=*
//SYSMSG DD SYSOUT=*
//SYSPUNCH DD DISP=(NEW, PASS, DELETE),
//          SPACE=(TRK, (1, 1)), UNIT=$sysda, DSN=&&SOURCE
/*
//ASM EXEC PGM=ASMA90, PARM='OBJECT, NODECK', COND=(4, LT, HFPCRE)
//SYSLIB DD DISP=SHR, DSN=SYS1.MACLIB
//SYSLIN DD DSN=&&OBJLIB, DISP=(NEW, PASS, DELETE),
//          UNIT=$sysda, SPACE=(TRK, (1, 1))
//SYSPRINT DD SYSOUT=*
//SYSUT1 DD UNIT=$sysda, SPACE=(TRK, (1, 1))
//SYSIN DD DISP=(OLD, DELETE, DELETE), DSN=&&SOURCE
/*
//LKED EXEC PGM=IEWL, COND=(4, LE, ASM)
//SYSPRINT DD SYSOUT=*
//SYSLIN DD DSN=&&OBJLIB, DISP=(OLD, DELETE, DELETE)
//SYSUT1 DD UNIT=$sysda, SPACE=(TRK, (1, 1))
//SYSLMOD DD DISP=OLD, DSN=$hfphlq.userlib(HFPSCTL0)
/*
//          PEND
/*
//*=====
//* <<< DEL/DEF SITE DEFAULT LOAD MODULE LIBRARY >>>
//*=====
//SITECRE EXEC SITEMOD
//HFPCRE.HFPSYSIN DD *
GLOBAL
          ITKBSRVR=FPQSRV01
/*
//*

```

Figure 42. JCL for creating the site default table (FP Site Default Generation utility) (Part 2 of 2)

What to do next

When you code the DB Sensor JCL to run a DB Sensor job, you must concatenate the load module library in which HFPSTL0 resides to the STEPLIB DD of the DB Sensor JCL.

You can always check the options that are set in the site default table by running the FP Site Default Generation utility with the PARM='REPORT' option. When you specify this option, the utility prints the keywords and their parameters that are set in the site default table in the Site and System Default report.

The following example shows how to print the keywords and the parameters that are defined in HFPSTL0.

```

//*=====
//* <<< DEL/DEF SITE DEFAULT LOAD MODULE LIBRARY >>>
//*=====
//HFPREP EXEC PGM=HFPSTGEN, PARM='REPORT', REGION=1M
//STEPLIB DD DISP=SHR, DSN=$hfphlq.SHFPLMD0
//          DD DISP=SHR, DSN=IMSXXA.SDFSRESL
//          DD DISP=SHR, DSN=IMSXXA.PGMLIB
//          DD DISP=SHR, DSN=$hfphlq.userlib
/*
//SYSPRINT DD SYSOUT=*
//SYSMSG DD SYSOUT=*
//*

```

Figure 43. JCL for printing the contents of the site default table (FP Site Default Generation utility)

EXEC and DD statements for the FP Site Default Generation utility

You must include the EXEC statement and appropriate DD statements in your FP Site Default Generation utility JCL.

Subsections:

- “EXEC statement” on page 96

- [“DD statement summary” on page 96](#)
- [“DD statements for input” on page 97](#)
- [“DD statements for output” on page 98](#)

EXEC statement

The EXEC statement must be in the following format:

```
//STEP EXEC PGM=HFPSTGEN,PARM='parameter'
```

where:

PGM

Specifies the FP Site Default Generation program, which is HFPSTGEN.

PARM

Specifies the function to run. Specify either of the following values:

GEN

Generates a site default table.

REPORT

Reports the contents of the site default table.

DD statement summary

The following table summarizes the DD statements for the FP Site Default Generation utility.

Table 10. HFPSTGEN DD statements

DD name	Use	Format	When EXEC PARM='GEN'	When EXEC PARM='REPORT'
STEPLIB	Input	RECFM=U	Required	Required
HFPSYSIN	Input	RECFM=FB LRECL=80	Required	Not applicable
IMSACB, IMSACBA, or IMSACBB	Input	PDS	Optional	Not applicable
MODSTAT	Input	PS	Optional	Not applicable
MODSTAT2	Input	PS	Optional	Not applicable
OLCSTAT	Input	PS	Optional	Not applicable
SYSMSG	Output	RECFM=FBA LRECL=133 BLKSIZE=1330	Required	Required
SYSPRINT	Output	RECFM=FBA LRECL=133 BLKSIZE=1330	Required	Required
SYSPUNCH	Output	RECFM=FB LRECL=80	Required	Not applicable

DD statements for input

Specify the following input DD statements:

STEPLIB DD

This required DD statement specifies the load module library of DB Sensor. You must APF-authorize this library.

When you specify PARM='REPORT' on the EXEC statement, you must also specify the library that contains the site default table module (HFPSCTLO).

HFPSYSIN DD

This DD statement is required when you specify PARM='GEN' on the EXEC statement. This DD statement specifies the HFPSYSIN data set that contains the HFPSYSIN control statement.

IMSACB DD

This optional DD statement specifies the library that contains the DMB for the database. The IMSACB DD statements (IMSACB, IMSACBA, IMSACBB, MODSTAT, MODSTAT2, and OLCSTAT) can be used to identify the active ACB library. When both OLCSTAT or MODSTAT and MODSTAT2 are found, the FP Site Default Generation utility checks the time stamp and determines which one is the latest.

DB Sensor determines the active IMSACB library according to the following rules:

1. Check the IMSACB DD statement in the JCL statement.
2. Check the OLCSTAT DD statement in the JCL statement.
3. Check the MODSTAT and MODSTAT2 DD statements in the JCL statement.
4. Allocate the OLCSTAT data set dynamically and check the OLCSTAT member.
5. Allocate the MODSTAT and MODSTAT2 data sets dynamically and check the MODSTAT and MODSTAT2 members.

If you specify the IMSCATHLQ keyword, IMSACB DD statements are not used. The IMS directory is used instead of the ACB library

IMSACBA DD

This DD statement specifies the library that contains the DMB for the database. This statement must be provided if MODSTAT and MODSTAT2, or the OLCSTAT DD statement is specified.

IMSACBB DD

This DD statement specifies the library that contains the DMB for the database. This statement must be provided if MODSTAT and MODSTAT2, or the OLCSTAT DD statement is specified.

MODSTAT DD

This optional DD statement specifies the MODSTAT data set. When this statement is specified, the IMSACBA and IMSACBB DD statements must be specified instead of the ACBLIB DD statement.

If this statement is not specified in the JCL statement when the data set is required, the data set is allocated dynamically by using a DFSMDA member. You can build the DFSMDA member for the MODSTAT library by using a TYPE=DATABASE statement of the DFSMDA macro.

MODSTAT2 DD

This optional DD statement specifies the MODSTAT2 data set. When this statement is specified, the IMSACBA and IMSACBB DD statements must be specified instead of the ACBLIB DD statement.

If this statement is not specified in the JCL statement when the data set is required, the data set is allocated dynamically by using a DFSMDA member. You can build the DFSMDA member for the MODSTAT2 library by using a TYPE=DATABASE statement of the DFSMDA macro.

OLCSTAT DD

This optional DD statement specifies the OLCSTAT data set. When this statement is specified, the IMSACBA and IMSACBB DD statements must be specified instead of the ACBLIB DD statement.

If this statement is not specified in the JCL statement when the data set is required, the data set is allocated dynamically by using a DFSMDA member. You can build the DFSMDA member for the OLCSTAT library by using a TYPE=DATABASE statement of the DFSMDA macro.

DD statements for output

Specify the following output DD statements:

SYMSMSG DD

This required DD statement specifies the output data set for the messages that will be issued while generating or reporting the site default table. You can specify NULLFILE or DUMMY for this data set.

If you omit this DD statement, it is allocated dynamically with SYSOUT=* and the messages are printed in the SYSOUT data set.

SYSPRINT DD

This required DD statement specifies the output data set for the FP Site Default Generation utility reports. You can specify NULLFILE or DUMMY for this data set.

If you omit this DD statement, it is allocated dynamically with SYSOUT=* and the reports are printed in the SYSOUT data set.

SYSPUNCH DD

This DD statement is required when you specify PARM='GEN' on the EXEC statement. This DD statement specifies the output data set in which the source code for the site default table is generated.

Keywords for the FP Site Default Generation utility

When you create a site default table, you must specify the command, keywords, and parameters in the HFPSYSIN data set and provide the data set to the FP Site Default Generation utility.

The format of the HFPSYSIN data set is the same as the format that you specify for FP Stand-alone DB Sensor JCL. You can use the HFPSYSIN data set that you use for an FP Stand-alone DB Sensor job.

In the site default table, you can set the keywords and their parameters only for the GLOBAL command. If you specify the keywords for the DATABASE command, the FP Site Default Generation utility ignores the DATABASE command keywords.

You can set the following keywords and parameters in the HFPSYSIN data set:

Table 11. Keywords for the FP Site Default Generation utility

Keyword	DB Sensor default value
ADXCFGRP	*NO
DBRC	NO
IMSCATACB_INPUT	CURRENT
IMSCATHLQ	*NO
ITKBSRVR	No default
MSTIMESTAMP	NO
SENSOR_DBREC	YES
SENSOR_UOW	NO
SENSOR_UOW_REPORT	NO
SORTOPT_FILSZ	NONE
TASKNUM	4

Requirement: To create a site default table, you must specify at least one keyword and parameter pair for the GLOBAL command.

Output from the FP Site Default Generation utility

Each FP Site Default Generation utility job generates an Audit report and a Site and System Default report. The following figure shows an example of the Audit report.

```

IMS HPFP UTILITIES - DB SENSOR                "Audit report"                PAGE: 1
5698-FPP V2R1                                2022-10-30 15:50:32

HFPYSIN
0.....1.....2.....3.....4.....5.....6.....7.....8
123456789012345678901234567890123456789012345678901234567890

- 1: GLOBAL
- 2: ITKBSRVR=FPQSRV01
  
```

Figure 44. Audit report (FP Site Default Generation utility)

The following figure shows an example of the Site and System Default report.

```

IMS HPFP UTILITIES - DB SENSOR                "Site and system default report"    PAGE: 1
5698-FPP V2R1                                2022-12-24 15:50:32

SITE DEFAULT MODULE INFORMATION                : HFPSC TL0
- RELEASE LEVEL                               : 210
- CREATE DATE                                 : 12/19/2022
NOTE: '*' MEANS THAT THE VALUE SPECIFIED IS SAME AS SYSTEM DEFAULT VALUE. THE SPECIFICATION IGNORED.
SITE DEFAULT                                  SYSTEM DEFAULT
-----
GLOBAL
ADXCFGRP                                     : *NO
IMSCATACB_INPUT                             : CURRENT
IMSCATHLQ                                    : *NO
ITKBSRVR                                     : FPQSRV01
MSTIMESTAMP                                  : NO
SENSOR_DBREC                                 : YES
SENSOR_UOW                                    : NO
SENSOR_UOW_REPORT                            : NO
SORTOPT_FILSZ                                : NONE
TASKNUM                                       : 4
  
```

Figure 45. Site and System Default report (FP Site Default Generation utility)

Chapter 16. Printing sensor data by using the FP DB Sensor Printing utility

Use the FP DB Sensor Printing utility (HFSPRNT) to print the sensor data that is stored in the IMS Tools KB Sensor Data repository.

The FP DB Sensor Printing utility reads the latest sensor data for the specified DEDB area from the IMS Tools KB Sensor Data repository and prints a Sensor Data Statistics report in the HFSPRT data set.

The HFSPRNT program is distributed in IMS Fast Path Solution Pack, and it processes sensor data that is collected from DEDB areas. If you have both IMS Database Solution Pack and IMS Fast Path Solution Pack or IMS Database Utility Solution and IMS Fast Path Solution Pack, you can retrieve sensor data from full-function databases and DEDBs by using the FP DB Sensor Printing utility (BBESPRNT) that is distributed in IMS Database Solution Pack or IMS Database Utility Solution.

Topics:

- [“Printing a Sensor Data Statistics report ” on page 101](#)
- [“FP DB Sensor Printing utility JCL and control statements” on page 102](#)
- [“Output from the FP DB Sensor Printing utility” on page 104](#)

Printing a Sensor Data Statistics report

To print a Sensor Data Statistics report, code the FP DB Sensor Printing utility JCL and run the job.

Procedure

1. Write the EXEC and the DD statements.

For the format of the EXEC statement and the list of DD statements, see [“EXEC and DD statements for the FP DB Sensor Printing utility” on page 102](#).

2. Specify the GLOBAL command, the DATABASE command, and their keywords in the HFSPRIN DD.

See the following topics for more information:

- For information about the keyword that can be specified for the GLOBAL command, see [“ GLOBAL command keyword for the FP DB Sensor Printing utility” on page 104](#).
- For information about the keywords that can be specified for the DATABASE command, see [“DATABASE command keywords for the FP DB Sensor Printing utility” on page 104](#).

3. Run the FP DB Sensor Printing utility (HFSPRNT) job step to print the report.

Ensure that the return code is 0.

For a sample of the Sensor Data Statistics report, see [“Sensor Data Statistics report from the FP DB Sensor Printing utility” on page 105](#).

Example

The following example shows how to specify the FP DB Sensor Printing utility JCL.

```

//HFSPRNT JOB CLASS=A
//HFSPRNT JOB CLASS=A
//PGM1 EXEC PGM=HFSPRNT
//STEPLIB DD DISP=SHR,DSN=fp_solution_pack_load_module_library
// DD DISP=SHR,DSN=IMS_Tools_Base_load_module_library
//RECON1 DD DISP=SHR,DSN=recon1_data_set_name
//HFSPRNT DD SYSOUT=*
//HFPSOUT DD SYSOUT=*
//HFSPRIN DD *
GLOBAL ITKBSRVR=FPQSVRDM
DATABASE DBD=DEDB0001,AREA=AREA0001
/*

```

Figure 46. FP DB Sensor Printing utility JCL

FP DB Sensor Printing utility JCL and control statements

Input for the FP DB Sensor Printing utility consists of JCL statements that satisfy the JCL requirements and that conform to the required control statement format.

EXEC and DD statements for the FP DB Sensor Printing utility

You must include the EXEC statement and appropriate DD statements in your FP DB Sensor Printing utility JCL.

Subsections:

- [“EXEC statement” on page 102](#)
- [“DD statement summary” on page 102](#)
- [“DD statements for input” on page 102](#)
- [“DD statements for output” on page 103](#)

EXEC statement

The EXEC statement must be in the following format:

```
//STEP EXEC PGM=HFSPRNT
```

where PGM specifies the FP DB Sensor Printing program, which is HFSPRNT.

DD statement summary

The following table summarizes the DD statements for the FP DB Sensor Printing utility.

Table 12. HFSPRNT DD statements

DD name	Use	Required or optional	Format
STEPLIB	Input	Required	RECFM=U
RECON1	Input	Optional	
HFSPRIN	Input	Required	RECFM=FB,LRECL=80
HFPSOUT	Output	Required	RECFM=FBA,LRECL=133
HFSPRNT	Output	Required	RECFM=FBA,LRECL=133

DD statements for input

Specify the following input DD statements:

STEPLIB DD

This required DD statement specifies the load module library of DB Sensor. You do not need to APF-authorize this library.

RECON1 DD

Specify the RECON1 data set name that was used when sensor data was stored. If you do not specify the correct name, the utility cannot find the sensor data.

HFSPRIN DD

This DD statement is required. This DD statement specifies the HFSPRIN data set that contains the HFSPRIN control statement.

DD statements for output

Specify the following output DD statements:

HFPSOUT DD

This required DD statement specifies the output data set for the FP DB Sensor Printing utility reports and messages. If you omit HFPSOUT DD, this DD is allocated dynamically with SYSOUT=* and the reports and messages are printed in the SYSOUT data set.

HFSPRT DD

This required DD statement specifies the output data set for the FP DB Sensor Printing utility reports. If you omit HFSPRT DD, this DD is allocated dynamically with SYSOUT=* and the reports are printed in the SYSOUT data set.

Format of the HFSPRIN control statement

The HFSPRIN control statement defines the user description of the GLOBAL command and the DATABASE command, both of which control the behavior of the FP DB Sensor Printing utility process.

You must specify the commands and their keywords in the HFSPRIN data set. This data set usually resides in the input stream. However, it can also be defined as a sequential data set or as a member of a partitioned data set. It must contain 80-byte, fixed-length records. BLKSIZE, if coded, must be a multiple of 80.

An HFSPRIN control statement must conform to the following format:

GLOBAL command

- Only one GLOBAL command can be specified.
- The GLOBAL command keyword and its parameter follow the GLOBAL command.
- A GLOBAL command keyword and its parameter must be connected with an equal sign (=).
- A line that starts with an asterisk (*) is treated as a comment line.
- The first column must be blank.

DATABASE command

- Only one DATABASE command can be specified.
- The DATABASE command keywords and their parameters follow the DATABASE command.
- A DATABASE command keyword and its parameter must be connected with an equal sign (=).
- Multiple keyword and parameter pairs can be specified.

Keyword and parameter pairs can span more than one line; type a comma as a continuation character at the end of the first line, and continue the next keyword and parameter pair on the next line.

- A line that starts with an asterisk (*) is treated as a comment line.
- The first column must be blank.

GLOBAL command keyword for the FP DB Sensor Printing utility

The GLOBAL command keyword specifies the XCF group name of IMS Tools Knowledge Base. You must specify the GLOBAL command and its keyword in the HFSPRIN DD.

ITKBSRVR=

This keyword specifies the IMS Tools KB XCF group name (IMS Tools KB server name). The sensor data is retrieved from the IMS Tools Knowledge Base repositories that are managed by this IMS Tools KB server. This keyword is required, and you must supply an IMS Tools KB XCF group name.

DATABASE command keywords for the FP DB Sensor Printing utility

The DATABASE command keywords specify the database to process. You must specify the DATABASE command and its keywords in the HFSPRIN DD.

The FP DB Sensor Printing utility generates a report about the latest sensor data that is collected from the target resource (database and area) that is specified by the DATABASE command.

DBD=

This required keyword specifies the DBD name that you want to retrieve sensor data from. You can specify only one DBD name.

IAREA=

This required keyword specifies the DEDB area name. You can specify only one area name.

UOW_REPORT=

This keyword specifies whether to print the sensor data that is related to UOW in the HFSPRRT data set. If you omit this keyword, UOW_REPORT=NO is used as the default value.

YES

Prints the sensor data that is related to UOW in the HFSPRRT data set.

NO

Does not print the sensor data that is related to UOW.

Note: The sensor data that is related to UOW is not printed when such data is not stored in the Sensor Data repository.

Output from the FP DB Sensor Printing utility

An FP DB Sensor Printing utility job generates a Runtime Summary report and a Sensor Data Statistics report.

Runtime Summary report from the FP DB Sensor Printing utility

The Runtime Summary report contains summary information about the FP DB Sensor Printing utility job. This report is printed in the HFPSOUT data set.

Sample report

The following figure shows an example of the Runtime Summary report.

```
"CONTROL STATEMENTS"
0. ....1. ....2. ....3. ....4. ....5. ....6. ....7. ....8
1234567890123456789012345678901234567890123456789012345678901234567890

GLOBAL ITKBSRVR=FPQSVRDM
DATABASE DBD=DEDB0001,AREA=AREA0001

"RUNTIME OPTIONS"

KEYWORD          RUNTIME OPTIONS FOR THIS STEP
-----
ITKBSRVR         FPQSVRDM
DBD              DEDB0001
IAREA           AREA0001
UOW_REPORT      NO

"MESSAGES"
HFPO1101I SENSOR DATA READING STARTED FOR DATABASE DEDB0001, AREA AREA0001
HFPO1105I SENSOR DATA LOCALE=RECON ID:$IVP , RECON DATA SET NAME=TEMPDS.IVP.RECON1
HFPO1102I SENSOR DATA READING ENDED FOR DATABASE DEDB0001, AREA AREA0001, RSI=00C7F425AB17545940000000012B0000
HFPO1103I SENSOR DATA STATISTICS REPORT GENERATION STARTED FOR DATABASE DEDB0001, AREA AREA0001
HFPO1104I SENSOR DATA STATISTICS REPORT GENERATION ENDED FOR DATABASE DEDB0001, AREA AREA0001
```

Figure 47. Runtime Summary report (FP DB Sensor Printing utility)

Report field descriptions

This report provides the following information:

CONTROL STATEMENTS

This part shows an echo of the control statements that you specified in the HFPSPRIN data sets. If any errors were found while FP DB Sensor Printing utility reads the control statements, error messages are also displayed in this part.

RUNTIME OPTIONS

This part shows the options that were applied at run time.

MESSAGES

This part shows the processing messages.

Sensor Data Statistics report from the FP DB Sensor Printing utility

The Sensor Data Statistics report contains the value of sensor data. This report is printed in the HFPSPT data set.

This report contains the data element names and their values. For the definitions of these data elements, see the topics about data elements in the *IMS Tools Base Policy Services User's Guide*.

The number of data elements in the report differs based on the sensor data that is stored in the Sensor Data repository and the UOW_REPORT keyword specification in the JCL.

The following figures show an example of the Sensor Data Statistics report when UOW-related sensor data is not stored in the Sensor Data repository, or when UOW_REPORT=NO is specified.

DBD NAME: DEDBJN21, AREA NAME: DB21AR0

Collected on 10/29/2022 17.05.05

```
=====
AREA DEFINITION
=====
Data Element Name          Value
-----
DB_AREAEDEF_CISIZE        1,024
DB_AREAEDEF_UOW1          15
DB_AREAEDEF_UOW2          10
DB_AREAEDEF_ROOT1         10
DB_AREAEDEF_ROOT2         5
DB_AREAEDEF_NUM_SDEP_CIS  64

=====
FREE SPACE PERCENTAGE STATISTICS
=====
Data Element Name          Value
-----
DB_PCT_BYTES_FS_RAA        96%
DB_PCT_BYTES_FS_DOVF       81%
DB_PCT_BYTES_FS_IOVF       96%
DB_PCT_BYTES_FS_SDEP       52%

=====
OVERFLOW USAGE STATISTICS
=====
Data Element Name          Value
-----
DB_PCT_NUM_UOW_USE_DOVF    20%
DB_AVG_NUM_DOVFCI_BY_UOW   10.00
DB_MAX_NUM_DOVFCI_BY_UOW   10
DB_PCT_NUM_UOW_USE_IOVF    20%
DB_NUM_UOW_USE_IOVF        1
DB_AVG_NUM_IOVFCI_BY_UOW   3.00
DB_MAX_NUM_IOVFCI_BY_UOW   3
DB_MIN_NUM_IOVFCI_BY_UOW   3
DB_PCT_NUM_IOVFCI_USED     5%
DB_PCT_NUM_RAPCI_OVFL      100%

=====
SEGMENT OCCURRENCE STATISTICS
=====
Data Element Name          Value
-----
DB_NUM_SEG                  130
```

Figure 48. Sensor Data Statistics report when UOW-related sensor data is not stored or UOW_REPORT=NO (FP DB Sensor Printing utility) (Part 1 of 2)

DBD NAME: DEDBJN21, AREA NAME: DB21AR0

Collected on 10/29/2022 17.05.05

```

=====
DATABASE RECORD STATISTICS
=====
Data Element Name          Value
-----
DB_NUM_ROOT                120
DB_AVG_DBREC_LENGTH        106.00
DB_MAX_DBREC_LENGTH        582
DB_MIN_DBREC_LENGTH        102
DB_PCT_NUM_DBREC_IOVF      18%

=====
RANDOMIZING STATISTICS
=====
Data Element Name          Value
-----
DB_AVG_LEN_SYNONYM_CHAIN   120.00
DB_MAX_LEN_SYNONYM_CHAIN   120

=====
PHYSICAL I/O STATISTICS
=====
Data Element Name          Value
-----
DB_ESTIMATED_DBREC_IO      26.00
DB_ESTIMATED_ROOT_IO      26.00
DB_AVG_DBREC_IO            7.06
DB_MAX_DBREC_IO            13
DB_AVG_ROOT_IO             7.06
DB_MAX_ROOT_IO             13

=====
UOW STATISTICS INFORMATION
=====
Data Element Name          Value
-----
DB_FLAG_UOW_DATA           N
DB_FLAG_UOW_GROUP_DATA     N
DB_NUM_UOW_GROUPS          n/a
DB_THRESHOLD_RBASEFS       30%
DB_THRESHOLD_RDOVFFS       50%
DB_NUM_UOW_RFS_COND        50
DB_PCT_NUM_UOW_RFS_COND    10%

=====
REPOSITORY GROUP INFORMATION
=====
Data Element Name          Value
-----
DB_SENSOR_DATA_GROUP_ID    n/a

```

Figure 49. Sensor Data Statistics report when UOW-related sensor data is not stored or UOW_REPORT=NO (FP DB Sensor Printing utility) (Part 2 of 2)

The following figures show another example of the Sensor Data Statistics report. In this report, logical pages 3 and 4 contain data element values for the first UOW in the area that is specified by the IAREA keyword. This report is printed if all of the following conditions are met:

- UOW_REPORT=YES is specified
- UOW-related sensor data exists in the Sensor Data repository
- HFP AUOWC DD statement was not specified in the job that collected and stored the sensor data

In actual reports, data element values for other UOWs are printed in the subsequent pages.

DBD NAME: DEDBJN21, AREA NAME: DB21AR0

Collected on 10/29/2022 17.05.05

```

=====
AREA DEFINITION
=====
Data Element Name          Value
-----
DB_AREAEDEF_CISIZE        1,024
DB_AREAEDEF_UOW1          15
DB_AREAEDEF_UOW2          10
DB_AREAEDEF_ROOT1         10
DB_AREAEDEF_ROOT2         5
DB_AREAEDEF_NUM_SDEP_CIS  64
=====

FREE SPACE PERCENTAGE STATISTICS
=====
Data Element Name          Value
-----
DB_PCT_BYTES_FS_RAA        96%
DB_PCT_BYTES_FS_DOVF       81%
DB_PCT_BYTES_FS_IOVF       96%
DB_PCT_BYTES_FS_SDEP       52%
=====

OVERFLOW USAGE STATISTICS
=====
Data Element Name          Value
-----
DB_PCT_NUM_UOW_USE_DOVF    20%
DB_AVG_NUM_DOVFCI_BY_UOW   10.00
DB_MAX_NUM_DOVFCI_BY_UOW   10
DB_PCT_NUM_UOW_USE_IOVF    20%
DB_NUM_UOW_USE_IOVF        1
DB_AVG_NUM_IOVFCI_BY_UOW   3.00
DB_MAX_NUM_IOVFCI_BY_UOW   3
DB_MIN_NUM_IOVFCI_BY_UOW   3
DB_PCT_NUM_IOVFCI_USED     5%
DB_PCT_NUM_RAPCI_OVFL     100%
=====

SEGMENT OCCURRENCE STATISTICS
=====
Data Element Name          Value
-----
DB_NUM_SEG                  130
=====

```

Figure 50. Sensor Data Statistics report when UOW_REPORT=YES and sensor data for all UOWs is stored (FP DB Sensor Printing utility) (Part 1 of 4)

DBD NAME: DEDBJN21, AREA NAME: DB21AR0

Collected on 10/29/2022 17.05.05

=====

DATABASE RECORD STATISTICS

=====

Data Element Name	Value
DB_NUM_ROOT	120
DB_AVG_DBREC_LENGTH	106.00
DB_MAX_DBREC_LENGTH	582
DB_MIN_DBREC_LENGTH	102
DB_PCT_NUM_DBREC_IOVF	18%

=====

RANDOMIZING STATISTICS

=====

Data Element Name	Value
DB_AVG_LEN_SYNONYM_CHAIN	120.00
DB_MAX_LEN_SYNONYM_CHAIN	120

=====

PHYSICAL I/O STATISTICS

=====

Data Element Name	Value
DB_ESTIMATED_DBREC_IO	26.00
DB_ESTIMATED_ROOT_IO	26.00
DB_AVG_DBREC_IO	7.06
DB_MAX_DBREC_IO	13
DB_AVG_ROOT_IO	7.06
DB_MAX_ROOT_IO	13

=====

UOW STATISTICS INFORMATION

=====

Data Element Name	Value
DB_FLAG_UOW_DATA	Y
DB_FLAG_UOW_GROUP_DATA	N
DB_NUM_UOW_GROUPS	n/a
DB_THRESHOLD_RBASEFS	30%
DB_THRESHOLD_RDOVFFS	50%
DB_NUM_UOW_RFS_COND	50
DB_PCT_NUM_UOW_RFS_COND	10%

=====

REPOSITORY GROUP INFORMATION

=====

Data Element Name	Value
DB_SENSOR_DATA_GROUP_ID	MYID

Figure 51. Sensor Data Statistics report when UOW_REPORT=YES and sensor data for all UOWs is stored (FP DB Sensor Printing utility) (Part 2 of 4)

DBD NAME: DEDBJN21, AREA NAME: DB21AR0, UOW NUMBER: 0 Collected on 10/29/2022 17.05.05

=====

FREE SPACE PERCENTAGE STATISTICS

=====

Data Element Name	Value
DBU_PCT_BYTES_FS_RAA	80%
DBU_PCT_BYTES_FS_DOVF	80%
DBU_PCT_BYTES_FS_IOVF	95%
DBU_PCT_USABLE_RAAFS	80%
DBU_PCT_USABLE_DOVFFS	80%
DBU_PCT_USABLE_IOVFFS	95%
DBU_PCT_RAP_ROOTSZFS	0%
DBU_MAX_PCT_BYTES_RAPFS	0%
DBU_FLAG_UOW_USING_OVFL	Y
DBU_FLAG_UOW_USING_IOVF	Y

=====

OVERFLOW USAGE STATISTICS

=====

Data Element Name	Value
DBU_NUM_DOVFCT_BY_UOW	10
DBU_NUM_IOVFCT_BY_UOW	3
DBU_PCT_NUM_RAPCT_OVFL	100%

=====

DATABASE RECORD STATISTICS

=====

Data Element Name	Value
DBU_NUM_ROOT	120
DBU_AVG_DBREC_LENGTH	106.00
DBU_MAX_DBREC_LENGTH	582
DBU_MIN_DBREC_LENGTH	102
DBU_PCT_NUM_DBREC_IOVF	18%

Figure 52. Sensor Data Statistics report when UOW_REPORT=YES and sensor data for all UOWs is stored (FP DB Sensor Printing utility) (Part 3 of 4)

DBD NAME: DEDBJN21, AREA NAME: DB21AR0, UOW NUMBER: 0 Collected on 10/29/2022 17.05.05

=====

RANDOMIZING STATISTICS

=====

Data Element Name	Value
DBU_AVG_LEN_SYN_CHAIN	120.00
DBU_MAX_LEN_SYN_CHAIN	120

=====

PHYSICAL I/O STATISTICS

=====

Data Element Name	Value
DBU_AVG_DBREC_IO	7.06
DBU_MAX_DBREC_IO	13
DBU_AVG_ROOT_IO	7.06
DBU_MAX_ROOT_IO	13

Figure 53. Sensor Data Statistics report when UOW_REPORT=YES and sensor data for all UOWs is stored (FP DB Sensor Printing utility) (Part 4 of 4)

The following figures show another example of the Sensor Data Statistics report. In this report, logical pages 3 and 4 contain data element values for a UOW group that was specified by the HFP AUOWC DD statement in the job that collected and stored the sensor data. This report is printed if all of the following conditions are met:

- UOW_REPORT=YES is specified
- UOW-related sensor data exists in the Sensor Data repository
- HFP AUOWC DD statement was specified in the job that collected and stored the sensor data

In actual reports, if multiple UOW groups are specified, data element values for other UOW groups are printed in the subsequent pages.

DBD NAME: DEDBJN21, AREA NAME: DB21AR0

Collected on 10/29/2022 17.05.05

=====
AREA DEFINITION
=====

Data Element Name	Value
DB_AREAEDEF_CISIZE	1,024
DB_AREAEDEF_UOW1	15
DB_AREAEDEF_UOW2	10
DB_AREAEDEF_ROOT1	10
DB_AREAEDEF_ROOT2	5
DB_AREAEDEF_NUM_SDEP_CIS	64

=====
FREE SPACE PERCENTAGE STATISTICS
=====

Data Element Name	Value
DB_PCT_BYTES_FS_RAA	96%
DB_PCT_BYTES_FS_DOVF	81%
DB_PCT_BYTES_FS_IOVF	96%
DB_PCT_BYTES_FS_SDEP	52%

=====
OVERFLOW USAGE STATISTICS
=====

Data Element Name	Value
DB_PCT_NUM_UOW_USE_DOVF	20%
DB_AVG_NUM_DOVFCI_BY_UOW	10.00
DB_MAX_NUM_DOVFCI_BY_UOW	10
DB_PCT_NUM_UOW_USE_IOVF	20%
DB_NUM_UOW_USE_IOVF	1
DB_AVG_NUM_IOVFCI_BY_UOW	3.00
DB_MAX_NUM_IOVFCI_BY_UOW	3
DB_MIN_NUM_IOVFCI_BY_UOW	3
DB_PCT_NUM_IOVFCI_USED	5%
DB_PCT_NUM_RAPCI_OVFL	100%

=====
SEGMENT OCCURRENCE STATISTICS
=====

Data Element Name	Value
DB_NUM_SEG	130

Figure 54. Sensor Data Statistics report when UOW_REPORT=YES and sensor data for a UOW range is stored (FP DB Sensor Printing utility) (Part 1 of 4)

DBD NAME: DEDBJN21, AREA NAME: DB21AR0

Collected on 10/29/2022 17.05.05

=====

DATABASE RECORD STATISTICS

=====

Data Element Name	Value
DB_NUM_ROOT	120
DB_AVG_DBREC_LENGTH	106.00
DB_MAX_DBREC_LENGTH	582
DB_MIN_DBREC_LENGTH	102
DB_PCT_NUM_DBREC_IOVF	18%

=====

RANDOMIZING STATISTICS

=====

Data Element Name	Value
DB_AVG_LEN_SYNONYM_CHAIN	120.00
DB_MAX_LEN_SYNONYM_CHAIN	120

=====

PHYSICAL I/O STATISTICS

=====

Data Element Name	Value
DB_ESTIMATED_DBREC_IO	26.00
DB_ESTIMATED_ROOT_IO	26.00
DB_AVG_DBREC_IO	7.06
DB_MAX_DBREC_IO	13
DB_AVG_ROOT_IO	7.06
DB_MAX_ROOT_IO	13

=====

UOW STATISTICS INFORMATION

=====

Data Element Name	Value
DB_FLAG_UOW_DATA	N
DB_FLAG_UOW_GROUP_DATA	Y
DB_NUM_UOW_GROUPS	1
DB_THRESHOLD_RBASEFS	30%
DB_THRESHOLD_RDOVFFS	50%
DB_NUM_UOW_RFS_COND	50
DB_PCT_NUM_UOW_RFS_COND	10%

=====

REPOSITORY GROUP INFORMATION

=====

Data Element Name	Value
DB_SENSOR_DATA_GROUP_ID	n/a

Figure 55. Sensor Data Statistics report when UOW_REPORT=YES and sensor data for a UOW range is stored (FP DB Sensor Printing utility) (Part 2 of 4)

DBD NAME: DEDBJN21, AREA NAME: DB21AR0 , UOW GROUP (STARTUOW: 1, STOPUOW: 3) Collected on 10/29/2022 17.05.05

=====

FREE SPACE PERCENTAGE STATISTICS

=====

Data Element Name	Value
DEBUG_PCT_BYTES_FS_RAA	80%
DEBUG_PCT_BYTES_FS_DOVDF	80%
DEBUG_PCT_BYTES_FS_IOVDF	95%
DEBUG_PCT_USABLE_RAAFS	80%
DEBUG_PCT_USABLE_DOVFFS	80%
DEBUG_PCT_USABLE_IOVFFS	95%
DEBUG_PCT_RAP_ROOTSZFS	0%

=====

OVERFLOW USAGE STATISTICS

=====

Data Element Name	Value
DEBUG_PCT_NUM_UOW_DOVDF	80%
DEBUG_AVG_NUM_DOVFCI	5
DEBUG_MAX_NUM_DOVFCI	10
DEBUG_PCT_NUM_UOW_IOVDF	80%
DEBUG_AVG_NUM_IOVFCI	10
DEBUG_MAX_NUM_IOVFCI	50
DEBUG_PCT_NUM_RAPCI_OVFL	100%

=====

DATABASE RECORD STATISTICS

=====

Data Element Name	Value
DEBUG_NUM_ROOT	120
DEBUG_AVG_DBREC_LENGTH	106.00
DEBUG_MAX_DBREC_LENGTH	582
DEBUG_MIN_DBREC_LENGTH	102
DEBUG_PCT_NUM_DBREC_IOVDF	18%

Figure 56. Sensor Data Statistics report when UOW_REPORT=YES and sensor data for a UOW range is stored (FP DB Sensor Printing utility) (Part 3 of 4)

DBD NAME: DEDBJN21, AREA NAME: DB21AR0 , UOW GROUP (STARTUOW: 1, STOPUOW: 3) Collected on 10/29/2022 17.05.05

=====

RANDOMIZING STATISTICS

=====

Data Element Name	Value
DEBUG_AVG_LEN_SYN_CHAIN	120.00
DEBUG_MAX_LEN_SYN_CHAIN	120

=====

PHYSICAL I/O STATISTICS

=====

Data Element Name	Value
DEBUG_AVG_DBREC_IO	7.06
DEBUG_MAX_DBREC_IO	13
DEBUG_AVG_ROOT_IO	7.06
DEBUG_MAX_ROOT_IO	13

Figure 57. Sensor Data Statistics report when UOW_REPORT=YES and sensor data for a UOW range is stored (FP DB Sensor Printing utility) (Part 4 of 4)

Part 4. Using Stand-alone Recovery Sensor

Stand-alone Recovery Sensor (also referred to as Recovery Sensor) can collect statistics from the content of DBRC RECON data sets.

The following topics explain how to use Recovery Sensor.

Topics:

- [Chapter 17, “Overview of Recovery Sensor,” on page 117](#)
- [Chapter 18, “Running Recovery Sensor,” on page 119](#)
- [Chapter 19, “Recovery Sensor JCL and control statements,” on page 121](#)
- [Chapter 20, “Output from Recovery Sensor,” on page 127](#)

Chapter 17. Overview of Recovery Sensor

You can use Stand-alone Recovery Sensor to collect sensor data from the content of DBRC RECON data sets.

Recovery Sensor runs as a batch job step of z/OS.

Support for recovery autonomies

The Recovery Sensor is a critical component in supporting passive recovery autonomies for IMS database backup and recovery preparedness provided in IMS Recovery Solution Pack V2.1 and later.

The data collected by Recover Sensor is used by Autonomics Director to monitor and maintain the image copy, change accumulation, and recoverability of the database.

Basic function

Recovery Sensor scans the content of DBRC RECON data sets and collects database statistics including data about individual databases, HALDB partitions, FP Areas, and Change Accumulation Groups. IMS Recovery Expert System Level Backups (SLB) can also be used to discover available image copies.

Then it organizes the statistics into sensor data, and stores the sensor data in the IMS Tools Knowledge Base Sensor Data repository in the form of records that are comprised of data elements. When Recover Sensor completes storing the sensor data in the repository, it notifies the Autonomics Director server that the sensor data is available so that the new data can be immediately analyzed and evaluated if necessary.

Policy, rule, and repository support for the recovery domain used by recovery autonomies is provided by the Policy Services and IMS Tools Knowledge Base components of IBM IMS Tools Base 1.6 and later.

For a list of the data elements that are collected by Recovery Sensor, see the topics about data elements in the *IMS Tools Base Policy Services User's Guide*.

During the job, Recovery Sensor prints a runtime summary report to the IROSPRT DD. The report contains the extracted sensor values in table format and is designed for technical analysis only.

Basic characteristics

Recovery Sensor has the following characteristics:

- Recovery Sensor can process online IMS databases
- One Recovery Sensor job can process multiple databases and partitions.
- Recovery Sensor can process both offline DEDB areas and online DEDB areas
- One Recovery Sensor job can process multiple DEDB area data sets

The maximum number of area data sets is 2048

- Recovery Sensor uses high performance I/O techniques to reduce the amount of time that is required to scan area data sets
- For HALDB, Recovery Sensor processes only the active side (A or M side) of data sets.

Restriction: Recovery Sensor does not support HALDB partitions when the partition is under online reorganization processing or online reorganization suspended, that is, when OLR cursor active.

How sensor data is used in the autonomies process

Sensor data is the information collected by a sensor utility when, at an instance in time, it scans one or more IMS database environments and measures the specified conditions (or states) occurring in those environments.

Fast Path and Full-Function Sensor utilities function in an IMS Tools space management and reorganization domain and capture statistics about the characteristics and organization of data in each database. Information is also collected from the system catalog, VSAM catalog, and Volume Table of Contents (VTOC).

The Recovery Sensor utility functions in an IMS Tools recovery domain and captures information from the content of DBRC RECON data sets. Data is gathered about individual databases, HALDB partitions, Fast Path areas, and change accumulation groups.

Sensor data is stored in the IMS Tools Knowledge Base Sensor Data repository in the form of records made up of data element values. The data record is stored in a well-understood and flexible format that allows its use for years and multiple product releases later in time. The data and its format is understandable between products and releases to ensure reliable functionality. The data can then be used for later database analysis and tuning purposes.

Autonomics Director jobs can use sensor data to monitor and maintain the health, performance, and recoverability of the database. In the Autonomics Director jobs, Policy Services evaluation is internally called to evaluate the database state based on the stored sensor data.

When the jobs end, you can use IMS Administration Foundation or Management Console to view graphical visualization and charting of the sensor data, the exceptions that were detected by the policy evaluations, and the recommendations for resolving the exceptions.

Chapter 18. Running Recovery Sensor

To run Recovery Sensor, code Recovery Sensor JCL statements and submit the job.

Before you begin

Recovery Sensor is delivered with the IMS Recovery Solution Pack as part of the IMS Database Recovery Facility Extended Functions component.

Before you submit your Recovery Sensor job, ensure that the IMS Tools Knowledge Base server and all the repositories, including the Sensor Data repository, are available.

Optionally, start the Autonomics Director servers if you want to run Recovery Sensor and a policy evaluation by using the Autonomics Director scheduling calendar. To start Autonomics Director servers, see the *IMS Tools Base Autonomics Director User's Guide*.

Procedure

1. Write the EXEC and the DD statements.

See [“EXEC and DD statements for Recovery Sensor” on page 121](#) for information about the format of the EXEC statement and the input and the output DD statements.

2. Specify the GLOBAL command and keywords in the IROSIN DD.

The GLOBAL command controls the behavior of the Recovery Sensor job.

If IMS Recovery Expert System Level Backups (SLB) are available, the Recovery Sensor can determine if a more recent backup of a specified database, partition, or area is available in the IMS catalog.

This option can be activated by specifying USESLBIC=Y on the GLOBAL command.

Detailed information about System Level Backup configuration and processing can be found in *IMS Recovery Solution Pack: IMS Database Recovery Facility User's Guide*.

See [“GLOBAL command keywords for Recovery Sensor” on page 125](#) for information about the keywords that can be specified for the GLOBAL command.

3. Specify the DATABASE command and keywords in the IROSIN DD.

The DATABASE command specifies the DEDB areas to process.

See [“DATABASE command keywords for Recovery Sensor” on page 125](#) for information about the keywords that can be specified for the DATABASE command.

4. Specify the CA command and keywords in the IROSIN DD.

The CA command specifies change accumulation groups to process.

See [“CA command keywords for Recovery Sensor” on page 126](#) for information about the keywords that can be specified for the CA command.

5. Submit the job.

Ensure that the return code is 0.

If the return code is other than 0, check the write-to-operator (WTO) messages or the messages that are printed in the IROSPRNT data set, and take the appropriate actions by referring to the troubleshooting information.

Chapter 19. Recovery Sensor JCL and control statements

Input for Recovery Sensor consists of JCL statements that satisfy the JCL requirements and that conform to the required control statement format.

Topics:

- [“EXEC and DD statements for Recovery Sensor” on page 121](#)
- [“Format of the IROSIN control statement” on page 123](#)
- [“GLOBAL command keywords for Recovery Sensor” on page 125](#)
- [“DATABASE command keywords for Recovery Sensor” on page 125](#)
- [“CA command keywords for Recovery Sensor” on page 126](#)
- [“JCL examples for Recovery Sensor” on page 126](#)

EXEC and DD statements for Recovery Sensor

You must include the EXEC statement and appropriate DD statements in your Stand-alone Recovery Sensor JCL.

Subsections:

- [“EXEC statement” on page 121](#)
- [“DD statement summary” on page 121](#)
- [“DD statement reference for input” on page 122](#)
- [“DD statement reference for output” on page 122](#)

EXEC statement

The EXEC statement must be in the following format:

```
//STEP EXEC PGM=IROSENSR,PARM='IMSPLEX=imsplex,DBRCGRP=dbrcgrp'
```

where:

PGM

Specifies the Stand-alone Recovery Sensor program, which is IROSENSR.

PARM

Specifies optional parameters for the DBRC interface.

For information about specifying the PARM parameter, see *IMS System Programming APIs* for the version of IMS that you are using.

DD statement summary

The following table summarizes the DD statements for Stand-alone Recovery Sensor.

Table 13. IROSENSR DD statements

DD name	Use	Required or optional	Format
STEPLIB	Input	Required	RECFM=U
IROSIN	Input	Required	RECFM=FB,LRECL=80

Table 13. IROSENSR DD statements (continued)

DD name	Use	Required or optional	Format
RECON[1 2 3]	Input	Optional	VSAM
IMSDALIB	Input	Optional	RECFM=U
IROSPRT	Output	Required	RECFM=FBA,LRECL=133
SYSUDUMP	Output	Optional	RECFM=FBA,LRECL=133
IROSNAP	Output	Optional	RECFM=F,LRECL=125

DD statement reference for input

STEPLIB DD

This required DD statement specifies the following load module libraries. All of these libraries must be APF-authorized.

- IMS Recovery Solution Pack product load module library (SFRXLOAD data set, which includes Recovery Sensor)
- Recovery Sensor site default library
- IMS RESLIB, IMS user exit library (randomizer), and DFSMDA members
- SCI exit library for parallel RECON access (if used)
- IMS Tools Base product library (SHKTLOAD and SFOILOAD data sets)

IROSIN DD

This required DD statement specifies the input data set that contains the input control statements to specify the Recovery Sensor runtime options.

For details about the control statement format, commands, and keywords, see the following topics:

- [“Format of the IROSIN control statement” on page 123](#)
- [“GLOBAL command keywords for Recovery Sensor” on page 125](#)
- [“DATABASE command keywords for Recovery Sensor” on page 125](#)
- [“CA command keywords for Recovery Sensor” on page 126](#)

RECON[1 2 3] DD

These optional DD statements specify the RECON1, RECON2, and RECON3 data sets for DBRC.

You can omit these DD statements if the DFSMDA member is included in the STEPLIB DD.

IMSDALIB DD

This optional DD statement specifies an unauthorized load library for loading the DFSMDA members for RECON1, RECON2, RECON3.

DD statement reference for output

IROSPRT DD

This required DD statement specifies the output data set for the Recovery Sensor reports.

For details about the Recovery Sensor reports that are generated in the IROSPRT data set, see [Chapter 20, “Output from Recovery Sensor,” on page 127](#).

An additional feature of the Recovery Sensor is to provide built-in control card syntax and keywords when a control card error is encountered. Sample output is provided below:

Note: In this example, IROSPADF is the name of the BPE control statement dictionary and can be valid for problem solving.

```
Control Card Syntax for IROSPADF

GLOBAL                                (Req) Repeating
(
  ADXCFGRP=Adxcfgrp                    (Req) 8 Char
  ITKBSRVR=Itkbsrvr                    (Req) 8 Char
  USESLBIC=Y | N                        (Opt) 1 Char
)

DATABASE                               (Opt) Repeating
(
  DBD=Db                                (Req) 8 Char
  PART=Part                              (Opt) 8 Char
  AREA=Area                              (Opt) 8 Char
  TYPE=F | D | H                        (Opt) 1 Character
  DBSENSOR                               (Opt) Repeating
  (
    DDN=Ddname                          (Req) 8 Char
    NAME=Name                            (Req) 24 Char
    VALUE=Value                          (Opt) 22 CharLL
    HEXVALUE=Hexvalue                    (Opt) 22 Hex
    HEXLEN=Hexlen                        (Opt) Decimal
  )
)

CA                                     (Opt) Repeating
(
  GROUP=Group                           (Req) 8 Char
  CASENSOR                               (Opt) Repeating
  (
    NAME=Name                            (Req) 24 Char
    VALUE=Value                          (Opt) 22 CharLL
    HEXVALUE=Hexvalue                    (Opt) 22 Hex
    HEXLEN=Hexlen                        (Opt) Decimal
  )
)
)
```

SYSUDUMP DD

This optional DD statement defines the output for a system ABEND dump routine.

Specify this DD statement if you want to generate a dump.

IROSNAP DD

This optional DD contains the hexadecimal print of the main control block built by the control statements.

It is intended for debugging purposes and should only be coded when requested by IBM Software Support.

Format of the IROSIN control statement

The IROSIN control statement defines the user description of the GLOBAL command and the DATABASE command, both of which control the behavior of the Recovery Sensor process.

The commands and their keywords must be specified in the IROSIN data set. This data set usually resides in the input stream.

However, it can also be defined as a sequential data set or as a member of a partitioned data set. It must contain 80-byte, fixed-length records. BLKSIZE, if coded, must be a multiple of 80.

The following example shows the correct syntax for the control statement in the IROSIN data set.

Commands

```
//IROSIN DD*
GLOBAL(ITKBSRVR=FPQSRV01,ADXCFGRP=ADSRV01,USES LBIC=N)
DATABASE(DBD=HIDAM1)
DATABASE(DBD=PHDAM2,PART=PHDPART1)
DATABASE(DBD=DEDB2,AREA=DEDB2AR1)
DATABASE(DBD=DEDB2,PART=DEDB2AR2)
CA(GROUP=CAGRP1)
CA(GROUP=CAGRP2)
/*
```

The diagram illustrates the format of the IROSIN control statement. It shows a sequence of commands: a comment line starting with //IROSIN DD*, followed by a GLOBAL command with parameters in parentheses, three DATABASE commands with parameters, and two CA commands with parameters. The keywords GLOBAL, DATABASE, and CA are highlighted with blue boxes. Arrows point from the label 'Keyword' to these boxes, and from the label 'Parameter' to the values in parentheses.

Figure 58. Format of the IROSIN control statement

A IROSIN control statement must conform to the following format:

GLOBAL command

- Only one GLOBAL command can be specified.
- The GLOBAL command keywords and their parameters follow the GLOBAL command.
- A GLOBAL command keyword and its parameter must be connected with an equal sign (=).
- Each GLOBAL command keyword and value pair must be separated by a comma.
- Multiple keyword and parameter pairs can be specified.

Keyword and parameter pairs can span more than one line; type a comma as a continuation character at the end of the first line, and continue the next keyword and parameter pair on the next line.

- A line that starts with an asterisk (*) is treated as a comment line.
- The first column must be blank.

DATABASE command

- One or more DATABASE commands can be specified.
- The DATABASE command keywords and their parameters follow the DATABASE command.
- A DATABASE command keyword and its parameter must be connected with an equal sign (=).
- Each DATABASE command keyword and value pair must be separated by a comma.
- Multiple keyword and parameter pairs can be specified.

Keyword and parameter pairs can span more than one line; type a comma as a continuation character at the end of the first line, and continue the next keyword and parameter pair on the next line.

- A line that starts with an asterisk (*) is treated as a comment line.
- The first column must be blank.

CA command

- One or more CA commands can be specified.
- The CA command keywords and their parameters follow the CA command.
- A CA command keyword and its parameter must be connected with an equal sign (=).
- Each CA command keyword and value pair must be separated by a comma.
- Multiple keyword and parameter pairs can be specified.

Keyword and parameter pairs can span more than one line; type a comma as a continuation character at the end of the first line, and continue the next keyword and parameter pair on the next line.

- A line that starts with an asterisk (*) is treated as a comment line.
- The first column must be blank.

GLOBAL command keywords for Recovery Sensor

The GLOBAL command keywords control the behavior of the job. You must specify the GLOBAL command and its keywords in the IROSIN DD.

The following syntax diagram shows the GLOBAL command keywords for Recovery Sensor.

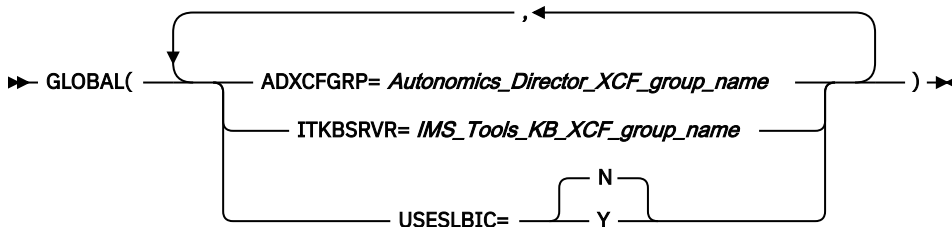

ADXCFGRP= *Autonomics_Director_XCF_group_name*

This required keyword specifies whether to send notification to Autonomics Director. The notification is used as a trigger by Autonomics Director to schedule a policy evaluation.

If you want Autonomics Director to schedule a policy evaluation, you use this keyword to specify the name of the Autonomics Director XCF group. Recovery Sensor sends sensor data notification to Autonomics Director after storing sensor data in the Sensor Data repository of IMS Tools Knowledge Base.

ITKBSRVR=*IMS_Tools_KB_XCF_group_name*

This required keyword specifies the IMS Tools Knowledge Base XCF group name (IMS Tools KB server name).

The sensor data and reports are stored in the IMS Tools Knowledge Base repositories that are managed by this IMS Tools Knowledge Base server.

USESLBIC=[Y | N]

This required keyword specifies if the IMS Recovery Expert SLB (System Level Backup) is used to identify possible image copies that are more recent than the image copies in DBRC.

This option can be activated by coding USESLBIC=Y.

The default setting is USESLBIC=N.

DATABASE command keywords for Recovery Sensor

The DATABASE command keywords specify the database to process.

You can specify multiple DATABASE commands.

The following syntax diagram shows the DATABASE command keywords for Recovery Sensor.

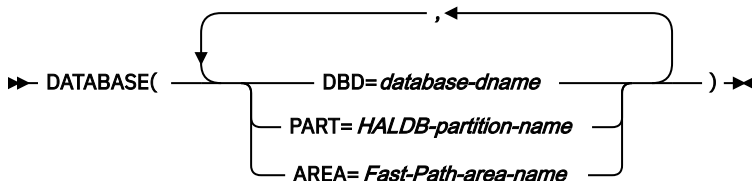

The maximum number of database data sets that a Recovery Sensor job can process is 1001. However, the actual number of data sets that can be processed depends on system resources. If Recovery Sensor cannot process a large number of database data sets, reduce the number of data sets and rerun the job.

DBD=database-dname

This required keyword specifies the database name for which sensor data needs to be collected.

PART=HALDB-partition-name

This optional keyword is used when DBD is a HALDB and specifies the HALDB partition name.

If this keyword is omitted, all partitions associated with the database are processed.

AREA=Fast-Path-area-name

This optional keyword is used when DBD is a Fast Path database and specifies the database area name.

If this keyword is omitted, all areas associated with the database are processed.

CA command keywords for Recovery Sensor

The CA command keywords specify the change accumulation groups to process.

You can specify multiple CA commands.

The following syntax diagram shows the CA command keywords for Recovery Sensor.

➤ CA(GROUP= *DBRC-change-accum-group-name*) ➤

The maximum number of database data sets that a Recovery Sensor job can process is 1001. However, the actual number of data sets that can be processed depends on system resources. If DB Sensor cannot process a large number of database data sets, reduce the number of data sets and rerun the job.

GROUP=DBRC-change-accum-group-name

This keyword specifies the change accumulation group name as defined to DBRC for which recovery sensor data is to be collected.

The data collected belongs to the CA group attributes and does not reflect individual databases contained in the group.

JCL examples for Recovery Sensor

Use these JCL examples to help you code JCL statements for Recovery Sensor.

A complete sample JCL can be found in member SFRXSAMP(IROSSAMP).

Processing recovery sensor data from DBRC

The following JCL example shows the control statements to extract recovery sensor data from DBRC.

```
SAMPLE Control statements extract sensors from DBRC
//IROSIN DD *
*
*   SOME GLOBAL VALUES THAT ITKB INTERFACE MAY NEED
*
*   GLOBAL (ITKBSRVR=REPOSRVR,
*           ADXCFGRP=ADXCFGRP)
*
*   THIS IS TO GENERATE SENSORS FROM DBRC DATA
*
*   DATABASE ( DBD=F101PC )
*   DATABASE ( DBD=H101PL,PART=H101PL1 )
*   DATABASE ( DBD=D2V1P1,AREA=D2V1P11 )
*   CA ( GROUP=CAF101PP )
```

Figure 59. Recovery Sensor JCL example: Processing recovery sensor data from DBRC

Chapter 20. Output from Recovery Sensor

Recovery Sensor generates a runtime summary report that is designed to be used only for troubleshooting purposes.

A more user-friendly report can be generated from an IMS Tools Knowledge Base utility.

Topics:

- [“Runtime summary report from Recovery Sensor” on page 127](#)

Runtime summary report from Recovery Sensor

The runtime summary report contains summary information about the Recovery Sensor job.

This report contains the following information:

- IROSIN control card information
- Global values required by the IMS Tools Knowledge Base interface
- DBRC DSPAPI generic database optimizer statistics
- Recovery Sensor results and, if any, error messages

The report is designed to be used only for troubleshooting purposes.

A more user-friendly report can be generated from an IMS Tools Knowledge Base utility.

Sample Recovery Sensor runtime report

The following figure (parts 1 and 2) shows an example of the Recovery Sensor runtime summary report.

```
IROSIN Control Cards follow:
Line  +-----1-----2-----3-----4
00001 *
00002 *      SOME GLOBAL VALUES THAT ITKB INTERFACE MAY NEED
00003 *
00004 *      GLOBAL (ITKBSVR=REPOSRVR,
00005 *              ADXCFGRP=ADXCFGRP)
00006 *
00007 *      THIS IS TO GENERATE SENSORS FROM DBRC DATA
00008 *
00009 *      DATABASE ( DBD=F101PC )
00010 *      DATABASE ( DBD=H101PL,PART=H101PL1 )
00011 *      DATABASE ( DBD=D2V1P1,AREA=D2V1P11 )
00012 *      CA ( GROUP=CAF101PP )

*****
DBRC DSPAPI Generic Database Optimizer Statistics

Databases      :      3
Key Ranges     :      3

DBD Range D    :      1  DSPAPI KEY : D2V1P1    CALL :      1  RLSE :      1
DBD Range F    :      1  DSPAPI KEY : F101PC    CALL :      1  RLSE :      1
DBD Range H    :      1  DSPAPI KEY : H101PL    CALL :      1  RLSE :      1

AD XCF Group   : ADXCFGRP
ITKB Server    : REPOSRVR

Database       : F101PC
Part/Area      :
DB Type        : F    Full Function
```

Figure 60. Runtime summary report (Recovery Sensor) - Part 1

```

Sensor DDname: F101PC1
Sensor Name   : DB_LASTIC_DBRC_TS
Sensor Value  : .....
                : 0021231514030600000000
                : 0C060F4599121D00000000

Sensor DDname: F101PC1
Sensor Name   : DB_DBRC_RECOV_NEEDED
Sensor Value  : ..N.....
                : 00D000000000000000000000
                : 0150000000000000000000

Sensor DDname: F101PC1
Sensor Name   : DB_DBRC_IC_NEEDED
Sensor Value  : ..N.....
                : 00D000000000000000000000
                : 0150000000000000000000

Sensor DDname: F101PC1
Sensor Name   : DB_DBRC_EEQE_COUNT
Sensor Value  : .....
                : 000000000000000000000000
                : 0400000000000000000000

Sensor DDname: F101PC1
Sensor Name   : DB_DBRC_IC_RECOMMENDED
Sensor Value  : ..N.....
                : 00D000000000000000000000
                : 0150000000000000000000

Sensor DDname: F101PC1
Sensor Name   : DB_IS_IN_A_DBRC_CAGRP
Sensor Value  : ..Y.....
                : 00E000000000000000000000
                : 0180000000000000000000

Sensor DDname: F101PC1
Sensor Name   : DB_DBRC_CAGRP_NAME
Sensor Value  : ..I247F101.....
                : 00CFFFCFDF00000000000000
                : 0892476161000000000000

Sensor DDname: F101PC1
Sensor Name   : DB_DBRC_BACKOUT_NEEDED
Sensor Value  : ..N.....
                : 00D000000000000000000000
                : 0150000000000000000000

Sensor DDname: F101PC1
Sensor Name   : DB_DBRC_RECOVERABLE
Sensor Value  : ..Y.....
                : 00E000000000000000000000
                : 0180000000000000000000

```

Figure 61. Runtime summary report (Recovery Sensor) - Part 2

Part 5. Troubleshooting

Use these topics to diagnose and correct problems that you experience with Data Sensor.

The following topics contain troubleshooting information:

Topics:

- [Chapter 21, “Messages and codes,” on page 131](#)
- [Chapter 22, “Gathering diagnostic information,” on page 159](#)
- [Chapter 23, “Diagnostics Aid for FF Stand-alone DB Sensor,” on page 161](#)
- [Chapter 24, “Diagnostics Aid for FP Stand-alone DB Sensor,” on page 167](#)

Chapter 21. Messages and codes

Use the following information to diagnose Data Sensor problems and error conditions.

Topics:

- “Data Sensor return codes” on page 131
- “FF DB Sensor messages” on page 132
- “FP DB Sensor messages” on page 155
- “Recovery Sensor messages (IRO)” on page 155

Data Sensor return codes

Stand-alone Data Sensor jobs, the Site Default Generation utility jobs, and the DB Sensor Printing utility jobs issue a return code to indicate the success or failure.

Data Sensor return codes

The following table summarizes the return codes that might be issued by FF Stand-alone DB Sensor, FP Stand-alone DB Sensor, and Recovery Sensor.

Table 14. Data Sensor return codes

Return code	Meaning
0	Stand-alone Data Sensor ended normally. Sensor data is stored in the Sensor Data repository.
4	Stand-alone Data Sensor ended with warning conditions. Sensor data is stored in the Sensor Data repository.
8	One or more errors occurred. Some or all sensor data is not stored in the Sensor Data repository.

If you receive return code 4 or 8, locate the Data Sensor messages in the following output:

- For FF Stand-alone DB Sensor, see the BBE messages that were sent as write-to-operator (WTO) messages or that are written in the job log or the Runtime Summary report.
- For FP Stand-alone DB Sensor, see the HFP messages that were sent as WTO messages or that are written in the job log or the HFPPRINT data set.
- For Recovery Sensor, see the IRO messages in the IROSPRNT data set.

Site Default Generation utility return codes

The following table summarizes the return codes that might be issued by the FF Site Default Generation utility and the FP Site Default Generation utility.

Table 15. Site Default Generation utility return codes

Return code	Meaning
0	The site default generation utility ended normally. The source code for the site default table is created, or the keywords and their parameters that are defined in the site default table are reported.

Table 15. Site Default Generation utility return codes (continued)

Return code	Meaning
8	One or more errors occurred. The source code for the site default table is not created, or the keywords and their parameters that are defined in the site default table are not reported.

If you receive return code 8, locate the BBE or the HFP messages in the following output:

- For FF Stand-alone DB Sensor, see the BBE messages that were sent as WTO messages or that are written in the job log or the Site Default report.
- For FP Stand-alone DB Sensor, see the HFP messages that were sent as WTO messages or that are written in the job log or the SYSMMSG data set.

DB Sensor Printing utility return codes

The following table summarizes the return codes that might be issued by the FF DB Sensor Printing utility and the FP DB Sensor Printing utility.

Table 16. DB Sensor Printing utility return codes

Return code	Meaning
0	DB Sensor Printing utility ended normally. A Sensor Data Statistics report is generated.
4	DB Sensor Printing utility ended with warning conditions. A Sensor Data Statistics report is partially generated.
8	DB Sensor Printing utility ended with errors. A Sensor Data Statistics report is not generated.

If you receive return code 4 or 8, locate the BBE or the HFP messages in the following output:

- For FF DB Sensor Printing utility, see the BBE messages that were sent as WTO messages or that are written in the job log or the Runtime Summary report.
- For FP DB Sensor Printing utility, see the HFP messages that were sent as WTO messages or that are written in the job log or the Runtime Summary report.

FF DB Sensor messages

Use the information in these messages to help you diagnose and solve FF Database Sensor problems. These messages apply to both FF Stand-alone DB Sensor and FF Integrated DB Sensor.

Message format

FF Database Sensor messages adhere to the following format:

```
BBEnnnnæ
```

where:

BBE

Indicates that the message was issued by FF Database Sensor.

nnnn

Indicates the message identification number

x

Indicates the severity of the message:

A

Indicates that operator intervention is required before processing can continue.

E

Indicates that an error occurred, which might or might not require operator intervention.

I

Indicates that the message is informational only.

W

Indicates that the message is a warning to alert you to a possible error condition.

Each message also includes the following information:

Explanation:

The Explanation section explains what the message text means, why it occurred, and what its variables represent.

System action:

The System action section explains what the system will do in response to the event that triggered this message.

User response:

The User response section describes whether a response is necessary, what the appropriate response is, and how the response will affect the system or program.

Messages

Messages that are issued by FF Database Sensor begin with BBE.

BBE1201W **DB SENSOR ENDED WITH
WARNINGS IN FUNC=*function*.
RC=*return_code***

Explanation

DB Sensor ended with warning conditions. *function* indicates the name of the internal function that was used by DB Sensor.

System action

DB Sensor processing ends with return code 4.

User response

Check the warning messages that were issued before this message. If necessary, correct the warning conditions and rerun the job.

BBE1202E **DB SENSOR COULD NOT OBTAIN
THE CORRECT STATISTICS
BECAUSE FSE OR FSEAP IS NOT
CORRECT**

Explanation

DB Sensor could not get the correct statistics because FSE or FSEAP is not correct. The error in FSE or FSEAP might have been caused because the database was being updated.

System action

DB Sensor processing ends with return code 8.

User response

None. This message is informational.

BBE1203W **FAILED TO SEND SENSOR DATA
NOTIFICATION TO AD. DBRC=YES
AND RECON1 DD MUST BE
SPECIFIED.**

Explanation

DB Sensor could not send a sensor data notification to Autonomics Director because DBRC=YES or RECON data sets were not specified.

System action

DB Sensor continues processing without sending a sensor data notification to Autonomics Director. When the process is complete, DB Sensor ends with return code 4.

User response

If you want DB Sensor to send a sensor data notification to Autonomics Director to start a policy evaluation, specify DBRC=Y and the RECON data sets, and rerun the job.

BBE1204W	FAILED TO SEND SENSOR DATA NOTIFICATION TO AD. FUNC=INIT, RC=return_code, RSN=reason_code
-----------------	--

Explanation

DB Sensor attempted to send a sensor data notification to Autonomics Director, but it failed.

System action

DB Sensor continues processing without sending a sensor data notification to Autonomics Director. When the process is complete, DB Sensor ends with return code 4.

User response

If you want to send a sensor data notification, ensure that the Autonomics Director master server is running correctly by completing the following tasks:

- Ensure that the Autonomics Director configuration has been set up correctly
- Ensure that the connection to the IMS Tools KB server is successful

For instructions, see the *IMS Tools Base Autonomics Director User's Guide*.

BBE1205W	FAILED TO SEND SENSOR DATA NOTIFICATION TO AD. FUNC=function, RC=return_code, RSN=reason_code, DB/PART=dbdname
-----------------	---

Explanation

DB Sensor attempted to send a sensor data notification to Autonomics Director, but it failed.

System action

DB Sensor continues processing without sending a sensor data notification to Autonomics Director. When

the process is complete, DB Sensor ends with return code 4.

User response

If you want to send a sensor data notification, ensure that the Autonomics Director master server is running correctly by referring to the *IMS Tools Base Autonomics Director User's Guide*.

BBE1206W	FAILED TO SEND SENSOR DATA NOTIFICATION TO AD. MASTER ADDRESS SPACE IS NOT ACTIVE. DB/PART=dbdname
-----------------	---

Explanation

DB Sensor could not send a sensor data notification to Autonomics Director because the Autonomics Director master address space is not active.

System action

DB Sensor continues processing without sending a sensor data notification to Autonomics Director. When the process is complete, DB Sensor ends with return code 4.

User response

If you want to send a sensor data notification, start the Autonomics Director master server.

BBE1207W	LOAD FAILED FOR IAVNTFY0 MODULE. CODE=code, RSN=reason_code
-----------------	--

Explanation

DB Sensor could not send a sensor data notification to Autonomics Director because the Autonomics Director load module could not be loaded.

System action

DB Sensor continues processing without sending a sensor data notification to Autonomics Director. When the process is complete, DB Sensor ends with return code 4.

User response

If you want to send a sensor data notification, ensure that the IMS Tools Base product data set, which contains the Autonomics Director load module, is specified on the STEPLIB DD correctly, and rerun the job.

BBE1208W **FAILED TO SEND SENSOR DATA NOTIFICATION TO AD. ITKB SERVER AND AD SERVER NAMES MUST BE SPECIFIED.**

Explanation

DB Sensor did not send a sensor data notification to Autonomics Director because ITKBSRVR=*NO is specified in the BBESIN data set. To send a sensor data notification to Autonomics Director, both the ADXCFGRP keyword and the ITKBSRVR keyword must specify valid server (XCF group) names.

System action

DB Sensor continues processing without sending a sensor data notification to Autonomics Director. When the process is complete, DB Sensor ends with return code 4.

User response

If you want DB Sensor to send a sensor data notification to Autonomics Director to start a policy evaluation, specify ITKBSRVR=*IMS_Tools_KB_XCF_group_name* in the BBESIN data set, and rerun the job.

BBE1320I **THE SITE DEFAULT TABLE BBESCTLO IS USED**

Explanation

Stand-alone DB Sensor used the runtime option values that are defined in the site default table.

System action

Processing continues.

User response

None. This message is informational.

BBE1321I **SOURCE CODE FOR THE SITE DEFAULT TABLE (BBESCTLO) WAS GENERATED**

Explanation

The Site Default Generation utility generated the source code for the site default table.

System action

The Site Default Generation utility ends.

User response

Assemble and link-edit the source code to create the site default table module.

BBE1322I **TOSI IS NOT ACTIVE**

Explanation

The IMS Tools Online System Interface (TOSI) is not active in IMS control regions.

System action

DB Sensor continues processing; however, DB Sensor does not retrieve the latest VSAM statistics information.

User response

You can ignore this message if the database is offline or if the database is an OSAM database.

If the database is a VSAM database and if it is online, values for some sensor data elements might contain old data (that is, data from before the database was made online). To obtain the most recent VSAM statistics, activate TOSI in IMS control regions. For the list of sensor data elements that might contain old data, see the explanation of TOSI in “GLOBAL command keywords for FF Stand-alone DB Sensor” on page 28.

BBE1323I **ddname DD IS NOT USED IN ANY OF THE IMS CONTROL REGIONS**

Explanation

IMS control regions are running. However, the database that is specified by the indicated DD is not made available to the IMS control regions or the DL/I separate address spaces (DLISASs). The database is offline, or is not allocated or opened in the IMS control regions or the DLISASs.

System action

DB Sensor obtains space utilization information about the database data set from the system catalog and VTOC without using IMS Tools Online System Interface (TOSI) due to the condition described in the explanation section. DB Sensor processing continues.

User response

None. This message is informational.

BBE1324I **DB SENSOR WAS NOT DEFINED IN ITKB**

Explanation

IMS Database Solution Pack or IMS Database Utility Solution is not defined in the IMS Tools Knowledge Base information management environment as a product that can store reports to the IMS Tools KB Output repository.

System action

Processing continues, but DB Sensor does not store any reports to the IMS Tools KB Output repository.

User response

If you want to store the reports in the IMS Tools KB Output repository, check the listing of registered products by using the LIST command of the IMS Tools KB HKTAPRA0 utility, and register the IMS Database Solution Pack product or IMS Database Utility Solution product by using HKTAPRA0. For instructions for using the HKTAPRA0 utility, see the *IMS Tools Base IMS Tools Knowledge Base User's Guide*.

BBE1325I	RECON ENTRY WAS NOT FOUND IN ITKB
-----------------	--

Explanation

A RECON entry was not defined in your IMS Tools Knowledge Base information management environment.

System action

Processing continues, but DB Sensor does not store any reports to the IMS Tools KB Output repository.

User response

If you want to store the reports in the IMS Tools KB Output repository, check the RECON information in the IMS Tools Knowledge Base panel of the ISPF dialogue and add a RECON environment.

For information about the IMS Tools Knowledge Base panel and about adding the RECON environment, see the *IMS Tools Base IMS Tools Knowledge Base User's Guide*.

BBE1326I	THE REPORT WAS NOT DEFINED IN ITKB
-----------------	---

Explanation

The report was not defined in the IMS Tools Knowledge Base information management environment.

System action

Processing continues, but DB Sensor does not store the report to the IMS Tools KB Output repository.

User response

If you want to store the report to the Output repository, check the listing of registered products and reports in IMS Tools KB by issuing the LIST command of the IMS Tools KB product administration utility (HKTAPRA0), and register the report by using the HKTAPRA0 utility.

For information about HKTAPRA0, see the *IMS Tools Base IMS Tools Knowledge Base User's Guide*.

BBE1327I	AN ERROR OCCURRED IN ACCESSING OUTPUT REPOSITORY FUNC: <i>function</i> RC: <i>return_code</i> RSN: <i>reason_code</i>
-----------------	--

Explanation

An error occurred while accessing the IMS Tools KB Output repository.

System action

Processing continues. If the return code is equal to or greater than 8, DB Sensor does not store its reports in the IMS Tools KB Output repository.

User response

If you do not want to store the reports in the IMS Tools KB Output repository, ignore the error.

If you want to store the reports in the IMS Tools KB Output repository, complete the appropriate action:

- If one or more of the messages BBE1324I, BBE1325I, or BBE1326I are issued after this message, see the explanation and user response for those messages.
- If these messages are not issued, check the return code and the reason code that are shown in this message. The codes are in hexadecimal. For the description of the return code and reason code, see the *IMS Tools Base IMS Tools Knowledge Base User's Guide*.

BBE1328I	DB: <i>dbdname</i> PART: <i>partname</i> REPORT: <i>report_name</i>
-----------------	--

Explanation

This message follows the BBE1327I message.

System action

Processing continues. If the return code in the BBE1327I message is equal to or greater than 8, DB Sensor does not store the *report_name* report for the database and the partition that are shown in this message.

User response

See the description for message BBE1327I.

BBE1329I **OPEN FAILED. THE DB SENSOR REPORTS ARE NOT PRINTED. DD=BBESPRT, RC=return_code**

Explanation

DB Sensor failed to open the data set that is specified by the BBESPRT DD. The DB Sensor reports are not printed. *return_code* is the return code from the macro.

System action

DB Sensor processing continues.

User response

The Sensor Data Statistics report is not generated. If you want to obtain this report, run the FF DB Sensor Printing utility.

To determine the cause of the open failure, ensure that the BBESPRT data set is specified correctly. If the data set is specified correctly, see *z/OS DFSMS Macro Instructions for Data Sets* to determine the meaning of the return code and the reason code. If the error is not in the data set or your system, contact IBM Software Support.

BBE1330I **THE ACCESS TO OUTPUT REPOSITORY WAS CANCELED BECAUSE GETMAIN FAILED WITH RC=return_code**

Explanation

DB Sensor canceled its access to the IMS Tools KB Output repository because of a GETMAIN macro error was encountered.

System action

DB Sensor processing continues.

User response

See the *z/OS MVS Assembler Services Reference* to determine the meaning of the return code. If the

problem is due to a lack of storage, increase the region size by specifying a larger value for the REGION parameter in the JCL, and rerun the job. If the problem is due to other reasons, contact IBM Software Support.

BBE1331I **SENSOR DATA FOR SOME DATA ELEMENTS ARE NOT STORED BECAUSE THEY ARE NOT IN THE DATA DICTIONARY.**

Explanation

The sensor data for any of the following data elements was not stored because the following data elements are not defined in the Policy Services Data Dictionary:

- DB_FLAG_SENSOR_DBINFO
- DB_FLAG_SEGMENT_STAT
- DBX_FLAG_SEGMENT_STAT

System action

DB Sensor stores sensor data for other data elements and continues processing.

User response

- To store sensor data for data element DB_FLAG_SENSOR_DBINFO, use IMS Tools Base 1.6 with APAR PI93320 or later, or IMS Tools Base 1.7.
- To store sensor data for data elements DB_FLAG_SEGMENT_STAT and DBX_FLAG_SEGMENT_STAT, use IMS Tools Base 1.7 with APAR PH52899 or later.

If you do not use these data elements, ignore this message.

BBE1332I **SOME OF SENSOR DATA ELEMENTS ARE NOT STORED BECAUSE OF INVALID VSAM STATISTIC.**

Explanation

The following sensor data elements are not stored because VSAM statistic values in the catalog are invalid.

- DB_UNUSED_BYTES
- DB_PCT_UNUSED_BYTES
- DB_NUM_CI_SPLIT
- DB_PCT_NUM_CI_SPLIT
- DB_NUM_CA_SPLIT
- DB_PCT_NUM_CA_SPLIT
- DBX_NUM_IPS
- DBX_NUM_IPS_OVFL

- DBX_PCT_IPS_OVFL
- DBX_UNUSED_BYTES
- DBX_PCT_UNUSED_BYTES
- DBX_NUM_CI_SPLIT
- DBX_PCT_NUM_CI_SPLIT
- DBX_NUM_CA_SPLIT
- DBX_PCT_NUM_CA_SPLIT

This problem is caused by either of the following conditions:

- VSAM statistics values of the database data set in the z/OS catalog are invalid.
For more information about invalid values in VSAM statistics, refer to the description of APAR II14008 in the IBM Support Web site.
- The database is being updated by an IMS application and, therefore, VSAM statistics in the z/OS catalog is also being updated.

Another BBE1332I message follows this message. The second BBE1332I message identifies the data set whose VSAM statistics values are invalid.

System action

DB Sensor stores sensor data elements except for the listed sensor data elements and continues processing.

User response

To store the listed sensor data elements, do as follows:

- If VSAM statistics values in the catalog are invalid, refer to the description of APAR II14008 and correct the statistic values of the VSAM data set.
- If the database is being updated, rerun the job after the database updates are completed.

BBE1333I DB SENSOR IS RETRYING SENSOR DATA COLLECTION FOR INDEX DATABASE *dbdname* DD *ddname*.

Explanation

DB Sensor is retrying to collect sensor data because some of the VSAM statistics information retrieved from the z/OS catalog has inconsistencies. The possible cause could be that the database is being updated by an IMS application and, therefore, VSAM statistics in the z/OS catalog is also being updated.

System action

DB Sensor continues processing.

User response

None. This message is informational.

BBE1350I DB SENSOR STORED SENSOR DATA FOR DATABASE *dbdname* [, PARTITION *partname*]

Explanation

DB Sensor stored the sensor data for the indicated database and HALDB partition in the Sensor Data repository of IMS Tools KB.

System action

DB Sensor continues processing.

User response

None. This message is informational.

BBE1351I DB SENSOR STORED SENSOR DATA RELATED TO SEGMENT STATISTICS FOR DATABASE *database*

Explanation

SEGMENT_STAT=YES is found in the BBESIN control statement. DB Sensor stored sensor data that is related to the segment occurrence count in the Sensor Data repository of IMS Tools KB.

System action

DB Sensor continues processing.

User response

None. This message is informational.

BBE1381I SENSOR DATA READING STARTED FOR DATABASE *dbdname* [, PARTITION *partname*]

Explanation

The DB Sensor Printing utility started to read the sensor data from the Sensor Data repository.

System action

Processing continues.

User response

None. This message is informational.

BBE1382I **SENSOR DATA READING ENDED FOR DATABASE *dbdname*[, PARTITION *partname*], RSI=*record_set_identifier***

Explanation

The DB Sensor Printing utility completed reading the sensor data from the Sensor Data repository. RSI indicates the identifier of the sensor data.

System action

Processing continues.

User response

None. This message is informational.

BBE1383I **SENSOR DATA STATISTICS REPORT GENERATION STARTED FOR DATABASE *dbdname*[, PARTITION *partname*]**

Explanation

The DB Sensor Printing utility started to generate the Sensor Data Statistics report.

System action

Processing continues.

User response

None. This message is informational.

BBE1384I **SENSOR DATA STATISTICS REPORT GENERATION ENDED FOR DATABASE *dbdname*[, PARTITION *partname*]**

Explanation

The DB Sensor Printing utility generated the Sensor Data Statistics report.

System action

Processing continues.

User response

None. This message is informational.

BBE1385I **SENSOR DATA PROCESSED IS IDENTIFIED BY LOCALE=RECON, RECON ID: *recon_id*, DSN: *dsname***

Explanation

The DB Sensor Printing utility processes the sensor data that was identified by the RECON locale that has the indicated RECON ID and RECON data set names.

System action

Processing continues.

User response

None. This message is informational.

BBE1386I **SENSOR DATA PROCESSED IS IDENTIFIED BY LOCALE=DEFAULT, RECON ID: NORECON**

Explanation

The DB Sensor Printing utility processes the sensor data that was identified by the default locale that has the indicated RECON ID (NORECON). NORECON is the default locale.

System action

Processing continues.

User response

None. This message is informational.

BBE1387I **THE SENSOR DATA STATISTICS REPORT FOR *database_type* WAS GENERATED**

Explanation

The DB Sensor Printing utility generated the Sensor Data Statistics report for the indicated database type.

System action

Processing continues.

User response

None. This message is informational.

BBE1388I **ALL REPORT SECTIONS ARE PRINTED BECAUSE THE DATABASE TYPE IS UNKNOWN**

Explanation

The type of database could not be identified because the data element that identifies the database type (DB_DATABASE_TYPE) was not found. DB Sensor

Printing utility prints all the sections in the Sensor Data Statistics report.

System action

Processing continues.

User response

None. This message is informational.

BBE1401E **DB SENSOR ENDED WITH ERRORS
IN FUNC=*function*. RC=*return_code***

Explanation

DB Sensor ended with errors and could not gather the statistics data.

System action

DB Sensor processing ends with return code 8 or 16.

User response

Check the error messages that are issued before this message. If necessary, correct the errors and rerun the job. If the problem persists, contact IBM Software Support.

BBE1402E **INPUT PARAMETER *parameter* IS
NOT CORRECT. FUNC=*function***

Explanation

The input *parameter* parameter for an API macro is not correct.

System action

DB Sensor processing ends with return code 8.

User response

This error is likely an internal error. Contact IBM Software Support.

BBE1403E **THE DB ORGANIZATION
(*organization*) OF DATABASE
dbdname IS NOT SUPPORTED**

Explanation

The database organization of the *dbdname* database is not supported.

System action

DB Sensor processing ends with return code 8.

User response

This error is likely an internal error. Contact IBM Software Support.

BBE1404E ***ddname* DD IS MISSING**

Explanation

A data set is not allocated to *ddname* DD.

System action

DB Sensor processing ends with return code 8.

User response

Specify a data set name on the *ddname* DD statement and rerun the job.

BBE1405E **DB SENSOR WAS CALLED
IMPROPERLY BY FUNC=*function***

Explanation

The *function* function called DB Sensor improperly.

System action

DB Sensor processing ends with return code 8.

User response

Contact IBM Software Support.

BBE1406E **DB SENSOR RECEIVED BROKEN
CI/BLOCK AS RBN=*rbn* OF *ddname*
DD**

Explanation

The CI/Block cannot be analyzed because the CI/Block that was passed to DB Sensor as the CI/Block for *rbn* of *ddname* DD is broken.

System action

DB Sensor processing ends with return code 8.

User response

Contact IBM Software Support.

BBE1407E **THE SENSOR DATA PROCESS WAS
CANCELED**

Explanation

An error occurred and the sensor data process was canceled.

System action

DB Sensor processing ends with return code 8.

User response

If you receive this error message while running Integrated DB Sensor, see the message explanation for the error message that was issued by the product that called the DB Sensor process.

If you receive this error message while running Stand-alone DB Sensor, see the BBE messages that were issued before this message. If the problem persists, contact IBM Software Support.

BBE1408E	BLOCK ANALYSIS IS INCOMPLETE. TASK-ID: <i>task_id</i>
-----------------	--

Explanation

The block analysis that was run by the SCAN task and that is identified by *task_id* is incomplete because the task failed with errors.

System action

DB Sensor processing ends with return code 8.

User response

Check the error messages that are issued before this message. Correct the errors and rerun the job. If the problem persists, contact IBM Software Support.

BBE1409E	DB SENSOR SHOULD BE CALLED WITH FUNC=<i>function</i>
-----------------	---

Explanation

The *function* function should have called DB Sensor, but the call was not made.

System action

DB Sensor processing ends with return code 8.

User response

Contact IBM Software Support.

BBE1410E	DASD VOLUME (<i>volume_serial</i>) OF <i>ddname</i> DD IS UNAVAILABLE
-----------------	--

Explanation

The DASD volume that contains DBDS *ddname* DD is not available. *volume_serial* indicates the volume serial number.

System action

DB Sensor processing ends with return code 8.

User response

Make the DASD volume available in the system, and specify the correct data set for *ddname* DD.

BBE1411E	CATALOG SEARCH PROCESS FOR <i>ddname</i> DD FAILED BECAUSE [CSI FAILED WITH RC=<i>return_code</i>, RSN=<i>reason_code</i> CATALOG HAS NO DATA COMPONENT DCOLLECT FAILED WITH RC=<i>return_code</i>]
-----------------	--

Explanation

DB Sensor failed to obtain the space utilization information from the catalog of the *ddname* DD data set.

System action

DB Sensor processing ends with return code 8.

User response

Catalog the data set information correctly and rerun the job. If the problem persists, contact IBM Software Support.

BBE1412E	DB SENSOR ENDED WITH ERRORS. FUNC=<i>function</i>, RC=<i>return_code</i>, RSN=<i>reason_code</i>
-----------------	---

Explanation

DB Sensor ended with errors.

System action

DB Sensor processing ends with return code 8 or 16.

User response

Check the error messages that are issued before this message and follow the user response sections of those messages. If necessary, correct the errors and rerun the job. If the problem persists, contact IBM Software Support.

BBE1413E	DB SENSOR IS NOT APF-AUTHORIZED
-----------------	--

Explanation

The load module library that includes DB Sensor is not APF-authorized.

System action

DB Sensor processing ends with return code 8.

User response

APF-authorize all the data sets that are concatenated to the STEPLIB or the JOBLIB DD.

BBE1414E *parameter* **CANNOT BE SPECIFIED FOR THE keyword KEYWORD**

Explanation

The indicated parameter is not valid for the indicated keyword.

System action

DB Sensor processing ends with return code 8.

User response

In the BBESIN data set, specify the correct parameter for the keyword and rerun the job.

BBE1415E **THE NUMBER OF DATABASE DATA SETS EXCEEDED THE LIMIT**

Explanation

More than 1001 database data sets are specified.

System action

DB Sensor processing ends with return code 8.

User response

In the BBESIN data set, decrease the number of database data sets.

BBE1416E **THE BBESIN CONTROL STATEMENT CONTAINS ONE OR MORE ERRORS**

Explanation

Control statement errors are found in the BBESIN data set.

System action

DB Sensor processing ends with return code 8.

User response

Check the job log or the Runtime Summary report and locate the WTO message that explains the error. Identify the cause, correct the error, and rerun the job.

BBE1417E *command* **COMMAND MUST NOT BE SPECIFIED MORE THAN ONCE**

Explanation

The indicated command can be specified only once; however, it is specified more than once in the BBESIN data set.

System action

DB Sensor processing ends with return code 8.

User response

Remove the duplicate command and rerun the job.

BBE1418E **IMS VERSION *ims_version* IS NOT SUPPORTED**

Explanation

The version of the IMS RESLIB that is in the STEPLIB or JOBLIB is not supported.

System action

DB Sensor processing ends with return code 8.

User response

Specify the correct IMS RESLIB and rerun the job.

BBE1419E **THE GLOBAL COMMAND MUST BE SPECIFIED BEFORE THE *command* COMMAND**

Explanation

The GLOBAL command must be specified before the indicated command.

System action

DB Sensor processing ends with return code 8.

User response

Correct the order of the commands and rerun the job.

BBE1420E **THE *command* COMMAND MUST BE SPECIFIED**

Explanation

The indicated command is a required command. However, the command is not specified in the control statement.

System action

DB Sensor processing ends with return code 8.

User response

Specify the correct command in the control statement and rerun the job.

BBE1421E **STATEMENT CONTAINS A SYNTAX ERRORS**

Explanation

Syntax errors were found in the control statements that are specified in the BBESIN data set.

System action

DB Sensor processing ends with return code 8.

User response

Correct the syntax errors and rerun the job.

BBE1422E ***command* COMMAND IS NOT CORRECT**

Explanation

The specified command is not a GLOBAL or a DATABASE statement.

System action

DB Sensor processing ends with return code 8.

User response

Specify the GLOBAL statement or the DATABASE statement, and rerun the job.

BBE1423E ***keyword* KEYWORD CANNOT BE SPECIFIED IN THE *command* COMMAND**

Explanation

The indicated keyword cannot be specified in the indicated command.

System action

DB Sensor processing ends with return code 8.

User response

Specify the correct keyword and rerun the job.

BBE1424E **THE NUMBER OF *keyword* KEYWORDS EXCEEDED THE LIMIT. MAX IS *number*.**

Explanation

The indicated keyword is specified more than the maximum allowable number of times.

System action

DB Sensor processing ends with return code 8.

User response

Reduce the number of keywords and rerun the job.

BBE1425E ***keyword* KEYWORD MUST BE SPECIFIED FOR THE *command* COMMAND**

Explanation

The indicated keyword is a required keyword for the indicated command; however, the keyword was not specified.

System action

DB Sensor processing ends with return code 8.

User response

Specify the required keyword and rerun the job.

BBE1426E **THE NUMBER OF PARAMETERS SPECIFIED IN *keyword* KEYWORD EXCEEDED THE LIMIT. MAX IS *number*.**

Explanation

The number of parameters that are specified on the indicated keyword is more than the maximum allowable number.

System action

DB Sensor processing ends with return code 8.

User response

Correct the parameters and rerun the job.

BBE1427E **THE *n*TH PARAMETER ON THE *keyword* KEYWORD HAS INCORRECT LENGTH**

Explanation

The length of the indicated parameter that is specified on the indicated keyword is incorrect.

System action

DB Sensor processing ends with return code 8.

User response

Correct the length of the parameter and rerun the job.

BBE1428E	THE DATABASE IS A HALDB. SPECIFY DBRC=YES ON THE GLOBAL STATEMENT FOR HALDB DATABASES.
-----------------	---

Explanation

For HALDB databases, you must specify DBRC=YES on the GLOBAL control statement. However, DBRC=NO was specified.

System action

DB Sensor processing ends with return code 8.

User response

Specify DBRC=YES on the GLOBAL command. Also, specify the RECON data sets by using the RECON1, RECON2, and RECON3 DD statements or by using the DFSMDA members that are in the STEPLIB or IMSDALIB.

BBE1429E	PARTITION <i>partname</i> IS DISABLED OR NOT FOUND IN THE RECON DATA SETS.
-----------------	---

Explanation

The indicated HALDB partition is either disabled or not found in the RECON data sets.

System action

DB Sensor processing ends with return code 8.

User response

Specify the correct partition name for the PART keyword in the BBESIN data set and rerun the job.

BBE1430E	THE SITE DEFAULT TABLE BBESCTLO IS NOT FOUND
-----------------	---

Explanation

The Site Default Generation utility could not find the input site default table module (BBESCTLO) in the STEPLIB data set. BBESCTLO is required in the STEPLIB concatenated data sets when PARM=REPORT is specified on the JCL EXEC parameter.

System action

DB Sensor processing ends with return code 8.

User response

Store the site default table module (BBESCTLO) in the data set that is concatenated to the STEPLIB.

BBE1431E	SITE DEFAULT TABLE BBESCTLO IS CORRUPTED
-----------------	---

Explanation

The site default table module (BBESCTLO) was found in the STEPLIB data sets; however, it is not in a valid format.

System action

DB Sensor processing ends with return code 8.

User response

Re-create the site default table module (BBESCTLO) by submitting the Site Default Generation utility. Assemble and link-edit the source code, and then store the module in the STEPLIB data set. Rerun the job.

BBE1432E	<i>parm-value</i> IS NOT VALID FOR THE PARAM PARAMETER OF THE EXEC STATEMENT
-----------------	---

Explanation

The indicated PARM value is incorrect. This PARM value is specified on the EXEC statement of the Site Default Generation utility.

System action

DB Sensor processing ends with return code 8.

User response

Specify GEN or REPORT for the PARM= parameter on the EXEC statement, and rerun the job.

BBE1433E	ALL HALDB PARTITIONS MUST BE SPECIFIED
-----------------	---

WHEN SEGMENT_STAT=YES IS SPECIFIED.

Explanation

When SEGMENT_STAT=YES, DB Sensor collects data elements that are related to segment occurrence count at the database level, so all partitions of the HALDB database must be specified in the DATABASE command.

System action

DB Sensor processing ends with return code 8.

User response

Specify all HALDB partitions in the DATABASE command or change the SEGMENT_STAT parameter from YES to NO.

BBE1434E **keyword=parameter CANNOT BE SPECIFIED WHEN SENSOR_DBINFO=NO IS SPECIFIED**

Explanation

The following *keyword* and *parameter* combination is invalid when SENSOR_DBINFO=NO is specified:

- SENSOR_HOME=YES
- SEGMENT_STAT=YES

System action

DB Sensor processing ends with return code 8.

User response

Ensure that NO is specified for the SENSOR_HOME keyword and the SEGMENT_STAT keyword and rerun the job.

BBE1435I **SENSOR_HOME=NO IS APPLIED BECAUSE SENSOR_DBINFO=NO IS SPECIFIED**

Explanation

SENSOR_DBINFO=NO is specified but the SENSOR_HOME keyword is not specified explicitly neither in the BBESIN data set nor in the site default table. SENSOR_HOME=NO is applied because the combination of SENSOR_HOME=YES (default value) and SENSOR_DBINFO=NO is invalid.

System action

Processing continues.

User response

None. This message is informational.

BBE1440E **TOSI API FUNCTION=function FAILED, RC=return_code, RSN=reason_code**

Explanation

An error occurred during IMS Tools Online System Interface (TOSI) processing. *function* is the TOSI function code, and *return_code* and *reason_code* are the return code and the reason code from TOSI.

System action

DB Sensor processing ends with return code 8.

User response

See the IMS Tools Online System Interface messages (FOIxxxx) that were issued in the IMS control regions where the IMS Tools Online System Interface is active.

BBE1441E **TOSI API FUNCTION=function FAILED FOR DBD=dbdname, RC=return_code, RSN=reason_code**

Explanation

An error occurred during IMS Tools Online System Interface (TOSI) processing. *function* is the TOSI function code, and *return_code* and *reason_code* are the return code and the reason code from TOSI.

System action

DB Sensor processing ends with return code 8.

User response

See the IMS Tools Online System Interface messages (FOIxxxx) that were issued in the IMS control regions where the IMS Tools Online System Interface is active.

BBE1442E **THE VSAMSTAT COMMAND FAILED FOR DBD=dbdname , DD=ddname, RC=nnnn, RSN=nnnn**

Explanation

DB Sensor issued the VSAMSTAT action command to obtain the latest VSAM statistics of the IMS full-function database data set by using IMS Tools

Online System Interface (TOSI). However, the TOSI processing did not complete successfully in one or more IMS control regions.

System action

DB Sensor processing ends with return code 8.

User response

See the IMS Tools Online System Interface messages (FOIxxxxx) that were issued in the IMS control regions where the IMS Tools Online System Interface are active.

BBE1444E **TOSI IS NOT AT THE REQUIRED MAINTENANCE LEVEL:**
reason_code

Explanation

The version and release of IMS Tools Online System Interface (TOSI) that was used in the DB Sensor job, in the IMS control regions, or both are lower than the required maintenance level. *reason_code* has the following meaning:

Reason code	Meaning
0001	The version of IMS Tools Online System Interface is not at the required maintenance level to support the VSAMSTAT command. One of the currently supported versions of IMS Tools Base is required.
0002	The version of IMS Tools Online System Interface is not at the required maintenance level to run the VSAMSTAT command against VSAM linear data sets. IMS Tools Base 1.6 with APAR PH23664 or later is required.

System action

DB Sensor processing ends with return code 8.

User response

Use IMS Tools Online System Interface that is at the required maintenance level.

BBE1445E **CONNECTION TO THE ITKB SERVER FAILED**

Explanation

The connection to the IMS Tools KB server failed. This message might be issued for the following reasons:

- The server configuration is incomplete.
- The server is not started.
- The server name (XCF group name) that is specified by the ITKBSRVR keyword is incorrect.
- Insufficient access authority to repository.

System action

DB Sensor processing ends with return code 8.

User response

Complete the following steps:

1. Ensure that the server name (XCF group name) specified on the ITKBSRVR keyword is correct.
2. Ensure that the IMS Tools KB server is configured and started without any errors. For configuration steps, see the topic "Configuring IMS Tools Knowledge Base" in the *IMS Tools Base Configuration Guide*.

If the problem persists, contact your system administrator to obtain the required level of authorization.

BBE1446E ***product* IS NOT AT THE REQUIRED MAINTENANCE LEVEL**

Explanation

The version and release of the product is lower than the required maintenance level.

- When SENSOR_DBINFO=NO is specified, IMS Tools Base 1.6 with APAR PI93320 or later, or IMS Tools Base 1.7 is required.
- When SEGMENT_STAT=YES is specified, IMS Tools Base 1.7 with APAR PH52476 or later is required.

System action

Database Sensor ends with return code 8.

User response

Use the product that meets the required maintenance level. Otherwise, remove the SEGMENT_STAT or SENSOR_DBINFO keyword, or specify SEGMENT_STAT=NO or SENSOR_DBINFO=YES in the GLOBAL command.

BBE1449E **DB SOLUTION PACK VERSION IS LOWER THAN 1.2**

Explanation

The version of IMS Database Solution Pack is earlier than 1.2.

System action

DB Sensor processing ends with return code 8.

User response

Specify the library of a supported version of IMS Database Solution Pack on the STEPLIB DD, and rerun the job.

BBE1450E **DATA DICTIONARY SERVICE FAILED.**
FUNC=function, RC=return_code,
RSN=reason_code[,
ELEM=data_element xxxx/yyyy]

Explanation

One or more errors were detected when the *function* function of the Data Dictionary Service was running. Hexadecimal values *return_code* and *reason_code* show the return and reason codes of the error, respectively. If the errors are detected in specific data elements, *data_element* shows the name of the data element, and hexadecimal values *xxxx* and *yyyy* show the return and reason codes of the error, respectively.

System action

DB Sensor processing ends with return code 8.

User response

Determine if the correct load module library for Policy Services is specified in your JCL. See the *IMS Tools Base Policy Services User's Guide* to determine the meaning of the return code and reason code. Correct the error and rerun the job. If the problem persists, contact IBM Software Support.

BBE1451E **SENSOR DATA SERVICE FAILED.**
FUNC=function, RC=return_code,
RSN=reason_code[,
ELEM=data_element xxxx/yyyy]

Explanation

One or more errors were detected when the *function* function of the sensor data service was running. Hexadecimal values *return_code* and *reason_code* show the return and reason codes of the error, respectively. If the errors are detected in specific data elements, *data_element* shows the name of the data

element, and hexadecimal values *xxxx* and *yyyy* show the return and reason codes of the error, respectively.

If this message contains FUNC=INIT, RC=4, and RSN=X'52', the message indicates that the Sensor Data repository is not initialized.

System action

DB Sensor processing ends with return code 8.

User response

Determine if the correct load module library for Policy Services is specified in your JCL. See the *IMS Tools Base Policy Services User's Guide* to determine the meaning of the return code and reason code. Correct the error and rerun the job.

When FUNC=INIT, RC=4, and RSN=X'52', follow the instructions in the topic "Initializing the Sensor Data and Input repositories" in the *IMS Tools Base Configuration Guide* and initialize the Sensor Data repository. Rerun the job.

If the problem persists, contact IBM Software Support.

BBE1452E **DB SENSOR DID NOT STORE SENSOR DATA FOR DATABASE dbdname [,PARTITION partnam]**

Explanation

DB Sensor did not store the sensor data for the indicated database and partition.

System action

DB Sensor processing ends with return code 8.

User response

The probable cause of this error is that one of the following events occurred:

- IMS Tools KB server ended while DB Sensor was running.
- Not enough space is available to store the sensor data in the Sensor Data repository.

Ensure that the IMS Tools KB server is operating correctly and that the Sensor Data repository has enough space to store the sensor data. Also, check the BBE messages that were issued before this message.

BBE1453W **DB SENSOR COULD NOT COLLECT DATA FOR data_element FOR DATABASE dbdname [, PARTITION partname].**

Explanation

DB Sensor failed to collect information for the indicated data element for the indicated database or the HALDB partition.

System action

DB Sensor continues processing without storing the data element in the IMS Tools KB Sensor Data repository. When the process is complete, DB Sensor ends with return code 4.

User response

See the description for message BBE1332I. If message BBE1332I is not issued, contact IBM Software Support.

BBE1454E	DB SENSOR DID NOT STORE SENSOR DATA RELATED TO SEGMENT STATISTICS FOR DATABASE <i>dbdname</i>
-----------------	--

Explanation

SEGMENT_STAT=YES is found in the BBESIN control statement but DB Sensor did not store sensor data that is related to the segment occurrence count in the Sensor Data repository of IMS Tools KB.

System action

DB Sensor processing ends with return code 8.

User response

The probable cause of this error is that one of the following events occurred:

- IMS Tools KB server ended while DB Sensor was running.
- Not enough space is available to store the sensor data in the Sensor Data repository.

Ensure that the IMS Tools KB server is operating correctly and that the Sensor Data repository has enough space to store the sensor data. Also, check the BBE messages that were issued before this message.

BBE1480E	ERRORS WERE DETECTED WHILE <i>description</i>
-----------------	--

Explanation

The DB Sensor Printing utility detected errors and stopped processing. *description* shows the processing that was performed when the error was found. *description* can be one of the following strings:

- ANALYZING THE CONTROL STATEMENT
- READING THE SENSOR DATA
- GENERATING THE SENSOR DATA STATISTICS REPORT

System action

The DB Sensor Printing utility ends with return code 8.

User response

Determine the cause of the errors by investigating the BBESOUT data set, correct the error, and rerun the job.

BBE1481E	UNABLE TO CONNECT TO THE ITKB REPOSITORY
-----------------	---

Explanation

The DB Sensor Printing utility could not communicate with the IMS Tools KB server.

System action

The DB Sensor Printing utility ends with return code 8.

User response

The probable cause of this error is that one of the following events occurred:

- The IMS Tools KB server name that was specified is incorrect.
- The IMS Tools KB server ended while the DB Sensor Printing utility was running.

Correct the error and rerun the job.

BBE1482E	THE SPECIFIED SENSOR DATA WAS NOT FOUND IN THE REPOSITORY
-----------------	--

Explanation

The sensor data that is associated with the specified locale was not found in the IMS Tools KB Sensor Data repository.

System action

The DB Sensor Printing utility ends with return code 8.

User response

The probable cause of this error is that one of the following events occurred:

- The database name that was specified on the DBD keyword is incorrect.

- The processed resource was a HALDB partition. However, the PART keyword was not specified.
- The processed resource was a DEDB area. However, the IAREA keyword was not specified.
- The ITKBSRVR keyword specifies an incorrect IMS Tools KB server XCF group name.
- DB Sensor has not stored sensor data for the specified database.
- SEGSTAT_REPORT=YES was specified on the GLOBAL command. However, DB Sensor has not stored the relevant sensor data (segment occurrence count at the database level) for the specified database.
- The sensor data does not exist in the repository because the retention period has expired.

BBE1483E **THE SENSOR DATA SERVICE FAILED. RC=return_code, RSN=reason_code, FUNC=function**

Explanation

The sensor data service function call ended with errors. *function* indicates the function name that is used internally by sensor data service. The hexadecimal value *return_code* indicates the return code, and the hexadecimal value *reason_code* indicates the reason code from the sensor data service.

System action

The DB Sensor Printing utility ends with return code 8.

User response

See the *IMS Tools Base Policy Services User's Guide* to determine the meaning of the return code and the reason code. If you receive other BBE messages, check the meaning of those messages and take appropriate actions that are described in the user response section of the messages.

BBE1484E **THE DATA DICTIONARY SERVICE DETECTED ERRORS. FUNC=function, RC=return_code, RSN=reason_code**

Explanation

One or more errors were detected when the indicated function of the Data Dictionary Service was running. Hexadecimal values *return_code* and *reason_code* indicate the return and reason codes from the Data Dictionary Service, respectively. If the errors were detected in specific data elements, BBE1485E messages follow this message.

System action

When the indicated function is FORM, the DB Sensor Printing utility ends with return code 4. In other cases, the DB Sensor Printing utility ends with return code 8.

User response

Specify the correct load module library for Policy Services in your JCL, and rerun the job. If the problem persists, contact IBM Software Support.

BBE1485E **- DATA ELEMENT: data_element, RC=return_code, RSN=reason_code**

Explanation

An error was detected while processing the indicated data element. Hexadecimal values *return_code* and *reason_code* indicate the return and reason codes, respectively. The preceding message, BBE1484E, indicates the function of Data Dictionary that was in process when this error occurred.

System action

See the System action section for BBE1484E message.

User response

Specify the correct load module library for Policy Services in your JCL, and rerun the job. If the problem persists, contact IBM Software Support.

BBE1486E **THE RECON ID THAT CORRESPONDS TO [RECON1 DD | NORECON] COULD NOT BE OBTAINED**

Explanation

The DB Sensor Printing utility failed to retrieve the RECON ID from the IMS Tools KB Input repository.

System action

The DB Sensor Printing utility ends with return code 8.

User response

Ensure that the correct RECON data set name is specified on the RECON1 DD statement in the DB Sensor Printing utility JCL. Also, ensure that the RECON data set name is registered in IMS Tools KB. If the problem persists, contact IBM Software Support.

BBE1487E **keyword KEYWORD CANNOT BE SPECIFIED WHEN**

SEGSTAT_REPORT=YES IS SPECIFIED

Explanation

The PART keyword of the DATABASE command cannot be specified when SEGSTAT_REPORT=YES is specified.

System action

The DB Sensor Printing utility ends with return code 8.

User response

Remove the PART keyword from the DATABASE command, or change the parameter of the SEGSTAT_REPORT keyword from YES to NO.

BBE1488E product IS NOT AT THE REQUIRED MAINTENANCE LEVEL

Explanation

The version and release of the product is lower than the required maintenance level. IMS Tools Base 1.7 with PTF for APAR PH52899 or later is required when SEGSTAT_REPORT=YES is specified.

System action

The DB Sensor Printing utility ends with return code 8.

User response

Use the product that meets the required maintenance level. Otherwise, remove the SEGSTAT_REPORT keyword or specify SEGSTAT_REPORT=NO in the GLOBAL command.

**BBE3201E GETMAIN FAILED.
RC=return_code, SIZE=size, MOD:
modname, ERROR-ID: error_id**

Explanation

The GETMAIN macro failed with return code *return_code*. *size* indicates the size of the area that is specified in the macro, *modname* and *error_id* indicate the location and cause of the error.

System action

DB Sensor processing ends with return code 16.

User response

See the *z/OS MVS Assembler Services Reference* to determine the meaning of the return code. If the

problem is due to a lack of storage, increase the region size by specifying a larger value for the REGION parameter in the JCL and rerun the job. If the problem is due to other reasons, contact IBM Software Support.

**BBE3202E FREEMAIN FAILED.
RC=return_code, MOD: modname,
ERROR-ID: error_id**

Explanation

The FREEMAIN macro failed with return code *return_code*. *modname* and *error_id* indicate the location and cause of the error.

System action

DB Sensor processing ends with return code 8.

User response

This error is likely an internal error. Contact IBM Software Support.

**BBE3203E OPEN FAILED.
DB=dbdname, DD=ddname,
DSORG=dsorg, RC=return_code,
RSN=reason_code,
MOD=modname, ERROR-
ID=error_id**

Explanation

DB Sensor failed to open the database data set *ddname* DD. *return_code* is the return code and *reason_code* is the reason code from the macro. *modname* and *error_id* indicate the location and cause of the error.

System action

DB Sensor processing ends with return code 8.

User response

See *z/OS DFSMS Macro Instructions for Data Sets* to determine the meaning of the return code and reason code. Correct the error and rerun the job. If the error is not in the data set or your system, contact IBM Software Support.

**BBE3204E VSAM xxxxxxxx
FAILED. RC=return_code,
RSN=reason_code, DD: ddname,
MOD: modname, ERROR-ID:
error_id**

Explanation

The macro for the VSAM data set *ddname* DD failed. *return_code* is the return code and *reason_code* is the reason code from the macro. *modname* and *error_id* indicate the location and cause of the error.

System action

DB Sensor processing ends with return code 8.

User response

See *z/OS DFSMS Macro Instructions for Data Sets* to determine the meaning of the return code and reason code. Correct the error and rerun the job. If the error is not in the data set or your system, contact IBM Software Support.

BBE3205E **LOAD FAILED. SC=*sc*, RSN=*rsn*, DD: *ddname*, MEMBER: *member*, MOD: *modname*, ERROR-ID: *error_id***

Explanation

The LOAD macro failed with system completion code *sc* and reason code *rsn*. *member* indicates the name of the member that caused the failure. *modname* and *error_id* indicate the location and cause of the error.

System action

DB Sensor processing ends with return code 8 or 16.

User response

See the *z/OS MVS Assembler Services Reference* to determine the meaning of the return code and reason code. Correct the error and rerun the job. If the error is not in the data set or your system, contact IBM Software Support.

BBE3206E **DYNAMIC ALLOCATION FAILED. RC=*return_code*, RSN=*reason_code*, DD: *ddname*, MOD: *modname*, ERROR-ID: *error_id***

Explanation

A database data set could not be dynamically allocated. This message contains the following information:

- *return_code* indicates the return code.
- *reason_code* indicates the reason code.
- *ddname* indicates the name of the DD for which the allocation failed.

- *modname* indicates the module name in which the error occurred.
- *error_id* indicates the cause of the error.

Another BBE3206E message follows this message. The second BBE3206E message indicates the name of the data set that could not be allocated.

System action

DB Sensor processing ends with return code 8.

User response

Ensure that the data set information is correctly cataloged to the system catalog. If no problems are found in the catalog, see the topic about interpreting DYNALLOC return codes in the *z/OS MVS Authorized Assembler Services Guide* to determine the meaning of the return code and reason code. Correct the error and rerun the job. If the error is not in the data set or your system, contact IBM Software Support.

BBE3207E **OBTAIN FAILED. RC=*return_code*, DSCB: *dscbname*, DD: *ddname*, MOD: *modname*, ERROR-ID: *error_id***

Explanation

The OBTAIN macro failed to read a DSCB by data set name with return code *return_code*. *dscbname* indicates the name of the DSCB that was used in the macro, and *ddname* indicates the DD name that could not be obtained. *modname* and *error_id* indicate the location and cause of the error.

System action

DB Sensor processing ends with return code 8.

User response

If the return code that is shown in this message is 16 (X'10'), contact IBM Software Support. Otherwise, see *z/OS DFSMSdfp Advanced Services* to determine the meaning of the return code. Correct the error and rerun the job.

BBE3208E **UCBSCAN FAILED. RC=*return_code*, RSN=*reason_code*, DD: *ddname*, MOD: *modname*, ERROR-ID: *error_id***

Explanation

The UCBSCAN service failed for *ddname* DD with return code *return_code* and reason code *reason_code*.

modname and *error_id* show the location and cause of the error.

System action

DB Sensor processing ends with return code 8.

User response

Contact IBM Software Support.

BBE3209E **NAME/TOKEN SERVICE
(pgmname) FAILED.
RC=return_code, NAME:
nametoken_name**

Explanation

The Name/Token callable service failed with return code *return_code*. *pgmname* indicates the program name of the Name/Token callable service, and *nametoken_name* indicates the name of Name/Token pairs.

System action

DB Sensor processing ends with return code 16.

User response

Contact IBM Software Support.

BBE3210E **UCBINFO FAILED. RC=return_code,
RSN=reason_code, DD: ddname,
VOLSER: volume_serial, MOD:
modname, ERROR-ID: error_id**

Explanation

The UCBINFO service failed with return code *return_code* and reason code *reason_code*. *ddname* and *volume_serial* indicate the names of the DD and the volume for which the UCBINFO macro was issued. *modname* and *error_id* indicate the location and cause of the error.

System action

DB Sensor processing ends with return code 8.

User response

Contact IBM Software Support.

BBE3211E **IGWASYS FAILED.
RC=return_code, RSN=reason_code**

Explanation

The IGWASYS routine failed with return code *return_code* and reason code *reason_code*.

System action

DB Sensor processing ends with return code 16.

User response

Contact IBM Software Support.

BBE3212E **DFSMS VERSION IS LOWER THAN
1.7**

Explanation

The current version of DFSMS is lower than the minimum version required.

System action

DB Sensor processing ends with return code 16.

User response

Use DFSMS 1.7 or later, and rerun the job.

BBE3213E **BLDL FAILED. RC=return_code,
RSN=reason_code, DD: ddname,
MEMBER: member, MOD:
modname, ERROR-ID: error_id**

Explanation

The BLDL macro failed with return code *return_code* and reason code *reason_code*. *member* indicates the name of the member that caused the failure. *modname* and *error_id* indicate the location and cause of the error.

System action

DB Sensor processing ends with return code 8.

User response

Check the data set that is specified by the *ddname* DD to see if the member is included in the data set. If the member is included in the data set, identify the cause of the BLDL failure by determining the meaning of the return code and reason code, which are documented in *z/OS DFSMS Macro Instructions for Data Sets*. Correct the error and rerun the job. If the error is not in the data set or your system, contact IBM Software Support.

BBE3214E **HPIO *function* FUNCTION FAILED FOR *ddname* DD****Explanation**

An error occurred while processing the *function* function of High Performance I/O driver for *ddname* DD.

System action

DB Sensor processing ends with return code 8 during the SCAN process or issues U3214 during the main process.

User response

Contact IBM Software Support.

BBE3215E **UNABLE TO OBTAIN RECONID. RECON: *dsname*, RC=*return_code*, RSN=*reason_code*****Explanation**

DB Sensor failed to obtain a RECON ID from IMS Tools Knowledge Base. If DB Sensor attempts to obtain the RECON ID from the global locale, *dsname* is BSNGLOBL. If DB Sensor attempts to obtain the RECON ID from a RECON-specific locale, *dsname* indicates the name of the data set that is associated with the RECON ID. The hexadecimal values *return_code* and *reason_code* show the return code and the reason code from the RECON ID retrieval service.

System action

DB Sensor processing ends with return code 8.

User response

The probable cause of this error is that one of the following conditions occurred:

- The IMS Tools KB server is not running.
- The IMS Tools KB repositories are not configured correctly.
- The RECON ID for the RECON data sets is not defined correctly to the Input repository.

Ensure that the IMS Tools KB server is operating correctly, that the IMS Tools KB repositories are configured correctly, and that the RECON ID is defined correctly to the Input repository. If the problem persists, contact IBM Software Support.

BBE3216E **RECON ACCESS FAILED: FUNC=*function* RC=*return_code* RSN=*reason_code*****Explanation**

DB Sensor attempted to use the DBRC API to obtain the database information from DBRC. However, the DBRC API did not complete successfully.

System action

DB Sensor processing ends with return code 8.

User response

The probable cause of this error is that one of the following conditions occurred:

- DBRC (PGM=DSPURX00) could not initialize the RECON data sets (INIT.RECON).
- The database is not registered to the RECON data sets.
- IMSPLEX, DBRCGRP, and SCI exit are inconsistent with the definitions in the RECON data sets.
- The RECON version that is defined in the RECON data sets is not the same as the IMS RESLIB version that is specified to the STEPLIB.

Ensure that the DBRC and RECON definitions are correct. Browse the DB Sensor JCL (PGM=BBESNSR) and ensure that the IMSPLEX and DBRCGRP that are specified on the EXEC PARM= parameters are correct and that the SCI exit module exists in the STEPLIB data sets. In addition, check the meaning of *function*, *return_code*, and *reason_code* in the topic about Database Recovery Control (DBRC) in *IMS System Programming APIs*.

BBE3217E **DATA DICTIONARY ACCESS FAILED: FUNC=*function* RC=*rc* RSN=*rsn*****Explanation**

DB Sensor issued the IMS Tools Base Policy Service Data Dictionary API call to obtain the following data element information, but the API did not complete successfully.

- DB_PCT_NUM_FRAGD_FSE
- DB_AVG_NUM_FRAGD_FSE
- DB_PCT_NUM_NOREUSE_FSE
- DB_FLAG_SENSOR_HOME
- DB_FLAG_SEGMENT_STAT
- DBX_FLAG_SEGMENT_STAT
- DB_FLAG_SENSOR_DBINFO

System action

DB Sensor processing ends with return code 8.

User response

Contact IBM Software Support.

BBE3218E **IMS DIRECTORY ACCESS FAILED:
FUNCTION=*func* RC=*rc* RSN=*rsn*.**

Explanation

DB Sensor failed to access the IMS directory.

System action

DB Sensor processing ends with return code 8.

User response

Contact IBM Software Support.

BBE3219E ***dbdname* IS NOT FOUND IN THE
IMS DIRECTORY.**

Explanation

The DBD resource indicated by *dbdname* is not found in the IMS directory.

System action

DB Sensor processing ends with return code 8.

User response

Ensure that the correct DBD resource name is specified in the BBESIN data set. Then rerun the job.

BBE3250E **LOAD FAILED FOR *modname*
MODULE. CODE=*nnn*, RSN=*rsn***

Explanation

DB Sensor failed to load the *modname* module. The hexadecimal value *nnn* shows the system completion code and the hexadecimal value *rsn* shows the associated reason code that are returned from the LOAD macro.

System action

DB Sensor processing ends with return code 8.

User response

See *MVS System Codes* to determine the meaning of the system completion code. Correct the error and

rerun the job. If the problem persists, contact IBM Software Support.

BBE3251E **GETMAIN FAILED WITH
RC=*return_code* (SIZE=*size*) IN
modname MODULE, ERROR-ID:
*error_id***

Explanation

DB Sensor failed to obtain storage. *size* indicates the size of the storage that could not be obtained. The hexadecimal value *return_code* shows the return code that is returned from the GETMAIN macro. *modname* indicates the name of the failed module, and *error_id* indicates the error ID that is associated with the module.

System action

DB Sensor processing ends with return code 8.

User response

See the *MVS Programming: Assembler Services Reference* to determine the meaning of the return code. Correct the error and rerun the job. If the problem persists, contact IBM Software Support.

BBE3280E **OPEN FAILED. DD: *ddname*,
RC=*return_code***

Explanation

Open failed for the indicated DD.

System action

The DB Sensor Printing utility ends with return code 8.

User response

Browse the DB Sensor Printing utility JCL and ensure that the indicated DD is correctly specified. Correct the error and rerun the job. See the topic about OPEN return codes in *z/OS DFSMS Macro Instructions for Data Sets* to determine the meaning of the return code that is shown in the message.

BBE3281E **DEVTYPE FAILED. RC=*return_code*,
RSN=*reason_code*, DD: *ddname***

Explanation

The DB Sensor Printing utility failed to issue the DEVTYPE macro for the indicated DD. The hexadecimal value *return_code* shows the return code and the hexadecimal value *reason_code* shows the associated

reason code that are returned from the DEVTYPE macro.

System action

The DB Sensor Printing utility ends with return code 8.

User response

See *z/OS DFSMSdfp Advanced Services* to determine the meaning of the return code and the reason code. Correct the error and rerun the job. If the problem persists, contact IBM Software Support.

BBE3282E **DYNAMIC ALLOCATION
FAILED. RC=return_code,
RSN=reason_code, DD: ddname**

Explanation

The DB Sensor Printing utility failed to request the dynamic allocation service for the indicated DD. The

hexadecimal value *return_code* shows the return code and the hexadecimal value *reason_code* shows the associated reason code that are returned from the dynamic allocation service.

System action

The DB Sensor Printing utility ends with return code 8.

User response

See the *z/OS MVS Authorized Assembler Services Guide* to determine the meaning of the return code and the reason code. Correct the error and rerun the job. If the problem persists, contact IBM Software Support.

FP DB Sensor messages

FP Stand-alone DB Sensor and FP Integrated DB Sensor issue messages that begin with HFP.

For explanations of the HFP messages, see "Messages" in *IMS FP Solution Pack: IMS High Performance Fast Path Utilities User's Guide*.

Recovery Sensor messages (IRO)

This reference topic provides detailed information about the messages that are issued by Recovery Sensor.

Message format

Recovery Sensor messages adhere to the following format:

```
IROnnnnx
```

where:

IRO

Indicates that the message was issued by Recovery Sensor.

nnnn

Indicates the message identification number

x

Indicates the severity of the message:

A

Indicates that operator intervention is required before processing can continue.

E

Indicates that an error occurred, which might or might not require operator intervention.

I

Indicates that the message is informational only.

W

Indicates that the message is a warning to alert you to a possible error condition.

Each message also includes the following information:

Explanation:

The Explanation section explains what the message text means, why it occurred, and what its variables represent.

System action:

The System action section explains what the system will do in response to the event that triggered this message.

User response:

The User response section describes whether a response is necessary, what the appropriate response is, and how the response will affect the system or program.

Module

The Module section indicates which module or modules are affected.

IRO4001E	BPE START LFS Failed
-----------------	-----------------------------

Explanation

Module IROSENSR encountered an error when attempting to initialize BPE Limited Function Services.

System action

Processing terminates.

User response

Ensure STEPLIB is correct and send the joblog to IBM Software Support.

Module

IROSENSR

Explanation

Module IROSENSR encountered an error processing control statements.

System action

Processing terminates.

User response

Correct the control statements and rerun the job. Control statement syntax and keywords are printed to ISORPRT *ddname*.

Module

IROSENSR

IRO4002E	OPEN failed for IROSIN
-----------------	-------------------------------

Explanation

Module IROSENSR encountered an error on OPEN processing.

System action

Processing terminates.

User response

Correct the JCL to have IROSIN DD coded as DD * or a sequential data set PS FB 80 bytes.

Module

IROSENSR

IRO4004E	Multiple GLOBAL keywords not supported
-----------------	---

Explanation

Control statement error detected in IROSIN. Only one GLOBAL keyword can be specified.

System action

Processing terminates.

User response

Correct the control statements and rerun the job.

Module

IROSENSR

IRO4003E	Control Statement Error/s See IROSPRT
-----------------	--

IRO4011E	DB=xxxxxxx not defined in RECON
-----------------	--

Explanation

The database name specified in the control statement is not defined in the RECON.

System action

Processing terminates.

User response

Correct the DBD= keyword and rerun the job.

Module

IROSDBRC

IRO4012E **KY=xxxxxxx DBRC Unexpected
Block ID yyyyyy**

Explanation

An unexpected block was identified by the DSPAPI call interface.

xxxxxxx identifies the requested key and yyyyyy identifies the returned value.

System action

Processing terminates.

User response

Send a copy of the job log to IBM Software Support. Additional information might be requested.

Module

IROSDBRC

IRO4013E **DB=xxxxxxx PART=yyyyyyy
invalid partition**

Explanation

The partition name specified as yyyyyyy for database xxxxxxx does not exist in DBRC.

System action

Processing terminates.

User response

Correct the partition name in control statements and rerun the job.

Module

IROSDBRC

IRO4014E **CA=xxxxxxx Group not defined in
RECON**

Explanation

The change accumulation group identified by xxxxxxx does not exist in DBRC.

System action

Processing terminates.

User response

Correct the change accumulation group name in the control statements and rerun the job.

Module

IROSDBRC

IRO4017A **PROGRAM IS NOT AUTHORIZED**

Explanation

The Recovery Sensor program is not authorized to z/OS.

System action

Recovery Sensor ends with a return code of 8.

User response

Ensure that each data set in the STEPLIB and JOBLIB concatenation is APF-authorized.

Module

IROSENSR

Chapter 22. Gathering diagnostic information

Before you report a problem with Data Sensor to IBM Software Support, you must gather the appropriate diagnostic information.

Procedure

Provide the following information for all Data Sensor problems:

- The error messages that were issued by Data Sensor
- A clear description of the problem and the steps that are required to re-create the problem
- A complete log of the job
- If an abend has occurred, the abend dump
- If Data Sensor is used with other IMS Tools or IMS Tools Base products, messages, job logs (JOBLOG), and dumps from these products
- The version of IMS that you are using and the version of the operating system that you are using
- For FF DB Sensor or FP DB Sensor problems, a Load Module/Macro APAR Status report

For information about creating a Load Module/Macro APAR Status report, see the following topics:

- [Chapter 23, “Diagnostics Aid for FF Stand-alone DB Sensor,” on page 161](#)
- [Chapter 24, “Diagnostics Aid for FP Stand-alone DB Sensor,” on page 167](#)

Chapter 23. Diagnostics Aid for FF Stand-alone DB Sensor

If you have a problem with FF Stand-alone DB Sensor that you think is not a user error, use the Diagnostics Aid to collect the necessary information before you contact IBM Software Support.

1. Run Diagnostics Aid (HPSCDIAG) and obtain the DB Sensor Load Module APAR Status report.
2. Attach the report to the other diagnostic documents (such as job dump list or I/O of the utility).
3. Report the error to IBM.

Diagnostics Aid (HPSCDIAG) generates the DB Sensor Load Module APAR Status report for the DB Sensor maintenance by IBM. This report shows the latest APAR fixes applied to each module and macro of DB Sensor components.

Topics:

- [“How to run FF DB Sensor Diagnostics Aid with JCL stream” on page 161](#)
- [“FF DB Sensor Diagnostics Aid APAR status reports” on page 162](#)
- [“FF DB Sensor Diagnostic Aid messages and codes” on page 163](#)

How to run FF DB Sensor Diagnostics Aid with JCL stream

To run Diagnostics Aid (HPSCDIAG), supply an EXEC statement and a DD statement that defines the output data set.

EXEC

This statement must be in the following form:

```
//stepname EXEC PGM=HPSCDIAG
```

STEPLIB DD

This statement points to the load module library data set where HPSCDIAG load module resides:

```
//STEPLIB DD DISP=SHR,DSN=HPS.SHPSLMD0
```

where HPS.SHPSLMD0 is the name of the library that contains the DB Sensor load modules.

SHPSLMD DD

This statement defines the library containing the DB Sensor load modules (typically HPS.SHPSLMD0) for which you have a problem.

If this DD statement is not provided, or if DD DUMMY is specified, the DB Sensor Load Module APAR Status report is not generated.

It is always recommended that you specify this DD statement.

SHPSMAC DD

This statement defines the library containing the provided DB Sensor macros (typically HPS.SHPSMAC0) for which you have a problem.

If this DD statement is not provided, or if DD DUMMY is specified, the DB Sensor Macro APAR Status report is not generated.

SYSPRINT DD

This output data set contains the DB Sensor Load Module/Macro APAR Status report. The data set contains 133-byte, fixed-length records. It can reside on a tape, direct-access device, or printer; or it can be routed through the output stream. If BLKSIZE is coded in the DD statement, it must be a multiple of 133. However, it is recommended that you use the following:

FF DB Sensor Diagnostics Aid APAR status reports

Diagnostics Aid (HPSCDIAG) generates the following two reports for the DB Sensor maintenance by IBM:

- DB Sensor Load Module APAR Status report
- DB Sensor Macro APAR Status report

DB Sensor Load Module APAR Status report

The DB Sensor Load Module APAR Status report contains information about the modules and their applied APARs.

This report contains the following information:

MODULE LIBRARY

This includes the data set names specified in the SHPSLMD DD statement. If more than 30 data sets are concatenated, only the first 30 are listed.

MODULE NAME

This is the name of either the load module member or the alias that belongs to the DB Sensor feature.

ALIAS-OF

This is the name of the original member of the alias. If the module name is not an alias, this field is left blank.

CSECT NAME

This is the name of the CSECT included in the module. The CSECT names are listed in the order in which they are included in the module.

APAR NUMBER

This is the latest APAR number applied to the module represented by the CSECT name. If no APAR is applied, NONE is shown.

APAR FIX-DATE

This is the date on which the modification for the module represented by the CSECT name was prepared. If no APAR is applied, N/A is shown.

Notes:

1. If the CSECT name does not start with *HPS*, or if the program structure of the CSECT does not identify the APAR number and the APAR fixed date as specified by the DB Sensor module standard, the fields APAR NUMBER and APAR FIX-DATE are filled with asterisks (*).
2. If the load module is a member of the PDSE library, the following statement is shown on the report line and the job completes with a return code of 4.

```
** IT CAN NOT BE ANALYZED DUE TO PDSE LIBRARY MEMBER **
```

3. If the load macro for a DB Sensor member fails, the following statement is shown on the report line and the job completes with a return code of 8.

```
** IT CAN NOT BE ANALYZED DUE TO LOAD FAILED MEMBER **
```

DB Sensor Macro APAR Status report

The DB Sensor Macro APAR Status report contains information about macros and their applied APARs.

This report contains the following information:

MACRO LIBRARY

This includes the data set names specified in the SHPSMAC DD statement. If more than 30 data sets are concatenated, only the first 30 are listed.

MACRO NAME

This is the name of either the macro member or the alias that belongs to the DB Sensor feature.

ALIAS-OF

This is the name of the original member of the alias. If the macro name is not an alias, this field is left blank.

APAR NUMBER

This is the latest APAR number applied to the macro. If no APAR is applied, NONE is shown.

APAR FIX-DATE

This is the date on which the macro was modified. If no APAR is applied, N/A is shown.

Note: If the macro source statement structure does not identify the APAR number and the APAR fixed date as specified in the DB Sensor macro standard, the fields APAR NUMBER and APAR FIX-DATE are filled with asterisks (*).

FF DB Sensor Diagnostic Aid messages and codes

The following topics describe the return codes, abend codes, and messages issued by Diagnostics Aid.

FF DB Sensor Diagnostics Aid return codes

HPSCDIAG contains the following return codes:

- 0** Successful completion of the program.
- 4** Warning messages were issued, but the requested operation was completed.
- 8** Error messages were issued, but the request operation was completed.

FF DB Sensor Diagnostics Aid abend codes

All 36xx abend codes are accompanied by an HPSD36xx message. Refer to the appropriate message for problem determination.

FF DB Sensor Diagnostics Aid messages

The HPSD messages are issued by the Diagnostic Aid.

HPSD1001I	HPSCDIAG ENDED NORMALLY	Explanation
<p>Explanation</p> <p>This message is generated when HPSCDIAG has been completed successfully.</p> <p>System action</p> <p>HPSCDIAG completes the job successfully with a return code of 0.</p> <p>User response</p> <p>None. This message is informational.</p>		<p>This message is generated when trivial error conditions are encountered by HPSCDIAG.</p> <p>System action</p> <p>HPSCDIAG ends with a return code of 4.</p> <p>User response</p> <p>Refer to other messages generated by Diagnostic Aid to determine the nature and the cause of the detected errors. Correct the problem, and rerun the job.</p>
HPSD1002W	HPSCDIAG ENDED WITH WARNINGS	Explanation
<p>Explanation</p> <p>This message is generated when severe error conditions are encountered by HPSCDIAG.</p>		<p>HPSD1003E HPSCDIAG ENDED WITH ERRORS</p>

System action

HPSCDIAG ends with a return code of 8.

User response

Refer to other messages generated by HPSCDIAG to determine the nature and the cause of the detected errors. Correct the problem, and rerun the job.

HPSD1005W [SHPSLMD | SHPSMAC] DD
STATEMENT NOT FOUND

Explanation

HPSCDIAG could not find the SHPSLMD or SHPSMAC DD statement.

System action

HPSCDIAG sets an end-of-job return code of 4 and continues processing. HPSCDIAG does not generate a report for the load module or the macro.

User response

If you intended to specify the indicated DD statement, correct the error, and rerun the job.

HPSD1006W DUPLICATE *member name* IN
LIBRARY DDNAME *ddname*

Explanation

HPSCDIAG found a duplicated member in the concatenated libraries.

System action

HPSCDIAG uses the member that is first found in the concatenated libraries. HPSCDIAG sets an end-of-job return code of 4 and continues processing.

User response

Make sure which libraries have correct module/macro libraries. Correct the error, and rerun the job if necessary.

HPSD1007W DUMMY SPECIFIED FOR
[SHPSLMD | SHPSMAC] DD
STATEMENT

Explanation

DUMMY was specified for the SHPSLMD or SHPSMAC DD statement.

System action

HPSCDIAG sets an end-of-job return code of 4 and continues processing. HPSCDIAG does not generate a report for the load module or the macro.

User response

If you did not intend to specify the dummy DD statement, correct the error, and rerun the job.

HPSD1008W NO IMS DB REORG EXPERT
[MODULE | MACRO] MEMBERS
FOUND IN DDNAME [SHPSLMD |
SHPSMAC]

Explanation

HPSCDIAG could not find any DB Sensor modules or macros members from the DD ddname data set.

System action

HPSCDIAG sets an end-of-job return code of 4 and continues processing.

User response

Ensure that the libraries have correct DB Sensor module or macro libraries. Correct the error and rerun the job.

HPSD2001E LOAD FAILED FOR DDNAME
ddname MODULE *member*

Explanation

HPSCDIAG could not load a *member name* from *ddname*.

System action

HPSCDIAG sets an end-of-job return code of 8 and continues processing.

User response

Make sure that the member indicated exists in the data set specified for the indicated *ddname*. Correct the error, and rerun the job.

HPSD3600E OPEN FAILED FOR DDNAME
ddname

Explanation

The named DCB could not be opened.

System action

HPSCDIAG ends with an abend code of U3600.

User response

Make sure that a *ddname* DD statement exists, and that it specifies the correct DD parameter. Correct any errors, and rerun the job.

HPSD3601E GET FAILED FOR DDNAME *ddname*

Explanation

The GET failed for a directory from the DD *ddname* data set.

System action

HPSCDIAG ends with an abend code of U3601.

User response

Refer to the MVS™ system message and its programmer response. Correct the error, and rerun HPSCDIAG. If the error persists, contact IBM Software Support.

HPSD3602E READ FAILED FOR DDNAME *ddname* MEMBER *member*

Explanation

The READ failed for a *member* from the DD *ddname* data set.

System action

HPSCDIAG ends with an abend code of U3602.

User response

Refer to the MVS system message and its programmer response. Correct the error, and rerun HPSCDIAG. If the error persists, contact IBM Software Support.

HPSD3603E BLDL FAILED FOR DDNAME *ddname* MEMBER *member*

Explanation

The *member* was not found when the BLDL macro searched the PDS directory for the *ddname*.

System action

HPSCDIAG ends with an abend code of U3603.

User response

Make sure that the member indicated exists in the data set specified for the indicated *ddname*. Correct the error, and rerun the job. If the error persists, contact IBM Software Support.

HPSD3604E LOAD FAILED FOR DDNAME *ddname* MODULE *member*

Explanation

HPSCDIAG could not load the *member name* from the *ddname*.

System action

HPSCDIAG ends with an abend code of U3604.

User response

Refer to the MVS system message and its programmer response. Correct the error, and rerun HPSCDIAG. If the error persists, contact IBM Software Support.

HPSD3605E DELETE FAILED FOR MODULE *member*

Explanation

HPSCDIAG could not delete a *member name*.

System action

HPSCDIAG ends with an abend code of U3605.

User response

Contact IBM Software Support.

HPSD3606E PUT FAILED FOR SYSPRINT

Explanation

HPSCDIAG could not put report data in SYSPRINT.

System action

HPSCDIAG ends with an abend code of U3606.

User response

Refer to the MVS system message and its programmer response. Correct the error, and rerun HPSCDIAG. If the error persists, contact IBM Software Support.

HPSD3607E OPEN FAILED FOR SYSPRINT

Explanation

SYSPRINT DCB could not be opened.

System action

HPSCDIAG ends with an abend code of U3607.

User response

Make sure that a *ddname* SYSPRINT DD statement exists, and that it specifies the correct DD parameter. Correct any errors, and rerun the job.

HPSD3608E **FIND FAILED FOR DDNAME**
ddname MEMBER *member*

Explanation

The FIND failed for a *member* from DDNAME *ddname* data set.

System action

HPSCDIAG ends with an abend code of U3608.

User response

Make sure that the member indicated exists in the data set specified for the indicated *ddname*. Correct the error, and rerun the job. If the error persists, contact IBM Software Support.

HPSD3609E **DEVTYPE FAILED FOR DDNAME**
ddname

Explanation

The DEVTYPE failed for a DDNAME *ddname* data set.

System action

HPSCDIAG ends with an abend code of U3609.

User response

Contact IBM Software Support.

HPSD3610E **RDJFCB FAILED FOR DDNAME**
ddname

Explanation

The READJFCB failed for a DDNAME *ddname* data set.

System action

HPSCDIAG ends with an abend code of U3610.

User response

Contact IBM Software Support.

HPSD3611E **GETMAIN FAILED. INSUFFICIENT**
STORAGE TO RUN THE JOB

Explanation

Workspace for HPSCDIAG could not be obtained.

System action

HPSCDIAG ends with an abend code of U3611.

User response

Increase the region size, and rerun the job.

HPSD3612E **TOO MANY IMS DB REORG**
EXPERT MODULE MEMBERS
DETECTED IN DDNAME [SHPSMOD
| SHPSMAC]

Explanation

Too many DB Sensor members are in the SHPSMOD or SHPSMAC DD data set.

System action

HPSCDIAG ends with an abend code of U3612.

User response

Specify the correct data set for the indicated DD statement, and rerun the job.

Chapter 24. Diagnostics Aid for FP Stand-alone DB Sensor

If you have a problem with FP Stand-alone DB Sensor that you think is not a user error, use the Diagnostics Aid to collect the necessary information before you contact IBM Software Support.

After you obtain the Load Module/Macro APAR Status report, attach it to the other diagnostic documents (such as job dump list or I/O of the utility), and contact IBM Software Support. The diagnostics aid generates a Load Module/Macro APAR Status report. This report shows the latest APAR fixes that were applied to each module and macro.

The diagnostics aid program is HFPUDIAG, which is the alias name of FABADIAG. You can invoke the diagnostics aid program by using either HFPUDIAG or FABADIAG.

Topics:

- [“How to run FP DB Sensor Diagnostics Aid with JCL” on page 167](#)
- [“FP DB Sensor Diagnostics Aid APAR status reports” on page 168](#)
- [“FP DB Sensor Diagnostics Aid messages and codes” on page 169](#)

How to run FP DB Sensor Diagnostics Aid with JCL

To run the diagnostics aid program, supply an EXEC statement and a DD statement that defines the output data set.

Procedure

1. Specify the EXEC statement. It must be in the following form:

```
//stepname EXEC PGM=HFPUDIAG
```

2. Specify a DD statement.

STEPLIB

This statement defines the library that contains the HFPUDIAG program (usually *prefix.SHFPLMD0*).

SHPSLMD

This statement defines the library that contains the load modules (usually *prefix.SHFPLMD0*) for which you have a problem.

The Load Module APAR Status report is not generated if this DD statement is not provided or if DD DUMMY is specified.

It is recommended that you specify this DD statement.

SHPSMAC

This statement defines the library that contains the macros (usually *prefix.SHFPLMD0*) for which you have a problem.

The Macro APAR Status report is not generated if this DD statement is not provided or if DD DUMMY is specified.

SYSPRINT

This output data set contains the Load Module/Macro APAR Status report. The data set contains 133-byte, fixed-length records. It can reside on a tape, direct-access device, or printer; or it can be routed through the output stream. If BLKSIZE is coded in the DD statement, it must be a multiple of 133. However, it is recommended that you use:

```
//SYSPRINT DD SYSOUT=A
```

3. Run the JCL.

FP DB Sensor Diagnostics Aid APAR status reports

The diagnostics aid generates two reports for maintenance by IBM.

The generated reports are:

- Load Module APAR Status report
- Macro APAR Status report

DB Sensor Load Module APAR Status report

The Load Module APAR Status report contains information about the modules and their applied APARs.

This report contains the following information:

MODULE LIBRARY

This includes the data set names that were specified in the SHPSLMD DD statement. If more than 30 data sets are concatenated, only the first 30 data sets are listed.

MODULE NAME

This is the name of the load module member or the alias.

ALIAS-OF

This is the name of the original member of the alias. If the module name is not an alias, this field is left blank.

CSECT NAME

This is the name of the included CSECT in the module. The CSECT names are reported in the included order in the module.

APAR NUMBER

This is the latest APAR number that was applied to the module that is represented by the CSECT name. If no APAR is applied, NONE is shown.

APAR FIX-DATE

This is the date when the modification was prepared for the module that is represented by the CSECT name. If no APAR is applied, N/A is shown.

Notes:

1. If the CSECT name does not start with *FAB*, *HPS*, *HFP*, *FPX* or the program structure of the CSECT does not conform to the IMS HP Fast Path Utilities module standard to identify the APAR number and the APAR fixed date, the fields APAR NUMBER and APAR FIX-DATE are filled with asterisks (*).
2. If the load module is a member of the PDSE library, the following statement is shown on the report line, and the job completes with a return code of 4.

```
** IT CAN NOT BE ANALYZED DUE TO PDSE LIBRARY MEMBER **
```

3. If the load macro fails for a utility member, the following statement is shown on the report line, and the job completes with a return code of 8.

```
** IT CAN NOT BE ANALYZED DUE TO LOAD FAILED MEMBER **
```

DB Sensor Macro APAR Status report

The Macro APAR Status report contains information about macros and their applied APARs.

This report contains the following information:

MACRO LIBRARY

This includes the data set names that were specified in the SHPSMAC DD statement. If more than 30 data sets are concatenated, only the first 30 data sets are listed.

MACRO NAME

This is the name of the macro member or the alias.

ALIAS-OF

This is the name of the original member of the alias. If the macro name is not an alias, this field is left blank.

APAR NUMBER

This is the latest APAR number that was applied to the macro. If no APAR is applied, NONE is shown.

APAR FIX-DATE

This is the date when the modification was prepared for the macro. If no APAR is applied, N/A is shown.

Note: If the macro source statement structure does not conform to the IMS HP Fast Path Utilities macro standard to identify the APAR number and the APAR fixed date, the fields APAR NUMBER and APAR FIX-DATE are filled with asterisks (*).

FP DB Sensor Diagnostics Aid messages and codes

The following topics describe the return codes, abend codes, and messages issued by Diagnostics Aid.

FP DB Sensor Diagnostics Aid return codes

FABADIAG contains the following return codes:

0

The program has been completed successfully.

4

Warning messages were issued, but the requested operation was completed.

8

Error messages were issued, but the requested operation was completed.

FP DB Sensor Diagnostics Aid abend codes

All abend codes are accompanied by a FABUxxxx message. Refer to the appropriate message for problem determination.

FP DB Sensor Diagnostics Aid messages

The FABU messages are issued by the Diagnostics Aid.

FABU1001I DIAG ENDED NORMALLY

Explanation

This message is generated when trivial error conditions are encountered by Diagnostics Aid.

Explanation

This message is generated when Diagnostics Aid has completed successfully.

System action

Diagnostics Aid ends with a return code of 4.

System action

Diagnostics Aid completes the job successfully with a return code of 0.

User response

See other messages generated by Diagnostics Aid to determine the nature and the cause of the detected errors. Correct the problem, and rerun the job.

User response

None. This message is informational.

FABU1003E DIAG ENDED WITH ERRORS

FABU1002W DIAG ENDED WITH WARNINGS

Explanation

This message is generated when severe error conditions are encountered by Diagnostics Aid.

System action

Diagnostics Aid ends with a return code of 8.

User response

See other messages generated by Diagnostics Aid to determine the nature and the cause of the detected errors. Correct the problem, and rerun the job.

FABU1005W [SHPSLMD | SHPSMAC] DD STATEMENT NOT FOUND

Explanation

Diagnostics Aid could not find the SHPSLMD/SHPSMAC DD statement.

System action

Diagnostics Aid sets an end-of-job return code of 4 and continues processing. Diagnostics Aid does not generate a report for the load module or the macro.

User response

If you intended to specify the specified DD statement, correct the error and rerun the job.

FABU1006W DUPLICATE *member name* IN LIBRARY DDNAME *ddname*

Explanation

Diagnostics Aid found a duplicated member in the concatenated libraries.

System action

Diagnostics Aid uses the member which is first found in the concatenated libraries. Diagnostics Aid sets an end-of-job return code of 4 and continues processing.

User response

Make sure that the appropriate libraries have correct module/macro libraries. Correct the error, and rerun the job if necessary.

FABU1007W DUMMY SPECIFIED FOR [SHPSLMD | SHPSMAC] DD STATEMENT

Explanation

DUMMY was specified for the SHPSLMD/SHPSMAC DD statement.

System action

Diagnostics Aid sets an end-of-job return code of 4 and continues processing. Diagnostics Aid does not generate a report for the load module or the macro.

User response

If you did not intend to specify the dummy DD statement, correct the error and rerun the job.

FABU1008W NO [MODULE | MACRO] MEMBERS FOUND IN DDNAME [SHPSLMD | SHPSMAC]

Explanation

Diagnostics Aid could not find any utility modules or macros members from the DD ddname data set.

System action

Diagnostics Aid sets an end-of-job return code of 4 and continues processing.

User response

Make sure that the libraries have correct utility module or macro libraries. Correct the error, and rerun the job.

FABU2001E LOAD FAILED FOR DDNAME *ddname* MODULE *member*

Explanation

Diagnostics Aid could not load a member name from *ddname*.

System action

Diagnostics Aid sets an end-of-job return code of 8 and continues processing.

User response

Make sure that the member specified exists in the data set specified for the specified *ddname*. Correct the error, and rerun the job.

FABU3600E OPEN FAILED FOR DDNAME *ddname*

Explanation

The named DCB could not be opened.

System action

Diagnostics Aid ends with an abend code of U3600.

User response

Make sure that a *ddname* DD statement exists, and that it specifies the correct DD parameter. Correct any errors, and rerun the job.

FABU3601E GET FAILED FOR DDNAME *ddname*

Explanation

The GET failed for a directory from the DD *ddname* data set.

System action

Diagnostics Aid ends with an abend code of U3601.

User response

See the MVS system message and programmer response. Correct the error, and rerun Diagnostics Aid. If the error persists, contact IBM Software Support.

FABU3602E READ FAILED FOR DDNAME *ddname* MEMBER *member*

Explanation

The READ failed for a *member* from the DD *ddname* data set.

System action

Diagnostics Aid ends with an abend code of U3602.

User response

See the MVS system message and programmer response. Correct the error, and rerun Diagnostic Aids. If the error persists, contact IBM Software Support.

FABU3603E BLDL FAILED FOR DDNAME *ddname* MEMBER *member*

Explanation

The *member* was not found when the BLDL macro searched the PDS directory for the *ddname*.

System action

Diagnostics Aid ends with an abend code of U3603.

User response

Make sure that the member specified exists in the data set specified for the specified *ddname*. Correct the error and rerun the job. If the error persists, contact IBM Software Support.

FABU3604E LOAD FAILED FOR DDNAME *ddname* MODULE *member*

Explanation

Diagnostics Aid could not load the member name from the *ddname*.

System action

Diagnostics Aid ends with an abend code of U3604.

User response

See the MVS system message and programmer response. Correct the error, and rerun Diagnostics Aid. If the error persists, contact IBM Software Support.

FABU3605E DELETE FAILED FOR MODULE *member*

Explanation

Diagnostics Aid could not delete a *member name*.

System action

Diagnostics Aid ends with an abend code of U3605.

User response

Contact IBM Software Support.

FABU3606E PUT FAILED FOR SYSPRINT

Explanation

Diagnostics Aid could not put report data in SYSPRINT.

System action

Diagnostics Aid ends with an abend code of U3606.

User response

See the MVS system message and programmer response. Correct the error and rerun Diagnostics Aid. If the error persists, contact IBM Software Support.

FABU3607E OPEN FAILED FOR SYSPRINT

Explanation

SYSPRINT DCB could not be opened.

System action

Diagnostics Aid ends with an abend code of U3607.

User response

Make sure that a *ddname* SYSPRINT DD statement exists, and that it specifies the correct DD parameter. Correct any errors, and rerun the job.

**FABU3608E FIND FAILED FOR DDNAME
 ddname MEMBER *member***

Explanation

The FIND failed for a *member* from DDNAME *ddname* data set.

System action

Diagnostics Aid ends with an abend code of U3608.

User response

Make sure that the member specified exists in the data set specified for the specified *ddname*. Correct the error, and rerun the job. If the error persists, contact IBM Software Support.

**FABU3609E DEVTYPE FAILED FOR DDNAME
 *ddname***

Explanation

The DEVTYPE failed for a DDNAME *ddname* data set.

System action

Diagnostics Aid ends with an abend code of U3609.

User response

Contact IBM Software Support.

**FABU3610E RDJFCB FAILED FOR DDNAME
 *ddname***

Explanation

The READJFCB failed for a DDNAME *ddname* data set.

System action

Diagnostics Aid ends with an abend code of U3610.

User response

Contact IBM Software Support.

**FABU3611E GETMAIN FAILED. INSUFFICIENT
 STORAGE TO RUN THE JOB**

Explanation

Work space for Diagnostics Aid could not be obtained.

System action

Diagnostics Aid ends with an abend code of U3611.

User response

Increase the region size, and rerun the job.

**FABU3612E TOO MANY [MODULE | MACRO]
 MEMBERS DETECTED IN DDNAME
 [SHPSMOD | SHPSMAC]**

Explanation

There are too many IMS DBT members in the SHPSMOD/SHPSMAC DD data set.

System action

Diagnostics Aid ends with an abend code of U3612.

User response

Specify the correct data set for the specified DD statement, and rerun the job.

Part 6. Reference

Use the following information to interpret syntax diagrams included in the IMS Data Sensor topics.

Topics:

- [Chapter 25, “How to read syntax diagrams,” on page 175](#)

Chapter 25. How to read syntax diagrams

The following rules apply to the syntax diagrams that are used in this information:

- Read the syntax diagrams from left to right, from top to bottom, following the path of the line. The following conventions are used:
 - The >>--- symbol indicates the beginning of a syntax diagram.
 - The ---> symbol indicates that the syntax diagram is continued on the next line.
 - The >--- symbol indicates that a syntax diagram is continued from the previous line.
 - The --->< symbol indicates the end of a syntax diagram.
- Required items appear on the horizontal line (the main path).

▶▶ *required_item* ▶▶

- Optional items appear below the main path.

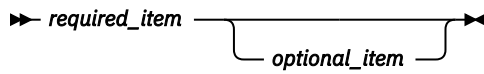

If an optional item appears above the main path, that item has no effect on the execution of the syntax element and is used only for readability.

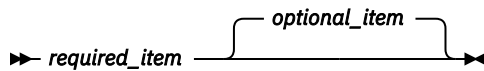

- If you can choose from two or more items, they appear vertically, in a stack.

If you *must* choose one of the items, one item of the stack appears on the main path.

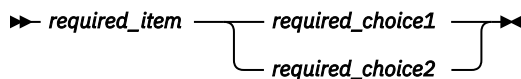

If choosing one of the items is optional, the entire stack appears below the main path.

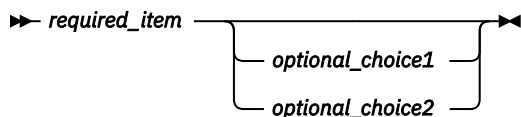

If one of the items is the default, it appears above the main path, and the remaining choices are shown below.

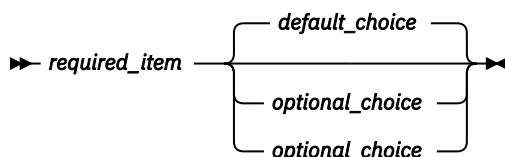

- An arrow returning to the left, above the main line, indicates an item that can be repeated.

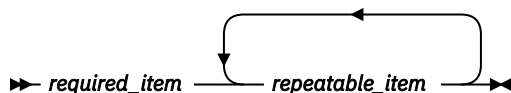

If the repeat arrow contains a comma, you must separate repeated items with a comma.

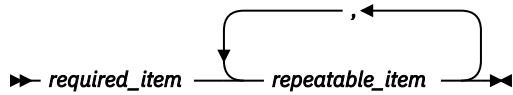

A repeat arrow above a stack indicates that you can repeat the items in the stack.

- Sometimes a diagram must be split into fragments. The syntax fragment is shown separately from the main syntax diagram, but the contents of the fragment should be read as if they are on the main path of the diagram.

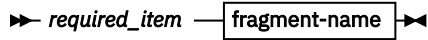

fragment-name

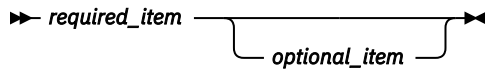

- A b symbol indicates one blank position.
- Keywords, and their minimum abbreviations if applicable, appear in uppercase. They must be spelled exactly as shown. Variables appear in all lowercase italic letters (for example, *column-name*). They represent user-supplied names or values.
- Separate keywords and parameters by at least one space if no intervening punctuation is shown in the diagram.
- Enter punctuation marks, parentheses, arithmetic operators, and other symbols exactly as shown in the diagram.
- Footnotes are shown by a number in parentheses; for example, (1).

Notices

This information was developed for products and services offered in the U.S.A.

This material may be available from IBM in other languages. However, you may be required to own a copy of the product or product version in that language in order to access it.

IBM may not offer the products, services, or features discussed in this document in other countries. Consult your local IBM representative for information on the products and services currently available in your area. Any reference to an IBM product, program, or service is not intended to state or imply that only that IBM product, program, or service may be used. Any functionally equivalent product, program, or service that does not infringe any IBM intellectual property right may be used instead. However, it is the user's responsibility to evaluate and verify the operation of any non-IBM product, program, or service.

IBM may have patents or pending patent applications covering subject matter described in this document. The furnishing of this document does not give you any license to these patents. You can send license inquiries, in writing, to:

IBM Director of Licensing
IBM Corporation
North Castle Drive
Armonk, NY 10504-1785
U.S.A.

For license inquiries regarding double-byte (DBCS) information, contact the IBM Intellectual Property Department in your country or send inquiries, in writing, to:

Intellectual Property Licensing
Legal and Intellectual Property Law
IBM Japan Ltd.
19-21, Nihonbashi-Hakozakicho, Chuo-ku
Tokyo 103-8510, Japan

The following paragraph does not apply to the United Kingdom or any other country where such provisions are inconsistent with local law: INTERNATIONAL BUSINESS MACHINES CORPORATION PROVIDES THIS PUBLICATION "AS IS" WITHOUT WARRANTY OF ANY KIND, EITHER EXPRESS OR IMPLIED, INCLUDING, BUT NOT LIMITED TO, THE IMPLIED WARRANTIES OF NON-INFRINGEMENT, MERCHANTABILITY OR FITNESS FOR A PARTICULAR PURPOSE. Some states do not allow disclaimer of express or implied warranties in certain transactions, therefore, this statement may not apply to you.

This information could include technical inaccuracies or typographical errors. Changes are periodically made to the information herein; these changes will be incorporated in new editions of the publication. IBM may make improvements and/or changes in the product(s) and/or the program(s) described in this publication at any time without notice.

Any references in this information to non-IBM Web sites are provided for convenience only and do not in any manner serve as an endorsement of those Web sites. The materials at those Web sites are not part of the materials for this IBM product and use of those Web sites is at your own risk.

IBM may use or distribute any of the information you supply in any way it believes appropriate without incurring any obligation to you.

Licensees of this program who wish to have information about it for the purpose of enabling: (i) the exchange of information between independently created programs and other programs (including this one) and (ii) the mutual use of the information which has been exchanged, should contact:

IBM Director of Licensing
IBM Corporation
North Castle Drive

Armonk, NY 10504-1785
U.S.A.

Such information may be available, subject to appropriate terms and conditions, including in some cases, payment of a fee.

The licensed program described in this information and all licensed material available for it are provided by IBM under terms of the IBM Customer Agreement, IBM International Program License Agreement, or any equivalent agreement between us.

Any performance data contained herein was determined in a controlled environment. Therefore, the results obtained in other operating environments may vary significantly. Some measurements may have been made on development-level systems and there is no guarantee that these measurements will be the same on generally available systems. Furthermore, some measurements may have been estimated through extrapolation. Actual results may vary. Users of this document should verify the applicable data for their specific environment.

This information contains examples of data and reports used in daily business operations. To illustrate them as completely as possible, the examples include the names of individuals, companies, brands, and products. All of these names are fictitious and any similarity to the names and addresses used by an actual business enterprise is entirely coincidental.

COPYRIGHT LICENSE:

This information contains sample application programs in source language, which illustrate programming techniques on various operating platforms. You may copy, modify, and distribute these sample programs in any form without payment to IBM, for the purposes of developing, using, marketing or distributing application programs conforming to the application programming interface for the operating platform for which the sample programs are written. These examples have not been thoroughly tested under all conditions. IBM, therefore, cannot guarantee or imply reliability, serviceability, or function of these programs. The sample programs are provided "AS IS", without warranty of any kind. IBM shall not be liable for any damages arising out of your use of the sample programs.

If you are viewing this information softcopy, the photographs and color illustrations may not appear.

Trademarks

IBM, the IBM logo, and [ibm.com](http://www.ibm.com)[®] are trademarks or registered trademarks of International Business Machines Corp., registered in many jurisdictions worldwide. Other product and service names might be trademarks of IBM or other companies. A current list of IBM trademarks is available on the web at "Copyright and trademark information" at <http://www.ibm.com/legal/copytrade.shtml>.

Microsoft, Windows, Windows NT, and the Windows logo are trademarks of Microsoft Corporation in the United States, other countries, or both.

Java[™] and all Java-based trademarks and logos are trademarks or registered trademarks of Oracle and/or its affiliates.

Other company, product, and service names may be trademarks or service marks of others.

Terms and conditions for product documentation

Permissions for the use of these publications are granted subject to the following terms and conditions:

Applicability: These terms and conditions are in addition to any terms of use for the IBM website.

Personal use: You may reproduce these publications for your personal, noncommercial use provided that all proprietary notices are preserved. You may not distribute, display or make derivative work of these publications, or any portion thereof, without the express consent of IBM.

Commercial use: You may reproduce, distribute and display these publications solely within your enterprise provided that all proprietary notices are preserved. You may not make derivative works of these publications, or reproduce, distribute or display these publications or any portion thereof outside your enterprise, without the express consent of IBM.

Rights: Except as expressly granted in this permission, no other permissions, licenses or rights are granted, either express or implied, to the publications or any information, data, software or other intellectual property contained therein.

IBM reserves the right to withdraw the permissions granted herein whenever, in its discretion, the use of the publications is detrimental to its interest or, as determined by IBM, the above instructions are not being properly followed.

You may not download, export or re-export this information except in full compliance with all applicable laws and regulations, including all United States export laws and regulations.

IBM MAKES NO GUARANTEE ABOUT THE CONTENT OF THESE PUBLICATIONS. THE PUBLICATIONS ARE PROVIDED "AS-IS" AND WITHOUT WARRANTY OF ANY KIND, EITHER EXPRESSED OR IMPLIED, INCLUDING BUT NOT LIMITED TO IMPLIED WARRANTIES OF MERCHANTABILITY, NON-INFRINGEMENT, AND FITNESS FOR A PARTICULAR PURPOSE.

Privacy policy considerations

IBM Software products, including software as a service solutions, ("Software Offerings") may use cookies or other technologies to collect product usage information, to help improve the end user experience, to tailor interactions with the end user or for other purposes. In many cases no personally identifiable information is collected by the Software Offerings. Some of our Software Offerings can help enable you to collect personally identifiable information. If this Software Offering uses cookies to collect personally identifiable information, specific information about this offering's use of cookies is set forth below.

This Software Offering does not use cookies or other technologies to collect personally identifiable information.

If the configurations deployed for this Software Offering provide you as customer the ability to collect personally identifiable information from end users via cookies and other technologies, you should seek your own legal advice about any laws applicable to such data collection, including any requirements for notice and consent.

For more information about the use of various technologies, including cookies, for these purposes, see IBM's Privacy Policy at <http://www.ibm.com/privacy> and the section titled "Cookies, Web Beacons, and Other Technologies" in IBM's Online Privacy Statement at <http://www.ibm.com/privacy/details>. Also, see the "IBM Software Products and Software-as-a-Service Privacy Statement" at <http://www.ibm.com/software/info/product-privacy>.

Index

A

accessibility
overview [14](#)

B

BBESIN control statement
format [27](#)
BBESPRIN control statement
format [53](#)

C

CA command
Recovery Sensor [126](#)
commands
CA
Recovery Sensor [126](#)
DATABASE
FF DB Sensor Printing utility [54](#)
FF Stand-alone DB Sensor [33](#)
FP DB Sensor Printing utility [104](#)
FP Stand-alone DB Sensor [79](#)
Recovery Sensor [125](#)
GLOBAL
FF DB Sensor Printing utility [54](#)
FF Site Default Generation utility [48](#)
FF Stand-alone DB Sensor [28](#)
FP DB Sensor Printing utility [104](#)
FP Site Default Generation utility [98](#)
FP Stand-alone DB Sensor [76](#)
Recovery Sensor [125](#)
components [8](#)
considerations
FF DB Sensor [21](#)
FP Stand-alone DB Sensor [65](#)
cookie policy [177](#)

D

DATABASE command
FF DB Sensor Printing utility [54](#)
FF Stand-alone DB Sensor [33](#)
FP DB Sensor Printing utility [104](#)
FP Stand-alone DB Sensor [79](#)
Recovery Sensor [125](#)
diagnostic information [159](#)
diagnostic messages and codes [163](#)
diagnostics aid
FF Stand-alone DB Sensor [161](#)
FP Stand-alone DB Sensor [167](#)
documentation
accessing [13](#)
sending feedback [13](#)
documentation changes [3](#)

E

examples
FF Stand-alone DB Sensor [33](#)
FP Stand-alone DB Sensor [80](#)
Recovery Sensor [126](#)

F

FABADIAG [167](#)
features [9](#)
FF DB Sensor messages [132](#)
FF DB Sensor Printing utility [51](#)
FF Site Default Generation utility
keywords [48](#)
FF Stand-alone DB Sensor [19](#)
FP DB Sensor messages [155](#)
FP DB Sensor Printing utility [101](#)
FP Site Default Generation utility
keywords [98](#)
FP Stand-alone DB Sensor [63](#)

G

GLOBAL command
FF DB Sensor Printing utility [54](#)
FF Site Default Generation utility [48](#)
FF Stand-alone DB Sensor [28](#)
FP DB Sensor Printing utility [104](#)
FP Site Default Generation utility [98](#)
FP Stand-alone DB Sensor [76](#)
Recovery Sensor [125](#)

H

HFPSPRIN control statement
format [103](#)
HFPSYSIN control statement
format [75](#)
HFPUDIAG [167](#)
HPSCDIAG [161](#)

I

IMS Tools Base [7](#)
installation requirements [15](#)
introduction [7](#)
IROSIN control statement
format [123](#)

J

JCL examples
FF Site Default Generation utility [45](#)
FF Stand-alone DB Sensor [33](#)
FP Site Default Generation utility [93](#)

JCL examples *(continued)*

- FP Stand-alone DB Sensor [80](#)
- Recovery Sensor [126](#)

JCL requirements

- FF DB Sensor Printing utility [52](#)
- FF Site Default Generation utility [47](#)
- FF Stand-alone DB Sensor [25](#)
- FP DB Sensor Printing utility [102](#)
- FP Site Default Generation utility [95](#)
- FP Stand-alone DB Sensor [69](#)
- Recovery Sensor [121](#)

K

keywords

- FF Site Default Generation utility [48](#)
- FP Site Default Generation utility [98](#)

L

legal notices

- cookie policy [177](#)
- notices [177](#)
- programming interface information [177](#)
- trademarks [177](#)

M

messages

- FF DB Sensor [132](#)
- FP DB Sensor [155](#)
- Recovery Sensor [155](#)

N

notices [177](#)

O

output

- FF DB Sensor Printing utility [54](#)
- FF Site Default Generation utility [49](#)
- FF Stand-alone DB Sensor [37](#)
- FP DB Sensor Printing utility [104](#)
- FP Site Default Generation utility [99](#)
- FP Stand-alone DB Sensor [83](#)
- Recovery Sensor [127](#)

overview [3](#), [7](#)

P

printing sensor data

- FF DB Sensor Printing utility [51](#)
- FP DB Sensor Printing utility [101](#)

process flow [10](#)

Processing report

- FP Stand-alone DB Sensor [84](#)

programming interface information [177](#)

R

reader comment form [13](#)

Recovery Sensor [117](#)

reports

- FF DB Sensor Printing utility [54](#)
- FF Site Default Generation utility [49](#)
- FF Stand-alone DB Sensor [37](#)
- FP DB Sensor Printing utility [104](#)
- FP Site Default Generation utility [99](#)
- FP Stand-alone DB Sensor [83](#)
- Recovery Sensor [127](#)

return codes

- Data Sensor [131](#)
- DB Sensor Printing utility [131](#)
- Site Default Generation utility [131](#)

Runtime summary report

- Recovery Sensor [127](#)

Runtime Summary report

- FF DB Sensor Printing utility [54](#)
- FF Stand-alone DB Sensor [37](#)
- FP DB Sensor Printing utility [104](#)
- FP Stand-alone DB Sensor [83](#)

S

screen readers and magnifiers [14](#)

Sensor Data Statistics report

- FF DB Sensor Printing utility [55](#)
- FF Stand-alone DB Sensor [38](#)
- FP DB Sensor Printing utility [105](#)
- FP Stand-alone DB Sensor [84](#)

service information [13](#)

site default values

- FF DB Sensor [45](#)
- FP DB Sensor [93](#)

Stand-alone Recovery Sensor [117](#)

summary of changes [3](#)

support information [13](#)

syntax diagrams

- how to read [175](#)

T

technotes [13](#)

terminology [12](#)

trademarks [177](#)

W

what's new [3](#)



SC19-3283-09

