

z/OS



JES2 Messages

Version 2 Release 2

z/OS



JES2 Messages

Version 2 Release 2

Note

Before using this information and the product it supports, read the information in "Notices" on page 565.

This edition applies to Version 2 Release 2 of z/OS (5650-ZOS) and to all subsequent releases and modifications until otherwise indicated in new editions.

© **Copyright IBM Corporation 1988, 2015.**

US Government Users Restricted Rights – Use, duplication or disclosure restricted by GSA ADP Schedule Contract with IBM Corp.

Contents

Tables	v	Chapter 7. Three-hundreds	201
About this document	vii	Chapter 8. Four-hundreds	225
Who should use this document	vii	Chapter 9. Five-hundreds	279
How to use this document	vii	Chapter 10. Six-hundreds	327
How Messages are Explained in this Book	vii	Chapter 11. Seven-hundreds	375
Where to find more information	viii	Chapter 12. Eight-hundreds	407
How to send your comments to IBM ..	xi	Chapter 13. Nine-hundreds	477
If you have a technical problem.	xi	Chapter 14. One-thousands	479
Summary of changes for z/OS JES2		Chapter 15. Two-thousands	501
Messages for Version 2 Release 2. ..	xiii	Chapter 16. Four-thousands	503
z/OS Version 2 Release 1 summary of changes ..	xv	Chapter 17. Five-thousands	505
Chapter 1. Introduction	1	Chapter 18. Nine-thousands	511
System log	1	Chapter 19. Health Check messages	549
Hard-copy log	1	Appendix A. PCE list	553
JES2 message format.	1	Appendix B. Accessibility	561
Messages preceded by a job identifier	2	Accessibility features	561
Multiple-line JES2 messages	3	Consult assistive technologies	561
A Method for Finding Changes to MVS and		Keyboard navigation of the user interface	561
TSO/E Message Texts	4	Dotted decimal syntax diagrams	561
JES2 message documentation	5	Notices	565
Chapter 2. Routing codes	7	Policy for unsupported hardware.	566
Specification	7	Minimum supported hardware	567
Routing code meaning	7	Programming Interface Information	567
Routing codes in this document	9	Trademarks	567
Chapter 3. Descriptor codes	13		
Association with message type code	13		
Specification	13		
Message deletion	14		
Message color	14		
Descriptor code meaning	14		
Descriptor codes in this document.	15		
Chapter 4. Zero to ninety-nine.	17		
Chapter 5. One-hundreds.	85		
Chapter 6. Two-hundreds	131		

Tables

- | | | | |
|---|---|--|---|
| 1. \$HASP messages that may start with a job identifier | 2 | 2. Multiple-line JES2 messages | 4 |
|---|---|--|---|

About this document

This document supports z/OS® (5650-ZOS).

This documents the messages issued by the JES2 element of z/OS.

Who should use this document

This document should be used by operators, system or application programmers, or by anyone who is responsible for controlling or diagnosing problems in JES2.

How to use this document

The messages in this document are organized in sections, each of which contains messages in a 100-number range. The documentation for each message includes:

- Message identifier and message text
- Explanation of the message
- Description of the action taken by JES2 after issuing the message

The documentation for a message may also include any of the following:

- Operator response
 - User response
 - Application programmer response
 - System programmer response
-

How Messages are Explained in this Book

The following describes the different parts of message explanations in this book:

Explanation

The meaning of the message, including why the system issued the message.

System Action

- What the system did as a result of the system condition reported by the message. A system condition could include running out of storage, a hardware or software failure, an abend, a wait state.
- What the system did as a result of user input. User input can include a system command, a job running on the system, a transaction, a query, or another user-system interaction.

Operator Response

Instructions for the system operator, including, as appropriate, decisions to make and actions to take.

Only provided for messages that could appear at the operator console.

User Response

Instructions for the end user.

Only provided for messages that could appear at an interactive interface such as a TSO/E terminal or ISPF application.

Note: Most user messages are explained in other message books, such as *z/OS TSO/E Messages*.

Application Programmer Response

Instructions for an application programmer.

Only provided for messages that could appear in SYSOUT produced by a job, for example SPZAP.

System Programmer Response

Instructions for the system programmer.

Only provided for messages that require additional action beyond the operator response, user response, or application programmer response.

Storage Administrator Response

Instructions for the DFSMSdfp storage administrator.

Security Administrator Response

Instructions for the security administrator.

Only provided for security-related messages.

Problem Determination

Additional instructions for determining the cause of the problem, searching problem databases, and, if necessary, reporting the problem to the IBM support center. These instructions are for a customer support person who can troubleshoot problems, such as the system programmer or system administrator, an experienced security administrator, or an experienced storage administrator.

For additional information on performing problem determination procedures, see the appropriate diagnosis guide for the product or element issuing the message, such as:

- DFSMS/MVS diagnosis guides and references
- *z/OS JES2 Diagnosis*
- *z/OS JES3 Diagnosis*

Source

Element, product, or component that issued the message.

Detecting Module

Name of the module or modules that detected the condition that caused the message to be issued.

Routing Code

For WTO or WTOR messages, the routing code of the message.

Descriptor Code

For WTO or WTOR messages, the descriptor code of the message.

Where to find more information

The document references the following documents using the shortened version of the document title. The following table lists the shortened titles, complete titles, and order numbers of the documents you might need while you are using this document that are not listed in *z/OS V2R2 Information Roadmap*. See that document for all z/OS documents.

Short title used in this document	Title	Order Number
<i>2701 Data Adapter Unit</i>	<i>2701 Data Adapter Unit Component Description</i>	GA22-6864

Short title used in this document	Title	Order Number
<i>Print Services Facility Diagnosis</i>	<i>Print Services Facility Diagnosis Guide and Reference for MVS</i>	SY35-0063
<i>PSF for z/OS Messages and Codes</i>	<i>PSF for z/OS Messages and Codes</i>	G544-5627
<i>2703 Transmission Control Component Description</i>	<i>2703 Transmission Control Component Description</i>	GA27-2703

How to send your comments to IBM

We appreciate your input on this publication. Feel free to comment on the clarity, accuracy, and completeness of the information or provide any other feedback that you have.

Use one of the following methods to send your comments:

1. Send an email to mhvrcfs@us.ibm.com.
2. Send an email from the "Contact us" web page for z/OS (<http://www.ibm.com/systems/z/os/zos/webqs.html>).

Include the following information:

- Your name and address.
- Your email address.
- Your telephone or fax number.
- The publication title and order number:
z/OS V2R2 JES2 Messages
SA32-0989-03
- The topic and page number that is related to your comment.
- The text of your comment.

When you send comments to IBM, you grant IBM a nonexclusive right to use or distribute the comments in any way appropriate without incurring any obligation to you.

IBM or any other organizations use the personal information that you supply to contact you only about the issues that you submit.

If you have a technical problem

Do not use the feedback methods that are listed for sending comments. Instead, take one of the following actions:

- Contact your IBM service representative.
- Call IBM technical support.
- Visit the IBM Support Portal at z/OS Support Portal (<http://www-947.ibm.com/systems/support/z/zos/>).

Summary of changes for z/OS JES2 Messages for Version 2 Release 2

The following lists indicate the messages that are new, changed, or no longer issued in z/OS V2R2 for z/OS JES2 Messages.

Messages that have been added, updated or that are no longer issued in an updated edition are identified by the quarter and year that the message was updated, in parentheses. For example, (4Q2015) indicates that a message was updated in the fourth quarter, 2015.

New

The following messages are new.

\$HASP148
\$HASP261
\$HASP262
\$HASP732
\$HASP734
\$HASP739
\$HASP790
\$HASP1110
\$HASP1111
\$HASP1112
\$HASP1114
\$HASP1115
\$HASP1116
\$HASP1117
\$HASP1118
\$HASP1130
\$HASP1131
\$HASP1132
\$HASP1133
\$HASP1201
\$HASP1210
\$HASP1300
\$HASP1301
\$HASP1302
\$HASP1303
\$HASP1304
\$HASP1305
\$HASP1306
\$HASP4401
\$HASP9178
\$HASP9179

Changed

The following messages are changed.

\$HASP003 (4Q2015)
\$HASP095
\$HASP101
\$HASP110 (4Q2015)
\$HASP112
\$HASP118
\$HASP119
\$HASP148 (4Q2015)
\$HASP165
\$HASP233
\$HASP237
\$HASP255
\$HASP260
\$HASP290
\$HASP292
\$HASP293
\$HASP295 (4Q2015)
\$HASP296
\$HASP305 (4Q2015)
\$HASP375
\$HASP395
\$HASP414
\$HASP436
\$HASP445
\$HASP492
\$HASP493
\$HASP686
\$HASP740
\$HASP745
\$HASP852
\$HASP890
\$HASP895 (4Q2015)
\$HASP1110 (4Q2015)
\$HASP1111 (4Q2015)
\$HASP1112 (4Q2015)
\$HASP1114 (4Q2015)
\$HASP1201 (4Q2015)
\$HASP022E
\$HASP023I
\$HASP024I
\$HASP025I
\$HASP026I

\$HASPH027I
\$HASPH028E
\$HASPH029E
\$HASPH030E

z/OS Version 2 Release 1 summary of changes

See the following publications for all enhancements to z/OS Version 2 Release 1 (V2R1):

- *z/OS V2R2 Migration*
- *z/OS Planning for Installation*
- *z/OS Summary of Message and Interface Changes*
- *z/OS V2R2 Introduction and Release Guide*

Chapter 1. Introduction

z/OS issues messages from JES2 to different locations in the following ways:

- Through the WTO and WTOR macros to operator consoles, the hard-copy log, a SYSOUT data set, or the job log for the job's system output message class. Routing codes determine where (such as the system log (SYSLOG)) the messages are to be displayed or printed.

Message routing codes provide the ability to route system operator messages to the locations where they are needed. The routing codes indicate the functional areas to which a message is to be sent. More than one routing code may be assigned to a message to send it to more than one console.

Message descriptor codes identify the type of message being written so that individual console support may determine how to handle the message. Specifically, this type of code determines how the system will display and delete the message.

- Through the WTL macro or the operator LOG command to the system log (SYSLOG).
- Through the access methods directly to an output data set or a display terminal.

System log

The system log (SYSLOG) is a SYSOUT data set provided by JES2. SYSOUT data sets are output spool data sets on direct access storage devices (DASD). Your installation should print the SYSLOG periodically. The SYSLOG consists of:

- All messages from WTL macros
- All messages entered by operator LOG commands
- Any messages routed to the SYSLOG from any system component or program
- Typically the hard-copy log

Hard-copy log

The hard-copy log is a record of all system message traffic and written to SYSLOG.

JES2 message format

JES2 messages appear on a display console or system log in the following format:

```
[hh.mm.ss] [sysname] {jobid} {@    } {Nn Mm} $HASPnnnn text           {*   }
                                                                {b[+]}
```

hh.mm.ss

The time stamp shows the time the message was issued in hours, minutes, and seconds. This display is optional and appears before the message identifier (\$HASPnnn) if your installation has entered the CONTROL (K S,MFORM=(T)) command to include the time stamp in the console message format.

sysname

The system name. This display is optional and appears before the message identifier (\$HASPnnn) if your installation has entered the CONTROL (K S,MFORM=(S)) command to include the system name in the console message format.

jobid

JES2 job identifier. This display is optional, and it appears before a subset of message identifiers (\$HASPnnn) if your installation has entered the CONTROL (K S,MFORM=(J)) command to include the job identifier in the console message format. See Table 1 for a list of the subset of messages preceded by a job identifier.

Nn Mm

The number of the node (Nn) and the multi-access spool (MAS) member (Mm).

- * Indicates a request for operator action.
- @ Indicates a request for operator action by JES2 generation modules or the remote workstation generation program (RMTGEN).
- b Blank, if no operator action is required.
- + Indicates the message is issued by JES2 generation or RMTGEN; no action is required.

\$HASP

All messages in this document are documented with the \$HASP prefix. The dollar sign (\$) is the console character defined by JES2. All JES2 messages will be preceded by \$HASP unless your installation changes the dollar sign to another character using the CONDEF CONCHAR initialization statement, the \$T CONDEF CONCHAR command, or supply the CONDEF CONCHAR statement from the console during initialization.

nnn

3 or 4 digit message serial number.

text

Message text.

Messages preceded by a job identifier

The following table identifies the JES2 messages that have a job identifier (JOBxxxx or Jxxxxxx followed by a job number) if the installation has entered the CONTROL (K S,MFORM=(J)) command to include the job identifier in the message format.

Table 1. \$HASP messages that may start with a job identifier

Number range	Number
0-100	077, 088, 096
100s	100, 101, 102, 103, 104, 105, 106, 109, 110, 111, 112, 113, 114, 115, 116, 117, 118, 119, 121, 122, 125, 128, 129, 135, 150, 151, 154, 156, 157, 158, 165, 180, 183, 185, 186, 190, 191, 197
200s	211, 219, 250
300s	301, 303, 304, 305, 308, 310, 311, 312, 313, 316, 321, 322, 323, 326, 329, 347, 349, 350, 351, 352, 353, 354, 356, 357, 359, 360, 361, 362, 363, 364, 370, 371, 373, 374, 375, 394, 395, 396, 397, 398, 399
400s	404, 406, 407, 408, 409, 410, 455, 461, 462, 463, 464
500s	513, 515, 520, 521, 522, 523, 525, 526, 527, 529, 530, 531, 532, 533, 540, 543, 546, 588, 589
600s	624, 629, 632, 635, 658, 681, 682, 686, 690, 692, 693, 694, 695
700s	704, 708, 751

Table 1. \$HASP messages that may start with a job identifier (continued)

Number range	Number
800s	800, 801, 802, 803, 804, 805, 890, 891
1000s	1300, 1301, 1302, 1305
9000s	–

Multiple-line JES2 messages

JES2 presents information in both single-line and multiple-line format. The format of multiple-line messages is different from that of single-line messages. A multiple-line message consists of:

1. A control line containing:
 - The message identifier
 - An indication of the information in the following data lines
 - A three-digit decimal connect identification number, which varies.
2. Two or more data lines. The number of lines varies with the amount of information displayed.

The following figure is an example of a multiple-line message.

```
$HASP826 NODE(1) 239
$HASP826 NODE(1) NAME=POK,STATUS=OWNNODE,
$HASP826 AUTH=(DEVICE=NO,JOB=YES,NET=NO,
$HASP826 SYSTEM=YES),TRANSMIT=BOTH,
$HASP826 RECEIVE=BOTH,HOLD=NONE,PENCRYPT=NO,
$HASP826 REST=0,COMPACT=0,LINE=0,
$HASP826 LOGMODE=,PASSWORD=(VERIFY=(NOTSET)),
$HASP826 SEND=(NOTSET)),PATHMGR=YES,PRIVATE=NO,
$HASP826 SUBNET=,TRACE=NO
```

If JES2 is responding to a request for information about a range of devices that requires multiple lines, a multiple-line message will be issued for each device. For example, \$D NODE(1-3) causes JES2 to display three multiple-line messages: one each for node 1, 2, and 3.

If a message that JES2 issues as a multiple-line message does not contain enough information to span more than one line, JES2 issues that message in single-line format. This occurs when:

- JES2 uses the message to display information for various devices that do not contain enough information to create more than a single line of message data.
- JES2 responds to a command that limits the information for a device to a single line. For example, by entering the \$D NODE(POK),STATUS command, the following single-line message is issued:

```
$HASP826 NODE(3) STATUS=(PENDING/POK)
```

When automating messages, it is recommended that your automation program determine how many lines are contained in the message. If there is more than one line, your automation program should process the first line as the control line of a multiple-line message. Table 2 on page 4 lists the message identifiers for the messages that JES2 issues as multiple-line messages.

JES2 cannot issue some of the messages listed in single-line format.

Table 2. Multiple-line JES2 messages

Multi-line JES2 messages				
003	005	077	088	185
231	249	270	271	273
276	278	280	281	282
284	286	287	288	289
290	291	292	293	312
321	365	416	458	468
477	478	480	482	486
503	504	603	608	621
636	648	650	667	686
690	698	715	776	777
778	779	780	783	785
786	787	788	789	790
815	816	818	819	820
821	822	823	824	826
827	829	830	831	832
833	834	835	836	837
838	839	840	841	842
843	844	845	846	847
848	849	852	878	879
880	881	882	883	884
885	886	890	891	892
893				

A Method for Finding Changes to MVS and TSO/E Message Texts

Automation routines are sensitive to changes to message text between releases. You can find changes to message texts in the following ways:

- The Summary of Changes of the related messages book can be helpful when you go from one release to the next.
- Data set SYS1.MSGENU contains data that can help you identify changes to message texts more accurately. This method allows you to find message text changes between your current release and whatever release you choose to migrate to. This method is described below.

Using SYS1.MSGENU to Find Message Text Changes

IBM supplies a data set containing the text of system messages that are translated. This data set, called SYS1.MSGENU, contains the text of system messages in the form of message skeletons. (For more information, see *z/OS MVS Planning: Operations*.)

Note that this method will not show changes to:

- MVS system messages that are not translated, such as IPL and NIP messages (which are issued before the MVS message service is available)
- Other product messages that are not translated, such as DFSMS/MVS messages, and JES3 messages.
- For JES2 messages, use the appropriate SYS1.SHASMENU data set.

Also, this method works better if the “old” copy of SYS1.SHASMENU has the same level of service as the system from which you are migrating.

You can compare the new data set with the data set on the system from which you are migrating. Depending on how you do the comparison, you can get output like the following.

For new messages, the output might show an I (for Insert) on the left:

```
I - IEA403I      VALUE OF RMAX HAS BEEN CHANGED TO 99
```

For messages whose text has changed, the output might show both an I and a D, indicating that a record in the message file has been replaced:

```
I - IEE162I 46  &NNN. ROLL &A. MESSAGES (DEL=R OR RD)
D - IEE162I 46  &NNN. ROLL &A. MESSAGES (DEL=R, RD)
```

This means that, in message IEE162I, (DEL=R, RD) was replaced by (DEL=R OR RD).

Using this information, you can decide if your automation routines need to be changed.

JES2 message documentation

Some messages have optional fields in the text; these are fields that appear in the messages only under certain circumstances. In this document, optional fields are shown enclosed in brackets:

```
$HASPnnn message text [optional field]
```

Some messages have alternative fields; that is, under certain circumstances one field will appear, and under other circumstances another field will appear. One of the alternative fields appear when the message appears on your console. In this document, alternative fields are shown stacked one above the other, enclosed in braces:

```
$HASPnnn message text {first alternative }
                        {second alternative }
```

Each message description includes the following sections:

\$HASPnnn message text

Message identifier and text.

Explanation

Explains why the message was issued.

System Action

Explains the action JES2 takes.

Operator Response

Describes any actions the operator should take to correct the problem. (This section is omitted if there is no operator action necessary.)

Application Programmer Response

Describes any actions the application programmer should take to correct the problem. (This section is omitted if there is no application programmer action necessary.)

User Response

Describes any action the user should take to correct the problem, such as resubmitting a job. (This section is omitted if there is no user action necessary.)

System Programmer Response

Describes any actions system programmer should take to correct the problem. (This section is omitted if there is no system programmer action necessary.)

Chapter 2. Routing codes

Routing codes send system messages to the consoles where they are to be displayed. More than one routing code can be assigned to a message to send it to more than one console. For more information on message routing, see the following documents:

- *z/OS MVS Programming: Authorized Assembler Services Guide*
- *z/OS MVS Programming: Authorized Assembler Services Reference SET-WTO*
- *z/OS MVS Installation Exits*
- *z/OS MVS Initialization and Tuning Reference*

Specification

The routing codes are specified in the ROUTCDE parameter of the WTO or WTOR macro. If you specify a message which contains no routing codes, MVS™ may provide one or more default routing codes, based upon the presence or lack of other queuing specifications.

If you specify a message containing descriptor codes but no routing codes and no target console, MVS will not assign any routing codes but will attempt to queue the message to the console with master authority.

If you specify a message containing no routing codes, no descriptor codes, and no target console, MVS will assign a default set of routing codes. This set of default routing codes is specified at MVS initialization on the DEFAULT statement in your CONSOLxx parmlib member. If a set of default routing codes was not provided on the DEFAULT statement, MVS will assign routing codes 1 through 6.

Routing code meaning

Code	Meaning
------	---------

1	Operator Action
----------	------------------------

The message indicates a change in the system status. It demands action by the operator at the console with master authority.

2	Operator Information
----------	-----------------------------

The message indicates a change in system status. It does not demand action; rather, it alerts the operator at the console with master authority to a condition that might require action.

This routing code is used for any message that indicates job status when the status is not requested specifically by an operator inquiry. It is also used to route processor and problem program messages to the system operator.

3	Tape Pool
----------	------------------

The message gives information about tape devices, such as the status of a tape unit or reel, the disposition of a tape reel, or a request to mount a tape.

4	Direct Access Pool
----------	---------------------------

The message gives information about direct access storage devices (DASD), such as the status of a direct access unit or volume, the disposition of a volume, or a request to mount a volume.

5 Tape Library

The message gives tape library information, such as a request by volume serial numbers for tapes for system or problem program use.

6 Disk Library

The message gives disk library information, such as a request by volume serial numbers for volumes for system or problem program use.

7 Unit Record Pool

The message gives information about unit record equipment, such as a request to mount a printer train.

8 Teleprocessing Control

The message gives the status or disposition of teleprocessing equipment, such as a message that describes line errors.

9 System Security

The message gives information about security checking, such as a request for a password.

10 System/Error Maintenance

The message gives problem information for the system programmer, such as a system error, an uncorrectable I/O error, or information about system maintenance.

11 Programmer Information

The message is intended for the problem programmer. This routing code is used when the program issuing the message cannot route the message to the programmer through a system output (SYSOUT) data set. The message appears in the job log.

12 Emulation

The message gives information about emulation. (These message identifiers are not included in this document.)

13-20 For customer use only.

21-28 For subsystem use only.

29 For disaster recovery.

30-40 For IBM[®] use only.

41 The message gives information about JES3 job status.

42 The message gives general information about JES2 or JES3.

43-64 For JES use only.

65-96 Messages associated with particular processors.

97-128 Messages associated with particular devices.

Routing codes in this document

Routing codes appear to the right of the message identifiers in the **Routing Code** column. The column can also contain the following special characters or notes:

- * The message will be routed back to the consoles that initiated the associated requests.
- / The message will be routed to different locations according to the task issuing it. For example, */2/3 means the message is routed back to the console that initiated the request, to the console with master authority, or to the tape pool.
- # The message will be routed in one of the following ways:
 - According to the routing indicators specified by the operator
 - According to the default routing instructions previously specified by the operator
 - Back to the console that initiated the associated request
- The message has no routing code.

Note 2

The message is issued by a WTO or WTOR macro, but has no routing or descriptor codes (old format WTO or WTOR macro).

Note 3

The message has a routing code of 1, which sends it to the console with master authority, and is also routed to the console that the message describes.

Note 4

The message is sent to all active consoles; this is a broadcast message.

Note 5

The message has a routing code of 2, which sends it to the console with master authority, and is also routed to the consoles that are assuming the duties of the failing console. (This message indicates that console switching has occurred.)

Note 6

The message is routed only to non-printer consoles. This message is not issued by a WTO or WTOR macro.

Note 7

The message is routed to consoles where one or more of the following are active:

- MONITOR JOB NAMES
- MONITOR SESSIONS
- MONITOR STATUS

Note 8

The message is also routed to the MSS space manager's console specified by an alternate console routing code on the MSFMSG parameter in the MVIKEY00 parmlib member.

Note 9

The message is issued during the nucleus initialization program (NIP) processing.

Note 10

The message is issued by the WTL macro.

- Note 11**
The message is routed to a SYSPRINT data set by data management.
- Note 12**
The message is issued by a WTO or WTOR macro with SYNCH=YES. See *z/OS MVS Initialization and Tuning Reference* for more information.
- Note 13**
The message is routed only to receivers of the hardcopy message set.
- Note 14**
The message is routed back to the console that initiated the request and to all associated consoles.
- Note 16**
The message is routed to the IPCS print file IPCSPRNT.
- Note 17**
The message is issued by JES3. A JES3 destination class is specified either by the initialization stream or by operator commands.
- Note 18**
The message is sent in response to a command to the console where the command was entered.
- Note 19**
The message is written to a data set. If routing and descriptor codes are also included for the message, the message might also be displayed according to the specified routing and descriptor codes. (The descriptor code does not apply to writing the message to the data set.)
- Note 20**
JES3 does not issue the message. JES3 sends the message to another subsystem for processing.
- Note 21**
This message is a trailer attached to multiple messages previously issued. It has the same routing and descriptor codes as the first line of the conglomerate.
- Note 22**
This message is routed to the transaction program (TP) message log.
- Note 23**
This message is issued by the device controller. The routing code will vary according to the device controller's task.
- Note 24**
This message is routed to the assembly listing.
- Note 25**
When this message is issued during IPL, the routing codes are 2 and 10 and the descriptor code is 12. When it is issued after IPL, it has no routing code and the descriptor code is 5.
- Note 26**
When this message is issued during NIP processing, the descriptor code is 12. When it is issued after NIP processing, the descriptor code is 4.
- Note 27**
The indicated route codes are used only if this message is issued in response to a reply of CKPTDEF during a JES2 checkpoint reconfiguration. This message might be issued to a specific console ID rather than directed

by route code. For further information concerning the routing of JES2 messages issued during a reconfiguration, see *z/OS JES2 Initialization and Tuning Guide*.

Note 28

These routing and descriptor codes apply only when SMS issues the message. If SMS returns the message to its caller and the caller issues the message, the codes do not apply.

Note 29

This message is written to the JES3OUT data set.

Note 30

This message is issued by JES3. The message is written to the *MODIFY CONFIG (*F MODIFY) log, the issuer of the *F CONFIG command, or both.

Chapter 3. Descriptor codes

Descriptor codes describe the significance of messages. They indicate whether the system or a task stops processing, waits until some action is completed, or continues. This code also determines how the system will display and delete the message.

Association with message type code

Descriptor codes are associated with message type codes, specified by a letter following the message serial number, as follows:

Descriptor Code	Type Code
------------------------	------------------

1	W (wait)
2	A (action) or D (decision)
3	E (eventual action)
4 through 10	I (information)
11	E (eventual action)
12 and 13	I (information)

Specification

Descriptor codes are specified in the DESC parameter of the WTO or WTOR macro. The following restrictions apply when specifying descriptor codes:

- Descriptor codes 1 through 6, 11, and 12 are mutually exclusive. Assign only one of these codes to a message. If you assign two mutually exclusive codes to one message, the system uses the most important code and ignores the other.
- Descriptor codes 7 through 10 and 13 can be assigned in combination with any of the mutually exclusive codes.
- Descriptor code 9 or 10 can be used only with descriptor code 8.

Under certain conditions, the system uses a descriptor code other than that specified in the macro as follows:

- The system assigns descriptor code 6 if the macro specifies a ROUTCDE parameter, but no DESC parameter.
- The system assigns descriptor code 7 if all of the following are true:
 1. A problem program issued the macro.
 2. The macro omits both DESC and ROUTCDE parameters, or specifies descriptor codes 1 or 2.
 3. The message is not a multiple-line WTO message.
- The system assigns no descriptor code if all of the following are true:
 1. An authorized program issued the macro.
 2. The macro omits both DESC and ROUTCDE parameters.
 3. The message is not a multiple-line WTO message.

Note: An authorized program has at least one of these characteristics:

- Authorized by the authorized program facility (APF)
- Runs in supervisor state
- Runs under PSW key 0 through 7

Message deletion

With multiple console support (MCS), action messages with descriptor code 1 or 2 issued by problem programs are assigned descriptor code 7; thus, they are automatically deleted from the system at task or address space ending.

The system deletes messages issued by any program when that program issues the DOM macro.

The operator can manually remove all messages from a display console screen or can set the console to roll messages off the screen.

Message color

On operator consoles with color, the descriptor code determines the color of the message. The use of color is explained in *z/OS MVS System Commands*. Also see the descriptions of the CONSOLxx and MPFLSTxx parmlib members in *z/OS MVS Initialization and Tuning Reference*.

Descriptor code meaning

Code	Meaning
1	System Failure The message indicates an error that disrupts system operations. To continue, the operator must reIPL the system or restart a major subsystem. This causes the audible alarm to be issued.
2	Immediate Action Required The message indicates that the operator must perform an action immediately. The message issuer could be in a wait state until the action is performed or the system needs the action as soon as possible to improve performance. The task waits for the operator to complete the action. This causes the audible alarm to be issued. Note: When an authorized program issues a message with descriptor code 2, a DOM macro <i>must</i> be issued to delete the message after the requested action is performed.
3	Eventual Action Required The message indicates that the operator must perform an action eventually. The task does not wait for the operator to complete the action. If the task can determine when the operator has performed the action, the task should issue a DOM macro to delete the message when the action is complete.
4	System Status The message indicates the status of a system task or of a hardware unit.
5	Immediate Command Response

The message is issued as an immediate response to a system command. The response does not depend on another system action or task.

6 Job Status

The message indicates the status of a job or job step.

7 Task-Related

The message is issued by an application or system program. Messages with this descriptor code are deleted when the job step that issued them ends.

The message appears in hardcopy before being queued to a console.

8 Out-of-Line

The message, which is one line of a group of one or more lines, is to be displayed out-of-line. If a message cannot be printed out-of-line because of the device being used, descriptor code 8 is ignored, and the message is printed in-line with the other messages.

9 Operator's Request

The message is written in response to an operator's request for information by a DEVSERV, DISPLAY, TRACK, or MONITOR command.

10 TRACK Command Response

The message is issued in response to a TRACK command.

11 Critical Eventual Action Required

The message indicates that the operator must perform an action eventually, and the action is important enough for the message to remain on the display screen until the action is completed. The task does not wait for the operator to complete the action. This causes the audible alarm to be issued.

Avoid using this descriptor code for non-critical messages because the display screen could become filled.

If the task can determine when the operator has performed the action, the task should issue a DOM macro to delete the message when the action is complete.

12 Important Information

The message contains important information that must be displayed at a console, but does not require any action in response.

13 Automation Information

Indicates that this message was previously automated.

14-16 Reserved for future use.

Descriptor codes in this document

The descriptor codes appear in the **Descriptor Code** column. The column can also contain the following special characters.

/ The message will have different descriptor codes according to the task issuing it. For example, 4/6 means the message can describe system status or job status.

— The message has no descriptor code.

Chapter 4. Zero to ninety-nine

The following JES2 messages are numbered in the 0-99 range.

\$HASP000

Explanation:

►►—OK—◄◄

The command has been accepted for action. The appropriate action has been taken or has been scheduled. The OK response is an indication that the JES2 command processor found no fault in the command; however, actions such as an attempt to initiate a function already scheduled or in progress may be ignored.

System action: The system continues processing.

Operator response: None.

Module: HASPCOMM

Routing Code: #

Descriptor Code: –

\$HASP001

Explanation:

►►—*con_name, text*—◄◄

The operator at console *con_name* has entered the displayed message, using the display message (\$DM) command. In the message text: *con_name* is either:

Rnnnnnnnn

The number of a remote terminal.

vvvvvvvvv

The 2- to 8-character console name of a central console.

System action: The system continues processing.

Operator response: Perform the appropriate action in accordance with installation procedures.

Module: HASPCOMM

Routing Code: 8

Descriptor Code: 4

\$HASP003

Explanation:

►►—RC=*rsnc*, *trace-of-keywords* *text* ERROR BUILDING MESSAGE HASP—*nnn*—◄◄

During \$SCAN processing, the \$SCAN facility detected one of the following conditions:

- A JES2 operator command was entered in error.
- A JES2 initialization statement was entered in error.
- An error occurred while JES2 was trying to issue a message with the \$BLDMSG service.

\$HASP003

In the message text:

trace-of-keywords

This lists the command verb (VERB from the \$SCAN call) and list of keywords being scanned when the error occurs. For example, the command \$ADD NETSERV(1),TRACE=ALWAYS will result in a \$HASP003 RC=(03),ADD NETSERV2 TRACE ALWAYS - INVALID PARAMETER STATEMENT, where ADD is the verb and NETSERV, TRACE and ALWAYS are the operands where the error was detected.

If the \$HASP003 message is being issued because of an error building a message, the trace-of-keywords will be the number (nnnn) of the message being constructed.

The reason code (*rsnc*) and variable message *text* define the reason for the error:

rsnc *text*

01 INVALID SYNTAX

The syntax of the specified keyword is incorrect.

03 INVALID PARAMETER STATEMENT

JES2 does not recognize the specified keyword.

04 CONTAINS AN INVALID SUBSCRIPT[, RANGE IS (xxxx-yyy)]

The specified subscript value is either outside the allowable range or is not defined by your installation. The valid range of the subscript is displayed. This code can also be displayed if a subscript should have been specified but was not.

05 TOO MANY VALUES WERE SPECIFIED

More values were provided for the keyword than are allowed.

06 VALUE CONTAINS INVALID DATA

The value specified for the keyword is in an incorrect character set.

07 INVALID JOB TYPE

The job type specified for the keyword is incorrect. For offload SYSOUT receivers/transmitters and print/punch devices, the valid job types are J, S, and T. For offload job receivers/transmitters, the only valid job type is J.

08 VALUE IS OUTSIDE NUMERICAL RANGE, RANGE IS (xxxx-yyy)

The value specified for the keyword is not within the specified range.

09 DATA IS TOO SHORT

The number of characters entered is insufficient for the value of the specified keyword.

10 DATA IS TOO LONG

Too many characters were entered for the value of the specified keyword.

11 TOO MANY {REMOTE | NETWORK RECEIVER | NETWORK XMITTER} DEVICES HAVE BEEN DEFINED

The specified device exceeds the maximum number allowed.

12 MISSING REQUIRED OPERAND xxxxxxxx

The variable field xxxxxxxx is optional. When present, it indicates the required operand that is missing for the specified keyword.

13 VALUE CAN NOT BE DISPLAYED – TOO LARGE

A request to display a specified keyword value cannot be granted because the area used for display processing is too small. An error has occurred in \$SCAN processing. Determine if it's either an installation exit or an IBM \$SCAN error. If it is an internal JES2 error, contact the IBM support center.

14 TOO MANY *keyword type* WERE PROVIDED

The specified keyword is ignored because too many have been provided for this keyword type. You have exceeded the maximum number of specified items that have been defined for your system. If this is a subscript value, you have exceeded the valid number of subscripts on the command.

17 INVALID DESTINATION

The value specified for the destination **must** be for a node (Nnnnn), a remote workstation (Rnnnn), a remote work station on another node (NnnnnRnnnn), a special local (Unnnn), or a local (LOCAL) destination.

This message will be issued during initialization:

- if the symbolic node name has not yet been defined to JES2 (either the NODE statement defining the symbolic node name is missing from the initialization stream or JES has not yet processed the NODE statement in the initialization stream).
- if JES2 detected a DESTID(xxxxxxx) subscript value that matched a NODE NAME= specification within the initialization data set. (JES2 does not allow you to specify functionally redundant DESTID statements in the initialization data set.)

The problem is either that the sequence of the node definition in the initialization stream is not correct or the initialization stream defines a duplicate node. Correct the initialization stream.

If you ignore this error message when a DESTID subscript value matches a NODE NAME specification and proceed with initialization, JES2 will initialize, but is unable to communicate with the duplicated node as specified by *trace-of-keywords*. This means that anything you direct to the duplicated node, such as output or commands, might arrive at an unexpected destination.

18 INVALID ROUTE CODE

In general the valid route codes for a device are to a node (Nnnnn), a remote workstation (Rnnnn or R*), a remote workstation on a different node (NnnnnRnnnn or NnnnnR*), a special local (Unnnn) or a local (LOCAL). See the description of the specific device in *z/OS JES2 Initialization and Tuning Reference* for a list of the valid route codes.

19 INVALID ACCOUNT INFORMATION

The specified low range of the account information is greater than the specified high range of the account information.

21 INVALID REMOTE DEVICE NAME

The specified remote device has not been defined to JES2 with an RMTnnnn initialization statement because it was issued locally, and JES2 could not determine the remote device name. For example, if not issued from a remote, issue the fully qualified command \$D R(nnnn).PU(m).

22 VALUE CAN NOT BE DISPLAYED – NOT YET SPECIFIED

A request was made to display a keyword that has not been specified.

23 INVALID COMMENT FOUND

An incorrect comment was found. Either it does not have the proper delimiters (/ * comment */) or its location is not legal. See *z/OS JES2 Initialization and Tuning Reference* or *z/OS JES2 Commands* for valid syntax.

24 REQUEST DENIED – INSUFFICIENT STORAGE

The request is denied because there is insufficient storage to satisfy it. Increase the JES2 region size or increase the private storage area above 16 megabytes in virtual storage.

25 NO SELECTABLE DEVICE(S) FOUND

A request to set, display, or act upon (for example, \$P) a device or range of devices cannot be satisfied. Either JES2 could not find a device or the device it found was not in the range, didn't match the filter, or is in a state that could not be operated on.

26 REQUEST DENIED – INTERNAL ERROR WITHIN \$SCAN

An abend occurred within JES2 \$SCAN processing, causing the request to end. See previous \$HASP088 or \$HASP095 message. An attempt has been made to return the storage obtained for the processing of the request and JES2 has recovered from the error.

\$HASP003

27 REQUEST DENIED – INTERNAL ERROR WITHIN \$SCAN

Insufficient information passed to the JES2 \$SCAN routine has caused the request to end abnormally. This error could also be due to a \$SCANTAB macro coding error. Determine if it's either an installation exit or an IBM \$SCANTAB error. If an internal JES2 error, contact the IBM support center. \$SCAN requires:

- A valid call (see the macro \$SCAN)
- Specification of a display output area with a valid length
- Specification of a display routine
- A parameter statement for the highest level of scanning passed to it
- A set of tables passed to it

28 REQUIRED CONTROL BLOCK(S) NOT (YET) AVAILABLE

The requested control block(s) could not be found. While progressing through a chain of control blocks, JES2 encountered a pointer of zero. It is possible that an attempt to display fields in a control block was made before the set request to build the control block. Contact the IBM support center.

31 MODULE COULD NOT BE LOADED

The specified module cannot be loaded. See message \$HASP875, RC=02 for more information.

32 MODULE IS INVALID, RMODE MUST BE 24

The module is in RMODE 31; JES2 expects it to be in RMODE 24. See message \$HASP875, RC=06 for more information.

33 MODULE NAME DOES NOT MATCH ITS MIT, EXPECTED-mit_exp ACTUAL-mit_act

The module name does not match the label specified on the \$MODULE macro. See message \$HASP875, RC=07 for more information. *z/OS JES2 Macros* provides a description of the \$MODULE macro.

34 MODULE VERSION IS INVALID, EXPECTED-ver_exp ACTUAL-ver_act

The module version in the module's module information table (MIT) does not match that in \$HCT. See message \$HASP875, RC=08 for more information.

35 MODULE ASSEMBLED WITH INVALID MACRO LIBRARIES, EXPECTED-lib_exp ACTUAL-lib_act

The module was assembled with a different set of macro libraries than the rest of the modules in JES2. See message \$HASP875, RC=09 for more information.

36 MODULE IS NOT IN COMMON STORAGE

The module is not in common storage. See message \$HASP875, RC=10 for more information.

37 INSUFFICIENT STORAGE FOR LOAD MODULE TABLE ENTRY

The amount of storage needed to allocate the load module table entry for the module was unavailable. See message \$HASP875, RC=01 for more information.

38 MODULE MIT IS INVALID, CANNOT LOCATE LMT

**MODULE MIT IS INVALID, MODULE
TOO SMALL**

**MODULE MIT IS INVALID, INCORRECT
MITETBL ADDRESS**

**MODULE MIT IS INVALID, INCORRECT
EYECATCHER, EXPECTED-MIT
ACTUAL-mit**

The module information table (MIT) for this module is incorrect. See message \$HASP875, RC=11 for more information.

39 INCOMPATIBLE OPERAND SETTINGS – xxxxxxxx xxxxxxxx

The values specified for the displayed operands are incompatible. See *z/OS JES2 Initialization and Tuning Reference* or *z/OS JES2 Commands* for incompatibilities.

40 MULTI-LINE OUTPUT FROM MESSAGE BUILDING (\$BLDMSG) INVALID FOR WTOR

A request to create a message using \$BLDMSG TYPE=WTOR has resulted in an attempt to send more than one line of output to MCS. Because MCS does not accept multi-line WTORS, the request is rejected. However, the first line of the multi-line WTOR is written to the console and all other lines are suppressed. Shorten the message by modifying the \$SCANTAB entries that define that message. See the description of the \$SCANTAB macro in *z/OS JES2 Macros* for information on how to modify these entries. Determine if it's either an installation exit or an IBM \$SCANTAB error. If an installation exit, notify the system programmer. If an internal JES2 error, contact the IBM support center.

41 SPIN NOT VALID IF TRACE LOG NOT ACTIVE

A request was made to spin the trace log data set when trace logging was not active.

43 MAXIMUM TRACE STORAGE EXCEEDED (NUMBER OF TABLES TIMES PAGES PER TABLE)

The total amount of storage requested for trace tables (number of tables times pages per table) exceeds the maximum of 10 megabytes.

44 IGNORED, IT IS AN OBSOLETE PARAMETER

The specified keyword has been eliminated from JES2. See *z/OS JES2 Commands* or *z/OS JES2 Initialization and Tuning Reference* to find the replacement for this keyword.

45 IGNORED, VALUES ON HOT START ARE RESTORED TO PRIOR VALUES

A request was made to alter a field that is maintained in CSA. The request is ignored and the field is restored on hot start to the CSA version.

46 IGNORED, AS SPECIFIED BY LOCAL INSTALLATION \$SCAN TABLES

The installation-defined WARNING operand on the \$SCANTAB macro matched the value specified on the \$SCAN WARNMSK operand.

47 MODULE IS NOT REENTRANT

Because the module is not reentrant, JES2 could not load the module into CSA. See message \$HASP875, RC=03 for more information.

48 NEW CSA/LPA LOADMODS INVALID ON HOT START

Because the common storage module was not loaded during a prior initialization of JES2, JES2 denies its load on a hot start. See message \$HASP875, RC=04 for more information.

49 INSUFFICIENT STORAGE TO LOAD MODULE

The amount of storage needed to load the module could not be allocated. See message \$HASP875, RC=05 for more information.

51 MODULE NOT FOUND – MODULE CANNOT BE VERIFIED

The \$MODCHK macro made no verification checks on the module because the address operand was not coded on the \$MODCHK macro and the entry point was not found in the load module table (\$LMT). See message \$HASP875, RC=12 for more information.

52 NO SELECTABLE ENTRIES FOUND MATCHING SPECIFICATION

Either a keyword request was made to \$SCAN but no entries matched the input, or JES2 determined that a requested operation is not required or cannot be fulfilled. This error typically occurs when a numeric or symbolic subscript is used and no entries matching the subscript are currently defined. For example, this message is issued if a display request for NODE(POK*) was made and no control blocks that define nodes contained POK as the first three characters in the name.

Either JES2 could not find a device or the device it found was not in the range, didn't match the filter, or is in a state that could not be operated on.

54 INVALID NODE NAME SPECIFIED

A character name representing a node is expected, but the name is not valid. If this message appears for a NODE(nnnn) statement, then the following applies.

- The node name can only be an explicit destination value (that is, a numerical value) if both of the following are true:

\$HASP003

- The value is not the same as another node number.
- The value is not the same as the DEST= value on the DESTID statement unless the DEST= value is also the number of this node (Nnnnn).

If you ignore this error message and proceed with initialization, JES2 will initialize but is unable to communicate with the duplicated node as specified by *trace-of-keywords*.

55 REQUEST INVALID DUE TO ACTIVE STATUS

The request to change or display characteristics is not permitted at this time because JES2 determined using the ACTFLAG, ACTSET, and ACTDISP operands on the \$SCANTAB macro for the keyword, that the object is active.

56 EXISTING ENTRIES FOUND MATCHING SPECIFICATION

The request to create a new control block (for example, \$ADD) is ignored because a matching control block already exists.

57 DISPLAY TERMINATED DUE TO EXCESSIVE OUTPUT (AS DEFINED BY CONDEF DISPMAX)

The number of lines of output that \$SCAN was to display exceeded either the maximum number of lines permitted by the DISPMAX= parameter on the CONDEF initialization statement or 9999999. \$SCAN processing truncates the display to that limit.

If you want \$SCAN to display the entire number of output lines, and the optional text "AS DEFINED BY CONDEF DISPMAX" to be displayed, you can use one of the following two ways:

1. Increase the DISPMAX= value and reissue the request.
2. For operator commands, reissue the request with the L= parameter to send the response to an out-of-line area.

Note: If the request was to change parameter values, by display, you can make the changes even though the display was truncated.

58 CANNOT SELECT GENERIC/MULTIPLE ENTRIES FOR xxxxxxxxxx

The keyword cannot be altered on a request that specified a generic or generic range subscript (for example, DESTID(JES*) DEST=N3). This restriction is defined by the GENSET operand on the \$SCANTAB macro for the keyword.

In the message, xxxxxxxxxx is one of the following functions:

- ADD
- ALTERATION
- CANCEL
- DELETE
- MIGRATE
- PROCESSING
- START
- STATEMENT

59 REQUEST INVALID DUE TO INACTIVE STATUS

The request to change or display characteristics is not permitted at this time because JES2 determined using the ACTFLAG, ACTSET, and ACTDISP operands on the \$SCANTAB macro for the keyword, that the object is inactive.

60 MODULE USER VERSION IS INVALID, EXPECTED-uver_exp ACTUAL-uver_act

The module version in the module's module information table (MIT) does not match that in \$HCT. See message \$HASP875, RC=15 for more information.

61 MODULE IBM USER VERSION IS INVALID

The module version in the module's module information table (MIT) contains an unexpected value. See message \$HASP875, RC=16 for more information.

62 CONSOLE LOCATION INVALID OR UNAVAILABLE

The console identified on a \$T or \$ADD REDIRECT command is either unavailable or the identification is incorrect.

63 NOT VALID FOR PATH MANAGER DEFINED CONNECTIONS

A \$T CONNECT or \$DEL CONNECT command was entered for a connection that is not defined as a static connection. Either a CONNECT initialization statement does not exist for the specified connection or a \$ADD CONNECT command was not entered for the specified connection. Enter a \$ADD CONNECT command to override the non-static connection with a static one before reentering the original command.

64 REJECTED – NETWORK PATH MANAGER NOT AVAILABLE

A command was entered that requires the path manager services after JES2 suspended network path manager functions. See message \$HASP502.

65 UNSUPPORTED LOCAL DEVICE TYPE

The device specified by the UNIT keyword exists but JES2 does not support this as a local device. Use the MVS D U command to display which devices are defined.

66 UNIT SPECIFIED DOES NOT EXIST

The device specified by the UNIT keyword does not exist. Use the MVS D U command to display which units are defined.

67 FSS SPECIFIED IS NOT DEFINED

The FSS named in the FSS keyword of a \$ADD PRT(n) command does not exist. Use the \$D FSS command to display which FSSes are defined.

68 VALUE MAY NOT BE SPECIFIED AT THIS TIME

JES2 either processed an initialization statement or a \$T command, but could not set an attribute specified for a device. *trace—of—keywords* in the message text indicates the attribute that could not be set. It may be possible to set the attribute later, but if you continue to receive this reason code with the same keyword you will not be able to set the attribute. For example, if you attempt to assign a compaction table with the COMPACT keyword on a device that does not support compaction (CMPCT=NO), you will always receive this reason code.

69 CANNOT USE STRUCTURE *strname* WHILE RUNNING IN MODE=DUAL

The current checkpoint mode is DUAL, but an attempt was made to assign a NEWCKPT*n* to a coupling facility structure by coding the STRNAME= keyword. Because the use of a coupling facility structure is only supported while running in DUPLEX mode, the request is denied. Issue the \$T CKPTDEF,MODE=DUPLEX command to change the checkpoint mode to DUAL and then retry the command assigning CKPTDEF to a coupling facility.

70 ELEMENT VALUE MUST EXCEED PREVIOUS ELEMENT VALUE [BY AT LEAST *yyyyy*]

A parameter range was specified which requires the second range element to be greater than the first range element by at least 1. The bracketed portion of the message appears only if the values must be different by more than 1.

71 LINE/SHARABLE SPECIFICATIONS ARE NOT VALID

A LINE= value on either the \$T RMT(nnnn) command or the \$ADD RMT(nnnn) command is **not**:

- Defined on a LINE(nnnn) initialization statement.
- Available for RJE (remote job entry) because it is dedicated to NJE (network job entry) use.
- Accessible because it is dedicated to another remote that has specified SHARABLE=NO on the RMT(nnnn) definition.
- Accessible because it is being used by another remote as a nondedicated line.

72 CANNOT BE {MODIFIED | TERMINATED} BY ANOTHER RJE WORKSTATION

A command (\$ADD RMT, \$T RMT, or \$P RMT) was issued from either another RJE workstation or from an JES2 NJE system that does not have proper authorization to issue the command. The command fails.

73 ALL MEMBERS ARE NOT AT THE REQUIRED PRODUCT/SERVICE LEVEL

\$HASP003

All active JES2 MAS members are not at the correct service/product level to support the command. Active implies defined members that are not drained and not initializing.

- If you applied a new product level:
See *z/OS V2R2 Migration* for your new product level to determine actions that are required for the command to function.
- If you applied a new service level:
See the documentation supplied with the maintenance you just applied to determine actions that are required for the command to function.

The command fails, notify the system programmer.

74 CURRENT CHECKPOINT DATA SETS ARE TOO SMALL

A command was issued which required an increase in the amount of space needed for the checkpoint data set(s). The current checkpoint is too small. Either there are not enough tracks in the data set or the size of an individual track is too small. This message is accompanied by either \$HASP295 (TRACK SIZE INSUFFICIENT) or \$HASP296 (*dsname* SPACE INSUFFICIENT). If the \$HASP296 message was issued, then issue a \$D CKPTSPACE command to determine the current set utilization. Then use the reconfiguration dialog to increase the size of and begin using the larger data set. If the \$HASP295 message was issued, then either use the reconfiguration dialog to move the data set to a volume that has a larger track size or decrease a CKPT size related parameter. See the \$HASP295 message for more information. In either case, the command fails.

75 MEMBER *mmmm* NOT ALLOCATED TO BOTH CKPT DATA SETS (MODE=DUPLEX, DUPLEX=OFF)

A \$T command was issued which requires adjusting the size of the checkpoint, and the current member is not allocated to both checkpoint data sets. The command fails because of lack of checkpoint data set access.

mmmm is the member that currently has DUPLEX=OFF set.

Note: There may be more than one member that has DUPLEX=OFF. This is just the first member that was detected.

76 FILTER KEYWORD NOT ALLOWED AFTER SET KEYWORD

Before you specify any related set keyword(s), you must first specify the filter keyword(s). Example:
Non-valid: \$t jobq,class=a,/class=b Valid: \$t jobq,/class=a,class=b

77 AT LEAST ONE FILTER MUST BE SPECIFIED

The command requires at least one filter. Example: Non-valid: \$poj Valid: \$poj,jm=alice*

78 MULTIPLE JOBS FOUND

There is more than one job by the name specified in the system. Specify the job by number (jobid) if you want to affect all jobs with a name. Specify the name within parenthesis rather than quotes.

79 INCORRECT RETURN CODE FROM PRESCAN OR POSTSCAN ROUTINE

Pre-scan or post-scan routine returned a return code other than those allowed. Determine if it's either an installation exit or an IBM \$SCANTAB error. If an internal JES2 error, contact the IBM support center.

80 MISSING PRESCAN OR POSTSCAN ROUTINE

A pre-scan or post-scan routine specified on SCANTAB or an exit routine could not be found. Determine if it's either an installation exit or an IBM \$SCANTAB error. If an internal JES2 error, contact the IBM support center.

81 SOURCE OF COMMAND HAS IMPROPER AUTHORITY

The issuer of the command requires a higher level of authority. Example: Command required system authority and console specified from has job authority.

82 INVALID FILTER KEYWORD

The keyword entered is not a valid filter.

83 INVALID DELIMITER

A filter was entered with an invalid delimiter. For example, > (greater than) or < (less than) were entered when only <> (not equal to) or = (equal to) are valid delimiters. See *z/OS JES2 Commands* .

84 JOB IS BUSY, TRY LATER

Job is busy on a device and cannot be modified at this time.

85 JOB CANNOT BE CANCELLED; SPECIFY 'PROTECTED'

The operator entered one of the following against a protected job:

- A \$C command with the PURGE or ALL parameters
- A \$O CANCEL command
- A \$P command

JES2 purges any output for one or more specified jobs that are not protected. If the output for the specified jobs is protected, JES2 ignores the command and continues processing. Specify the PROTECTED parameter on the command if you must cancel the job or output.

86 SPOOL VOLUME CANNOT BE STARTED – NO TRACK GROUPS AVAILABLE. CHECK MAX TGSPACE ON SPOOLDEF.

There are no more track groups available to start the spool volume. Increase TGSPACE to specify the number of track groups required.

87 ROUTECDE - INCORRECT COMBINATION OF FILTERS SPECIFIED. MUST SPECIFY BOTH '>' AND '<' FILTERS, OR NEITHER.

An attempt was made to filter on ROUTECDE= or DEST= using either a > or a < filter, but not both. Therefore, the route code comparisons result in an open-ended range, which is not allowed. To avoid this message, an additional route code filter must be provided on the command.

88 INCORRECT RANGE OF ROUTE CODES SPECIFIED

An attempt was made to filter on a range of route codes using > and < filters, but the resulting range was inconsistent for one of the following reasons:

- The high and low bounds of the range specified different node names, and the nodal route codes were not both specified as 'node.*'.
- The low bound of the range specified a special local route code (Unnnn or equivalent) and the high bound of the range did not.
- The low bound of the range specified a userid route code, and the high bound specified a remote route code (Rnnnn or equivalent).

89 JOB CANNOT BE CANCELLED

The operator has attempted to cancel a job which is not cancelable. The most common reasons are the job is marked non-cancelable by MVS or you tried to cancel an executing STC (you must use the MVS CANCEL command to cancel a started task in execution). The message is issued and no MVS CANCEL is issued for that job.

90 NOT DEFINED TO WLM

The operator has attempted to modify the default SCHENV for a jobclass or has attempted to modify the SCHENV for a job and the SCHENV name is not defined to WLM.

91 nnnnnn FAILURE

The MVS service listed was called and returned an error. Details of the error are in previous messages.

92 NOT VALID FOR DEMAND SELECT JOBS

The command was issued against a started task or time sharing user which is not allowed.

93 NOT EXECUTING

Command could not complete because job is not actively executing.

**| 94 JOB/OUTPUT QUEUE ERROR DETECTED WHICH PREVENTS Z11 AND Z22 CHECKPOINT MODE
| ACTIVATION, RC=rc**

\$HASP003

rc identified the type of queue error detected. Reason codes from X'01' to X'7F' are errors encountered in the job queue. Reason codes X'80' to X'FF' are errors encountered in the output queue.

95 INSUFFICIENT BERTS

Operator command failed because of a BERT shortage.

96 NOT SPINNABLE

\$T J/S/T,SPIN valid only if JESLOG=SPIN or JESLOG=(SPIN,xxxx)

97 LOGICAL PARMLIB {MEMBER NOT FOUND | ALLOCATION FAILED}

An error was returned from the MVS IEFPRMLB service while trying to access the default PARMLIB concatenation.

98 PROCESSING INCLUDE keyword error

An error was encountered processing the keyword in the message.

In the message text *keyword error* is one of the following:

- MEMBER - NO BASE DATA SET
- MEMBER - BASE DATA SET IS NOT PDS
- DSN - MEMBER NOT SPECIFIED FOR PDS

99 REJECTED - JOB IS POST EXECUTION

The operator issued a command against a job that has completed execution. The command contained an operand only valid for jobs that have not yet executed.

100 REJECTED - AT LEAST ONE DATA SET IS REQUIRED IN PROCLIB(xxxxxxxx) CONCATENATION

The operator issued a \$T command to delete a data set from the PROCLIB concatenation. However, this was the only data set within the PROCLIB(xxxxxxxx) concatenation, where xxxxxxxx is the PROCLIB name for which the message is issued. Because JES2 requires there be at least one data set in the concatenation it does not delete the data set and rejects the command.

101 SUBSYSTEM INTERFACE NOT DORMANT, COLD START NOT ALLOWED

A start parameter of COLD or FORMAT was specified, but there is an active subsystem interface (SSI).

102 CONFLICTING FILTERS SPECIFIED

Mutually exclusive filters were specified.

103 INTERNAL ERROR - R11 = HCT NOT ALLOWED IN NON-JES2 ADDRESS SPACE

A \$SCANTAB specified a prescan, postscan, or cleanup routine that requires the HCT (JES2 or SUBTASK) environment, but the invoking table was requested outside the JES2 address space.

104 SOCKET MUST SPECIFY LOCAL NODE

A NETSRV points to a SOCKET whose NODE= value does not specify the local node.

105 DEVICE TYPE UNSUPPORTED BY ASSOCIATED REMOTE

The remote device points to a line that is not of the correct type (for example, a SNA remote points to a TCP/IP line) .

106 CANNOT SET DYNAMIC IF NOT ACTIVE ON ALL MEMBERS

The QAFF for the service class is not set to 'ANY'.

107 SERVICE CLASS NOT DEFINED OR WLM ERROR

The service class name given in a \$S/\$P/\$T SRVCLASS(serviceclass) is not defined.

108 OUTPUT QUEUE IS FULL

An additional Job Output Element (JOE) was necessary to complete the command, but none were available. You can issue a \$T OUTDEF,JOENUM= command to increase the number of output elements.

109 JOB NOT SELECTED

INTERNAL ERROR
 RSN=02 SYSTEM DRAINING
 RSN=03 JOB WITH SAME NAME
 ALREADY RUNNING
 RSN=04 SCHEDULING ENVIRONMENT
 NOT AVAILABLE
 RSN=05 INDEPENDENT MODE
 MISMATCH
 RSN=06 SPOOL(S) NOT AVAILABLE
 RSN=07 DISALLOWED BY \$EXIT 49
 RSN=08 SECLABEL NOT AVAILABLE
 RSN=09 NO AFFINITY TO ANY ACTIVE
 SYSTEM
 RSN=10 UNEXPECTED RESPONSE
 FROM WLM
 RSN=11 ARM RESTART PENDING
 RSN=12 BUSY
 RSN=13 NOT BATCH JOB
 RSN=14 NOT ON EXECUTION QUEUE
 RSN=15 NO JES2 CAN SELECT
 RSN=16 JOBCLASS AFFINITY NOT
 AVAILABLE
 RSN=17 Minimum z/OS level not available

The job was not to be selected. The additional text gives the reason.

110 NO EXISTING ENTRIES FOUND MATCHING SPECIFICATION

The name specified as a subscript does not match any control blocks.

111 EXIT ROUTINE xxxxxxxx (EXITnnn) NOT FOUND

A routine with the specified name was not found during processing the listed exit.

In the message text:

xxxxxxx

 The name of the exit routine.

nnn The number of the exit.

112 EXIT ROUTINE xxxxxxxx (EXITnnn) NOT LOCATED IN COMMON STORAGE

The routine specified for the listed exit is not in common storage but the exit requires routines in common storage.

113 SPACE PARM REQUIRES NEW SPOOL VOLUME

The SPACE parameter was specified on the \$S SPOOL command when starting a SPOOL volume that is already defined to JES2.

114 SPACE PARM MAX MUST NOT HAVE UNITS SPECIFIED

The sub operand that denotes units was specified when the MAX sub operand was specified for the SPACE parameter on the \$S SPOOL command.

116 z11 CHECKPOINT ACTIVATION CANNOT BE PERFORMED. CHECKPOINT DATA SETS ARE TOO SMALL. ISSUE COMMAND \$D ACTIVATE FOR MORE INFORMATION.

JES2 cannot activate the z/OS 1.11 level of function because the checkpoint data sets are not large enough to hold the expanded checkpoint data areas.

117 z11 CHECKPOINT ACTIVATION CANNOT BE PERFORMED. THERE ARE TOO FEW BERTS TO SUPPORT Z11 JOE ACTIVATION. ISSUE COMMAND \$D ACTIVATE FOR MORE INFORMATION.

JES2 cannot activate the z/OS 1.11 level of function because there are not enough BERTS available.

118 z11 CHECKPOINT ACTIVATION CANNOT BE PERFORMED. LARGEDS SUPPORT MUST BE ACTIVATED. ISSUE COMMAND \$D ACTIVATE FOR MORE INFORMATION.

\$HASP003

JES2 cannot activate the z/OS 1.11 level of function because large data set support has not been activated.

119 NUMBER OF CYLINDERS MUST BE SPECIFIED AND THE RANGE ALLOWED IS 1 TO 69,905.

The sub operand that denotes units was not specified in one of the following situations:

- The sub operand CYL was specified for the SPACE parameter on the \$S SPOOL command.
- The value specified was not in the allowed range.

This message is issued when large data sets are used for SPOOL.

120 NUMBER OF TRACKS MUST BE SPECIFIED AND THE RANGE ALLOWED IS 1 TO 1,048,575.

The sub operand that denotes units was not specified in one of the following situations:

- The sub operand TRK was specified for the SPACE parameter on the \$S SPOOL command.
- The value specified was not in the allowed range.

This message is issued when large data sets are used for SPOOL.

121 NUMBER OF CYLINDERS MUST BE SPECIFIED AND THE RANGE ALLOWED IS 1 TO 4,369.

The sub operand that denotes units was not specified in one of the following situations:

- The sub operand CYL was specified for the SPACE parameter on the \$S SPOOL command
- The value specified was not in the allowed range.

This message is issued when small data sets are used for SPOOL.

122 NUMBER OF TRACKS MUST BE SPECIFIED AND THE RANGE ALLOWED IS 1 TO 65,535.

The sub operand which denotes units was not specified in one of the following situations:

- The sub operand TRK was specified for the SPACE parameter on the \$S SPOOL command
- The value specified was not in the allowed range.

This message is issued when small data sets are used for SPOOL.

| 123 BOTH z11 and z22 CHECKPOINT ACTIVATION ARE DISALLOWED DUE TO EXTREME BERT | SHORTAGE. JES2 IS IN A NON-STABLE STATE. RESTART JES2 AS SOON AS MORE BERTS HAVE | BEEN MADE AVAILABLE.

| An extreme BERT shortage was previously encountered. To rectify this situation BERTS need to be added
| and JES2 must be restarted. Neither z11 nor z22 checkpoint activation will be allowed until this situation is
| resolved.

124 CYL_MANAGED=FAIL CANNOT BE PERFORMED. EITHER SPOOL/OR CHECKPOINT DATA SETS ARE ALLOCATED IN CYLINDER MANAGED STORAGE.

125 CYL_MANAGED=ALLOWED REQUIRES LARGEDS=ALLOWED OR LARGEDS=ALWAYS. LARGEDS=FAIL CANNOT BE SPECIFIED IF CYL_MANAGED=ALLOWED.

126 CYL_MANAGED=FAIL CANNOT BE PERFORMED WHILE A START SPOOL COMMAND IS PENDING.

127 REQUIRED SPOOL VOLUMES NOT AVAILABLE.

SPOOL volumes that are required for the command are currently inactive.

128 BOTH TARGET= AND SPACE= ARE REQUIRED WHEN MIGRATING TO A NEW SPOOL VOLUME.

A new spool volume was specified, which requires specifying both TARGET= and SPACE=. At least one of these required parameters was not specified.

130 ONLY TARGET= IS ALLOWED WHEN MIGRATING TO AN EXISTING SPOOL VOLUME.

A merge migration was specified, which requires specifying only the TARGET= parameter. This parameter requirement was not met.

131 SPOOL MIGRATION CANNOT BE CANCELLED.

Either CANCEL was specified after the COPY phase, which is not permitted, or a migration is not in progress.

- 132 **SOURCE VOLUME *volser* IS ALREADY BEING MIGRATED, IS CURRENTLY MAPPED, OR IS BEING EXTENDED.**
 The specified source spool volume *volser* cannot be migrated because it is already being migrated or is currently mapped.
- 133 **TARGET VOLUME *volser* IS BEING EXTENDED AND CANNOT BE USED FOR A MIGRATION.**
 The specified target volume *volser* cannot be used in a spool migration because it is currently being used for an extend spool data set command.
- 134 **CANCEL MUST BE SPECIFIED WITH NO ADDITIONAL PARAMETERS.**
CANCEL was specified with one or more additional parameters, which is not allowed.
- 135 **CANCEL IS ONLY VALID ON THE SOURCE OF AN ACTIVE MIGRATION.**
CANCEL was specified for a spool volume other than the source volume of a spool migration. **CANCEL** can only be specified on the source volume.
- 136 **COMMAND IS NOT ALLOWED ON *volume description*.**
 The command is not allowed on the specified spool volume, where *volume description* is one of the following:
- The source spool volume of an active migration
 - The target spool volume of an active migration
 - A mapped spool volume
 - A spool volume that would be affected by the migration.
- 137 **INSUFFICIENT SPACE ON *volume indicator**volser* FOR MASTER TGM TO MAP ALL TRACKS.**
 There is insufficient space on the specified spool volume to map all tracks, where *volume indicator* is **source volume** or **target volume**, and *volser* is the spool volume serial number.
- 138 **SOURCE AND TARGET VOLUMES MUST BE DIFFERENT.**
 Spool migration was not initiated because the same spool volume *volser* was specified for the source and target spool volumes.
- 139 **TARGET TRACK CAPACITY INSUFFICIENT TO ENCOMPASS SOURCE VOLUME.**
 Spool migration was not initiated because the target spool volume track capacity is insufficient to encompass the source volume.
- 140 **SOURCE VOLUME MUST BE INACTIVE TO MIGRATE TO NEW VOLUME.**
 Spool migration was not initiated because the source spool volume is not in an inactive state.
- 141 **MERGE REQUIRED DUE TO SOURCE VOLUME FORMAT.**
 Spool migration was not initiated because the source volume format does not permit moving to a new spool volume.
- 142 **JOB CANNOT BE RESTARTED.**
 The job cannot be restarted because the job is either not a batch job or it does not have a journal.
- 143 **SPOOL VOLUME MUST BE ACTIVE TO EXTEND ITS DATA SET.**
 The data set could not be extended because the specified spool volume is not active.
- 144 **SPOOL VOLUME DATA SET CANNOT EXTEND WHEN THE VOLUME IS MAPPED OR IS ASSOCIATED WITH AN ACTIVE MIGRATION.**
 The data set could not be extended because the specified spool volume is mapped or is associated with an active migration.
- 145 **SPOOL VOLUME CANNOT BE EXTENDED WHEN A COMMAND IS ACTIVE OR PENDING AGAINST IT.**
 The data set could not be extended because the specified spool volume has an active or pending command against it.
- 146 **SPOOL VOLUME CANNOT BE EXTENDED DUE TO A WRONG FORMAT.**

\$HASP003

The data set could not be extended because the specified spool volume is in a wrong format.

147 SPACE= TO EXTEND A SPOOL VOLUME MUST BE LARGER THAN THE CURRENT SIZE.

The spool volume could not be extended because the specified space value is less than or equal to the current size of the spool volume.

148 Job class not authorized for operator or job owner.

The job owner or operator does not have authorization for the job class.

149 CANNOT DELETE *parameter*.

CANNOT RENAME *parameter*.

A \$T or a \$DEL command was issued to alter the parameter specified. The object cannot be processed in the way being requested. The *parameter* value in the messages indicates the object of the command. See the specific command for an explanation of the restriction.

150 NOT A DEFINED JOBCLASS OR JOBCLASS GROUP.

The specified JOBCLASS or JOBCLASS group is not defined.

151 NOT A DEFINED JOBCLASS.

The specified JOBCLASS is not defined.

152 Cannot delete due to jobs awaiting execution or currently executing.

The delete request cannot be completed due to the job status of executing.

153 JOE INDEX ALREADY EXISTS.

\$TOUTDEF,WS_OPT=YES calls the internal service to create the JOE index, but the existing JOE index was found in the JES2 checkpoint. This is an internal error - a mismatch between the JOE index and JOE index control flags. Contact the IBM Support Center to report this error.

154 INTERNAL ERROR TRYING TO BUILD JOE INDEX.

An internal error was found when trying to build the JOE index. Contact the IBM Support Center to report this error.

165 Not enough free JOEs to complete request.

The number of Job Output Elements (JOEs) is insufficient to complete the command. Increase the number of available JOEs. You can purge some output that is no longer needed or use a \$T OUTDEF,JOENUM= command to increase the number of output elements.

166 JOE INDEX BUILD IN PROGRESS.

An attempt was made to create the JOE index but a previous request to create the JOE index is still in progress. Wait for the previous request to complete and retry the command. Alternatively, run the \$TOUTDEF,WS_OPT=NO command to both cancel the previous request and disable the JOE index.

167 Job class limit cannot be exceeded.

An attempt to add a job class is rejected because the maximum number of job classes (512) has been exceeded.

168 HOLD and DORMANCY cannot be changed when CYCLEMGT=AUTO.

An attempt was made to change either HOLD or DORMANCY but CYCLEMGT=AUTO is in effect, so the change is rejected.

169 Multiple JOBGROUPs found.

Multiple JOBGROUPs were found that meet the criteria, so the command is rejected.

System action: The system does the following:

- If JES2 encounters an incorrect initialization statement, JES2 ignores all parameters on that statement. If the initialization statement is defining a device, JES2 will create that device using all device default settings.
- If JES2 encounters an incorrect initialization statement, parameter processing requests input from the operator console instead of from the normal PARMLIB input, thus allowing the operator to correct the error, if necessary.
- If a JES2 command was entered in error, processing continues. The command does not take effect.

- If the error was encountered while JES2 was trying to issue a message, see the documentation of that message for the system action.

Operator response: Do one of the following:

- If an operator command was entered in error, correct the problem and reenter the command.
- If the error occurred while JES2 was trying to issue message **HASP nnn** , see the documentation of that message and respond accordingly.

System programmer response: See *z/OS JES2 Initialization and Tuning Reference* or *z/OS JES2 Installation Exits* for information about correcting the initialization statement errors. See *z/OS JES2 Commands* for information about correcting the JES2 command errors.

Module: HASPCOMM, HASPNUC, HASCSCAN, HASPSERV, HASPSXIT, HASPSXDV, HASPSXNJ, HASPSXOT

Routing Code: 1,2,10

Descriptor Code: 2,7

Note: If **ERROR BUILDING MESSAGE HASP nnn** is displayed, this message (\$HASP003) also has the routing and descriptor codes of message \$HASP nnn .

\$HASP004

Explanation:

▶▶—COMMAND PREFIX INVALID:—*text*—RC=—*rsnc*—————▶▶

The command prefix specified by the CONCHAR parameter of the CONDEF statement either at initialization or through a \$T command is not valid.

In the message text:

rsnc The reason code.

text The explanatory text accompanying the reason code.

rsnc text

01 PREFIX ALREADY DEFINED

The prefix specified already exists in the sysplex, if the scope is SYSPLEX, or on this system, if the scope is SYSTEM.

02 PREFIX IS A SUBSET OF ANOTHER

System action: If JES2 detects the error during initialization, JES2 issues message \$HASP428 and then ends. If JES2 detects the error while processing a \$T command, the command fails and JES2 continues to use the previously defined prefix.

Operator response: Notify the system programmer.

System programmer response: For JES2 initialization, choose a different command prefix. For a \$T command, either choose a new prefix or JES2 continues to use the prefix already in use.

Module: HASPSERV

Routing Code: 2,10

Descriptor Code: 4

\$HASP005

Explanation:

▶▶—COMMAND PREFIX NOT DEFINED,—ERROR IN CONSOLE SERVICES (CPF MACRO).—RETURN CODE=—*rc*—————▶▶

\$HASP007 • \$HASP050

►REASON CODE=*rsnc*◄

During JES2 initialization processing, MVS detected an error while defining a command prefix. The command prefix is defined on the CONCHAR parameter of the CONDEF initialization statement.

In the message text:

rc The return code from the CPF assembler macro.

rsnc The reason code from the CPF assembler macro.

System action: JES2 initialization processing ends.

Operator response: Notify the system programmer.

System programmer response: Do the following:

1. Look up the return code and reason code in *z/OS MVS Programming: Authorized Assembler Services Reference ALE-DYN* under the CPF macro.
2. Correct the problem.
3. Restart JES2.

Module: HASPSERV

Routing Code: 2,10

Descriptor Code: 4

\$HASP007

Explanation:

►►APAR OW28617 WAS NOT ACTIVATED—DUE TO CHECKPOINT DATA SET CONSTRAINTS◄◄

An attempt was made to increase the size of the checkpoint data set to include the JQX CTENT header. This attempt failed because there was not enough space in the checkpoint data set to increase the size.

System action: JES2 initialization continues.

Operator response: Notify the system programmer.

System programmer response: The checkpoint reconfiguration dialog should be used to move to a larger checkpoint data set and JES2 should be restarted.

Module: HASPCKPT

Routing Code: 1,2,10

Descriptor Code: 2,4,7,11

\$HASP050

Explanation:

►►JES2 RESOURCE SHORTAGE OF—*resource-type* — *nnn*—% UTILIZATION REACHED—*optional text*◄◄

optional text can be one of the following

**A TOTAL OF *aaaaa* *resource-type* ARE
CURRENTLY DEFINED, OF WHICH:
xxxxx (*xxx*%) ARE IN USE
yyyyy (*yyy*%) ARE BEING WAITED FOR
zzz PROCESSORS REQUESTED *resource-type*
BUT DID NOT WAIT
THE LARGEST UNFULFILLED REQUEST WAS**

FOR *bbbb resource-type*
**A MINIMUM OF *cccc resource-type* ARE
 REQUIRED TO SATISFY CURRENT DEMAND**

JES2 has a shortage of the resource type identified in the message text. The threshold percentage of utilization of the resource is displayed. The percentage is based on volumes available for allocation (active spool volumes).

The presence of the optional text indicates that the demand for the resource is greater than the current number of resources that are defined. Throughput might be increased by increasing the number of the resources that are defined.

A resource shortage is defined as one of the following:

- A percent utilization value for the resource was specified either on the initialization statement or on a \$T command, and JES2 is now using more than that percentage of the resource.
- No percent utilization value was specified on the initialization statement or on a \$T command, and JES2 is now using more than 80% of the resource. (80 percent is the default for the percent utilization value.)
- The demand for the resource exceeded 100% within the last 32 seconds. The message includes optional text indicating that JES2 was unable to fulfill some request for the resource. Note that the message displays the **current** utilization which might be a value lower than your installation-defined threshold.

In the message text:

resource-type

The type of resource for which the shortage exists.

nnn The current utilization percentage of the resource.

aaaa The total number of resource *resource-type* that is currently defined.

xxxx The number of resource *resource-type* that is currently in use.

xxx The percentage of the total resource that is currently in use.

yyyy The number of resource *resource-type* for which JES2 processors are currently waiting, because their requests could not be satisfied. If this value is non-zero, the utilization percentage (*nnn*) might be less than the threshold percentage.

yyy The amount of the resource being waited for, expressed as a percentage of the currently defined total.

zzz The number of processors that attempted to obtain resource *resource-type*, but had their requests denied because of a shortage, and did not wait for the resource. If this value is non-zero, the utilization percentage (*nnn*) might be less than the threshold percentage.

bbbb The size of the largest unfulfilled request for *resource-type*.

cccc The estimated total number of resource-type that would be required to fulfill all current outstanding requests.

The resource types and the corresponding initialization statements are:

resource-type

Initialization Statement

BERT (block extension reuse table)

BERTNUM on CKPTSPACE

BSCB (bisynchronous buffers)

BSCBUF on TPDEF

BUFX (extended logical buffers)

EXTBUF on BUFDEF

CKVR (checkpoint versions)

NUMBER on the CKPTDEF statement

CMBs (console message buffers)

BUFNUM on the CONDEF statement

\$HASP050

CMDs CMDNUM on the CONDEF statement

ICES (SNA interface control elements)

SESSIONS on the TPDEF statement

LBUF (logical buffers)

BELOWBUF on the BUFDEF statement

JNUM (job numbers)

RANGE on the JOBDEF statement

JQEs (job queue elements)

JOBNUM on the JOBDEF statement

JOEs (job output elements)

JOENUM on the OUTDEF statement

NHBs (NJE header/trailer buffers)

HDRBUF on the NJEDEF statement

SMFB (system management facilities buffers)

BUFNUM on the SMFDEF statement

TGs (spool space/track groups)

TGSPACE=(MAX=) on the SPOOLDEF statement

TTAB (trace tables)

TABLES on the TRACEDEF statement

VTMB (VTAM[®] buffers)

SNABUF on TPDEF

For example, on the CONDEF initialization statement, LIMIT=20 tells JES2 to generate 20 console message buffers and WARN=75 tells JES2 to issue this message when 75% of those buffers are being used.

Note: If a CMB shortage is reached, remote messages may be discarded to alleviate the shortage.

System action: Processing continues. If the utilization percentage decreases, JES2 deletes this message from the console 32 seconds after it is issued. If the utilization percentage still exceeds the threshold value, JES2 reissues this message with the new utilization percentage displayed. This process continues until the resource shortage is relieved (either by less use of the resource or by an increase in the threshold). If JES2 ends before the shortage is relieved, the message is deleted.

For the resources that are monitored on a MAS-wide basis (JNUM, JQEs, JOEs and TGs), the message can be displayed to the console by any member. The operator will not see redundant messages issued to the console by every member if the MVS MSCOPE>(*ALL) command was specified, but messages from all members are written to hardcopy. If MSCOPE>(*ALL) was not specified in the MVS CONSOLxx PARMLIB member, the operator might miss seeing this message.

For CMDS, the CMDNUM value on CONDEF can be changed through the \$TCONDEF command.

Operator response: Notify the system programmer. If *resource-type* is either JQEs (job queue elements) or JOEs (job output elements), any operator in the MAS can relieve the shortage by doing one or more of the following:

- Entering the \$OQ command to release held output.
- Purging unneeded output.
- Making unprocessed output eligible for selection by changing printer characteristics.

System programmer response: If this message appears frequently (or continues to be issued):

- Increase the percent utilization value with an operator command.
- Take steps to lower the usage of the resource.
- If the extended form of the message appears, increase the number of the resource to at least *cccc*, if possible.

Module:

HASPMISC

Routing Code: 2,10

Descriptor Code: 2,7

\$HASP051

Explanation:

- ▶▶—EXTREME BERT SHORTAGE DETECTED.—JES2 PROCESSING IS IN A NON-STABLE STATE.—————▶
- ▶—RESTART JES2 AS SOON AS MORE BERTS HAVE BEEN MADE AVAILABLE.—————▶▶

System action: JES2 Processing continues.

Operator response: Notify the system programmer.

System programmer response: Increase the number of free BERTs by using one of the following methods:

- Increase the number of BERTs for JES2 processing by using the \$T CKPTSPACE,BERTNUM=*nnn* command. If the number of BERTs cannot be increased because of checkpoint space, use one of the following methods:
 - Decrease the number of JOEs (\$T OUTDEF,JOENUM=*nnnnn*) and then try increasing the number of BERTs again.
 - Decrease the number of JQEs (\$T JOBDEF,JOBNUM=*nnnn*) and then try increasing the number of BERTs again.
 - Allocate a new larger checkpoint data set or structure and perform a checkpoint reconfiguration (\$T CKPTDEF,RECONFIG=YES) to begin using the new data set or structure. Then try increasing the number of BERTs again.
- Reduce the number of jobs in the preexecution phase (look at results of \$DN,Q=XEQ).

Restart JES2 after the number of free BERTs has been increased. For example, perform a JES2 hot start after a \$P JES2,ABEND command.

Module: HASPJQS, HASPXEQ

Routing Code: 2,10,42

Descriptor Code: 7,11

\$HASP052

Explanation:

- ▶▶—JES2 BERT resource shortage is critical—immediate action required—————▶
- ▶—DO NOT TERMINATE JES2 OR IPL.—Doing so may result in a COLD start.—————▶
- ▶—Current BERTNUM=*nnnnn*, Free BERTs=*nnn*—————▶
 - └─No batch jobs can be submitted┘
- ▶—JQEs requiring BERTs cannot be added └─No batch jobs, STCs or TSUs can be submitted┘—————▶
- ▶—Correct BERT shortage by—\$T CKPTSPACE,BERTNUM=*nnnn* (increase BERTs)—————▶
 - └─\$P Jnnnn (purge pre-execution jobs)┘

Batch jobs will not be added to the queue if the number of BERTs is fewer than 32. No jobs of any kind will be added to the queue if the number of BERTs is fewer than 16.

HASP052 is issued every 32 seconds until the extreme shortage has been relieved.

System action: JES2 Processing continues.

Operator response: Do not terminate JES2 and do not IPL. Notify the system programmer.

System programmer response: Increase the number of free BERTs by using one of the following methods:

- Increase the number of BERTs for JES2 processing by using the \$T CKPTSPACE,BERTNUM=*nnn* command. If the number of BERTs cannot be increased because of checkpoint space, use one of the following methods:

\$HASP060 • \$HASP064

- Decrease the number of JOEs (\$T OUTDEF,JOENUM=*nnnnn*) and try increasing the number of BERTs again.
 - Decrease the number of JQEs (\$T JOBDEF,JOBNUM=*nnnn*) and try increasing the number of BERTs again.
 - Allocate a larger checkpoint data set or structure and perform a checkpoint reconfiguration (\$T CKPTDEF,RECONFIG=YES) to use the data set or structure. Then try increasing the number of BERTs again.
- Reduce the number of jobs in the pre-execution phase (see the results of \$DN,Q=XEQ).

Module: HASPMISC

Routing Code: 2,10

Descriptor Code: 7,11

\$HASP060

Explanation:

►►—ISGENQ FAILURE—RC=*retcd* RSN=*rsncd*—RNAME=*rname*—►►

An unexpected return code that indicates that an attempt has been made to obtain an ENQ using the ISGENQ service.

In the message text:

retcd The return code from the ISGENQ service.

rsncd The reason code from the ISGENQ service.

rname The rname (minor name) of the resource that is the target of ENQ. The major name is SYSZJES2.

System action: The ENQ being requested is not obtained and error processing begins. If the resource represents the JES2 checkpoint data set, a reconfiguration dialog will appear.

Operator response: Respond as directed by subsequent messages to recover the resource that is the target of the ENQ.

System programmer response: See the explanation of the return and reason codes for the ISGENQ macro to determine the appropriate action.

Module: HASPCKPT, HASPCKDS, HASPIRDA

Routing Code: 2,4,10

Descriptor Code: 4

\$HASP064

Explanation:

►►—MIGRATION—READ—WRITE—I/O ERROR ON—*device*—AT—*unit*—EXCP CC=*cc1* IOS CC=*cc2* CSW STATUS=*stat*—►►

►—CSW COUNT=*count*—IOB SENSE=*sens*—*sens*—DEVICE SENSE=*ssssssss sssssss sssssss sssssss*—►

►—*ssssssss sssssss sssssss sssssss*—SEEK ADDRESS =*bbccc*CC:*h-r*, MQTR=*mmtttttttr*—►

►—CURRENT CCW(S) *address1* =*opwwwwww,wwwwwwww*—*address2* =*opwwwwww,wwwwwwww*—NO CURRENT CCW—►►

An input/output error has occurred on the indicated JES2 device.

In the message text:

device The VOLSER associated with the device.

unit Specifies a 4-digit hexadecimal device number.

cc1 EXCP compatibility completion code associated with the error.

- cc2** IOS completion code from the IOBE control block (if available).
- 41 Permanent I/O error.
 - 42 Extent error (DASD only). Either IOBSEEK lies outside the extents described by the DEB or the channel program attempted execution outside the current extent.
 - 43 Duplexed I/O request was not started because of the UCB level or a not ready device.
 - 44 An error occurred after the previous I/O request to the device was posted complete. The appendages and (if allowed to execute) the ERP have determined that this is a permanent error. The I/O request is terminated with the permanent error. The CSW contents and sense data in the IOB do not apply to the attempted operation. They apply to the previous operation attempted for any data set on the device. You can reissue the EXCP macro instruction to restart the channel program.
 - 45 A program check or machine check occurred in IOS while processing the I/O request.
 - 48 The channel program was purged.
 - 49 Store or modify sub-channel request has been canceled.
 - 4A I/O prevention — either the I/O request has not been started or the I/O request has been terminated.
 - 4B An error occurred during tape repositioning that was requested by the tape ERP.
 - 4C Invalid exposure number.
 - 4D CC=3. GDP or NIP in control, or with IOSGDPLP set, in logical paths available (UCBLPM).
 - 4E GDP — reserved device or in conjunction with IOSRELSE, device cannot be released.
 - 4F Error recovery routines were entered following a direct access error but are unable to read the home address or record 0.
 - 51 Simulated error status. The appendages and, if allowed to execute, the ERP have determined that this is a permanent error. The I/O request is terminated with the permanent error. The code indicates that the device is in a permanent error state, boxed, or not connected. The code can indicate also that a missing interrupt was detected and that the I/O operation was terminated as a result of recovery operations by the missing interrupt handler.
 - 52 The I/O request was found pending in the sub-channel by IOS, and the driver requested that the IOSB not be requeued.
 - 53 IOS canceled the I/O request because of an I/O timeout condition.
 - 54 The I/O request could not be started. The current address space did not match IOSASID and a captured UCB address was used in IOSUCB.
 - 6D CC=3 on all paths with IOSCC3WE bit set. Return request to requester.
 - 71 For fetch driver — hardware corrected data check.
 - 74 Simulated error status. This code is set as a result of attempting to start an I/O operation to a device that is in a permanent error state, boxed, or is not connected. This code is also set if a missing interrupt was detected and the I/O operation was terminated as a result of recovery operation by the missing interrupt handler. The system has set this code temporarily in IOBECBCC and IEDB to invoke the ERP, if allowed to execute, and the appendages to determine if the error is permanent or correctable. If the error is determined to be permanent, the system will change the value to 51. The system does not set the 74 code in the ECB.
 - 7D I/O exit requested the ERP to log this request.
 - 7E Intercept condition before entrance to error routine.
- stat** CSW status code.
- Specifies the device status returned in the CCW.
- 80 Attention
 - 40 Status modifier

\$HASP064

20	Control unit end
10	Control unit busy
08	Channel end
04	Device end
02	Unit check
01	Unit exception

Specifies the sub-channel status in the CCW.

80	Program controlled interruption
40	Incorrect length
20	Program check
10	Protection check
08	Channel data check
04	Channel control check
02	Interface control check
01	Chaining check

count CSW residual count — the number of bytes not transferred in the last CCW.

sens The first two sense bytes when a unit check occurs. Occasionally, the system is unable to obtain any sense bytes because of unit checks when sense commands are issued. In this case, the system simulates sense bytes by sense to X'10FE' information.

sssssss

Complete device specific sense information (set after a unit check). See the appropriate device document for an explanation of the sense information.

bbcccC:h-r

Device address of the record being processed (bb=Bin identifier, cccC=Cylinder identifier, h=Head identifier, r=record).

mmttttttrr

JES2 address of the record being processed (mm=SPOOL extent, tttttt=absolute track, rr=record)

opwwwwww,wwwwwwww

Actual CCW data.

Associated error messages may be displayed as a result of the error. For direct access, the following could be causes of the error:

1. The channel, control unit, or device may be malfunctioning.
2. The recording surface is bad, possibly indicated by the nature and the distribution of the *bbchhr* information.
3. The data set SYS1.HASPACE may have been overwritten by improper data set assignment and protection procedures. This may be indicated by wrong length record indicators.

System action: JES2 continues job processing and submits additional error messages, indicating the severity of the error to the system.

Operator response: Contact the systems programmer.

System programmer response: See "Recovery from Spool Volume Failure" in *z/OS JES2 Initialization and Tuning Guide*.

Module: HASPRAS

Routing Code: 2,4,10

Descriptor Code: 4

\$HASP065

Explanation:

▶▶—AWAITING RESPONSE TO \$HASP—*xxx*—MESSAGE, AUTO-REPLY IN—*sec*—SECONDS—▶▶

JES2 has issued a WTOR for the \$HASP*xxx* message and is waiting for a reply. After 5 minutes, JES2 issues this message to inform the operator that no reply has been given. This message is repeated every 30 seconds with an updated *sec* value. If the WTOR has not been replied to when *sec* reaches 0, JES2 will take a default action based on the WTOR that is pending.

In the message text:

\$HASP*xxx*

The message id associated with the WTOR JES2 is waiting for.

sec The number of seconds remaining before JES2 takes a default action.

System action: JES2 repeats this message every 30 seconds until the time in message goes to 0 or the WTOR is replied to. If the times runs out before a reply is received, then a default action will be taken and the WTOR will be deleted. The default action is described in the system action of the WTOR.

Operator response: Reply to the WTOR listed in the message. See the WTOR explanation for details on how to reply.

System programmer response: None.

Module: HASPTERM

Routing Code: 1,2,10

Descriptor Code: 2,7

\$HASP068

Explanation:

▶▶—PARTIAL RECOVERY SUCCESSFUL —*xxxxxxxx*—PCE ENDED JES2 CONTINUES WITHOUT—*desc*—▶▶

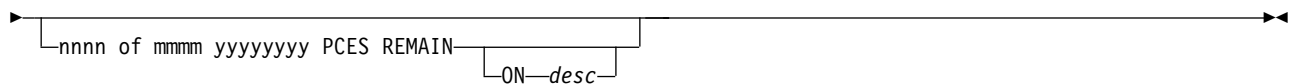

JES2 encountered an ABEND in a situation where no active recovery (\$ESTAE) existed. At the time of the ABEND, the PCE in control was not considered a required PCE for continued JES2 operations. JES2 will permanently suspend the failing PCE and will continue running without the function provided by that PCE. See Appendix A, "PCE list," on page 553 for a summary table of PCEs, their functions, and the JES2 system implications to losing the PCE.

In the message text:

xxxxxxxx

Name of the PCE or device that has failed. The list of valid PCE's can be obtained through a \$DPCE command. If the failed PCE has a device associated with it, the device name is displayed (for example; PRT1).

desc Short description of the PCE type that failed and the function it performs. (For example; PRINTER or RESOURCE MONITOR).

nnnn The number of PCEs of the type specified that have not been ended.

mmmm

The number of PCEs of the specified type that exist.

yyyyyyyy

The same as *xxxxxxxx*, except in the case of internal readers. When *xxxxxxxx* is INTRDR, STCINRDR, or TSUINRDR, then *yyyyyyyy* is always INTRDR.

ON device

Displays the remote or line with which the remote or network PCE is associated.

\$HASP069 • \$HASP070

System action: System continues processing without the function provided by the listed PCE.

Operator response: Contact the systems programmer.

System programmer response: Determine the impact of the lost function to the installation. If the function is critical to normal operation, a \$PJES2,ABEND is required to end JES2 (\$PJES2 won't work), then restart JES2. If not, JES2 will continue running without the listed function until the next restart of JES2.

Module:

HASPTERM

Routing Code: 1,2,10

Descriptor Code: 7,11

\$HASP069

Explanation:

▶— JES2 SYSTEM DUMP SUPPRESSED BY —┐ DUMP ANALYSIS ELIMINATION ┘ ┐ SLIP ┘ —▶
└─┐ INSTALLATION REQUEST ┘ —▶

JES2 requested an SVC dump.

JES2 found that:

- The requested dump contained the same symptoms as an existing dump by the Dump Analysis Elimination (DAE) routine.
- A SVC dump was suppressed by a SLIP NODUMP command.
- A SVC dump was suppressed by a request from the installation (for example, DUMP=NO at IPL or CHNGDUMP SET,NODUMP).

System action: JES2 continues processing.

Operator response: None.

Module: HASPRAS

Routing Code: 1,2,10

Descriptor Code: 4

\$HASP070

Explanation:

▶— SPECIFY RECOVERY OPTIONS —('RECOVER' OR 'TERMINATE'— OR 'SNAP' AND, OPTIONALLY, —▶
▶— ',NODUMP') —▶

A JES2 error has occurred and JES2 has issued message \$HASP095 to describe the error. The JES2 error rate has reached or exceeded the value specified on the RECVOPTS initialization statement (RECVOPTS COUNT=nn, INTERVAL=hhhh, where nn is the number of system ABENDs of the JES2 main task plus the number of JES2 catastrophic errors within the interval of hhhh hours. The default values for nn and hhhh are 2 and 24, respectively). The JES2 processor that was running has a recovery routine for this error, but because the error rate has exceeded the value specified at initialization, JES2 does not automatically run the processor recovery routine. Instead, JES2 issues this message to require the operator to choose the action JES2 should take.

System action: JES2 waits for the operator to reply. If the operator replies **RECOVER**, JES2 issues an indicative dump (message \$HASP088) to the hardcopy log and then attempts recovery. If the operator replies **SNAP**, JES2 issues message \$HASP088 at the console, and then issues message \$HASP070 again. If the operator replies **TERMINATE**, JES2 stops processing and a system dump is written. If no response is made after 10 minutes, then

JES2 will take the default action of RECOVER. \$HASP065 is issued every 30 seconds to tell the operator that an automatic response will occur for the WTOR.

Operator response: Enter the appropriate reply:

RECOVER

to allow the JES2 processor recovery routine to run and to allow the automatic system dump

RECOVER,NODUMP

to allow the JES2 processor recovery routine to run and to prevent the system dump

TERMINATE

to stop JES2 and to allow the automatic system dump

TERMINATE,NODUMP

to stop JES2 and prevent the system dump

SNAP to receive message \$HASP088 at the console followed by a repeat of message \$HASP070. To prevent a system dump, reply **NODUMP** to the second \$HASP070 message.

SNAP,NODUMP

to receive message \$HASP088 at the console followed by a repeat of message \$HASP070. To prevent a system dump, reply **NODUMP** to the second \$HASP070 message. (Replying **NODUMP** on the **SNAP** option is meaningless and equivalent to replying **SNAP**.)

Module: HASPTERM

Routing Code: 1,2,10

Descriptor Code: 4

\$HASP071

Explanation:

▶▶—INVALID REPLY TO \$HASP070—◀◀

The operator entered an incorrect reply to message \$HASP070.

System action: JES2 reissues message \$HASP070.

Operator response: Enter a valid reply to message \$HASP070.

Module: HASPTERM

Routing Code: 1,2,10

Descriptor Code: 4

\$HASP072

Explanation:

▶▶—RECOVERY IN PROGRESS—◀◀

An error has occurred in a JES2 processor (for example, in the JES2 command processor). The processor recovery routine has received control and is attempting to recover from the error and to avoid ending JES2.

System action: While the JES2 processor recovery routine is running, JES2 runs in a quiesced state. JES2 processors that are not essential to the recovery attempt (those processors controlling readers and printers, for example) do no processing.

Operator response: None.

Module: HASPTERM

Routing Code: 1,2,10

Descriptor Code: 7,11

\$HASP073 • \$HASP075

\$HASP073

Explanation:

▶▶—RECOVERY SUCCESSFUL —NORMAL PROCESSING RESUMES—▶▶

A JES2 processor recovery routine successfully recovered from a JES2 error.

System action: JES2 processing continues.

Operator response: Check the \$HASP messages to see if the processor recovery routine caused any units of work to be canceled or suspended. Take corrective action, if necessary.

Module: HASPTERM

Routing Code: 1,2,10

Descriptor Code: 4

\$HASP074

Explanation:

▶▶—RECOVERY UNSUCCESSFUL—▶▶

An error occurred in a JES2 processor (for example, in the command processor). The processor recovery routine received control but was unable to recover from the error.

System action: JES2 issues message \$HASP098 to request ending options.

Operator response: Reply to message \$HASP098.

Module: HASPTERM

Routing Code: 1,2,10

Descriptor Code: 4

\$HASP075

Explanation:

▶▶—Alternate—nnnnnnnn—CELL POOL CREATED. VIRTUAL STORAGE LOSS.—▶▶

JES2 detected an error in cell pool *nnnnnnnn*. JES2 has successfully rebuilt the cell pool, but was unable to free the storage associated with the damaged cell pool.

In the message text:

nnnnnnnn

The number of the damaged cell pool.

System action: Processing continues.

Operator response: Contact the system programmer.

System programmer response: When possible, schedule a JES2 restart to reclaim the lost storage.

Module: HASCPOOL

Routing Code: 1,2,10

Descriptor Code: 4

\$HASP076

Explanation:

▶▶—NO ALTERNATE—*type*—CELL POOL CREATED FOR DAMAGED CELL POOL.—LOSS OF VIRTUAL STORAGE.—▶▶

JES2 detected an error in a cell pool, but was unable to rebuild the damaged cell pool. All storage associated with the cell pool is lost.

In the message text:

type The type of cell pool affected.

System action: Processing continues.

Operator response: Contact the system programmer.

System programmer response: Examine the original cell pool to find out why it cannot be rebuilt. When the problem is resolved, issue a warm start.

Module: HASCPOOL

Routing Code: 1,2,10

Descriptor Code: 4

\$HASP077

Explanation:

▶▶ [JOB—*jobname*]—SUBTASK FAILED—ACCESS REQUEST DENIED DURING—NJE SESSKEY EXTRACT—▶▶

▶ [JES2—*function*]— [USER—*function*]— [REQUEST NUMBER—*nnn*]—▶▶

A failure occurred in the JES2 general purpose subtask during access verification performed for a command, remote signon, or the specified job. The access request was denied for installation-specified function *nnn* or during authorization checking for one of the following functions:

- \$DESTCHK authorization call
- Audit for job in error
- Command authorization
- Data set delete
- DCT SECLABEL extract
- Device authorization
- Environment extract
- JESNEWS update processing
- JESNEWS token build
- Job XMIT/OFFLOAD
- NEWS SYSOUT data set create
- NJE SYSOUT data set authorization
- Notify user token extract
- Printer data set select
- PSO data set open
- PSO data set select
- RJE SIGNON/LOGON
- OUTPUT descriptor modify
- Reverify token extract

\$HASP078

- SECLABEL affinity extract
- Security environment initialization
- Security environment create
- Security environment delete
- SJF services token extract
- SPOOL browse data set open
- Subtask ACEE create
- SYSIN data set create
- SYSIN data set open
- SYSOUT application programming interface (API)
- SYSOUT data set create
- SYSOUT data set open
- SYSOUT XMIT/OFFLOAD
- SYSOUT XMIT/OFFLOAD VERIFYX
- System SYSOUT data set create
- Token build
- Trace SYSOUT data set create
- TSO cancel
- Unknown request
- NJE secure signon session key extraction

In the message text:

jobname

The name of the failed job.

function

The name of the failed function for which access was denied during authorization checking.

nnn

The name of the installation-specified function for which access was denied.

Note: A jobid may appear before \$HASP077 if your installation includes the jobid in the console message format and if this message is issued on behalf of a job (not a command or remote signon).

System action: JES2 sets a return code indicating that an access request was denied. If the authorization check was for user or job verification, JES2 flushes the job. Processing for all other cases, and for user functions, depends upon the requester.

JES2 also issues the \$HASP078 message, which identifies the subtask that ABENDED.

Operator response: Notify the system programmer of this message.

System programmer response: Determine why the failure occurred by examining the abend and reason codes issued with the corresponding \$HASP078 message.

Module: HASPNUC

Routing Code: 2,9,10

Descriptor Code: 3,6

\$HASP078

Explanation:

►►—xxxxxxx—SUBTASK FAILED – ABEND—*cde*—RC=—*rsnc*—◄◄

This message identifies the subtask *xxxxxxx* that abended. The displayed completion code *cde* and reason code RC=*rsnc* are obtained from the SDWA for the abend.

In the message text:

xxxxxxx

The identifier of the abended subtask.

cde The completion code.

rsnc The reason code.

Note: The subtask identifier is the same name as the TYPE parameter of the RECVOPTS initialization statement.

System action: JES2 begins subtask recovery processing, unless the indicated subtask is HASPVTAM, for which there is no recovery.

Operator response: Notify the system programmer. In the case of a HASPVTAM failure, a JES2 hot start is required.

System programmer response: See *z/OS MVS System Codes* for an explanation of the completion code and the reason code. Use these codes, the JES2 snap abend analysis, and the SVC dump (if any) to correct the problem.

Module: HASPRAS

Routing Code: 1,2,10

Descriptor Code: 4

\$HASP079

Explanation:

▶▶—xxxxxxx—SUBTASK REINSTATED—▶▶

Recovery processing is complete for the indicated subtask. The subtask identifier xxxxxxxx displayed in the text is the same name as the subscript of the RECVOPTS initialization statement.

In the message text:

xxxxxxx

The reinstated subtask.

System action: Normal processing continues.

Operator response: None.

Module: HASPRAS

Routing Code: 1,2,10

Descriptor Code: 4

\$HASP080

Explanation:

▶▶—JES2 SYSTEM DUMP REQUESTED—FROM—mod (adr)—+ X'000000'—▶▶

An SVC dump was requested by a JES2 module. The request was issued from offset X'000000' in the module.

In the message text:

mod The name of the module

addr The address of the module

X'000000'

The offset into the module

Messages issued before the \$HASP080 message define the reason for the dump request.

System action: JES2 requests a dump of the appropriate storage areas, address spaces, and diagnostic information.

Operator response: Notify the system programmer, and note the descriptions of messages issued before message \$HASP080.

\$HASP081 • \$HASP082

Save the hard-copy log. For systems with remote consoles, save the remote console sheet.

System programmer response: Print the dump taken (or use IPCS to view the dump), and note the descriptions of the messages issued before \$HASP080.

If you used SMP/E to make all changes to the system, run the LIST CDS and LIST PTFBY functions of SMP/E to obtain a list of the current maintenance from the SMP/E control data set (CDS).

If you changed the system without using SMP/E, run the LISTIDR function of AMBLIST to obtain a list of all members with a PTF or local fix and save the output. Run the LISTIDR against the following data sets:

- SYS1.SVCLIB
- The library that contains the program that issued the message.
- SYS1.LPALIB.

Run EREP to format the LOGREC data set and save the resulting output.

Module: HASPRAS

Routing Code: 1,2,10

Descriptor Code: 4

\$HASP081

Explanation:

▶▶—JES2 SYSTEM DUMP UNSUCCESSFUL—▶▶

The SDUMP requested by JES2 after issuing message \$HASP080 has failed. A probable cause is that the dump data set is full.

Note: This message is also issued if the dump has been suppressed by either dump analysis elimination (DAE) or a SLIP command.

System action: The JES2 module that requested the SDUMP did not specify operator intervention if an error occurred while issuing the SDUMP. Therefore, the module regains control. JES2 processing continues, and the dump request is canceled.

Operator response: Notify the system programmer.

System programmer response: Determine the reason(s) why the SDUMP failed using the IEA messages issued and correct the problem.

Module: HASPRAS

Routing Code: 1,2,10

Descriptor Code: 4

\$HASP082

Explanation:

▶▶—INSTALLATION EXIT 26 ABEND—*cde*—AT—*mod* (*adr*)—+ X'000000'—▶▶

Installation exit 26 abended. The message text includes diagnostic information:

cde The abend completion code for the failing exit routine.

mod The failing module name.

adr The module address.

X'000000'
The offset from the module address to the failing instruction.

System action: The ESTAE issuing this message requests an SDUMP. Control is returned to the JES2 main task where normal JES2 end processing continues.

Operator response: Notify the system programmer.

System programmer response: Print and analyze the SDUMP. See other messages and the system completion code described in *z/OS MVS System Codes*.

Module: HASPTERM

Routing Code: 1,2,10

Descriptor Code: 11

\$HASP083

Explanation:

▶▶—R13 NOT A VALID PCE ADDRESS—▶▶

The operator responded SNAP in reply to message \$HASP070 or \$HASP098, requesting an indicative dump. JES2, during indicative dump processing, found that register 13 contains zeros or an incorrect processor control element (\$PCE) address.

System action: Indicative dump processing continues, but PCE information is not displayed in message "\$HASP088 PCE = pceid (adr)". When indicative dump processing completes, message \$HASP098 is issued.

Operator response: None.

Module: HASPTERM

Routing Code: 1,2,10

Descriptor Code: 4

\$HASP084

Explanation:

▶▶—INVALID SAVE AREA CHAIN—▶▶

The operator responded SNAP in reply to message \$HASP070 or \$HASP098, requesting an indicative dump. JES2, during indicative dump processing, found that the chain of processor control element (\$PCE) save areas in fields PSVNEXT and PSVPREV is in error.

System action: Indicative dump processing continues, but message "\$HASP088 – CALLED BY mod2" is not included in the output. When the indicative dump completes, message \$HASP098 is issued.

Operator response: None.

Module: HASPTERM

Routing Code: 1,2,10

Descriptor Code: 4

\$HASP085

Explanation:

▶▶—JES2 TERMINATION COMPLETE—▶▶

JES2 has ended because the operator entered the \$P JES2 command or the operator replied EXIT or PURGE to message \$HASP098. If PURGE was entered, JES2 attempts to end any attached tasks.

System action: JES2 ends.

\$HASP086 • \$HASP088

Operator response: None.

Module: HASPTERM

Routing Code: 1,2,10

Descriptor Code: 4

\$HASP086

Explanation:

▶▶—WARNING —JES2 CHECKPOINT LOCK NOT RELEASED—▶▶

JES2 has abnormally ended without releasing the DASD resident checkpoint data set lock.

System action: When any other system in the multi-access spool configuration cannot obtain the checkpoint data set lock, it issues message \$HASP264 or \$HASP479.

Operator response: See the descriptions of messages \$HASP264 and \$HASP479 and correct the problem.

Module: HASPTERM

Routing Code: 1,2,10

Descriptor Code: 1

\$HASP087

Explanation:

▶▶—JES2 FAILED—DURING TERMINATION PROCESSING,—ABEND CODE—*cde*—▶▶

HASPTERM abended while JES2 was stopping.

In the message text:

cde The system or installation completion code.

System action: An SDUMP is requested by the ESTAE issuing this message. JES2 stops processing.

Operator response: Notify the system programmer.

System programmer response: See other error messages and the description of the completion code. Print and analyze the SDUMP. For descriptions of the system completion codes, see *z/OS MVS System Codes*.

Module: HASPTERM

Routing Code: 1,2,10

Descriptor Code: 4

\$HASP088

Explanation:

```
Only 32 bit registers are being used
----- JES2 [SUBTASK ] ABEND ANALYSIS -----
FMID  = xxxxxxxx      LOAD MODULE = lmodname
SUBSYS = ssss vvvvvvvv uuuuuuuu
DATE  = yyyy.ddd      TIME   = hh.mm.ss
[DESC = text]
MODULE  MODULE  OFFSET  SERVICE  ROUTINE  EXIT
NAME    BASE    + OF CALL  LEVEL   CALLED   ##
-----
modname strtadr + offset  ptfnum  rtn-or-abend  exit
[GENERAL PURPOSE SUBTASK CALLER]
[callname1 strtadr + offset  ptfnum  rtnname]
FAILING INSTR WAS instr
PSW  = psw          ILC = n  IC = mm
```

```

BEA = Modname Address + offset
TEA = tea_addr
SID = asid (HOME) asid (PRIM) asid (SCND)
{PCE = pceid (adr) [jobid] [jobname]}
DTE = tasktype (adr)}
R0 = r0 r1 r2 r3
R4 = r4 r5 r6 r7
R8 = r8 r9 r10 r11
R12 = r12 r13 r14 r15

```

```

-----
      The full 64 bit registers are being used
----- JES2 [SUBTASK ] ABEND ANALYSIS -----
FMID = xxxxxxxx      LOAD MODULE = lmodname
SUBSYS = ssss vvvvvvvv uuuuuuuu
DATE = yyyy.ddd      TIME = hh.mm.ss
[DESC = text]
MODULE  MODULE  OFFSET  SERVICE  ROUTINE      EXIT
NAME    BASE    + OF CALL  LEVEL    CALLED       ##
-----
modname strtadr + offset  ptfnum  rtn-or-abend  exit
[GENERAL PURPOSE SUBTASK CALLER]
[callname1 strtadr + offset  ptfnum  rtnname]
FAILING INSTR WAS instr
PSW = psw          ILC = n  IC = mm
BEA = bea_addr
TEA = tea_addr
SID = asid (HOME) asid (PRIM) asid (SCND)
{PCE = pceid (adr) [jobid] [jobname]}
DTE = tasktype (adr)}
R0 = r0 r1
R2 = r2 r3
R4 = r4 r5
R6 = r6 r7
R8 = r8 r9
R10 = r10 r11
R12 = r12 r13
R14 = r14 r15
-----

```

JES2 writes this message to SYSLOG when the operator replies SNAP in response to message \$HASP070 or \$HASP098, or when a JES2 subtask ABENDs. This message contains the requested indicative dump information.

In the message text:

- xxxxxxx SMP Function Modification ID for the current JES2 product.
- lmodname The name of the load module in which the error occurred.
- sss Subsystem name (such as JES2 or JESA).
- vvvvvvvv Subsystem version identifier.
- uuuuuuuu Installation version identifier (defaults to blanks).
- yyyy.ddd Year and day of the message.
- hh.mm.ss The time in hours, minutes, and seconds when JES2 wrote the message.
- text Description of the error (such as: INVALID OPERATION CODE, DATA EXCEPTION, or ATTEMPT TO UPDATE CKPT WITHOUT A \$QSUSE). If this message describes a JES2 \$ERROR, then the text describes the \$ERROR code and a further explanation can be found in the explanation for the \$HASP095 message.

\$HASP088

The next 6 fields are repeated for each module from the module which initiated the processing through the failing module.

modname

Name of the module.

stradr

Beginning address of the JES2 module.

offset

Offset into the JES2 module of the failing instruction or the call to the next module.

ptfnum

The number of the last PTF applied to this module. If there have been no PTFs applied to this module, this field reads NONE. If this module is part of an installation exit, this field reads UNKNOWN.

rtn-or-abend

The name of the last routine called by this module. This field always contains the abend or error for the failing module.

exit

The exit number in control when the call was made to the call routine.

callname1

The module which invoked the subtask.

rtnname

The name of the last routine called by the subtask caller.

instr

The actual failing instruction. It is not given if the home ASID is not the same as the primary ASID.

psw

PSW at the time of the error.

n

Instruction length code.

mm

Interruption code.

Modname Address + offset

Breaking event address. If supported by the hardware, this is the address of the last branch instruction before a program check. This is useful for diagnosing wild branch instructions.

tea_addr

Translation exception address related to the program check. If the abend was a program check, this is the translation exception address associated with the program check. If none is available, this field will not be displayed.

asid

Address space identifiers (ASID) at the time of abend (home asid, primary asid, and secondary asid). All the address spaces indicated by this message are included in the SDUMP(s) written from this abend by JES2. These ASID values are not given on a SNAP dump if JES2 ends because of a catastrophic error (cde \$nnn) caused by a JES2 \$ERROR macro, or if an SDWA was not allocated for this abend. If the home ASID is not the same as the primary ASID, then the failing instruction is not given in the \$HASP088 message.

pceid

Name of the processor control element (\$PCE).

tasktype

The type of subtask invoked. This field can be either ALLOCATE, CONVERT, GENERAL, IMAGE, OFFLOAD, SME, SPOOL, VERSIONS, VTAM, or WTO.

JES2 displays the \$DTE field in place of the \$PCE field for subtask ABENDs.

adr

Address of the \$PCE or \$DTE.

jobid

The job identifier associated with the \$PCE (JOB, STC, or TSU).

jobname

The name of the current job.

r0-r15

Contents of the registers at the time of the error. Addresses which are qualified by ALETs are indicated with a Q by the address.

System action: When the indicative dump completes, JES2 issues message \$HASP098.

System programmer response: Note that if the home ASID is not the primary ASID, diagnosis from the associated dump(s) should be done recognizing that the \$HASP088 message trace indicates activity within the JES2 address space (HOME), while the actual abend location is in the primary address space and occurred in a cross-memory "PC" routine.

Module: HASPTERM

Routing Code: 1,2,10

Descriptor Code: 4

\$HASP089

Explanation:

▶▶—JES2 SYSTEM DUMP UNSUCCESSFUL, REPLY—REPLY 'Y' TO RETRY, OR—'N' TO BYPASS DUMP—▶▶

The SDUMP requested by JES2 after issuing message \$HASP080 has failed. A possibility is that the dump data set is full. This message is also issued if the dump has been suppressed by a SLIP command.

System action: The operator is given control with this message to retry the SDUMP, if required. If no response is made after 10 minutes, then JES2 will take the default action of 'N'. \$HASP065 is issued every 30 seconds to tell the operator that an automatic response will occur for the WTOR.

Operator response: Notify the system programmer. If possible, correct the reason for the SDUMP failure and reply Y to retry the SDUMP.

Note: At this time, the JES2 subsystem issuing this message cannot start a job of any kind. If a job must be run to clear out a SYS1.DUMPxx DASD data set, the running of that job must not involve services from this subsystem.

System programmer response: Determine the reason why a successful dump cannot be issued and correct the problem.

Module: HASPRAS, HASPTERM

Routing Code: 1,2,10

Descriptor Code: 4

\$HASP090

Explanation:

▶▶—CALLER ADDRESS ARRAY OVERFLOWED—▶▶

JES2 processing is attempting to build the calling sequence for the \$HASP088 message. The calling sequence includes routines in the JES2 CSA modules. Because the linkage stack is used in these routines, the list of routines called is kept in a separate table. When JES2 attempted to access that table, the pointer to the current entry was found to be beyond the end of the table. This is probably caused by an error in maintaining the caller array.

System action: JES2 does not include any of the CSA routines in the \$HASP088 message. The rest of the message is issued normally.

Operator response: None.

System programmer response: When debugging the error, you must examine the linkage stack entries to determine which CSA routines were called.

Module: HASPTERM

Routing Code: 1,2,10

Descriptor Code: 4

\$HASP091

Explanation:

▶▶—LOGONxxx IS ACTIVE—▶▶

The operator entered a \$S LOGON:xxx command and the ACB for the device opened successfully. In the message text:

\$HASP092 • \$HASP093

xxx The identifier of the opened device.

System action: The application program interface between the SSCP and JES2 is activated for LOGONxxx.

Operator response: None.

Module: HASPSNA

Routing Code: 8

Descriptor Code: 4

\$HASP092

Explanation:

▶▶—API ERROR ON LOGONxxx—ACB,—rrrr,—SSCP,—ssss—▶▶

The interface between the SSCP and JES2 has failed.

In the message text:

xxx The identifier of the device for which the logon was attempted.

rrrr The SSCP service that was requested.

ssss The first two characters of ssss indicate the return code in register 15 after the ACB request; the last two characters indicate the setting of the ACBERFLG field.

System action: The ACB is closed and the connection between the SSCP and JES2 is ended.

Operator response: Determine if the SSCP has been started, and then try the LOGON again. If the SSCP is started and the attempt to log on fails, contact the system programmer.

System programmer response: To correct the problem, see *z/OS V2R1.0 Communications Server: SNA Programming* for explanations of the ACBERFLG setting and return code.

Module: HASPSNA

Routing Code: 8,10

Descriptor Code: 4

\$HASP093

Explanation:

▶▶—CALLER ADDRESS ARRAY UNDERFLOWED—▶▶

JES2 processing is attempting to build the calling sequence for the \$HASP088 message. The calling sequence includes routines in the JES2 CSA modules. Because the linkage stack is used in these routines, the list of routines called is kept in a separate table. When JES2 attempted to access that table, the pointer to the current entry was found to be before the beginning of the table. This is probably caused by an error in maintaining the caller array.

System action: JES2 does not include any of the CSA routines in the \$HASP088 message. The rest of the message is issued normally.

Operator response: None.

System programmer response: When debugging the error, you must examine the linkage stack entries to determine which CSA routines were called.

Module: HASPTERM

Routing Code: 1,2,10

Descriptor Code: 4

\$HASP094

Explanation:

▶▶—I/O ERROR ON SPOOL, MTTR=—*nnnnnnnn*—————▶▶

An incorrect extent was supplied when requesting I/O from a spool device. Either the “m” from the MTTR was greater than X'FD', or the spool volume designated by the “m” value was not available for use.

Note: Several versions of this message follow. Use the form that corresponds to the \$HASP094 message on your console.

In the message text:

nnnnnnnn

In hexadecimal, the location on the disk drive of the failing record in the spool data set.

System action: JES2 continues job processing and submits additional error messages, indicating the severity of the error.

Operator response: None.

Module: HASPRAS

Routing Code: 8,10

Descriptor Code: 4

\$HASP094

Explanation:

▶▶—I/O ERROR ON—*ser dev,cde,stat,sens,bbcchr*—————▶▶

An input/output error has occurred on the indicated JES2 device. The fields in the message text and their meanings are:

- ser** JES2 device name.
- dev** Specifies a 4-digit hexadecimal device number.
- cde** CCW op code used at the time of error.
- stat** CSW status code.
- sens** Sense information.
- bb** Bin, as appropriate.
- cc** Cylinder, as appropriate.
- hh** Head, as appropriate.
- r** * .record, as appropriate.

Associated error messages may be displayed as a result of the error.

System action: JES2 continues job processing and submits additional error messages, indicating the severity of the error to the system.

Operator response: Determine the cause of the error, and take appropriate action.

Module: HASPRAS

Routing Code: 8,10

Descriptor Code: 4

\$HASP094

\$HASP094

Explanation:

►►—I/O ERROR ON LINE1na—*dev,cde,stat,sensrr,xyee,ffcc*—◄◄

An error has been detected on the indicated JES2 RJE line, or on a device attached to that line. The fields in the message and their meanings are:

lna JES2 RJE line number

dev Specifies a 4-digit hexadecimal device number.

cde The codes are:

01	WRITE
02	READ
03	NOP (SYN)
07	CTCA CONTROL
08	TIC
14	CTCA SENSE
23	SET MODE
27	ENABLE
2F	DISABLE

stat CSW status code if no block sequence check.

0000 – indicator for normal channel end, with a block sequence check at the central processor

FFFF – indicator for normal channel end, with a block sequence check at the remote site

sens Sense symbol=information, if *stat*=0E00. The values are:

01	time-out
02	lost data
04	overrun
08	data check
10	equipment check
20	bus out check
40	intervention required
80	command reject

Last character received, if *stat*=0C00. The values are:

01	SOH-STX-DATA-ETB
02	DLE-STX-DATA-ETB
2D	SOH-ENQ
37	EOT
3D	NAK
61	DLE-ACK1
70	DLE-ACK0
7C	RVI (reverse interrupt)

rr Remote device first response character. See the *sens* field for a description of the possible values.

xy JES2 CCW internal sequence identification and command type. The values are:

- BSC prepare sequence:
 - C0 DISABLE (IOBCCW1)
 - C1 SET MODE (IOBCCW2)
 - C2 ENABLE (IOBCCW3)
 - C4 READ (IOBCCW6)
 - CA SYN (IOBCCW4)
 - CA WRITE ENQ/EOT or SYN (IOBCCW5)
- BSC multileaving sequence:
 - 92 ENABLE (IOBCCW1)
 - 94 READ (IOBCCW4)
 - 98 SYN (IOBCCW5)
 - 98 WRITE DATA (IOBCCW6)
 - 98 WRITE RESPONSE (IOBCCW7)
 - 99 SYN (IOBCCW2)
 - 99 WRITE RESP (IOBCCW3)
 - B4 READ (IOBCCW8)
- BSC hardware terminal read sequence:
 - 82 ENABLE (IOBCCW1)
 - 84 READ (IOBCCW4)
 - 89 WRITE RESPONSE (IOBCCW3)
 - 90 SYN (IOBCCW2)
- BSC hardware terminal write sequence:
 - A0 WRITE DATA (IOBCCW6)
 - A2 ENABLE (IOBCCW1)
 - A5 READ (IOBCCW8)
 - A6 READ (IOBCCW4)
 - A8 SYN (IOBCCW5)
 - A8 WRITE RESP (IOBCCW7)
 - AA SYN (IOBCCW2)
 - AA WRITE RESP (IOBCCW3)
- CTCA sequences (x=C or x=9):
 - x2 SENSE (IOBCCW1)
 - x4 READ (IOBCCW4)
 - x7 CONTROL (IOBCCW3)
 - x8 WRITE (IOBCCW2)
 - xA WRITE ENQ (IOBCCW2)

ee Expected response, if xy contains B4 or 94. See the *sens* field for a description of the possible values.

ff IOB flag byte 1

cc IOB completion code (IOBECBCC) for an I/O request, or '00'. If the e=y trace is on, cc should never be zero.

\$HASP094

Note:

1. This message can also occur as an informational message when a JES2 trace is requested for diagnostic purposes using the LOG=Y option on the \$T LINE(nnnn) command.
2. For BSC terminals, see the appropriate IBM component description document for descriptions of additional status and sense values.

System action: For most line errors, JES2 attempts to recover and continue processing, using the line.

Operator response: The console log should be saved for maintenance personnel (even if recovery is successful). Additional responses depend on the nature of the problem.

Module: HASPRAS

Routing Code: 8,10

Descriptor Code: 4

\$HASP094

Explanation:

►►—I/O ERROR ON LINE1na—dev—,02,0000,00—rr,—

94
B4

—ee—

A block sequence error has been detected by JES2, while communicating with a multileaving terminal. This indicates that one or more transmission blocks have been lost. This message can also occur as an informational message when a JES2 trace is requested for diagnostic purposes using the LOG=Y option on the \$T LINE(nnnn) command.

In the message text:

lna The line number.

dev Specifies a 4-digit hexadecimal device number.

rr The count received.

ee The count expected.

System action: Any job being read in is deleted and must be resubmitted.

Operator response: This represents a very serious error. Control records may have been lost, which could cause partial loss of terminal function. The line should be drained (\$P) and restarted (\$S) as soon as practical.

Module: HASPRAS

Routing Code: 8,10

Descriptor Code: 4

\$HASP094

Explanation:

►►—I/O ERROR ON LINE1na—dev—,02,0C00,0001,—

84
A6

—**—

A 2770, 2780, or 3780 terminal has disconnected without signing off, and a multileaving terminal has subsequently connected to the same line and is attempting to sign on. This message can also occur as an informational message when a JES2 trace is requested for diagnostic purposes using the LOG=Y option on the \$T LINE(nnnn) command.

In the message text:

lna The line number.

dev Specifies a 4-digit hexadecimal device number.

System action: The previous terminal is signed off, and the line is disconnected.

Operator response: The remote terminal operator must re-dial and attempt to sign on again.

Module: HASPRAS

Routing Code: 8,10

Descriptor Code: 4

\$HASP094

Explanation:

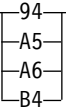
▶▶ I/O ERROR ON LINE1na—dev—,02,0C00,003D,  **

A negative acknowledge character (NAK) has been received from the remote terminal, indicating an error was detected at the terminal. This message can also occur as an informational message when a JES2 trace is requested for diagnostic purposes using the LOG=Y option on the \$T LINE(nnnn) command.
In the message text:

lna The line number.

dev Specifies a 4-digit hexadecimal device number.

System action: Normal error recovery procedures are invoked.

Operator response: None.

Module: HASPRAS

Routing Code: 8,10

Descriptor Code: 4

\$HASP094

Explanation:

▶▶ I/O ERROR ON LINE1na—dev—,02,0C00,0061,  70

▶▶ I/O ERROR ON LINE1na—dev—,02,0C00,0070,  61

JES2 has received an incorrect acknowledgment from a 2770, 2780, or 3780 terminal. This may indicate that an output device (printer or punch) at the remote terminal has become “not ready”. It may also indicate that an output block has been lost. This message can occur as an informational message when a JES2 trace is requested for diagnostic purposes using the LOG=Y option on the \$T LINE(nnnn) command.
In the message text:

lna The line number.

dev Specifies a 4-digit hexadecimal device number.

System action: The last block is retransmitted.

Operator response: The remote terminal operator should check (to any extent possible) for missing or duplicate output and should request a backspace or restart if the output looks questionable.

Module: HASPRAS

Routing Code: 8,10

Descriptor Code: 4

\$HASP094

\$HASP094

Explanation:

►►—I/O ERROR ON LINE1na dev—,02,0C00,00—rr—,84 **—————►►

Erroneous data has been received from a 2770, 2780, or 3780. This message can also occur as an informational message when a JES2 trace is requested for diagnostic purposes using the LOG=Y option on the \$T LINE(nnnn) command.

In the message text:

lna The line number.

dev Specifies a 4-digit hexadecimal device number.

rr The first significant byte received.

System action: Normal error recovery procedures are invoked.

Operator response: None.

Module: HASPRAS

Routing Code: 8,10

Descriptor Code: 4

\$HASP094

Explanation:

►►—I/O ERROR ON LINE1na—dev—,02,0C00,—i i

01
94

02
B4

 **—————►►

An incorrect ending character was received from a multileaving terminal. This message can also occur as an informational message when a JES2 trace is requested for diagnostic purposes using the LOG=Y option on the \$T LINE(nnnn) command.

In the message text:

lna The line number.

dev Specifies a 4-digit hexadecimal device number.

ii The end character received.

System action: Normal error recovery procedures are invoked.

Operator response: None.

Module: HASPRAS

Routing Code: 8,10

Descriptor Code: 4

\$HASP094

Explanation:

►►—I/O ERROR ON LINE1na dev—,02,0D00,0037,84**—————►►

The card reader on a 2770, 2780, or 3780 has become not ready. This may be caused by a card feed error or by the failure of the remote operator to activate the end-of-file switch or button. This message can also occur as an informational message when a JES2 trace is requested for diagnostic purposes using the LOG=Y option on the \$T LINE(nnnn) command.

In the message text:

lna The line number.

dev Specifies a 4-digit hexadecimal device number.

System action: The system waits for the reader to be made ready and transmission to continue.

Operator response: The remote terminal operator should correct the problem and ready the card reader (ensuring that the end-of-file switch or button is activated).

Module: HASPRAS

Routing Code: 8,10

Descriptor Code: 4

\$HASP094

Explanation:

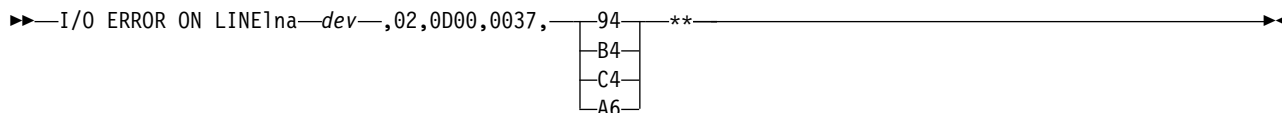

JES2 has received an unexpected end-of-transmission (EOT). This message can also occur as an informational message when a JES2 trace is requested for diagnostic purposes using the LOG=Y option on the \$T LINE(nnnn) command.

In the message text:

lna The line number.

dev Specifies a 4-digit hexadecimal device number.

System action: Normal error recovery procedures are invoked.

Operator response: None.

Module: HASPRAS

Routing Code: 8,10

Descriptor Code: 4

\$HASP094

Explanation:

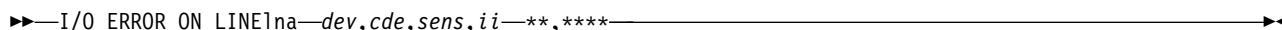

A unit check on the communications adapter has been detected by JES2. For more detailed information concerning the exact nature of the error, consult *2701 Data Adapter Unit Component Description* or *2703 Transmission Control Component Description*.

In the message text:

lna Line number.

dev Specifies a 4-digit hexadecimal device number.

cde Code.

sens Sense information.

ii Additional sense information.

System action: Processing continues.

Operator response: None.

Module: HASPRAS

Routing Code: 8,10

\$HASP094

Explanation:

►► /O ERROR ON—*devname*—SNA ,—*xx, len, iiiiii, —ttrrf feebbsccgwwvkkwwyy, luname*—►►

A VTAM RPL request has failed because an I/O error has occurred on the indicated SNA device or line.

Note:

1. This message can occur as an informational message about LINE(nnnn) or LOGON(n) when a JES2 trace is requested for diagnostic purposes using the LOG=Y option on the \$T LINE(nnnn) or \$T LOGON(n) command.
2. This message can be issued when an autologon remote failed at attempting to logon. A 6x in the *tt* field indicates autologon; the *rr* and *ff* fields contain the return and feedback codes for the failure, respectively. If recovery is possible from the condition that caused the codes, the message may be repeated for subsequent autologon attempts.
3. This message can occasionally occur if a remote SNA device cannot respond quickly enough after a BIND during remote sign on processing. System sense data in RPLFDBK2 indicates that an incorrect FM header is sent. The remote session is logged off shortly thereafter. Increase the WAITIME parameter on the SNA RMT statement to allow the remote adequate time for setup and give the remote time to be the first speaker for the SNA session.

In the message text:

devname

The device or line on which the error occurred.

SNA The type of device.

xx The VTAM request type (RPLREQ), as follows:

- X'15' SETLOGON
- X'16' SIMLOGON
- X'17' OPNDST
- X'1A' INQUIRE
- X'1F' CLSDST
- X'22' SEND
- X'23' RECEIVE
- X'24' RESETSR
- X'25' SESSIONC
- X'27' SENDCMD
- X'28' RVCMD
- X'29' REQSESS
- X'2A' OPNSEC
- X'2C' TERMSESS

For descriptions of the VTAM request types for your system, see the level of *z/OS V2R1.0 Communications Server: SNA Programming* that corresponds to the level of your system.

len The data length including FM headers (RPLRLLEN).

iiiiiii System and installation sense information (RPLFDBK2). See *z/OS V2R1.0 Communications Server: SNA Programming*.

tt The JES2 RPL sequence type (RPLSEQTP), as follows:

Normal Sequences
Type

\$HASP094

- 00 Normal RECEIVE
- 01 Normal SEND
- 02 RESETSR (continue-specific)
- 03 RESETSR (continue-any)

Special Sequences Type

- 1x Connection sequence
- 3x Disconnection sequence
- 6x Autologon sequence (see note 2 above)

rr The VTAM return code (RPLRTNCD). See the level of *z/OS V2R1.0 Communications Server: SNA Programming* that corresponds to the level of your system.

ff The VTAM feedback code (RPLFDB2). See the level of *z/OS V2R1.0 Communications Server: SNA Programming* that corresponds to the level of your system.

ee FM header type (FMHBYTE1), as follows:

- 00 No FM header
- 01 Type 1 FM header (destination select)
- 02 Type 2 FM header (PDIR)
- 03 Type 3 FM header (compaction table)
- 04 Type 4 FM header (NJE)

bb Bracket and direction controls (RPLRH3), as follows:

- X'80' Begin bracket
- X'40' End bracket
- X'20' Change direction
- X'08' Alternate code

ss The SEND/RECEIVE type (RPLSRTYP), as follows:

- X'80' Send response
- X'0C' Receive response
- X'00' Receive synchronous data
- X'06' Receive asynchronous data

cc Chaining controls (RPLCHN), as follows:

- X'80' First-in-chain
- X'40' Middle-in-chain
- X'20' End-of-chain
- X'10' Only-in-chain

gw VTAM flags (RPLVTFL1), as follows:

- X'20' VTAM fast path

For NJE SEND/RECV RPL, the **gw** field contains RID/RCB.

FM header properties (FMHPROPS) set for type 1 FM headers only, as follows:

- g** Destination select
 - 0 Resume
 - 2 Normal end

- 4 Begin
- 8 Suspend
- A Abort end
- 1 Basic exchange (used in combination with the above)
- w Data stream properties
 - 0 No compression or compaction
 - 2 Compaction only
 - 4 Compression only
 - 6 Compression and compaction
- vv VTAM flags (RPLVTF2), as follows:
 - X'80' POST = SCHED
 - X'04' Exception response
 - X'02' No definite response 1 (note inverse)
 - X'01' Definite response 2
- kk Data flow controls (DFC), first byte RPLCNTDF, as follows:
 - X'80' Normal data
 - X'40' CANCEL DFC
- ww Additional data flow controls (DFC), second byte RPLCNTDC, as follows:
 - X'40' RTR DFC
 - X'20' LUSTAT DFC
 - X'10' SIGNAL DFC
 - X'08' BIND SC
 - X'04' UNBIND SC
- yy Session control indications, third byte RPLCNTSC, as follows:
 - X'04' RQR SC
 - X'02' RSHUTD DFC

luname

The LU name when the error occurred or * if no LU name was available.

System action: Normal recovery procedures are invoked.

Module:

HASPRAS

Routing Code: 8,10

Descriptor Code: 4

\$HASP095

Explanation:

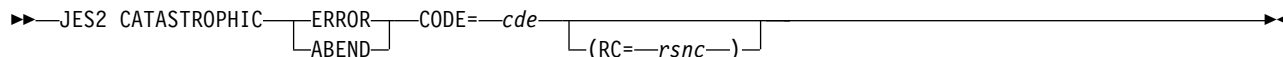

An error has caused the JES2 main task to enter the main task ESTAE routine because of an ABEND or ERROR. If the message displays ABEND, an MVS system service (GETMAIN processing, for example) detected an error or abnormally ended.

\$HASP095

If the message displays ERROR, JES2 processing detected the error.
In the message text:

- cde** One of the error codes (if a CATASTROPHIC ERROR) in the following list or one of the system completion codes (if a CATASTROPHIC ABEND) documented in *z/OS MVS System Codes*.
- rsnc** The reason code associated with the cause of this occurrence.

The *cde* field contains one of the following codes; if there is an associated reason code, this is displayed also.

Error *cde*

Explanation

- \$A01** JES2 detected more channel end indications for a device than expected. Only one channel end indication should be received from IOS for each input/output operation that JES2 has initiated.
- \$AR1** JES2 detected an internal error while processing a request from the automatic restart manager.
- \$AR2** JES2 could not process a request from the automatic restart manager because the job was active when it shouldn't have been.
- \$B01** Either an attempt has been made to return a JES2 buffer that contains an error to the buffer pool, or the free buffer chain has been destroyed.
- \$B02** Although the available buffer count for a buffer pool is non-zero, no buffer is indicated as available.
- \$B03** A JES2 processor attempted, in a single request, to obtain more buffers from a buffer pool than the maximum possible size that pool would allow.
- \$BR1** **ERROR PROCESSING BERT MAPS**
JES2 initialization processing encountered an error examining the BERT maps.
- \$BR2** **LOGIC ERROR DETECTED BY \$DOGBERT SERVICE**
A logic error has been detected in the calling sequence to the \$DOGBERT service routine.
- \$BR3** **DATA ERROR DETECTED BY xxxxxx SERVICE**
A service routine has detected a data error in the BERT CTENT. This code will only occur when DEBUG BERT=YES has also been specified.
- \$BR4** **PCE \$WAITED WITH A SPECIAL=YES BERT CB**
SPECIAL=YES has been coded on a prior \$DOGBERT or \$DOGJQE call, but a \$WAIT occurred between the ACTION=FETCH and the ACTION=RETURN.
- \$BR5** **NO BERTS TO LOCK SPECIAL=YES CB**
The \$DOGBERT call fetches data from BERTs with SPECIAL=NO. A subsequent call was made to update the BERTs. More BERTs were needed for that update and there are no BERTs available on the system.
- \$BR6** **OVERLAPPING \$BERTTAB ENTRIES**
JES2 has detected that \$BERTTAB entries have been coded which unexpectedly used overlapping offsets. The \$HASP474 message issued in conjunction with this error indicates the tables that were in error.
- \$CF1** **COUPLING FACILITY FAILURE**
JES2 initialization processing has encountered an unexpected error processing data on a coupling facility. This can be caused by starting JES2 pointing to a coupling facility structure that is not compatible with the version of JES2 being started.
JES2 has detected an incorrect list element control value associated with an element in a JES2 checkpoint structure.
It is possible that you are attempting to start a JES2 member with initialization parameters that are incompatible with the initialization parameters that are either:

- a. Currently in effect in the MAS
- or
- b. Different from those specified at cold-start time

Under these circumstances, the format of the checkpoint data set already in effect can be very different from the one expected on the member you are attempting to start. This discrepancy can cause various errors to occur, including the display of this message.

This is an example of conditions that can cause these errors to occur:

You have attempted to change a cold start initialization parameter during a warm start (for example, `JOBNUM=` on the `JOBDEF` initialization statement). See the *z/OS JES2 Initialization and Tuning Reference* for a description of initialization parameters that require a cold start.

System Programmer Response: Correct the initialization parameters so that they are compatible with the with the cold start initialization parameters currently in effect.

See the JES2 Migration Notebook applicable for the highest JES2 release running in the MAS for more details on checkpoint compatibility.

\$CF1 JES2 ERROR DURING COUPLING FACILITY ACCESS

During normal checkpoint processing, JES2 encountered an unexpected return code from an `IXLLIST` request.

\$CF2 An I/O error occurred on a checkpoint data set that resides on a coupling facility structure and 'TERM' was specified in a checkpoint reconfiguration.

\$D01 The `$GETABLE` service routine was unable to locate the DTE table for the subtask identifier specified in the `$DTEDYN ATTACH` macro call.

\$D02 The DTE table for the specified subtask identifier requests information from the user control table (UCT), however no UCT address was found in the HCT pointer field `$UCT`.

\$D03 `RC=(MVS IDENTIFY return code)`. The `MVS IDENTIFY` for the subtask requested on this `$DTEDYN ATTACH` macro failed.

\$D04 The `$GETABLE` service routine was unable to locate the DTE table for the subtask identifier specified in the `$DTEDYN DETACH` macro call.

\$D05 The DTE passed by the caller of `$DTEDYN DETACH` failed validity checking. Either the EBCDIC eye catcher was not 'DTE' or the subtask name in the DTE did not match the name in the DTE table.

\$D06 The event control block (ECB) that ends the subtask was not posted before a `$DTEDYND` macro was issued to detach the subtask. All subtasks must return to MVS before `$DTEDYND` issues the `MVS DETACH` macro for that subtask.

\$D07 The DTE table for the specified subtask identifier requested information from the user control table (UCT), however no UCT address was found in the HCT pointer field `$UCT`.

\$D08 The `$DTEDYN ATTACH` service has found an entry point address to be zero.

\$D09 The `$DTEDYN ATTACH` service has found a `HEAD=`field address that is not valid.

\$D10 The `$DTEDYN` service cannot find a required name/token pair.

\$D11 The `$DTEDYN DETACH` service has found a `HEAD=`field address that is not valid.

\$D12 The `$DTEDYN DETACH` service cannot find a required name/token pair.

| \$DAU1 INVALID PARAMETERS FOR \$DLSADDH

| Invalid parameters detected by `$DLSADDH` subroutine.

\$DB1 INCORRECT TYPE PASSED TO \$DILBERT

Call to `$DILBERT` services was made which passed an invalid `TYPE=`parameter.

\$DB2 INCORRECT TYPE PASSED TO \$DILBERT

\$HASP095

The processing routine specified on the \$DILBERT Macro returned a return code that is not supported. The reason code associated with \$DB2 is the bad return code.

\$DB3 \$DILBERT INLINE PARMLIST MISMATCH

The in-line parameter list passed to the \$DILBERT service is incompatible with the routine. The most likely cause is a failure to reassemble a module containing a \$DILBERT macro call.

\$DB4 UPDATE MODE JOA/JQA NEEDED FOR QSUSE=NO

The caller failed to pass an update mode JOA or JQA to the \$DILBERT service if QSUSE=NO was specified.

\$DD1 The \$GETABLE service routine was unable to locate a DCT table related to the DCT name specified in the \$DCTDYN macro call.

\$DD2 Indicates that a WSTAB address was found on a \$DCTTAB that was not eligible for job or SYSOUT selection.

\$DD3 A required name/token pair could not be located by the \$DCTDYN service.

\$DD4 \$DCTDYN was unable to build device name.

\$DJ1 EXIT CODE RETURNING NON-EXIT MODE JQA

The \$DOGJQE service has been called by a JES2 exit to perform a \$DOGJQE ACTION=RETURN. The JQA being returned was obtained by IBM code, not by exit code.

\$DJ2 EXIT CODE DID NOT RETURN EXIT MODE JQA

The \$DOGJQE service has been called by a JES2 exit to perform a \$DOGJQE ACTION=RETURN. The JQA being returned was obtained by exit code and not subsequently freed before returning to JES2.

\$DO1 EXIT CODE RETURNING NON-EXIT MODE JOA

User code attempted to free an IBM queue element.

\$DO2 EXIT CODE DID NOT RETURN EXIT MODE JOA

IBM code attempted to free a user queue element.

\$DP1 \$XECB is not valid or is being \$WAITed on by two PCEs.

\$DP2 Data was on a linkage stack when a \$WAIT macro was issued.

\$DP3 \$WAIT WAS ISSUED FROM INITIALIZATION PCE

A \$WAIT has been issued during JES2 initialization, before the initialization of the JES2 PCE dispatcher.

\$DP4 \$WAIT WAS ISSUED FROM JES2 SUBTASK

A \$WAIT has been issued from a JES2 subtask.

\$DP5 The JES2 dispatcher has found a PCE eyecatcher that is not valid.

| \$DP6 PCE guard bytes altered - \$WAIT.

| \$DP7 PCE guard bytes altered - DISP.

| \$DP8 \$SCANXWA/\$GENWORK guard altered

| \$DSC1 JOB NOT FOUND IN A CLASS QUEUE

| Expected job entry was not found during the deadline scheduling processing.

\$E01 The total number of channel end indications from IOS has exceeded the total number of input/output operations initiated by JES2. For example, the total number of outstanding input/output operations became negative.

\$EP1 The routine specified on a \$PCTAB resolved to an address of zero.

\$EP2 The routine specified on a \$PCTAB for a common PC cannot be found in the common storage.

\$EN1 JES2 or an installation exit routine either called a JES2 service routine or used a macro that called a service routine that issued the \$EN1 error code. This error code indicates that the service does not support running under the processor type (PCEID) of the caller.

- \$ER1** A JES2 processor is attempting to cancel or replace its current JES2 recovery environment, but there is no recovery environment associated with the current save area level. That is, the processor has not established a recovery environment since it obtained control, and therefore cannot cancel one.
- \$ER2** JES2 detected a non-valid track address in module HASPRAS during an I/O operation.
- \$ER5** When a JES2 processor recovery routine returned control, critical register contents or control block contents (or both) had been destroyed.
- \$ER9** There is a logic error in the JES2 processing associated with (but not included in) a JES2 processor recovery routine.
- | **\$F00 GETCELL SERVICES ERROR**
| HASPFSSM detected error requesting a storage cell from a pool.
- | **\$F01 FREECELL SERVICES ERROR**
| HASPFSSM detected error returning a storage cell to a pool.
- | **\$F02 GETCELL EXTENSION ERROR**
| HASPFSSM detected error when extending a storage cell pool.
- | **\$F03 QUICKCELL INITIALIZATION ERROR**
| HASPFSSM detected error when initializing cell pool service.
- | **\$F05 SJF REQUEST ERROR ON RELDS**
| HASPFSSM detected error calling SJF services.
- | **\$F06 GETBLK SERVICE ERROR**
| HASPFSSM detected error requesting a block of storage cells from a pool.
- | **\$F07 RETBLK SERVICE ERROR**
| HASPFSSM detected error returning a block of storage cells to a pool.
- | **\$F08 RPL HAS INCORRECT DATA**
| HASPFSSM detected error when reading records from a SYSOUT data set.
- \$G01** JES2 issued the GETMAIN macro instruction for storage for a TGB (track group buffer), but the required storage is not available in subpool 0.
- \$GF1 ATTEMPT TO FREE SUBPOOL 0**
An attempt was made to \$FREMAIN subpool 0. This is not allowed in the JES2 main task. This is probably an incorrect call to the \$FREMAIN service.
- \$GF2 UNEXPECTED LENGTH OF 0**
A \$FREMAIN request was issued with a length value passed as zero. If allowed to continue, this would result in a subpool FREEMAIN. If a subpool FREEMAIN is required, then do not code LV= on the \$FREMAIN call. Otherwise, correct the length specification for the \$FREMAIN call.
- | **\$GL01 INVALID JQE PASSED**
| Invalid parameters detected by \$ZGLSTRT subroutine.
- \$GS1** A subtask work queue error was detected.
- \$GT1 \$GETABLE - INVALID TABLE ENTRY**
The \$GETABLE service has located a table pair in which the JES2 table pointer points to a USER table, or the USER table pointer points to a HASP table, or a dynamic table pointer does not point to a dynamic table. The probable cause is either a mismatch of levels of the \$MCT macro, or a failure to use the \$PAIR macro to define a table pair.
- \$GW1** Either a JES2 processor requested a work area larger than the maximum size allowed, or a processor's total work area requests are larger than the total allowed.
- \$GW2** One of the following occurred:
RC=04 A JES2 processor has attempted to return a work area with an incorrect pool identifier.
RC=08 A JES2 processor has attempted to return a larger work area than it acquired.
RC=12 A JES2 processor has attempted to return a work area which has already been marked as free.

\$HASP095

- RC=16** \$RETNWORK has discovered that the cell control prefix for the cell being returned has been overlaid.
- \$GW3** A JES2 processor used part of a work area that it did not own. (For \$DEBUG=YES only.)
- \$GW4** A \$GETWORK request was issued unconditionally (without ERRET= on the macro), and the GETMAIN, required to satisfy the request, failed.
- \$I04** The \$GETABLE service routine was unable to locate a DCT table related to the DCT type specified in the INITRTE subroutine in HASPIRMA.
- \$I05** An internal logic error has occurred in one of the HASPIRDA routines. The reason code indicates the routine and type of error.
- RC=04** The main routine, IRDA, received a return code from KTRK1IO indicating IRDA passed bad parameters to KTRK1IO. This occurred while attempting to lock the checkpoint data set.
- RC=08** The main routine, IRDA, received a return code from KTRK1IO indicating IRDA passed incorrect parameters to KTRK1IO. This occurred while attempting to read the master record from the checkpoint data set.
- RC=12** The main routine, IRDA, received a return code from TRK1IO indicating IRDA passed incorrect parameters to KTRK1IO. This occurred while attempting to read the entire first track from the checkpoint data set.
- RC=16** The main routine, IRDA, received a return code from TRK1IO indicating IRDA passed incorrect parameters to KTRK1IO. This occurred while attempting to write the lock at the end of IRDA processing.
- RC=20** IRDA processing had a failure in PARM=UNACTIVATE processing. Unexpected return code from CKPTVSIZ.
- RC=24** IRDA processing cannot find the local KITs for either the NITC or RECY CTENTs.
- RC=28** 4K pages increased on HOT-START.
- \$I06** **ENF TYPE 40 SIGNAL ERROR REASON=(return code from the ENFREQ macro)**
The ENF 40 signal was not issued during JES2 initialization. Recover from this abend and allow JES2 to complete initialization.
Operator Action: Hot start JES2 if OMVS is needed.
- \$IP1** Input services incurred a GETMAIN failure.
- \$IP2** JES2 detected an error in the parameter list passed to the Security Authorization Facility to validate the job.
- \$IP3** JES2 read a job card from an input device. JES2 passed control to installation exit 2. After exit 2 returned, JES2 detected that the card was changed. JES2 scanned the card and could not recognize it as a job card. Exit 2 has probably overlaid the card.
- \$IR1** JES2 detected an error in the internal reader protected buffer. The pointer to the current job within the buffer does not point to a valid location. JES2 deletes the current job on the internal reader.
- \$IR2** JES2 detected a serialization error for an internal reader. JES2 deletes the current job on the internal reader.
- \$IV8** **QUEUE VERIFY ERROR FOLLOWING \$IVATE**
Reverification of job queue after \$ACTIVATE failed.
- \$IV82** **JQT KIT NOT FOUND FOLLOWING \$IVATE**
\$ACTIVATE LEVEL=R4 processing failed to find the JQT CTENT.
- \$J05** JES2 detected an error with either the chaining or the type of JQE or JOE by one of the job output service routines:
- RC=04** The work JOE does not point to a characteristics JOE.
- RC=08** JES2 cannot find the work JOE that was requested to be removed from a characteristics JOE chain (JOECHAINXT).
- RC=12** Either the subject JQE has no work JOEs or JES2 cannot find the work JOE requested to be removed from a JQE.

- RC=16** The use count of the characteristics JOE is zero, but it still points to a work JOE.
- RC=20** The work JOE points to an alleged characteristics JOE that is not a characteristics JOE.
- RC=24** The JQE pointed to by the JOE is a free JQE.
- \$J06** **##POST** was entered when not under control of **##QSUSE** macro.
- \$J07** The **##ADD** routine detected that a **##JOE** that was to be added to a **##JOT** had an erroneous **##SYSOUT** class. Valid **##SYSOUT** classes are (A-Z, 0-9).
- \$J08** JES2 detected an error in the output queues and the detecting routine was not able to correct the error.
- RC=04** The verification/correction routine(s) detected an error. JES2 issues the **##HASP498** message, which asks the operator if the **##JOT** queues should be totally rebuilt.
- RC=08** The rebuild routine detected an error. JES2 issues the **##HASP499** message, indicating both the correction and rebuild routines have failed.
- \$J09** **JOE ON INCORRECT QUEUE**
- A JOE does not have the correct **##JOETYPE**. Possible causes are:
- Something other than a work JOE is passed to one of the job output service routines.
 - A free JOE queue points to a JOE that isn't marked 'free'.
- RC=0** A work JOE is expected and the JOE is not a work JOE
- RC=4** JES2 just removed a JOE that is not a free JOE from the free JOE chain.
- \$J10** **INCORRECT JOE ADDRESS**
- The JOE address passed to one of the job output service routines was not a valid JOE address.
- RC=04** The JOE address is not within the valid range of JOE addresses.
- RC=08** The JOE address is not on a control block boundary.
- \$J11** **ATTEMPT TO BUSY A JOE DURING WARM START**
- During warm-start processing, JES2 attempted to set on the busy system indicator for a JOE. Changing the system busy indicator for a JOE cannot occur during a warm-start because it would conflict with the recovery processing of busy JOEs.
- \$J12** **QUEUES NOT OWNED ENTERING ##JWEL**
- The caller of **##JWEL** failed to ensure the checkpoint queues were owned, that is, it failed to do a **##QSUSE** prior invoking the **##JWEL** macro.
- \$J14** **JOE CHANGED WHILE JOA ACTIVE**
- JES2 detected an update to a real JOE while an artificial JOE (JOA) was locked by the **##DOGJOE** macro. JOE cannot be updated without **##DOGJOE** serialization.
- \$J16** **##DOGJOE FETCH,UPDATE AND QUEUES NOT OWNED**
- The **##DOGJOE** macro was called to support **ACTION=(FETCH,UPDATE)** or **ACTION=REFRESH** and the JES2 queues were not owned.
- \$J17** **EXIT CODE RETURNING NON-EXIT MODE JOA**
- The **##DOGJOE** macro was called by a JES2 exit to perform a **##DOGJOE ACTION=RETURN** service. The returned JOA was obtained by IBM code, not exit code.
- \$J18** **EXIT CODE DID NOT RETURN EXIT MODE JOA**
- The **##DOGJOE** macro was called by a JES2 exit to perform a **##DOGJOE ACTION=RETURN** service. The returned JOA was obtained by exit code and not freed before returning to JES2.
- \$J19** **##DOGJOE FETCHNEXT NOT VALID IF STACK**
- The **##DOGJOE** macro was called to perform a **##FETCHNEXT** service by using a JOA, which has a stack of users, as input.
- \$J20** **##DOGJOE IMPROPER JOA EMPTY STATUS**

\$HASP095

The \$DOGJOE service was called to support ACTION=FETCH and was given an empty JOA.

\$J21 REQUIRED JOA ADDR NOT PASSED TO \$DOGJOE

The \$DOGJOE service was called to support an ACTION other than FETCH, FETCHNEXT, REFRESH or QUERYLOCK and no other JOA is provided.

\$J22 \$DOGJOE CALLER USED OBSOLETE MACRO FORM

The \$DOGJOE service was called by a routine that was not reassembled using the latest version of the \$DOGJOE macro.

\$J23 NON WORK JOE PASSED TO \$DOGJOE AS JOE=

The caller failed to provide a Work JOE on the \$DOGJOE invocation.

\$J24 JOE REQUESTED BY \$DOGJOE DOES NOT EXIST

JES2 could not find the real JOE that was associated with the \$DOGJOE invocation.

\$J26 INCORRECT OFFSET OR LENGTH FOR \$DOGJOE

The caller passed an incorrect offset or length to the \$DOGJOE service.

\$J27 \$#REP CALLER DID NOT PASS REAL JOA AS REQUIRED

The caller failed to pass a real JOA to the \$#REP service.

\$J28 GTPDVER - UNEXPECTED WAIT FOR BERT LOCK

An attempt to obtain an update mode JOA in routine GTPDVER encountered an unexpected wait for the BERT lock.

\$J29 \$#ALCHK - CALLED WITHOUT UPDATE JOA

The caller failed to pass an update mode JOA to the \$#ALCHK service.

\$J30 \$#BUSY - CALLED WITHOUT UPDATE JOA

The caller failed to pass an update mode JOA to the \$#BUSY service.

\$J31 GTDEVID - UNEXPECTED WAIT FOR BERT LOCK

An attempt to obtain an update mode JOA in routine GTDEVID encountered an unexpected wait for the BERT lock.

\$J32 SAIFETCH - UNEXPECTED WAIT FOR BERT LOCK

An attempt to obtain an update mode JOA in routine SAIFETCH encountered an unexpected wait for the BERT lock.

| **\$JD1** Input object is not a ZOD.

| **\$JD2** Incorrect Operation type.

| **\$JD3** ZJC free chain error. Free chain does not match free count.

| **\$JD4** Checkpoint queues not owned.

| **\$JD5** Checkpointed ZOD not validated.

| **\$JD6** Invalid operator code.

| **\$JD7** Unaccounted character code.

\$JX01 INVALID \$DOGJAX REQUEST

\$DOGJAX service was called with an undefined action code.

\$JX02 \$DOGJAX WITHOUT OWNING QUEUES

\$DOGJAX caller did not own the queues at the time of the call.

\$JX03 JAXCKPT OBJECT NOT DEFINED

\$DOGJAX service was called, but checkpointed JAX object was not defined in the BERT tables.

- \$K01** Alteration of checkpoint record contents when not under control of \$QSUSE macro. (For DEBUG=YES only)
- \$K02** The coupling facility lock was stolen unexpectedly by another member of the MAS.
- \$K03** One of the following is true:
1. Two members are using the same member name.
 2. There is a time stamp synchronization problem in a multi-access spool configuration. This is typically caused by an incorrect operator reply to message \$HASP420 or some other operator error.

This error (\$K03) requires that you re-IPL the system.

- \$K04** An attempt was made to recover from a permanent I/O error on a checkpoint data set. Although the recovery was successful, an error occurred on the “companion” checkpoint data set during a checkpoint reconfiguration. (CKPT2 is the companion for CKPT1 and vice versa.) In an attempt to recover from the I/O error on the companion data set, JES2 initiated a subsequent checkpoint reconfiguration, and the operator replied TERM to \$HASP272.
- \$K05** A checkpoint record has been changed, but not flagged for checkpoint. (For DEBUG=YES only.)
- \$K06** The operator issued the \$T CKPTDEF,RECONFIG=Yes command (the blank between \$T and CKPTDEF is optional) to enter a checkpoint reconfiguration dialog with JES2. This dialog is not possible because there are no checkpoint data sets presently in use.
- \$K08** An abend has occurred during a checkpoint reconfiguration. This error requires that you re-IPL the system.
- \$K10** A permanent read error has occurred on a checkpoint data set. The reason code (RC=) indicates the reason for the error.
- RC=04** An I/O error occurred while attempting to acquire a RESERVE (using the MVS RESERVE macro) for the checkpoint data set.
- RC=08** The check value in the HASP communications table (HCT) does not agree with the check value in the CHECK record.
- RC=12** An I/O error occurred while reading the 4K pages of the checkpoint data set.
- RC=16** An I/O error occurred while reading the first track of the checkpoint data set.
- RC=20** An I/O error occurred while attempting to acquire the checkpoint lock.
- \$K13** The checkpoint lock, which has been read, contains erroneous information. The reason code (RC=) indicates the reason for the error.
- RC=04** The checkpoint lock, which has been read, has a mismatching key.
- RC=8** The checkpoint lock, which has been read, has an invalid member area.
- RC=12** The checkpoint lock, which has been read, has an incorrect level value.
- \$K15** An attempt to format the checkpoint data set was unsuccessful. If this error occurs after initialization, you must re-IPL the system.
- \$K17** A checkpoint read channel program was interrupted. Retries were also interrupted.
- \$K18** A checkpoint write channel program was interrupted.
- This I/O error occurred on the only checkpoint data set allocated by this member. There will be a backup copy of the checkpoint data set only if one of the following is true:
- The JES2 configuration is running in DUPLEX mode and another member has specified DUPLEX=ON. The DUPLEX data set can then be used as the backup copy.
 - Before ABENDING, this member created an emergency backup copy of the checkpoint in the data set named SYS1.EMERGENCY.HASPCKPT.
- \$K19** The same error occurred as indicated by \$K18 except that both CKPTn data sets were allocated to this member during the error.

Although the CKPTn data set without the error may contain a valid copy of the checkpoint, it is recommended that you restart JES2 with the SYS1.EMERGENCY.HASPCKPT data set, providing that it was previously specified (in response to a \$HASP279 message).

\$HASP095

- \$K20** JES2 detected an incorrect change log address list entry while updating the checkpoint records from the change log.
- \$K21** JES2 detected an incorrect change log address list entry while building the change log.
- \$K22** An internal logic error has occurred in one of the checkpoint related routines. The reason code indicates the routine and type of error.
- RC=04** The routine CKPTALOC was unable to locate the UCB for a checkpoint data set even though an OBTAIN indicates the volume is mounted. Because a recovery routine exists for this error, recovery will be attempted.
- RC=08** The routine KTRK1IO detected that an incorrect parameter list was passed to it when called from KREAD1.
- RC=12** The routine KTRK1IO, called from KREAD1, detected that I/O was already active for a checkpoint data set before attempting a lock read operation.
- \$K23** JES2 detected that either one or both of the active checkpoint data sets being used by this member of the multi-access spool (MAS) configuration was forwarded (possibly because of error recovery on another member). Because this member detected the forwarded data set(s) during normal processing, it could not perform the necessary recovery action. When you restart JES2, initialization processing will detect a change in the checkpoint data set configuration.
- \$K24** Internal error: JES2 has detected that the checkpoint data set configuration has been altered by another member of the multi-access spool (MAS) configuration (possibly because of error recovery action on another member). Because this member detected the change during normal processing, it could not perform the necessary recovery action. When you restart JES2, initialization processing will detect a change in the checkpoint data set configuration.
- \$K25** **FCT REQUESTED ABEND BIT SET**
- Internal error: JES common coupling services installation exits IXZXIT01 or IXZXIT02 set the bit to request an abend during JESXCF inter-member communications. This bit is available for testing and diagnostic purposes.
- \$K26** **INCOMPATIBLE LEVELS OF CODE DETECTED**
- Internal error: a JES2 checkpoint reconfiguration was attempted between JES2 members at incompatible service levels for the \$CKX data area. Return codes are:
- | RC= | Meaning |
|-----|---|
| 1 | Receiver's \$CKX data area version is too far down level to be compatible with the sender's \$CKX data area version |
| 2 | Receiver's \$CKX data area version is too far up level to be compatible with the sender's \$CKX data area version |
- System Programmer's Response:** Ensure that every MAS member has a compatible \$CKX data area service level.
- \$K27** **CKPT RECONFIGURATION ALREADY STARTED**
- Internal error: a checkpoint reconfiguration is already started on another MAS member and has progressed too far for this member to participate. A reason code is set from the second byte of field PCEID in the \$PCE data area.
- \$K28** **INTERNAL ERROR DETECTED BY HASPCKRR**
- Internal error: either incorrect data was passed to the checkpoint reconfiguration routine or the inter-member communication routine was called out of sequence. Return codes are:
- | RC= | Meaning |
|-----|---|
| 1 | A \$CKM data area was not passed to the inter-member communication routine |
| 2 | Sequence error: there was a second checkpoint reconfiguration start inter-member communication call (CKRRSTRT) without an intervening checkpoint reconfiguration end (CKRRDONE) |

- 3 Sequence error: a checkpoint reconfiguration synchronization call (CKRRSYNC) occurred before starting inter-member communications (CKRRSTRT)
- 4 Sequence error: a checkpoint reconfiguration synchronization call (CKRRSYNC) occurred after inter-member communications (CKRRSTRT) indicated JES2 canceled the reconfiguration
- 5 Sequence error: a checkpoint reconfiguration end (CKRRDONE) was called before starting inter-member communications (CKRRSTRT)
- 6 Inter-member communications (CKRRSTRT) was called on this member with more than one reason for the reconfiguration
- 7 A checkpoint reconfiguration synchronization call (CKRRSYNC) occurred on this non-driving member with a type different from that of the synchronization call made to the driving member
- 8 A checkpoint reconfiguration synchronization call (CKRRSYNC) occurred on this non-driving member but the corresponding call made to the driving member was a checkpoint reconfiguration end (CKRRDONE)
- 9 A checkpoint reconfiguration end (CKRRDONE) call was made to this non-driving member but the corresponding call made to the driving member was a checkpoint reconfiguration synchronization call (CKRRSYNC)
- A A storage overlay was detected in the \$CKM data area

\$K29 INTERNAL ERROR DETECTED BY HASPCKRR

Internal error: an error was detected by JES2 checkpoint reconfiguration routines that manage JESXCF communications. Likely, JESXCF is the component in error. \$K29 is issued for errors detected in data returned from the JES common coupling services (JESXCF) as follows:

\$K29 reason codes (displayed in hexadecimal) have the following format:

RC=ffssttxx

where:

- ff** function footprint from the CKMIFUNC byte of the \$CKM data area
- ss** status bits from the CKMIFLG2 byte of the \$CKM data area
- tt** error type code from the CKMIXERT byte of the \$CKM data area (Type codes numbers may be the same but their meanings are different than those for \$K30 errors.)
- xx** call code of the last call made to JES XCF (IXZXIXcc) indicated by the xx value in the CKMILSTX byte of the \$CKM data area as follows:
 - 00 no IXZXIXcc service was called within the scope of the currently executing JES2 inter-member communication routine.
 - 01 IXZXIXAC – acknowledge message
 - 02 IXZXIXIF – obtain member information
 - 03 IXZXIXMB – build mailbox
 - 04 IXZXIXMC – clear mailbox
 - 05 IXZXIXMD – delete mailbox
 - 06 IXZXIXRM – receive message
 - 07 IXZXIXSM – send message
 - 08 call to XCFUSTAT routine to update this member's XCF user state

\$K30 INTERNAL ERROR DETECTED BY HASPCKRR

Internal error: an error was detected by JES2 checkpoint reconfiguration routines that manage JESXCF communications. \$K30 is issued for errors detected in data contained in the \$CKM data area or messages transported by the JES common coupling services (JESXCF) as follows:

\$K30 reason codes (displayed in hexadecimal) have the following format:

\$HASP095

RC=ffssttxx

where:

- ff** function footprint from the CKMIFUNC byte of the \$CKM data area
- ss** status bits from the CKMIFLG2 byte of the \$CKM data area
- tt** error type code from the CKMIXERT byte of the \$CKM data area (Type codes numbers may be the same but their meanings are different than those for \$K29 errors.)
- xx** the call code of the last call made to JES XCF (IXZXIXcc) indicated by the xx value in the CKMILSTX byte of the \$CKM data area as follows:
 - 00** no IXZXIXcc service was called within the scope of the currently executing JES2 inter-member communication routine.
 - 01** IXZXIXAC – acknowledge message
 - 02** IXZXIXIF – obtain member information
 - 03** IXZXIXMB – build mailbox
 - 04** IXZXIXMC – clear mailbox
 - 05** IXZXIXMD – delete mailbox
 - 06** IXZXIXRM – receive message
 - 07** IXZXIXSM – send message
 - 08** call to XCFUSTAT routine to update this member's XCF user state

\$K31 INTERNAL ERROR DETECTED BY HASPCKDS

Internal error: this non-driving member was directed by the driving member to perform a reconfiguration action that this member considers unavailable.

\$K32 INTERNAL ERROR DETECTED BY HASPCKDS

Internal error: this non-driving member received \$HFAME data areas from the driving member and detected they were inconsistent with its own \$HFAMES. That is, those CKPTn= specifications that include INUSE=YES on the CKPTDEF initialization statement must be the same on both members.

\$K33 INTERNAL ERROR DETECTED BY HASPCKDS

Internal error: KDLRSERV routine returned with an unexpected return code.

\$K34 UNEXPECTED RETURN CODE FROM JESXCF

Internal error: an interface error with JES common coupling services. An unexpected return code was returned from a IXZXIXcc service. See the \$HASP088 message for the reason and return codes in R0 and R15, respectively, for call codes 01 through 07, and see message \$HASP777 for call code 08. (Call code 08 has a return code in R15 only.)

\$K34 reason codes (displayed in hexadecimal) have the following format:

RC=ffss01xx

where:

- ff** function footprint from the CKMIFUNC byte of the \$CKM data area
- ss** status bits from the CKMIFLG2 byte of the \$CKM data area
- 01** error type code from the CKMIXERT byte of the \$CKM data area (always 01 for \$K34 errors.)
- xx** the call code of the last call made to JES XCF (IXZXIXcc) indicated by the xx value in the CKMILSTX byte of the \$CKM data area as follows:
 - 01** IXZXIXAC – acknowledge message
 - 02** IXZXIXIF – obtain member information
 - 03** IXZXIXMB – build mailbox

- 04 IXZXIXMC – clear mailbox
- 05 IXZXIXMD – delete mailbox
- 06 IXZXIXRM – receive message
- 07 IXZXIXSM – send message
- 08 call to XCFUSTAT routine to update this member's XCF user state

Refer to a previously issued \$HASP777 message for the reason and return codes for an XCF user state update failure.

- \$L02** A command exceeded the length of the work area where it was being built.
- \$MD1** The WSTAB entry for "spool offload modify" requests information from the UCT (MODSCB=UCT), but no UCT address was found in the HCT field \$UCT.
- \$MD2** The \$WSTAB entry for "spool offload modify" specifies an MODCB address that cannot be located .
- \$MD3** The \$WSTAB entry for "spool offload modify" specifies a name/token pair that cannot be located.
- \$M01** JES2 has detected more channel end indications for a bisynchronous (BSC) line than expected. Only one channel end indication should be received from input/output supervisor (IOS) for each I/O operation initiated by JES2.
- \$M02** An attempt has been made to initiate an I/O operation on a BSC line before the previous operation has completed.
- \$M03** An internal logic error has been detected by the Remote Telecommunications Access Method (RTAM) during processing for a systems network architecture (SNA) or BSC remote work station.
- \$M04** An SNA logical line has been erroneously removed from the SNA line queue after having been reserved for an SNA application-to-application session.
- \$M05** **BUFSIZE TOO SMALL**
The size of the buffer associated with the remote punch is too small to hold the buffer being sent to the device. Increase the buffer size being used for this remote.
- \$M06** **SNA/NJE INTERNAL LOGIC ERROR**
Buffer DCT is different from a line DCT.
- \$M10** The network path manager has determined that the nodes attached table (NAT) is incorrect.
- \$MG0** Migrator DTE not found. There is a spool volume that is actively migrating, but a corresponding spool migrator subtask was not found. The reason code indicates the processing that failed.
- \$MG1** Migration assistant DTE not found. There is a spool volume that is actively migrating, but a spool migration assistant subtask was not found. The reason code indicates the processing that failed.
- \$MG2** Cannot locate source DAS for migration. Spool processing is using a migration object located in BERTs, but cannot locate the actual source DAS that corresponds to it. The reason code indicates the processing that failed.
- \$MG3** Cannot locate target DAS for migration. There is a spool volume that is actively migrating, but the DAS representing the target of the migration cannot be located.
- \$MG4** Source not in proper phase during Move. Spool move migration processing is working with a migration object, but the associated Source DAS does not indicate it is in the proper phase.
- \$MG5** Cannot locate target DAS for migration. There is a spool volume that is actively migrating, but the migration object representing the target of the migration cannot be located.
- \$MG6** MIGFINAL passed incorrect DAS. The DAS passed to MIGFINAL for migration completion is not valid.
- \$MG7** Track group allocation during migration. An attempt was made to allocate spool space on the source volume in a spool migration.
- \$MG8** Incorrect TGM type during migration. The \$TGMMIG service detected that the wrong track group map was passed to it.

\$HASP095

\$MSER1

\$SCAN ERROR DETECTED

Unrecoverable error detected by the \$BLDMSG service when processing WTOR-type message.

- \$N01** JES2 detected an error while computing the full networking path. The reason code is the return code from the \$SUBIT macro.
- \$N02** Either JES2 received an unexpected return code processing a \$NATGET or an error was found in the nodes attached table (NAT). The reason code is the \$NATGET return code.
- \$N03** Either JES2 received a nonzero return code processing a \$NATMOD, or an error was found in the nodes attached table (NAT). The reason code is the \$NATMOD return code.
- \$N04** JES2 received an unexpected return code processing a \$NATNOT request. The reason code is the \$NATNOT return code.
- \$N05** Either JES2 received an unexpected return code processing a \$NATADD or an error was found in the nodes attached table (NAT). The reason code is the \$NATADD return code.
- \$N06** Either JES2 received an unexpected return code processing a \$NATREM or an error was found in the nodes attached table (NAT). The reason code is the \$NATREM return code.
- \$N07** A service that processes the nodes attached table (NAT) returned an input not valid error, which JES2 cannot resolve.
- \$N08** A buffer queued to the Network Path Manager (NPM) was found to be in error.
- Possible errors are:
- Address queued does not point to a buffer.
 - Buffer is currently in the pool of free buffers.
- The following reason codes describe the source of the buffer in error:
- RC=04** Buffer queued between members of a MAS.
- RC=08** Buffer queued by BSC processing.
- RC=12** Buffer queued by SNA processing.
- \$N11** Network Path Manager (NPM) encountered an error from an XCF service.
- \$PD1** A call was made to \$PCEDYN for a DCT chain, and a DCT in that chain is incorrect (for example, its DCT table cannot be found, or it should not have a PCE related to it).
- \$PD2** A call was made to \$PCEDYN, passing a PCE or a DCT, and the corresponding PCE table entry or DCT table entry could not be found.
- \$PD3** A call was made to \$PCEDYN, passing a DCT, and the DCT table entry corresponding to that DCT does not have a matching PCE table entry.
- \$PD4** A call was made to \$PCEDYN and there was an error in the connection between the PCE and a DCT (for example, the PCE and DCT are required to match one-to-one and do not).
- \$PD5** A call was made to \$PCEDYN to detach a PCE and (1) the PCE length is incorrect, or (2) the PCE indicates the processor has resources outstanding (for example, save areas, buffers, or job queue elements).
- \$PD6** A call was made to \$PCEDYN that resulted in references to PCE table entries (in the installation PCE table) that indicated required fields are in the UCT. The installation has not allocated a UCT.
- \$PD7** A call was made to \$PCEDYN to attach a PCE after initialization or to detach a PCE, and the corresponding PCE table entry indicates PCEs of that type cannot be dynamically attached or detached.
- \$PD8** The entry point address of a necessary module is set to zeros. This field is zero if the VCON created by the MODULE= parameter on the \$PCETAB macro could not be resolved at link edit time.
- \$PD9** The \$PCEDYN service has not found a required name/token pair.
- \$PD10** The \$PCEDYN service has found the address of a required COUNT= parameter that is not valid.
- \$PD11** The \$PCEDYN service has found the address of a required CHAN= field that is not valid.

- \$PD12** The required name/token pair that attached a PCE associated with the DCT has not been found.
- \$PG1** An address of zero was passed to the \$PGSERV service routine.
- \$PJ2** The \$PJES2,ABEND command was issued.
- \$PJF** The \$PJES2,ABEND,FORCE command was issued.
- \$PP0** **PQE COUNT IS GREATER THAN PQE LIMIT**
A print processor detected an incorrect PQE count.
- \$PP1** **PQE CHAINING ERROR**
A print processor detected an incorrectly chained PQE. The reason code describes how the PQE is incorrectly chained:
- RC=04** The PQE address is the PQE header address.
- RC=08** The PQE is on the free queue.
- RC=12** The PQE forward pointer loops to the same PQE.
- RC=16** The PQE backward pointer loops to the same PQE.
- RC=20** The PQE backward pointer is incorrect.
- RC=24** The PQE forward pointer is incorrect.
- RC=28** The PQEJ forward pointer loops to the same PQE for a job start PQE (PQEJ).
- \$PP2** **PQE IS NOT ON THE FREE QUEUE**
A print processor detected an active PQE on the PQE free queue.
- \$PP3** **PQE IS IN ERROR**
A print processor detected an error with an active PQE. The problem is one of the following:
- The data set PQE is not a valid PQED.
 - The job start PQE is not a valid PQEJ.
 - The PQE is pointing to itself.
- \$PP4** **EXCP FOR IOB ALREADY IN PROGRESS**
JES2 Print/Punch processing is about to initiate I/O to a printer/punch and has unexpectedly discovered that I/O is already in progress.
- \$PS0** **NO PCE FOR ACTIVE PSO**
An active PSO was detected but a search of PSO PCEs found none processing the PSO.
- \$PS1** **JQELock NOT HELD AT TREGROUP**
TREGROUP service routine was called without holding job lock.
- \$PS2** **JQELock NOT HELD AT PSOFRELK**
PSOFRELK service routine was called without holding the job lock.
- \$PS3** **PSOPDDB IS NOT LARGE ENOUGH**
PSO tried to process a PDDB that is longer than the PDDB area provided in the PSO structure.
- \$PS4** **PDDB SIZE WAS CHANGED**
The size of the updated PDDB returned to JES2 from the PSO caller has changed, so the PDDB cannot be updated in place.
- \$PT1** **\$PUTABLE INVALID TABLE ENTRY**
The \$PUTABLE service has located a table pair which a dynamic table pointer does not point to a dynamic table. The probable cause is either a mismatch of levels of the \$MCT macro, or a failure to use the \$PAIR macro to define a table pair.

\$HASP095

- \$Q01** A JES2 processor requested a job queue service routine function with incorrect arguments or failed to ensure that the job queue checkpoint processor was not active for a \$QMOD service function.
- \$Q02** A JES2 processor requested a job queue service but failed to find the queue for the type specified in the job's JQE. To ensure a clean recovery, this error requires that you perform an all-member warm start of JES2.
- \$Q03** **REQUIRED \$QSUSE CONTROL NOT OBTAINED**
- A service was called that requires the caller to own the checkpoint queues, but the caller does not own them. The caller must issue a \$QSUSE macro to obtain ownership before calling the service, or before attempting to modify a checkpointed control block.
- \$Q04** JES2 has detected an incorrect checkpoint queue element address. The reason code indicates the exact error.
- RC=04** The element address passed to the \$CKPT service routine is lower than the valid range of addresses for the element type.
- RC=08** The element address passed to the \$CKPT service routine is higher than the valid range of addresses for the element type.
- RC=12** The element address passed to the \$CKPT service routine does not point to the start of the control block being \$CKPTed.
- \$Q05** **INCORRECT JOB QUEUE CHANGE REQUEST**
- A JES2 processor requested a job queue service with the \$QMOD macro to change the processing phase of a job when the change was not allowed.
- \$Q06** **JQE ON INCORRECT QUEUE**
- The JQE obtained from the free queue had a type indication other than free or while running a JQE queue, a JQE with an incorrect queue type was encountered. This is a JES2 internal logic error.
- \$Q07** **INCORRECT JQE ADDRESS**
- The JQE address passed to one of the job service routines was not a valid JQE or JQA address.
- \$Q08** **ATTEMPT TO QUEUE JOB TO NON-EXISTENT QUEUE**
- A \$QADD, \$QMOD, or \$QPUT service requested a job queue type that is not valid.
- \$Q09** The caller of the \$GETLOKW service did not establish access to the checkpoint queues using the \$QSUSE macro.
- \$Q10** The \$GETLOKW or \$FRELOKW service was called from an unexpected PCE.
- \$Q11** **JQE/JIX MISMATCH**
- A job has a job number that the JIX indicates is either unassigned or assigned to another job.
- \$Q12** **REQUEST TO MANIPULATE FREE JQE**
- The caller passed a 'free' JQE to a service routine.
- \$Q13** **ATTEMPT TO BUSY A JQE DURING WARM START**
- During warm-start processing, JES2 attempted to set on the busy system indicator for a JQE. Changing the system busy indicator for a JQE cannot occur during a warm-start because it would conflict with the recovery processing of busy JQEs.
- \$Q14** **JQE CHANGED WHILE JQA ACTIVE**
- JES2 detected an update to a real JQE while an artificial JQE was locked using \$DOGJQE. Updates to JQE without \$DOGJQE serialization is not allowed.
- \$Q15** **JQE NOT ARTIFICIAL**
- A job was being added to a WLM service class queue, however, a real JQE was passed to the queue service but an artificial JQE was required.
- \$Q16** **\$DOGJQE FETCH,UPDATE AND QUEUES NOT OWNED**
- The \$DOGJQE service has been called to support ACTION=(FETCH,UPDATE) or ACTION=REFRESH and the JES2 queues are not owned.

- \$Q17 DJACCESS INCORRECT CALLING SEQUENCE**
The \$DOJQE service has been called to support ACTION=FETCHNEXT, ACTION=REFRESH, ACTION=SETACCESS or ACTION=MANAGELOCK. The caller has failed to provide a valid JQA address.
- \$Q18 INCORRECT ACTION AGAINST UNLOCKED JQA**
The \$DOJQE service has been called to perform an action other than FREE or MANAGELOCK,ACQUIRE for a JQA which previously had been set in a lock freed state by a MANAGELOCK,RELEASE call.
- \$Q19 \$DOJQE FETCHNEXT NOT VALID IF STACK**
The \$DOJQE service has been called to perform a FETCHNEXT using a JQA as input which has a stack of users.
- \$Q20 \$DOJQE IMPROPER JQA EMPTY STATUS**
The \$DOJQE service has been called to support ACTION=FETCH and was given a JQA which is empty.
- \$Q21 REQUIRED JQA ADDR NOT PASSED TO \$DOJQE**
The \$DOJQE service has been called to support an ACTION other than FETCH, FETCHNEXT, REFRESH or QUERYLOCK and there was no other JQA provided.
- \$Q22 \$DOJQE CALLER USED OLD MACRO FORM**
The \$DOJQE service has been called by a routine which has not been reassembled using the latest version of the \$DOJQE macro.
- \$Q23 CAT AND JOB CLASS DIFFER ON \$QBUSY**
The CAT that the \$QBUSY service found (or the CAT passed into the service) does not match the execution class in the JQE. Either the wrong CAT was passed into the service or the current JQETYPE does not reflect the same job class as the JQXJCLAS field.
- \$Q24 ATTEMPT TO BUSY JOB THAT IS ALREADY ACTIVE**
The \$QBUSY service was called to busy a JQE that was already marked as busy.
- \$Q25 ATTEMPT TO SET DCTDEVID WITH NO DCT**
The \$QBUSY service was called to busy a JQE and set the active device identifier (JQEDEVID). However there is no DCT associated with the current PCE.
- \$Q26 INCORRECT OFFSET OR LENGTH FOR \$DOJQE**
\$DOJQE ACTION=CKPTFLD not valid parameters.
- \$Q30 CHECKPOINT INFO FOR JIX CTENT OVERLAID**
JES2 detected an overlay of the JIX CTENT.
- \$QG1 EXIT 49 ISSUED \$WAIT**
Exit 49 rejected the JQE that was passed to it and also issued \$WAIT. Exit 49 can only \$WAIT if it does not reject the JQE.
- \$QG2 \$EXIT 14 DID NOT RETURN UPDATABLE JQA**
Exit 14 gave a return code of 8 but failed to provide an update-mode JQA.
- \$QG3 \$EXIT 14 DUPLICATE JOB LOOP**
Exit 14 returned a job which had been returned in the prior call to exit 14 in the same QGET call. The job has been rejected again because it is a duplicate jobname.
- \$R01 JES2 detected that \$SCQJQE does not contain a valid offset for shared communication queue JQE.**
- \$RD1 NJE job header create table is full.**
- \$RD2 NJE job header or trailer corrupted.**
- \$REP The required recovery routine specified on a \$PCTAB cannot be found.**
- \$RT1 \$RETABLE INVALID TABLE ENTRY**

\$HASP095

The \$RETABLE service has located a table pair in which a dynamic table pointer does not point to a dynamic table. The probable cause is either a mismatch of levels of the \$MCT macro, or a failure to use the \$PAIR macro to define a table pair.

- \$S01 A GETMAIN for a permanent JES2 save area pool has failed.
- \$S02 The JES2 \$RETSAVE service routine has detected that the save area being returned is not on the calling processor's save area chain.
- \$S03 JES2 detected an incorrect spin \$IOT address while processing the first-in first-out (FIFO) spin \$IOT queue.
- \$SA1 The JOE or JQE currently found in the \$SAPID for this thread is not consistent with a previous SAP1 request made by this thread.
- \$SG1 While processing a request to get an SMF buffer, the SMF free count was about to go negative.
- \$SG2 While processing a request to get an SMF buffer, \$CPOOL services failed to return a cell. If recovery is attempted from this error, SMF processing will be turned off.
- \$SM1 JES2 detected a non-valid track address in module HASPSPOL during an I/O operation.
- \$SW1 JES2 detected an error while processing a scheduler JCL facility request.
- \$TK1 An incorrect checkpoint token was passed to the \$CHECK service routine. Because a recovery routine exists for this error, recovery will be attempted.
- \$TR1 The exclusive ENQ for the trace table, issued by the \$TRACE log processor, failed. The reason code is the return code from the ENQ macro.
- \$TR2 The trace log processor incurred a GETMAIN failure.
- \$U01 An installation exit routine issued a return code that is higher than the maximum return code value specified in the \$MAXRC parameter of the \$EXIT macro instruction.
- \$U03 A GETMAIN for the UCB parameter list failed.
- | \$U04 JES2 detected a PCE eyecatcher overlay.
- | \$U05 JES2 detected PCE guard bytes overlaid.
- \$V01 The executing job is using unavailable spool space during a hot start of JES2.
- \$WL1 **UNABLE TO DETERMINE WLM SERVICE ID** While processing the policy activation, JES2 received an unexpected return code from IWMPQRY. See message \$HASP712 to determine what return code was passed.
- \$WL2 **UNRECOVERABLE CLASSIFICATION ERROR** While classifying a job, JES2 received an unexpected error return code from IWMCLSFY. See messages \$HASP712 to determine what return code was passed.
- \$WS1 The remote printer or punch device control table (DCT) you want cannot be found. The request is ended.
- \$WS2 The work selection service routine (WSSERV) did not receive the address of a required control block from the calling routine.
 - RC=04 The JOE address was not found.
 - RC=08 The JQE address was not found.
 - RC=12 The JCT address was not found.
 - RC=16 The data set header address was not found.
 - RC=20 The UCT address was not found.
 - RC=24 The DCT address was not found.
- \$WS3 No work selection (WS) tables were defined for a device.
- \$WS4 There was no slash found in either the installation work selection table or the HASP work selection table. A slash must be found in one of these tables for the selection criteria to be valid.
- | \$WTE \$WAIT issued when prohibited
- \$X01 The spool offload channel-end routine (module HASPSTAM) found that I/O operations were not completing in order.

- \$X02 The spool offload channel-end routine (module HASPSTAM) found that the number of I/O completions exceeded the number of I/O operations issued.
- \$X03 GETMAIN failed to obtain the storage required for job control blocks during conversion processing.
- \$X04 **UNRECOVERABLE CLASSIFICATION ERROR SJB NO LONGER QUEUED TO CHAIN**An attempt has been made to dequeue an SJB that has already been dequeued.
- \$X05 The running processor incurred a GETMAIN failure.
- \$X06 Unable to obtain the SVJLOK resource. The return code from ENQ is in register 2.
- \$XC1 A JES2 XCF error has occurred. A previously displayed message(s) (\$HASP777 and \$HASP779) provides the reason for the JESXCF error.
- \$XC2 A JES XCF service returned an unexpected return code. The reason code associated with this error code is the return code from the JES XCF service. See *z/OS MVS Programming: JES Common Coupling Services* for an explanation of the return code and the associated programmer action.
- \$XF1 JES2 detected an error or unexpected return code from JESXCF.
- \$ZP1 **ZAP JOB QUEUE ERROR**
ZAPJOB processing has induced a job queue error. JES2 terminates. When restarting JES2, use the initialization form ZAPJOB to remove the offending job.
- \$Z03 An unrecoverable subtask abend has occurred.
- 0Cx The JES2 abnormal exit routine has been entered, indicating that the JES2 system has been abnormally ended. X'0Cx' is the system completion code, where x = 1 through F. See the description of codes in *z/OS MVS System Codes*.

System action: If a JES2 recovery routine exists for this error, and the JES2 error rate has *not* reached or exceeded the value specified in the RECVOPTS initialization statement, JES2 issues an indicative dump (message \$HASP088) to the hard-copy log, and then invokes the recovery routine.

If a JES2 recovery routine exists for this error, and the JES2 error rate *has* reached or exceeded the value specified in the RECVOPTS initialization statement, JES2 issues message \$HASP070 and waits for the operator to reply.

If there is no JES2 recovery routine for this error, JES2 issues an indicative dump (message \$HASP088) and message \$HASP098 to the master console.

Even if a recovery routine exists, the following catastrophic errors cause JES2 to end: BR3, CF1, CF2, DP3, DP4, ER1, ER5, ER9, GS1, J09, J10, K04, K08, K20, K21, K22, K23, K24, PJF, PJ2, Q02, Q06, Q07, Q11, Q23, WS3, WS4, ZP1, and Z03

The following catastrophic errors require that the system be re-IPLed: \$K02, \$K03, \$K08, \$K15 (when \$K15 occurs after initialization) and \$V01.

Operator response: Notify the system programmer. Enter the appropriate response to message \$HASP098.

System programmer response: Use the indicative dump and the SVC dump (if any) to diagnose the error.

If the displayed error code is \$K04, \$K10, \$K15, \$K17, \$K18, or \$K19, a possible reason for the error is that the JES2 program (for example, HASJES20) does not have the non-swappable attribute in the program properties table. Examine the SCHEDxx PARMLIB member to determine whether the JES2 program has the non-swappable attribute. See *z/OS JES2 Initialization and Tuning Reference* for more information.

Module: HASPBSC, HASPIRMA, HASPCKDS, HASPCKRR, HASPJOS, HASPCKPT, HASPNUC, HASPCNVT, HASPNPM, HASPCOMM, HASPRAS, HASPCON, HASPRDR, HASPDYN, HASPSERV, HASPEVTL, HASPSNA, HASPFSSM, HASPSTAM, HASPIRA, HASPTERM, HASPIRDA, HASPTRAK

Routing Code: 1,2,10

Descriptor Code: 11

\$HASP096 • \$HASP097

\$HASP096

Explanation:

▶▶—DISASTROUS ERROR AT SYMBOL—*errorsyn*— IN CSECT—*errormod*—▶▶
▶▶—*mmttttrr*,UNIT=*unit*,VOLSER=*vvvvvv*—▶▶

One of the following occurred:

- If an I/O error message accompanies this message, a critical I/O error has occurred on the SYS1.HASPACE data set.
- If no I/O error message accompanies this message, there is a logic error in JES2. Possible reasons for the logic error are:
 - JES2 tried to free a JCT (job control table) from the JCT queue and could not find the JCT on the queue, or JES2 detected an incorrect IOT (I/O table) or incorrect JCT while reading the spool.
 - JES2 detected an incorrect remote message JQE (RATRMJQE) for the signed-on remote. Either the JQE was not on the hardcopy queue (\$HARDCPY), or was not a started task (STC), or the remote name (RATNAME) and the JQE jobname (JQENAME) did not match.

The indicated symbol is used to generate the error message and can be referenced in the assembler cross-reference for the indicated CSECT.

In the message text:

errorsyn

The label within the CSECT.

errormod

The name of the affected CSECT.

mmttttrr

JES2 address of the record being processed (mm=SPOOL extent, tttt=absolute track, rr=record)

uuuu Specifies a 4-digit hexadecimal device number.

vvvvvv The VOLSER associated with the device.

Note: A jobid may precede \$HASP096. See “JES2 message format” on page 1.

System action: JES2 continues processing jobs using unaffected facilities.

Operator response: Notify the system programmer.

System programmer response: Recreate the failure while running \$TRACE ID=3. Optionally, issue a SLIP dump or code an SDUMP macro on entry to the \$DISTERR routine in HASPNUC.

Module: HASPRAS

Routing Code: 10

Descriptor Code: 4

\$HASP097

Explanation:

▶▶—*devname*—IS DRAINED—▶▶

The operator issued the \$P command for the indicated device, and the device has entered the DRAINED status. With OS/390® Release 4, some parameter descriptions might truncated (for example, LNE), therefore, your automation processing might be affected.

In the message text:

devname

The name of the drained device.

System action: JES2 discontinues use of the device until a \$S device command is entered, specifying the device correctly. JES2 deallocates the device, permitting it to be used by other tasks within the system.

Operator response: Enter a \$S device command when JES2 is to continue using the device.

Module: HASPNUC

Routing Code: 7,8

Descriptor Code: 4

\$HASP098

Explanation:

▶—ENTER TERMINATION OPTION—▶

The JES2 main task encountered an error and issued message \$HASP095 to describe the error. JES2 is stopping because one of the following occurred:

- There is no JES2 processor recovery routine that can handle this error.
- JES2 issued message \$HASP070 to ask the operator whether JES2 should attempt recovery or end and the operator replied TERMINATE.
- JES2 ran a recovery routine, but the recovery attempt failed.

\$HASP098 prompts the operator for an ending option. This message is preceded by \$HASP198.

System action: The system waits for the operator to reply. If no response is made after 10 minutes, then JES2 will take the default action of END,DUMP. \$HASP065 is issued every 30 seconds to tell the operator that an automatic response will occur for the WTOR.

Operator response: Enter one of the following:

END – JES2 attempts to stop any attached tasks, informs tasks waiting on a JES2 function of the error, and then exits from the system. Upon completion, the \$HASP085 message is issued.

END,DUMP
JES2 attempts to take a dump followed by end processing.

END,NOHOTSTART –
JES2 exits from the system with a reduced amount of clean up, risking the ability to bring JES2 back up on a hot-start. When processing completes, message \$HASP085 is issued.

SNAP –
JES2 produces an indicative snap. See message \$HASP088 for a description of the contents that are displayed. When SNAP processing completes, message \$HASP098 is issued again.

DUMP –
JES2 initiates a system dump with a title of:

ABEND *cde* AT *mod1* (*start1*) + *offset1 desc ssss vvv*

The fields in the title are:

- cde** The system (Sxxx) or JES2 (\$xxx) abend code.
- mod1** The JES2 module name.
- start1** The beginning address of the JES2 module.
- offset1** The offset into the JES2 module of the failing instruction.
- desc** The description of the error.
- ssss** The subsystem name.
- vvv** The subsystem version number.

\$HASP099

DUMP text –

JES2 initiates a system dump with the title “text”.

Note: When dump processing completes, this message is issued again.

Module: HASPTERM

Routing Code: 1,2,10

Descriptor Code: 4

\$HASP099

Explanation:

▶▶—ALL AVAILABLE FUNCTIONS COMPLETE—▶▶

All JES2 job processors have become dormant, and no JES2 RJE lines are active.

System action: Processing continues and JES2 waits for work.

Operator response: Enter more jobs into the system or enter a command that allows job processing, such as:

- \$S if a \$P has been previously entered and processing is to be continued.
- \$SI if initiators are drained or halted.
- \$S devname if devices are drained, halted, or paused.
- \$AQ, \$AA, or \$AJ if queues or jobs are held.
- \$TI if initiators are not set to select available jobs in the execution queues.
- \$T devname if output devices are not set to select available output.
- \$R if output is routed to devices that are not currently operational and should be output to alternate devices.
- \$O if output is held and should be released.

Module: HASPNUC

Routing Code: 1–10

Descriptor Code: 4

Chapter 5. One-hundreds

The following JES2 messages are numbered in the 100-199 range.

\$HASP100

Explanation:

▶▶—*jobname*—ON—*devname*—programmer—FROM—*text*—▶▶

A JOB statement has been detected in the input stream from the indicated device, and JES2 has assigned the associated job a JES2 job identifier. The programmer name is displayed if it was specified on the JOB statement. In the message, *text* is one of the following:

- *jobid jobname*
- *userid at nodename*

In the message:

jobname

The name that appears in the name field of the JOB JCL statement.

devname

The name of the device on which this job entered the system. If the device name is **INTRDR**, this message also displays *ijobid* and *ijobname*.

programmer

The programmer name that appears in the NAME field of the JOB JCL statement.

ijobid The identifier of the job that is submitting *jobname*. This information is displayed only if the device name is **INTRDR**, and the submitter has a job identifier. If the submitter does not have a job identifier, **N/A** is displayed.

ijobname

The name of the job that is submitting this job. This information is displayed only if the device name is **INTRDR**.

userid The TSO/E user ID that originated this job. JES2 only displays this information if the job enters the system from the network. If JES2 cannot identify the user ID that originated this job, this field displays ***UNKNOWN**.

nodename

The name of the node from which this job originated. JES2 only displays this information if the job enters the system from the network. If JES2 cannot identify the node from which this job originated, this field displays ***UNKNOWN**.

Note: A job identifier may precede \$HASP100. See “JES2 message format” on page 1.

System action: Processing continues.

Operator response: None.

System programmer response: None.

Module: HASPRDR, HASCINJR, HASCNJJR

Routing Code: 7

Descriptor Code: 4

\$HASP101 • \$HASP102

\$HASP101

Explanation:

▶▶—*jobname*—HELD—◀◀

The indicated job has been placed in JES2 HOLD status for one of the following reasons:

- | • The JOB statement specified TYPRUN=HOLD. Check to see if the job card specified TYPRUN=HOLD.
- | • The JOB statement specified TYPRUN=JCLHOLD. Check to see if the job card specified TYPRUN=JCLHOLD.
- | • The device from which the job was read was set to HOLD all jobs. Run the \$D command with the input device to see if HOLD=YES is specified.
- | • The class of the job has been set by JES2 initialization parameters such that all jobs entered in that class is held. Run the \$D JOBCLASS command with the initial class that was specified for the job to see if HOLD=YES was specified.
- | • The job had a /* SETUP JCL control statement. Check to see if the job card specified a /* SETUP control card.
- | • HOLDUNTIL keyword on the SCHEDULE statement was used to specify a time in the future when the job should be released. Job is held until the specified time or until the job is released.

In the message text:

jobname

The name of the held job.

Note: A job identifier may precede \$HASP101. See “JES2 message format” on page 1.

System action: Processing continues on other jobs.

Operator response: Determine the reason the job was placed in JES2 HOLD status. When appropriate, release the job for further processing.

System programmer response: None.

Module: HASPCNVT

Routing Code: 1,2

Descriptor Code: 4

\$HASP102

Explanation:

▶▶—*jobname*—HELD FOR THE—FOLLOWING VOLUME(S) — —◀◀

The indicated job has been placed in HOLD status by the JES2 input service because a /*SETUP control statement was encountered. The text of the control statement is displayed with accompanying \$HASP103 messages.

In the message text:

jobname

The name of the held job.

Note: A jobid may precede \$HASP102. See “JES2 message format” on page 1.

System action: The system continues processing and holds the job on the execution queue.

Operator response: Ensure that the requested volumes are available to be mounted, and release the job.

System programmer response: None.

Module: HASCSRIP

Routing Code: 1–6

Descriptor Code: 4

\$HASP103

Explanation:

►► *jobname*—*volser*, ..., *volser* ◀◀

The indicated job has been placed in HOLD status by the JES2 input service pending availability of the volumes indicated by *volser*, ..., *volser*.
In the message text:

jobname
The name of the held job.

volser ..., **volser**
The one to eight character volume identifier of the volumes.

Note: A jobid may precede \$HASP103. See “JES2 message format” on page 1.

System action: The job is placed in JES2 HOLD status, and input processing continues.

Operator response: Ensure that the requested volumes are available to be mounted and release the job.

System programmer response: None.

Module: HASCSRIP

Routing Code: 1–6

Descriptor Code: 4

\$HASP104

Explanation:

►► *jobname* *devname* *text* ◀◀

The input service processor has detected a /*MESSAGE control statement in the input stream.
In the message text:

jobname
The name of the job.

devname
The name of the device.

text The text of the /*MESSAGE control statement.

Note: A jobid may precede \$HASP104. See “JES2 message format” on page 1.

System action: Processing continues.

Operator response: Respond to the message accordingly.

System programmer response: None.

Module:

HASCSRIP

Routing Code: 1–6

Descriptor Code: 4

\$HASP105 • \$HASP107

\$HASP105

Explanation:

▶▶—*jobname*— - - EXPECTED CONTINUATION—NOT RECEIVED—▶▶

In a line of a JCL statement, the system found either a non-blank character in column 72, or a comma at the end of the last operand, and expected a continuation on the next line. A continuation begins with `//`. Instead, the next line began with `/*`.

In the message text:

jobname

The name of the job.

System action: Input servicing for *jobname* terminates.

Programmer response: If the continuation line is missing, provide it.

If the continuation line is present, but mistakenly begins with `/*`, correct it to begin with `//`.

If no continuation was intended, correct the first line so that column 72 is blank, and the last operand ends with a blank.

Module:

HASPRDR, HASCINJR, HASCNJJR

Routing Code: 7

Descriptor Code: 4

\$HASP106

Explanation:

▶▶—*jobname*—DELETED BY JES2 OR CANCELLED—BY OPERATOR BEFORE EXECUTION—▶▶

JES2 places this message in the job log:

- If the *jobname* contained a JECL error
- The operator canceled the job before the *jobname* processed.

In the message text:

jobname The name that appears in the name field of the JOB JCL statement.

Note: A job identifier may precede \$HASP106. See “JES2 message format” on page 1.

System action: Processing continues.

Operator response: None.

System programmer response: None.

Module: HASPHOPE

Routing Code: -

Descriptor Code: -

\$HASP107

Explanation:

▶▶—*jobname*—NON-VALID—*statement*—STMT,—*reason*—▶▶

OR

▶▶—*jobname*—Non-valid—*statement*—STMT,—*reason*—▶▶

While parsing JCL statements, JES2 detected an error on the *xxxxxxx* statement. The problem encountered is identified by *reason*.

In the message text:

jobname The name of the affected job.

statement

The JCL statement affected.

reason is one of the following:

KEYWORD LENGTH NOT VALID

A keyword longer than 8 characters was encountered.

VALUE FOR *xxxxxxx* KEYWORD NOT VALID

The value for the keyword listed is syntactically not valid (for example, unbalanced parentheses or apostrophes might exist).

UNEXPECTED KEYWORD DETECTED – *xxxxxxx*

An unknown keyword was encountered on the statement.

UNEXPECTED POSITIONAL OPERAND DETECTED

A positional operand was encountered where one was not expected. Typically this is caused by a missing '=' or improper apostrophes.

VALUE FOR POSITIONAL OPERAND NOT VALID

A syntactically invalid positional operand was detected.

value for DLM keyword not valid

The syntax of the delimiter keyword value is incorrect.

Note: A job identifier may precede \$HASP107. See “JES2 message format” on page 1.

System action: The message is written to the JCL data set and JES2 ends input service processing for the job. The job is queued for output processing.

Operator response: None.

Programmer response: See *z/OS MVS JCL Reference* for correct forms of the listed statement. Correct the JCL error and rerun the job.

Module: HASCSRIP

Routing Code: 7

Descriptor Code: 4

\$HASP108

Explanation:

| ▶▶—*JOB name*—Non-valid XMIT stmt—*reason*—▶▶

| While parsing JCL statements, JES2 detected an error on the XMIT statement. The problem encountered is identified by *reason*. In the message text:

| *JOB name*

The name of the affected job.

The *reason* is defined as one of the following:

| **operand field does not terminate in comma or blank**

| Operand field must terminate with a comma or blank.

| **DEST keyword error, RC=1**

The DEST= keyword specified null destination.

\$HASP109

no operand supplied, RC=2

No operands were specified on the //XMIT card. The DEST= keyword is required.

DEST= value in error, RC=3

The DEST= keyword specified a destination that was not valid.

delimiter error, RC=4

Error processing DLM= parameter.

NON-VALID CONTINUATION, RC=5

A continuation that is not valid was detected.

UNEXPECTED KEYWORD DETECTED, RC=6

An unsupported or unrecognized keyword was detected.

DEST keyword missing, RC=7

DEST= keyword is required but not found.

duplicate DEST keyword, RC=8

Multiple DEST= keywords detected

duplicate DLM keyword, RC=9

Multiple DLM= keywords detected.

placement in JCL is not correct, RC=10

An XMIT statement must be placed after the JOB card and before any other JCL/JECL statements, except comments. This did not occur in the affected job stream.

System action: The message is written to the console and to the JESYSMSG data set when the job is converted. The job is queued for output processing after conversion, unless the message is a warning only.

Operator response: None.

Programmer response: See *z/OS MVS JCL Reference* for the correct format of the //XMIT JCL statement. Correct the statement and rerun the job.

Module: HASPRDR, HASCINJR, HASCSRIP

Routing Code: 7

Descriptor Code: 4

\$HASP109

Explanation:

▶▶—*jobname*—ILLEGAL CONTROL CARD—DETECTED BY EXIT 4/54—▶▶

The JECL/JCL installation exit routine (Exit 4/54) has notified the input service processor that it has detected an illegal control statement. The installation may use the exit routine to replace the text of this message.

In the message text:

jobname

The name of the job.

Note: A jobid may precede \$HASP109. See "JES2 message format" on page 1.

System action: JES2 ends input service processing for the job.

Programmer response: See *z/OS MVS JCL Reference* for the correct format of the control statement in error. Correct the control statement and resubmit the job.

Module:

HASCSRIP

Routing Code: 7

Descriptor Code: 4

\$HASP110

Explanation: Operator console form:

▶▶—*jobname*—Illegal JOB card—*reason*—————▶▶

OR

▶▶—*jobname*—illegal JOB card—*reason*—————▶▶

OR

▶▶—*jobname*—Invalid JOB statement—*reason*—————▶▶

| OR

| ▶▶—*jobname*—Illegal /*MAIN card—*reason*—————▶▶

| JESYSMSG message form:

▶▶—*reason*—————▶▶

| While parsing JCL and JECL statements, JES2 detected an error on the JOB JCL statement or MAIN JES3 JECL statement. The problem encountered is identified by *reason*. In the message text:

| *jobname* The name of the affected job.

The *reason* is one of the following strings:

account field incorrect

JES2 requires both an account number and a room number. This requirement is due to the ACCTFLD=REQUIRED on the JOBDEF initialization statement. Check for a missing or incorrect account number or room number.

ERROR DETECTED BY EXIT *nnn* OR error detected by exit *nnn*

The listed exit has detected an error on the JOB statement. See processing in that exit to determine the cause of the error.

| **Illegal job card - Multiple job/jobgroup cards detected**

| Under normal conditions, multiple job/jobgroup statements are allowed. For example, they are allowed from an internal reader (a SUBMIT from ISPF EDIT). However, JES2 does not permit multiple job/jobgroup statements in the following situations:

- An NJE job stream from VM RSCS or from another JES2 node that uses /*XMIT.
- Started jobs that use IEFJOBS support, where only one JOB card is permitted in the started member.

If the problem is a started job, for example, and this message is preceded by \$HASP100 ON STCINRDR, see *z/OS MVS JCL Reference* for more information.

value of accounting string is too long

The accounting string positional operand is longer than the maximum value allowed.

value of programmer name is too long

The programmer name positional operand is longer than the maximum value allowed.

value of *keyword*= exceeds *n* characters

The value provided for the specified keyword exceeds the maximum value allowed.

value of *keyword*= has too many operands

The specified keyword is a list for which too many values have been specified.

value of *keyword*= parameter is greater than *nnn*

The specified keyword has a value larger than the maximum allowed for the keyword.

\$HASP110

value of keyword= parameter is not numeric

The specified keyword is required to be numeric.

value of keyword= parameter is not valid

The value provided for the specified keyword is not valid.

value of keyword= parameter is null

The specified keyword cannot be specified as null.

value of CLASS= parameter is an inactive class

The specified class is not valid because the class is inactive.

| **JOB CLASS FAILED AUTHORIZATION**

| Job submitter or job owner is not authorized to submit jobs for the job class specified for this job.

Value of UJOBCORR has embedded blanks

The user portion of the job correlator cannot contain embedded blanks, and an embedded blank was provided.

Value of UJOBCORR has invalid characters

The user portion of the job correlator contains characters other than alphanumeric, national (@, #, \$), or underscore (_) characters.

Value of UJOBCORR has greater than 32 characters

The user portion of the job correlator is limited to 32 characters, and more than 32 characters were supplied.

default class ccccccc is not valid

The job class used for the job by default is not valid.

default class ccccccc is not active

The job class used for the job by default is not active.

| **value of CLASS= parameter is not valid**

The specified job class is not valid.

| **value of CLASS= parameter is an inactive class**

The specified job class is not active.

keyword= not valid for this job type

The keyword, and value, are not allowed for a started task.

SYSTEM and SYSAFF cannot both be specified

SYSTEM= and SYSAFF= are mutually exclusive keywords.

SYSTEM specified more than once

SYSTEM= cannot be specified more than once.

SYSAFF not valid, begins with "-" on second or later value

"-" is allowed only before the first member name.

SYSAFF of -ANY not valid

It is not valid to remove all members from SYSAFF by using "-ANY".

SYSTEM= names of JGLOBAL and JLOCAL must not appear with other names

The JES3 generic names of JGLOBAL and JLOCAL cannot be specified with other SYSTEM names.

SYSTEM of -ANY not valid

It is not valid to remove all systems from consideration by using "-ANY".

SYSTEM not valid, begins with "-" on second or later value

"-" is allowed only before the first system name.

SYSTEM= values of JGLOBAL and JLOCAL are ignored

JGLOBAL and JLOCAL are used in a JES3 environment. They are tolerated in a JES2 environment, but provide no function. This situation results in:

- The message ID and the reason text are the only text written.
- The message appears only in the JESYSMSG data set.
- The condition is treated as a warning, not an error.

| **SYSTEM= not valid for this job type**

| SYSTEM keyword is not valid for started tasks (STC) and TSO jobs.

| **Operand field does not terminate in comma or blank**
 | Operand field must terminate with a comma or blank.

| **Unable to access JCT extension**
 | JES2 processing failed when it attempted to access a JCT extension.

Note: A *jobid* can precede \$HASP110. See “JES2 message format” on page 1.

System action: The message is written to the JESYSMSG data set when the job is converted. The job is queued for output processing after conversion, unless the message is a warning only.

Operator response: None

Programmer response: See *z/OS MVS JCL Reference* for information about coding JOB statements. Correct the JOB statement or remove the additional job cards and resubmit the job.

Module: HASCINJR, HASCS RIP, HASPRDR

Routing Code: 7

Descriptor Code: 4

\$HASP111

Explanation:

▶▶—*jobname*—Invalid /*ROUTE card—*reason*—*jobname*—Invalid /*ROUTE XEQ card—*reason*————▶

▶—*jobname*—INVALID PRINT/PUNCH ROUTE————▶▶

While parsing JCL statements, JES2 detected an error on the /*ROUTE statement. The problem encountered is identified by *reason*.

In the message text:

jobname The name of the affected job.

The *reason* is one of the following strings:

destination not valid

The destination that is specified on the /*ROUTE statement is not valid, or this user does not have access to the destination.

missing positional operand

The destination operand was not specified.

not valid for this job type

A ROUTE XEQ card was specified for a started task.

PRINT, PUNCH, OR XEQ required

The first positional operand on a /*ROUTE statement must be one of the values listed.

Note: A *jobid* can precede \$HASP111. See “JES2 message format” on page 1.

System action: The message is written to the JESYSMSG data set when the job is converted. The job is queued for output processing after conversion unless the message is a warning only.

Operator response: None

Programmer response: See *z/OS MVS JCL Reference* for correct forms of the /*ROUTE statement. Correct the JCL error and rerun the job.

Module: HASCINJR, HASCS RIP, HASPRDR

Routing Code: 7

Descriptor Code: 4

\$HASP112

\$HASP112

Explanation:

►►—*jobname*—Invalid /*JOBPARM card—*reason*—————►►

| OR

| ►►—*jobname*—Illegal /*MAIN card—*reason*—————►►

| While parsing JECL statements, JES2 detected an error on the /*JOBPARM JES2 JECL statement or /* MAIN JES3
| JECL statement. The problem encountered is identified by *reason*.

In the message text:

jobname The name of the affected job.

reason is one of the following:

| **JOB CLASS FAILED AUTHORIZATION**

| The supplied job class did not pass the authorization check.

| **SECURITY AUTHORIZATION FAILURE FOR JOB CLASS**

| The supplied job class did not pass the authorization check.

keyword= not valid for this job type

The keyword, and value, is not allowed for a started task.

unknown positional operand

A positional operand was encountered that was not recognized.

value of keyword= EXCEEDS nnnnnnnn

The numeric value provided for the specified keyword exceeds the maximum value allowed for the keyword.

value of keyword= exceeds n characters

The character values provided for the specified keyword is longer than the maximum allowed length.

value of keyword= must be Y or N

The only allowed values for the specified keyword are 'Y' or 'N'.

value of keyword= parameter is not valid

The value provided for the specified keyword is not allowed. It might be that the value is null and the keyword requires a value.

PROCLIB in prior /*JOBPARM statement not valid if PROCLIB also on JCLLIB statement

PROCLIB= can be specified on the /*JOBPARM statement or on the JCLLIB statement, but not both.

Not valid to specify PROCLIB if also specified in JCLLIB statement

PROCLIB= can be specified on the /*JOBPARM statement or on the JCLLIB statement, but not both.

SYSAFF not valid, begins with "-" on second or later value

"-" is allowed before only on the first member name.

SYSAFF of -ANY not valid

It is not valid to remove all members from SYSAFF by using "-ANY".

| **Value of keyword= ignored – prior value used**

| The value provided for the specified keyword was provided earlier on a prior JCL or JECL statement. The prior
| value is used. The value from the current statement is ignored. This situation results in:

- | • The message ID and the reason text are the only text written.
- | • The message appears only in the JESYSMSG data set.
- | • The condition is treated as a warning, not an error.

SYSAFF ignored because SYSAFF or SYSTEM specified on JOB card

The value provided for SYSAFF has been ignored because SYSAFF or SYSTEM was specified on the JOB card.
This situation results in:

- The message ID and the reason text are the only text written.

- The message appears only in the JESYSMSG data set.
- The condition is treated as a warning, not an error.

value of PROC= parameter is not valid

PROC= keyword must specify two character suffix of PROCxx DD statement used during invocation of JES2 subsystem.

A *jobid* can precede \$HASP112. See “JES2 message format” on page 1.

System action: The message is written to the JESYSMSG data set when the job is converted. The job is queued for output processing after conversion unless the message is a warning only.

Operator response: None

Programmer response: See *z/OS MVS JCL Reference* for correct forms of the /*JOBPARM statement. Correct the control statement and resubmit the job.

Module: HASCSRIP

Routing Code: 7

Descriptor Code: 4

\$HASP113

Explanation:

►►—*jobname*—Invalid /*OUTPUT card—*reason*—————►►

While parsing JCL statements, JES2 detected an error on the /*OUTPUT statement. The problem encountered is identified by *reason*.

In the message text:

jobname The name of the affected job.

The *reason* text is one of the following strings:

incorrect code value

The code value specified is not valid (too long or invalid characters).

incorrect continuation

An attempt to continue an OUTPUT statement was made but no previous output statement exists for the job.

value of keyword= exceeds nnnnnnnn

The numeric value provided for the specified keyword exceeds the maximum value allowed for the keyword.

value of keyword= exceeds n characters

The character values provided for the specified keyword are longer than the maximum allowed length.

value of keyword= has too many operands

The specified keyword is a list for which too many values have been specified.

value of keyword= must be Y or N

The only allowed value for the specified keyword is 'Y' or 'N'.

value of keyword= parameter is not valid

The value provided for the specified keyword is not allowed. It is possible that the value is null and the keyword requires a value.

Note: A *jobid* can precede \$HASP113. See “JES2 message format” on page 1.

System action: The message is written to the JESYSMSG data set when the job is converted. The job is queued for output processing after conversion unless the message is a warning only.

Operator response: None

Programmer response: See *z/OS MVS JCL Reference* for correct forms of the /*OUTPUT control statement. Correct the control statement and rerun the job.

\$HASP114 • \$HASP115

Module: HASCS RIP

Routing Code: 7

Descriptor Code: 4

\$HASP114

Explanation:

▶▶—*jobname*—Invalid /*XEQ card —*reason*—*jobname*—Invalid /*ROUTE XEQ card —*reason*————▶▶

▶—*jobname*—INVALID EXECUTION NODE————▶▶

While parsing JCL statements, JES2 detected an error on the /*XEQ or /*ROUTE XEQ statement. The problem encountered is identified by *reason*.

In the message text:

jobname The name of the affected job.

The *reason* is one of the following strings:

execution node not valid

The node specified on the XEQ statement is not a valid NJE node or DESTID of a valid node.

missing positional operand

The required node name operand was not specified on the JCL statement.

Note: A *jobid* can precede \$HASP114. See “JES2 message format” on page 1.

System action: The message is written to the JESYSMSG data set when the job is converted. The job is queued for output processing after conversion unless the message is a warning only.

Operator response: None

Programmer response: See *z/OS MVS JCL Reference* for the correct format of the /*XEQ control statement. Correct the control statement and rerun the job.

Module: HASCINJR, HASCS RIP, HASPRDR

Routing Code: 7

Descriptor Code: 4

\$HASP115

Explanation:

▶▶—*jobname*—Invalid /*NETACCT card—*reason*————▶▶

While parsing JCL statements, JES2 detected an error on the /*NETACCT statement. The problem encountered is identified by *reason*.

In the message text:

jobname The name of the affected job.

The *reason* is one of the following strings:

value of account exceeds 8 characters

The network account number specified is more than 8 characters in length.

missing positional operand

The required network account number was not specified on the NETACCT statement.

Note: A *jobid* can precede \$HASP115. See “JES2 message format” on page 1.

System action: The message is written to the JESYSMSG data set when the job is converted. The job is queued for

output processing after conversion unless the message is a warning only.

Operator response: None

Programmer response: See *z/OS MVS JCL Reference* for the correct format of the /*NETACCT control statement. Correct the control statement and resubmit the job.

Module: HASCSRIP

Routing Code: 7

Descriptor Code: 4

\$HASP116

Explanation:

▶▶—*jobname*—Invalid /* NOTIFY card—*reason*—————▶▶

While parsing JCL statements, JES2 detected an error on the /*NOTIFY statement. The problem encountered is identified by *reason*.

In the message text:

jobname The name of the affected job.

The *reason* is one of the following strings:

destination not valid

The notify destination specified is not valid.

missing positional operand

The required notify destination was not specified on the NOTIFY card.

Note: A *jobid* can precede \$HASP116. See “JES2 message format” on page 1.

System action: The message is written to the JESYSMSG data set when the job is converted. The job is queued for output processing after conversion unless the message is just a warning.

Operator response: None

Programmer response: See *z/OS MVS JCL Reference* for the correct format of the /*NOTIFY control statement, correct the control statement and rerun the job.

Module: HASCSRIP

Routing Code: 7

Descriptor Code: 4

\$HASP117

Explanation:

▶▶— *jobname*— JOB FAILED. JOB SYMBOL TABLE COULD NOT BE WRITTEN TO SPOOL—————▶▶

The input service processor encountered an error when writing Job Symbol Table (JSMT) to SPOOL.

In the message text:

jobname The name of the affected job.

System action: The message is written to the job log data set and JES2 ends input service processing for the job. The job is queued for output processing.

Operator response: Try to resubmit the job. Report this problem to the system programmer.

Programmer response: Contact the IBM Support Center.

Module: HASCSRIP

\$HASP118 • \$HASP119

Routing Code: 7

Descriptor Code: 4

\$HASP118

Explanation:

| ►►—*jobname*—Invalid JECL statement—►►

The input service processor has detected an unrecognizable JECL control statement.
In the message text:

jobname The name of the affected job.

Note: A jobid can precede \$HASP118. See “JES2 message format” on page 1.

System action: JES2 ends input service processing for the job.

Programmer response: See *z/OS MVS JCL Reference* for the correct format of the control statement in error. Correct the statement and resubmit the job.

Module: HASCSRIP

Routing Code: 7

Descriptor Code: 4

\$HASP119

Explanation:

►►—*jobname*—DELETED—_ text _—►►

The input service processor has deleted the indicated job. The cause for the deletion may be that the operator entered a command to cause the deletion or an error may have been encountered while inputting the job (for example, if JESYSMSG could not be created). When input errors are encountered, a previously displayed message details the nature of the error. In addition to previous messages, text, if present, describes the reason for the deletion.
In the message text:

jobname

The name of the affected job.

text will be one of the following:

ILLEGAL JOB CARD, RC=1

The JOB statement was found to be incorrect by the input service processor.

ILLEGAL CONTROL CARD (EXIT 4/54), RC=2

The JECL/JCL installation exit routine (Exit 4/54) has notified the input service processor that it has detected an illegal control statement.

MISSING CONTINUATION, RC=3

On an input JCL line, the input service processor found either a non-blank character in column 72 or a comma at the end of the last operand and the following input JCL line began with a /*.

/*DEL or /*PURGE JECL, RC=4

The input service processor detected a /*DEL or /*PURGE JECL statement in a JCL stream from an internal reader.

Note: JES2 generates a /*DEL if MVS closes an open internal reader data set on behalf of an ABENDING TCB.

OPERATOR COMMAND, RC=5

An operator command was issued against the job in input processing that requested the job to be deleted.

INTERNAL PROCESSING ERROR, RC=6

An internal logic error was detected by the input service processor.

I/O ERROR, RC=7

When attempting to read the JCL stream for a job, the input service processor detected an I/O error.

ILLEGAL JECL CARD, RC=8

The input service processor detected an error on a JECL card.

ILLEGAL EXECUTION NODE, RC=9

The input service processor detected an incorrect execution node for a JOB.

EXCESSIVE SYSIN STATEMENTS, RC=10

The job being processed by the input service processor has more SYSIN data sets than can be represented within the total number of buffers available on this member.

DEVICE CANCELLED OR STOPPED, RC=11

The input service processor has detected that the associated device has been canceled or stopped. This may be the result of an operator command or a request by the device to terminate processing.

ILLEGAL JOB CARD ACCT FIELD, RC=12

The input service processor detected that the accounting information on the job card is missing or incorrect.

SECURITY PROCESSING ERROR, RC=13

An internal logic error was detected by the input service processor while attempting to perform security validation.

NJE PROTOCOL ERROR, RC=14

The input service processor detected a violation of the NJE protocol.

NON-VALID // XMIT CARD, RC=15

The input service processor detected an error on a // XMIT JCL card.

NON-VALID // DD DATA CARD, RC=16

The input service processor detected an error in a // DD DATA JCL statement.

| **Error writing job symbols, RC=17**

| The input processor encountered an error when writing job symbols to SPOOL.

| **Continuation error on JOBGROUP card, RC=18**

| The input processor detected invalid continuation syntax used on a JOBGROUP card.

| **JECL card not allowed, RC=19**

| The input processor encountered a JECL card in the JCL stream for the job, for which the JECLDEF command/initialization statement specifies action FAIL.

Note: A jobid may precede \$HASP119. See "JES2 message format" on page 1.

System action: The job is routed to the print phase for appropriate action and then purged.

Operator response: Report this message to the system programmer.

Programmer response: Correct the problem as appropriate and resubmit the job.

Module: HASCINJR, HASCSRIP, HASPRDR

Routing Code: 7

Descriptor Code: 4

\$HASP120

Explanation:

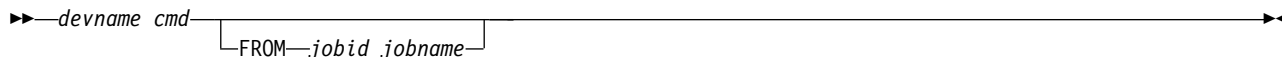

The displayed command has been entered from the device indicated. In the message text:

\$HASP121

devname

The name of the device from which the command was entered.

cmd

The text of the entered command.

jobid

If the command was submitted from an internal reader (devname is INTRDR), this is the jobid of the job that allocated the internal reader (submitter of the command).

jobname

If the command was submitted from an internal reader (devname is INTRDR), this is the jobname of the job that allocated the internal reader (submitter of the command).

System action: The command is passed to the JES2 command processor for the further action.

Operator response: None.

Module: HASPRDR, HASCINJR, HASCNJJR

Routing Code: 7,8

Descriptor Code: 4

\$HASP121

Explanation:

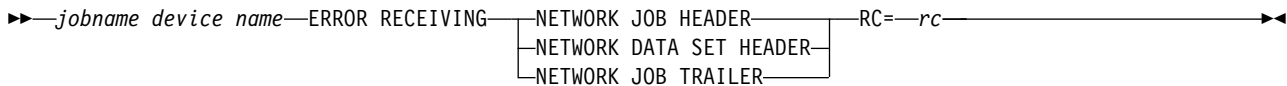

The device (either a JES2 job receiver or SYSOUT receiver) detected an error in the NJE header of the specified type. `RC=rc` contains a reason code that indicates why JES2 rejected the header or trailer.

In the message text:

jobname

The name of the job containing the error.

device name

The JES2 job receiver or the JES2 SYSOUT receiver.

rc

The reason code indicating why JES rejected the header or trailer.

The return codes:

- 00** The complete header could not be created because of a line error or record sequencing error. A symptom record (\$SYMREC) is not issued for this error.
- 04** The length of the header/trailer exceeds the maximum allowed by JES2.
- 08** The first section of the header or trailer is not the general section.
- 12** JES2 processing found a section with a length of less than 4 in the header or trailer.
- 16** The sum of the length of the header and trailer sections does not equal the total header length.

Note: A jobid may precede \$HASP121. See "JES2 message format" on page 1.

System action: The indicated job is deleted from this JES2 member. JES2 processing sends a negative response to the sending system, which should cause the job to be held there. A symptom record (\$SYMREC) might be written to the logrec data set to capture significant information in this header/trailer.

System programmer response: If other systems communicating with JES2 have specified their headers and trailers correctly, a hardware problem can be the only other cause for this message.

Module:

HASPNET

Routing Code: 1,2,10

Descriptor Code: 4

\$HASP122

Explanation:

▶▶—*jobname*—(—*jobid*—FROM—*nnnnnnnn*—)—RECEIVED AT—*nodename*—▶▶

The specified job has been received at the node where the job runs. This message is displayed to the TSO/E or VM/RSCS user if either the NOTIFY parameter is specified on the JCL JOB statement or the JECL /*NOTIFY statement is specified.

The fields displayed in the message and their meanings are:

jobname

The job name.

jobid The jobid at the input node.

nnnnnnnn

The input node for this job.

nodename

The node where the job runs.

Note: A jobid may precede \$HASP122. See “JES2 message format” on page 1.

System action: Processing continues.

Operator response: None.

System programmer response: None.

Module: HASCNJJR, HASPRDR

Routing Code: 7

Descriptor Code: 4

\$HASP123

Explanation:

▶▶—NJE PROTOCOL VIOLATION FROM NODE—*nodeid*— – PASSWORD ENCRYPTION—▶▶

In the NJE header for the specified job, an incorrect combination of password, new password, and password encryption bits were set.

One of the following 2 conditions exist:

1. The bit indicating that the new password is encrypted is set but the bit for the old password is not.
2. The bit indicating that the old password is encrypted is set and the corresponding bit for the new password is not set, and a new password is present in the header.

In the message:

nodeid The origin node for this job.

System action: JES2 ends input service processing for the job.

Operator response: Report this message to the local system programmer and to the node which originated the job.

System programmer response: Inform the origination node that the network headers created at that node do not conform to NJE protocols. The origin node can de-activate password encryption until the problem is resolved.

Module:

HASCINJR, HASPRDR

Routing Code: 7,8,10

\$HASP124 • \$HASP125

Descriptor Code: 4

\$HASP124

Explanation:

▶▶—*devname*—SKIPPING FOR JOB CARD AT—*xeqnode,orgjobid orgjname*—▶▶

The JES2 input service processor at node *xeqnode* is scanning the input stream for a JOB card. If the input stream enters the system (*xeqnode*) from the network, this message is displayed to the user from which the input stream originated. The operator at node *xeqnode* receives the \$HASP125 message from this input stream and may receive other diagnostic messages indicating errors encountered in the reading of jobs.

In the message text:

devname

The name of the device on which the input was entering the system (*xeqnode*).

xeqnode

The name of the node at which this job was to execute.

orgjobid

The job identifier or VM/RSCS spool file identifier from which this job originated.

orgjname

The job name associated with this job identifier that was found in the Network Job Header.

System action: The input service processor continues to read the input stream until a JOB card is encountered or until an end-of-data condition is recognized.

Operator response: None.

Programmer response: Correct the JCL and resubmit, or contact the system operator at the execution node to resolve any errors with the receiving of jobs on the network. This message can be cross referenced with *orgjobid* to the \$HASP125 message received by the operator at the execution node.

Module:

HASCS RIP

Routing Code: 7,8,10

Descriptor Code: 4

\$HASP125

Explanation:

▶▶—*devname*—SKIPPING FOR JOB CARD—orgjobid FROM—text—▶▶

The JES2 input service processor is scanning the input stream for a JOB card. This message may be accompanied by diagnostic messages indicating that errors have been encountered in the reading of jobs. In the message, *text* is one of the following:

- *ijobid ijobname*
- *userid AT nodename*

In the message:

devname

The name of the device on which the input was entering the system. If the device name is **INTRDR**, this message also displays *ijobid* and *ijobname*.

orgjobid

The job identifier or VM/RSCS spool file identifier from which this job originated. JES2 only displays this information if the job enters the system from the network.

ijobid The job identifier of the job that is submitting this job. This information is displayed only if the device name is **INTRDR**.

ijobname

The name of the job that is submitting this job. This information is displayed only if the device name is **INTRDR**.

userid The TSO/E user ID that originated this job. JES2 only displays this information if the job enters the system from the network. If JES2 cannot identify the user ID that originated this job, this field displays ***UNKNOWN**.

nodename

The name of the node from which this job originated. JES2 only displays this information if the job enters the system from the network. If JES2 cannot identify the node from which this job originated, this field displays ***UNKNOWN**.

System action: The input service processor continues to read the input stream until a **JOB** card is encountered or until an end-of-data condition is recognized.

Operator response: If you entered a command to delete a job currently on the device, perform the appropriate action consistent with the reason for deletion. If skipping is caused by the deletion of a job because of an error encountered, inform the programmer of the error. Otherwise, check the input stream to make sure that the cards are in correct order and resubmit the corrected jobs after canceling any that were incorrectly entered.

Programmer response: Correct the JCL in accordance with the accompanying error messages.

Module: HASPRDR, HASCINJR, HASCNJJR

Routing Code: 7

Descriptor Code: 4

\$HASP126

Explanation:

▶▶—OUTPUT=*grpid,joeid1,joeid2*—OUTPUT DELETED—▶▶

A \$#ADD macro has found a bad class in the JOE. A disastrous error is issued previous to this message. In the message text:

grpid The group identifier name assigned by the user or JES2.

joeid1 The number of job output elements in output group *grpid*.

joeid2 The number of job output elements in the output group identified by *grpid* and *joeid1*.

System action: JES2 deletes the data set.

Operator response: Notify the system programmer.

System programmer response: Investigate disastrous error.

Module: HASPMSG, HASPJOS

Routing Code: 2,10

Descriptor Code: 4

\$HASP128

Explanation:

▶▶—*devname*—SIMULATING \$C—
 └─*jobid jobname*—FLUSHED—▶▶

A program check occurred while a JES2 processor was using device *devname*. JES2 is simulating a \$C command for

\$HASP129 • \$HASP130

the device to prevent JES2 from ending. If the device was processing a job when the program check occurred, JES2 flushes the job and identifies it in the message text.

In the message text:

devname

The device name.

jobid The job identifier of the flushed job.

jobname

The name of the flushed job.

System action: Recovery processing continues.

Operator response: None.

System programmer response: None.

Module:

HASPRDR

Routing Code: 7,10

Descriptor Code: 4

\$HASP129

Explanation:

▶▶—*jobname*—EXCESS SYSIN DD STATEMENTS—▶▶

A user submitted a job stream to JES2 with such a large number of SYSIN // *ddname* DD * or DD DATA JCL statements that they could not be represented within the total number of buffers allocated to JES2 by the EXTBUF parameter on the BUFDEF initialization statement.

In the message text:

jobname

The name of the failed job.

Note: A jobid may precede \$HASP129. See "JES2 message format" on page 1.

System action: JES2 ends input service processing for the specified job.

Programmer response: If the failing job was submitted by a program that entered a loop, correct the program. Otherwise, use the failing job's output to determine the largest number of SYSIN DD cards that can be included in one job stream on your system. Correct the JCL and rerun the job.

Module: HASCSRIP

Routing Code: 7

Descriptor Code: 4

\$HASP130

Explanation:

▶▶—SECOND OPERAND OF JESLOG HAS—*sssssss*—ERROR—▶▶

Or:

▶▶—*jobname*—*procstepname*—*stepname*—*ddname*—SECOND OPERAND OF SPIN HAS—*sssssss*—ERROR—▶▶

The JOB statement has an error in the second operand of the JESLOG= operand, or the DD statement has an error in the second operand of the SPIN= operand.

In the message text *sssssss* =:

SYNTAX

The operand is not of the form *nnn*, *nnnK*, *nnnM*, *hh:mm*, *h:mm +hh:mm*, or *+h:mm*. If of the proper form, then the minute value may be greater than 59.

SEMANTICS

The line count is less than 500, the time interval is less than 10 minutes or the time of day, *hh*, is greater than 23.

In the message text:

jobname Specifies the name of the job.

procstepname
Specifies the name of the step invoking the PROC.

stepname
Specifies the name within the PROC.

ddname Specifies the name of the DD statement that returned the error.

System action: The job fails JCL conversion, or the job fails allocation.

Programmer response: Fix the JCL specification.

Module: HASCCNVS or HASCDALS

Routing Code: None. The message appears only in the JESYSMSG data set.

Descriptor Code: None

\$HASP131

Explanation:

▶▶—DSNAME—*devname*—MUST BE '&' —FOLLOWED BY AN ALPHABETIC OR CHARACTER—@,#,\$————▶▶

JES2 builds this message when the first character following the ampersand (&) on the DSNAME value specified on a SYSIN or SYSOUT DD statement is not alphabetic, @, #, or \$.

In the message text:

dsname
The name of the data set.

System action: JES2 uses the job name instead of the DSNAME specification when building the data set name.

Note: The JCL converter/interpreter (C/I) includes this message in the job's JESJCL data set; *this message is not issued to a JES2 operator console.*

User response: The DSNAME specification is incorrect. For more information, see the description of the DD DSNAME parameter in *z/OS MVS JCL Reference*. You may want to change the JCL and rerun the job.

Module: HASCSRDS

Routing Code: –

Descriptor Code: –

\$HASP132

Explanation:

▶▶—DSNAME—*devname*—MUST CONTAIN ALL—ALPHANUMERICS AND/OR CHARACTERS—@,#,\$,-,X'C0'————▶▶

JES2 builds this message when an incorrect character is found in the DSNAME value specified on a SYSIN or SYSOUT DD statement.

In the message text:

\$HASP133 • \$HASP134

dsname

The name of the data set.

System action: JES2 uses the job name instead of the DSNAMESPECIFICATION when building the data set name.

Note: The JCL converter/interpreter (C/I) includes this message in the job's JESJCL data set; *this message is not issued to a JES2 operator console.*

User response: The DSNAMESPECIFICATION is incorrect. For more information, see the description of the DD DSNAMESPECIFICATION parameter in *z/OS MVS JCL Reference*. You may want to change the JCL and rerun the job.

Module: HASCSRDS

Routing Code: –

Descriptor Code: –

\$HASP133

Explanation:

▶▶—DSNAME—*devname*—IS LONGER—THAN EIGHT CHARACTERS—▶▶

JES2 builds this message when the DSNAMESPECIFICATION value specified on a SYSIN or SYSOUT DD statement contains more than eight characters.

In the message text:

dsname

The name of the data set.

System action: JES2 uses the job name instead of the DSNAMESPECIFICATION when building the data set name.

Note: The JCL converter/interpreter (C/I) includes this message in the job's JESJCL data set; *this message is not issued to a JES2 operator console.*

User response: The DSNAMESPECIFICATION should contain no more than eight characters. For more information, see the description of the DD DSNAMESPECIFICATION parameter in *z/OS MVS JCL Reference*. You may want to change the JCL and rerun the job.

Module: HASCSRDS

Routing Code: –

Descriptor Code: –

\$HASP134

Explanation:

▶▶—DSNAME—*devname*—IS A—JES RESERVED NAME—▶▶

JES2 builds this message when the DSNAMESPECIFICATION value specified on a SYSIN or SYSOUT DD statement is reserved for JES2 use. This message can also be built as a result of dynamic allocation's creation of a data set.

In the message text:

dsname

The name of the data set.

System action: JES2 uses the job name instead of the DSNAMESPECIFICATION when building the data set name.

Note: The JCL converter/interpreter (C/I) includes this message in the job's JESJCL data set; *this message is not issued to a JES2 operator console.*

User response: The following data set names are reserved for use by JES2:

- JESJCL
- JESJCLIN

- JESMSGLG
- JESYSMSG

For more information, see the description of the DD DSNAME parameter in *z/OS MVS JCL Reference*. You may want to change the JCL and rerun the job.

Module:

HASCSRDS

Routing Code: –

Descriptor Code: –

\$HASP135

Explanation:

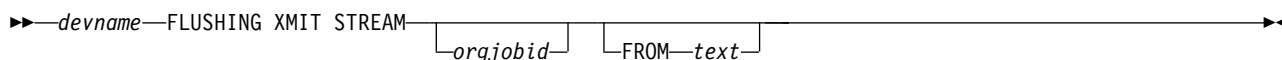

The JES2 input service processor is scanning the input stream for a JOB card when it encounters a /*XMIT control card. This card is not valid when it is not preceded by a valid JOB card. This message may be accompanied by diagnostic messages indicating that errors have been encountered in the reading of jobs. In the message, *text* is one of the following:

- *ijobid ijobname*
- *userid AT nodename*

In the message:

devname

The name of the device on which the input was entering the system. If the device name is **INTRDR**, this message also displays *ijobid* and *ijobname*.

orgjobid

The job identifier or VM/RSCS spool file identifier from which this job originated. JES2 only displays this information if the job enters the system from the network.

ijobid The job identifier of the job that is submitting this job. This information is displayed only if the device name is **INTRDR**.

ijobname

The name of the job that is submitting this job. This information is displayed only if the device name is **INTRDR**.

userid The TSO/E user ID that originated this job. JES2 only displays this information if the job enters the system from the network. If JES2 cannot identify the user ID that originated this job, this field displays ***UNKNOWN**.

nodename

The name of the node from which this job originated. JES2 only displays this information if the job enters the system from the network. If JES2 cannot identify the user ID that originated this job, this field displays ***UNKNOWN**.

System action: The input service processor flushes the input stream until a delimiter is encountered or until an end-of-data condition is recognized. The delimiter is determined by the DLM parameter on the /*XMIT control card if specified correctly. Otherwise, the delimiter is determined by the defaults.

Operator response: If you entered a command to delete a job currently on the device, perform the appropriate action consistent with the reason for deletion. If flushing is caused by the deletion of a job because of an error encountered, inform the programmer of the error. Otherwise, check the input stream to make sure that the cards are in correct order and resubmit the corrected jobs after canceling any that were incorrectly entered.

Programmer response: Check the input stream to make sure that the cards are in the correct order and there is a valid JOB card before the /*XMIT card. Correct the JCL accordingly and resubmit the job.

Module:

\$HASP136 • \$HASP137

HASCS RIP

Routing Code: 7,8,10

Descriptor Code: 4

\$HASP136

Explanation:

▶▶—*devname*—FLUSHING XMIT STREAM AT—*xeqnode,orgjobid orgjname*—▶▶

The JES2 input service processor at node *xeqnode* is scanning the input stream for a JOB card when it encounters a /*XMIT control card. This card is not valid when it is not preceded by a valid JOB card. If the input stream enters the system (*xeqnode*) from the network, this message is displayed to the user from whom the input stream originated. The operator at node *xeqnode* receives the \$HASP135 message from this input stream and may receive other diagnostic messages indicating errors encountered in the reading of jobs. In the message text:

devname

The name of the device on which the input was entering the system (*xeqnode*).

xeqnode

The name of the node at which this job was to execute.

orgjobid

The job identifier or VM/RSCS spool file identifier from which this job originated.

orgjname

The job name associated with this job identifier that was found in the Network Job Header.

System action: The input service processor flushes the input stream.

Operator response: None.

Programmer response: Check the input stream to make sure that the cards are in the correct order and there is a valid JOB card before the /*XMIT card. Correct the JCL accordingly and resubmit the job. This message can be cross referenced with *orgjobid* to the \$HASP135 message received by the operator at the execution node.

Module:

HASCS RIP

Routing Code: 7,8,10

Descriptor Code: 4

\$HASP137

Explanation:

▶▶—ACTRMT—(—*nnnn*—)—MEMBER=—*memname*—▶▶

JES2 displays all RJE workstations that are active in the multi-access spool (MAS) configuration in response to the \$D ACTRMT command.

All RJE workstations displayed do not need to be defined on the member from which the \$D ACTRMT command was entered.

In the message text:

nnnn The number of the active RJE workstation.

memname

The name of the MAS member on which this RJE workstation is active.

System action: Processing continues.

Operator response: None.

System programmer response: None.

Module: HASCSCAN

Routing Code: #/1,2,10

Descriptor Code: 4

\$HASP138

Explanation:

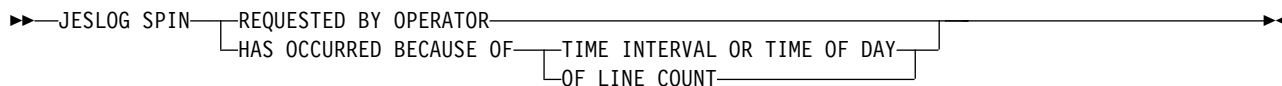

The JES2 JOBLOG (JESMSG LG) and systems messages (JESYSMSG) have been spun and made available for processing.

In the message text if:

JESLOG SPIN REQUESTED BY OPERATOR

A result of a \$Tjnnn, SPIN \$TSnnn,SPIN or \$TTnnn,SPIN command.

JESLOG SPIN HAS OCCURRED BECAUSE OF TIME INTERVAL OR TIME OF DAY

A result of the time interval for JESLOG (JESLOG=(SPIN,+hh:mm)) expiring or the time of day (JESLOG=(SPIN, hh:mm)) occurring.

JESLOG SPIN HAS OCCURRED BECAUSE OF LINE COUNT

A result of the line count criterion being reached (JESLOG=(SPIN,nnn)).

System action: Job processing continues.

Operator response: None.

System programmer response: None.

Module: HASPCOMM, HASCDSOC

Routing Code: None. The message appears only in SYSLOG, JESMSG LG and JESYSMSG.

Descriptor Code: None.

\$HASP139

Explanation:

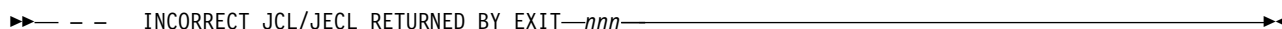

The specified exit returned JCL to be processed by input processing. However, the JCL that was returned had continuation or other errors that prevented input processing from correctly processing the job stream.

In the message text:

jobname The name of the affected job.

nnn The exit, or exits, that returned the invalid JCL.

Note: A jobid may precede \$HASP139. See “JES2 message format” on page 1.

System action: The message is written to the JCL data set and JES2 ends input service processing for the job. The job is queued for output processing.

Operator response: None

System programmer response: Review the exit and any JCL that is being modified or added by the exit. Review documentation for the exits in *z/OS JES2 Installation Exits* for more information on how to code a user exit.

Module: HASCSRIP

Routing Code: 7

\$HASP140 • \$HASP142

Descriptor Code: 4

\$HASP140

Explanation:

▶▶—ENF LISTEN REQUEST—*nn*—FAILED — — —RC=—*xx*—▶▶

During initialization, JES2 encountered a failure attempting to set up an ENF listen exit. This message is followed by message \$HASP428.

In the message text:

nn Relative number of the ENFREQ CODE=LISTEN that failed.

xx The hexadecimal return code from the ENFREQ CODE=LISTEN macro.

System action: JES2 initialization ends.

System programmer response: Contact the IBM Support Center.

Module: HASPIRSI

Routing Code: 1,2,10

Descriptor Code: 4

\$HASP141

Explanation:

▶▶—ENF DELETE REQUEST—*nn*—FAILED — — — RC=—*xx*—▶▶

During termination, JES2 encountered a failure attempting to delete an ENF listen exit.

In the message text:

nn Relative number of the ENFREQ CODE=DELETE that failed.

xx The return code from the ENFREQ CODE=DELETE macro.

System action: JES2 continues termination processing.

System programmer response: Contact the IBM Support Center.

Module: HASPTERM

Routing Code: 1,2,10

Descriptor Code: 4

\$HASP142

Explanation:

▶▶— Error encountered in JOE Index—(— RC=—*xxx*—)—.— JOE index suspended—▶▶

During JOE index verification, logical errors have been found in the JOE index.

In the message text:

xxx The reason code that identifies the detected problem.

System action: The JOE index is suspended and can no longer be used for the SYSOUT work selection. This might degrade performance of SYSOUT work selection, but otherwise does not impact JES2 functions.

System programmer response: Contact the IBM Support Center.

Module: HASPJOS

Routing Code: 2,10

Descriptor Code: 4

\$HASP143

Explanation:

▶▶—Error encountered in JOE Index—(— RC=—xxx—)—JOE index rebuild initiated————▶▶

During JOE index verification, logical errors have been found in the JOE index.
In the message text:

xxx The reason code that identifies the detected problem.

System action: The JOE index rebuild is initiated to rebuild the JOE index and to restore JOE index functionality. This is an asynchronous process running in the background. When the JOE index build is complete, message HASP145 is issued.

System programmer response: Contact the IBM Support Center.

Module: HASPJOS

Routing Code: 2,10

Descriptor Code: 4

\$HASP144

Explanation:

▶▶—JOE index build initiated————▶▶

The JOE index build was initiated by the \$TOUTDEF,WS_OPT=YES command.

System action: The JOE index build is initiated. This is an asynchronous process running in the background. When the JOE index build is complete, message HASP145 is issued.

Module: HASPXIT

Routing Code: 2,10

Descriptor Code: 4

\$HASP145

Explanation:

▶▶— JOE index build complete————▶▶

The JOE index build is complete. The JOE index build was initiated by the \$TOUTDEF,WS_OPT=YES command or by the JOE index verification process during JES2 member start if logical errors were found in the JOE index.

System action: The JOE index build is complete. The JOE index is fully functional and can be used for SYSOUT work selection.

Module: HASPJOS

Routing Code: 2,10

Descriptor Code: 4

\$HASP146

Explanation: Operator console form:

\$HASP147

▶▶—*jobname*—Invalid JCLLIB statement—*reason*—————▶▶

JESYSMSG message form:

▶▶—*reason*—————▶▶

While parsing JCL statements, JES2 detected an error on the JCLLIB statement. The problem encountered is identified by *reason*. In the message text:

jobname The name of the affected job.

The *reason* is one of the following strings:

VALUE OF *keyword*= EXCEEDS *n* CHARACTERS

The character values provided for the specified keyword are longer than the maximum allowed length.

VALUE OF *keyword*= PARAMETER IS NOT VALID

The value provided for the specified keyword is not allowed. If the specified value is null, the keyword might require a value.

Second JCLLIB statement ignored

The second JCLLIB statement is ignored by JES2. It is flagged by the converter as an error.

PROCLIB in prior /*JOBPARM statement not valid if PROCLIB also on JCLLIB statement

A prior /*JOBPARM statement has specified PROCLIB. Specifying PROCLIB on a subsequent JCLLIB statement is an error.

Note: A jobid can precede \$HASP146. See “JES2 message format” on page 1.

System action: The message is written to the JESYSMSG data set when the job is converted. The job is queued for output processing after conversion, unless the message is a warning only.

Operator response: None

Programmer response: See *z/OS MVS JCL Reference* for information about coding JCLLIB statements. Correct the control statement and resubmit the job.

Module: HASCSRIP

Routing Code: 7

Descriptor Code: 4

\$HASP147

Explanation:

▶▶— Exit 2/52 user portion of the job correlator ignored— invalid character—————▶▶

▶▶— Exit 2/52 user portion of the job correlator ignored— embedded blank—————▶▶

▶▶— Exit 20/50 user portion of the job correlator ignored— invalid character—————▶▶

▶▶— Exit 20/50 user portion of the job correlator ignored— embedded blank—————▶▶

JES2 detected an error while validating the user portion of the job correlator that was returned by exit 2, 20, 50, or 52 in the XPL. The message text indicates the error, as follows:

embedded blank

The user portion of the job correlator cannot contain embedded blanks, and an embedded blank was found in the supplied value.

invalid character

The user portion of the job correlator contains characters other than the supported alphanumeric, national (@, #, \$), and underscore (_) characters.

System action: The message is written to the JESYSMSG data set when the job is converted. The user portion of the job correlator supplied by the exit is ignored, and any existing setting of the user portion is retained. The job continues processing because the message is a warning message only.

Operator response: None

Programmer response: Investigate the installation exit code to determine where the data is placed in the user portion of the job correlator contained in the XPL.

Module: HASCSRIP

Routing Code: -

Descriptor Code: -

\$HASP148

Explanation:

▶▶—SCHEDULE statement ignored for STC/TSU—▶▶

▶▶—STARTBY time in the past—▶▶

▶▶—Conflict between STARTBY and HOLDUNT—▶▶

▶▶—Conflict between STARTBY and JOBGROUP—▶▶

▶▶—Job Group ID is not valid—▶▶

▶▶—Missing Job Group name—▶▶

▶▶—Job Group name is too long—▶▶

JES2 conversion processing detected an error while validating the keyword input on the SCHEDULE statement. The message text indicates the error, as follows:

SCHEDULE statement ignored for STC/TSU

SCHEDULE statement can be used in the JCL used for started tasks and TSO sessions, but is ignored and does not influence execution in any way.

STARTBY time in the past

STARTBY keyword specifies time in the past.

Conflict between STARTBY and HOLDUNT

There is a conflict between time specified on STARTBY keyword and time specified on HOLDUNT keyword. This message is issued in the following situations:

- STARTBY time is earlier than HOLDUNT time.
- STARTBY and HOLDUNT use different formats. One of them specifies an interval time and the other a point in time.

Conflict between STARTBY and JOBGROUP

STARTBY keyword is mutually exclusive with the JOBGROUP keyword.

\$HASP150

- | **Job Group ID is not valid**
| The supplied job group job ID does not match an existing, active job group.
- | **Missing Job Group name**
| A job group name must be supplied for the JOBGROUP parameter.
- | **Job Group name is too long**
| The supplied job group name is greater than 8 characters in length.
- | **System action:** The message is written to the JESYSMSG data set when the job is converted. The job is queued for
| output processing after conversion.
- | **Operator response:** None
- | **Programmer response:** See *z/OS MVS JCL Reference* for information about coding SCHEDULE statements. Correct
| the statement and resubmit the job.
- | **Module:** HASCCNVS
- | **Routing Code:** N/A
- | **Descriptor Code:** N/A

\$HASP150

Explanation:

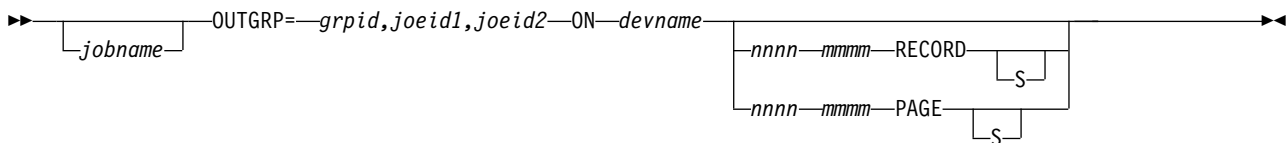

Device *devname* is beginning to process the output identified in the *grpId.joeId1.joeId2* fields for the indicated job. The record count includes only records with a non-zero text length and which do not use immediate machine control characters. The page count includes begin page structured fields only. Other AFP control records (records that start with the X'5A' control character) are not included in either the record or page count. Count information is omitted is not available.

In the message text:

jobname

The name of the job

grpId The group identifier assigned by user JCL or generated by JES2 if the user did not specify it

joeId1 The number of job output elements in output group *grpId*

joeId2 The number of job output elements in the output group identified by *grpId* and *joeId1*

devname

The name of the device

nnnn The number of records, pages, or both to be processed

mmmm

The number of records, pages, or both initially represented by the job output element identified by **OUTGRP=grpId.joeId1.joeId2**

If *nnnn* and *mmmm* are not equal, the job output element was partially processed at an earlier time, but that processing was interrupted.

Note: A jobid may precede \$HASP150. See "JES2 message format" on page 1.

System action: JES2 processing continues.

Operator response: None.

System programmer response: None.

Module: HASPPRPU, HASPFSSM

Routing Code: 7,10

Descriptor Code: 4/6

\$HASP151

Explanation:

►►—*jobname prtname text*—————►►

An error occurred while SETPRT processing was setting up the 3800 printer identified by *prtname* for the indicated job.

In the message text:

jobname

The name of the job.

prtname

The name of the printer.

text

The message number and text of a SETPRT error message.

See *z/OS MVS Programming: Assembler Services Reference ABE-HSP* under the SETPRT macro instruction for the explanation of the return code in the SETPRT error message.

Note: A jobid may precede \$HASP151. See “JES2 message format” on page 1.

System action: JES2 stops processing the specified job. Message \$HASP190 is issued when this job requires that the setup for the device be altered. The SETPRT error message and message \$HASP154 are issued to the programmer.

Operator response: Respond as indicated in the SETPRT error message. If necessary, issue the \$DU command to display the current status of the printer and use the \$T command to correct the error.

System programmer response: None.

Module: HASPPRPU

Routing Code: 7

Descriptor Code: 2

\$HASP152

Explanation:

►►—*prtname*—COMMAND REJECTED—
└ - PRIOR COMMAND ACTIVE ┘—————►►

A repositioning command for the 3800 printer or impact printers identified by *prtname* cannot be processed. If – PRIOR COMMAND ACTIVE appears, the repositioning command is rejected because a previous command is still being processed by JES2.

If the optional text is not displayed, the command is rejected for one of the following reasons:

- The output currently located at the 3800 transfer station does not allow the specified command.
- For impact printers, no output is active for the specified command.

In the message text:

prtname

The name of the printer.

System action: The command is not processed. Processing continues.

Operator response: If this message is issued because a previous command is active, wait for processing to complete and then reenter the command. If this message is issued because the output is not valid for the specified command,

\$HASP153 • \$HASP154

ensure that the page currently at the transfer station is not a dummy page between jobs. Reenter the command when valid output is being printed.

System programmer response: None.

Module: HASPPRPU, HASPFSSP

Routing Code: 7,10

Descriptor Code: 4

\$HASP153

Explanation:

▶▶—*prtname*—JAMMED,SYSOUT RESTART—————▶▶

The printer identified in the message has lost some data.
In the message text:

prtname

The name of the printer.

System action: If the operator does not reposition the printer, output processing resumes with the output last fused by the printer. If the operator wants to reposition the printer, the operator must wait for JES2 to resume output processing.

Operator response: If automatic recovery is acceptable, the operator need not respond. If automatic recovery is not acceptable, the operator must wait for JES2 to complete its backspacing process. If the operator does not wait, JES2 does not accept any operator commands. The operator may enter a \$F command or \$B command to reposition the printer to the page you want. The operator may even choose to enter a \$E command to restart the printer.

System programmer response: None.

Module:

HASPPRPU

Routing Code: 7

Descriptor Code: 4

\$HASP154

Explanation:

▶▶—SETPRT ERROR DEVICE=—*prtname*—JOB=—*jobname*—ID=—*jobid*—ROOM=—*rrr*—————▶▶

An error occurred while SETPRT processing was setting up the 3800 printer identified by *prtname* for the specified job. This message appears in the programmer's listing, preceded by the appropriate SETPRT error message. The operator receives message \$HASP151 or \$HASP157.

In the message text:

prtname

The name of the printer.

jobname

The name of the job.

jobid The identification number assigned to the job by JES2.

rrr The programmer's room number entered on the job statement.

System action: Processing of the specified job halts.

System programmer response: Respond as indicated in the SETPRT error message and rerun the job.

Module: HASPPRPU

Routing Code: 7

Descriptor Code: 4

\$HASP156

Explanation:

▶▶—*jobname prtname*—JOB REQUEUED—▶▶

The operator entered a repositioning command for the 3800 printer identified by *prtname*. At least some (and possibly all) of the output for the specified job has crossed the 3800 transfer station. This job is requeued on the output queue. In the message text:

jobname

The name of the job.

prtname

The name of the printer.

Note: A jobid may precede \$HASP156. See “JES2 message format” on page 1.

System action: The repositioning command is processed. The requeued job is printed on any eligible device.

Operator response: None.

System programmer response: None.

Module: HASPPRPU

Routing Code: 7

Descriptor Code: 4

\$HASP157

Explanation:

▶▶—*jobname prtname*—SETPRT ERROR,—RETURN CODE=—*rc*—▶▶

An error occurred while SETPRT processing was setting up the printer (with universal character set (UCS) specifications) identified by *prtname* for the specified job. In the message text:

jobname

The name of the job.

prtname

The name of the printer.

rc

The return code.

Note: A jobid may precede \$HASP157. See “JES2 message format” on page 1.

System action: JES2 stops processing the specified job. Depending on the type of error, message \$HASP190 might be issued. The appropriate SETPRT error message is issued. For the 3800 printer, message \$HASP154 is issued to the programmer's listing.

Operator response: Enter the \$DU command to display the current status of the printer, and use the \$T command to attempt to correct the error. If necessary, contact the system programmer.

System programmer response: Respond as indicated by the return code in register 15, which appears in this message. See the SETPRT macro instruction in *z/OS DFSMS Macro Instructions for Data Sets* for the meanings of return codes 18 through 50.

Module: HASPPRPU

Routing Code: 7

\$HASP158 • \$HASP160

Descriptor Code: 2

\$HASP158

Explanation:

▶▶—*jobname prtname*—PPQ SHORTAGE— — CODE =—*cde*—▶▶

JES2 detected a critical resource shortage during processing for the 3800 printer.
In the message text:

jobname

The name of the job.

prtname

The name of the printer.

cde

A decimal code indicating the type of shortage.

Possible values of *cde* are:

<i>cde</i>	Description
04	The PPQ (pending page queue) of the 3800 printer has been exhausted.
08	GETMAIN attempted to expand the PPQ of the 3800 printer and failed.
12	An error has been detected in the PPQ of the 3800 printer.

Note: A jobid may precede \$HASP158. See “JES2 message format” on page 1.

System action: When *cde*=04, the printer is halted.

When *cde*=08, the current job is interrupted and the printer is drained.

When *cde*=12, all jobs queued to the printer that has the error are requeued to another printer. The printer that has the error is drained.

Operator response: Possible responses are:

<i>cde</i>	Response
04	Entering a \$S PRTnnnn command attempts to expand the PPQ of the 3800 printer. If the expansion is successful, normal processing continues. If you enter a command to stop a printer (\$C, \$E, or \$I), the command processes against the current job and the printer drains.
08	Hold or cancel the job and restart the printer. Notify the system programmer.
12	Notify the system programmer.

System programmer response: If this message appears frequently, increase the CKPTPAGE parameter in the printer initialization statement. If this message is associated with a particular job, increase the CKPTPGS parameter in the /*OUTPUT control statement or the CKPTPAGE parameter on the JCL OUTPUT statement.

Module: HASPPRPU

Routing Code: 7

Descriptor Code: 2,4

\$HASP160

Explanation:

▶▶—*devname*—INACTIVE — CLASS =—*class*—
 └─*class...class*—▶▶

The indicated device found no work in the queue(s) specified by *class* [*class...class*].
In the message text:

devname

The name of the device searching for work.

class[class...class]

The names of the queues.

System action: The specified device remains INACTIVE until work becomes available.

Operator response: You can use the set (\$T) command to:

- Alter the setup to match work in the listed classes.
- Alter the current class list.

System programmer response: None.

Module:

HASPPRPU, HASPFSSP

Routing Code: 7

Descriptor Code: 4

\$HASP165

Explanation:

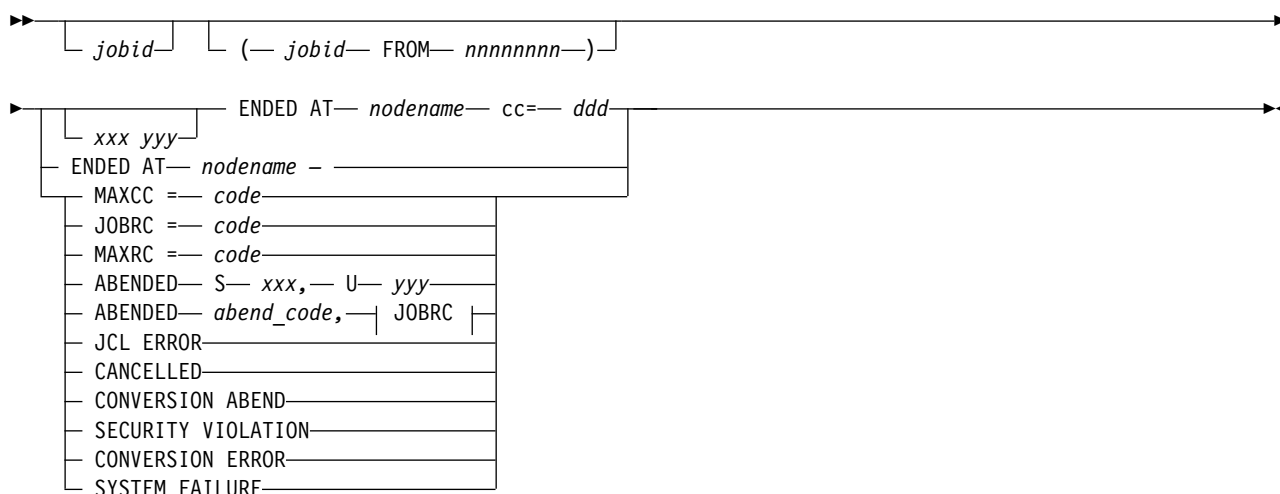

JOBRC:

| JOBRC = code

The following values are displayed in the message text:

jobname The job name. If apostrophe characters are imbedded in the job name, they are replaced by quotation mark characters.

jobid The job identifier on the input node.

nnnnnnnnn The input node for this job. This is displayed only if *nodename* is not the job input node.

nodename The node that the job ran on, or attempted to run on.

[*xxx yyy*] ENDED AT *nodename* - *cc=dddd*

JES2 stopped the specified job at *nodename* by a condition test specified in the COND parameter of the job statement being satisfied by the completion code *dddd* of the running step *xxx*. If step *xxx* is a step of a cataloged procedure, then *yyy* is the step that called step *xxx*.

\$HASP170

ENDED AT *nodename*

The specified job on *nodename* did not complete for the specified reason.

For ENDED AT *nodename* inclusive, one of the following reasons is displayed:

MAXCC=*code*

The job maximum condition *code* was reached (JOBRC was not specified).

JOBRC=*code*

The job returned *code*.

MAXRC=*code*

The job maximum return *code* was reached (JOBRC was specified but MAXRC was returned).

ABENDED *Sxxx,Uyyy*

The job abended with system code *xxx* and user code *yyy*.

ABENDED *abend_code*, JOBRC=*code* - JOBRC=(STEP,*stepname*),

The job abended with code *abend_code* and JOBRC *code*. The job step *stepname* executed, but a subsequent step abended.

JCL ERROR

The converter/interpreter or initiator phase of job processing could not be completed because of an error in the JCL.

CANCELLED

The job was cancelled by the operator.

CONVERSION ABEND

The job conversion phase abended.

SECURITY VIOLATION

The specified job did not run because of an unsuccessful authorization check during input processing.

CONVERSION ERROR

An error occurred during the job conversion phase.

SYSTEM FAILURE

A failure occurred on the system that the job was running on.

msgid message-text

A message from a component other than JES2 appears with the HASP165 prefix, and could be related to the reason the job ended (whether normally or abnormally). To determine the appropriate actions to take, see the description of the *msgid* message.

Note: A *jobid* value might precede \$HASP165. See "JES2 message format" on page 1.

System action: The job was ended for the specified reason. This message is displayed to an interactive user if the NOTIFY parameter is specified on the JCL JOB statement, or the JECL /*NOTIFY statement is specified.

Programmer response: In the case of a JCL ERROR message, check the system output for the actual error message. Correct the indicated error and resubmit the job. In the case of an ABENDED message, check system output for the ABEND code. In the case of SECURITY VIOLATION, verify the user ID, group ID, and password used, if any.

Module: HASPHOPE

Routing Code: 7

Descriptor Code: 4

\$HASP170

Explanation:



Output processing on the indicated device has been aborted, forward-spaced, deleted, backspaced, repeated, restarted, or interrupted.

In the message text:

devname

The name of the device.

System action: The system action depends on the specified function:

ABORTED

An unrecoverable error has occurred on the 3800 printer. Output processing is stopped. Job(s) currently active on the device are requeued from their last checkpoint and the device drains.

FWD-SPACED

The requested number of pages or cards is skipped without printing or punching, and processing continues. If the end of the data set is encountered while skipping, processing continues with the beginning of the next data set.

Note: If FWD-SPACED appears in the message, the operator might have pressed the cancel key on a printer that has cancel-key support.

DELETED

The output being processed on the indicated device is queued for the next processing phase. Output processing is stopped.

BACKSPACED

The requested number of pages or cards is backspaced, and processing continues. If the beginning of the data set is encountered while backspacing, processing continues at the beginning of the data set.

REPEATED

The output being processed on the indicated device is requeued. Output processing is continued.

RESTARTED

The output being processed on the indicated device is requeued. Output processing for the job is stopped.

INTERRUPTED

The output being processed on the indicated device is requeued. When it is processed again, processing begins from the last checkpoint taken. The device selects new output to process. If the interrupted output is the highest priority output available for the device, it is selected.

Operator response: None.

System programmer response: None.

Module: HASPPRPU, HASPFSSP

Routing Code: 7

Descriptor Code: 4

\$HASP175

Explanation:



Output processing on the indicated device is stopped at an end-of-job boundary.

In the message text:

\$HASP180 • \$HASP181

devname

The name of the device.

System action: Processing continues with the device unavailable.

Operator response: After removing the processed output, the operator can cause the device to continue its function by either depressing first the STOP then the START key on the device or by entering a \$S device command on the system console. To prevent future device pauses, enter \$T *devname*,P=NO.

System programmer response: None.

Module: HASPPRPU

Routing Code: 7

Descriptor Code: 4

\$HASP180

Explanation:

▶▶—*jobname devname*—

FCB
UCS

—IMAGE—*id*—

NOT FOUND
INVALID

————▶▶

The specified job has requested that image *id* be loaded into either the printer device forms control buffer (FCB), or the universal character set (UCS). A search of all images has shown that an I/O error occurred during an attempt to read from SYS1.IMAGELIB or a load error occurred during an attempt to load the image into the printer. Channel 1 must be defined in the image, otherwise the INVALID message results. This error can occur if the FCB or UCS was added to SYS1.IMAGELIB after JES2 was up and the new FCB or UCS caused SYS1.IMAGELIB to expand into a new extent. In this case, JES2 must be restarted to pick up the new FCB or UCS.

In the message text:

jobname

The name of the job.

devname

The name of the device.

id

The identifier of the image.

Note: A jobid may precede \$HASP180. See “JES2 message format” on page 1.

System action: Processing of the indicated job is halted.

Operator response: Enter the \$DU command to see the current status. Then use the \$T command to correct the indicated error. If FCB is indicated in the message and you have a non-impact printer, ensure that the forms settings on the printer correspond to the FCB specifications.

System programmer response: None.

Module: HASPPRPU

Routing Code: 7

Descriptor Code: 2,4

\$HASP181

Explanation:

▶▶—WARNING — PRINTER LOG—OR MDR AREA UNAVAILABLE————▶▶

During output processing to a printer, JES2 encountered an error while attempting to obtain buffers for the printer error log or MDR area.

System action: Output processing to the printer continues. However, there might be a loss of error log data or inappropriate error recovery procedures on some devices.

Operator response: Use the \$P PRT(nnnn) command to stop the printer, then restart it with the \$S PRT(nnnn) command. If the problem persists, notify the system programmer.

System programmer response: None.

Module: HASPNUC

Routing Code: 2,7

Descriptor Code: 4

\$HASP182

Explanation:

▶▶—NO BUFFERS TO DETERMINE—IF STD UCS/FCB—▶▶

During JES2 initialization processing for a printer, the \$GETBUF routine could not get enough buffers for JES2 to determine if the UCS or the FCB is a standard image. JES2 sets the DCT to show that the UCS or the FCB is a standard image.

System action: JES2 initialization processing continues.

Operator response: You might want to reset the printer because if the UCS or the FCB is not a standard image, jobs on the device might run incorrectly.

System programmer response: None.

Module:

HASPPRPU

Routing Code: 7

Descriptor Code: 4

\$HASP183

Explanation:

▶▶—*jobname*—HELD,BUFFER SHORTAGE DURING

CONVERSION
OUTPUT

—*mmm*—REQUIRED,—*nnn*—DEFINED—▶▶

During the indicated process, sufficient buffers were not available to process the specified job. In the message text:

jobname

The name of the held job.

mmm

The number of required buffers.

nnn

The number of defined buffers.

Note: A jobid may precede \$HASP183. See “JES2 message format” on page 1.

System action: The job is held.

Operator response: Release the job when fewer JES2 devices are active. If the job continues to receive this message, or if the number of required buffers (*mmm*) is greater than the number defined (*nnn*), notify the system programmer.

System programmer response: Increase the value of the limit for the EXTBUF parameter on the BUFDEF initialization statement, or use the PURGE option to cancel the specified job.

Module: HASPHOPE, HASPCNVT

Routing Code: 1,2

\$HASP184 • \$HASP185

Descriptor Code: 4

\$HASP184

Explanation:

▶▶—*devname*—NOT STARTED - —INSUFFICIENT STORAGE—▶▶

JES2 was unable to obtain storage for a DCB/DEB for the specified device.
In the message text:

devname

The name of the device.

System action: JES2 continues processing without the device.

Operator response: Notify the system programmer. Try to start the device at a later time.

System programmer response: Determine why there is insufficient storage in the JES2 address space and correct the error.

Module: HASPDYN

Routing Code: 7,10

Descriptor Code: 4

\$HASP185

Explanation:

▶▶—*jobname*—OUTGRP=*grpid,joeid1,joeid2*—BLOCK=*nnnn*—*devname*—TERMINATED - text, RC=*rsnc*—▶▶

JES2 stops processing the data set identified by *grpid.joeid1.joeid2* on the specified device.
In the message text:

jobname

The name of the job.

grpid The group identifier either assigned by the user JCL or generated by JES2 if the user did not specify it.

joeid1 The number of job output elements in output group *grpid*.

joeid2 The number of job output elements in the output group identified by *grpid* and *joeid1*.

nnnn The relative block number of the data set in which the error was detected.

rsnc The reason code.

text The explanatory text accompanying the reason code.

Note: A jobid may precede \$HASP185. See "JES2 message format" on page 1.
The device is stopped for the reasons associated with the following reason codes:

rsnc *text*

01 DATA SET NOT CLOSED

JES2 stopped processing the current data set because it encountered an error while attempting to read the next block of data. The data set was not closed. This may be because either the job was running during a system failure and is now being printed without being rerun or an abend occurred in CLOSE processing.

02 INVALID TRACK ADDRESS

JES2 detected that the track address of the next data block to be read is incorrect. It may be incorrect because a storage overlay of the track addressing field of the next spool block occurred before the block was written out. If BLOCK=1 is displayed, the error occurred in the control block pointing to the start of the data set (PDDDB in the IOT). If BLOCK=1 is **not** displayed, the error occurred in a data block. If a dump is issued, the \$PCE contains the value of the incorrect track address in the PCESEEK field.

03 I/O READ ERROR

An I/O error occurred while JES2 was attempting to read the data block numbered *nnnn* for the specified data set. A hardware problem is the probable cause for the error.

04 INVALID JOB KEY

The job key field of the data block numbered *nnnn* does not match the current job key because the same spool address has been allocated to more than one job. This is most likely caused by a JES2 abend after the JES2 checkpoint processor began to replenish the TGMs but before the next checkpoint write started.

05 INVALID DATA SET KEY

The data set key field of data block numbered *nnnn* does not match the current data set key. Allocation of the same spool address to more than one data set within a multi-tasking program is most likely caused by an error within the JES2 subsystem interface.

06 OBSOLETE OUTPUT ELEMENT

JES2 selected an output element that is ineligible for processing because its corresponding data set was already purged. The probable cause for this error is that, after a JES2 failure, the spin data set was purged without the JOE being removed.

07 AUTHORIZATION FAILED

The user identification associated with the output group is not eligible to use the device that selected this group.

08 BAD I/O FOR SWBIT READ

An I/O error occurred while JES2 was reading the SWBIT(s) for a data set during print separator processing. This is probably a hardware error.

09 NO DATA SET IN THE IOT

JES2 did not find a matching data set for the job output element (JOE) in the IOT during print/punch processing. This is probably an IOT chaining error.

System action: JES2 discontinues output processing on the device.

Operator response: Notify the system programmer.

Programmer response: If RC=06, no response is necessary. Otherwise, rerun the job.

Module: HASPPRPU, HASPFSSM

Routing Code: 7

Descriptor Code: 4

\$HASP186

Explanation:

►►—*jobname*—OUTGRP=—*grpid,joeid1,joeid2*—NOT SELECTED BY—*device*—DUE TO SECURITY POLICY—◄◄

JES2 processing does not select the output group element identified by *grpid.joeid1.joeid2* on the specified device. In the message text:

jobname

The name of the job.

grpid

The group identifier. This is a 1- to 8-character alphameric name either specified by the user's JCL or generated by JES2.

joeid1

This number is assigned by JES2 and is used to uniquely identify job output elements within the output group.

joeid2

This number is assigned by JES2 and determines the number of job output elements within the output group identified by *grpid* and *joeid1*.

\$HASP190

device The device name for an output device or the *job number/procname.identifier* of the task attempting output selection through the PSO interface.

- JES2 device name for physical device (for example, PRT1)
- *job number/procname.identifier* of the requesting task for the PSO interface
- *job number/procname.identifier.threadid* of the requesting task for the SAPI interface. The SAPI application provides the *threadid*.

Note: A jobid may precede \$HASP186. See “JES2 message format” on page 1.

System action: JES2 discontinues HARDCPY processing on the device for the specified job output group element (\$JOE), and continues to scan for the next BEST JOE. JES2 remembers that the device cannot select the specified JOE and skips that JOE for the specified device until the device is restarted, JES2 is restarted, or the output group element is modified through operator commands.

If an access violation occurs, and you have DEBUG SECURITY=YES, JES2 issues this message, and RACF® issues message ICH408I and writes an SMF TYPE80 (X'50') record which includes LOGSTR information. The LOGSTR identifies the problem as either:

- JES2 DEVICE WORK SELECTION SCREENING
- EXTERNAL WRITER WORK SELECTION SCREENING
- SAPI - DATA SET ACCESS

Operator response: Notify the system programmer.

System programmer response: Select one of the following actions based on your environment set up:

- If security is intended to act as a work selection criterion and another device can select the output group element, no action is required.
- If the output group element was routed to the wrong device, modify the output to go to a device on which it can be processed using operator commands.
- If the output group element should have been selected by the device, update any security definitions or profiles for the device and restart the device.
- If you need to determine why JES2 issued this message or you are running in RACF warn mode and need to know if this message would also occur in fail mode, set DEBUG SECURITY=YES.

System programmer response: None.

Module: HASPJOS, HASPPSO

Routing Code: –

Descriptor Code: –

\$HASP190

Explanation:

▶▶—*jobname*—SETUP – —*devname*— – F=—*ffff*—
└ — C=—*cccc*—
└ — T=—*tttt*—

If *devname* specifies a punch device, the indicated job requires that the setup of that punch device be altered to forms = *ffff*. If *devname* specifies a printer device, the indicated job requires the setup be altered to forms = *ffff*, carriage control = *cccc*, and print train = *tttt*.

Note: Another version of this message follows. Use the form that corresponds to the \$HASP190 message on your console.

In the message text:

jobname

The name of the job.

devname

The name of the print or punch device.

fff The forms name.
cccc The carriage control name.
tttt The print train name.

Note: A jobid may precede \$HASP190. See “JES2 message format” on page 1.

System action: Output processing is halted on the specified device until an appropriate operator response is received.

Operator response: Verify that the requested setup has been completed and enter a start (\$S) command for the indicated device. If you want to override any or all of the setup specifications, do so with the set (\$T) command followed by a start (\$S) command. Current activity may be suspended by the restart (\$E), interrupt (\$I), and cancel (\$C) commands. In this event, all intervening set (\$T) commands are ignored and the device setup is the same as before the setup message.

System programmer response: None.

Module: HASPPRPU

Routing Code: 7

Descriptor Code: 2,4

\$HASP190

Explanation:

▶▶—*jobname*— SETUP - —*prtname*— - F=—*fff*— - O=—*name*— - B=

Y
N

▶▶

The indicated job requires that the setup of the 3800 printer device or AFP1 printer device with burster indicated by *prtname* be altered to forms = *fff*, forms overlay = *name*, and burst mode or no burst mode.

Note: JES2 only issues \$HASP190 for:

1. Channel-attached printers that are defined with PRINTER(*nnnnn*) SETUP=HALT,WS=(...F/).
2. Non-channel-attached (PSF FSS-driven printers that are SNA or TCP/IP attached) printers that are defined with PRINTER(*nnnnn*) SETUP=HALT,WS=(...F/) and with the PSF PRINTDEV statement that includes SETUP= in the PSF PROC. Be aware that this SETUP= setting is application-specific and you need to consult the appropriate user's guide before setting this value. For example, see the PSF book that documents the use of PRINTDEV SETUP=ALL | NONE | FORMS | BURST to understand which settings prompt the \$HASP190 message.

This allows JES2 to stop, issue this message, and wait until the operator verifies printer changes.

In the message text:

jobname The name of the job.
prtname The name of the printer.
fff The forms name.
name The name of the overlay.

Note: A jobid may precede \$HASP190. See “JES2 message format” on page 1.

System action: Output processing is halted on the specified device until an appropriate operator response is received. For burst mode, if the burster is not threaded, this message is repeated.

Operator response: Verify that the requested setup has been completed and enter a start (\$S) command for the indicated 3800 printer device. If you want to override any or all of the setup specifications, do so with the set (\$T) command followed by a start (\$S) command. Current activity may be suspended by the restart (\$E), interrupt (\$I),

\$HASP191 • \$HASP196

and cancel (\$C) commands. In this event, all intervening set commands are ignored, and the device setup is that before the setup message.

System programmer response: None.

Module: HASPPRPU, HASPFSSP

Routing Code: 7

Descriptor Code: 2

\$HASP191

Explanation:

▶▶—*jobname prtname*—HALTED — DATA POSSIBLY LOST—▶▶

A channel or I/O error has occurred while printing a data set. Printing does not continue until the operator takes some action, although during error recovery, JES2 may cause the data set to be printed again. In the message text:

jobname

The name of the halted job.

prtname

The name of the printer on which the job was processing.

Note: A jobid may precede \$HASP191. See “JES2 message format” on page 1.

System action: The printer *prtname* is halted until the operator takes some action. The error may have caused data to be duplicated or lost.

Operator response: Use the \$S command to restart the printer if automatic recovery is acceptable. If automatic recovery is not acceptable, use the \$B command to reposition the printer to the top of the page in error, or to a page before the page that has the error. Then use the \$S command to restart the printer. If you must be sure that the data set prints correctly, use the \$E command to reposition the printer to the beginning of the data set, and then use the \$S command to restart the printer.

System programmer response: None.

Module: HASPPRPU

Routing Code: 7

Descriptor Code: 2

\$HASP196

Explanation:

▶▶—

ERROR
ABEND

—ON—*devname*—WHILE INVOKING—*text*—▶▶

JES2 detected an error or abend during an installation exit or a scheduler JCL facility (SJF) service while printing or punching a job's output. In the message text:

devname

The name of the printer or punch.

text is one of the following:

EXIT 1 JES2 encountered a problem while Exit 1 was in control.

EXIT 15

JES2 encountered a problem while Exit 15 was in control.

SWBTUREQ RETRIEVE

JES2 was processing a scheduler JCL facility **SWBTUREQ RETRIEVE** request.

SWBTUREQ SPLICE

JES2 was processing a scheduler JCL facility **SWBTUREQ SPLICE** request.

SJFREQ SWBTUMERGE

JES2 was processing a scheduler JCL facility **SJFREQ SWBTUMERGE** request.

SWBTUREQ RETRIEVE RC=*nn*,REASON=*nnnn*

JES2 was processing a scheduler JCL facility **SWBTUREQ RETRIEVE** request. This form of the text includes a return code (RC) and a reason code.

SWBTUREQ SPLICE RC=*nn*,REASON=*nnnn*

JES2 was processing a scheduler JCL facility **SWBTUREQ SPLICE** request. This form of the text includes a return code (RC) and a reason code.

SJFREQ SWBTUMERGE RC=*nn*,REASON=*nnnn*

JES2 was processing a scheduler JCL facility **SJFREQ SWBTUMERGE** request. This form of the text includes a return code (RC) and a reason code.

System action: When *text* is **SWBTUREQ RETRIEVE** with an ERROR, JES2 stops processing the output and then purges the output. When *text* is **SWBTUREQ SPLICE**, JES2 does not insert the SWBTU into the SMF type 6 record, and processing continues. For all other cases, JES2 puts the output into hold (HOLD=SYS) and continues processing.

Operator response: See the operator response for message \$HASP197.

System programmer response: None.

Module: HASPPRPU

Routing Code: 7,10

Descriptor Code: 4

\$HASP197

Explanation:

►►—*devname*— SIMULATING \$I - —*jobid jobname*—OUTGRP=—*grpid.joeid1.joeid2*—►►

A program check occurred while device *devname* was processing the output identified in the *grpid.joeid1.joeid2* field for the indicated job. JES2 is simulating a \$I command for the device to prevent JES2 ending. In the message text:

devname

The name of the device.

jobid The job identifier.

jobname

The name of the job.

grpid The group identifier name assigned by the user or JES2.

joeid1 The number of job output elements in output group *grpid*.

joeid2 The number of job output elements in the output group identified by *grpid* and *joeid1*.

System action: JES2 puts the output in HOLD=SYS status. Recovery processing continues.

Operator response: Use the \$L command to display the status of this job output element identified by *grpid.joeid1.joeid2*. and correct the error. Use the \$TO command to put the output in REL=SYS status, or cancel the job and have the user resubmit it.

System programmer response: None.

Module: HASPPRPU

Routing Code: 7,10

\$HASP198

Descriptor Code: 4

\$HASP198

Explanation:

▶▶—REPLY TO \$HASP098 WITH—ONE OF THE FOLLOWING:—————▶▶

▶—END — STANDARD ABNORMAL END—————▶▶
▶—END,DUMP — END JES2 WITH A DUMP (WITH AN OPTIONAL TITLE)—————▶▶
▶—END,NOHOTSTART — ABBREVIATED ABNORMAL END (HOT-START IS AT RISK)—————▶▶
▶—SNAP — RE-DISPLAY \$HASP088—————▶▶
▶—DUMP — REQUEST SYSTEM DUMP (WITH AN OPTIONAL TITLE)—————▶▶

The JES2 main task encountered an error and issued message \$HASP088 to describe the error. This message lists the termination options and precedes the \$HASP098 message.

Operator response: This is only an informational message; reply to the \$HASP098 message with one of the responses above.

System programmer response: None.

Module:

HASPTERM

Routing Code: 1,2,10

Descriptor Code: 2,7

Chapter 6. Two-hundreds

The following JES2 messages are numbered in the 200-299 range.

\$HASP200

Explanation:

▶▶—RMTnnnn—└──────────┘—STARTED ON LNE1na—└──────────┘—SESSION—zzzzzzzz—└──────────┘—NODE—nodename—└──────────┘—BFSZ=—size—▶▶

A remote workstation or JES2 NJE node has appropriately identified itself to JES2. If RMTnnnn is an SNA remote workstation, the message indicates the session zzzzzzzz and the node nodename the workstation is on. If RMTnnnn is a BSC remote workstation, the message indicates the node nodename the workstation is on.

For JES2 NJE, if the line is an SNA line, the message indicates the session by using the application name zzzzzzzz. If the line is a BSC or TCP/IP line, the message indicates the line number the NJE node is on.

BFSZ is the specified, calculated, or negotiated transmission buffer size, as appropriate. For information about transmission buffer sizes, see the descriptions of the TPDEF BSCBUF and SNABUF parameters in *z/OS JES2 Initialization and Tuning Reference*.

In the message text:

nnnn The number of the remote workstation.

lna The line number (up to 5 digits).

nodename

The name of the node.

zzzzzzzz

The name of the session.

size The transmission buffer size.

System action: Job processing activity is initiated with the remote workstation or JES2 NJE node.

Operator response: None.

Module: HASPSNA, HASPBSC, HASPTCP

Routing Code: 8

Descriptor Code: 4

\$HASP201

Explanation:

▶▶—LINExxx— – INVALID PASSWORD—rmtname—▶▶

An operator at a remote workstation attempted to sign on the specified line with an incorrect password.

In the message text:

xxx The number of the line.

rmtname

Specifies the name of the remote workstation asking to sign on.

System action: The attempt to sign on is not allowed, and the line is left in an INACTIVE status.

Operator response: The remote workstation operator should determine the valid password and attempt to sign on again.

Module: HASPBSC

\$HASP202 • \$HASP203

Routing Code: 8

Descriptor Code: 4

\$HASP202

Explanation:

▶▶—LINExxx— – INVALID SIGN-ON—*rmtname*—▶▶

A remote workstation specified on the signon has insufficient authorization, or a remote workstation operator attempted to sign on to the specified line with a signon card that is not valid. A signon card is not valid if any of the following are true:

- The remote workstation name is spelled incorrectly. The numbers must be left-justified with no leading zeros.
- The remote workstation name specified has not been generated.
- The remote workstation name specified is attached to another line.
- The remote workstation name does not begin in column 16.
- The signon statement was received from a remote BSC workstation followed by other data in the same transmission. For a remote BSC workstation, the signon statement must be received in a transmission by itself.

Note: Failure to comply with the above can result in a \$HASP202 message after receiving \$HASP200 and after correctly processing a valid signon statement. The signon card must be the only one in the reader with the end-of-file on. If the signon card is from a diskette, then the same end-of-file must be simulated.

In the message text:

xxx The number of the line.

rmtname

Specifies the name of the remote workstation asking to sign on.

Note: The remote name will be added to this message only in the case of authorization failure, not for the case of a bad signon card.

System action: The attempted signon is not allowed, and the line is left in an INACTIVE status.

Operator response: The remote workstation operator should verify the spelling of the name. If the remote workstation is attached to another line, steps should be taken to correct this conflict in assignments. Notify the system programmer to determine if the remote workstation has sufficient authority.

System programmer response: Contact the security administrator to determine whether the remote workstation should be authorized for signon. If so, update the appropriate profiles and notify the operator that signon may be retried.

Module: HASPBSC

Routing Code: 8,9

Descriptor Code: 4

\$HASP203

Explanation:

▶▶— RMTnnnn—DISCONNECTED{—
└—*nodename*—┘ └—FROM LINE1na—DISCINTV EXCEEDED—┘▶▶

The specified node or remote workstation that was previously active has been disconnected. If the node or remote workstation was connected to a BSC line, the line is displayed in the message.

In the message text:

nnnn The number of the disconnected remote workstation.

nodename
The name of the disconnected node.

lna The number of the line.

System action: If the line is still active, JES2 prepares for a new connection, otherwise, the line goes into DRAINED status.

Operator response: None.

Module: HASPSNA, HASPBSC, HASPTCP

Routing Code: 8,10

Descriptor Code: 4

\$HASP204

Explanation:

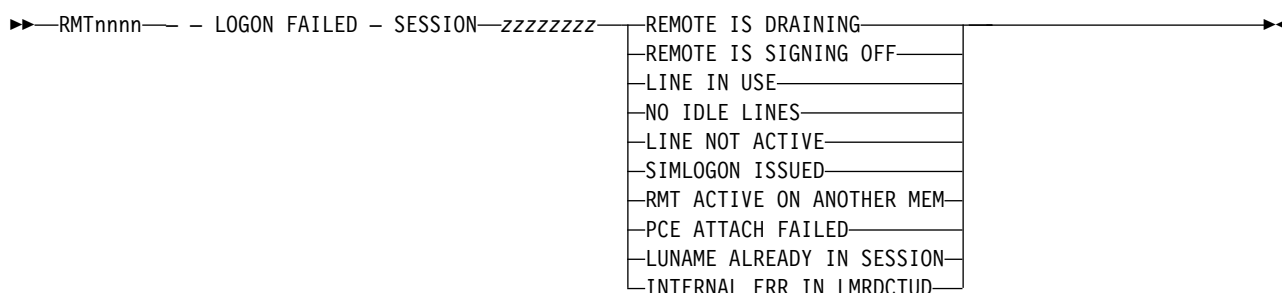

SNA remote workstation RMTnnnn attempted to logon. Either there was no line DCT for that workstation or RMTnnnn is logged on to another member. In the message text:

nnnn The number of the remote workstation.

zzzzzzzz
The session name.

text is one of the following:

REMOTE IS DRAINING
The line is being drained.

REMOTE IS SIGNING OFF
The line is currently signing off the connection.

LINE IN USE
The line is in use by another node.

LINE NOT ACTIVE
The line associated with the remote being started is not currently active. Issue the \$S LINE command for the line specified on the RMTnnnn statement.

NO IDLE LINES
There are no idle lines available.

SIMLOGON ISSUED
JES2 is simulating a logon for this logical unit (LU).

RMT ACTIVE ON ANOTHER MEM
The logon request for this remote is active on another member.

PCE ATTACH FAILED
A failure occurred when JES2 tried to attach the processor control element for this remote.

\$HASP205 • \$HASP206

LUNAME ALREADY IN SESSION

The specified logical unit is already in session with the remote. A second session with the same LU name is not permitted.

INTERNAL ERR IN LMRDCTUD

An internal error was encountered in the \$RAT, \$DCT or the \$DCT chain.

System action: The attempted logon is not allowed, and the remote workstation is not connected.

Operator response: If there is no line DCT for RMT $nnnn$, the network operator should start a logical line so that the remote workstation operator can log on. If RMT $nnnn$ is logged on to another member, RMT $nnnn$ cannot logon to this member.

System programmer response: None.

Module: HASPSNA

Routing Code: 8,10

Descriptor Code: 4

\$HASP205

Explanation:

►►—LOGONxxx— – INVALID LOGON – – SESSION—*sessname rmtname*—►►

An SNA remote workstation attempted to log on, but failed for one of the following reasons:

- The remote workstation was already logged on.
- The logon contained an incorrect RMT number.
- The logon contained an incorrect remote password.
- The logon contained an incorrect line password.
- The syntax of the logon data was not valid.
- The remote workstation specified on the signon has insufficient authority.

In the message text:

xxx The number of the logon.

sessname

The session name.

rmtname

Specifies the name of the remote workstation asking to sign on.

System action: The attempted logon is not allowed; the remote workstation is not connected.

Operator response: If the logon was incorrect, correct it and try to log on again. Notify the system programmer to determine if the remote workstation has sufficient authority to sign on.

System programmer response: Contact the security administrator to determine whether the remote workstation should be authorized for signon. If so, update the appropriate profiles and notify the operator that signon may be retried.

Module: HASPSNA

Routing Code: 8,9,10

Descriptor Code: 4

\$HASP206

Explanation:

▶▶—LOGON—BIND—FAILED FOR—*luname*— —MAXSESS EXCEEDED—SESSION DRAINING—▶▶

The logon of a SNA remote device or bind of a JES2 NJE remote node is prohibited. The VTAM LUNAME involved is displayed.

If the reason displayed is MAXSESS EXCEEDED, the problem is that all resources allocated for SNA sessions have been exhausted. The number of sessions is specified on the TPDEF SESSIONS=(LIMIT=) initialization statement. One session is used for each VTAM logical unit (LU) that is communicating with JES2. Also, sessions can be marked permanently in use during error processing.

If the reason displayed is SESSION DRAINING, the specified logical unit (LU) attempted to establish a session with JES2 before JES2 had completed terminating a previous session with the same logical unit. This can occur when an LU logs off and then immediately logs back on, or when a failure occurs as the LU is signing on.

System action: The attempted logon is not allowed. The remote workstation or NJE node is not connected.

Operator response: If the session was draining, retry the signon after JES2 has been given a chance to complete the signoff. If the problem persists, contact your system programmer. If there are not enough sessions, log off any unneeded connections, use the \$T TPDEF SESSIONS=(LIMIT=) operator command to increase the number of available sessions, and restart the operation.

System programmer response: Verify that there are sufficient resources allocated during initialization for all sessions that may be used plus extra to handle error cases.

Module: HASPSNA

Routing Code: 8,10

Descriptor Code: 4

\$HASP207

Explanation:

▶▶—RMTnnnn— – AUTOLOGON FAILED—▶▶

An attempt to automatically log on to this SNA remote terminal has failed for one of the following reasons:

- The VTAM SIMLOGON request failed (see \$HASP092). The key code is hexadecimal 16.
- LUNAME is not specified for this SNA remote terminal.

In the message text:

nnnn The number of the remote terminal.

System action: Automatic logon mode (A=Y) is reset to A=N.

Operator response: Re-initiate the automatic logon (with the \$\$ Rnnnn or \$T Rnnnn, A=Y commands) after the cause of the failure has been fixed.

Module:

HASPSNA

Routing Code: 8,10

Descriptor Code: 4

\$HASP208

Explanation:

▶▶—*event*—SCHEDULED FOR—*luname*—RC=—*xx*—NSEXIT SCHEDULED FOR—*luname*—CLEANUP,—*xx*—▶▶

▶—NSEXIT SCHEDULED FOR—*luname*—NOTIFY,—*tt*,—*rr*,—*sssssss*—▶▶

A system network architecture (SNA) event *event* occurred requiring that the specified session be ended. Not all SNA events have an associated reason code. Additional diagnostic information is provided for an NSEXIT. If the SNA

\$HASP209

event has a reason code, the reason code is defined by *xx*. See *z/OS V2R1.0 Communications Server: SNA Programming* for an explanation of the hexadecimal reason codes. Possible values of the SNA event and the explanation of each are:

Event	Explanation
-------	-------------

TPEND	
--------------	--

	VTAM TPEND exit (terminal pending)
--	------------------------------------

	Reason code provided: Yes
--	---------------------------

LSTRM	
--------------	--

	VTAM LOSTERM exit (lost terminal services)
--	--

	Reason code provided: Yes
--	---------------------------

UNBND	
--------------	--

	VTAM SCIP exit (unbind)
--	-------------------------

	Reason code provided: No
--	--------------------------

RQRVY	
--------------	--

	VTAM SCIP exit (request recovery)
--	-----------------------------------

	Reason code provided: No
--	--------------------------

NSXIT	VTAM NSXIT exit (network services)
--------------	------------------------------------

	Reason code provided: See below
--	---------------------------------

There are 2 types of NSEXITs scheduled by VTAM: CLEANUP and NOTIFY.

For CLEANUP requests, in the message text:

xx The reason code indicating how the session was taken down.

For NOTIFY requests, in the message text:

tt The status byte.

rr The associated reason code if the status byte is a procedure error (03).

ssssssss

The associated sense data if the status byte is a procedure error (03).

System action: JES2 ends the affected sessions. Message \$HASP210 provides additional information.

Operator response: None.

System programmer response: If the termination is unexpected, examine any VTAM messages related to the session that terminated.

Module: HASPSNA

Routing Code: 8,10

Descriptor Code: 4

\$HASP209

Explanation:

▶▶—SESSION SYMBOL=—zzzzzzzz—STARTED ON LINE|na—BFSZ=—size—▶▶

Another session has started for the SNA remote workstation on this line. BFSZ is the specified, calculated, or negotiated transmission buffer size, as appropriate.

In the message text:

zzzzzzzz

The session name.

lna The line number.

size The transmission buffer size.

System action: The additional session may be used to communicate with the SNA remote workstation.

Operator response: None.

Module: HASPSNA

Routing Code: 8

Descriptor Code: 4

\$HASP210

Explanation:

▶▶—SESSION—zzzzzzzz—LOGGED OFF LINElna—▶▶

Session *zzzzzzzz* has ended for the SNA remote terminal on this line.
In the message text:

zzzzzzzz

The session name.

lna The line number.

System action: The remaining sessions are used to communicate with this SNA remote terminal. When the last session for a SNA remote terminal is ended, a \$HASP203 message is displayed.

Operator response: None.

Module: HASPSNA

Routing Code: 8

Descriptor Code: 4

\$HASP211

Explanation:

▶▶—*jobname devname*—COMPACTION TABLE—*xxx*—NOT FOUND—▶▶

The specified compaction table was not defined during JES2 initialization.
In the message text:

jobname

The name of the job.

devname

The name of the device.

xxx The number of the missing compaction table.

Note: A jobid may precede \$HASP211. See “JES2 message format” on page 1.

System action: The data is sent to the specified SNA remote device in un-compacted form.

Operator response: None.

Module: HASPSNA

Routing Code: 7,8

Descriptor Code: 4

\$HASP212 • \$HASP214

\$HASP212

Explanation:

▶▶—SNA CRITICAL ERROR ON—*zzzzzzzz*—▶▶

On the identified session, an unrecoverable system network architecture (SNA) error occurred in an SNA request parameter list (RPL)-based request or response.

In the message text:

zzzzzzzz

The name of the session.

System action: JES2 ends the session. Messages \$HASP094 and \$HASP210 provide further information.

Operator response: The V NET,INACT command may be necessary to remove the session from VTAM.

Module: HASPSNA

Routing Code: 8,10

Descriptor Code: 4

\$HASP213

Explanation:

▶▶—INVALID DATA RECORD RECEIVED—FROM—*applid*—▶▶

JES2 received an incorrect data record from *applid* in an SNA session.

In the message text:

applid The VTAM application identifier of the node.

System action: JES2 restarts the line (as if a \$E LNE(nnnn) command was entered) resulting in the end of the SNA session by a close destination (CLSDST).

System programmer response: Examine incoming data buffers on this line to determine if the session partner is violating SNA protocols.

Module: HASPSNA

Routing Code: 8,10

Descriptor Code: 4

\$HASP214

Explanation:

▶▶—LINE1na— – SIGNON FAILED,—UNABLE TO INITIATE SAF REQUEST—▶▶

JES2 was unable to obtain sufficient storage for the control blocks needed to initiate a security authorization facility (SAF) request to verify the signon of an RJE terminal.

In the message text:

lna The line number.

System action: JES2 stops the remote terminal signon.

Operator response: Notify the operator of the system trying to sign on that the attempt failed and to try to sign on later. If the condition persists, notify the system programmer.

System programmer response: Determine why there is insufficient storage in the JES2 address space and correct the problem. Failed logon attempt will be brought to the security administrator's attention. Contact the operator when the problem is corrected.

Module: HASPSNA, HASPBSC

Routing Code: 8,9

Descriptor Code: 4

\$HASP215

Explanation:

▶▶—NEW PASSWORD IGNORED—▶▶

RJE password checking was performed by JES2 (instead of by RACF or another security product). The new password field on the /*SIGNON statement or the VTAM LOGON command is ignored.

System action: The RJE signon/logon continues normally.

Operator response: The former password remains in effect.

Module: HASPSNA, HASPBSC

Routing Code: #

Descriptor Code: –

\$HASP216

Explanation:

▶▶—LINE1na—lna—NOT STARTED – UNABLE TO INITIATE—RMTnnnn—
 └SAF REQUEST└▶▶

JES2 was not able to obtain enough storage to initiate a security authorization facility (SAF) request to obtain information about the associated remote workstation.

In the message text:

lna The line number.

nnnn The number of the remote workstation.

System action: The line is left drained or the remote workstation remains unstarted.

Operator response: Attempt to start the line or remote workstation again. If the condition persists, notify the system programmer.

System programmer response: Determine why there is insufficient storage in the JES2 address space and correct the problem. Failed logon attempt will be brought to the security administrator's attention. Contact the operator when the problem has been corrected.

Module: HASPBSC, HASPSNA

Routing Code: 8,9

Descriptor Code: 4

\$HASP217

Explanation:

▶▶—command— – UNABLE TO VALIDATE COMMAND—▶▶

JES2 at the receiving node was not able to obtain enough storage to initiate a request to the security product to validate the origin of the command.

In the message text:

command

The text of the command.

\$HASP218 • \$HASP219

System action: The receiving node ignores the command. (This message is issued to the operator at the issuing node only.)

Operator response: Reenter the command. If the condition persists, notify the system programmer at the receiving node.

System programmer response: Determine why there is insufficient storage in the JES2 address space and correct the problem. Notify the operator at the issuing node that the command can be reentered.

Module: HASPRTAM

Routing Code: 8

Descriptor Code: 4

\$HASP218

Explanation:

▶▶—HASPVTAM SUBTASK NOT AVAILABLE—▶▶

A \$S LOGON(n) command was entered when the HASPVTAM subtask was not active. Either JES2 failed to attach the subtask during initialization or the HASPVTAM subtask has ended.

System action: Processing of the \$S LOGON(n) command stops. Other JES2 processing continues.

Operator response: Notify the system programmer. JES2 requires a hot start to attach the HASPVTAM subtask. You may then reenter the \$S LOGON(n) command.

System programmer response: Examine SYSLOG to determine whether the subtask stopped or failed to be attached during JES2 initialization.

Module:

HASPSNA

Routing Code: 8

Descriptor Code: 4

\$HASP219

Explanation:

▶▶—*jobname*—CANNOT BE CANCELLED—▶▶

The operator has entered a \$C command for a job that is executing on another member. JES2 tried to cancel the job, but the job is currently marked non-cancelable by MVS. The message is issued and the command ignored. No MVS CANCEL command is issued.

In the message text:

jobname

The name of the job.

Note: A jobid may precede \$HASP219. See "JES2 message format" on page 1.

System action: The command is ignored for the specified job and processing continues.

Operator response: None.

Module:

HASPCOMM

Routing Code: 1,2,10

Descriptor Code: 4

\$HASP220

Explanation:

▶▶—*nodename*—STARTED DOES NOT MATCH APPL—(*applname*)—NODE=—*nodenum*—▶▶

A SNA network connection has been made with node *nodename*. This application *applname* is defined to JES2 with a node *nodenum* specified that is different than the node *nodename* that is started.
In the message text:

nodename

The node name of the started node in the network connection.

applname

The VTAM application name used on the network connection.

nodenum

The node number defined on the APPL definition if the network connection is correct.

System action:

Operator response: Contact the system programmer.

System programmer response: Ensure that the application definitions defined to JES2 on the APPL(avvvvvvv), LOGON(n), and N(nnnn) definitions are the same as those defined to VTAM and all other JES2 NJE nodes in the network. If they are not, correct the definitions in error. Determine if the network connection is correct, and if not, stop and restart the network connection.

Module: HASPSNA

Routing Code: 1,2,8,10

Descriptor Code: 4

\$HASP221

Explanation:

▶▶—BIND RECEIVED FROM—*applid*—REJECTED —

NO IDLE LINES AVAILABLE, RC=01
DEDICATED LINE LINE1na IS NOT AVAILABLE, RC=02
APPLID NOT DEFINED, RC=03
NETWORK PATH MANAGER IS NOT AVAILABLE, RC=04

▶▶

A BIND RU has been received from another NJE node attempting to establish a session with the local node. The BIND cannot be accepted because JES2 could not locate a qualifying SNA line device control table (DCT).
In the message text:

applid The VTAM application identifier of the node.

The texts have the following meanings:

- **NO IDLE LINES AVAILABLE, RC=01**
No qualifying lines in the SNA idle line DCT.
- **DEDICATED LINE LINE1na IS NOT AVAILABLE, RC=02**
Dedicated line number *lna* is not in the SNA idle line DCT.
Dedicated line number *lna* is also dedicated to an RJE device (RMT5,LINE=5).
Dedicated line number *lna* is in disconnect process (draining).
Dedicated line number *lna* has a "password" set on it.
User has multiple SNA paths to NODE5 and has set the node for the dedicated line instead of setting the associated APPL statement for a dedicated line.
- **APPLID NOT DEFINED, RC=03**
Application not defined by an APPL(avvvvvvv) statement.
- **NETWORK PATH MANAGER IS NOT AVAILABLE, RC=04**

\$HASP222 • \$HASP223

JES2 could not start the connect because the network path manager PCE failed. JES2 issues \$HASP502 to indicate this condition.

System action: The BIND is rejected.

Operator response: Start a qualifying SNA line with the \$S command and have the other node reenter the \$SN command or enter the \$SN command locally to start networking with *applid* specified in the message text.

System programmer response: For RC=02, reason 1, 2, or 3, this line cannot be used for SNA/NJE line dedication. Another line must be used. For RC=02, reason 4, turn off the password to this line or use another line. For RC=02, reason 5, dedicate the line on the APPL definition instead of the NODE definition. For RC=03, ensure that the application names defined to JES2 NJE with the APPL(*avvvvvvv*) or N(*nnnn*) initialization parameters are the same as those defined to VTAM and all other JES2 NJE nodes in the network. If not, correct the APPL(*avvvvvvv*) or N(*nnnn*) statement in error and retry starting networking to the node.

Module: HASPSNA

Routing Code: 8,10

Descriptor Code: 4

\$HASP222

Explanation:

▶▶—XEQ DRAINING—◀◀

JES2 issues this message in response to a \$P XEQ command.

System action: JES2 selects no more jobs for execution on this member. This message is non-deletable.

Operator response: To resume job selection by this member, issue \$S XEQ.

System programmer response: None

Module: HASPCOMM

Routing Code: 8,10

Descriptor Code: 4

\$HASP223

Explanation:

▶▶—NJE UNABLE TO SIGN ON TO—*nodename,reason*—◀◀

The NJE signon to node *nodename* was unable to be processed. Valid reasons include:

LINE IS DRAINED

The line being used is drained and could not be started.

LINE IS BUSY

The line being used is already in session.

SYSTEM RESOURCE SHORTAGE <NETDCTS|BUFFERS>

A resource shortage exists.

INTERNAL ERROR

An internal error occurred.

NETWORK PATH MANAGER NOT AVAILABLE

The network path manager previously ABENDED and is not available, a restart of JES2 is required.

SIGNON ENCRYPTION KEY NOT FOUND

A secure NJE signon was attempted, but the encryption key could not be found in the RACF database.

APPCLU CLASS INACTIVE

A secure NJE signon was attempted, but the APPCLU class is not active.

System action: The NJE connection does not start.

Operator response: If the line is drained or busy, ensure that the setup is correct and retry the connection. For resource shortages, try the command later and notify the system programmer that the condition exists. If the network path manager is not available, a restart of JES2 is required to start the connection.

System programmer response: For resource shortages, you may need to increase the value for NJEDEF LINENUM= or TPDEF SNABUF=LIMIT=. For secure signon failures, contact the security administrator to ensure that the correct SESSKEY was provided for the NJE.node1.node2 profile in the APPCLU class, and that the APPCLU class is active.

Module: HASPSNA, HASPNPM

Routing Code: 1,2,8,10

Descriptor Code: 4

\$HASP224

Explanation:

▶▶—INVALID COMPACTION SCB—RECEIVED FROM—*applid*————▶▶

A compaction string control byte has been found in a data record received on the identified NJE session. No compaction table currently exists for this session.

In the message text:

applid The VTAM application identifier of the node.

System action: The line is restarted (as if a \$E LINE(nnnn) command was entered) resulting in the SNA application-to-application session being stopped by a CLSDST from the primary node.

System programmer response: Examine incoming data buffers on this line to determine if the session partner is violating JES2 NJE protocols.

Module: HASPSNA

Routing Code: 8,10

Descriptor Code: 4

\$HASP225

Explanation:

▶▶—INVALID JOB/SYSOUT DATA RECORD—RECEIVED FROM—*applid*————▶▶

A job or SYSOUT data record was received on the indicated session for an idle or nonexistent receiver.

In the message text:

applid The VTAM application identifier of the node.

System action: The line is restarted (as if a \$E LINE(nnnn) was entered) resulting in the SNA application-to-application session being stopped by a CLSDST from the primary node.

System programmer response: Ensure that the session partner is not violating JES2 NJE protocols.

Module: HASPSNA

Routing Code: 8,10

Descriptor Code: 4

\$HASP226

Explanation:

\$HASP227 • \$HASP228

▶▶—INVALID STREAM ALLOCATION REQUEST—RECEIVED FROM—*applid*—▶▶

A control record requesting allocation of a job/SYSOUT stream has been received on the indicated session. The identified receiver is already in use.

In the message text:

applid The VTAM application identifier of the node.

System action: The line is restarted (as if a \$E LINE(nnnn) command was entered) resulting in the SNA application-to-application session being stopped by a CLSDST from the primary node.

System programmer response: Take steps to ensure that the session partner is not violating JES2 NJE protocols.

Module: HASPSNA

Routing Code: 8,10

Descriptor Code: 4

\$HASP227

Explanation:

▶▶—LINE1na—SIMULATING \$E—▶▶

JES2 has detected more channel end indications than expected for the BSC RJE line identified in the message text (JES2 error code \$M01). JES2 is simulating a \$E command for the line to prevent JES2 ending.

In the message text:

lna The number of the line.

System action: JES2 recovery processing continues.

Operator response: None.

Module:

HASPBSC

Routing Code: 8,10

Descriptor Code: 4

\$HASP228

Explanation:

▶▶—LINE1na—NOT STARTED – RMTnnnn—IS ALREADY ON MEMBER—*memname*—▶▶

The operator has entered a \$S command for the indicated line or a range of lines that included the identified line. Because LINE=*nnnn* was specified on the RMT(*nnnn*) initialization statement, a \$S LINE(*nnnn*) command implies a start for RMT(*nnnn*). RMT*nnnn* is already logged on to member *memname* in the message.

In the message text:

lna The number of the line.

nnnn The number of the remote workstation.

memname

The member name.

System action: Processing continues with the identified line remaining drained.

Operator response: If RMT*nnnn* is to be logged onto this member, you must first log it off the identified member. This can be done by entering a \$P command for the line it is using on that member, then entering the \$S LINE(*nnnn*) command for the line you want to start.

Module: HASPSXDV

Routing Code: 1,2,10

Descriptor Code: 4

\$HASP229

Explanation:

▶▶—RMTnnnn—INPUT DATA INVALID ON LINElna—————▶▶

The input data stream did not contain a valid record control byte (RCB). If the number of messages becomes excessive, there could be a line or remote terminal problem.

In the message text:

nnnn The number of the remote workstation.

lna The number of the line.

System action: Processing continues. The current data is purged and the line is restarted.

Operator response: Notify the system programmer.

System programmer response: Determine the source of the incorrect data. A probable cause of this error is a hardware problem. If this is true, contact your hardware support personnel.

Module: HASPBSC

Routing Code: 8

Descriptor Code: 4

\$HASP230

Explanation:

▶▶—UNDEFINED RCB/SRCB -- Rnnnn—.RDm—————▶▶

The specified remote sent JES2 a request to begin the input function for an input device. However, the record control byte (RCB)/sub-record control byte (SRCB) received from the remote does not match any of the devices defined to JES2 for that remote.

In the message text:

nnnn The remote number.

m The reader number.

System action: JES2 ignores the control record containing the undefined RCB/SRCB. Other active functions for the specified remote are not affected.

Operator response: Notify the system programmer.

System programmer response: Check the JES2 initialization statements that define this remote and its associated devices to ensure that the number of devices defined to JES2 matches the number of devices actually attached to the remote or defined to the remote software.

Module: HASPBSC

Routing Code: 8

Descriptor Code: 4

\$HASP231

Explanation:

▶▶—PATH—(node)—STATUS=—(connection),—REST=—nnnnn,—PATH=—(node1, node2, node3,..., noden)—————▶▶

\$HASP232

JES2 issues this message in response to a \$D PATH(*noden*) command. JES2 lists the nodes in the path from the node on which the command is entered to the target node, *noden*, named in the command.

In the message text:

connection

UNCONNECTED

This system cannot reach the target node at this time.

LOCAL NODE

The target node is the local node.

THROUGH LINE*nnnnn*

The path to the target node goes through line *nnnnn*.

THROUGH MEMBER *memx*

The path to the target node begins with member *memx* in this multi-access spool configuration.

PENDING *nnnnnnnn-Mnnnn*

There is no active line to the target node even though static connections describe a path to the target.

AWAITING RESET WITH *node*

The primary trunk of a multi-trunk connection to *node* has gone down and the new primary is in the process of being established.

SIGNING ON LINE*nnnn*

The path to the target node will be through line *nnnn* as soon as the current signon completes.

nnnnn The resistance of the entire path.

node1 The node on which the \$D PATH(*noden*) command was entered.

node2, node3

The names of the nodes in the path between *node1* and *noden*.

Subnets are displayed in the following manner:

nodeX, ..., nodeY

In the example:

nodeX The name of the gateway node that connects the subnet to the node preceding the subnet in the path.

nodeY The name of the gateway node that connects the subnet to the node following the subnet in the path.

noden The name of the node that was specified in the \$D PATH(*noden*) command.

System action: The system continues processing.

Operator response: To activate a path to the target node, you must enter a \$S LINE(*nnnn*) command to node *nnnnnnnnn* on member *mmm*.

Module:

HASCSCAN

Routing Code: 1,2,10

Descriptor Code: 4

\$HASP232

Explanation:

►►—*cmdmsg*—COMMAND TEXT TOO LONG——ORIGINATED BY NODE—*nodename*—◄◄

A command received by JES2 to be issued on a node is greater than the text length allowed. The optional section

appears in situation when message cannot be sent to the command originator and is sent to this system console instead, the originator is known, and the originator is not this node.

In the message text:

cmdmsg

The first nine bytes of the command.

nodename

The node name of the originator.

System action: JES2 returns the command to the issuer and processing continues.

Operator response: Reissue the command with a valid text length.

Module:

HASPRAM, HASPCON

Routing Code: –

Descriptor Code: –

\$HASP233

Explanation:

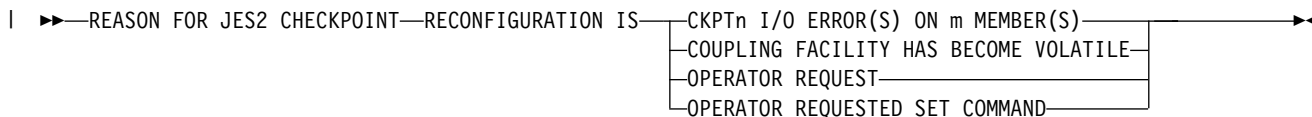

This message indicates the reason JES2 is performing this checkpoint reconfiguration thereby determining the available reconfiguration processing options. If members simultaneously enter a reconfiguration for different reasons, JES2 determines the reason displayed in this message using the following order of precedence:

1. I/O on CKPT1
2. I/O on CKPT2
3. Coupling facility becomes volatile
4. Operator request

CKPTn I/O ERROR(S) ON m MEMBERS

JES2 initiated a checkpoint reconfiguration because of I/O error(s) on a coupling facility structure or data set on *m* members. \$HASP275 (issued by one or more members) accompanies this message and provides the specific member and reason code. (\$HASP275 might be displayed on a different console based on your installation's MSCOPE specification on the CONSOLxx parmlib member. See *z/OS MVS Initialization and Tuning Guide* for a description of the MSCOPE parameter. See *z/OS JES2 Initialization and Tuning Guide* for a complete explanation of checkpoint reconfiguration processing and examples of various checkpoint reconfiguration dialogs.

In the message text:

- n* Either 1 or 2 indicating CKPT1 or CKPT2, respectively.
- m* The number of members encountering I/O errors on CKPTn when JES2 first determined the reason for this checkpoint reconfiguration.

COUPLING FACILITY HAS BECOME VOLATILE

The coupling facility on which a checkpoint resides became volatile and JES2 entered a checkpoint reconfiguration as a result of processing based on your CKPTDEF VOLATILE= specification.

Note: A coupling facility is always considered volatile unless you have taken measures to protect against the loss of power to that coupling facility. See *ES/9000 and ES/3090 PR/SM Planning Guide* for a description of how to monitor the volatility of coupling facilities.

OPERATOR REQUEST

JES2 entered this reconfiguration following your request to begin a checkpoint reconfiguration with a \$T CKPTDEF,RECONFIG=Yes command. (The blank between \$T and CKPTDEF is optional.)

\$HASP234

OPERATOR REQUESTED SET COMMAND

JES2 entered this reconfiguration following your request to alter the current CKPT1 or CKPT2 specifications using the \$T CKPTDEF command. If there is a problem making the requested changes, the reconfiguration is failed.

System action: JES2 checkpoint reconfiguration processing continues, and JES2 (re)issues message \$HASP285 with either STARTED or RE-SYNCHRONIZING.

\$HASP233 is issued to a console by the driving member and also issued to HRDCPY by non-driving members for diagnostic purposes.

Operator response: Monitor subsequent checkpoint reconfiguration messages and follow any further instructions as appropriate. Follow-on checkpoint reconfiguration messages will inform you of ongoing status.

System programmer response: None.

Module:

HASPCCKDS

Routing Code: 1,2,10,42

Descriptor Code: 2,7

\$HASP234

Explanation:

▶▶—MEMBER—*member-name*—UNABLE TO RECONFIGURE AS REQUESTED—BY THE DRIVING MEMBER—▶▶

The driving member is able to perform a requested reconfiguration action; however, member *member-name* (a non-driving member) is unable to perform the same action. A specific reason for the non-driving member's inability to perform the action appeared in a previous message (such as \$HASP295, \$HASP296, \$HASP297, \$HASP414, \$HASP424, \$HASP429, \$HASP453, \$HASP536, \$HASP542, and \$HASP581). For example, the checkpoint may have been forwarded to a data set on a volume that is not mounted on the system where the non-driving member resides. In this case, you receive \$HASP424 followed by \$HASP234.

System action: This message is issued by both the non-driving member that encountered the error and the driving member.

- On the non-driving member, the message is written to HRDCPY only.
- On the driving member, the message is written to a console to indicate which member encountered the error.

JES2 then issues message \$HASP235.

Operator response: Search the SYSLOG of the indicated *member* for previous messages such as \$HASP424 that provide details of the error condition. The search is unnecessary if you were aware of the previous error messages. Determine if the problem can be corrected by a simple action such as a vary command to bring a volume on line on the system on which the member resides. If such an action corrects the problem, you then need to attempt the same reconfiguration action when presented with the \$HASP271/\$HASP272 or \$HASP273/\$HASP272 message pair. If you need to forward CKPTn, you must now reply CKPTDEF with operands and specify NEWCKPTn. Otherwise, select an alternative action in response to \$HASP272.

System programmer response: None.

Module:

HASPCCKDS

Routing Code: 1,2,10,42

Descriptor Code: 4

\$HASP235

Explanation:

►►—*n*—MEMBERS UNABLE TO RECONFIGURE—┌ — OPERATOR ASSISTANCE REQUESTED ─┐—————►►

This message informs the operator that *n* members are unable to reconfigure. This message is preceded by *n* \$HASP234 messages.

The optional text, OPERATOR ASSISTANCE REQUESTED, is only displayed when there was no prior operator involvement in this checkpoint reconfiguration because CKPTDEF OPVERIFY=NO is in effect.

In the message text:

n The number of members that encountered I/O errors on CKPT*n* when the \$HASP235 message was first issued for this checkpoint reconfiguration.

System action: This message is followed by \$HASP271 or \$HASP273 and the corresponding \$HASP272 ENTER RESPONSE message. This message is highlighted and not deleted until you reply to \$HASP272.

Operator response: Search each member's SYSLOG for the *n* \$HASP234 messages. This search is unnecessary if you were aware of the previous error messages.

System programmer response: Wait for follow-on messages \$HASP271 or \$HASP273.

Module:

HASPCCKDS

Routing Code: 1,2,10,42

Descriptor Code: 2,7

\$HASP236

Explanation:

►►—JES2 CHECKPOINT RECONFIGURATION—DRIVING MEMBER—*member-name*—FAILED—————►►

During a checkpoint reconfiguration, the driving member *member-name* failed.

The message is issued by the new driving member and is issued to the hardcopy log on all other members for diagnostic purposes.

System action: The remaining member with the most-current checkpoint data becomes the new driving member. The new driving member issues \$HASP233 followed by message \$HASP285 indicating the members participating in the reconfiguration are STARTED or RE-SYNCHRONIZING. Message pair \$HASP271/\$HASP272 or \$HASP273/\$HASP272 are reissued if necessary.

Processing continues.

Operator response: None.

System programmer response: None.

Module:

HASPCKRR

Routing Code: 1,2,10

Descriptor Code: 4

\$HASP237

\$HASP237

Explanation:

→ CKPT_n — *strname* — IS ON A VOLATILE COUPLING FACILITY — VALID RESPONSES ARE: — *response* →
 └─NEWCKPT_n┘

The message *response* can be one of the following:

'CONT' - PROCEED WITH ASSIGNMENT
'CANCEL' - EXIT FROM RECONFIGURATION
'TERM' - TERMINATE MEMBERS WITH I/O
ERROR ON CKPT_n
'DELETE ' - DISCONTINUE USING CKPT_n
CKPTDEF (NO OPERANDS) - DISPLAY
MODIFIABLE SPECIFICATIONS
CKPTDEF (WITH OPERANDS) - ALTER
MODIFIABLE SPECIFICATIONS

| During a checkpoint reconfiguration, JES2 detects that the selected checkpoint *strname* is on a volatile coupling
| facility. The current CKPTDEF VOLATILE= settings does not allow this situation to be ignored. The message is
| informing the operator and requesting permission to continue with the assignment. This situation is considered an
| error (based on the installation VOLATILE= setting) and will require an operator response even if OPVERIFY=NO.

Not all of the options appear for a given instance of this message.

Note: A coupling facility is always considered volatile unless you have taken measures to protect against the loss of power to that coupling facility. See *ES/9000 and ES/3090 PR/SM Planning Guide* for a description of how to monitor the volatility of coupling facilities.

In the message text:

CKPT_n The checkpoint that JES2 is attempting to resume using.

NEWCKPT_n

The checkpoint to which JES2 is attempting to forward CKPT_n.

strname The structure name (STRNAME) of the coupling facility structure used for this checkpoint.

System action: JES2 issues message \$HASP272 and waits for an operator response.

JES2 issues \$HASP237 instead of any processing based on the CKPTDEF VOLATILE= specification.

Operator response: Determine the action you want to take and respond to message \$HASP272 with one of the options described below. Not all of the options appear for a given instance of this message.

Option Meaning

CONT JES2 uses the volatile structure.

Attention:

- IBM does not recommend using a volatile structure for a checkpoint. Notify your system programmer before replying CONT to this message.
- If you reply CONT to allow JES2 to use the volatile structure and the other checkpoint is already volatile, you receive this message only. JES2 does not process the CKPTDEF VOLATILE=ALLCKPT= subparameter if you receive this \$HASP237 message. To ensure that you are not running with CKPT1 and CKPT2 both on volatile coupling facilities, issue \$D CKPTDEF to display the volatility status of your active checkpoints.

CANCEL

JES2 ends the reconfiguration and continues processing. If you previously replied CKPTDEF to change CKPT_n or NEWCKPT_n, those changes are lost.

Note: CANCEL appears as an option only if this reconfiguration is **not** for an I/O error.

Attention: If the TERM option appears and you inadvertently reply CANCEL, JES2 will treat CANCEL as a synonym for TERM and terminate members.

TERM A reply of TERM is not recommended. If TERM appears as an option, JES2 is processing an I/O error for the CKPT n as indicated by message \$HASP233.

A reply of TERM causes **all** members experiencing an I/O error on CKPT n to end abnormally with a \$Kxx error code. The reason code on the \$HASP275 message for each member is the \$HASP095 error code for each member. Depending on the \$Kxx reason code given in the \$HASP275 message and the subsequent \$HASP095 error code, the TERM response may require an IPL or an all-member warm start. Although JES2 attempts to create an emergency backup copy of this data set before ending (see message \$HASP279), it may not be successful.

DELETE

JES2 reformats the other CKPT n data set (for example, CKPT2, if CKPT1 is displayed) and then deallocates the CKPT n data set specified in this message (\$HASP237). JES2 continues processing with only one checkpoint data set in use.

Note:

1. The DELETE option appears only if there is an I/O error and both checkpoint data sets are in use (INUSE=YES). For example, if there is an error on CKPT1 and CKPT2 is not in use, JES2 **does not** present a DELETE option because its selection would leave no checkpoint data set in use.
2. If your JES2 configuration is running in DUPLEX mode and any member has specified DUPLEX=OFF, JES2 does not delete the CKPT1 data set unless it can allocate the DUPLEX data set (CKPT2) on every member. If allocation is successful, JES2 issues message \$HASP280 indicating the CKPT2 data set is in use and then suspends the use of CKPT1. If allocation is not successful on this member, JES2 issues the \$HASP278/\$HASP272 message pair. If allocation is not successful on a non-driving member(s), JES2 issues message \$HASP234 and \$HASP235.

CKPTDEF (NO OPERANDS)

If you reply with a CKPTDEF statement with no operands, JES2 issues message \$HASP829 displaying the current settings of the CKPTDEF parameters that **can be modified** during a dialog. \$HASP289 is highlighted and is deleted after you reply to the \$HASP237/\$HASP272 message pair that JES2 reissues.

Note: If, during a reconfiguration dialog, you need to see the complete set of CKPTDEF specifications, issue the \$D CKPTDEF command. If you only need to see specific parameter settings (for example, CKPT1 and CKPT2), issue the \$D CKPTDEF,CKPT1,CKPT2 command. JES2 responds by issuing message \$HASP829 showing only the CKPT1 and CKPT2 specifications.

CKPTDEF (WITH OPERANDS)

If you want to change a checkpoint specification, reply with a CKPTDEF statement with one or more of the operands listed below (for example, CKPTDEF CKPT1=...). JES2 scans the CKPTDEF statement and immediately resets the indicated parameters to the values specified. Message \$HASP829 is issued displaying the current settings of the modifiable parameters on the CKPTDEF initialization statement. \$HASP289 is highlighted and is deleted after you reply to the next \$HASP272 message that JES2 issues.

The CKPTDEF operands that can be modified are:

- CKPT1=

{(DSName=dsname,VOLser=volser)
(STRNAME=strname)} –
if not currently in use

- CKPT2=

{(DSName=dsname,VOLser=volser)
(STRNAME=strname)} –
if not currently in use

- NEWCKPT1=

{(DSName=dsname,VOLser=volser)
(STRNAME=strname)}

\$HASP238 • \$HASP239

- NEWCKPT2=
{(DSName=dsname,VOLser=volser)
(STRNAME=strname)}
- DUPLEX={ON | OFF}

For an explanation of each operand, see the description of the CKPTDEF initialization statement in *z/OS JES2 Initialization and Tuning Reference*.

JES2 assumes you specified a checkpoint and attempts to process it. If the specification is null, JES2 issues the \$HASP282/\$HASP272 message pair to request your checkpoint specification. Otherwise, JES2 issues the \$HASP273/\$HASP272 message pair to request confirmation of the checkpoint you specified.

System programmer response: If you are not familiar with the reconfiguration dialog process, see *z/OS JES2 Initialization and Tuning Guide* for a detailed discussion.

Module: HASPCKDS

Routing Code: 1,2,10,42

Descriptor Code: 2,7

\$HASP238

Explanation:

▶▶—RMTxxxx ROUTECDE=yyyy ———CONFLICTS WITH RMTyyyy—ROUTECD=—zzzz————▶▶

The JES2 initialization data set specified (using the ROUTECDE= parameter on RMT(nnnn) statement) that a remote is to be pooled to a remote that, in turn, is to be pooled to a second remote. JES2 does not allow multiple levels of remote redirection. The initialization statement that should be corrected is either:

```
RMTxxxx ROUTECDE=yyyy
-- or --
RMTyyyy ROUTECDE=zzzz
```

System action: JES2 issues \$HASP441 to query the operator as to whether JES2 is allowed to continue initialization with the incorrect RMT(nnnn) definition.

Operator response: Contact your system programmer. Reply 'N' to the \$HASP441 message if your remote pooling definitions are important to your system, otherwise reply 'Y'.

System programmer response: Correct the remote definitions in the JES2 initialization data set by either:

- Modifying the ROUTECDE= parameter on the definition for RMTxxxx (for example, to ROUTECDE=zzzz), or
- Modifying the ROUTECDE= parameter on the definition for RMTyyyy (for example, to ROUTECDE=yyyy).

Your requirements for which remotes are to be pooled will determine which RMT(nnnn) statement(s) you need to correct.

Module: HASPIRRE

Routing Code: 1,2,10

Descriptor Code: 4

\$HASP239

Explanation:

▶▶—PCE UNABLE TO ATTACH ———
 └─RMTnnn─┘ — LINE1na—RC=rc————▶▶

During signon processing for a remote terminal, the processor control element (PCE) failed to attach because of the

reason indicated by *rc*. PCEs are required for the unit record devices (such as printers, punches, and readers) attached to the remote terminal.

In the message text:

nnnn The number of the remote terminal.

lna The line number.

rc The return code.

Possible values of *rc* are:

RC=04 Indicates not enough virtual storage was available for the \$PCE.

RC=08 Indicates the EXIT27 routine denied the attach of the \$PCE.

System action: signon processing for the remote terminal ends.

Operator response: Notify the system programmer.

System programmer response: If the PCE was unable to attach because of a virtual storage constraint, determine why the private area of the JES2 address space is exhausted and attempt to correct the problem. It is possible that the JES2 parameters specified allow only a relatively limited number of remote terminals to be signed on at any one time.

If the EXIT27 routine denied the attach of the PCE, determine why and correct the problem.

Module: HASPRTAM, HASPSNA, HASPBSC, HASPTCP

Routing Code: 8,10

Descriptor Code: 4

\$HASP240

Explanation:

▶▶—MESSAGES TO INACTIVE SPOOL—MEMBER DISCARDED—▶▶

The JES2 remote console processor has received a message for a member of a multi-access spool configuration that is not currently active.

System action: The message is discarded and processing continues.

Operator response: None.

Module: HASPRTAM

Routing Code: 8,10

Descriptor Code: 4

\$HASP241

Explanation:

▶▶—MAXIMUM NUMBER OF MESSAGES—TO QUEUE TO SPOOL EXCEEDED—▶▶

The number of commands or messages the JES2 remote console processor has queued for delivery to members of the NJE node on the spool volumes exceeds the amount allowed (as specified by the MASMSG parameter on the CONDEF initialization statement).

System action: The commands and messages currently spooled are discarded; processing continues.

System programmer response: Increase the value of the MASMSG parameter or install communication lines between nodes to reduce message traffic through the node.

Module: HASPRTAM

Routing Code: 8,10

\$HASP242 • \$HASP244

Descriptor Code: 4

\$HASP242

Explanation:

▶▶—REMOTE POOLING ERROR – —CANNOT POOL A REMOTE TO A—REMOTE WHICH IS ALSO POOLED—▶▶

The JES2 initialization data set specified (using the ROUTECDE= parameter on the RMT(nnnn) statements) that a remote is to be pooled to a remote which in turn is to be pooled to a second remote. JES2 does not allow and cannot resolve multiple levels of remote redirection. Therefore, JES2 flags such initialization statements in error and provides \$HASP238 to indicate the specific remotes that you defined improperly.

System action: JES2 issues \$HASP441 to query the operator as to whether JES2 is allowed to continue initialization. A response of 'Y' causes JES2 to define the remote pooling as specified in the RMT(nnnn) initialization statements; potentially causing output routed to these remotes to be nonselectable. A response of 'N' causes JES2 to terminate initialization processing and allows you to correct the incorrectly coded RMT(nnnn) statements.

JES2 issues message \$HASP238 to display each remote that is defined incorrectly.

Operator response: Contact your system programmer. Reply 'N' to the \$HASP441 message if your remote pooling definitions are important to your system and you intend to correct the RMT(nnnn) statements, otherwise reply 'Y'.

System programmer response: Correct the RMT(nnnn) definitions in the JES2 initialization data set.

Module: HASPIRRE

Routing Code: 1,2,10

Descriptor Code: 2,7

\$HASP243

Explanation:

▶▶—PATH LOST TO—*nodename*—▶▶

A command was entered into the NJE network, but all paths to the action node were lost before the command could be delivered. The command is ignored.

In the message text:

nodename

The name of the node.

System action: Processing continues.

Operator response: Enter a \$TN command to display the action node status. Reenter the command if a path is available; otherwise, wait until later or call the operator on the action node.

Module: HASPRTAM

Routing Code: 1,2

Descriptor Code: 4

\$HASP244

Explanation:

▶▶—*cmd*—INVALID COMMAND—▶▶

A command was forwarded through the NJE network to a JES2 subsystem for action. The subsystem did not recognize the command by its first character as a JES2 command. The subsystem could not pass the command to OS/VS2 for action. This is due to lack of command authority (JES2 requires the entry console to have system command authority and the entry node to have network and system command authority at the action node). In the message text:

cmd The text of the invalid command.

System action: Processing continues.

Operator response: If the command entry was improper, correct it. Obtain correct authority to enter the command or request the operator at the action node to enter the command.

Module:

HASPR TAM

Routing Code: 8

Descriptor Code: 4

\$HASP245

Explanation:

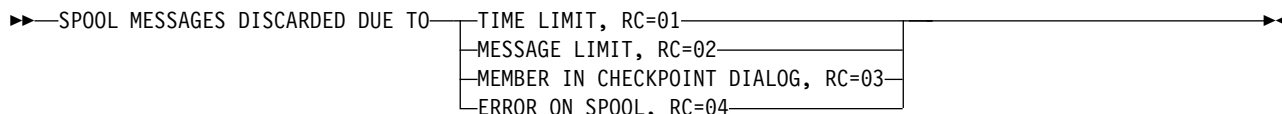

An error occurred that caused JES2 to discard spool messages. In the message text:

TIME LIMIT, RC=01

JES2 attempted to gain control of the job queue (for an installation-specified period of time indicated by the DELAY parameter on the NJEDEF initialization statement) to write messages to the spool (multi-access spool (MAS) configuration). The attempt was unsuccessful and a console lock-out condition could exist. Therefore, commands and messages are discarded to permit functions that are able to continue to do so.

This message is also issued if commands and messages are to be written to spool volumes that are already 100 percent utilized for an extended period.

Note: If a MAS member holding the shared spool is in abend recovery longer than the maximum time specified by the DELAY parameter, this message is issued on the "locked out" system.

MESSAGE LIMIT, RC=02

Another member of the MAS queued more messages to this system than allowed by the value of the MASMSG parameter of the CONDEF initialization statement of the sending system. This could indicate either a problem on the sending system or too low a value for the MASMSG parameter.

MEMBER IN CHECKPOINT DIALOG, RC=03

This member of the MAS is in checkpoint reconfiguration dialog. Commands and messages sent to other members of the MAS are immediately discarded to permit functions that are able to continue to do so.

ERROR ON SPOOL, RC=04

JES2 has tried to issue a message to a remote console. There were existing messages waiting to be sent, but they could not be accessed because the spool volume was unavailable.

System action: Processing continues.

Operator response: If **TIME LIMIT** appears in the message text, clear the hardware reserve on the checkpoint device by bringing down the system holding the lock. Clear 100 percent spool utilization by canceling input jobs or jobs that could be easily rerun, or add spool volumes to the configuration.

If **MESSAGE LIMIT** appears in the message text, determine which system in the MAS is sending the messages. Determine if that system is looping or if there is an application that is sending many notifications to the system that issued this message.

If **MEMBER IN CHECKPOINT DIALOG** appears in the message text, answer the console prompts for the checkpoint reconfiguration dialog for that member.

If **ERROR ON SPOOL** appears in the message text, the old messages are discarded and a new remote message data set will be created that contains any new messages.

\$HASP246 • \$HASP247

Module: HASPRTAM

Routing Code: 10

Descriptor Code: 4

\$HASP246

Explanation:

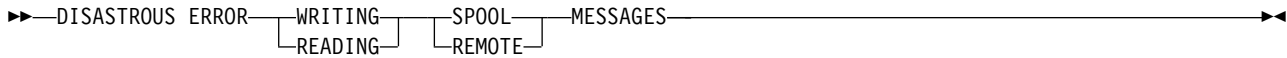

A disastrous error occurred while JES2 was reading or writing commands and messages to or from the spool volumes or a remote console. The system has discarded commands and messages.

Possible causes of this problem are any of the following:

- The time of day (TOD) clock setting for one of the systems is out of synchronization relative to one or more of the other systems. The synchronization tolerance is specified by the SYNCTOL parameter on the MASDEF initialization statement.
- Physical I/O errors on the spool volumes may have occurred if the system has issued message \$HASP094. See the explanation of that message.
- JES2 ended with a \$Q02 abend and was then restarted with a hot start.

System action: Processing continues.

Operator response: Notify the system programmer. The system may issue message \$HASP096 or \$HASP094.

System programmer response: If JES2 has issued an associated \$HASP096 message or a \$HASP094 message, see the explanation of that message for more information. Do the following:

1. For cause 1, correct the clock values on the system in error with the older clock value. IPL to set the TOD clock and perform a single system warm start.
2. For cause 2, evaluate the \$HASP094 explanation. Consider evaluating the disk surface for bad cylinders in the SYS1.HASPACE data set or consider possible spool contamination (logical error in processing on spool).
3. For cause 3, see the \$Q02 explanation under \$HASP095. To ensure a clean recovery from a \$Q02 abend, perform an all-member warm start of JES2.

Module: HASPRTAM

Routing Code: 8,10

Descriptor Code: 4

\$HASP247

Explanation:

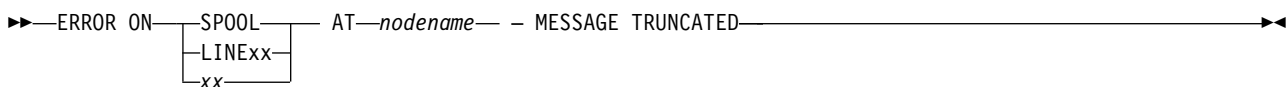

If **SPOOL** occurs in the message text:

An error occurred while spooling a multi-line write to operator (WTO) message at the indicated node. This message appears as the last line of the multi-line WTO at the node for which the message was destined.

If **LINExx** occurs in the message text:

The value of the DELAY parameter on the NJEDEF initialization statement was exceeded while receiving a multi-line WTO.

In the message text:

xx The receiving line.

nodename

The name of the node.

System action: Processing continues.

Operator response: Inform the operator of the node that sent the message about the truncated message.

Module: HASPRTAM

Routing Code: 8,10

Descriptor Code: 4

\$HASP248

Explanation:

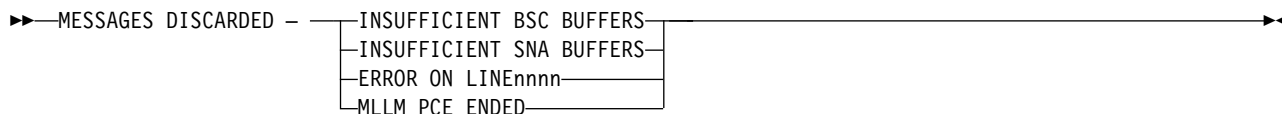

JES2 has been attempting to transmit commands and messages through NJE without success because of insufficient teleprocessing (BSC or SNA) buffers. This insufficiency caused transmission delays that exceeded the DELAY= specification on the NJEDEF initialization statement. Messages have been discarded to prevent a possible console lockout.

INSUFFICIENT BSC BUFFERS

There are insufficient BSC buffers to accommodate the number of concurrently active functions.

INSUFFICIENT SNA BUFFERS

There are insufficient SNA buffers to accommodate the number of concurrently active functions.

ERROR ON LINEnnnn

Line errors are extremely frequent, causing all buffers to wait for transmission, or the receiving system is congested and cannot receive.

MLLM PCE ENDED

The multi-leaving line manager (MLLM) PCE has terminated abnormally, causing JES2 to not be able to issue messages across NJE lines. JES2 previously issued message \$HASP068 to indicate this condition.

In some cases, JES2 might disconnect some communication lines to free the buffer resources and inform the other end of the line concerning the abnormal conditions. This condition is followed by appropriate disconnect messages.

System action: Processing continues.

System programmer response: If the problem appears in the receiving system, inform the remote installation and prepare a plan to reduce congestion. For example, reduce message flow by altering connection resistances (REST= parameter on the LINE(nnnn) initialization statement), provide more resources to handle NJE traffic, or install new lines to bypass congested system.

If appropriate, provide more buffers for transmission. Use the BSCBUF= and SNABUF= parameters on the TPDEF initialization statement for BSC and SNA buffers, respectively.

If the condition occurs as a result of the suspension of the MLLM PCE, you need to restart JES2 to restore normal line operation.

If excessive line errors continue, inform your hardware maintenance personnel.

Module: HASPRTAM

Routing Code: 1,2,8

Descriptor Code: 4

\$HASP249

Explanation:



JES2 received a command from a node or a remote.

\$HASP250

In the message text:

source The location that the command originated from. The *source* value can be one of the following:

userid **AT** *node*

The command was entered from a TSO/E userid at *node*.

Rnnnn **AT** *node*

The command was entered from a remote workstation at *node*.

***CONSOLE** **AT** *node*

The command was entered from an operator console at *node*.

***UNKNOWN** **AT** *node*

The command was entered at *node* but JES2 could not determine the originator of the command.

Rnnnn The command was entered from a locally-attached remote workstation.

INITIALIZATION

The command was included in the JES2 initialization stream.

AUTO COMMAND ID=xxxx

The command was issued by the JES2 automatic command facility, using the \$TA command. The *xxxx* value is the ID associated with the issuing automatic command.

command text

The command JES2 received.

System action: Processing continues.

Operator response: None.

Module: HASPRTAM, HASJCMDS, HASPCOMM

Routing Code: 1, 2, 10

Descriptor Code: 4

\$HASP250

Explanation:

►► *jobname* —

PURGED
ZAPPED

 — (JOB KEY WAS *jobkey*) —►

If the message states "PURGED", the job was removed from the job queue normally. JES2 has completely finished processing the designated job, and all JES2 facilities belonging to the job are made available for reuse. If the value for *jobname* is **TEMP**, a job was submitted through a TP line, but an error occurred before the job name was read.

If the message states "ZAPPED" then this job was removed as the result of a \$ZAPJOB command or a ZAPJOB initialization statement. This job does not create the normal SMF records and does not free SPOOL space. SPOOL space will be reclaimed by the normal SPOOL cleanup process within one week.

In the message text:

jobname

The name of the job.

jobkey The jobkey of the job.

Note: A jobid may precede \$HASP250. See "JES2 message format" on page 1.

System action: JES2 resources associated with the specified job are freed.

Operator response: None.

Module: HASPTRAK or HASPJQS

Routing Code: 7

Descriptor Code:

\$HASP251

Explanation:

▶▶—TRACK GROUP—

RETURNED TO	volser	AT	bbbccccch
REMOVED FROM			

—————▶▶

JES2 detected a bad track group and tried to recover from the error. If the recovery attempt was successful, **TRACK GROUP RETURNED TO** *volser* appears. If the recovery attempt was not successful, **TRACK GROUP REMOVED FROM** *volser* appears.

In the message text:

volser The volume serial number.

bbb The bin identifier, or 0000.

cccc The cylinder identifier.

h The head identifier.

Note: This message appears during JES2 initialization if the number of tracks allocated to the spool extent results in a partial track group. The partial track group is removed.

System action: JES2 attempts recovery, and this message appears, when JES2 purges the job or data set associated with the track group and at future JES2 warm starts.

Operator response: Notify the system programmer.

System programmer response: If the recovery attempt was not successful, contact your hardware support representative.

Module: HASPSPOL

Routing Code: 10

Descriptor Code: –

\$HASP252

Explanation:

▶▶—*nnnnnnnn*—NOTIFY SERVICE MESSAGES DISCARDED—————▶▶

JES2 was unable to process notify service messages because of a backlog of messages. The most common cause of this backlog is that JES2 abended, but processing by other products that create notify service messages continued. Another cause of a backlog may be that other products are creating too many notify service messages.

In the message text:

nnnnnnnn
 The number of messages discarded.

System action: Processing continues.

System programmer response: If the system issues this message during normal operation of JES2, you may have a performance problem. Investigate what is affecting your performance and review your installation's use of the notify service.

Module:

HASCSIRQ

Routing Code: –

Descriptor Code: 4

\$HASP253 • \$HASP255

\$HASP253

Explanation:

▶▶—MEMBER—*member*— — \$GETWORK FAILED—DURING DYNAMIC ALLOCATION ERROR PROCESSING—▶▶

While processing a dynamic allocation error on member *member*, JES2 issued a \$GETWORK macro to obtain storage to contain formatted text for display by message \$HASP581. The \$GETWORK failed because there is insufficient storage in the JES2 address space.

System action: JES2 issues the \$HASP581 message without the formatted text.

Operator response: Notify the system programmer.

System programmer response: Determine why there is insufficient storage in the JES2 address space and correct the error.

Module:

HASPNUC

Routing Code: 1,2,10

Descriptor Code: 4

\$HASP254

Explanation:

▶▶—MEMBER—*member*— — JES2 CHECKPOINT RECONFIGURATION—DELAYED BECAUSE JESXCF HAS NOT RESPONDED—▶▶

▶—TO A REQUEST FOR MEMBER INFORMATION—▶▶

This highlighted, informational message informs the operator that a request for member information (through a JES XCF IXZXIXIF macro invocation) has been delayed at least 3 seconds.

In the message text:

member The member encountering the delay.

System action: JES2 checkpoint reconfiguration is delayed until the IXZXIXIF request completes, at which time the message is deleted from the console.

Operator response: Notify the system programmer.

System programmer response: If this message persists, issue the \$PJES2,ABEND command followed by the \$PJES2,ABEND,FORCE command. Also, request a dump in response to the \$HASP098/\$HASP198 message pair.

Module:

HASPCKRR

Routing Code: 1,2,10

Descriptor Code: 2,7

\$HASP255

Explanation:

| ▶▶—JES2 CHECKPOINT RECONFIGURATION—

COMPLETE
CANCELLED BY OPERATOR
CANCELLED BY JES2
FAILED

—▶▶

JES2 displays this message to indicate that checkpoint reconfiguration has ended and normal checkpoint processing has resumed.

COMPLETE

JES2 checkpoint reconfiguration has completed.

CANCELLED BY OPERATOR

The JES2 checkpoint reconfiguration has been canceled as requested by the operator during the reconfiguration dialog.

CANCELLED BY JES2

JES2 could not determine the reason for the reconfiguration and canceled it. This can occur if a member initiates a reconfiguration, but fails before the driving member determines the reason for the request.

FAILED

While processing a operator requested set CKPTDEF command (\$T CKPTDEF), JES2 encountered a condition that could not be resolved and failed the command. Previous messages describe the condition encountered.

System action: Processing continues.

Operator response: None.

Module:

HASPCKDS

Routing Code: 1,2,10,42

Descriptor Code: 4

\$HASP256

Explanation:

▶▶—FUTURE AUTOMATIC FORWARDING OF CKPTn— IS SUSPENDED UNTIL NEWCKPTn—IS RESPECIFIED.—▶▶

▶—ISSUE \$T CKPTDEF,NEWCKPTn=(...)—TO RESPECIFY—▶

The driving member issues this message after completing a checkpoint reconfiguration where the CKPTn data set was forwarded (or attempted to forward) to a NEWCKPTn. The NEWCKPTn data set is now undefined.

System action: Processing continues. This message is highlighted and is not deleted until you specify a NEWCKPTn by issuing a \$T CKPTDEF command on any member, or the member that issued this message terminates.

Operator response: Use the \$T CKPTDEF command to specify a new replacement data set for NEWCKPTn. Otherwise, if JES2 needs to enter a reconfiguration in the future, it will be unable to complete automatically; operator involvement would be necessary at that time to specify a NEWCKPTn data set.

Module:

HASPCKDS

Routing Code: 1,2,10,42

Descriptor Code: 2,7

\$HASP257

Explanation:

▶▶—MEMBER—*delayed-member-name*— – JES2 CHECKPOINT RECONFIGURATION—▶▶

▶—DELAYED BY MEMBER—*causing-member-name*.—*delayed-member-name*—IS WAITING FOR ACTION=—▶

▶—*action-code*, *action-text*.—▶▶

The *delayed-member-name* is participating in a JES2 checkpoint reconfiguration and is waiting on the *causing-member-name* to perform an expected action before the checkpoint reconfiguration can continue. The delayed member has been waiting for at least 15 seconds to:

\$HASP257

- Detect an XCF user-state update by the causing member. (The user-state information is for the JES XCF group name defined by the XCFGRPNM= parameter on the MASDEF initialization statement.)
- Receive a JES XCF application message from the causing (driving) member.
- Receive a JES XCF acknowledgment message from the causing (non-driving) member.

In the message text:

delayed-member-name

The member waiting for an action to occur on another member

causing-member-name

The member that has not yet performed or informed the *delayed-member-name* of completion of an expected action.

Probable causes for the delay to perform the necessary action by the *causing-member-name* are:

1. More than 15 seconds might be required for JES2 to format a large checkpoint data set.
2. The operator stopped the MVS system on which the causing member resides.
3. The causing member is in termination processing.
4. The causing member is a candidate for partitioning or is being partitioned out of the sysplex.
5. JES2 is in a loop or hung or some other non-productive state.
6. The waiting member has not yet received an expected message or acknowledgment from the causing member. JES2 might not have issued, or JES XCF might not have delivered, an expected application or acknowledgment message.
7. The delayed member has not yet detected an expected XCF user state update by the causing member.

For all causes above, the delay can be temporary and reconfiguration processing continues if the respective activity completes. If temporary, consider this an informational message for those conditions.

For causes 5, 6, and 7, one or more members might have caused reconfiguration processing to not proceed. These delays can be permanent.

System action: In general, the JES2 checkpoint reconfiguration is delayed until the expected XCF user state update is detected or JES XCF application or acknowledgment message is received. If the delaying member eventually responds or fails, the \$HASP257 message is deleted and processing continues. Specific system actions are provided for each *action-code* and *action-text*.

Operator response: There are certain general actions you might take for all *action-codes* and *action-texts* are noted here. Specific actions are also provided for each *action-code* and *action-text*.

General Approach for All Action Codes: Before JES2 can continue with the checkpoint reconfiguration, you must first resolve any outstanding sysplex partition problems.

If the \$HASP257 message(s) persists, you must issue \$PJES2,ABEND followed by \$PJES2,ABEND,FORCE to remove the problem member(s) from the MAS and wait for the reconfiguration to end before restarting the failed members. To determine which member is actually causing the problem, consider:

1. If the driving member is waiting for one (or more) non-driving members, **and** all the other non-driving members are waiting on the driving member, then the member(s) for which the driving member is waiting is likely the cause of the delay.
2. If the driving member has not issued \$HASP257, and all the other non-driving members issued \$HASP257 indicating a delay, then the member causing the delay is likely the driving member.

If you can isolate the most likely member(s) causing the delay:

1. Terminate the member(s). (You cannot issue \$PJES2,ABEND,FORCE unless you have first attempted to terminate the member with the \$PJES2,ABEND command.)
2. Try to not terminate the driving member unless necessary. It holds the latest (most current) copy of the checkpoint data. However, terminate the driving member before terminating **all** non-driving members.

These recommendations require that you have an overall view of the status of the MAS. Obtain this overall view from message \$HASP255 which identifies the driving member and the set of \$HASP254 and \$HASP257 messages from all members. You can use a single command to display the set of \$HASP257 messages if the CONDEF

CONCHAR= is defined as the same character on every JES2 member of the MAS. For example, if CONCHAR=\$ is specified on every member, issue the MVS command *D R,L,CN=(ALL),MSG=\$HASP257*.

The *action-code* and corresponding *action-text* are:

Code **Text**

1 *causing-member-name* TO INDICATE RECONFIGURATION STARTING

Explanation: The causing member has not updated its XCF user-state information to indicate it has started checkpoint reconfiguration processing.

System Action: If the cause is temporary, processing continues when the reason for delay is processed.

Operator Response: If the causing member is on an MVS system that is a candidate for partitioning or is being partitioned out of the sysplex or the member is in termination processing, then checkpoint reconfiguration processing resumes after that processing completes. As appropriate, you can:

- Request that MVS partition the system out of the sysplex
- Wait for partitioning processing to end
- Terminate the *causing-member*.

In rare situations, you may be able to end the delay by issuing a *\$D CKPTDEF* command to the *causing-member*. If the response does not indicate RECONFIG=YES, issue *\$T CKPTDEF,RECONFIG=Yes* (the blank between \$T and CKPTDEF is optional) to the causing member. If this does not initiate the checkpoint reconfiguration on the *causing-member*, issue *\$PJES2,ABEND* followed by *\$PJES2,ABEND,FORCE*. Restart the JES2 member after reconfiguration processing completes.

2 *causing-member-name* TO COMMIT AS THE DRIVING MEMBER

Explanation: The driving member has not updated its XCF user-state information to indicate it has committed as the driving member for this checkpoint reconfiguration.

System Action: If the driving member is on an MVS system about to be partitioned out of the sysplex or the member is in termination processing, then checkpoint reconfiguration processing resumes after that processing completes. The member with the next highest level of checkpoint data takes over the role as driving member.

Operator Response: If the driving member also issued one or more \$HASP257 messages, respond to those before taking action to satisfy this message. If the driving member did not also issue a \$HASP257 message(s), the driving member may be the cause of the problem. See General Approach for All Action Codes.

3 *causing-member-name* TO COMMIT AS NON-DRIVING MEMBER

Explanation: The non-driving member has not updated its XCF user-state information to indicate it has committed to this checkpoint reconfiguration.

System Action: If the non-driving member is on an MVS system about to be partitioned out of the sysplex or the member is in termination processing, then checkpoint reconfiguration processing resumes after that processing completes.

Operator response: If the delay is not temporary (such as because of partitioning or termination processing), you need to fail (terminate) the causing member. See General Approach for All Action Codes.

4 JESXCF APPLICATION MESSAGE (CKXMTYPE=*msg-type*) FROM DRIVING MEMBER *causing-member-name*

Explanation: The non-driving member has not received a JESXCF application message of the indicated CKXMTYP=*msg-type* from the driving member.

System Action: If the non-driving member is on an MVS system about to be partitioned out of the sysplex or the member is in termination processing, then checkpoint reconfiguration processing resumes after that processing completes.

Operator response: If the driving member also issued one or more \$HASP257 messages, respond to those before taking action to satisfy this message. If the driving member did not also issue a \$HASP257 message(s), the driving member may be the cause of the problem. See General Approach for All Action Codes.

\$HASP258

- 5 JESXCF ACKNOWLEDGEMENT MESSAGE (CKXMTYPE=*msg-type*) FROM NON-DRIVING MEMBER
causing-member-name

Explanation: The driving member has not received a JESXCF acknowledgment message of the indicated CKXMTYP=*msg-type* from the non-driving member.

System Action: If the non-driving member is on an MVS system about to be partitioned out of the sysplex or the member is in termination processing, then checkpoint reconfiguration processing resumes after that processing completes.

Operator Response: If the delay is not temporary (such as because of partitioning or termination processing), you need to fail (terminate) the causing, non-driving member. See General Approach for All Action Codes.

- 6 *causing-member-name* TO DECOMMIT AS THE DRIVING MEMBER

Explanation: The non-driving member is waiting for the driving member to update its XCF user-state to decommit as the driving member.

System Action: If the driving member is on an MVS system about to be partitioned out of the sysplex or the member is in termination processing, then checkpoint reconfiguration processing resumes after that processing completes.

Operator response: If the driving member also issued one or more \$HASP257 messages, respond to those before taking action to satisfy this message. If the driving member did not also issue a \$HASP257 message(s), the driving member may be the cause of the problem. See General Approach for All Action Codes.

- 7 *causing-member-name* TO DECOMMIT THIS RECONFIGURATION

Explanation: The *delayed-member* is waiting for the *causing-member* to update its XCF user-state to indicate that the *causing-member* has decommitted this reconfiguration. Because reconfiguration processing is completing, there is no longer a *driving* member.

System Action: If the *causing-member* is on an MVS system about to be partitioned out of the sysplex or the member is in termination processing, then checkpoint reconfiguration processing resumes after that processing completes.

Operator Response: If the delay is not temporary (such as because of partitioning or termination processing), you need to fail (terminate) the *causing-member*. See General Approach for All Action Codes.

System programmer response: None.

Module:

HASPCKRR

Routing Code: 1,2,10

Descriptor Code: 3,7

\$HASP258

Explanation:

▶▶—CHECKPOINT WRITE IS IN PROGRESS—FORCING JES2 MAY CAUSE SEVERE CKPT DAMAGE—▶▶

An operator has specified the \$PJES2,ABEND,FORCE command, after being warned by \$HASP552 message.

System action: JES2 abnormally ends without cleaning up the storage. As the message text indicates, the CKPT*n* data set can lose data integrity.

Operator response: None.

System programmer response:

None.

Module: HASC SIRQ

Routing Code: 1,2,10

Descriptor Code: 4

\$HASP259

Explanation:

▶▶—WAITING FOR I/O TO JES2 CKPTn—DATA SET TO COMPLETE—▶▶

JES2 has issued the first operation to obtain data from the checkpoint data set. The number of seconds specified as the time interval on the LOCKOUT= parameter on either the MASDEF initialization statement or on the \$T MASDEF operator command has elapsed, but the read operation has not completed.

System action: JES2 issues this message every time the warning interval specified on the LOCKOUT parameter expires until the read operation completes.

Operator response: Notify the system programmer.

System programmer response: Determine whether the LOCKOUT value at your installation has been set too low.

Module: HASPCKRR

Routing Code: 1,2,10

Descriptor Code: 4

\$HASP260

Explanation:

| ▶▶—MEMBER *sid* IS NOW IN z11/z22 CHECKPOINT MODE—OPTSDEF COLD_START_MODE=z11/z22—▶▶
 ▶—DOES NOT AGREE WITH THE CURRENT—CHECKPOINT MODE—▶▶

A \$ACTIVATE command has been issued to set the JES2 checkpoint into the displayed mode (\$ACTIVATE LEVEL). If this is the member where the command is issued, then the checkpoint data sets have been formatted in the new checkpoint mode. If this is another member of the MAS, then the message indicates that this member has updated its data structures and begun reading in the reformatted checkpoint.

The second line, if present, indicates that the OPTSDEF COLD_START_MODE parameter, read when this member was last started, is set to cold start JES2 in a mode different from the current checkpoint mode (\$ACTIVATE LEVEL). If a JES2 cold start is done at this time, it will not start in the same mode JES2 is currently running in. IBM recommends that the OPTSDEF COLD_START_MODE value be set to the checkpoint mode JES2 is expected to be running in.

In the message text, *sid* is the JES2 member name that issued the message

System action: JES2 processing continues.

Operator response: None

System programmer response: If the second line is present, then update your initialization parameters accordingly.

Module: HASPCKPT

Routing Code: 1,2,10

Descriptor Code: 4

| **\$HASP261**

| **Explanation:**

| ▶▶—Member—*member*—performs deadline scheduling processing—▶▶

| This message is issued on a JES2 member that was selected to perform the deadline scheduling processing function.
 | This member will perform deadline scheduling processing (DLS) for all members in a JESplex.

\$HASP262 • \$HASP263

- | In the message text:
 - | *member* The name of the JES2 member.
 - | **System action:** The message is written to the console. JES2 will perform the deadline scheduling function.
 - | **Operator response:** None
 - | **System programmer response:** None
 - | **Module:** HASPSERV
 - | **Routing Code:** 2,10
 - | **Descriptor Code:** 4
-

\$HASP262

Explanation:

- | ▶▶—DLS PCE failed. Deadline scheduling no longer available on—*member*.—————▶▶
 - |
 - | This message is issued when DLS PCE which performs processing for the deadline scheduling functions (DLS) fails.
 - | In the message text:
 - | *member* The name of the JES2 member.
 - | **System action:** The message is written to the console. This JES2 member does not perform the deadline scheduling processing. If there is another active JES2 member, it will take over DLS processing. This will be indicated by message HASP261. If there is none, DLS processing will not be available until another member is started or this member is restarted.
 - | **Operator response:** None
 - | **System programmer response:** This is abnormal situation. Collect diagnostic information and contact your IBM service representative.
 - | **Module:** HASPSERV
 - | **Routing Code:** 1,2,10
 - | **Descriptor Code:** 4
-

\$HASP263

Explanation:

- ▶▶—WAITING FOR ACCESS TO—JES2 CHECKPOINT—*VOLUME volser*—

LOCK HELD BY MEMBER <i>member_name</i>	——▶▶
LOCK HELD BY SYSTEM	
SYSTEM MANAGED PROCESS ACTIVE	

When the primary checkpoint data set resides on DASD, JES2 has issued a RESERVE operation to the CKPT1 or CKPT2 data set on volume *volser*. The number of seconds specified as the time interval on the LOCKOUT parameter on the MASDEF initialization statement or on the \$T MASDEF operator command has elapsed, but the RESERVE operation has not completed. Another member in the multi-access spool configuration may have ended while holding the hardware RESERVE on the checkpoint data set.

This message is informational and displays why the lock can not be obtained. Either:

- The lock is held by another member of the MAS.
- The lock is in transition and is currently held by MVS. If this state persists, there may be a XCF signalling problem or a system may have failed.
- The lock cannot be obtained because a system managed process is active for the structure.

- In the message text:
- volser** The volume identifier.

member_name

The JES2 member that holds the checkpoint lock.

SYSTEM

The MVS system temporarily holds the lock after it has been relinquished by the last JES2 member to update the checkpoint.

System action: JES2 issues this message every time the warning interval specified on the LOCKOUT parameter expires until the read operation completes.

Operator response: Ensure that other systems in the MAS configuration are operational. If the primary checkpoint is on DASD and the other system is down, it is probably holding a RESERVE on the JES2 checkpoint data set. If the failed system cannot be restarted, the RESERVE must be cleared by pressing SYSTEM RESET on the failed system. After pressing SYSTEM RESET, message \$HASP264 might be issued. Use of the JES2 \$E CKPTLOCK command will not clear the reserve when this message is issued with a VOLSER.

If the primary checkpoint data set resides on a coupling facility structure, wait until the software lock is freed. If the list member is not operational, then the JES2 \$E CKPTLOCK command can be used to steal the lock. If LOCK HELD BY SYSTEM is displayed, there may be a problem with XCF signalling or a system has failed and not been partitioned out of the SYSPLEX. Check for outstanding WTORs that have additional information. If a SYSTEM MANAGED PROCESS ACTIVE indication has not cleared, you should determine the state of the active process and possibly cancel it using the SETXCF command.

Examine other members of the MAS for a \$HASP9207 message. A member that has issued the \$HASP9207 message is the cause of this message. Perform diagnostics on the member issuing the \$HASP9207 message to resolve the problem.

Module:

HASPCCKDS

Routing Code: 1,2,10

Descriptor Code: 4

\$HASP264

Explanation:

▶▶—WAITING FOR RELEASE OF JES2 CKPT LOCK BY—*memname*—————▶▶

JES2 has successfully reserved the software lock on the checkpoint data set. However, it has determined (by examining the checkpoint data set lock record) that member *memname* has control of the software lock on the checkpoint data set and has not relinquished that control.

In the message text:

memname

The alphanumeric identifier of the failed member that is holding the software lock on the checkpoint data set. If the member undergoing initialization has failed before a member id is assigned, *memname* is INITIALIZATION.

System action: JES2 cannot continue processing until it has exclusive control of the software lock on the checkpoint data set. This message is repeated approximately every 30 seconds until *memname* relinquishes control of the software lock on the checkpoint data set. If the failed member *memname* participated in the automatic restart function (indicated by AUTOEMEM=ON on its MASDEF initialization statement), and another active JES2 member in the MAS performs restart functions for members on failed MVS systems (indicated by RESTART=YES on its MASDEF initialization statement), then the active JES2 member will recover the software lock on the checkpoint data set.

Operator response: Use the \$D MASDEF command to show all the parameters in the MAS and their current definitions.

- If *memname* has failed and the automatic restart function is not active (AUTOEMEM=OFF on its MASDEF initialization statement), then enter a \$E CKPTLOCK,HELDBY=*memname* command to remove control of the software lock on the checkpoint data set from *memname*.
- If *memname* has failed with the automatic restart function active (AUTOEMEM=ON on its MASDEF initialization statement), and another active member has an active automatic restart function, with that member performing

\$HASP265 • \$HASP266

restart functions for members on a failed MVS system (indicated by RESTART=YES on the MASDEF initialization statement display), then the member will recover the software lock on the checkpoint data set.

- If *memname* has failed and the automatic restart function is active (AUTOEMEM=ON on its MASDEF initialization statement) on *memname*, and no other member is active, enter a \$E CKPTLOCK,HELDBY=*memname* command to remove control of the software lock on the checkpoint data set from *memname*.

See the description of the \$E CKPTLOCK,HELDBY= command in *z/OS JES2 Commands*.

Examine other members of the MAS for a \$HASP9207 message. A member that has issued the \$HASP9207 message is the cause of this message. Perform diagnostics on the member issuing the \$HASP9207 message to resolve the problem.

Module: HASPCKPT

Routing Code: 1,2,10

Descriptor Code: 4

\$HASP265

Explanation:

▶▶—JES2 CKPTn—DATA SET – DAMAGED RECORD DETECTED—▶▶

JES2 has found that the last checkpoint write operation performed by another member in the multi-access spool configuration was interrupted. The data set in error (CKPT1 or CKPT2) is specified in the message text.

In the message text:

n The number of the checkpoint data set. The number will be either 1 or 2.

System action: JES2 initiates a checkpoint reconfiguration dialog with the operator to create a new checkpoint data set or reformat the current data set.

Operator response: Respond to the dialog messages to recover from this error. If you are not familiar with the dialog process, see *z/OS JES2 Initialization and Tuning Guide* for a detailed discussion.

Module: HASPCKPT

Routing Code: 1,2,10

Descriptor Code: 4

\$HASP266

Explanation:

▶▶—JES2—

CKPTn
NEWCKPTn

—DATA SET IS BEING FORMATTED—▶▶

JES2 is formatting the specified checkpoint data set because either an I/O error occurred during a write to the data set or because JES2 is being cold started.

In the message text:

n The number of the checkpoint or new checkpoint data set. The number is either 1 or 2.

System action: JES2 writes the entire job queue and related information to the specified checkpoint data set.

Operator response: None.

Module: HASPCKPT

Routing Code: 1,2,10

Descriptor Code: 4

\$HASP267

Explanation:

▶▶ JES2—

CKPTn	—
NEWCKPTn	—

DATA SET HAS BEEN SUCCESSFULLY FORMATTED—▶▶

JES2 has completed formatting the specified checkpoint data set. Message \$HASP266 precedes this message. In the message text:

n The number of the checkpoint or new checkpoint data set. The number is either 1 or 2.

System action: Processing continues.

Operator response: None.

Module: HASPCKPT

Routing Code: 1,2,10

Descriptor Code: 4

\$HASP268

Explanation:

▶▶ JES2 CKPTn—DATA SET – INTERRUPTED—

READ	—
WRITE	—

DETECTED—▶▶

JES2 found that a read or write operation to the specified checkpoint data set was interrupted. In the message text:

n The number of the checkpoint data set. The number is either 1 or 2.

System action: JES2 retries the read or write operation. If the retry is successful, normal processing continues. If the problem persists, JES2 initiates a checkpoint reconfiguration dialog with the operator in an attempt to recover from the error.

Operator response: If JES2 initiates a checkpoint reconfiguration dialog, respond to the dialog messages to recover from the error. If you are not familiar with the dialog process, see *z/OS JES2 Initialization and Tuning Guide* for a detailed discussion.

Module: HASPCKPT

Routing Code: 1,2,10

Descriptor Code: 4

\$HASP269

Explanation:

▶▶ JES2 CKPT ERROR—(cde)— – CKPT DUMP IN PROGRESS—▶▶

JES2 has detected a major error during I/O processing to the checkpoint data set. JES2 issues a dump of the checkpoint information in virtual storage.

In the message text:

cde The error code.

System action: JES2 processing stops.

Operator response: Notify the system programmer.

System programmer response: Use the checkpoint dump and the explanation of the displayed error code under \$HASP095 to correct the problem.

Module:

\$HASP270 • \$HASP271

HASPCKPT

Routing Code: 1,2,10

Descriptor Code: 4

\$HASP270

Explanation:

▶▶—UNABLE TO SUSPEND THE USE OF—CKPT1 DATA SET DUE TO ERROR—IN ALLOCATING CKPT2—▶▶
▶ (dsname ON volser) — REFER TO PREVIOUS MESSAGE(S) —▶
 └ (STRNAME strname) ┘

In response to the last checkpoint reconfiguration message displayed, the operator requested that JES2 discontinue using the CKPT1 data set. Because this member is not currently duplexing (DUPLEX=OFF), JES2 either attempted:

- To allocate CKPT2 *dsname* ON *volser*

— or —

- To connect to CKPT2 coupling facility structure *strname*

before suspending the use of CKPT1.

This message notifies the operator that, because allocation of CKPT2 failed, JES2 cannot suspend the use of CKPT1. The previous message(s) give the reason for the allocation failure.

In the message text:

dsname

The name of the checkpoint data set.

volser

The volume identifier.

strname

The name of the coupling facility structure.

System action: JES2 prompts the operator for an alternative reconfiguration action.

Operator response: Either fix the allocation problem and then again request that CKPT1 be suspended, or select an alternative reconfiguration action.

Module: HASPCKDS

Routing Code: 1,2,10,42

Descriptor Code: 4

\$HASP271

Explanation:

▶▶—CHECKPOINT RECONFIGURATION OPTIONS—VALID RESPONSES ARE:—▶▶
▶ '1' - FORWARD CKPT1 to NEWCKPT1 — CKPTDEF (NO OPERANDS) - DISPLAY —▶
 ├ '2' - FORWARD CKPT2 to NEWCKPT2 —
 ├ '5' - SUSPEND THE USE OF CKPT1 —
 ├ '6' - SUSPEND THE USE OF CKPT2 —
 ├ '7' - UPDATE AND START USING CKPT1 —
 ├ '8' - UPDATE AND START USING CKPT2 —
 └ 'CANCEL' - EXIT FROM RECONFIGURATION —

The operator has specified RECONFIG=YES on the \$T CKPTDEF command to request a dialog with JES2, or JES2 entered a reconfiguration because of processing based on the VOLATILE= specification of the CKPTDEF initialization statement. JES2 issues this message to determine how the checkpoint configuration should be changed. Not all of the numbered options appear for a given instance of this message.

System action: JES2 issues message \$HASP272 and waits for an operator response.

Operator response: Determine the action you want taken and then respond to message \$HASP272 with one of the options described below. Not all of the numbered options appear for a given instance of this message.

Option Meaning

1 JES2 replaces the structure or data set name and the volume serial of CKPT1 with the structure or data set name and volume serial assigned to NEWCKPT1. JES2 issues the \$HASP273/\$HASP272 message pair to verify this assignment and then copies the driving member's in-storage version of the checkpoint data to this newly defined CKPT1 data set.

Note:

1. This option appears only if CKPT1 is currently in use (INUSE=YES) and NEWCKPT1 is defined.
2. If you are unfamiliar with the checkpoint data set forwarding concept, see *z/OS JES2 Initialization and Tuning Guide* for more information.

2 JES2 replaces the structure or data set name and the volume serial of CKPT2 with the structure or data set name and volume serial assigned to NEWCKPT2. JES2 issues the \$HASP273/\$HASP272 message pair to verify this assignment and then copies the driving member's in-storage version of the checkpoint data to this newly defined CKPT2 data set.

Note:

1. This option appears only if CKPT2 is currently in use (INUSE=YES) and NEWCKPT2 is defined.
2. If you are unfamiliar with the checkpoint data set forwarding concept, see *z/OS JES2 Initialization and Tuning Guide* for more information.

5 JES2 reformats the CKPT2 checkpoint specification and suspends the use of CKPT1.

JES2 deallocates the CKPT1 data set and then issues message \$HASP280, indicating it is no longer in use. JES2 continues processing with only one checkpoint data set (CKPT2) in use.

Note:

1. This option appears only if both CKPT1 and CKPT2 are currently in use (INUSE=YES).
2. If your JES2 configuration is running in DUPLEX mode and any member has specified DUPLEX=OFF, JES2 does not delete the CKPT1 data set unless it can allocate the DUPLEX data set (CKPT2) on every member. If allocation is successful, JES2 issues message \$HASP280 indicating the CKPT2 data set is in use and then suspends the use of CKPT1. If allocation is not successful on this member, JES2 issues the \$HASP278/\$HASP272 message pair. If allocation is not successful on a non-driving member(s), JES2 issues message \$HASP234 and \$HASP235.

6 JES2 reformats the CKPT1 checkpoint specification and suspends the use of CKPT2.

JES2 deallocates the CKPT2 data set and then issues message \$HASP280, indicating it is no longer in use. JES2 continues processing with only one checkpoint data set (CKPT1) in use.

Note: This option appears only if both CKPT1 and CKPT2 are currently in use (INUSE=YES).

7 JES2 issues the \$HASP273/\$HASP272 message pair to verify this assignment and then copies the driving member's in-storage version of the checkpoint data to the CKPT1 data set and then starts (or resumes) using this data set.

For the CKPT1 assignment, if the data set name, or the volume serial number, or both need to be changed, respond to the outstanding \$HASP272 message using the CKPTDEF (WITH OPERANDS) response to this message.

Note: This option only appears if CKPT1 is currently **not** in use (INUSE=NO).

\$HASP271

- 8 JES2 issues the \$HASP273/\$HASP272 message pair to verify this assignment and then copies the driving member's in-storage version of the checkpoint data to the CKPT2 data set and then starts (or resumes) using this data set.

For the CKPT2 assignment, if the data set name, or the volume serial number, or both need to be changed, respond to the outstanding \$HASP272 message using the CKPTDEF (WITH OPERANDS) response to this message.

Note: This option appears only if CKPT2 is currently **not** in use (INUSE=NO).

CANCEL

JES2 ends the reconfiguration and continues processing. If you previously replied CKPTDEF to change CKPTn or NEWCKPTn, those changes are lost.

CKPTDEF

If you reply with a CKPTDEF statement with no operands, JES2 issues message \$HASP829 displaying the current settings of the CKPTDEF parameters that **can be modified** during a dialog. \$HASP289 is highlighted and is deleted after you reply to the \$HASP271/\$HASP272 message pair that JES2 reissues.

Note: If, during a reconfiguration dialog, you need to see the complete set of CKPTDEF specifications, issue the *\$D CKPTDEF* command. If you only need to see specific parameter settings (for example, CKPT1 and CKPT2), issue the *\$D CKPTDEF,CKPT1,CKPT2* command. JES2 responds by issuing message \$HASP829 showing only the CKPT1 and CKPT2 specifications.

CKPTDEF (WITH OPERANDS)

If you want to change a checkpoint specification, reply with a CKPTDEF statement with one or more of the operands listed below (for example, CKPTDEF CKPT1=...). JES2 scans the CKPTDEF statement and immediately resets the indicated parameters to the values specified. Message \$HASP829 is issued displaying the current settings of the modifiable parameters on the CKPTDEF initialization statement. \$HASP289 is highlighted and is deleted after you reply to the next \$HASP271/\$HASP272 message pair that JES2 reissues.

The CKPTDEF operands that can be modified are:

- CKPT1=

{(DSName=dsname,VOLser=volser)
(STRNAME=strname)} –
if not currently in use

- CKPT2=

{(DSName=dsname,VOLser=volser)
(STRNAME=strname)} –
if not currently in use

- NEWCKPT1=

{(DSName=dsname,VOLser=volser)
(STRNAME=strname)}

- NEWCKPT2=

{(DSName=dsname,VOLser=volser)
(STRNAME=strname)}

- DUPLEX={ON|OFF}

For an explanation of each operand, see the description of the CKPTDEF initialization statement in *z/OS JES2 Initialization and Tuning Reference*.

System programmer response: If you are not familiar with the reconfiguration dialog process, see *z/OS JES2 Initialization and Tuning Guide* for a detailed discussion.

Module: HASPCKDS

Routing Code: 1,2,10,42

Descriptor Code: 2,7

\$HASP272

Explanation:

▶▶—ENTER RESPONSE (ISSUE D R, MSG=\$HASPxxx FOR RELATED MSG)—▶▶

JES2 issues this message when operator input is needed to determine the correct action for JES2 to take and the explanation cannot be placed in a WTOR. JES2 issues a highlighted message (WTO) followed by the \$HASP272 WTOR. The information needed to reply to the \$HASP272 message is contained in the preceding message. The text of the preceding message can be obtained from MVS by using the D R,L command or, if the long form of the \$HASP272 message is issued, the MVS D R,MSG=\$HASPxxx command that is displayed in the message.

IBM suggests:

- If the D R,MSG=id response includes "NOARMF", then turn on ARMF by issuing the following command: K M,ARMF=Y This allows the display of future action messages. Also, you should update your CONSOLxx parmlib member to set on ARMF.
- Reply with "CKPTDEF". This is frequently a valid option that doesn't change anything. However, if it is not a valid reply, JES2 will issue an error message and then reissue the original message.

System action: JES2 waits for the operator's reply.

Operator response: The information needed to reply to the HASP272 message is contained in the preceding message. The text of the preceding message can be obtained from MVS by using the D R,L command or, if the long form of the HASP272 message is issued, the MVS D R,MSG=\$HASPxxx command that is displayed in the message.

Module:

HASPCCKDS

Routing Code: 1,2,10,42

Descriptor Code: 2,7

\$HASP273

Explanation:

▶▶—JES2 CKPTn—DATA SET WILL BE ASSIGNED TO NEWCKPTn dsname ON VOLUME volser STRNAME strname—▶▶

▶▶—VALID RESPONSES ARE:—*response*—▶▶

The message *response* can be one of the following:

'CONT' – PROCEED WITH ASSIGNMENT
 {'CANCEL' – EXIT FROM RECONFIGURATION}
 {'TERM' – TERMINATE MEMBERS WITH I/O ERROR ON CKPTn}
 ['DELETE' – DISCONTINUE USING CKPTn]
 CKPTDEF (NO OPERANDS) – DISPLAY MODIFIABLE SPECIFICATIONS
 CKPTDEF (WITH OPERANDS) – ALTER MODIFIABLE SPECIFICATIONS

If **NEWCKPTn** is displayed, JES2 is about to replace the data set name and volume serial or the coupling facility structure name of the specified checkpoint data set (CKPT1 or CKPT2) with the specifications assigned to **NEWCKPTn**. JES2 requests the operator to verify or change the action to be taken. If the specifications are not what you require, change them by replying to the \$HASP272 message with the CKPTDEF (WITH OPERANDS) option, or select a new action.

If **NEWCKPTn** is not displayed, the specified checkpoint data set (CKPT1 or CKPT2) is being placed into service. JES2 is about to assign the checkpoint data set to data set name *dsname* on volume *volser* or coupling facility structure

\$HASP273

name *strname*, based on an explicit request (option 7 or 8) given to the \$HASP271/\$HASP272 message pair. JES2 requests the operator to verify or change the action to be taken. If the specifications are not what you require, change them by replying to the \$HASP272 message with the CKPTDEF (WITH OPERANDS) option, or select a new action.

Not all of the options appear for a given instance of this message.

In the message text:

n The number of the checkpoint or new checkpoint data set (either 1 or 2).

dsname The name of the new checkpoint data set.

volser The volume identifier.

strname The name of the coupling facility structure.

System action: JES2 issues message \$HASP272 and waits for an operator response.

Operator response: Determine the action you want taken and then reply to \$HASP272 with one of the options described below. Not all of the options appear for a given instance of this message.

Option Meaning

CONT JES2 completes the checkpoint assignment.

CANCEL

JES2 ends from the reconfiguration and continues processing. If you previously replied CKPTDEF to change CKPTn or NEWCKPTn, those changes are lost.

Note: CANCEL appears as an option only if this reconfiguration is **not** for an I/O error.

Attention: If the TERM option appears and you inadvertently reply CANCEL, JES2 will treat CANCEL as a synonym for TERM and terminate members.

TERM A reply of TERM is not recommended. If TERM appears as an option, JES2 is processing an I/O error for the CKPTn as indicated by message \$HASP233.

A reply of TERM causes **all** members experiencing an I/O error on CKPTn to end abnormally with a \$Kxx error code. The reason code on the \$HASP275 message for each member is the \$HASP095 error code for each member. Depending on the \$Kxx reason code given in the \$HASP275 message and the subsequent \$HASP095 error code, the TERM response may require an IPL or an all-member warm start. Although JES2 attempts to create an emergency backup copy of this data set before ending (see message \$HASP279), it may not be successful.

DELETE

JES2 reformats the other CKPTn data set (for example, CKPT2, if CKPT1 is displayed) and then deallocates the CKPTn data set specified in this message (\$HASP273). JES2 continues processing with only one checkpoint data set in use.

Note:

1. The DELETE option appears only if there is an I/O error on this member and both checkpoint data sets are in use (INUSE=YES). For example, if there is an error on CKPT1 and CKPT2 is not active, there is no DELETE option because that would leave no active checkpoint data set.
2. If your JES2 configuration is running in DUPLEX mode and any member has specified DUPLEX=OFF, JES2 does not delete the CKPT1 data set unless it can allocate the DUPLEX data set (CKPT2) on every member. If allocation is successful, JES2 issues message \$HASP280 indicating the CKPT2 data set is in use and then suspends the use of CKPT1. If allocation is not successful on this member, JES2 issues the \$HASP278/\$HASP272 message pair. If allocation is not successful on a non-driving member(s), JES2 issues message \$HASP234 and \$HASP235.

CKPTDEF

If you reply with a CKPTDEF statement with no operands, JES2 issues message \$HASP829 displaying the current settings of the CKPTDEF parameters that **can be modified** during a dialog. \$HASP289 is highlighted and is deleted after you reply to the \$HASP273/\$HASP272 message pair that JES2 reissues.

Note: If, during a reconfiguration dialog, you need to see the complete set of CKPTDEF specifications, issue the `$D CKPTDEF` command. If you only need to see specific parameter settings (for example, CKPT1 and CKPT2), issue the `$D CKPTDEF,CKPT1,CKPT2` command. JES2 responds by issuing message \$HASP829 showing only the CKPT1 and CKPT2 specifications.

CKPTDEF (WITH OPERANDS)

If you want to change a checkpoint specification, reply with a CKPTDEF statement with one or more of the operands listed below (for example, CKPTDEF CKPT1=...). JES2 scans the CKPTDEF statement and immediately resets the indicated parameters to the values specified. Message \$HASP829 is issued displaying the current settings of the modifiable parameters on the CKPTDEF initialization statement. \$HASP289 is highlighted and is deleted after you reply to the next \$HASP272 message that JES2 issues.

The CKPTDEF operands that can be modified are:

- CKPT1=
 - {(DSName=dsname,VOLser=volser)
 - (STRNAME=strname)} –
 - if not currently in use
- CKPT2=
 - {(DSName=dsname,VOLser=volser)
 - (STRNAME=strname)} –
 - if not currently in use
- NEWCKPT1=
 - {(DSName=dsname,VOLser=volser)
 - (STRNAME=strname)}
- NEWCKPT2=
 - {(DSName=dsname,VOLser=volser)
 - (STRNAME=strname)}
- DUPLEX={ON|OFF}

For an explanation of each operand, see the description of the CKPTDEF initialization statement in *z/OS JES2 Initialization and Tuning Reference*.

JES2 assumes you specified a checkpoint and attempts to process it. If the specification is null, JES issues the \$HASP282/\$HASP272 message pair to request your checkpoint specification. Otherwise, JES2 reissues the \$HASP273/\$HASP272 message pair to request confirmation of the checkpoint you specified.

System programmer response: If you are not familiar with the reconfiguration dialog process, see *z/OS JES2 Initialization and Tuning Guide* for a detailed discussion.

Module: HASPCKDS
Routing Code: 1,2,10,42
Descriptor Code: 2,7

\$HASP274

Explanation:

▶▶—MEMBER—*member-name*— – SYS1.EMERGENCY.HASPCKPT CREATED ON VOLUME—*volser*—▶▶

Because the checkpoint reconfiguration had an unrecoverable error, JES2 has created a copy of the in-storage version of the checkpoint in the data set named SYS1.EMERGENCY.HASPCKPT on the specified volume. If necessary, this data set can be used on an all-member warm start.

In the message text:

member-name

The name of the member that created an emergency checkpoint data set.

\$HASP275 • \$HASP276

volser The volume identifier on which the SYS1.EMERGENCY.HASPCKPT was created.

System action: JES2 stops processing.

Operator response: Inform the system programmer of the data set name and volume serial of the emergency checkpoint data set.

System programmer response: See *z/OS JES2 Initialization and Tuning Guide* for restarting JES2 from an emergency checkpoint.

Module: HASPCKDS

Routing Code: 1,2,10

Descriptor Code: 4

\$HASP275

Explanation:

▶▶—MEMBER—*member-name*—JES2 CKPTn DATA SET—I/O ERROR REASON CODE—*rsnc*—————▶
▶—————▶
▶—Modifier—*Modifier_mcode*—▶

An I/O error has occurred on the specified checkpoint data set (CKPT1 or CKPT2).
In the message text:

member-name

The name of the member experiencing the I/O error.

n

The number of the checkpoint data set. The number is either 1 or 2.

rsnc

A code identifying the cause of the error. The \$HASP275 reason codes correspond to the \$Knn error codes for \$HASP095. See the \$HASP095 message for their descriptions.

Modifier_mcode

The modifier code. The \$HASP275 modifier codes correspond to the RC for the \$Knn error codes for \$HASP095. See the \$HASP095 message for their descriptions.

System action: JES2 enters a checkpoint reconfiguration, issuing message \$HASP255.

Operator response: Notify the system programmer.

System programmer response: After completing the checkpoint reconfiguration, run EREP and then analyze the logrec data set to determine if the error was due to a hardware problem. Another possible reason for the error (with the exception of reason code \$K13) is that the JES2 program (for example, HASJES20) does not have the non-swappable attribute in the program properties table. Examine the SCHEDxx member in SYS1.PARMLIB to determine whether the JES2 program has the non-swappable attribute. See *z/OS JES2 Initialization and Tuning Reference* for more information.

Module: HASPCKDS

Routing Code: 1,2,10,42

Descriptor Code: 2,7

\$HASP276

Explanation:

▶▶—JES2 CANNOT USE THE REQUESTED CHECKPOINT DATA—————▶
▶—SET(S) DURING A {COLD START}—{WARM START WITH—RECONFIG SPECIFIED}—BECAUSE—*reason text*—————▶

CURRENT CHECKPOINT VALUES:

```
{CKPT1=(DSNAME=dsname,VOLSER=volser,
INUSE=xxx),}
{CKPT1=(STRNAME=strname,
INUSE=xxx),}
{CKPT2=(DSNAME=dsname,VOLSER=volser,
INUSE=xxx)}
{CKPT2=(STRNAME=strname,INUSE=xxx)}
```

VALID RESPONSES ARE:

```
CKPT1=... - UPDATE CURRENT
            CHECKPOINT
CKPT2=... - SPECIFICATION WITH THE
            VALUES JES2 SHOULD USE
'CONT'    - ATTEMPT INITIALIZATION
            WITH THE VALUES LISTED
'TERM'    - TERMINATE JES2
            INITIALIZATION ON THIS
            MEMBER
```

JES2 initialization processing is unable to access the displayed checkpoint data set(s). The reason for the failure is detailed in a preceding message and summarized in the *reason text* in this message. JES2 cannot continue until either the problem displayed has been resolved or you supply a usable checkpoint data set specification.

In the message text:

reason text

The reason initialization cannot continue

dsname

The name of the data set.

volser The volume identifier.

strname

The name of the coupling facility structure.

xxx Either YES or NO, indicating whether the data set is currently in use.

reason text is one of the following. See the previous message for more information on the reason for entering the dialog.

- **BOTH CKPT1 AND CKPT2 ARE INUSE=NO**
\$HASP472 is issued before entering dialog
- **CONNECT FOR CKPT_n FAILED RC=xxxxxxx RSN=xxxxxxx**
\$HASP536 is issued before entering dialog
- **OBTAIN FOR CKPT_n FAILED RC=xxxxxxx**
\$HASP414 is issued before entering dialog
- **VOLUME FOR CKPT_n NOT MOUNTED**
\$HASP424 is issued before entering dialog
- **ALLOCATE FOR CKPT_n FAILED RC=xxxxxxx S99ERROR=xxxx S99INFO=xxxx**
\$HASP581 is issued before entering dialog
- **CKPT_n FAILED ALLOCATION**
There is no related error message
- **DATA SET FOR CKPT_n HAS NO EXTENTS**
\$HASP453 is issued before entering dialog
- **TRACK SIZE TOO SMALL FOR CKPT_n DATA SET**
\$HASP295 is issued before entering dialog

\$HASP277

- **CKPT n DATA SET TOO SMALL**
\$HASP296 is issued before entering dialog
- **CKPT n VOLUME NOT SHARED**
\$HASP449 is issued before entering dialog
- **OF ABEND PROCESSING CKPT n DATA SET**
\$HASP095 is issued before entering dialog
- **OF I/O ERROR READING CKPT n**
\$HASP290 or \$HASP291 is issued before entering dialog
- **OF I/O ERROR LOCKING CKPT n**
\$HASP290 is issued before entering dialog
- **OF I/O ERROR RESERVING CKPT n**
\$HASP291 is issued before entering dialog
- **CKPT n FAILED VALIDATION PROCESSING**
\$HASP434 is issued before entering dialog
- **CKPT n STRUCTURE CONTAINS NO DATA**
\$HASP555 is issued before entering dialog
- **OPERATOR DID NOT ALLOW FORWARDING**
A reply of 'N' was given to \$HASP457 before entering the dialog
- **OPERATOR REPLIED 'N' TO \$HASP417 MESSAGE**
\$HASP416 and HASP417 are issued before entering dialog
- **CKPT1 STRUCTURE IS NOT LARGE ENOUGH**
\$HASP295 is issued before entering dialog

System action: JES2 issues message \$HASP272 and waits for an operator response. If you reply 'CKPT1', 'CKPT2', or CKPTDEF to \$HASP272, JES2 reissues message \$HASP276 with the updated checkpoint specification.

Operator response: To determine why the reconfiguration was entered, examine the previous message listed above. Either correct the cause of the error or reply 'CONT' to the subsequent \$HASP272 message. If the checkpoint information displayed is not correct, determine where the checkpoint data set is to be placed (if this is a cold start) or where the current checkpoint data resides (if processing a RECONFIG request). Respond to the \$HASP272 message with the correct CKPT n specification (for example, 'CKPT1=(DSNAME=TEST.CKPT1, VOLSER=TSTCK1, INUSE=YES)'). When message \$HASP276 displays the correct checkpoint specification, reply 'CONT' to the HASP272 message.

If the data set specification displayed is correct, then resolve the error described in the message and reply 'CONT'. JES2 initialization attempts to access the data sets again.

If needed, in response to the immediately following \$HASP272 message, you can respond CKPTDEF with operands to change the checkpoint data set names, the mode (DUPLEX or DUAL), and the size of the change log.

If you do not want to continue JES2 initialization, reply 'TERM'.

System programmer response: If you are not familiar with the initialization dialog process, see *z/OS JES2 Initialization and Tuning Reference* for a detailed discussion.

Module: HASPCKDS

Routing Code: 1,2,10,42

Descriptor Code: 2,7

\$HASP277

Explanation:

▶—JES2 CANNOT FIND OR USE THE CHECKPOINT DATA SET(S)————▶

▶ THAT WERE IN USE WHEN THE MAS WAS LAST ACTIVE BECAUSE—*reason text*—————▶

CURRENT CHECKPOINT VALUES:

```
CKPT1=(DSNAME=dsname,VOLSER=volser,
INUSE=xxx),
CKPT1=(STRNAME=strname,INUSE=xxx),
CKPT2=(DSNAME=dsname,VOLSER=volser,
INUSE=xxx),
CKPT2=(STRNAME=strname,INUSE=xxx),
```

VALID RESPONSES ARE:

```
CKPT1=... - UPDATE CURRENT CHECKPOINT
CKPT2=... SPECIFICATION WITH THE VALUES USED WHEN JES2 MAS WAS LAST ACTIVE
RECONFIG - THE CHECKPOINT DATA SET(S) THAT WERE IN USE WHEN JES2 WAS LAST
ACTIVE ARE NO LONGER AVAILABLE (ALL-MEMBER WARM START ONLY)
CONT - ATTEMPT INITIALIZATION WITH THE VALUES LISTED
TERM - TERMINATE JES2 INITIALIZATION ON THIS MEMBER
```

JES2 initialization processing is attempting to restore the checkpoint data set specification to the values that were last used by this MAS. JES2 saves the checkpoint specification information in the checkpoint data sets. JES2 will not complete initialization until all the checkpoint specification (the in-storage copy, the copy on CKPT1 and the copy on CKPT2) agree.

JES2 encounters a problem while searching for consistent checkpoint specifications that it cannot resolve without assistance. JES2 needs the names of the last active checkpoint data sets. If the data sets that were active when JES2 was last active are no longer available, then you must reconfigure the checkpoint. Reconfiguration bypasses the saved information in the checkpoint data sets and forces JES2 to start with the data set names specified. To reconfigure the checkpoint during initialization, reply 'RECONFIG' to the corresponding \$HASP272 message or reply 'TERM' to message \$HASP272 and restart JES2 with the start option 'RECONFIG'. 'RECONFIG' is only valid if this is an all-member warm start.

In the message text:

reason text

The reason initialization cannot continue

dsname

The name of the data set.

volser

The volume identifier.

strname

The name of the coupling facility structure.

xxx

Either YES or NO, indicating whether the data set is currently in use.

reason text is one of the following:

- **BOTH CKPT1 AND CKPT2 ARE INUSE=NO**
\$HASP472 is issued before entering dialog
- **CONNECT FOR CKPT_n FAILED RC=xxxxxxx RSN=xxxxxxx**
\$HASP536 is issued before entering dialog
- **OBTAIN FOR CKPT_n FAILED RC=xxxxxxx**
\$HASP414 is issued before entering dialog
- **VOLUME FOR CKPT_n NOT MOUNTED**
\$HASP424 is issued before entering dialog
- **ALLOCATE FOR CKPT_n FAILED RC=xxxxxxx S99ERROR=xxxx S99INFO=xxxx**
\$HASP581 is issued before entering dialog
- **CKPT_n FAILED ALLOCATION**

\$HASP277

There is no related error message

- **DATA SET FOR CKPT_n HAS NO EXTENTS**
\$HASP453 is issued before entering dialog
- **TRACK SIZE TOO SMALL FOR CKPT_n DATA SET**
\$HASP295 is issued before entering dialog
- **CKPT_n DATA SET TOO SMALL**
\$HASP296 is issued before entering dialog
- **CKPT_n VOLUME NOT SHARED**
\$HASP449 is issued before entering dialog
- **OF ABEND PROCESSING CKPT_n DATA SET**
\$HASP095 is issued before entering dialog
- **OF I/O ERROR READING CKPT_n**
\$HASP290 or \$HASP291 is issued before entering dialog
- **OF I/O ERROR LOCKING CKPT_n**
\$HASP290 is issued before entering dialog
- **OF I/O ERROR RESERVING CKPT_n**
\$HASP291 is issued before entering dialog
- **CKPT_n FAILED VALIDATION PROCESSING**
\$HASP434 is issued before entering dialog
- **CKPT_n STRUCTURE CONTAINS NO DATA**
\$HASP555 is issued before entering dialog
- **OPERATOR DID NOT ALLOW FORWARDING**
A reply of 'N' was given to \$HASP457 before entering the dialog
- **OPERATOR REPLIED 'N' TO \$HASP417 MESSAGE**
\$HASP416 and HASP417 are issued before entering dialog
- **STRUCTURE DOES NOT HAVE A DISP OF KEEP**
\$HASP536 is issued before entering dialog
- **STRUCTURE DATA SIZE IS INCORRECT**
\$HASP536 is issued before entering dialog
- **STRUCTURE IS NOT A LIST**
\$HASP536 is issued before entering dialog
- **STRUCTURE DOES NOT SUPPORT NAMED REFERENCES**
\$HASP536 is issued before entering dialog
- **STRUCTURE DOES NOT HAVE ENOUGH LIST HEADERS**
\$HASP536 is issued before entering dialog
- **STRUCTURE DOES NOT HAVE ENOUGH LOCK ENTRIES**
\$HASP536 is issued before entering dialog
- **STRUCTURE NOT ALREADY USED**
\$HASP536 is issued before entering dialog
- **STRUCTURE IS NOT LARGE ENOUGH**
\$HASP536 is issued before entering dialog

System action: JES2 issues message \$HASP272 and waits for an operator response. If you reply 'CKPT1' or 'CKPT2' to \$HASP272, JES2 reissues message \$HASP277 with the updated checkpoint specification.

Operator response: Determine where the checkpoint data set was located when JES2 was last active. If the checkpoint specification displayed is not correct, reply CKPT1 or CKPT2 to specify the correct data set names. When message \$HASP277 displays the correct values, reply 'CONT' to attempt to allocate the correct data sets.

If the values for CKPT1 and CKPT2 are the same as when JES2 was last active, and you do not want to change those specifications, then resolve the problem as described in the *reason text* and any preceding messages. When you resolve the problem, reply 'CONT' to attempt to complete initialization processing.

If the values listed are the ones JES2 was last using and the error listed cannot be resolved, bypass the checkpoint information saved in the checkpoint data set(s) by replying 'RECONFIG' causing JES2 to issue message \$HASP283. Respond to \$HASP283 to verify the checkpoint specifications you want JES2 to use.

A common cause for this message is that a checkpoint volume or structure is lost while JES2 is not active. In this case, you can change the specification for that data set to INUSE=NO (either in the initialization data set or in response to this message). This message is issued with *VOLUME FOR CKPTn NOT MOUNTED*. If the operator again sets the data set to INUSE=NO and replies 'CONT', JES2 reissues this message. This message will be continually re-issued because the saved information says that the data set is INUSE=YES. Without specifying 'RECONFIG' as a start option or in response to this message, JES2 will use the saved information rather than what the operator specified. To start JES2 in this situation, you must reply 'RECONFIG' or restart JES2 by specifying S JES2,PARM=RECONFIG.

This problem can also occur if you rename a JES2 checkpoint data set, you change the VOLSER of the volume containing the checkpoint, or you move the checkpoint data set without using a JES2 checkpoint reconfiguration to do so. Therefore, to avoid this problem, IBM suggests that you always use a JES2 checkpoint reconfiguration to move or alter the name of a checkpoint data set.

If you do not want to continue JES2 initialization, reply 'TERM'.

System programmer response: If you are not familiar with the initialization dialog process, see *z/OS JES2 Initialization and Tuning Reference* for a detailed discussion.

Module:

HASPCKDS

Routing Code: 1,2,10,42

Descriptor Code: 2,7

\$HASP278

Explanation:

- ▶▶ UNABLE TO LOCATE OR UNABLE TO USE CKPTn *dsname* ON *volser* STRNAME *strname* NEWCKPTn ▶

- ▶ DOES NOT EXIST OR IS NOT USABLE - REFER TO PREVIOUS MESSAGE(S) ▶

- ▶ VALID RESPONSES ARE: ▶

'CANCEL' - EXIT FROM RECONFIGURATION
'TERM' - TERMINATE MEMBERS WITH I/O ERROR ON CKPTn
'CREATE' - CREATE DATA SET
'DELETE' - DISCONTINUE USING CKPTn

- ▶ CKPTDEF (NO OPERANDS) - DISPLAY MODIFIABLE SPECIFICATIONS ▶

- ▶ CKPTDEF (WITH OPERANDS) - ALTER MODIFIABLE SPECIFICATIONS ▶

JES2 cannot locate or use the specified data set (CKPT1, CKPT2, NEWCKPT1, or NEWCKPT2) for one of the following reasons:

- If the checkpoint resides on DASD, the data set name *dsname* does not exist on volume *volser* specified on the CKPTDEF initialization statement.
- If the data set resides on a coupling facility, the structure *strname* is unusable.
- The reason identified in one of the previous messages. If the checkpoint resides on a coupling facility, structure, the \$HASP536 message would have preceded this message.

A data set residing on DASD might be rejected because:

- The data set is too small

-- or --

- An I/O error occurred while JES2 was reading the volume table of contents (VTOC).

\$HASP278

A coupling facility structure name is rejected if it does not have a coupling facility resource management (CFRM) policy.

Not all of the options appear for a given instance of this message.

In the message text:

n The number of the checkpoint or new checkpoint data set. The number is either 1 or 2.

dsname The name of the checkpoint data set.

volser The volume identifier.

strname The name of the coupling facility structure.

System action: JES2 issues message \$HASP272 and waits for an operator response.

Operator response: Determine the action you want to take and respond to message \$HASP272 with one of the options described below. Not all of the options appear for a given instance of this message.

Option Meaning

CANCEL

JES2 ends the reconfiguration and continues processing. If you previously replied CKPTDEF to change CKPTn or NEWCKPTn, those changes are lost.

Note: CANCEL appears as an option only if this reconfiguration is **not** for an I/O error.

Attention: If the TERM option appears and you inadvertently reply CANCEL, JES2 will treat CANCEL as a synonym for TERM and terminate members.

TERM A reply of TERM is not recommended. If TERM appears as an option, JES2 is processing an I/O error for the CKPTn as indicated by message \$HASP233.

A reply of TERM causes **all** members experiencing an I/O error on CKPTn to end abnormally with a \$Kxx error code. The reason code on the \$HASP275 message for each member is the \$HASP095 error code for each member. Depending on the \$Kxx reason code given in the \$HASP275 message and the subsequent \$HASP095 error code, the TERM response may require an IPL or an all-member warm start. Although JES2 attempts to create an emergency backup copy of this data set before ending (see message \$HASP279), it may not be successful.

CREATE

JES2 creates the specified data set on the volume displayed (*volser*).

Note:

1. The CREATE option appears only if the displayed DASD data set does not exist.
2. Because a structure cannot be dynamically allocated, the CREATE option is not shown for a checkpoint that is to reside on a coupling facility.

DELETE

JES2 reformats the other CKPTn data set (for example, CKPT2, if CKPT1 is displayed) and then deallocates the CKPTn data set specified in this message (\$HASP278). JES2 continues processing with only one checkpoint data set in use.

Note:

1. The DELETE option appears only if there is an I/O error on this member and both checkpoint data sets are in use (INUSE=YES). For example, if there is an error on CKPT1 and CKPT2 is not active, there is no DELETE option because that would leave no active checkpoint data set.
2. If your JES2 configuration is running in DUPLEX mode and any member has specified DUPLEX=OFF, JES2 does not delete the CKPT1 data set unless it can allocate the DUPLEX data set (CKPT2) on every member. If allocation is successful, JES2 issues message \$HASP280 indicating the CKPT2 data set is in use and then suspends the use of CKPT1. If allocation is not successful on this member, JES2 issues the \$HASP278/\$HASP272 message pair. If allocation is not successful on a non-driving member(s), JES2 issues message \$HASP234 and \$HASP235.

CKPTDEF

If you reply with a CKPTDEF statement with no operands, JES2 issues message \$HASP829 displaying the current settings of the CKPTDEF parameters that **can be modified** during a dialog. \$HASP289 is highlighted and is deleted after you reply to the \$HASP278/\$HASP272 message pair that JES2 reissues.

Note: If, during a reconfiguration dialog, you need to see the complete set of CKPTDEF specifications, issue the \$D CKPTDEF command. If you only need to see specific parameter settings (for example, CKPT1 and CKPT2), issue the \$D CKPTDEF,CKPT1,CKPT2 command. JES2 responds by issuing message \$HASP829 showing only the CKPT1 and CKPT2 specifications.

CKPTDEF (WITH OPERANDS)

If you want to change a checkpoint specification, reply with a CKPTDEF statement with one or more of the operands listed below (for example, CKPTDEF CKPT1=...). JES2 scans the CKPTDEF statement and immediately resets the indicated parameters to the values specified. Message \$HASP829 is issued displaying the current settings of the modifiable parameters on the CKPTDEF initialization statement. \$HASP289 is highlighted and is deleted after you reply to the next \$HASP272 message that JES2 issues.

The CKPTDEF operands that can be modified are:

- CKPT1=

{(DSName=dsname,VOLser=volser)
(STRNAME=strname)} –
if not currently in use

- CKPT2=

{(DSName=dsname,VOLser=volser)
(STRNAME=strname)} –
if not currently in use

- NEWCKPT1=

{(DSName=dsname,VOLser=volser)
(STRNAME=strname)}

- NEWCKPT2=

{(DSName=dsname,VOLser=volser)
(STRNAME=strname)}

- DUPLEX={ON|OFF}

For an explanation of each operand, see the description of the CKPTDEF initialization statement in *z/OS JES2 Initialization and Tuning Reference*.

JES2 assumes you specified a checkpoint and attempts to process it. If the specification is null, JES issues the \$HASP282/\$HASP272 message pair to request your checkpoint specification. Otherwise, JES2 issues the \$HASP273/\$HASP272 message pair to request confirmation of the checkpoint you specified.

System programmer response: If you are not familiar with the reconfiguration dialog process, see *z/OS JES2 Initialization and Tuning Guide* for a detailed discussion.

Module: HASPCKDS

Routing Code: 1,2,10,42

Descriptor Code: 2,7

\$HASP279

Explanation:

▶—MEMBER—*member-name*— – SPECIFY EMERGENCY CKPT VOLUME SERIAL OR '*NONE*'—▶

During checkpoint reconfiguration, either JES2 had an unrecoverable error or the operator replied TERM to a

\$HASP280

\$HASP272 message. If the operator requests, JES2 attempts to provide the installation with an emergency copy of the checkpoint in the data set named SYS1.EMERGENCY.HASPCKPT, before terminating.

In the message text:

member-name

The name of the member terminating.

System action: JES2 waits for the operator's reply.

Operator response: If an emergency checkpoint data set is required, enter the volume serial of a volume on which the emergency copy of the checkpoint data set should be placed. IBM suggests that you create an emergency checkpoint, particularly if the *member-name* is the name of the driving member. See \$HASP285 for the name of the driving member.

Because DISP=NEW is forced for the SYS1.EMERGENCY.HASPCKPT data set, the volume chosen must not already have a data set by the same name on the volume. After you have responded, JES2 attempts to allocate a data set named SYS1.EMERGENCY.HASPCKPT (DISP=NEW) on the specified volume. If successful, JES2 copies the in-memory version of the checkpoint onto this new data set and then issues message \$HASP274. If JES2 fails to allocate or to format the new data set, this message is reissued asking the operator for a new volume serial.

If an emergency checkpoint data set is not required, reply *NONE* to this message.

Module:

HASPCKDS

Routing Code: 1,2,10

Descriptor Code: 2

\$HASP280

Explanation:

▶▶—JES2 CKPTn DATA SET—┌(dsname ON volser)┐┌IS NOW IN USE┐—————▶▶
└(STRNAME strname)┘└IS NO LONGER IN USE┘

The operator has specified, through the checkpoint reconfiguration dialog, that checkpoint processing should either begin or suspend the use of the CKPTn data set defined as *dsname* ON *volser* or coupling facility structure *strname*. JES2 issues this message to notify the operator of request completion.

In the message text:

n The number of the checkpoint data set. The number is either 1 or 2.

dsname

The name of the checkpoint data set.

volser The volume identifier.

strname

The name of the coupling facility structure.

System action: JES2 exits from the reconfiguration dialog and resumes normal processing either using or not using the specified CKPTn data set.

Operator response: None.

Module:

HASPCKDS

Routing Code: 1,2,10,42

Descriptor Code: 4

\$HASP281

Explanation:

▶▶—ARE YOU SURE THAT YOU WANT TO END THE CHECKPOINT—RECONFIGURATION BY CAUSING—*nn*—————▶▶
▶▶—MEMBERS WITH I/O ERRORS TO ABEND?—THIS COULD RESULT IN LOSS OF THE JOB QUEUE AND THE—————▶▶
▶▶—OUTPUT QUEUE REQUIRING A COLD START—————▶▶▶▶

VALID RESPONSES ARE:

'TERM' – CONFIRM THAT *nn* MEMBERS SHOULD BE TERMINATED
OTHER – CONTINUE RECONFIGURATION

JES2 is in a checkpoint reconfiguration because of an I/O error or a coupling facility failure. The operator had specified 'TERM' to exit the dialog. JES2 prompts the operator to confirm that the checkpoint reconfiguration should be ended and members terminated.

Note: Members that abend may need to be IPLed.
In the message text:

nn The number of members in the MAS with I/O errors.

System action: JES2 issues message and waits for an operator response.

Operator response: Determine the action you want taken and reply with one of the options described below.

Option Meaning

TERM The specified number of members that will be abended.

Note: Optional text will appear if *nn* is all the members of the MAS. If TERM is specified, JES2 issues message \$HASP279 then will abend the members.

Other Any other response entered causes JES2 to reissue the previous WTOR message. This message is then followed by \$HASP272.

Module: HASPCKDS

Routing Code: 1,2,10,42

Descriptor Code: 2,7

\$HASP282

Explanation:

▶▶—CKPT*n*—NEWCKPT*n*—DSNAME, VOLUME, AND STRNAME ARE NULL—————▶▶▶▶

VALID RESPONSES ARE:

'CANCEL' – EXIT FROM RECONFIGURATION
'TERM' – TERMINATE MEMBERS WITH I/O ERROR ON CKPT*n*
'DELETE' – DISCONTINUE USING CKPT*n*
CKPTDEF (NO OPERANDS) – DISPLAY MODIFIABLE SPECIFICATIONS
CKPTDEF (WITH OPERANDS) – ALTER MODIFIABLE SPECIFICATIONS

An attempt to use the displayed checkpoint (CKPT*n* or NEWCKPT*n*) has failed because there is a null specification for that checkpoint (that is, there is no data set name and volume serial, or structure name). Also, JES2 issues this message if these specifications have already been used (for example, to recover from a previous I/O error). JES2 prompts you for the action to be taken.

\$HASP282

A NEWCKPT n checkpoint can be null because:

- You have forwarded CKPT n in a previous reconfiguration, and have not yet re-specified NEWCKPT n .
- You have unsuccessfully attempted, within this reconfiguration, to forward CKPT n causing JES2 to nullify the NEWCKPT n specification.

If you still want to forward CKPT n , you must respecify CKPTDEF NEWCKPT n =(...) in response to \$HASP272.

Not all of the options appear for a given instance of this message.

In the message text:

n The number of the checkpoint or new checkpoint data set. The number is either 1 or 2.

System action: JES2 issues message \$HASP272 and waits for an operator response.

Operator response: Determine the action you want taken and reply to message \$HASP272 with one of the options described below. Not all of the options appear for a given instance of this message.

Option Meaning

CANCEL

JES2 ends the reconfiguration and continues processing. If you previously replied CKPTDEF to change CKPT n or NEWCKPT n , those changes are lost.

Note: CANCEL appears as an option only if this reconfiguration is **not** for an I/O error.

Attention: If the TERM option appears and you inadvertently reply CANCEL, JES2 will treat CANCEL as a synonym for TERM and terminate members.

TERM A reply of TERM is not recommended. If TERM appears as an option, JES2 is processing an I/O error for the CKPT n as indicated by message \$HASP233.

A reply of TERM causes **all** members experiencing an I/O error on CKPT n to end abnormally with a \$Kxx error code. The reason code on the \$HASP275 message for each member is the \$HASP095 error code for each member. Depending on the \$Kxx reason code given in the \$HASP275 message and the subsequent \$HASP095 error code, the TERM response may require an IPL or an all-member warm start. Although JES2 attempts to create an emergency backup copy of this data set before ending (see message \$HASP279), it may not be successful.

DELETE

JES2 reformats the other CKPT n data set (for example, CKPT2, if CKPT1 is displayed) and then deallocates the CKPT n data set specified in this message (\$HASP282). JES2 continues processing with only one checkpoint data set in use.

Note:

1. The DELETE option appears only if there is an I/O error on this member and both checkpoint data sets are in use (INUSE=YES). For example, if there is an error on CKPT1 and CKPT2 is not active, there is no DELETE option because that would leave no active checkpoint data set.
2. If your JES2 configuration is running in DUPLEX mode and any member has specified DUPLEX=OFF, JES2 does not delete the CKPT1 data set unless it can allocate the DUPLEX data set (CKPT2) on every member. If allocation is successful, JES2 issues message \$HASP280 indicating the CKPT2 data set is in use and then suspends the use of CKPT1. If allocation is not successful on this member, JES2 issues the \$HASP278/\$HASP272 message pair. If allocation is not successful on a non-driving member(s), JES2 issues message \$HASP234 and \$HASP235.

CKPTDEF

If you reply with a CKPTDEF statement with no operands, JES2 issues message \$HASP829 displaying the current settings of the CKPTDEF parameters that **can be modified** during a dialog. \$HASP289 is highlighted and is deleted after you reply to the \$HASP282/\$HASP272 message pair that JES2 reissues.

Note: If, during a reconfiguration dialog, you need to see the complete set of CKPTDEF specifications, issue the \$D CKPTDEF command. If you only need to see specific parameter settings (for example, CKPT1 and CKPT2), issue the \$D CKPTDEF,CKPT1,CKPT2 command. JES2 responds by issuing message \$HASP829 showing only the CKPT1 and CKPT2 specifications.

CKPTDEF (WITH OPERANDS)

If you want to change a checkpoint specification, reply with a CKPTDEF statement with one or more of the operands listed below (for example, CKPTDEF CKPT1=...). JES2 scans the CKPTDEF statement and immediately resets the indicated parameters to the values specified. Message \$HASP829 is issued displaying the current settings of the modifiable parameters on the CKPTDEF initialization statement. \$HASP289 is highlighted and is deleted after you reply to the next \$HASP272 message that JES2 issues.

The CKPTDEF operands that can be modified are:

- CKPT1=

```

{(DSName=dsname,VOLser=volser)
(STRNAME=strname)} -
    
```

if not currently in use

- CKPT2=

```

{(DSName=dsname,VOLser=volser)
(STRNAME=strname)} -
    
```

if not currently in use

- NEWCKPT1=

```

{(DSName=dsname,VOLser=volser)
(STRNAME=strname)}
    
```

- NEWCKPT2=

```

{(DSName=dsname,VOLser=volser)
(STRNAME=strname)}
    
```

- DUPLEX={ON | OFF}

For an explanation of each operand, see the description of the CKPTDEF initialization statement in *z/OS JES2 Initialization and Tuning Reference*.

JES2 assumes you specified a checkpoint and attempts to process it. If the specification is null, JES reissues the \$HASP282/\$HASP272 message pair to request your checkpoint specification. Otherwise, JES2 issues the \$HASP273/\$HASP272 message pair to request confirmation of the checkpoint you specified.

System programmer response: If you are not familiar with the reconfiguration dialog process, see *z/OS JES2 Initialization and Tuning Guide* for a detailed discussion.

Module: HASPCKDS

Routing Code: 1,2,10,42

Descriptor Code: 2,7

\$HASP283

Explanation:

```

▶▶—JES2 IS PROCESSING A 'RECONFIG'—REQUEST TO OVERRIDE THE—SAVED CHECKPOINT SPECIFICATIONS—▶▶
▶—WITH THE VALUES SPECIFIED BELOW—▶
    
```

```

KEYWORD=VALUE - TO CHANGE
THE VALUE OF ANY KEYWORD LISTED
'CONT' - TO CONTINUE INITIALIZATION
WITH THE VALUES LISTED
'TERM' - TERMINATE JES2 INITIALIZATION
ON THIS MEMBER
    
```

\$HASP284

VALID RESPONSES ARE:

```
{CKPT1=(DSNAME=dsname,VOLSER=volser,
INUSE=xxx),}
{CKPT1=(STRNAME=strname,INUSE=xxx),}
{CKPT2=(DSNAME=dsname,VOLSER=volser,
INUSE=xxx)}
{CKPT2=(STRNAME=strname,INUSE=xxx)}
MODE=mode,
LOGSIZE=size,
READFROM=filename
```

You requested JES2 to bypass the checkpoint specifications saved in the checkpoint data set and use the displayed checkpoint information. If JES2 is started with the S JES2,PARM=RECONFIG command, or you previously replied RECONFIG to message \$HASP277, JES2 issues this message. In response to this message, you can change the checkpoint data set names, the mode (DUPLEX or DUAL), and the size of the change log.

Note: JES2 performs minimal validation to ensure that the data sets specified are the correct data sets to be used. Therefore, it is your responsibility to ensure that one of the data sets specified contains the current checkpoint information.

In the message text:

dsname

The name of the data set.

volser The volume identifier.

strname

The name of the coupling facility structure.

xxx Either YES or NO, indicating whether the data set is currently in use.

mode Either DUAL or DUPLEX, indicating the mode the system should be in when initialization completes. (If the checkpoint is on a coupling facility, you must specify DUPLEX.)

size Number of 4K records to allocate for the change log

filename

CKPT1, CKPT2, or HIGHEST. CKPT1 or CKPT2 informs JES2 to initially read that checkpoint data set.

HIGHEST indicates that JES2 should determine and read the data set that has the most current data.

System action: JES2 issues message \$HASP272 and waits for an operator response. If you reply *keyword=value* to \$HASP272, JES2 reissues the \$HASP283 message and displays the updated checkpoint specification.

Operator response: Ensure that all the values displayed are correct for your checkpoint configuration. If any of the values displayed are not correct, reply to the \$HASP272 with the correct values.

When you are satisfied that all the displayed checkpoint information is correct, reply 'CONT' to the \$HASP272 message. JES2 initialization continues with the values provided.

If you do not want to continue JES2 initialization, reply 'TERM'.

System programmer response: If you are not familiar with the initialization dialog process, see *z/OS JES2 Initialization and Tuning Reference* for a detailed discussion.

Module: HASPIRDA

Routing Code: 1,2,10

Descriptor Code: 2,7

\$HASP284

Explanation:

▶▶—JES2 INITIALIZATION CHECKPOINT—DIALOG STARTED—▶▶

A JES2 checkpoint dialog is started because either JES2 initialization cannot determine which checkpoint data set or structure to use or JES2 cannot use the checkpoint data set(s) required to complete initialization.

System action: This dialog is limited to this single JES2 MAS member; other members of the MAS are not involved.

This message is followed by either message \$HASP276 or \$HASP277.

Operator response: Respond to subsequent checkpoint dialog messages, as requested by JES2. After the initialization dialog completes, JES2 initialization processing continues normally.

System programmer response: If you are not familiar with the initialization dialog process, see *z/OS JES2 Initialization and Tuning Reference* for a detailed discussion.

Module:

HASPCCKDS

Routing Code: 1,2,10,42

Descriptor Code: 2,7

\$HASP285

Explanation:

▶▶—JES2 CHECKPOINT RECONFIGURATION—*status*—————▶▶

JES2 has entered a checkpoint reconfiguration with the following *status*:

STARTED – JES2 INITIALIZATION

A JES2 checkpoint reconfiguration is started because: the operator specified RECONFIG as a JES2 start option, JES2 initialization cannot determine which checkpoint data set or structure to use, or JES2 requests confirmation of the checkpoint specifications.

System Action: This reconfiguration is limited to this single JES2 MAS member; other members are not involved. This message is followed by message \$HASP289.

STARTING

A JES2 checkpoint reconfiguration is starting. JES2 has not yet chosen the driving member.

System Action: This message is replaced by the “STARTED – DRIVEN BY MEMBER” form of the message after checkpoint reconfiguration start-up processing completes. If JES2 cancels the reconfiguration, this message is followed by \$HASP255.

This message is highlighted on the member(s) where the reconfiguration originated because of an operator request. It is also issued to HRDCPY on all other members for diagnostic purposes.

STARTED – DRIVEN BY MEMBER *member-name*

A JES2 checkpoint reconfiguration has started and is being driven by member *member-name* because JES2 has determined that member has the most-current in-storage copy of the checkpoint.

System Action: After reconfiguration start-up processing completes, JES2 replaces any previous \$HASP285 messages that indicated “STARTING” with this form of the message.

This message is highlighted on the driving member and also issued to HRDCPY on non-driving members for diagnostic purposes.

JES2 continues reconfiguration processing.

RE-SYNCHRONIZING – DRIVEN BY MEMBER *member-name*

A JES2 checkpoint reconfiguration is re-synchronizing following the failure of the previous driving member. JES2 has determined that member *member-name* now has the next most-current in-storage copy of the checkpoint.

System Action: This message is highlighted on the driving member and also issued to HRDCPY on non-driving members for diagnostic purposes.

Reconfiguration processing continues. Depending on how far the reconfiguration progressed before re-synchronization, JES2 might need to involve the operator to complete reconfiguration processing. If the operator needs to be involved, JES2 issues the \$HASP271/\$HASP272 or \$HASP273/\$HASP272 message pair.

Operator response: Respond to subsequent checkpoint reconfiguration messages, as requested by JES2. After the reconfiguration completes, JES2 resumes normal processing.

System programmer response: None. If you are not familiar with the checkpoint reconfiguration process, see *z/OS*

\$HASP287 • \$HASP288

JES2 Initialization and Tuning Guide for a detailed discussion before responding to checkpoint reconfiguration dialog messages.

Module: HASPCKDS

Routing Code: 1,2,10,42

Descriptor Code: 2,7

\$HASP287

Explanation:

▶▶—ONLY ONE CHECKPOINT DATA SET—IS CURRENTLY IN USE—DUPLEX CHECKPOINT WRITES—WILL BE SUSPENDED—▶▶

The DUPLEX=ON parameter was specified in one of the following cases:

- On the CKPTDEF initialization statement
- On a \$T CKPTDEF command
- In response to a WTOR message during the reconfiguration dialog.

Because only one checkpoint data set is in use, the CKPTDEF,DUPLEX=ON request cannot be satisfied.

System action: JES2 suspends the duplexing function on all members of the configuration and continues processing.

Operator response: Notify the system programmer.

System programmer response: If you want, enter the checkpoint reconfiguration dialog to start using the data set that is not in use. JES2 automatically begins duplexing.

Module:

HASPCKPT

Routing Code: 1,2,10

Descriptor Code: 4

\$HASP288

Explanation:

▶▶—CKPT2 COULD NOT BE ALLOCATED.—DUPLEX CHECKPOINT WRITES—WILL BE SUSPENDED—▶▶

While running in DUPLEX mode, either:

- The operator entered a \$T CKPTDEF,DUPLEX=ON command
- The operator replied CKPTDEF DUPLEX=ON in response to a WTOR message during the checkpoint reconfiguration dialog.

Because JES2 could not access the CKPT2 data set on this member, the request could not be satisfied.

System action: JES2 suspends the duplexing function on this member and continues processing.

Operator response: Notify the system programmer.

System programmer response: Message \$HASP414 precedes this message. Examine the completion code given in \$HASP414 to determine why the allocation failed and correct the problem. JES2 automatically begins duplexing.

Module:

HASPCKPT

Routing Code: 1,2,10

Descriptor Code: 4

\$HASP289

Explanation:

▶▶—CKPT1 AND/OR CKPT2—SPECIFICATIONS ARE REQUIRED.—REPLY TO HASP272—————▶▶
 ▶—(MULTIPLE TIMES IF NECESSARY)—————▶▶

VALID RESPONSES ARE:

CKPTDEF (NO OPERANDS) – PRODUCE
 A DISPLAY OF ALL CKPTDEF
 SPECIFICATIONS
 CKPTDEF (WITH OPERANDS) – FUNCTIONS
 JUST AS IF IT WERE IN THE JES2
 INITIALIZATION DATA SET
 'END' – IF FINISHED WITH SPECIFICATIONS
 'TERM' – TERMINATE JES2

JES2 is initializing and one of the following is true:

- It cannot determine the correct data set specifications for CKPT1, CKPT2, or both.
- The PARM=RECONFIG initialization option was specified.
- RECONFIG=YES was specified on the CKPTDEF initialization statement.

A checkpoint reconfiguration entered during initialization is limited to a single JES2 member only. Therefore, be certain that the parameters you specify here are consistent with the checkpoint specifications currently in use by this JES2 MAS or are only those parameters that you can change on an all-member warm start.

This message asks the operator to reply with a CKPTDEF statement specifying the necessary data set information.

System action: JES2 issues message \$HASP272 and waits for an operator response.

Operator response: Determine the action you want taken and reply to message \$HASP272 with one of the options described below.

Option Meaning

CKPTDEF

If you reply with a CKPTDEF statement with no operands, JES2 issues message \$HASP829 displaying the current settings of the parameters on the CKPTDEF initialization statement. \$HASP829 is highlighted and is deleted after you reply to the \$HASP289/\$HASP272 message pair that JES2 reissues.

CKPTDEF (WITH OPERANDS)

If you want to respecify CKPTDEF specification such as data set names and volume serials or the structure name of checkpoint data sets, reply with a CKPTDEF statement with appropriate parameters (for example,

```
CKPTDEF
CKPT1=(DSN=dsname,VOL=volser),
CKPT2=...)
```

JES2 scans the CKPTDEF statement and immediately resets the indicated parameters to the values specified. Message \$HASP829 is issued displaying the current settings of the modifiable parameters on the CKPTDEF initialization statement. \$HASP289 is highlighted and is deleted after you reply to the next \$HASP289/\$HASP272 message pair that JES2 reissues.

For a description of each operand, see the description of the CKPTDEF initialization statement in *z/OS JES2 Initialization and Tuning Reference*.

END When you are satisfied with the checkpoint specifications, reply END. JES2 initialization continues using the new specifications.

TERM JES2 initialization ends.

System programmer response: If you are not familiar with the reconfiguration dialog process, see *z/OS JES2 Initialization and Tuning Guide* for a detailed discussion.

Module:

\$HASP290 • \$HASP291

HASPCCKDS

Routing Code: 1,2,10

Descriptor Code: 2,7

\$HASP290

Explanation:

```
| ►►—MEMBER—member_name— — JES2—ckptn—IXLLSTE MOVE—REQUEST FAILURE—IXLLSTE WRITE—►
|                                     |IXLLSTM READ—
|                                     |IXLLSTC LOCK—
|                                     |IXLLSTM READ LIST—
|                                     |IXLLSTM DELETE MULT—
|                                     |IXLALTER—
```

```
*** CHECKPOINT DATA SET {NOT}
DAMAGED ***
RETURN CODE=cc
REASON CODE=rrrrrrr
RECORD=nnnnnnnn
```

JES2 detects a failure attempting to access a checkpoint data set that resides on a coupling facility. Depending on the point in JES2 processing where the error occurred, data might have been read or written and the error might or might not make the data set inaccessible.

In the message text:

```
| n          The number of the checkpoint data set (1 or 2).
| cc         Specifies the hexadecimal return code from the IXLLSTx macro service.
| rrrrrrr    Specifies the hexadecimal reason code from the IXLLSTx macro service.
| nnnnnnnn   Specifies the checkpoint data set record to which I/O was attempted (The possible values for nnnnnnnn are
|              CHECK, LOCK, MASTER, CHANGE_LOG, 4K_PAGE, or UNKNOWN).
```

System action: JES2 continues processing while issuing messages informing the operator of possible recovery actions. If the error is not severe, JES2 continues processing without operator intervention.

Operator response: Notify the system programmer and respond to subsequent messages as directed.

System programmer response: Determine the severity and extent of the error (type of request that failed, data set record to which I/O was attempted) from the information provided. For a complete list of these request failure return and reason codes, see *z/OS MVS Programming: Sysplex Services Reference*. Determine the appropriate recovery procedure and respond to subsequent messages to perform recovery.

Module: HASPCFDE, HASPCFFC, HASPCFLE, HASPCFMT, HASPCFQL, HASPCFRD, HASPCFRE, HASPCFRL, HASPCFRS, HASPCFR2, HASPCFSI, HASPCFWP, HASPCFWR

Routing Code: 1,2,10

Descriptor Code: 4

\$HASP291

Explanation:

```
►►—MEMBER—member-name — — JES2 CKPTn DATA SET I/O ERROR—►
```

```
VOL=volser,DSN=dsname *** CHECKPOINT DATA SET { NOT }
      { POSSIBLY }
DAMAGED BY THIS MEMBER *** EXCP COMP CODE = cc      IOS COMP CODE
= cc CSW UNIT STATUS = hh      CSW CHNL STATUS = hh
CSW RESIDUAL CT = hhh IOB SENSE DATA = sens
```

```
{DEVICE SENSE = ssssssss ssssssss ssssssss ssssssss ssssssss
 ssssssssssssssss ssssssss}
{CURRENT CCW(S)}
{address1 = opwwwwww, wwwwwwww RECORD = nnnnnnnn}
{CCHHR = cchhr1}
{address2 = opwwwwww, wwwwwwww RECORD = nnnnnnnn}
{CCHHR = cchhr2}
{No CURRENT CCW}
```

A permanent I/O error (I/O completion code other than X'7F') has been detected for a JES2 checkpoint data set I/O operation. Depending on the point in JES2 processing where the error occurred, data may have been read or written and the error may or may not be catastrophic.

In the message text:

member-name

The name of the JES2 member experiencing the I/O error.

n The number of the checkpoint data set. Is either 1 or 2.

volser The volume identifier.

dsname

The name of the checkpoint data set.

cc Specifies the completion code returned (in hexadecimal). It may be one of the following:

- 41 (PERMANENT ERROR)
- 42 (EXTENT VIOLATION)
- 44 (INTERRUPT CONDITION)
- 4F (ERROR RECOVERY FAILURE)
- 6D NO PATHS AVAILABLE
- cc (UNKNOWN)

hh Specifies the unit status returned in the CSW. It may be one or a combination of the following:

- 80 Attention
- 40 Status modifier
- 20 Control unit end
- 10 Control unit busy
- 08 Channel end
- 04 Device end
- 02 Unit check
- 01 Unit exception

Specifies the channel status returned in the CSW. It may be one or a combination of the following:

- 80 Program controlled interruption
- 40 Incorrect length
- 20 Program check
- 10 Protection check
- 08 Channel data check
- 04 Channel control check
- 02 Interface control check
- 01 Chaining check

hhhh Specifies the CSW residual byte count in hexadecimal.

sens Specifies the sense byte 0 returned in the IOB. It may be one or a combination of the following:

- 80 Command reject
- 40 Intervention required
- 20 Channel bus out parity check
- 10 Equipment check
- 08 Data check
- 04 Overrun

Specifies the sense byte 1 returned in the IOB. It may be one or a combination of the following:

- 80 Permanent error
- 40 Incorrect track format
- 20 End of cylinder
- 10 Message to operator
- 08 No record found
- 04 File protected
- 02 Write inhibited

\$HASP292

sssssss

Complete device specific sense information (set after a unit check). See the appropriate device document for an explanation of the sense information.

opwwwwww,wwwwwwww

Specifies the CCW that failed, where *op* may be one of the following:

03 (NO-OP)
05 (WRITE DATA)
06 (READ DATA)
07 (SEEK)
08 (TIC)
0E (READ KD)
1D (WRITE CKD)
23 (SET SECTOR)
29 (SRCH KEY EQ)
31 (SRCH ID EQ)
op (UNKNOWN)

nnnnnnnn

Specifies the checkpoint data set record to which I/O was attempted. It may be one of the following:

CHECK
LOCK
MASTER
CHANGE-LOG
4K-PAGE
UNKNOWN

System action: JES2 continues processing while issuing messages informing the operator of possible recovery actions. If the error is not severe, JES2 continues processing without operator intervention.

Note: JES2 issues a \$SDUMP to allow examination of the IOB and CCW packets when \$HASP291 is issued for a checkpoint data set I/O error indicating command reject in IOB sense byte 0.

Operator response: Notify the system programmer and respond to subsequent messages as directed.

System programmer response: Determine the severity and extent of the error (channel, control unit, device, media) from the channel status word and sense byte information provided. Determine the appropriate recovery procedure and respond to subsequent messages to perform recovery.

Module: HASPCKPT

Routing Code: 1,2,10

Descriptor Code: 4

\$HASP292

Explanation:

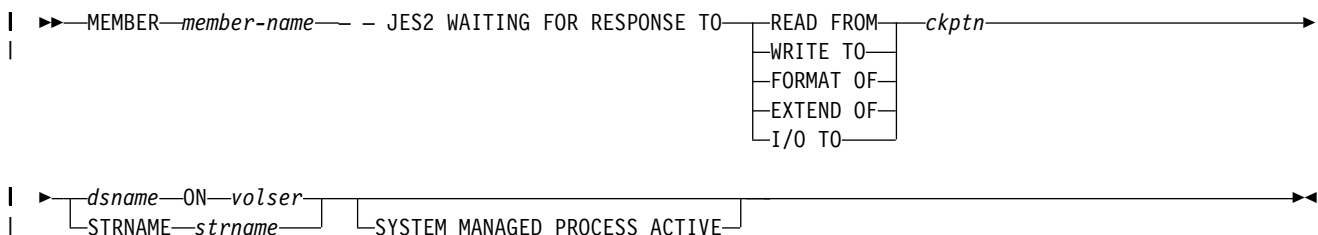

| Indicates that the device housing the specified checkpoint (a coupling facility or DASD) has not responded to JES2 after the indicated checkpoint operation was initiated. The value of MASDEF LOCKOUT is the elapsed time that the device has not responded.

| This is a normal condition if checkpoint is on a coupling facility that is being dumped.

| I/O indicates miscellaneous operations such as checkpoint lock and checkpoint query processing.

In the message text:

| **member-name**
 | The name of the JES2 member issuing the message.

| **ckptn** Checkpoint file being processed (CKPT1 or CKPT2).

| **STRNAME strname**
 | Indicates the checkpoint is housed in the structure name specified.

| **dsname ON volser**
 | Indicates the checkpoint is housed in the DASD data set and volser specified.

| **System action:** JES2 repeats this message (the time interval is the current value of MASDEF LOCKOUT) until JES2 receives a response from the device indicating checkpoint processing progress or the operation completes.

| **Operator response:** Attempt to determine the cause of the delay using other related messages or symptoms. If the checkpoint is on a coupling facility and the message states that a system managed process is in progress, this is a normal condition. However, if the condition persists, it may be because of an XCF signalling problem or a failed system. Check for any outstanding WTORs. If the condition cannot be cleared, then consider stopping the system managed process (using the SETXCF command) if appropriate. If the condition does not clear, consider initiating a checkpoint reconfiguration using the \$T CKPTDEF,RECONFIG=YES command to assign a new JES2 checkpoint data set. If a reconfiguration is requested, it may take the form of an I/O error because the current I/O must be purged and an I/O error simulated.

| **System programmer response:** None

| **Module:** HASPCKPT

| **Routing Code:** 1,2,10

| **Descriptor Code:** 4

\$HASP293

Explanation:

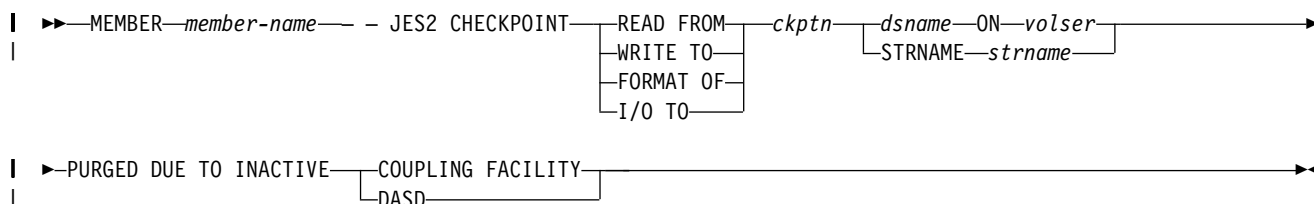

| Indicates that while checkpoint I/O is active, JES2 detected a request for a checkpoint reconfiguration, and the checkpoint device (DASD or coupling facility) has not responded to JES2 within approximately one minute. I/O indicates miscellaneous operations such as checkpoint lock and checkpoint query processing. In the message text:

| **member-name**
 | The name of the JES2 member issuing the message.

| **ckptn** Checkpoint file being processed (CKPT1 or CKPT2).

| **STRNAME strname**
 | Indicates the checkpoint is housed in the structure name specified.

| **dsname ON volser**
 | Indicates the checkpoint is housed in the DASD data set and volser specified.

| **System action:** The current I/O is purged, and JES2 reenters the checkpoint reconfiguration.

| If the current checkpoint I/O has been initiated as the result of a JES2 checkpoint reconfiguration, JES2 may issue message \$HASP282 to indicate a null NEWCKPTn specification.

| **Operator response:** Respond to the checkpoint reconfiguration messages with an appropriate option to recover from the error.

| Attempt to determine the cause of the delay using other related messages or symptoms.

\$HASP294 • \$HASP295

System programmer response: None

Module: HASPCKPT

Routing Code: 1,2,10

Descriptor Code: 4

\$HASP294

Explanation:

▶▶—WAITING FOR RESERVE (VOL *volser*).—REPLY 'CANCEL' TO END WAIT—▶▶

This copy of JES2 is waiting for the RESERVE on volume *volser* to be accepted. If you want to discontinue the wait, reply CANCEL.

In the message text:

volser The volume identifier.

System action: The system waits for either a response of CANCEL or for the RESERVE to be successful.

Operator response: Issue the D GRS command to determine what resource is reserving the volume. If you believe the RESERVE will never be successful, reply CANCEL. The reconfiguration starts again from the beginning; at which time you can define an accessible volume.

If you believe the RESERVE will be successful, wait. The message will be deleted when the RESERVE completes.

Module:

HASPCKDS

Routing Code: 1,2,10

Descriptor Code: 2,7

\$HASP295

Explanation:

▶▶—MEMBER—*member-name*— —
 ┌CKPT*n*—*dsname*—ON—*volser*—▶▶
 └NEWCKPT*n*—

▶ — TRACK SIZE INSUFFICIENT — — EXCEEDED BY—*m*—BYTES —▶▶

| JES2 has determined that the volume on which the specified checkpoint data set resides has an insufficient track size
| to contain the control information portion of the JES2 checkpoint data set.

In the message text:

member-name

The name of the JES2 member experiencing the problem.

n

The number of the checkpoint or new checkpoint data set. The number is either 1 or 2.

dsname

The checkpoint data set name.

volser

The volume on which the checkpoint resides.

m

The number of additional bytes required to accommodate the control information.

System action: If JES2 is in initialization, JES2 initiates a checkpoint reconfiguration dialog. If JES2 is already within a checkpoint reconfiguration, JES2 prompts the operator for alternative actions. If this is an operator command (\$T or \$ACTIVATE) the command is failed with a \$HASP003 message.

Operator response: Notify the system programmer and reply to the dialog messages.

System programmer response: Do one of the following:

- If you are cold starting JES2, change the values of initialization parameters that affect the size of the control information (such as JOBNUM on the JOBDEF initialization statement or JOENUM on the OUTDEF initialization statement).
- If this is an \$T command, choose a smaller value for the keyword you are modifying.
- If this is a \$ACTIVATE command, then you must decrease one of the CKPT size related parameters before issuing the \$ACTIVATE command. The parameters that can be decreased are CKPTSPACE BERTNUM=, JOBDEF JOBNUM=, OUTDEF JOENUM=.
- Use a direct access storage device with a larger track size.

If you are unfamiliar with the JES2 checkpoint reconfiguration dialog process, see *z/OS JES2 Initialization and Tuning Guide* for assistance.

Module: HASPCKDS

Routing Code: 1,2,10

Descriptor Code: 4

\$HASP296

Explanation:

▶▶ MEMBER—*member-name* — — CKPT*n* — *dsname*—ON—*volser* —————▶
 └─NEWCKPT*n*┐

| ▶ — — SPACE INSUFFICIENT — — *m*—TOTAL TRACKS NEEDED —————▶▶

An insufficient amount of space was allotted to the specified checkpoint data set. In the message text:

member-name

The name of the JES2 member experiencing the problem.

n

The number of the checkpoint or new checkpoint data set. The number is either 1 or 2.

dsname

The checkpoint data set name.

volser

The volume serial on which the checkpoint data set resides.

m

The total number of tracks needed to accommodate the checkpoint data set.

System action: JES2 initiates a checkpoint reconfiguration. If a checkpoint reconfiguration is already in progress, JES2 prompts the operator for alternative actions.

Operator response: Notify the system programmer and reply to the dialog messages.

System programmer response: Verify the checkpoint definition. If required, change the definition and use a larger data set. If you are unfamiliar with the dialog process, see *z/OS JES2 Initialization and Tuning Guide* for a detailed discussion.

Module:

HASPCKDS

Routing Code: 1,2,10

Descriptor Code: 4

\$HASP297

Explanation:

▶▶ MEMBER—*member-name* — — UNABLE TO OBTAIN NEEDED STORAGE—IN NON-EXTENDED PRIVATE —————▶▶

A GETMAIN for private virtual storage below 16 megabytes has failed.

\$HASP298 • \$HASP299

In the message text:

member-name

The name of the member experiencing the problem.

System action: If JES2 is in initialization, JES2 initiates a checkpoint reconfiguration dialog. If JES2 is already within a checkpoint reconfiguration, JES2 prompts the operator for alternative actions.

Operator response: Notify the system programmer.

System programmer response: Either increase the amount of private storage available to JES2 or change the initialization parameters to reduce the amount of storage needed.

Module: HASPCKDS

Routing Code: 1,2,10

Descriptor Code: 4

\$HASP298

Explanation:

▶▶—INVALID RECORD ENCOUNTERED ON CKPTn—WRITTEN BY MEMBER—*memname*—————▶▶

While processing updates from the CKPTn data set's change log, JES2 has discovered an incorrect change log record. In the message text:

n The number of the checkpoint data set. The number is either 1 or 2.

memname

The member name of the member that wrote the incorrect record.

System action: A \$K20 abend message is issued and JES2 stops processing.

Operator response: Notify the system programmer.

System programmer response: Use the indicative dump and the SVC dump (if any) to diagnose the error. If CKPT2 encountered an error, restart the failed member specifying PARM=CKPT1. If CKPT1 encountered an error, specify PARM=CKPT2. If storage overlay on member *memname* is suspected, re-IPL that member. On the remaining members in the configuration, enter the \$T CKPTDEF,RECONFIG=Yes command (the blank between the \$T and CKPTDEF is optional) to move CKPTn to a different volume using the checkpoint reconfiguration dialog.

Note: If no valid checkpoint data set is available to restart the failed member, you can recover from the error by performing an all-members warm start and bypassing the change log.

Module: HASPCKPT

Routing Code: 1,2,10

Descriptor Code: 4

\$HASP299

Explanation:

▶▶—'*verb*'— INVALID – PLEASE RESPECIFY—————▶▶

JES2 found that the *verb* of the last response entered for a WTOR message was incorrect. During the checkpoint reconfiguration dialog, all replies must begin with a *verb*. The operator must give a new reply. Examples of JES2 verbs are CONT, DELETE, or CKPTDEF. Reasons why the *verb* may be incorrect are:

- The *verb* is spelled incorrectly.
- The *verb* is a valid JES2 *verb* but is not a valid *verb* for this particular WTOR message.
- The response did not begin with a *verb* and JES2 is reading the first part of the response as the *verb.verb*.

System action: JES2 re-issues the original WTOR message and then waits for a reply.

Operator response: Read the descriptions of the valid responses to this particular WTOR message and then give a new reply.

Module: HASPCKDS

Routing Code: 1,2,10

Descriptor Code: 2,7

Chapter 7. Three-hundreds

The following JES2 messages are numbered in the 300-399 range.

\$HASP301

Explanation:

▶▶—*jobname*— – DUPLICATE JOBNAME— – JOB DELAYED—▶▶

The specified job was delayed for processing because a job of the same name was already running.
In the message text:

jobname

The name of the job.

Note: The HASP301 message will no longer be issued when a JES2 MAS consists of only release 1.8 and above members.

System action: The indicated job will be run when the job with the same name finishes running.

Operator response: None.

Module: HASPXEQ

Routing Code: 1,2

Descriptor Code: 4

\$HASP303

Explanation:

▶▶—*jobname*—RE-ENQUEUED AND HELD—▶▶

The specified job was requeued for processing and has been placed in JES2 HOLD status. The job ended abnormally and was restartable.
In the message text:

jobname

The name of the job.

Note: A jobid may precede \$HASP303. See “JES2 message format” on page 1.

System action: Processing continues.

Operator response: Determine the reason the job was placed in JES2 HOLD status and when appropriate, release the job for further processing.

Module: HASCJBST

Routing Code: 2

Descriptor Code: 6

\$HASP305

Explanation:

▶▶—FAILURE DURING CONVERSION FOR JOB—*jobname*—RC=*nnnnn*—▶▶

\$HASP307

A failure occurred during the conversion phase.
In the message text:

| *groupname*
| The name of the job group that is associated with a failure.

jobname The name of the job that failed during conversion.

nnnnnn The reason code with failure information:

 Error accessing CAT or JQA
 Error reading control blocks
 Error writing control blocks
 Error opening internal data sets, RC=&rc
 Exit indicated to fail job
 C/I subtask ABENDED
 Job Canceled
| Job already exists in job *groupname*
| Following job group not valid - *groupname*
| Job not associated with job group - *groupname*
| WITH= references job in the same job group
| WITH= reference creates a circular dependency between jobs
| JOBGROUP= requires Z22 checkpoint level

Note: A jobid may precede \$HASP305. See "JES2 message format" on page 1.

System action: The conversion of the specified job fails.

Operator response: If the condition persists, report it to your system programmer.

System programmer response: If the condition persists, contact your IBM service representative.

Module: HASPCNVT

Routing Code: 1,2,10

Descriptor Code: 4

\$HASP307

Explanation:

▶— *jobname*—cannot access PROCLIB—*ddname*—*reason*—▶

During JCL conversion, the procedure library that is specified by *ddname* could not be accessed. A DD card for the specified procedure library in the procedure that was used to start the subsystem, or in the dynamic PROCLIB concatenation, was either not found or encountered the problem specified in the message.

In the message text:

ddname The name of the procedure library.

reason The reason for the failure:

 OPEN failure
 DD not defined
 LRECL not valid
 BLKSIZE not valid
 Incorrect BLKSIZE and LRECL combination

System action: If the specified procedure library is other than PROC00, then an attempt is made to use PROC00. If PROC00 cannot be opened, an attempt is made to process the JCL without using a procedure library.

Operator response: Notify the system programmer.

System programmer response: Determine if the PROCLIB DD is specified correctly. If not, correct the JCL to use a correct PROCLIB. If it is specified correctly, determine why the PROCLIB cannot be accessed and correct the problem.

Programmer response: Check the value of the PROC= keyword on the /*JOBPARM JECL statement or the PROCLIB= keyword on the // JCLLIB JCL statement to see if the procedure library is specified correctly. Correct the value if necessary. Otherwise, notify the system programmer.

Module:

HASCCNVS

Routing Code: 2

Descriptor Code: 4

\$HASP308

Explanation:

▶▶—*jobname*—ESTIMATED TIME EXCEEDED—BY nnnnnnn MINUTES—▶▶

The indicated job has exceeded its estimated elapsed (wall clock) time in the JES2 execution phase by *nnnnnnn* minutes. In the message text:

jobname

The name of the job.

nnnnnnn

The time in minutes.

Note: A jobid may precede \$HASP308. See “JES2 message format” on page 1.

System action: Processing continues.

Operator response: Cancel the job if directed to do so by installation operating procedures.

Module:

HASPMISC

Routing Code: 1,2

Descriptor Code: 4

\$HASP309

Explanation:

▶▶—INIT—*init*—INACTIVE { ***** }—c=—*classes*—▶▶

The specified JES2 logical initiator is idle because no jobs of the classes indicated were available in the JES2 job queue.

In the message text:

init The initiator number or name.

classes The job classes.

System action: The execution processor activates the logical initiator when an appropriate job becomes available.

Operator response: If the initiator is not to be used for an extended period of time, enter a \$P init command for that initiator. Otherwise, enter a \$TI command to alter the job classes the initiator is to process or allow the initiator to remain inactive as required.

Module:

HASPXEQ

Routing Code: 1,2

Descriptor Code: 4

\$HASP310 • \$HASP312

\$HASP310

Explanation:

►►—*jobname*—TERMINATED AT END OF MEMORY—◄◄

The specified job is ended as a result of the abnormal end of the address space.
In the message text:

jobname

The name of the job.

Note: A jobid may precede \$HASP310. See “JES2 message format” on page 1.

System action: Processing continues.

Operator response: None.

Module: HASPXEQ

Routing Code: 1,2

Descriptor Code: 4

\$HASP311

Explanation:

►►—*jobname*—RE-QUEUED AT END OF MEMORY AND HELD—◄◄

The specified job has been re-queued for warm start processing as a result of the abnormal end of the address space in which it was running.
In the message text:

jobname

The name of the job.

Note: A jobid may precede \$HASP311. See “JES2 message format” on page 1.

System action: Processing continues.

Operator response: None.

Module:

HASPXEQ

Routing Code: 1,2

Descriptor Code: 4

\$HASP312

Explanation:

►►—*jobname*— JOB NOT CREATED.—*function*—NOT AVAILABLE DUE TO—SECURITY FAILURE.—◄◄

The security product failed a request to create the security environment for *function*.
In the message text:

jobname

The name of the job.

function

The name of the failed function.

Some of the values for *jobname*, and the corresponding values for *function* are:

jobname	function
SYSLOG	System log
\$JESNEWS	JES news
\$TRCLOG	JES2 trace

If *jobname* is a value other than those listed, the corresponding value of *function* is Application.

System action: Processing continues. However, the function indicated is not available.

Operator response: Notify the system programmer.

System programmer response: Look for prior error messages from your security product to determine the cause of the failure. Correct any security definitions or profiles to allow JES2 to create the security environment.

Module:

HASPRDR

Routing Code: 2,10

Descriptor Code: 4

\$HASP313

Explanation:

```

▶▶-jobname-JES2 IS UNABLE TO 

|        |
|--------|
| CREATE |
| DELETE |

 THE SECURITY ENVIRONMENT▶▶
▶-SECURITY PRODUCT RETURN CODE =-rrrrrrrr-REASON CODE =-sssssss▶▶
    
```

The specified job is canceled because JES2:

- could not create the security environment for the job to be converted
- could not delete the environment following the job's conversion
- is running in an environment where SECLABELs are active, but the userID associated with the JES2 address space is not defined with a SECLABEL of SYSMULTI. See *z/OS JES2 Initialization and Tuning Guide* for further explanation of using SECLABELs to provide system-level affinity.

either or . The return and reason codes are the hexadecimal values returned by the security product, (as opposed to the SAF return codes) for a RACROUTE REQUEST=VERIFY. See the documentation for your security product for an explanation of those values.

In the message text:

jobname	The name of the job.

Note: A jobid may precede \$HASP313. See "JES2 message format" on page 1.

System action: JES2 cancels the job.

Operator response: Notify the system programmer.

System programmer response: See the accompanying messages (from RACF or another security product), in addition to the return and reason codes, to determine the cause of the error. If the job originated from a member that had no security product installed, and the issuing member did have a security product installed, then the error may be due to incorrect data being passed on the JOB card. Otherwise, the error may indicate a problem with the security environment or the data passed to the security product. Correct the problem and resubmit the job.

\$HASP314 • \$HASP316

Module:

HASCCNVS

Routing Code: 1,2,10

Descriptor Code: 4

\$HASP314

Explanation:

▶▶—INIT—*init*—DRAINED { ***** }—c=—*classes*————▶▶

The operator has entered a \$PI command and the identified initiator has subsequently entered the DRAINED condition.

In the message text:

init The initiator number or name.

classes The job classes.

System action: If an initiator job can be associated with the identified initiator (address space creation has been verified), the job stops running and becomes eligible for output.

Operator response: Enter a \$SI command to create a new initiator to process jobs.

Module:

HASPXEQ

Routing Code: 1,2

Descriptor Code: 4

\$HASP315

Explanation:

▶▶—INIT—*init*—HALTED { ***** }—c=—*classes*————▶▶

The operator has entered a \$ZI command and the identified initiator has subsequently entered the HALTED condition.

In the message text:

init The initiator number or name.

classes The job classes.

System action: The initiator job associated with the identified initiator remains in an indefinite wait state.

Operator response: Enter a \$SI command to resume processing jobs with the initiator.

Module: HASPXEQ

Routing Code: 1,2

Descriptor Code: 4

\$HASP316

Explanation:

▶▶—*jobname*—HAS—

REPLACED
DELETED

—THE JESNEWS DATA SET————▶▶

The specified job has either replaced or deleted the JESNEWS data set.

In the message text:

jobname

The name of the job.

Note: A jobid may precede \$HASP316. See “JES2 message format” on page 1.

System action: Processing continues.

Operator response: None.

Module: HASPJOS

Routing Code: 1,2,7

Descriptor Code: 4

\$HASP319

Explanation:

►►—PROCLIB—(ddname) keyword=value—, ... —————►►
└—STATIC PROCLIB—┘

JES2 issues this message in response to a \$ADD, \$D, \$DEL, or \$T command for the PROCLIB statement. It is also issued in response to a PROCLIB initialization statement. It displays the keywords defined on this statement and their current values.

In the message text:

ddname The PROCLIB concatenation.

keyword The name of the keyword.

value The value of the keyword.

STATIC PROCLIB

Indicates that this PROCLIB DD name is a static PROCLIB concatenation from the JES2 PROC. Static PROCLIBs can be logically altered but they cannot be deleted.

The description of the PROCLIB statement in *z/OS JES2 Initialization and Tuning Reference* explains the parameters displayed in this message.

System action: Processing continues.

Operator response: None.

System programmer response: None.

Module: HASCSCAN

Routing Code: 1,2,10

Descriptor Code: 4

\$HASP321

Explanation:

►►—jobname—OUTGRP=—grpid joeid1 joeid2—PURGED - RECEIVER—DOES NOT HAVE ACCESS TO DATA—►►

A TSO RECEIVE command was issued for a data set that the requester is not authorized to access.

In the message text:

jobname

The name of the job

grpid The group identifier either assigned by the user JCL or generated by JES2 if the user did not specify it

joeid1 The number of job output elements in output group *grpid*

joeid2 The number of job output elements in the output group identified by *grpid* and *joeid1*

\$HASP322 • \$HASP323

Note: A jobid may precede \$HASP321. See "JES2 message format" on page 1.

System action: If the receiver's SECLABEL definition in the RACF profile includes the same or higher security label as the data set, JES2 keeps the data set for later access. Otherwise, JES2 deletes the data set. (This default processing may be changed by installation exit 38.)

Operator response: Inform the user to increase access authority.

User response: If authorized, logon at the appropriate security level to access the data set.

Module: HASPPSO

Routing Code: 2,9,10

Descriptor Code: 6

\$HASP322

Explanation:

▶▶—*jobname*—ERROR PREPARING FOR GROUPING ————
 ┌—STORAGE IN EPVT IS NOT AVAILABLE—┐
 ├—STORAGE IN ECSA IS NOT AVAILABLE—┤
 └—UNDEFINED JCL DEFINITION NAME—┘

JES2 detected an error while initializing work areas to collect a job's OUTPUT JCL keywords for output grouping. In the message text:

jobname

The name of the job.

text is one of the following:

STORAGE IN EPVT IS NOT AVAILABLE

There is not enough storage in the extended private storage area for grouping to occur.

STORAGE IN ECSA IS NOT AVAILABLE

There is not enough storage in the extended common storage area (ECSA) for grouping to occur.

UNDEFINED JCL DEFINITION NAME

JES2 attempted to group output using a JCL definition vector table (JDVT), which it could not locate.

Note: A jobid may precede \$HASP322. See "JES2 message format" on page 1.

System action: If the error occurs during the reception of SYSOUT, JES2 issues message \$HASP543 and then purges the incoming job. If the error occurs during job selection, JES2 fails the job select.

Operator response: Dump JES2 and notify the system programmer of the error.

System programmer response: Examine the dump to determine if a job or system component is using extreme amounts of extended private or common storage. In the case of an UNDEFINED JCL DEFINITION NAME, locate the source of the incorrect JDVT and correct the problem. If unable to determine the cause, contact the IBM Support Center.

Module: HASPNSR

Routing Code: 8,10

Descriptor Code: 4,6

\$HASP323

Explanation:

▶▶—*jobname*—ERROR DETERMINING GROUPING — —STORAGE IN EPVT IS NOT AVAILABLE—▶▶

JES2 detected an error while grouping a SYSOUT data set based on the OUTPUT JCL attributes. In the message text:

jobname

The name of the job.

text is:

STORAGE IN EPVT IS NOT AVAILABLE

There is not enough storage in the extended private storage area for grouping to occur.

Note: A jobid may precede \$HASP323. See "JES2 message format" on page 1.

System action: If the error occurs during reception of SYSOUT, JES2 issues message \$HASP543 and purges the incoming job. If the error occurs when a job requests an OPEN of a SYSOUT data set, the OPEN request fails. If the error occurs when JES2 opens a system data set, JES2 requeues the batch job for processing and ends the initiator. If the error occurs when a job unallocates a spin data set as a non-spin data set, JES2 leaves the data set as a spin data set.

Operator response: Obtain a dump of JES2 and notify the system programmer.

System programmer response: Examine the dump to determine if a job or system component is using extreme amounts of extended private or common storage. If unable to determine the cause, contact the IBM Support Center.

Module: HASPNSR

Routing Code: 8,10

Descriptor Code: 4,6

\$HASP324

Explanation:

►►—SCHEDULER FACILITY SERVICES SUSPENDED—◄◄

While processing a scheduler facility services request, JES2 detected an unrecoverable error.

System action: JES2 ends the scheduler facility processor control element (PCE).

Operator response: Request a dump of JES2 and notify the system programmer of the problem.

System programmer response: If the problem cannot be resolved, search problem reporting data bases for a fix for the problem. If no fix exists, contact the IBM Support Center.

Module: HASPSJFR

Routing Code: 1,2,10

Descriptor Code: 2,7

\$HASP325

Explanation:

►►—nnnnn—SJF REQUESTS—LOST DURING RESTART—◄◄

During a restart of JES2, JES2 determined that there were *nnnnn* scheduler facility requests to be processed that JES2 could not recover.

In the message text:

nnnnnn

The number of blocks lost.

System action: The restart continues.

Operator response: None.

Module: HASPSJFR

Routing Code: 2,10

\$HASP326

Descriptor Code: 4

\$HASP326

Explanation:

▶▶—*jobname*—SJF SERVICES REQUEST—*targetname targetid*—OUTGRP=—*grpname grpid1 grpid2*—————▶▶

▶ RC=01 - JOB NOT FOUND
| RC=02 - PROCESSING ERROR, RSNC=—*rsn*—
| RC=03 - REQUEST WAITING FOR RESOURCES—▶▶

The job specified requested that JES2 update the scheduler JCL facility (SJF) data associated with the specified OUTGRP. JES2 was unable to complete the request for the reasons given.

In the message text:

jobname

The job requesting the service

targetname

The jobname of the job that is being modified by the service

targetid

The job ID of the job being modified

grpname

The name of the output group.

grpid1 The first identifier JES2 assigned to the output.

grpid2 The second identifier JES2 assigned to the output.

Possible values of *text* and *rc* are:

rc	text
01	JOB NOT FOUND
02	PROCESSING ERROR, RSNC= <i>rsnc</i>
	<i>rsnc</i> Meaning
4	SAF authority check failure
8	I/O error on spool
12	Service routine error
16	DEST processing error
20	Error during \$SWBMERG/SJFREQ merge processing
24	Error during SWBTUREQ SPLIT processing
28	Subtask abended
32	IOT is not valid
36	Parameter or control block not valid
03	REQUEST WAITING FOR RESOURCES

System action: The system fails the SJF request and processing continues. The system creates a symptom record in SYS1.LOGREC.

Operator response: Contact the system programmer.

System programmer response: Use the environmental editing, recording, and printing program (EREP) to format SYS1.LOGREC and examine the output for the symptom record associated with this error. Report the return code (RC) and reason code (RSNC), if any, to the IBM Support Center.

Module: HASPSJFR

Routing Code: 2,10

Descriptor Code: 4

\$HASP329

Explanation:

▶▶—*jobname*—JOB VALIDATION FAILED—WITHOUT ACCOMPANYING MESSAGE—▶▶

▶—SECURITY PRODUCT RETURN CODE=—*rrrrrrrr*—REASON CODE=—*ssssssss*—▶

The security product failed the job without at least one accompanying message. This message is issued to hardcopy only and JES2 deletes the specified job. The return and reason codes are the hexadecimal values returned by the security product, (as opposed to the SAF return codes) for either a RACROUTE REQUEST=TOKENBLD or a RACROUTE REQUEST=VERIFY. See the documentation for your security product for an explanation of those values. In the message text:

jobname

The name of the job.

Note: A jobid may precede \$HASP329. See “JES2 message format” on page 1.

rrrrrrrr The security product return code.

ssssssss

The reason code.

System action: The job is routed to the print phase for appropriate action and then purged.

Operator response: Report this message to the system programmer.

System programmer response: No accompanying messages (from RACF or another security product) were returned to JES2. See the return and reason codes to determine the cause of the job validation failure. If the job originated from a member that had no security product installed, and the issuing member did have a security product installed, then the failure may be due to incorrect data being passed on the JOB card. Otherwise, the failure may indicate a problem with the security environment or the data passed to the security product. Correct the problem and resubmit the job.

Module: HASPSSRV

Routing Code: Message sent to hardcopy only.

Descriptor Code: 4

\$HASP347

Explanation:

▶▶—*jobname*—SYSOUT ALLOCATION FAILED—▶▶

JES2 cannot allocate a SYSOUT data set because an error occurred in an SJFREQ find or retrieve request or because an error occurred in scanning output references on a JCL DD statement.

In the message text:

jobname

The name of the job.

Note: A jobid may precede \$HASP347. See “JES2 message format” on page 1.

System action: If this was a static allocation, JES2 ends the job. For dynamic allocation, only the allocation fails.

Operator response: Notify the system programmer.

Programmer response: Check the job's JCL for an incorrect output reference.

\$HASP350 • \$HASP351

Module:

HASCDALS

Routing Code: 10

Descriptor Code: 6

\$HASP350

Explanation:

▶▶—*jobname*—INIT STOPPED—▶▶

JES2 has caused an initiator to stop. The initiator was stopped because of an operator request, because insufficient storage was available, or because the initiator had been started to run an STC or TSU job and that job had a JCL error.

In the message text:

jobname

The name of the job.

Note: A jobid may precede \$HASP350. See “JES2 message format” on page 1.

System action: The initiator should stop normally.

Operator response: None.

Module: HASCJBST

Routing Code: 2

Descriptor Code: 4

\$HASP351

Explanation:

▶▶—*jobid jobname*—SEGMENTATION SUSPENDED FOR—*ddname*,—RC=3 SEGMENT LIMIT REACHED—▶▶

JES2 stopped segmentation for the SYSOUT defined by *ddname*.

In the message text:

jobid The job identifier.

jobname The name of the job.

ddname The name of a DD statement.

text is one of the following:

RC=3 SEGMENT LIMIT REACHED

The SYSOUT being segmented has reached the number of segments specified in the SEGLIM= parameter of the OUTDEF statement.

System action: JES2 discontinues segmentation for the current output.

System programmer response:

RC=3 Determine why the job is exceeding the SEGLIM value and adjust SEGLIM if necessary.

Module: HASCHAM

Routing Code: 10

Descriptor Code: 6

\$HASP352

Explanation:

►►—*jobname*—OPEN FAILED BECAUSE NOT—SYSIN, SYSOUT, PROCESS-SYSOUT, NOR SPOOL BROWSE—————►►

An OPEN macro failed for a subsystem data set because JES2 could not determine the type of the data set from the data set name in the job file control block (JFCB).
In the message text:

jobname
The name of the job.

Note: A jobid may precede \$HASP352. See “JES2 message format” on page 1.

System action: Processing continues.

Programmer response: Resubmit the job ensuring that:

- MSGLEVEL=(1,1) is coded
- The failing step contains a SYSABEND DD statement.

Correct the incorrect data set type and resubmit job.

Module: HASCDSOC

Routing Code: 10

Descriptor Code: 6

\$HASP353

Explanation:

►►—*jobname*—CLOSE FAILED BECAUSE NOT—SYSIN, SYSOUT, PROCESS-SYSOUT, NOR SPOOL BROWSE—————►►

A CLOSE macro failed for a subsystem data set because JES2 could not determine the data set's type from the data set name in the JFCB.
In the message text:

jobname
The name of the job.

Note: A jobid may precede \$HASP353. See “JES2 message format” on page 1.

System action: Processing continues.

Programmer response: Correct the incorrect data set type and resubmit the job.

Module: HASCDSOC

Routing Code: 10

Descriptor Code: 6

\$HASP355

Explanation:

►►—SPOOL VOLUMES ARE FULL—————►►

A request for JES2 direct access spool space cannot be processed. All available space has been allocated to JES2 functions or no spool volumes are available. (Check the definition of the VOLUME= parameter on the SPOOLDEF initialization statement.)

This message is issued approximately every 30 seconds to the console by the first member to detect the shortage that

\$HASP357 • \$HASP358

also has the checkpoint. Because this resource is monitored on a MAS-wide basis, the operator will not see redundant messages issued to the console by every member if the MVS MSCOPE>(*ALL) command was specified, but messages from all members are written to hardcopy. If MSCOPE>(*ALL) was not specified in the MVS CONSOLxx PARMLIB member, the operator might miss seeing this message.

System action: The system suspends JES2 processors and users of JES2 services that require direct access space, until an output function completes and the associated direct access space becomes available, or another spool volume is added using the \$S SPOOL command.

Operator response: Take one or more of the following actions as appropriate:

- Identify any jobs using excessive amounts of spool space and take appropriate action. For example, cancel an executing job if it continues to use SPOOL at an unacceptable rate, or if it is being submitting to an internal reader that's in a loop.
- Purge old output and jobs.
- Offload old output and jobs using the SPOOL offload facility.
- Add more SPOOL volumes.
- If a very large job was recently deleted by a \$ZAPJOB command, rather than waiting for up to seven days for JES2 to recover its SPOOL space using SPOOL garbage collection, consider using a \$TSPOOLDEF,GCRATE=FAST command to recover the SPOOL space quickly.
- If SPOOL utilization reached 100% in seconds as a result of a programming error, first correct the cause of the problem. Then rather than waiting for up to seven days for JES2 to recover its SPOOL space using SPOOL garbage collection, consider using a \$TSPOOLDEF,GCRATE=FAST command to recover the SPOOL space quickly.

Note: Using \$TSPOOLDEF,GCRATE=FAST will not be useful for most SPOOL-full situations where the SPOOL space is legitimately owned by existing jobs.

Module: HASPCKPT

Routing Code: 1,2

Descriptor Code: 4

\$HASP357

Explanation:

▶▶—*jobname*—STORAGE UNAVAILABLE FOR SDB—▶▶

JES2 cannot allocate a subsystem data set, because storage within the user's address space is unavailable for a subsystem data set block.

In the message text:

jobname

The name of the job.

Note: A jobid may precede \$HASP357. See "JES2 message format" on page 1.

System action: The subsystem data set is not allocated.

Programmer response: Reduce the data set requirements of the job step.

Module: HASCSRDS

Routing Code: 10

Descriptor Code: 6

\$HASP358

Explanation:

▶▶—NO ACTIVE SPOOL VOLUMES—▶▶

A request for JES2 direct access spool space cannot be processed. One of the following conditions is true:

- There are no SPOOL volumes allocated to JES2. (Check the definition of the VOLUME= parameter on the SPOOLDEF initialization statement).
- There are no active volumes. That is, all volumes are halting, draining, or INACTIVE.

This message is issued approximately every 30 seconds to the console by the first member to detect the shortage that also has the checkpoint. Because this resource is monitored on a MAS-wide basis, the operator will not see redundant messages issued to the console by every member if the MVS MSCOPE>(*ALL) command was specified, but messages from all members are written to hardcopy. If MSCOPE>(*ALL) was not specified in the MVS CONSOLxx PARMLIB member, the operator might not see this message.

System action: The system suspends JES2 processors and users of JES2 services that require direct access space, until a volume becomes active.

Operator response: Add a spool volume (using the \$S SPL command) or make an already existing volume active by issuing a \$S SPL command.

Module: HASPCKPT

Routing Code: 1,2

Descriptor Code: 4

\$HASP359

Explanation:

▶▶—*jobname*—HCBGM – —NO STORAGE AVAILABLE—IN SP 230—▶▶

While attempting to start processing a job, JES2 has failed to obtain storage from the user address space to hold one of the job's direct access resident control blocks.

In the message text:

jobname

The name of the job.

Note: A jobid may precede \$HASP359. See "JES2 message format" on page 1.

System action: Processing continues.

System programmer response: Provide more common storage area.

Module: HASCSRDS

Routing Code: 10

Descriptor Code: 6

\$HASP360

Explanation:

▶▶—*jobname*—REQUESTS ACCESS TO JESNEWS—(Y OR N)—▶▶

The specified job is requesting permission to replace or delete the JESNEWS data set. This message is issued during subsystem data set allocation.

In the message text:

jobname

The name of the job.

Note: A jobid may precede \$HASP360. See "JES2 message format" on page 1.

System action: JES2 waits for the operator to reply Y or N.

Operator response: Reply Y or N. A reply of Y allows the job to replace or delete the JESNEWS data set. A reply of

\$HASP361

N prevents the job from replacing or deleting the data set and causes an allocation error.

Module: HASCDXSAL

Routing Code: 2

Descriptor Code: 6

\$HASP361

Explanation:

```
▶▶—jobname—JOB NOT FOUND—▶▶
      |
      |—SELECTED -RSN=nnxxxxxxxx—▶▶
```

JES2 was unable to select a job that was specified in a \$SJ command. The message text gives the reason why the job was not selected.

In the message text:

jobname

The name of the job.

nn The code for the reason why the job was not selected.

xxxxxxxx

The reason why the job was not selected.

The reason code and the reason will be one of the following:

- 02 SYSTEM DRAINING
- 03 JOB WITH SAME NAME ALREADY RUNNING
- 04 SCHEDULING ENVIRONMENT NOT AVAILABLE
- 05 INDEPENDENT MODE MISMATCH
- 06 SPOOL(S) NOT AVAILABLE
- 07 DISALLOWED BY \$EXIT 49
- 08 SECLABEL NOT AVAILABLE
- 09 NO AFFINITY TO ANY ACTIVE SYSTEM
- 10 UNEXPECTED RESPONSE FROM WLM
- 11 ARM RESTART PENDING
- 12 BUSY
- 13 NOT BATCH JOB
- 14 NOT ON EXECUTION QUEUE
- 15 NO JES2 CAN SELECT
- 16 JOBCLASS AFFINITY NOT AVAILABLE
- 17 Minimum z/OS level not available

Note: A jobid may precede \$HASP361. See "JES2 message format" on page 1.

System action: The requesting initiator is stopped.

Operator response: If you still want to start the job, correct the condition that made the job not selectable and reenter the command.

Module: HASCJBST

Routing Code: 10

Descriptor Code: 6

\$HASP362

Explanation:

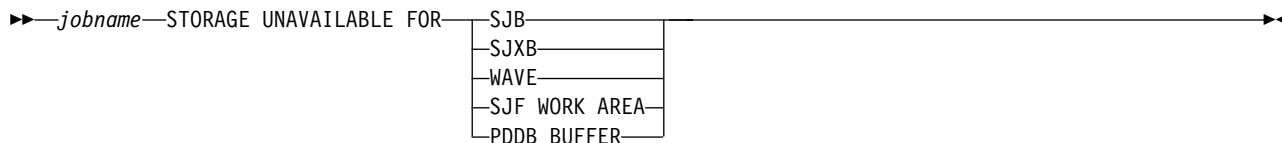

JES2 cannot continue processing for an initiator because JES2 has failed to obtain storage for one of the following:

- A subsystem job block (SJB)
- A subsystem job extension block (SJXB)
- A scheduler JCL facility (SJF) work area.
- A work access verification element (WAVE).
- A buffer for processing peripheral data definition blocks (PDDBs).

In the message text:

jobname

The name of the job.

Note: A jobid may precede \$HASP362. See “JES2 message format” on page 1.

System action: If a batch job is displayed, the initiator will stop normally. If an STC or TSU job is displayed, JES2 ends the job because insufficient storage is available.

Operator response: Notify the system programmer that this condition has occurred.

System programmer response: If this message occurs frequently for SJBs, increase the size of the common storage area.

Module: HASCSRJB

Routing Code: 10

Descriptor Code: 6

\$HASP363

Explanation:

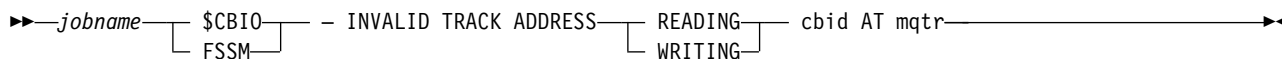

JES2 has attempted to read or write a disk-resident job control block to an incorrect track address. If \$CBIO appears in the message, the error has occurred in a JES2 common storage load module. If FSSM appears in the message, the error has occurred in the FSS address space.

In the message text:

jobname

The name of the job.

cbid The control block identifier

mqtr A 6 byte SPOOL address

Note: A jobid may precede \$HASP363. See “JES2 message format” on page 1.

System action: If the message occurred during job initiation, the job is ended. Otherwise, processing continues.

Operator response: None.

Module: HASCSRDS

\$HASP364 • \$HASP365

Routing Code: 10

Descriptor Code: 6

\$HASP364

Explanation:

▶▶—*jobname*— $\left\{ \begin{array}{l} \$CBIO \\ FSSM \end{array} \right.$ — - INVALID CONTROL BLOCK,—EXPECTING—*xxxx*— *cbid* AT *mqtr*—▶▶

JES2 has read a disk-resident control block whose identifier is unrecognizable. The control block identifier *xxxx* is passed by the requester of the I/O. If \$CBIO appears in the message, the error has occurred in a JES2 common storage load module. If FSSM appears in the message, the error has occurred in the FSS address space. In the message text:

jobname

The name of the job.

xxxx The control block identifier.

cbid The control block identifier

mqtr A 6 byte SPOOL address

Note: A jobid may precede \$HASP364. See “JES2 message format” on page 1.

System action: JES2 ends the job being initiated.

Operator response: Notify the system programmer.

Programmer response: Resubmit the job.

Module: HASCSRDS

Routing Code: 10

Descriptor Code: 6

\$HASP365

Explanation:

▶▶—*jobname*— $\left\{ \begin{array}{l} \$CBIO \\ FSSM \end{array} \right.$ — - INACTIVE VOLUME—*xxxx*— $\left\{ \begin{array}{l} \text{READING} \\ \text{WRITING} \end{array} \right.$ — *cbid* AT *mqtr*—▶▶

This message indicates that an I/O operation failed because the volume that is being accessed is currently inactive. You must start or drain the volume and then retry the I/O operation.

In the message text:

jobname

The name of the job.

xxxx The volume identifier.

cbid The control block identifier

mqtr A 6 byte SPOOL address

Note: A jobid may precede \$HASP365. See “JES2 message format” on page 1.

System action: JES2 ends the job being initiated.

Operator response: Notify the system programmer.

Programmer response: Resubmit the job.

Module: HASCSRDS

Routing Code: 10

Descriptor Code: 6

\$HASP370

Explanation:

▶▶—*jobname*— $\left\{ \begin{array}{l} \$CBIO \\ FSSM \end{array} \right.$ — I/O ERROR— $\left\{ \begin{array}{l} READING \\ WRITING \end{array} \right.$ —CONTROL BLOCK, EXPECTING—*xxxx*— *cbid* AT *mqtr*—▶▶

JES2 has encountered a permanent I/O error while reading or writing a disk-resident control block. The control block identifier *xxxx* is passed by the requester of the I/O. If \$CBIO appears in the message, the error has occurred in a JES2 common storage load module. If FSSM appears in the message, the error has occurred in the FSS address space. In the message text:

jobname The name of the job.

xxxx The control block identifier.

cbid The control block identifier

mqtr A 6 byte SPOOL address

Note: A jobid may precede \$HASP370. See “JES2 message format” on page 1.

System action: If the error occurred on a read, JES2 ends the job. Otherwise, processing continues.

Operator response: Notify the system programmer.

Programmer response: Resubmit the job. Determine if you need to call hardware support personnel.

Module: HASCSRDS

Routing Code: 10

Descriptor Code: 6

\$HASP371

Explanation:

▶▶—*jobname*—HCBFM – FREEMAIN FAILED—FOR SP 230—▶▶

JES2 failed in attempting to release main storage for a direct access resident job control block. In the message text:

jobname The name of the job.

Note: A jobid may precede \$HASP371. See “JES2 message format” on page 1.

System action: Processing continues.

Operator response: None.

Module:

HASCSRDS

Routing Code: 10

Descriptor Code: 4

\$HASP373 • \$HASP374

\$HASP373

Explanation:

```
▶▶—jobname—STARTED—┌──────────────────────────────────┐—jobname—STARTED—▶▶
                       └─ - INIT init— - CLASS class— - SYS sysname—┘
▶┌──────────────────────────────────┐──────────────────────────────────▶
  └─ -WLM INIT— -SRVCLASS srvclass— - SYS sysname—┘
```

The specified job is starting to run. If the job has been selected by class, the optional text is displayed. In the message text:

jobname

The name of the job.

init

The initiator number or name.

class

The job class.

srvclass

The job service class.

sysname

The name of the system.

Note: A jobid may precede \$HASP373. See “JES2 message format” on page 1.

System action: Processing continues.

Operator response: None.

Module: HASCJBST

Routing Code: 2

Descriptor Code: 6

\$HASP374

Explanation:

```
▶▶—jobname - —JOB HAS NO JOURNAL—▶▶
```

The specified job was attempting to warm start or restart. In both cases, a job journal data set is required, but the job had none.

In the message text:

jobname

The name of the job.

Note: A jobid may precede \$HASP374. See “JES2 message format” on page 1.

System action: The job ends.

Operator response: None.

Module:

HASCJBST

Routing Code: 11

Descriptor Code: 6

\$HASP375

Explanation:

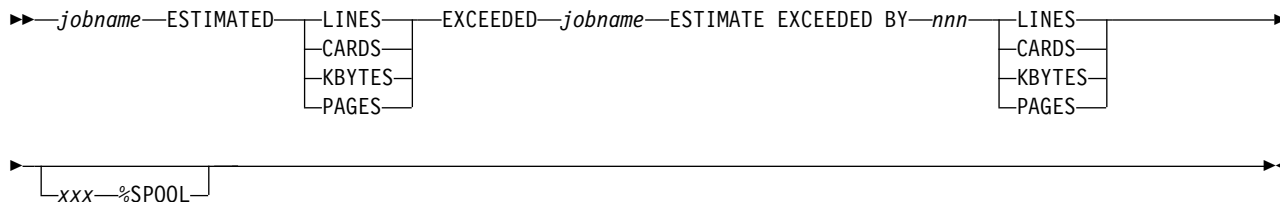

The specified batch job has exceeded its estimated number of lines, cards, bytes, or pages by *nnn*. The excession value *nnn* is a cumulative value over the entire lifespan of the job (and includes spin output). The job is currently using *xxx* percentage of SYSOUT spool space. If the percentage is zero, *xxx% SPOOL* is not displayed. When job *jobname* initially exceeds the specified amount of output, the short form of this message is issued. When the output increases further, the long form, indicating *nnn* lines, cards, Kbytes, or pages and percent spool usage is issued.

When CARDS appears in the message, the total record count exceeds the user-defined limit. This record count includes any print records destined for a punch with a printing feature (for example, the D/T3525). The percentage displayed in the message does not include the amount of spool space consumed by spin data sets. To determine the number of track groups and the percentage of spool the job is using, enter the \$DJx, LONG command.

In the message text:

jobname

The name of the job.

nnn

The number (up to 999,999,999,999,999) of lines, cards, Kbytes, or pages by which the job has exceeded the initial estimate.

xxx

The percentage of spool space used.

Note: A jobid may precede \$HASP375. See “JES2 message format” on page 1.

System action: The action depends on the installation options. If an abnormal end results, the system completion code is X'722' and a dump may or may not be issued. If the task producing the output is already ending (normally or abnormally), JES2 does not attempt to ABEND the output. If the excess processing has occurred only with a JES-managed data set (JESMSG LG, JESYSMSG), JES2 does not abend the output.

Operator response: None.

Module: HASCHAM

Routing Code: 2

Descriptor Code: 6

\$HASP381

Explanation:



An attempt has been made to trace an entry that is larger than the trace table.

In the message text:

xxx

The number of the trace entry.

System action: The specified trace entry *xxx* can not be written to the trace table; the trace ID is deactivated.

Operator response: Notify the system programmer.

System programmer response: If necessary, perform a warm start and increase the trace table size at JES2 initialization by increasing the value of the PAGE parameter on the TRACEDEF initialization statement. Enter the \$TRACE(n) command to reactivate the trace ID.

\$HASP394 • \$HASP395

Module: HASCSRIC

Routing Code: 10

Descriptor Code: 4

\$HASP394

Explanation:

▶▶—*jobname*—OUTPUT LOST—◀◀

During a warm start, JES2 encountered an error while reading the spin output group for job *jobname*.
In the message text:

jobname

The name of the job.

System action: JES2 attempts to recover the rest of the output. One or more output data sets may be lost in the attempt. If JES2 is unable to recover any of the data sets, JES2 cancels the job.

Operator response: None.

Routing Code: 4

Descriptor Code: 2

\$HASP395

Explanation:

▶▶—*jobname*—ENDED—◀◀

| ▶▶—*jobname*—ENDED—RC=*nnnn*—◀◀

| ▶▶—*jobname*—ENDED—ABEND=*Sxxx*—◀◀

| ▶▶—*jobname*—ENDED—ABEND=*Uddd*—◀◀

The specified job has completed processing.
In the message text:

jobname

The name of the job.

| **nnnn** The reason code the job ended with.

| **xxx** The system abend code the job ended with.

| **ddd** The user abend code the job ended with.

Note: A jobid may precede \$HASP395. See "JES2 message format" on page 1.

System action: Processing continues.

Operator response: None.

Module: HASCJBST

Routing Code: 2

Descriptor Code: 6

\$HASP396

Explanation:

▶▶—*jobname*—TERMINATED—▶▶

Because of circumstances specified by previous messages, the specified job was unable to start processing. This message can be issued with no previous messages for the following conditions:

1. A user attempted to logon to TSO/E on a member of a multi-access spool configuration and a duplicate logon ID was currently running on another member.
2. Installation exit 10 caused the job to end, but issued no explanatory message.

In the message text:

jobname

The name of the job.

Note: A jobid may precede \$HASP396. See “JES2 message format” on page 1.

System action: Processing continues.

Operator response: None.

Module: HASCJBST

Routing Code: 2

Descriptor Code: 6

\$HASP397

Explanation:

▶▶—*jobname*—RE-ENQUEUED—▶▶

The specified job is requeued for warm start or restart processing.

In the message text:

jobname

The name of the job.

Note: A jobid may precede \$HASP397. See “JES2 message format” on page 1.

System action: Processing continues.

Operator response: None.

Module: HASCJBST

Routing Code: 2

Descriptor Code: 6

\$HASP398

Explanation:

▶▶—*jobname*—QUEUED FOR RE-EXECUTION—▶▶

In response to operator command \$E jobid or \$E jobname, or because the initiator has insufficient resources to start the job, the specified job is requeued for processing.

In the message text:

jobname

The name of the job.

Note: A jobid may precede \$HASP398. See "JES2 message format" on page 1.

System action: Processing continues.

Operator response: None.

Module: HASCJBST

Routing Code: 2

Descriptor Code: 6

Chapter 8. Four-hundreds

The following JES2 messages are numbered in the 400-499 range.

\$HASP400

Explanation:

▶—ENTER REQUESTS—▶

JES2 is ready for job processing and is waiting for requests. This mode provides an opportunity to review, alter, or purge jobs that may have caused the problem. When the operator enters a \$S command to start JES2 processing, JES2 deletes this message from the console.

System action: JES2 does not process jobs until a \$S command is entered.

Operator response: Perform necessary preparatory functions, and enter the \$S command (if job processing is required) or \$P JES2 (if JES2 is to be withdrawn).

Note: If you have any device initialization statements defined with START in the initialization deck (for example, PRTnn START=Yes), the \$PJES2 command will not be accepted. You must enter a \$S command first.

Module: HASPWARM

Routing Code: 1,2

Descriptor Code: 2

\$HASP401

Explanation:

▶—EXTENT ERROR ON—*volser*—▶

The operator performed a JES2 warm start or entered a start spool (\$S SPOOL) command. JES2 has found that the first extent of data set SYS1.HASPACE on volume *volser* is different from the extent before the warm start, or different from the first system in the configuration that allocated the spool volume by a \$S SPOOL command, because of one of the following:

- Mounting the wrong volume.
- Starting a different JES2 system.
- Scratching and reallocating the SYS1.HASPACE data set.

In the message text:

volser The volume identifier.

System action: During a JES2 warm start, JES2 ends after attempting to verify the remaining required volumes. After a \$S SPOOL command is entered, the command is rejected and the volume is not started.

System programmer response: Make sure that all spooling volumes are correct. If not, mount the correct ones. If correct, perform a cold start, thus destroying any job information contained in the SYS1.HASPACE data set.

Module: HASPSPOL, HASPIRDA

Routing Code: 1,2,10

Descriptor Code: 4

\$HASP402 • \$HASP403

\$HASP402

Explanation:

▶▶—*ttt*—ATTACH ERROR — *cde*—▶▶

JES2 has attempted to attach a subtask, which is required for running the system. The module name indicates the EBCDIC name of the subtask *ttt*. If the system is allowed to continue processing, the results will be unpredictable and cause general malfunctioning as follows:

- HASPIMAG – JES2 FCB and UCS image retrieval facility will be inactive; output devices requiring images from SYS1.IMAGELIB will not operate.
- HASPWTO – JES2 WTO interface facility will be inactive, eventually causing JES2 to become interlocked when it attempts to use the OS console interface.
- HASPACCT – JES2 SMF interface facility will be inactive, eventually causing JES2 to become interlocked when it attempts to write SMF records.
- GENERAL – If at least one general purpose subtask has been attached, processing continues. Subtask requests may be accepted at a reduced rate.

If no subtasks were successfully attached, only required functions (including security processing) will be performed; JES2 performance will be severely degraded.

In the message text:

ttt The name of the subtask.

cde The system completion code returned.

System action: JES2 will attempt to process jobs.

Operator response: Stop JES2, see *z/OS MVS System Codes*, and correct the problem as indicated.

Module: HASPDYN

Routing Code: 1,2,10

Descriptor Code: 4

\$HASP403

Explanation:

▶▶—DO YOU WISH TO IGNORE THE—CHANGE LOG UPDATES?—('Y' OR 'N')—▶▶

JES2 has issued message \$HASP298 notifying the operator that an incorrect change log record was discovered while processing updates from the checkpoint data set's change log. If this is an all-member warm start, the installation can elect to continue without applying the change log updates.

System action: JES2 waits for the operator's reply.

Operator response: If you reply Y, JES2 discards the change log and continues processing with potential job queue damage. If you reply N, JES2 ends. Restart JES2 using the CKPT2 data set.

System programmer response: Determine if it is better to restart from another data set, or discard the change log and use this data set.

Module: HASPIRDA

Routing Code: 1,2,10

Descriptor Code: 2

\$HASP404

Explanation:

▶▶—*jobname*— – BAD — JCT — — — IOT — — — ERRORS MAY OCCUR —▶▶

The operator has performed a JES2 warm start. A direct-access allocation map for the job is in error. In the message text:

jobname
The name of the job.

Note: A jobid may precede \$HASP404. See “JES2 message format” on page 1.

System action: The control block allocation map is altered to preserve system integrity and the control block is rewritten. The job may experience premature end on input data sets (JCT) or output data sets (IOT).

Operator response: Consult the installation procedures guide to determine the advisability of deleting the job, resubmitting it, or allowing the job to continue.

Module: HASPWARM

Routing Code: 1,2

Descriptor Code: 4

\$HASP405

Explanation:

▶▶—JES2 IS UNABLE TO DETERMINE—IF OTHER MEMBERS ARE ACTIVE—▶▶

Because forwarding has taken place, JES2 is unable to determine if any other members in this multi-access spool configuration are active.

System action: JES2 issues message \$HASP420.

Operator response: Respond to message \$HASP420.

System programmer response: See the description of message \$HASP420.

Module: HASPIRDA

Routing Code: 1,2,10

Descriptor Code: 2,7

\$HASP406

Explanation:

▶▶—*jobname*—WAS EXECUTING ON MEMBER—*member-name*—▶▶

This message is issued for one of the following reasons:

- The operator has performed a JES2 warm start. When the system stopped, the job was in the JES2 execution phase.
- The automatic restart manager has requested a restart of a job that was executing on a system that has failed.

In the message text:

jobname
The name of the job.

member-name
The name of the member on which the job was executing.

\$HASP407 • \$HASP408

Note: A jobid may precede \$HASP406. See "JES2 message format" on page 1.

System action: JES2 requeues the job for execution. If checkpoint/restart or step restart is used, the system determines whether the job is eligible to restart. If it is, appropriate messages are issued allowing the operator to select restart options. If the job is not journaled or if the automatic restart manager is used, the operator will not be able to specify any restart options.

If the job is not eligible for restart, all of the job's data sets (including the system message and JES2 job log data sets) might not print to completion; some might not print at all.

Operator response: If the normal system action is not required, hold or cancel the job.

Module: HASPWARM

Routing Code: 1,2

Descriptor Code: 4

\$HASP407

Explanation:

▶▶—*jobname*—WAS TERMINATING ON MEMBER—*member-name*—————▶▶

JES2 warm start processing encountered a job that was stopping its processing during system shutdown. In the message text:

jobname

The name of the job.

member-name

The name of the member on which the job was terminating.

Note: A jobid may precede \$HASP407. See "JES2 message format" on page 1.

System action: The identified job is queued for output processing.

Operator response: None.

Module: HASPWARM

Routing Code: 1,2

Descriptor Code: 4

\$HASP408

Explanation:

▶▶—*jobname*—IS QUEUED FOR RE-EXECUTION—————▶▶

JES2 warm start processing encountered a running job during shutdown. The job was journaled or marked as restartable.

In the message text:

jobname

The name of the job.

Note: A jobid may precede \$HASP408. See "JES2 message format" on page 1.

System action: The identified job is placed back into the execution queue.

Operator response: None.

Module: HASPWARM

Routing Code: 1,2

Descriptor Code: 4

\$HASP409

Explanation:

▶▶—*jobname*—WAS ON—*device*—ON MEMBER—*member-name*—▶▶

The operator has performed a JES2 warm start. When the system stopped, the job was in the process of reading. In the message text:

jobname

The name of the job.

device The name of the input device on which the job was active.

member-name

The name of the member on which the job was being read.

Note: A jobid may precede \$HASP409. See “JES2 message format” on page 1.

System action: The job is purged.

Operator response: Resubmit the job.

Module: HASPWARM

Routing Code: 1,2

Descriptor Code: 4

\$HASP410

Explanation:

▶▶—*jobname*—OUTGRP=*outgrp*—WAS ON—*device*—ON MEMBER—*member-name*—▶▶

The indicated job was printing or punching when the last JES2 checkpoint was taken (before this warm start). In the message text:

jobname

The name of the job.

outgrp The name of the output group that was active on the print/punch device.

device The name of the device.

member-name

The name of the member on which the job was being processed.

Note: A jobid may precede \$HASP410. See “JES2 message format” on page 1.

System action: The job is requeued, and the output function is continued when print/punch devices are available.

Operator response: The operator may use the following console commands:

- \$H – hold job – to prevent output from occurring until a \$A (release) command is entered.
- \$C – cancel job – to remove the job from the output queue and pass it to purge.

If neither of these commands is used, the job can be controlled normally when it is started on a device.

Module: HASPWARM

Routing Code: 1,2

Descriptor Code: 4

\$HASP411 • \$HASP413

\$HASP411

Explanation:

►►—MORE THAN—*nnn*—VOLUMES MOUNTED—WITH PREFIX—*yyyy*—◄◄

During the cold start, the number of DASD volumes matching the spool volume prefix that are on-line is greater than *nnn*, the maximum number that JES2 supports, as defined by the SPOOLNUM parameter.

In the message text:

nnn The maximum number of direct access spool volumes that JES2 supports.

yyyy The prefix of the spool volume as specified by the VOLUME parameter of the SPOOLDEF initialization statement.

System action: JES2 does not allocate the spool volume. The operator has the option to continue or stop processing.

Operator response: If you request continuation, the system comes up with only *nnn* spool volumes. If you request to end processing, JES2 ends. Notify the system programmer.

System programmer response: Increase the value of the SPOOLNUM parameter on the SPOOLDEF initialization statement.

Module: HASPIRDA

Routing Code: 1,2,10

Descriptor Code: 2,7

\$HASP412

Explanation:

►►—JES2 CAN NOT RECONNECT TO FSS—*fssname*,—FSS ADDRESS SPACE HAS ENDED—◄◄

During a JES2 hot start, JES2 attempted to reestablish the cross memory interface required to support functional subsystem (FSS) *fssname*, but JES2 detected that the FSS address space has ended.

System action: JES2 drains all devices associated with this FSS.

Although JES2 determined that the FSS was active during a hot start, JES2 was unable to schedule an SRB to reconnect to the cross-memory address space. Either JES2 could not find a valid ASCB for the FSS or the FSS address space was terminating.

Operator response: Enter the \$S PRT*nnnn* command to restart the FSS. If JES2 also directly supports the FSS devices, issue the \$T command with MODE=JES and then issue the \$S command to start the device.

Module: HASPWARM

Routing Code: 1,2,10

Descriptor Code: 7

\$HASP413

Explanation:

►►—JES2 RECONNECT TO FSS—*fssname*—FAILED,—FSS TERMINATED WITH ABEND 02C - \$F06—◄◄

During a JES2 hot start, JES2 failed to reestablish the cross memory interface required to support functional subsystem *fssname*.

In the message text:

fssname

The name of the functional subsystem.

System action: The functional subsystem abends with an ABEND code of X'02C'. All devices are drained that are associated with the functional subsystem.

Operator response: Save the hard-copy log. For system with remote consoles, save the remote console sheet. Notify the system programmer.

To restart the functional subsystem enter the \$S PRTnnnn command. If the functional subsystem devices are also supported directly by JES2, they may be restarted by entering the \$T command with MODE=JES and then starting the device with the \$S command.

System programmer response: The \$F06 code indicates this error condition. See *z/OS MVS System Codes* for an explanation of the X'02C' abend. Determine the cause of the ATSET system service failure. ATSET was invoked with an authorization index value in the \$CCTAXV field of the \$HCCT. For a description of ATSET, see *z/OS MVS Programming: Assembler Services Reference ABE-HSP*.

Save the dump produced. If you use SMP/E to make all changes to the system, run the LIST CDS and LIST PTFBY functions of SMP/E to obtain a list of the current maintenance from the SMP/E control data set (CDS).

If any changes are made without using SMP/E, run LISTIDR of AMBLIST to obtain a list of all members with a PTF or local fix and save the output. Run LISTIDR against the following:

- SYS1.LINKLIB.
- SYS1.SVCLIB
- The library containing the program that issued the message.
- SYS1.LPALIB

Contact the IBM Support Center.

Module: HASPWARM

Routing Code: 1,2,10

Descriptor Code: 4

\$HASP414

Explanation:

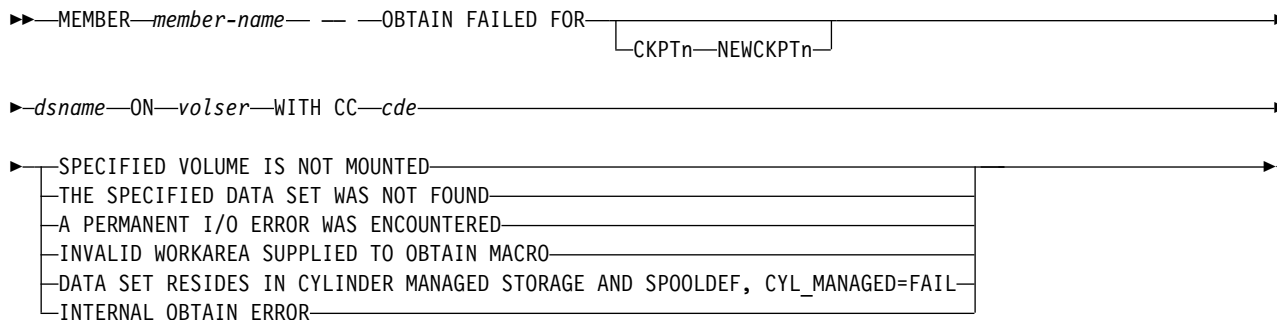

JES2 was preparing to allocate either a checkpoint or spool data set. JES2 used the OBTAIN supervisor service to get information about the specified data set, but OBTAIN did not work as expected. OBTAIN issued return code *cde* to indicate the problem.

In the message text:

member-name

The name of the member experiencing the problem.

n

The number of the checkpoint data set (either 1 or 2). CKPT*n* or NEWCKPT*n* is only displayed for checkpoint allocation problems.

dsname

The name of the checkpoint data set.

volser

The volume identifier.

\$HASP415 • \$HASP416

cde The OBTAIN return code.

System action:

- If this message is issued for a checkpoint data set, JES2 initiates a checkpoint reconfiguration. If a checkpoint reconfiguration is already in progress, JES2 prompts the operator for an alternative action. If *cde* is 08, and JES2 is attempting to reconfigure for an I/O error with OPVERIFY=NO, then JES2 attempts to create the data set.
- For a cold start, processing continues without the spool volume.
- For a warm start, processing stops after attempting to verify the remaining spool and checkpoint volumes.
- For a \$S SPOOL command, the command is rejected and processing continues.

System programmer response: If CKPT*n* or NEWCKPT*n* is displayed, respond to any checkpoint reconfiguration dialog messages. If you are not familiar with the dialog process, see *z/OS JES2 Initialization and Tuning Guide* for a detailed discussion.

If *cde* is 08, allocate a data set named *dsname* on the volume *volser* and start JES2 again. If you are in a checkpoint reconfiguration, you might choose to reply CREATE to the \$HASP278/\$HASP272 message pair.

If *cde* is 12, use the IBM utility program IEHDASDR or IBCDASDI to reinitialize the volume *volser*, then follow the procedure for *cde* 08.

Module: HASPSPOL, HASPCKDS

Routing Code: 1,2,10

Descriptor Code: 4

\$HASP415

Explanation:

▶▶—JES2 FSA PREVIOUSLY DEFINED FOR—*devname*, —(—UNIT=—*dev*—)—IS NOT DEFINED, FSA TERMINATED—————▶
▶—WITH—ABEND 02C— — —\$F07—————▶▶

During a JES2 hot start, no JES2 device control table (DCT) has been defined with the same device name and device address as the active FSA that had been supporting device *devname*. The \$F07 indicates this error condition. See *z/OS MVS System Codes* for an explanation of the X'02C' abend code.

In the message text:

devname

Specifies the name of the device.

dev Specifies a 4-digit hexadecimal device number.

System action: The FSA abnormally ends with an abend code of X'02C'.

Operator response: Notify the system programmer. If the device has been defined as being supported by a functional subsystem, it can be started under a new functional subsystem FSA by entering the \$S command to restart the device. If the device has been defined as a JES2 device, it can be started by entering the \$T command with MODE=JES and then the \$S command.

System programmer response: The probable cause is incorrect JES2 initialization parameters. If necessary, change the parameters then stop and restart JES2.

Module: HASPWARM

Routing Code: 1,2,10

Descriptor Code: 4

\$HASP416

Explanation:

▶▶—VERIFY CHECKPOINT DATA SET INFORMATION—| VALUES FROM CKPTDEF |—| VALUES JES2 WILL USE |—————▶

▶LAST WRITTEN—*day, dd mmm yyyy*—AT—*hh:mm:ss*—(—LOCAL TIME—)
 GMT

VALUES FROM CKPTDEF:

```

  |-----|
  | CKP1= | DSNAME |-----|
  |-----| STRNAME |-----|
  | CKP2= | DSNAME |-----|
  |-----| STRNAME |-----|
  
```

VALUES JES2 WILL USE:

```

  |-----|
  | CKP1= | DSNAME |-----|
  |-----| (—STRNAME=—strname, —INUSE=—xxx—) |-----|
  |-----|
  | CKP2= | (—DSNAME=—dsname, —VOLSER=—volser, —INUSE=—xxx—) |-----|
  |-----| STRNAME |-----|
  
```

DSNAME:

```

  |-----|
  | (—DSNAME=—dsname, —VOLSER=—volser, —INUSE=—xxx—) |-----|
  
```

STRNAME:

```

  |-----|
  | (—STRNAME=—strname, —INUSE=—xxx—) |-----|
  
```

JES2 initialization is unsure of the checkpoint data set specifications. If this message follows message \$HASP454, JES2 wants to confirm that the members have not migrated to a new checkpoint data set. This message is also issued if the CKPTDEF values given during initialization are not consistent with information read from the checkpoint data set. If this is true, JES2 is assuming the data sets have been forwarded and wants confirmation of the data set names. The message displays VALUES FROM CKPTDEF only if these values are different from the values JES2 will use. The LAST WRITTEN TIME in the message is the time associated with the checkpoint data set JES2 will read the control blocks from. LOCAL TIME or GMT displays depending on which was stored in the checkpoint. In the message text:

- dsname** The name of the data set.
- volser** The volume identifier.
- strname** The name of the coupling facility structure.
- xxx** Either YES or NO, indicating whether the data set is currently in use.
- day** The day of the week (Monday, Tuesday, ...) that the checkpoint data set was last written
- dd mmm yyyy** The date of the last write to the checkpoint in day, month, year format (for example, 28 MAR 2003)
- hh:mm:ss** The time of the last write to the checkpoint in hour:minute:second format (for example, 18:24:45)

System action: JES2 issues message \$HASP417.

Operator response: Respond to message \$HASP417.

System programmer response: If the data set JES2 will use is incorrect, update the CKPTDEF initialization statement with the correct CKPT*n* values and then restart JES2.

Module:

\$HASP417 • \$HASP418

HASPIRDA

Routing Code: 1,2,10

Descriptor Code: 2,7

\$HASP417

Explanation:

▶▶—ARE THE VALUES JES2 WILL USE CORRECT?—('Y' OR 'N')—▶▶

Message \$HASP416 or message \$HASP460 has been issued stating that JES2 initialization is unsure of the specifications of the checkpoint data sets. This message follows asking the operator for confirmation.

System action: JES2 waits for the operator's reply.

Operator response: If these data set values are being used by other members of the multi-access spool configuration or if these values are to be used for this start, reply Y. JES2 will use the started checkpoint data set specifications.

Note: JES2 will end even though you reply Y if this message is issued as a result of a N response to the \$HASP454 message because JES2 cannot continue processing without the lock.

If you do not want to use these checkpoint data set specifications, reply N. JES2 will initiate a dialog to determine the correct checkpoint data set specifications.

System programmer response: If the values are incorrect, update the CKPTDEF initialization statement with the correct values.

Module:

HASPIRDA

Routing Code: 1,2,10

Descriptor Code: 2

\$HASP418

Explanation:

▶▶—PERM I/O ERROR ON—*volser*—WHILE FORMATTING—▶▶

JES2 was unable to finish formatting the first extent of SYS1.HASPACE on the specified SPOOL volume because a hardware error occurred or because the SPOOL volume is not properly initialized.

In the message text:

volser The volume identifier.

System action:

- For a cold start, processing continues without the volume.
- For a warm start, processing stops after attempting to verify the remaining spool volumes.
- For a \$S SPOOL command, the command is rejected and processing continues.

Operator response: If the error was caused by a hardware malfunction, have it corrected. If not, the SPOOL volume may need to be re-initialized. Re-initialize it using ICKDSF.

Module: HASPSPOL

Routing Code: 1,2,10

Descriptor Code: 4

\$HASP419

Explanation:

▶▶—MEMBER—*memname1*—HAS DETERMINED THAT THE FOLLOWING—JES2 MEMBERS(S) ARE DORMANT:—————▶▶
 ▶—*memname2*—————▶▶
 └─, *memname3*...—┘

JES2 initialization has determined through analysis of the checkpoint record that the specified member(s) of the configuration is inactive. However, JES2 was not able to confirm this because it could not find the listed members in the XCF status information. The operator must confirm the member is down by responding to the following \$HASP420 message.

In the message text:

memname1

The member name of this member.

memname2 [, memname3,] ...

The member names of the inactive members.

System action: JES2 issues message \$HASP420 once for every member documented or until the operator responds N to the message.

Operator response: Notify your system programmer and respond to message \$HASP420.

System programmer response: This message is issued when JES2 determines that a member has not accessed the checkpoint data set within the value specified for SYNCTOL on the MASDEF initialization statement and JES2 cannot obtain status information for the member from XCF. This can occur because:

- The member is (or was at one time) active on an MVS system that is not in the same SYSPLEX as the member that is initializing. In this case, XCF cannot determine the current member status. If the member is still active on the other MVS system, reply N to the \$HASP420 message, otherwise reply Y.
- The member that is initializing is on an MVS system that has had its XCF coupling data sets reformatted. In this case, the old XCF status information for the member has been lost. Reply Y to the HASP420 message.

Note: An incorrect reply of Y to message \$HASP420 might cause JES2 to end abnormally (code \$K03) and possible damage to spool and checkpoint, resulting in a cold start of JES2.

Module: HASPIRDA

Routing Code: 1,2,10

Descriptor Code: 2,7

\$HASP420

Explanation:

▶▶—REPLY 'Y' IF ┌ memname IS — DOWN (IPL REQUIRED), —'N' IF NOT —▶▶
 └─ ALL MEMBERS ARE —┘

JES2 has issued either message \$HASP419 reporting the member(s) considered dormant, or message \$HASP405 if it cannot determine if any other member in the multi-access spool configuration is active. JES2 requires confirmation of the status of each of the displayed member(s).

In the message text:

memname

The member name.

System action: JES2 waits for the operator's reply.

Operator response:

- If *memname* is displayed:

\$HASP421

This \$HASP420 message is issued once for every member displayed in message \$HASP419 or until you reply N. For each issuance, determine whether MVS is down on *memname* using the notes provided below. If *memname* is indeed inactive, reply Y to this message. Otherwise reply N.

If you reply Y to every issuance of this message (indicating all members displayed in \$HASP419 are inactive), JES2 will perform a cold start or a warm start, depending on the initialization option you previously specified. If you reply N to this message for any member documented in \$HASP419, JES2 initialization will terminate, regardless of the kind of start you previously specified.

- If **ALL MEMBERS ARE** is displayed:

The \$HASP405 message precedes this message. Determine whether MVS is down on all other members in the multi-access spool (MAS) configuration using the notes provided below. If **all** other members are inactive, reply Y to this message. JES2 will perform a cold start or a warm start, depending on the initialization option you previously specified.

If at least one other member in the MAS is active, reply N to this message. JES2 initialization will terminate, regardless of the kind of start you previously specified.

Note:

1. If a member is in stop mode, or if MVS is up but JES2 has abended, the member is still considered active.
2. An incorrect reply of Y might cause JES2 to end abnormally (code \$K03) and possible damage to spool and checkpoint, resulting in a cold start of JES2.

System programmer response: See message \$HASP405 or \$HASP419.

Module: HASPIRDA

Routing Code: 1,2,10

Descriptor Code: 2

\$HASP421

Explanation:

▶▶—PREVIOUSLY MOUNTED VOLUME—*volser*—IS UNFORMATTED—▶▶

The operator performed a JES2 warm start or entered a \$S SPOOL command. The length of the first record on the last track of the first extent of SYS1.HASPACE is incorrect, because of overwriting, starting a different JES2 system, or mounting the wrong spool volume.

In the message text:

volser The volume identifier.

System action:

- If this message is issued during a warm start after attempting to verify the remaining required spool volumes, JES2 stops.
- If this message is issued in response to a \$S SPOOL command, the command is rejected, and normal processing continues.

Operator response: If the wrong volume was mounted, mount the correct volume and warm start JES2. Otherwise, cold start JES2; any spool volumes that are not correctly formatted will automatically be reformatted during a JES2 cold start. If the message was issued in response to a start spool (\$S SPOOL) command, make sure the correct spool volume is mounted on all systems, and reenter the \$S SPOOL command.

Module: HASPSPOL, HASPIRDA

Routing Code: 1,2,10

Descriptor Code: 4

\$HASP422

Explanation:

▶▶—DUPLICATE—*volser*—VOLUMES—▶▶

Multiple direct-access volumes have been found with identical labels.
In the message text:

volser The volume identifier.

System action:

- If this message is issued during initialization processing, JES2 ends.
- If this message is issued in response to a start spool (\$S SPOOL) command, the command is rejected and JES2 does not end.

Operator response: This is probably a user error. Check the volume labels of all direct-access volumes on the system and remove the duplicate volumes. If necessary, restart JES2.

Module:

HASPSPOL, HASPIRDA

Routing Code: 1,2,10

Descriptor Code: 4

\$HASP423

Explanation:

▶▶—*volser*—IS BEING MINI -]—FORMATTED—▶▶

Either the operator performed a JES2 warm start or format start, or entered a \$S SPOOL,FORMAT command to JES2, or the JES2 automated spool reclaim is performing a mini-format. If the format is performed in response to an operator request an unformatted spool volume is now being formatted. If the format is JES2-initiated (that is, a mini-format), JES2 does not affect the existing information on spool.

In the message text:

volser The volume identifier.

System action: If this is an operator-requested spool format, JES2 formats all unformatted spool volumes during a cold start, all spool volumes during a format start, and the indicated spool volume in response to a \$S SPOOL,FORMAT command.

If this is a JES2-initiated mini-format, JES2 only writes the signature records for a spool record. JES2 does not change or overwrite any spool data.

Operator response: None.

Module: HASPSPOL

Routing Code: 1,2,10

Descriptor Code: 4

\$HASP424

Explanation:

▶▶ MEMBER—*member-name*— - -]—*volser*—IS NOT MOUNTED—▶▶

JES2 can not find a direct-access UCB for the spool or checkpoint volume specified in one of the following ways:

\$HASP425 • \$HASP426

- On the SPOOLDEF initialization statement
- On the \$\$ SPOOL command
- In response to a \$HASP272 message during a checkpoint reconfiguration.

The volume must be mounted and online.

In the message text:

member-name

The member experiencing the problem. Member-name is only included when the *volser* is for a checkpoint data set.

volser The volume identifier.

System action: The specified volume is not allocated to JES2. If JES2 is in initialization, JES2 initiates a checkpoint reconfiguration dialog. If JES2 is already within a checkpoint reconfiguration, JES2 prompts the operator for alternative actions.

Operator response: Make sure the volume is mounted, ready, and online. Retry the request.

If JES2 issues this message when recovering from a spool failure, you will also receive \$HASP853 to which you can reply GO, PURGE, or QUIT. Generally, you will respond PURGE; however, if you are uncertain if the volume is permanently damaged and want to keep the system running until you have verified its status, reply GO. If you later determine that the spool volume is lost, you can re-IPL and then reply PURGE to \$HASP853.

Module:

HASPSPOL, HASPIRDA, HASPCKDS

Routing Code: 1,2,10

Descriptor Code: 4

\$HASP425

Explanation:

▶▶—SUBSYSTEM INTERFACE NOT DORMANT,—*ssn*—ALREADY ACTIVE—▶▶

The operator attempted to start the JES2 subsystem when the subsystem interface (SSI) created by a previous JES2 is still active. This could be caused by any of the following:

- The previous JES2 is still operating.
- The previous JES2 did not leave the subsystem interface (SSI) in a restartable condition.
- The interface is still being used.
- A cold start is being attempted but there is an active subsystem interface (SSI).

System action: The JES2 subsystem that is attempting to start is stopped.

Operator response: If there is a JES2 subsystem up and running, stop that subsystem before attempting to start a new JES2; otherwise, re-IPL the system.

Module: HASPIRSI

Routing Code: 1,2,10

Descriptor Code: 4

\$HASP426

Explanation:

▶▶—SPECIFY OPTIONS – JES2—*jeslevel*—SSNAME=—*ssname*—▶▶

JES2 has been given control and is requesting instructions from the operator.

In the message text:

jeslevel

The level and version of JES2 which was started.

ssname The name used when starting JES2.

System action: JES2 waits for the operator to reply.

Operator response: Enter the options you want. For further information about starting, stopping, and restarting JES2, see *z/OS JES2 Commands*.

Module: HASPIRMA

Routing Code: 1,2,10

Descriptor Code: 4

\$HASP427

Explanation:

▶▶—PARAMETER OR SYNTAX ERROR —RESPECIFY OPTIONS—▶▶

JES2 does not recognize one or more of the initialization options entered by the operator in response to message \$HASP426.

System action: JES2 resets to default responses, and waits for the operator to reply.

Operator response: Enter the required options. For further information, see *z/OS JES2 Commands*.

Module: HASPIRMA

Routing Code: 1,2,10

Descriptor Code: 4

\$HASP428

Explanation:

▶▶—CORRECT THE ABOVE PROBLEMS—AND RESTART JES2—▶▶

This message follows one or more messages that indicate why JES2 initialization could not complete normally.

System action: JES2 ends.

Operator response: Notify the system programmer. If possible, correct the problems described in the previous message(s) and restart JES2.

System programmer response: See the messages issued before \$HASP428, correct the problems described, and restart JES2.

Module:

HASPIRA

Routing Code: 1,2,10

Descriptor Code: 4

\$HASP429

Explanation:

▶▶—SUBSYSTEM—*jesname*—NOT DEFINED—▶▶

The operator attempted to start a procedure for JES2 with a name that was not generated into the operating system. In the message text:

\$HASP430

jesname

The name of the JES2 system.

System action: JES2 ends.

Operator response: Notify the system programmer.

System programmer response: Ensure that the subsystem name has been defined.

Module: HASPIRSI

Routing Code: 1,2,10

Descriptor Code: 4

\$HASP430

Explanation:

►►—INCOMPATIBLE SUBSYSTEM INTERFACE— — RC= *nn*—————►►

An incompatibility exists between the version of JES2 being initialized and the subsystem support module, (or its related control blocks). This can happen when:

- A JES2 subsystem (that is, a subsystem with the same name as the one now being started) had been active since the last IPL and had abnormally ended. The subsystem support module(s) (HASCxxxx) specified during this initialization is not the same module used by the previously running JES2, or the related control blocks left by that JES2 are not compatible with the JES2 now being initialized.
- The subsystem support module's structure or content indicates that it is not compatible with, or at a different level than, the JES2 currently being initialized.

In the message text:

nn The reason code.

Possible values of *nn* and their meanings are:

<i>nn</i>	Meaning
03	The prefix in the HASP common storage communication table (HCCT) is not "HCCT". This indicates a possible overlay of the HCCT.
04	The prefix in the subsystem vector table (SSVT) is not "SSVT". This indicates a possible overlay of the SSVT.
08	During JES2 initialization, JES2 loaded its common storage modules and located the service routine entry points within them. When this process was complete, entry points were missing. The probable reason is that the set of HASCxxxx modules loaded is from a different release or maintenance level of JES2 than the JES2 initialization code being executed.
09	During JES2 'hot start' initialization, the prefix in the JES2 Common Address (CADDR) control block is not CADD. The probable reason is that the set of HASCxxxx modules loaded is from a different release or maintenance level of JES2 than the JES2 initialization code being executed.
10	During JES2 initialization, JES2 loaded its common storage modules and located its subsystem interface (SSI) function routine entry points within them. During this process, more than one entry point was found for the same SSI function code. The probable reason is that the set of HASCxxxx modules loaded is from a different release or maintenance level of JES2 than the JES2 initialization code being executed.
11	During JES2 initialization, JES2 loaded its common storage modules and located its subsystem interface (SSI) function routine entry points within them. When this process was complete, SSI entry points were missing. The probable reason is that the set of HASCxxxx modules loaded is from a different release or maintenance level of JES2 than the JES2 initialization code being executed.

System action: JES2 stops initialization.

Operator response: Notify the system programmer.

System programmer response: Restart JES2 with a compatible HASCxxxx module or, if required, re-IPL the system and restart JES2.

Module: HASPIRSI

Routing Code: 1,2,10

Descriptor Code: 4

\$HASP431

Explanation:

▶▶—THE INITIALIZATION ADMINISTRATION—CODE (IRA)— CANNOT BE FOUND —▶▶

This message is issued for one of the following reasons:

- NOT LOADABLE – JES2 attempted to load module HASPINIT and failed.
- INCORRECT – The module entry point could not be found from the module information table assumed to be at the beginning of the module.

System action: The \$HASP428 message is issued and then JES2 ends.

Operator response: Notify the system programmer.

System programmer response: Place a compatible HASPINIT load module in the same data set that contains the HASJES20 load module referenced by the JES2 catalog procedure that is being started.

Module: HASPNUC

Routing Code: 1,2,10

Descriptor Code: 4

\$HASP432

Explanation:

▶▶—AVAILABLE STORAGE EXCEEDED— WHILE ALLOCATING —*id*—▶▶

During JES2 initialization, the amount of storage required for JES2 processing exceeded the available private virtual storage in the JES2 address space.

In the message text, *id* can be one of the following values:

BUFFERS

A GETMAIN to allocate JES2 buffers was unsuccessful.

CKPT – I/O

A GETMAIN to allocate storage for the checkpoint I/O area was unsuccessful.

CKPT – 4K

A GETMAIN to allocate storage for 4K checkpoint records was unsuccessful.

DCBS A GETMAIN to allocate direct access DCBs was unsuccessful.

DCTS A GETMAIN to allocate DCTs was unsuccessful.

PCES A GETMAIN to allocate the JES2 processor control element (PCEs) that must be created during initialization was unsuccessful.

System action: JES2 ends.

Operator response: Notify the system programmer.

System programmer response: Reduce the number or size of the JES2 buffers requested, or change other initialization parameters to reduce the storage required to initialize JES2.

Module: HASPIRA, HASPIRDA, HASPIRMA

Routing Code: 1,2,10

Descriptor Code: 4

\$HASP433 • \$HASP435

\$HASP433

Explanation:

▶▶—INVALID SUBSYSTEM EXECUTION MODE—▶▶

An attempt was made to run JES2 as other than a subsystem started task (for example, as a batch job).

System action: JES2 ends.

Operator response: Notify the system programmer.

System programmer response: Determine who made the attempt and verify their right to use JES2.

Module: HASPNUC

Routing Code: 1,2,10

Descriptor Code: 4

\$HASP434

Explanation:

▶▶—INVALID CHECKPOINT RECORD ON CKPTn—DATA SET—▶▶

JES2 has detected an incorrect checkpoint record on the specified checkpoint data set. The record is incorrect because of one of the following reasons:

- A permanent I/O error has occurred.
- A field named \$HASPID did not contain "JES2".
- A field named \$MSTRID did not contain "MSTR".
- The level of this record is different from the level of the master record.
- The number of members in a multi-access spool configuration (MAS) supported by this system is different than the number of MAS members supported by the last system to write to the checkpoint data set.

In the message text:

n The number of the checkpoint data set. The number is either 1 or 2.

System action: JES2 initiates a checkpoint reconfiguration dialog with the operator.

Operator response: Notify the system programmer and respond to the dialog messages. If you are unfamiliar with the dialog process, see *z/OS JES2 Initialization and Tuning Guide* for a detailed discussion.

System programmer response: Ensure that the system being started is the same as or is compatible with the last one run. If incompatibilities in JES2 parameter values are discovered and cannot be resolved, a cold start must be performed.

Module: HASPIRDA

Routing Code: 1,2,10

Descriptor Code: 4

\$HASP435

Explanation:

▶▶—DUPLICATE MEMBER NAME OR—MORE THAN 32 MEMBER NAMES—▶▶

One of the following error conditions exists:

- On the MASDEF statement, OWNMEMB specifies a member name that is different from any already existing member names and there are already 32 member names defined. In other words, there has been an attempt to define a 33rd member name.

- The same member name has been specified for two different members.

System action: JES2 ends.

Operator response: Notify system programmer.

System programmer response: Analyze the MEMBER statement and the OWNMEMB parameter on the MASDEF statement and correct the problem. Restart JES2.

Module:

HASPIRDA

Routing Code: 1,2,10

Descriptor Code: 1

\$HASP436

Explanation:

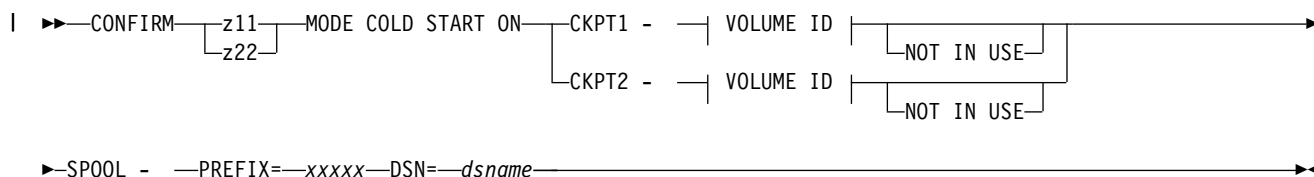

VOLUME ID:

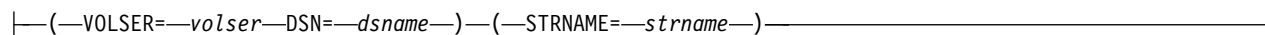

You have requested a cold start of JES2. The checkpoint mode (\$ACTIVATE LEVEL) that JES2 will cold start in is displayed. The checkpoint mode can be influenced by the UNACT start PARM or the COLD_START_MODE operand on OPTSDEF.

The checkpoint specifications that will be used are displayed in the message. Before beginning the start-up procedures, JES2 wants to confirm that you want a cold start, and if so, that you agree with the specifications to be used. For each checkpoint data set in use, the volume serial and data set name are displayed in the message. If the checkpoint data set is not in use, NOT IN USE is displayed.

For the SPOOL data sets, the data set name and the four or five character spool volume prefix (specified by the SPOOLDEF initialization statement) are displayed. The \$HASP441 message follows, asking you to confirm the request.

In the message text:

volser The volume identifier.

dsname
The name of the checkpoint data set.

strname
The name of the coupling facility structure.

xxxxx The prefix of the spool volume as specified by the VOLUME parameter of the SPOOLDEF initialization statement.

System action: JES2 issues message \$HASP441.

Operator response: Respond to message \$HASP441.

Module: HASPIRDA

Routing Code: 1,2,10

Descriptor Code: 2,7

\$HASP437 • \$HASP439

\$HASP437

Explanation:

►►—*parm*—VALUE EXCEEDS MAXIMUM—►►

The value specified for the initialization parameter *parm* exceeds the maximum value allowed.
In the message text:

parm The name of the initialization parameter.

System action: JES2 ends.

Operator response: Notify the system programmer. Restart JES2 when the parameter has been corrected.

System programmer response: Correct the incorrect parameter.

Module: HASPIRPL

Routing Code: 1,2,10

Descriptor Code: 4

\$HASP438

Explanation:

►►—FORWARDED DATA SET NAME FOUND ON A—

—COLD START—
—RECONFIG—

—►►

One or both of the checkpoint data sets indicate they have been forwarded. If this is a cold start, this message is for information only. If this is a warm start and RECONFIG=YES was specified, the operator will be asked if initialization should continue.

System action: If this is a cold start of JES2, processing continues. If this is a warm start and RECONFIG=YES is specified, JES2 issues message \$HASP441 asking if initialization should continue.

Operator response: If this is a warm start with RECONFIG=YES specified, notify the system programmer.

System programmer response: If this is a warm start with RECONFIG=YES specified, JES2 notifies you that one or both of the checkpoint data sets with which you are starting have been forwarded. If this is what you want, then reply Y to message \$HASP441 to continue initialization. If you reply N, JES2 terminates initialization.

Module: HASPIRDA

Routing Code: 1,2,10

Descriptor Code: 2,7

\$HASP439

Explanation:

►►—JES2 SUBTASK TO RECONNECT FSS—*fssname*—FAILED, FSS TERMINATED WITH ABEND02C, —SUBIT RC=—*xxxx*—►►

During a JES2 hot start, JES2 tried to reestablish the cross-memory interface required to support FSS *fssname*. JES2 used a subtask to schedule an SRB to reconnect to the FSS address space, and that subtask ended with a bad return code.

In the message text:

fssname The name of the functional subsystem.

System action: The FSS abends with ABEND code X'02C'. JES2 drains all devices associated with this FSS.

Operator response: Enter the \$S PRT*nnnn* command to restart the FSS. If JES2 also directly supports the FSS devices, issue the \$T command with MODE=JES and then issue the \$S command to start the device.

System programmer response: Use the SUBIT reason code to determine why the FSS reconnect subtask failed. See

\$SUBIT for a description of the \$SUBIT return codes in *z/OS JES2 Macros*. The probable cause is due to an abend during FSS reconnect SRB processing.

Module: HASPWARM

Routing Code: 1,2,10

Descriptor Code: 7

\$HASP440

Explanation:

▶▶—OUTPUT QUEUES—

ERROR CORRECTION
REBUILD

—IS COMPLETED.—*nnnn*—*text*—▶▶

JES2 found an error in the job queues during verification. To recover, JES2 either corrected the error or rebuilt the output queues. If JES2 moved any damaged JOEs to either the free or rebuild queue, the number *nnnnn* provides the number of JOEs moved. Recovery processing has completed.

In the message text:

nnnnn The number of JOEs re-queued to either the free or rebuild queue.

text is one of the following:

ELEMENTS DISCARDED

During an all-member warm start, damaged JOEs were moved to the free queue.

ELEMENT(S) PENDING DISCARD

During a JES2 warm start (quick, hot, single-member) damaged JOEs were moved to the rebuild queue awaiting discard.

The rebuild queue temporarily holds jobs (JOEs) that were actively being processed on a member of the MAS. JES2 returns these JOEs to the free queue at a later time.

System action: JES2 processing continues. Some output might have been lost in the recovery process.

Operator response: None.

System programmer response: None.

Module: HASPJOS

Routing Code: 1,2,10

Descriptor Code: 4

\$HASP441

Explanation:

▶▶—REPLY 'Y' TO CONTINUE INITIALIZATION—OR 'N' TO TERMINATE IN RESPONSE TO—MESSAGE HASPxxx—▶▶

This message is issued because one of two conditions occurred:

- The operator requested a cold start of JES2 (see message \$HASP436). JES2 prompts the operator to determine if the cold start should continue with the specifications displayed in \$HASP436.
- JES2 has found an error during initialization, and prompts the operator to determine whether initialization should continue.

System action: JES2 waits for the operator to reply.

Operator response: If this message follows \$HASP436 and you want JES2 to continue with the cold start using the displayed specifications, reply Y. If you do not want a cold start with the displayed specifications, reply N. JES2 ends.

If this message is issued because of an initialization error, notify the system programmer and reply to this message using the information below.

\$HASP442

- If this message follows the \$HASP858/\$HASP859 message pair (indicating that JES2 could not find a particular exit routine specified for EXITnnn) and you reply Y, JES2 ignores the missing exit routine and processes any other exit routines specified for EXITnnn.
- If you reply Y in other cases, JES2 proceeds, replacing the flagged parameter value with the last previously specified legitimate value or with the JES2 default value.
- If you reply N in any case, JES2 issues message \$HASP428 and then ends.

When the short form of the \$HASP441 message is issued, identify the highlighted message which precedes this \$HASP441 message. When the long form is issued, identify the message specified in the \$HASP441 message text (which preceded \$HASP441 and is highlighted). For both cases, review the options/consequences listed with the identified message.

System programmer response: If this message is issued because of an initialization error, correct the error as described in the preceding messages.

Module: HASPIRA

Routing Code: 1,2,10

Descriptor Code: 4

\$HASP442

Explanation:

►►—INITIALIZATION STATEMENTS CONFLICTING— WITH SAVED VALUES FOLLOW:—————►►

On a JES2 warm start, JES2 detected that certain initialization parameters do not match the settings saved in the JES2 checkpoint. This could be the result of a operator command that updated the parameters while the system was running or because an incorrect attempt was made to update the initialization statement. Following \$HASP442, the \$HASP496 message displays each incorrect initialization parameter, the value specified on the initialization statement, and the value saved in the checkpoint.

System action: JES2 issues the \$HASP496 message for each initialization statement. If the only conflicts that are detected are parameters that can be updated through operator commands, JES2 will initialize normally using the saved parameter settings. If a conflict is found in a parameter that cannot be updated by an operator command, either message \$HASP441 or \$HASP428 will be issued depending on whether restart can be continued with the changed values.

Operator response: If the \$HASP441 message is issued, examine which initialization statements are in error and verify that the correct initialization deck was used to start JES2. Reply Y to the \$HASP441 message to continue JES2 initialization using the saved parameter settings. Reply N to terminate JES2 initialization.

Note: Whether the \$HASP441 message is issued, notify the system programmer that there are incorrect or obsolete parameter settings in the JES2 initialization deck. If message \$HASP428 is issued, examine the initialization values in error and restart JES2 after correcting those which require correction as indicated by \$HASP496.

System programmer response: Update the initialization deck to reflect the correct values for the initialization statements in conflict. If the conflict was due to an attempt to alter an initialization parameter, then see the explanation for the statement in the *z/OS JES2 Initialization and Tuning Reference* to determine the correct way to update the parameter.

Module: HASPIRDA

Routing Code: 1,2,10

Descriptor Code: 4

\$HASP443

Explanation:

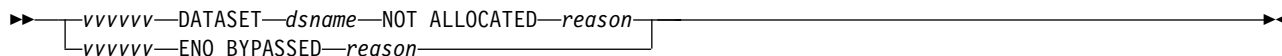

The specified spool volume has not been allocated. This message may follow another JES2 message indicating the problem.

In the message text, *reason* is one of the following:

- OBTAIN FAILURE, RC=01
 - I/O ERROR DURING FORMAT, RC=02
 - I/O ERROR DURING READ VALIDATION, RC=03
 - DYNAMIC ALLOCATION FAILURE, RC=04
 - allocation_message (This is the message put out by dynamic allocation in case of a failure)
 - INTERNAL ERROR, RC=05
 - UNABLE TO GET DEVICE INFORMATION, RC=06
 - UNUSABLE EXTENT SIZE, RC=07
 - EXTENT SIZE IS LIMITED TO 64K TRACKS --
 - NUMBER OF RECORDS PER TRACK EXCEEDS 15, RC=08
 - DSNAME AND VOLUME ALREADY OWNED BY ANOTHER MAS, RC=09
 - UNABLE TO CONSTRUCT ENQ MINOR NAME, RC=10
 - UCBINFO - RC=retcd RSN=rsncd
 - UNABLE TO CONSTRUCT ENQ MINOR NAME, RC=11
 - IOSCDR - RC=retcd RSN=rsncd
 - UNABLE TO CONSTRUCT ENQ MINOR NAME, RC=12
 - UNABLE TO FIND DEVICE IDENTIFICATION
 - UNABLE TO CONSTRUCT ENQ MINOR NAME, RC=13
 - DIAGNOSE - RC=retcd
- where retcd and rsncd are the return code and reason code from the failing service respectively.
- ERROR FINDING LARGEST EXTENT AVAILABLE, RC=14
 - EXTENT EXCEEDS 1,048,575 LIMIT, RC=15
 - SPOOL EXTENT TOO SMALL, RC=16
 - DATASET *dsname* NOT ALLOCATED, RC=17
 - SUBTASK ATTACH FAILURE, RC=18
 - MORE THAN xxx SPOOLS DEFINED, RC=19
 - EXTEND SPOOL UNSUCCESSFUL, RC=20

System action:

- For a cold start, the volume is ignored and processing continues.
- For an all-member warm start, the operator is queried as to the action to be taken. (The \$HASP853 message is issued.)
- For any other type of starts, initialization ends.
- If this message is issued in response to a start spool command, the command is rejected, and JES2 processing continues.

Operator response: Mount the correct volume on the required device.

For RC=20, use a VTOC reporting utility, such as IEHLIST, to determine the layout and size of data sets on the volume in relation to the JES2 spool data set extent.

Module: HASPSPOL, HASPIRDA

Routing Code: 1,2,10

Descriptor Code: 4

\$HASP444 • \$HASP445

\$HASP444

Explanation:

►►—*destid*—PRINT/PUNCH ROUTE CODE INVALID—◄◄

The routing code that appears in the *destid* field of the message text was specified on the ROUTECDE parameter of a JES2 initialization statement, but the routing code is incorrect for one of these reasons:

- If the routing code is an explicit value, then that value is greater than the maximum allowed.
- If the routing code is a symbolic value, then that symbol is not defined on a DESTID or a Nnnnn initialization statement.

In the message text:

destid The routing code.

System action: JES2 ends.

Operator response: Notify the system programmer.

System programmer response: Correct the error and restart JES2.

Module:

HASPIRA

Routing Code: 1,2,10

Descriptor Code: 4

\$HASP445

Explanation:

►►—UNACTIVATE REQUEST FAILED,—*reason*—◄◄

The unactivate request failed.

In the message text, *reason* is one of the following:

OTHER MEMBERS ACTIVE

| JES2 was warm started with PARM=UNACT specified; however, there are other members of the MAS that are
| active. PARM=UNACT can only be used on an all member warm start or an all member hot start (a hot start
| where there are no active JES2 address spaces). The effect is that the PARM=UNACT is ignored and JES2 starts
| in z/OS 2.2 (z22) mode.

MEMBER NOT ALLOCATED TO BOTH CHECKPOINT DATA SETS

| JES2 was warm started with PARM=UNACT specified; however, this member is not allocated to both checkpoint
| data sets (they have specified CKPT1 and CKPT2 as INUSE=YES, indicated MODE=DUPLEX and
| DUPLEX=OFF). You must be allocated to both checkpoint data sets to specify PARM=UNACT. The effect is that
| the PARM=UNACT is ignored and JES2 starts in z/OS 2.2 (z22) mode.

SPOOL MIGRATION IS IN PROGRESS OR A MAPPED VOLUME WAS FOUND

One of the following conditions prevented the unactivate request from succeeding:

- A JES2 spool migration is in progress and cannot be cancelled by the issued command. To run the issued command, you must first cancel the active spool migration by issuing the \$MSPL *volser* CANCEL command.
- One or more mapped spool volumes exist in the current configuration. Make sure that all mapped volumes are drained and removed from configuration and retry the command.

| **Note:** This applies to z/OS 2.1 only.

A SPOOL IS USING NON-DEFAULT DATA SET NAME

Either JES2 was warm started with PARM=UNACT or an \$ACTIVATE,LEVEL=Z2 command was issued, and JES2 detected at least one SPOOL volume with a non-default data set name. Z2 mode does not support

non-default data set names, so the SPOOL data set must be removed and created with the default SPOOL data set, as specified by SPOOLDEF DSNAME=, before switching to Z2 mode. The effect is that JES2 remains in z/OS Z11 mode.

Note: This applies to z/OS 2.1 only.

A greater than 1 character batch job class exists

Either JES2 was warm started with PARM=UNACT or an \$ACTIVATE,LEVEL=Z2 command was issued, and JES2 detected at least one job class of greater than one character. Z2 mode does not support greater than one character job class names, so the greater than one character job class must be deleted before switching to Z2 mode. The effect is that JES2 remains in z/OS Z11 mode.

Note: This applies to z/OS 2.1 only.

MAS ALREADY IN RELEASE 11 MODE

JES2 was warm started with PARM=UNACT specified; however, the JES2 MAS is already in z11 checkpoint mode.

JOB DEPENDENCY NETWORKS EXIST

JES2 was warm started with PARM=UNACT specified; however, at least one job dependency network (job groups) currently exists in the checkpoint.

An uplevel member is active in the MAS

A uplevel JES2 member is active in the MAS and it does not support the checkpoint level being unactivated to. The effect is that JES2 remains at the current checkpoint level.

System action: JES2 initialization continues.

Operator response: Notify the system programmer.

System programmer response: Correct the error and try again.

Module:

HASPIRDA

Routing Code: 1,2,10

Descriptor Code: 4

\$HASP446

Explanation:

▶▶—CURRENT CHECKPOINT DATA—SETS ARE IN—*checkpoint*—FORMAT. THIS IS NOT—SUPPORTED BY THE—*version*—▶▶
▶—LEVEL OF JES2—▶▶

JES2 warm start processing has read a checkpoint data set that is in a format that is not supported by the current level of JES2. This can happen if an z/OS is warm started with a checkpoint data set that has not been \$ACTIVATED (LEVEL=Z2).

In the message text:

nnnnnnnn

The format of the checkpoint data set.

vvvvvvvv

The level of the JES2 being started.

System action: JES2 terminates.

Operator response: Verify that the correct initialization deck and checkpoint data sets were used to start JES2. If not, restart JES2 with the correct initialization deck and checkpoint data sets. Otherwise, notify the systems programmer.

System programmer response: Review the migration requirements in the JES2 migration notebook for the release being started. Either follow the correct procedure to migrate to the new release or start a different level of JES2.

Module: HASPIRDA

\$HASP447 • \$HASP449

Routing Code: 1,2,10

Descriptor Code: 4

\$HASP447

Explanation:

▶— WARM START DENIED — ACTIVE SPOOL MIGRATION DETECTED —▶

A member cannot be warm started while a spool migration is in progress. For more information on MAS member restrictions, refer to the spool migration information in *z/OS JES2 Commands*.

System action: JES2 terminates.

Operator response: Wait for the spool migration to complete before warm starting the JES2 member.

System programmer response: None.

Module: HASPIRMA

Routing Code: 1,2,10

Descriptor Code: 4

\$HASP448

Explanation:

▶— ERROR ENCOUNTERED BUILDING— INFORMATION STRING— — *reason* —▶

During JES2 initialization, JES2 processing encountered an error when trying to build an information string for subsystem interface (SSI) call 54 (request subsystem version information). The information string could not be built for one of the following reasons:

STORAGE NOT AVAILABLE FOR INSTALLATION STRING

JES2 could not obtain the necessary storage in the extended common storage area for the installation information string.

INSTALLATION STRING LENGTH NOT VALID

The Exit 24 field X024SSIL (supplied length) was not valid.

STORAGE NOT AVAILABLE FOR SYSTEM STRING

JES2 could not obtain the necessary storage in the extended common storage area for the system information string.

System action: JES2 initialization continues: the SSI routine will operate without the string.

Operator response: Notify the system programmer.

System programmer response: If the reason text indicates that the installation string length is not valid, examine Exit 24 to ensure that the string is built correctly and supply the correct length.

Module: HASPIRA

Routing Code: 1,2,10

Descriptor Code: 4

\$HASP449

Explanation:

▶— MEMBER—*member-name*— — *volser*—MUST BE MOUNTED ON SHAREABLE DEVICE—▶

The specified volume is on a device that is not defined with 'share' option in the I/O configuration for MVS. If JES2

is operating in a multi access SPOOL configuration, the volumes used for the JES2 checkpoint and SPOOL must be on devices defined to z/OS with the 'share' option. JES2 will verify the definition of the device if SHARED=CHECK was specified on the MASDEF initialization statement.

In the message text:

member-name

The name of the member experiencing the problem. *member-name* is only displayed if this message is issued when JES2 is attempting to allocate a checkpoint data set on *volser*.

volser The volume identifier.

System action: If this message is issued for a checkpoint volume during JES2 initialization, JES2 initiates a checkpoint reconfiguration dialog. If JES2 is already within a checkpoint reconfiguration, JES2 prompts the operator for alternative actions.

If the volume is a required spool volume, JES2 ends. Otherwise, processing continues.

Operator response: If you are attempting to warm start JES2 when this message is received, it is possible that the I/O configuration for MVS has been updated incorrectly. JES2 will not be able to start unless either the definition of the device in the I/O configuration is updated to indicate the device is shared or JES2 is started with MASDEF SHARED=NOCHECK. By starting JES2 with the PARM=CONSOLE option, it is possible to restart JES2 and update the MASDEF SHARED parameter setting. However, you should not operate an MAS until the definition of the device is corrected in the MVS I/O configuration. Contact the programmer responsible for defining devices to the system to correct the device definition.

System programmer response: If you are not familiar with the checkpoint dialog process, see *z/OS JES2 Initialization and Tuning Guide* for a detailed discussion.

If you are running this JES2 member in a non-MAS environment, specify MASDEF SHARED=NOCHECK.

Module: HASPSPOL, HASPCKDS

Routing Code: 1,2,10

Descriptor Code: 4

\$HASP450

Explanation:

▶▶—OPEN FAILED FOR JES2 PARAMETER LIBRARY—

DDNAME
MEMBER

name—▶▶

JES2 issued an OPEN macro instruction for the parameter library data set and determined that the data set was not opened.

name is the name of the DD statement or member name in PARMLIB that could not be opened.

System action: Message \$HASP441 follows, requesting operator action.

Operator response: Check with the system programmer as to whether you should allow initialization to continue. Respond to the \$HASP441 message accordingly.

System programmer response: Determine the cause of the error and correct it.

Module: HASPIRPL

Routing Code: 1,2,10

Descriptor Code: 4

\$HASP451

Explanation:

▶▶—ERROR ON JES2 PARAMETER LIBRARY—▶▶

JES2 encountered an error when reading the initialization parameter library.

- Otherwise processing continues without the volume.

System programmer response: Reallocate data set *dsname* using a single extent.

Module:

HASPSPOL, HASPCKDS

Routing Code: 1,2,10

Descriptor Code: 4

\$HASP454

Explanation:

►►—SHOULD JES2 BYPASS THE MULTI-MEMBER—INTEGRITY LOCK? ('Y' OR 'N')—►►

JES2 initialization has issued message \$HASP479, indicating this member cannot obtain the multi-member integrity lock on the checkpoint data set. JES2 has obtained primary serialization on the checkpoint data set with a hardware reserve. JES2 prompts the operator to reply if processing should continue without the lock.

System action: JES2 waits for the operator's reply.

Operator response: This message prompts you to take the lock from the holding member. Replying Y bypasses serialization. Note that replying Y inappropriately could be harmful because the integrity of checkpoint data might be compromised. If JES2 initialization should continue without the multi-member integrity lock on the checkpoint data set, reply Y to direct JES2 to steal the lock. For example, you might reply Y in the following case:

- The JES2 member indicated in \$HASP479 holds the lock but has abnormally ended, or a system failure has occurred while the operating system was initializing a member in the configuration.

If you do not want to continue without the multi-member integrity lock on the checkpoint data set, reply N. For example, you might reply N in the following cases:

- A JES2 checkpoint reconfiguration is in progress on other members of the MAS
- The operator might have started the JES2 member with the wrong initialization data set. The data set does not reflect the forwarded checkpoint data set name.
- The reserve is broken (the device is not defined as shared, or is not functioning as expected). This could be caused by an OEM (other equipment manufacturer) GRS problem.
- The member holding the lock is another active member.

Replying N causes the member to issue either \$HASP416 or \$HASP460, and the \$HASP417 message. The \$HASP416 and \$HASP460 messages display the current checkpoint data set specifications according to JES2, and \$HASP417 prompts the operator to either confirm the specifications or have JES2 initiate a reconfiguration dialog to define the correct checkpoint data set specifications.

System programmer response: Determine why the checkpoint data set lock is not being released.

Module: HASPIRDA

Routing Code: 1,2,10

Descriptor Code: 2

\$HASP455

Explanation:

►►—*jobname*—
 ├ IS PURGED, CONTROL BLOCK READ ERROR—
 └ IS PURGED, SPOOL VOLUME NO LONGER EXISTS—►►

During a warm start, JES2 encountered one of the following conditions:

- An error while reading the job control table (JCT) or I/O table (IOT) for the specified job.

\$HASP456 • \$HASP457

- The specified job is using space on a spool volume that no longer exists. This occurs if the operator replied "PURGE" to a \$HASP853 message.

In the message text:

jobname The name of the job.

Note: A job ID might precede \$HASP455. See "JES2 message format" on page 1.

System action: The job is purged. Spool space used by the job cannot be made available until the JES2 spool reclamation function runs.

Operator response: None.

Module:

HASPWARM

Routing Code: 1,2

Descriptor Code: 4

\$HASP456

Explanation:

▶▶—LINEⁿⁿⁿ—REQUEST TO BE— NON - SHARED BY REMOTE DENIED—▶▶

JES2 indicates that a RMT(ⁿⁿⁿⁿ) statement specified that the LINE= value is SHARABLE=NO, but another RMT(ⁿⁿⁿⁿ) statement has specified the same LINE= value. The line will be shared.

In the message text:

nnnn The number of the line that JES2 forced to be shared.

System action: Processing continues.

Operator response: None.

Module:

HASPIRRE

Routing Code: 1,2,10

Descriptor Code: 4

\$HASP457

Explanation:

▶▶—FORWARDED DATA SET NAME FOUND. SHOULD—JES2 FORWARD? ('Y' OR 'N')—▶▶

JES2 initialization has found that the data set specifications read in for CKPT1 or CKPT2 do not match the specifications currently in use. This occurs if the specifications have been read in a data set that has been forwarded.

System action: JES2 waits for the operator's reply.

Operator response: If you reply Y, JES2 searches forward a maximum of 8 data sets until a checkpoint data set with no forwarding specification is found. If no such data set is found, JES2 reissues message \$HASP457 and continues to search the next 8 data sets.

If you reply N, JES2 will initiate a checkpoint reconfiguration dialog with the operator to determine the correct data set specifications.

System programmer response: If the data set specifications are obsolete, update the CKPTDEF initialization statement with the correct values.

Module:

HASPIRDA

Routing Code: 1,2,10

Descriptor Code: 2

\$HASP458

Explanation:

►►—FORWARDED CKPT—*n*—DATA SET IS—
 ┌(—*dsname*—ON VOLUME—*volser*—)
 └(—STRNAME—*strname*—) ◄◄

Because of a forwarding request, JES2 initialization is beginning to process a new checkpoint data set. In the message text:

- dsname** The checkpoint data set name.
- volser** The volume serial number on which the data set resides.
- strname** The name of the coupling facility structure.
- n** The number of the checkpoint data set (either 1 or 2).

System action: JES2 begins using the new checkpoint data set.

System programmer response: If the data set specifications are obsolete, update the CKPTDEF initialization statement with the correct values.

Module: HASPIRDA

Routing Code: 1,2,10

Descriptor Code: 4

\$HASP459

Explanation:

►►—CHECKPOINT LOCK ASSUMED TO BE HELD BY—THIS SYSTEM — LOCK BYPASSED—◄◄

This message is issued when the installation has specified CKPTLOCK=INFORM on the JES2 MASDEF initialization statement and JES2 has determined that the system holding the checkpoint lock is the same JES2 system currently being initialized. This message is to inform the operator that since the two system IDs match, the checkpoint lock will be taken back.

System programmer response: The system issues the message and continues.

Programmer response: None.

Module:

HASPIRDA

Routing Code: 2,10

Descriptor Code: 4

\$HASP460

Explanation:

►►—UNABLE TO CONFIRM THAT—EITHER DATA SET IS A VALID CHECKPOINT DUE TO—
 ┌CKPT*n* IS A VALID CHECKPOINT DATA SET DUE TO—
 └ ◄◄

\$HASP460

- ▶ AN I/O ERROR READING THE LOCK RECORD—AND A LOCK RECORD VALIDATION FAILURE—
- ▶ VERIFY THE SPECIFIED CHECKPOINT DATA SETS ARE CORRECT—
- ▶ VALUES FROM CKPTDEF | VALUES JES2 WILL USE | DATA SET(S) JES2 COULD NOT CONFIRM |
- ▶ LAST WRITTEN—*day, dd mmm yyyy*—AT—*hh:mm:ss*—(LOCAL TIME / GMT)

VALUES FROM CKPTDEF:

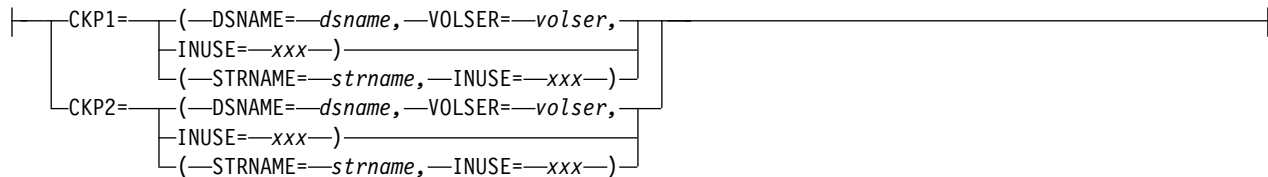

VALUES JES2 WILL USE:

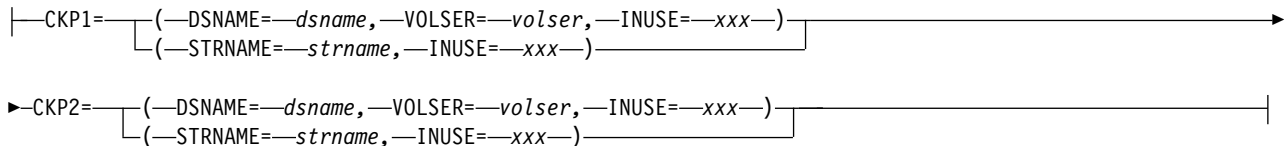

DATA SET(S) JES2 COULD NOT CONFIRM:

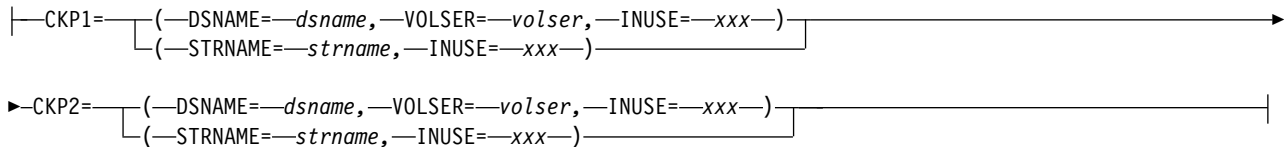

JES2 initialization is unsure of the checkpoint data set definitions because it was either unable to validate that the cold start times of CKPT1 and CKPT2 match or because it was unable to read either CKPT1 or CKPT2. JES2 wants the operator to confirm that it should use the data sets listed as checkpoints. If this message follows message \$HASP457, JES2 has encountered an error on the forwarded data set. JES2 wants to confirm that it should use the new (forwarded) checkpoint data set(s).

In the message text:

dsname

The name of the data set.

volser The volume identifier.

strname

The name of the coupling facility structure.

xxx Either **YES** or **NO**, indicating whether the data set is currently in use.

System action: JES2 issues message \$HASP417.

Operator response: Respond to message \$HASP417.

System programmer response: If the data set JES2 will use is incorrect, update the CKPTDEF initialization statement with the correct CKPT*n* values and then restart JES2.

Module: HASPIRDA

Routing Code: 1,2,10

Descriptor Code: 2,7

\$HASP461

Explanation:

▶▶—*jobname*—WAS ON—*device*—ON MEMBER—*member-name*————▶▶

JES2 warm start found that the indicated job was being received for processing when a system failure occurred. In the message text:

jobname

The name of the job.

device

The name of the job receiver on which the job was active.

member-name

The name of the member on which the job was being processed.

Note: A jobid may precede \$HASP461. See “JES2 message format” on page 1.

System action: The job is queued for purge.

Operator response: None.

Module: HASPWARM

Routing Code: 1,2

Descriptor Code: 4

\$HASP462

Explanation:

▶▶—*jobname*—WAS ON—*device*—ON MEMBER—*member-name*————▶▶

JES2 warm start found that the indicated job was being transmitted to another node for processing or being offloaded when a system failure occurred.

In the message text:

jobname

The name of the job.

device

The name of the job transmitter on which the job was active.

member-name

The name of the member on which the job was being processed.

Note: A jobid may precede \$HASP462. See “JES2 message format” on page 1.

System action: The job is requeued for transmission.

Operator response: None.

Module: HASPWARM

Routing Code: 1,2

Descriptor Code: 4

\$HASP463

Explanation:

\$HASP464 • \$HASP465

▶▶—*jobname*—WAS ON—*device*—ON MEMBER—*member-name*—▶▶

JES2 warm start found that the indicated job's system output was being received from another node when a system failure occurred.

In the message text:

jobname

The name of the job.

device The name of the SYSOUT receiver on which the job was active.

member-name

The name of the member on which the job was being processed.

Note: A jobid may precede \$HASP463. See “JES2 message format” on page 1.

System action: The job is queued for purge. Output already received is discarded.

Operator response: None.

Module: HASPWARM

Routing Code: 1,2

Descriptor Code: 4

\$HASP464

Explanation:

▶▶—*jobname*—OUTGRP=*outgrp*—WAS ON—*device*—ON MEMBER—*member-name*—▶▶

JES2 warm start found that the indicated job's system output was being transmitted to another node or being offloaded when a system failure occurred.

In the message text:

jobname

The name of the job.

outgrp The name of the output group that was active on the print/punch device.

device The name of the SYSOUT transmitter on which the job was active.

member-name

The name of the member on which the job was being processed.

Note: A jobid may precede \$HASP464. See “JES2 message format” on page 1.

System action: The job's output is requeued for transmission.

Operator response: None.

Module: HASPWARM

Routing Code: 1,2

Descriptor Code: 4

\$HASP465

Explanation:

▶▶—RMTnnnn—SPECIFIES INVALID LINE VALUE—▶▶

A BSC remote terminal attempted to specify ownership of an SNA line; an SNA remote terminal attempted to specify a BSC line; or a remote terminal (either BSC or SNA) specified a line that was not defined using a LINE(nnnn) initialization statement.

In the message text:

nnnn The number of the remote terminal.

System action: The system scans the remaining parameters, flags the errors, and issues a message requesting that JES2 be restarted.

Operator response: Notify the system programmer. Restart JES2 when the problem has been corrected.

System programmer response: Correct the line subparameter of the **RMT(nnnn)** initialization statement for this terminal.

Module: HASPIRRE

Routing Code: 1,2,10

Descriptor Code: 4

\$HASP466

Explanation:

►►—*initialization-parameter-statement-image*—◄◄

This message is issued for each initialization parameter statement having an error when JES2 initialization is not in console mode. All continuation cards pertaining to this initialization parameter statement should be examined for errors because this message displays only the first continuation card, not necessarily the continuation card(s) that have errors (bad parameters).

This message is followed by the \$HASP467 message, which forces JES2 initialization into console mode. The \$HASP467 message contains the diagnostic; the \$HASP469 reply message gives the operator an opportunity to correct the initialization statement in error. If the initialization statement is not in error but the LOG control parameter is in effect, the message is sent to the system log.

In the message text:

initialization-parameter-statement-image

The text of the initialization statement parameter.

System action: Processing continues.

Operator response: See message \$HASP469.

Module:

HASPIRPL

Routing Code: 1,2,10

Descriptor Code: 4

\$HASP467

Explanation:

►►—*diagnostic*—◄◄

Where *diagnostic* is one of the following:

- END-OF-INPUT INDICATION
- STATEMENT BYPASSED BY INSTALLATION EXIT
- STATEMENT INSERTED BY INSTALLATION EXIT
- TERMINATION REQUESTED BY INSTALLATION EXIT
- STATEMENT INSERTED BY JES2 DEFAULT
- VERIFICATION ERROR
- UNABLE TO REP DATA
- DATA OR FORMAT ERROR
- COMMAND LENGTH ERROR

\$HASP467

- COMMENT ERROR

This message is issued following the \$HASP466 message when an error is encountered in a JES2 initialization statement. Because the initialization error forces JES2 initialization into console mode, this message is followed by message \$HASP469.

The possible diagnostic messages are:

END-OF-INPUT INDICATION

The parameter statement displayed in message \$HASP466 was an end-of-input indication (/ * parameter). This is an informational message to indicate that parameter input processing stopped although an end-of-file had not been reached for the PARMLIB parameter input data set.

STATEMENT BYPASSED BY INSTALLATION EXIT

The parameter statement displayed in message \$HASP466 was bypassed by an exit 19 routine. This message is issued to the console only if the parameter input came from the console.

Note: This is a warning message, not an error message.

STATEMENT INSERTED BY JES2 DEFAULT

The parameter statement is inserted by default.

STATEMENT INSERTED BY INSTALLATION EXIT

The parameter statement displayed in message \$HASP466 was inserted by an exit 19 routine.

Note: This is an informational message, not an error message.

TERMINATION REQUESTED BY INSTALLATION EXIT

An exit 19 routine requested a stop of JES2 initialization when it was passed the associated parameter statement.

VERIFICATION ERROR

A VERIFY statement was entered but the storage being verified does not contain the data that was specified on the statement.

The verification error causes JES2 to ignore all subsequent REP statements until JES2 encounters a NAME statement.

UNABLE TO REP DATA

The JES2 REP facility was unable to replace the data at the specified storage location. The most probable cause of this error is that the specified storage is read-only. An example of read-only storage is storage in the pageable link pack area (PLPA).

If a VER statement failed, JES2 ignores subsequent REP statements until it encounters a NAME statement.

DATA OR FORMAT ERROR

The format of the data specified on a JES2 VER or REP facility statement is incorrect. Some possible errors are:

- JES2 has not yet loaded the module specified on a statement.
- The installation used incorrect delimiters to separate fields on a statement.
- The statement does not contain enough fields.
- The module name exceeds eight characters.

COMMAND LENGTH ERROR

A command in the JES2 initialization deck exceeds 132 characters.

COMMENT ERROR

A command in the JES2 initialization deck contains an invalid comment.

See message \$HASP003 for more information.

System action: Processing continues.

Operator response: Notify the system programmer. (See message \$HASP469.)

System programmer response: Correct the problem identified in the diagnostic message.

Module:

HASPIRPL

Routing Code: 1,2,10

Descriptor Code: 4

\$HASP468

Explanation:

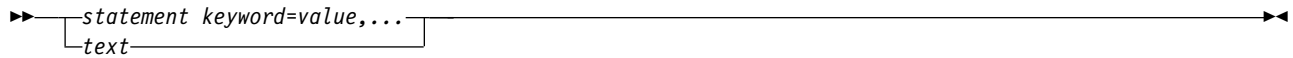

This message contains the response to the DISPLAY initialization control statement when the following are true:

- The statement requested the display of a fixed text string or
- The statement requested a display for all or part of a JES2 initialization statement for which there are no JES2 operator commands.

Display requests for JES2 initialization statements that share common definitions with JES2 \$D and \$T commands result in the same messages and message ids as those commands. Depending on what information you specified on the DISPLAY statement, the response is one of the following:

- The text of a message in the DISPLAY statement or command.
- All of the keywords defined on the specified initialization statement or command and their current values (if the statement name is specified without any keywords).
- Certain keywords defined on the initialization statement or command and their associated values (if the statement name and those keywords are specified on the DISPLAY statement or command).

In the message text:

statement

The initialization statement or command.

value

The value of that parameter.

text

Lists all of the keywords on the initialization statement or command.

Note: Placement of the DISPLAY initialization control statement influences whether JES2 will display coded or default options. It is recommended that you place the DISPLAY statement following the initialization statement to be displayed.

System action: Processing continues.

Operator response: None.

Module: HASCSCAN

Routing Code: 1,2,10

Descriptor Code: 4

\$HASP469

Explanation:

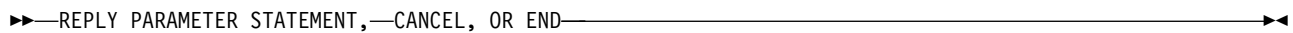

JES2 initialization is requesting the operator to enter either an initialization statement or a control statement.

System action: JES2 waits for the operator to reply.

Operator response: Reply with one of the following responses:

- Initialization statement – This response allows you to change an initialization statement. After you have entered the initialization statement, and JES2 has processed it, JES2 reissues this message. If you have no further statements to add, respond with **END** and JES2 processing resumes.

\$HASP470 • \$HASP472

- Control statement – This response allows you to submit a control statement. After you have entered the control statement, and JES2 has processed it, JES2 reissues this message. If you have no further statements to add, respond with **END** and JES2 processing resumes.
- **CANCEL** – The system issues message \$HASP428 and JES2 processing ends.
- **END** – This response signifies that parameter library processing resumes. The system creates a symptom record in the LOGREC data set.

Module: HASPIRPL

Routing Code: 1,2,10

Descriptor Code: 4

\$HASP470

Explanation:

▶▶—MEMBER—NOT DORMANT—▶▶
 └──COMPLEX──┘

Analysis indicates this member is not dormant or at least one member in the MAS configuration is not dormant.

System action: JES2 issues message \$HASP471 requesting operator response.

Operator response: See message \$HASP471.

Module: HASPIRDA

Routing Code: 1,2,10

Descriptor Code: 4

\$HASP471

Explanation:

▶▶—REPLY 'Y' TO CONTINUE—COLD—START, 'N' TO TERMINATE JES2—▶▶
 └──WARM──┘

Analysis determined that this system or MAS configuration is not dormant. The operator must determine if it is safe to continue. This message is preceded by \$HASP470.

Note: If another system in the configuration is currently being initialized, a reply to this message should not be made until the other system has finished its initialization processing.

System action: JES2 waits for the operator to reply.

Operator response: Evaluate the system/configuration environment and enter the appropriate reply. If N is entered, message \$HASP428 is issued and initialization processing stops.

Module: HASPIRDA

Routing Code: 1,2,10

Descriptor Code: 4

\$HASP472

Explanation:

▶▶—BOTH CHECKPOINT DATA SETS—ARE MARKED INUSE=NO—▶▶

The current CKPTDEF definition has INUSE=NO specified for both CKPT1 and CKPT2.

System action: JES2 initiates a checkpoint reconfiguration dialog with the operator to change the checkpoint specifications.

Operator response: Reply to the \$HASP289 dialog message with either:

- A CKPTDEF statement with INUSE=YES specified for CKPT1, CKPT2, or both.
- The TERM option. If you reply TERM, you must restart JES2 with valid CKPTDEF specifications.

Module: HASPIRDA

Routing Code: 1,2,10

Descriptor Code: 4

\$HASP473

Explanation:

▶▶—ERRORS OCCURRED CREATING JES2—CELL POOL RC=—*rsnc*—TYPE=—*ccccccc*—JOBNAME=—*jobname*—▶▶

JES2 initialization has detected errors in creating a cell pool. This could be caused by any of the following:

- The cell (buffer) size is not correct.
- There is already a cell pool created.
- Storage cannot be obtained because of insufficient space.
- An internal JES2 logic error.

In the message text:

ccccccc The type of cell pool JES2 was trying to create when the error occurred. TYPE= can be one of the following:

Type	Init Stmt	Parm	Storage
BAT	BUFDEF	EXTBUF	BELOW
BSC	TPDEF	BSCBUF	BELOW
B32K	N/A	N/A	ANY
CB	BUFDEF	EXTBUF	ANY
CMB	CONDEF	BUFNUM	ANY
EVT	N/A	N/A	ESCA
HASP	BUFDEF	BELOWBUF	BELOW
HEDR	NJEDEF	HDRBUF	ANY
ICE	TPDEF	SESSIONS	ANY
NAT	N/A	N/A	ANY
NSA	N/A	N/A	ANY
NMAP	N/A	N/A	ANY
NTQ	N/A	N/A	ANY
PAGE	PRTnnnn	number of 3800 printers defined	BELOW
PP	PRTnnnn	(number of non-3800 non-3800 printers) + (number of printers with TRKCELL=YES) + number of punches	BELOW
PSO	N/A	N/A	Dataspace
RNT	N/A	N/A	ANY
SMF	SMFDEF	BUFNUM	ANY
SAPID	N/A	N/A	Dataspace
STAC	N/A	N/A	Dataspace
TJEV	N/A	N/A	Dataspace
TRE	N/A	N/A	ANY
VTAM	TPDEF	SNABUF	ANY
XRQ	N/A	N/A	ANY

rsnc The reason code.

Possible values of *rsnc* and their meanings are:

\$HASP474

rsnc Meaning

- 00** During its initialization, JES2 attempted to obtain a cell pool of TYPE=ccccccc, but failed to do so because the request exceeded the cell pool limit. However, to allow initialization to proceed, JES2 obtains the cell pool by setting the primary extent to 1. IBM suggests that you review the appropriate initialization statement for the specified buffer type and either reduce the number of buffers specified there or, for a cell pool with a storage type of ANY, increase the region size of the address space where that cell pool resides.
- 04** There exists a cell pool with the same attribute as the one JES2 is trying to create.
- 08** Insufficient storage for the cell pool.

jobname The name of the job that encountered the error.

System action: JES2 initialization ends.

Operator response: Notify the system programmer.

System programmer response: Examine the appropriate JES2 initialization statement for the buffer type specified and reduce the number of buffers specified or increase the JES2 region size for cell pools specifying storage ANY. Restart JES2.

If RC=8, then restart JES2 with an increased region size. If the problem persists, contact your IBM support representative.

Module: HASCPPOOL

Routing Code: 1,2,10

Descriptor Code: 4

\$HASP474

Explanation:

▶—OVERLAPPING \$BERTTABL ENTRIES:—\$BERTTAB CBTYPE=—*cotype*,—NAME=—*name1*,—CBOFF=—*xxxx-xxxx*————▶

▶—USER TABLE—\$BERTTAB CBTYPE=—*cotype*,—NAME=—*name2*,—CBOFF=—*xxxx-xxxx*—USER TABLE—▶
└—HASP TABLE—┘ └—HASP TABLE—┘

JES2 initialization has detected that \$BERTTAB entries have been coded which unexpectedly used overlapping offsets. In the message text:

cotype The value of the CBTYPE operand as coded in the overlapping tables.

name1, name2

The value of the NAME operand as coded in each of the overlapping tables.

xxxx The low and high offset defined by the CBOFF and LEN values specified on each table.

System action: JES2 initialization ends.

Operator response: Notify the system programmer.

System programmer response: Examine any USER tables that are pointed to by this message and correct the CBOFF and LEN values so that an overlap will no longer exist. If one of the tables pointed to by the message is a HASP table, it is possible that a reassembly of the module containing the USER table will correct the problem.

Module: HASPCKPT

Routing Code: 1,2,10

Descriptor Code: 4

\$HASP475

Explanation:

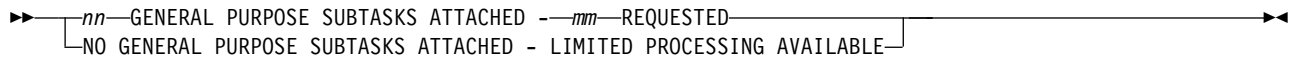

An attempt to attach one or more general purpose subtasks failed.
In the message text:

nn The number of general purpose subtasks attached.

mm The number of general purpose subtasks requested.

System action: If at least one subtask was attached (first version of \$HASP475), JES2 provides all functions, but functions that require subtasking will be processed at a reduced rate.

If no general purpose subtasks were attached (second version of \$HASP475), JES2 provides only those functions required for system operation and performance is severely degraded.

Operator response: Reply to the accompanying \$HASP872 message and notify the system programmer. Restart JES2.

System programmer response: Examine the \$DTEDYN and MVS ATTACH return codes to determine the cause of the problem.

Module: HASPIRMA

Routing Code: 1,2,10

Descriptor Code: 4

\$HASP477

Explanation:

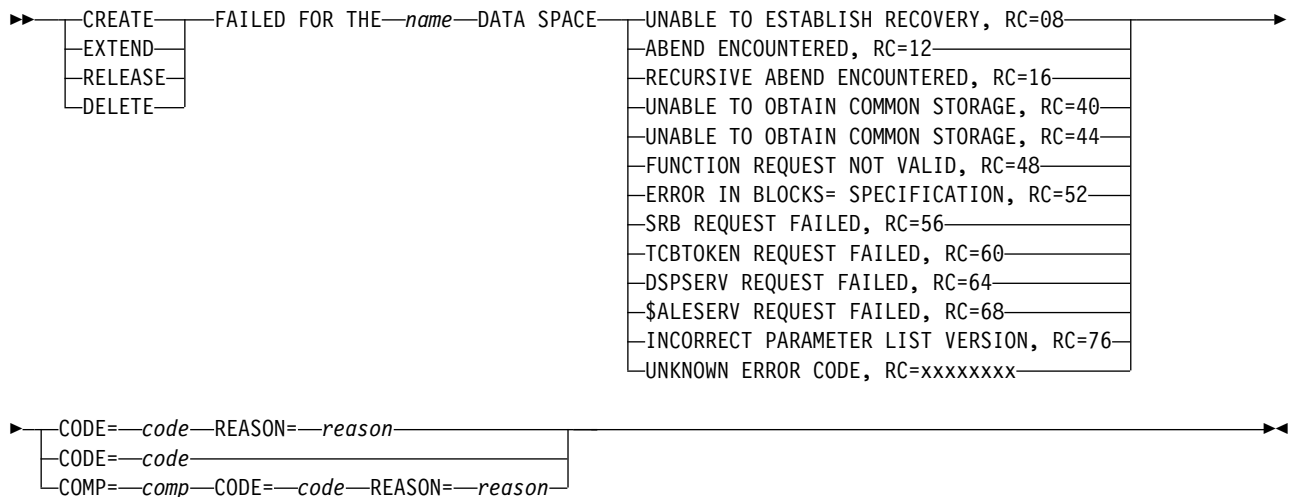

JES2 encountered an error while manipulating the data space *name*, the common name of the data space passed as NAME= on the data space CREATE request.
The message text displays the failed function as: CREATE, EXTEND, RELEASE, or DELETE. and \$DSPSERV returns the following failure explanations and associated reason codes as displayed in the message text:

Text \$DSPSERV Return Code

UNABLE TO ESTABLISH RECOVERY
RC=08

ABEND ENCOUNTERED
RC=12

\$HASP478

RECURSIVE ABEND ENCOUNTERED

RC=16

UNABLE TO OBTAIN COMMON STORAGE

RC=40

UNABLE TO OBTAIN COMMON STORAGE

RC=44

FUNCTION REQUEST NOT VALID

RC=48

ERROR IN BLOCKS= SPECIFICATION

RC=52

SRB REQUEST FAILED

RC=56

TCBTOKEN REQUEST FAILED

RC=60

DSPSERV REQUEST FAILED

RC=64

\$ALESERV REQUEST FAILED

RC=68

INCORRECT PARAMETER LIST VERSION

RC=76

UNKNOWN ERROR CODE

RC=xxxxxxx

System action: JES2 ends. For all return codes except 16, no data space was created or deleted.

Operator response: Notify the system programmer.

System programmer response: If the reason code is 12 or greater, call the IBM Support Center with the reason code and the LOGREC data set.

Module: HASCDSS

Routing Code: 1,2,10

Descriptor Code: 10

\$HASP478

Explanation:

▶▶—INITIAL CHECKPOINT READ IS—FROM CKPT1/2—*text*—————▶▶

Where *text* is one of the following:

(*dsname* ON *volser*) | (STRNAME *strname*)
LAST WRITTEN *day, dd mmm yyyy* AT *hh:mm:ss*
(LOCAL TIME) | (GMT)

▶▶—CONFIRM INITIAL CHECKPOINT READ FROM CKPT1/2—————▶▶

(*dsname* ON *volser*) | (STRNAME *strname*)
LAST WRITTEN *day, dd mmm yyyy* AT
hh:mm:ss
(LOCAL TIME | GMT)
{COMPANION DATA SET IS CKPT 1/2}
{*dsname* ON *volser*} | (STRNAME *strname*)}

{LAST WRITTEN *day, dd mmm yyyy* AT
hh:mm:ss
 (LOCAL TIME) | (GMT)}

In the first form of the message (INITIAL CHECKPOINT READ IS FROM CKPTn . . .), JES2 is informing the operator of the checkpoint data set it will read from for the initial copy of the checkpoint data.

A new form of the \$HASP478 message (CONFIRM INITIAL CHECKPOINT READ FROM CKPT1/2) is shown above. If this confirmation form of the message is issued, then JES2 has detected a data set's last written time that is outside what JES2 considers normal. The LAST WRITTEN TIME in the message is the time associated with the checkpoint data set JES2 will read the control blocks from. LOCAL TIME or GMT displays depending on which was stored in the checkpoint. JES2 is attempting to confirm that the data sets being used on the read are correct. The checkpoint 2 information is optional (only used if there is a CKPT2 data set) and is issued when the code detects an unexpected time stamp in the checkpoint data sets. Message \$HASP441 is issued in response to \$HASP478 as follows:

\$HASP441 REPLY 'Y' TO CONTINUE INITIALIZATION OR 'N' TO TERMINATE IN RESPONSE TO MESSAGE HASP478

In the message text:

dsname

The data set name.

volser

The volume serial number of the volume on which the data set resides.

strname

The name of the coupling facility structure.

n

The number of the checkpoint data set (either 1 or 2).

day

The day of the week (Monday, Tuesday,) that the checkpoint data set was last written.

dd mmm yyyy

The date of the last write to the checkpoint in day, month, year format (for example, 22 JUN 1994).

hh:mm:ss

The time of the last write to the checkpoint in hour:minute:second format (for example, 18:24:45).

Note: In Z2 mode, the CKPT write-time is recorded in GMT time format instead of LOCAL time. Therefore, when you use any checkpoint data set last-written in Z2 mode, the message \$HASP478 displays the time in GMT time format.

System action: JES2 processing continues.

Operator response: Verify the information is correct. If it is not correct, notify the system programmer.

System programmer response: If the checkpoint data set specification is not correct, stop JES2 as soon as possible. Determine the cause of the problem, correct it, and restart JES2. When JES2 comes up, check for possible spool damage.

Module:

HASPIRDA

Routing Code: 1,2,10

Descriptor Code: 4

\$HASP479

Explanation:

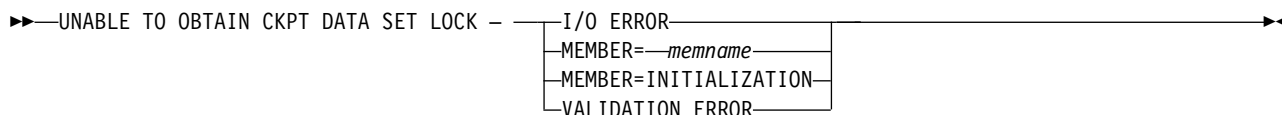

\$HASP481 • \$HASP482

JES2 initialization processing was not able to obtain control of the checkpoint data set.

- If **I/O ERROR** appears in the message text, an I/O error occurred on all defined checkpoint data sets while JES2 was attempting to obtain the checkpoint data set lock.
- If **MEMBER=memname** appears in the message text, another member in the MAS configuration has abnormally ended without releasing the checkpoint data set lock.
The member that has not released the lock is identified by *memname*.
- If **MEMBER=INITIALIZATION** appears in the message text, a system failure occurred while the operating system was initializing a JES2 member in the configuration. The JES2 member that the operating system was initializing did not release the checkpoint data set lock.
- If **VALIDATION ERROR** appears in the message text, the lock record was not in the correct format. Verify that the data set is a valid JES2 checkpoint.

If you are doing a cold start and using a new checkpoint data set, or if you are doing a all-members warm start, the system may issue this message as part of normal processing, in which case it does not indicate an error condition. This is also true when performing an all-members warm start and using the CKPTn option to restart JES2.

System action: JES2 issues message \$HASP454.

Operator response: Respond to message \$HASP454.

System programmer response: Determine why the checkpoint data set lock is not being released.

Module: HASPIRDA

Routing Code: 1,2,10

Descriptor Code: 2,7

\$HASP481

Explanation:

▶▶—~~PARM=CKPT—n—REJECTED~~ — — DATA SET IS MARKED INUSE=NO—▶▶

The JES2 operator used the CKPTn initialization option to request the initial read of the specified CKPTn data set. JES2 failed this request because INUSE=NO was specified for this data set on the CKPTDEF initialization statement or because CKPTn was not in use after forwarding completed.

In the message text:

n The number of the checkpoint data set. The number is either 1 or 2.

System action: JES2 processing ends.

Operator response: Either omit the CKPTn initialization option or have the system programmer change the specification of the appropriate CKPTn subparameter on the CKPTDEF initialization statement.

System programmer response: If necessary, specify INUSE=YES for this CKPTn data set on the CKPTDEF initialization statement.

Module:

HASPIRDA

Routing Code: 1,2,10

Descriptor Code: 4

\$HASP482

Explanation:

▶▶—WARM START DENIED —INCOMPATIBLE CHECKPOINT DATA SETS—CKPT1—

(dsname—ON—volser)
(strname)

—▶▶

▶—WAS COLD STARTED AT—*hh:mm:ss.hs*—ON—*yy.ddd*—CKPT2—(*dsname*—ON—*volser*)————→
(*strname*)

▶—WAS COLD STARTED AT—*hh:mm:ss.hs*—ON—*yy.ddd*————→

A warm start was requested when both CKPT1 and CKPT2 were in use. When JES2 began to read the data sets, it discovered that they were from separate cold starts and it could not accurately determine which data set is more current. Because of this, JES2 will not allow the system to come up.

Note: This situation can also happen if, while processing forwarded data sets, JES2 encounters a data set with a different cold start date.

In the message text:

dsname

The data set name.

volser The volume serial number.

hh:mm:ss.hs

The cold start time in hours, minutes, seconds, and hundredths of seconds.

strname

The name of the coupling facility structure.

yy.ddd The Julian date.

System action: JES2 ends.

Operator response: Either restart JES2 with a different CKPTDEF initialization statement or, if this is the configuration you want, specify the RECONFIG and CKPTn options on the START command to reconfigure the system and specify which data set should be read from first.

System programmer response: Determine which cold start date is correct and start from that data set. Modify the initialization stream as needed.

Module: HASPIRDA

Routing Code: 1,2,10

Descriptor Code: 4

\$HASP483

Explanation:

▶▶—JES2 JOB QUEUE ERROR,—RC=—*rc*— — —REPLY 'Y' TO REBUILD OR—'N' TO TERMINATE JES2————→

In the message text:

rc *rc* identified the type of queue error detected. Reason codes from X'01' to X'7F' are error encountered in the job queue.

An error has been found in the structure of the JES2 job queue. During system operation, the error could result in unpredictable problems, including JES2 catastrophic errors.

System action: JES2 waits for the operator to reply. If the system programmer directs you to respond 'Y', JES2 rebuilds the job queue and forces the JES2 start option REQ which then prompts an additional response to message \$HASP400.

Operator response: Notify the system programmer.

System programmer response: Unless you can identify a procedural problem that caused a mismatch between the checkpoint and the level of the system you are initializing that you can identify and correct, a response of Y is recommended to allow JES2 to rebuild the queue. However, some jobs or output might be lost and JES2 might change job priorities within the queue. During the current JES2 warm start, JES2 forces the REQ option, which will prompt additional operator action (see message \$HASP400).

Reply N, if you want JES2 to terminate to correct a procedural problem.

\$HASP484 • \$HASP486

Module: HASPIRDA

Routing Code: 1,2,10

Descriptor Code: 4

\$HASP484

Explanation:

▶▶—OUTPUT QUEUES ERROR—RC=—rc— — —OUTPUT MAY BE LOST OR DUPLICATED————▶▶

In the message text:

rc rc identified the type of queue error detected. Reason codes X'80' to X'FF' are errors encountered in the output queue.

An error was found in the structure of the JES2 output queues.

System action: JES2 rebuilds the output queues to correct the error; however, some output might be lost or duplicated in the process.

Operator response: None.

Module: HASPJOS

Routing Code: 1,2,10

Descriptor Code: 4

\$HASP485

Explanation:

▶▶—jobid—OUTPUT QUEUES ERROR—RC=—rc— — —OUTPUT MAY BE LOST OR DUPLICATED————▶▶

In the message text:

jobid The jobID of the job whose output is lost or duplicated.

rc rc identified the type of queue error detected. Reason codes X'80' to X'FF' are errors encountered in the output queue.

An error has been found in the structure of the output queue for the specified job.

System action: JES2 rebuilds the output queue elements for the specified job, but some output might be lost or duplicated in the process. JES2 puts the job in hold state.

Operator response: None.

Module:

HASPJOS

Routing Code: 1,2,10

Descriptor Code: 4

\$HASP486

Explanation:

▶▶—JES2 CKPT—n—DATA SET — —DAMAGED RECORD DETECTED—dsname—ON—volser
(—strname—)————▶▶

JES2 initialization processing found that the previous update made to the specified checkpoint data set (CKPT1 or CKPT2) did not complete successfully. The checkpoint data set is assumed to be incorrect.

In the message text:

dsname

The data set name.

volser The volume serial number of the volume on which the data set resides.

strname

The name of the coupling facility structure.

n The number of the checkpoint data set (either 1 or 2).

System action: JES2 issues message \$HASP441 asking the operator if initialization should continue.

Operator response: Notify the system programmer and respond to message \$HASP441.

- If this is an all-member warm start and you reply Y to message \$HASP441, JES2 initialization continues. If the warm start routines detect any incorrect job queue data, JES2 will issue message \$HASP483.
- If this is a single-system warm start and you reply Y to message \$HASP441, JES2 initialization continues with the damaged checkpoint data set. Job queue data verification is bypassed.

Note:

1. If this is a single-system warm start, it is recommended that you reply N and perform an all-member warm start to verify the job queue data.
 2. In a multi-access spool (MAS) environment, a member joining the MAS that detects the checkpoint damage during initialization can be terminated (by replying "N" to \$HASP441). The checkpoint reconfiguration dialog can then be initiated on one of the active members in order to replace the damaged data set without requiring an all-member warm start.
- If you reply N, JES2 ends.

System programmer response: If JES2 detects incorrect job queue data and issues the \$HASP483 message, determine whether JES2 should rebuild the job queues and advise the operator of what reply to give to message \$HASP483.

Module: HASPIRDA

Routing Code: 1,2,10

Descriptor Code: 2,7

\$HASP487

Explanation:



While other systems were running in the multi-access spool configuration, the CKPTn or RECONFIG initialization option was specified either on a cold start or on a warm start of a single system. These options are not allowed when you are performing a single system start and other systems are running.

In the message text:

n The number of the checkpoint data set. The number is either 1 or 2.

System action: JES2 processing ends.

Operator response: Either restart JES2 without the CKPTn or RECONFIG initialization option or stop JES2 on all other systems in the multi-access spool configuration and perform an all-member warm start.

Module: HASPIRDA

Routing Code: 1,2,10

Descriptor Code: 4

\$HASP488 • \$HASP490

\$HASP488

Explanation:

▶▶—WAITING FOR CHECKPOINT DATA SET LOCK—▶▶

JES2 initialization processing has determined (by examining the checkpoint data set lock record) that another system has control of the checkpoint data set lock and has not relinquished that control.

Note: This can also occur in a single-system configuration if the checkpoint data set lock was not reset.

System action: JES2 initialization processing cannot continue until it has exclusive control of the checkpoint data set lock. Initialization processing attempts to obtain the checkpoint data set lock once each second for the next 30 seconds. If JES2 cannot obtain the lock, message \$HASP479 is issued. If JES2 can obtain the lock, initialization processing continues.

Operator response: None.

Module: HASPIRDA

Routing Code: 1,2,10

Descriptor Code: 4

\$HASP489

Explanation:

▶▶—INITIALIZATION MAY NOT HAVE—RELEASED CKPT DATA SET LOCK—▶▶

JES2 initialization processing has abnormally ended without releasing the checkpoint data set lock on the first track of the checkpoint data set.

System action: Other systems in the multi-access spool configuration issue message \$HASP264 when they detect the above condition. Other systems going through initialization processing issue message \$HASP479 when they detect the above condition.

Operator response: See the descriptions of messages \$HASP264 and \$HASP479.

System programmer response: Determine why the checkpoint data set lock was not released.

Module: HASPIRA

Routing Code: 1,2,10

Descriptor Code: 4

\$HASP490

Explanation:

▶▶—HOT START DENIED – RE-IPL REQUIRED—▶▶

You cannot attempt a hot start because one of the following has occurred:

- JES2 has incurred a \$K03 or \$K15 catastrophic error.
- An abend occurred while JES2 was ending and normal cleanup could not be completed.
- The system you attempted to hot start was restarted by another member of the MAS configuration that issued a \$E MEMBER command for that failed member.

System action: JES2 processing ends.

Operator response: Re-IPL the system and perform a warm start of JES2.

Module: HASPIRA, HASPIRMA

Routing Code: 1,2,10

Descriptor Code: 4

\$HASP491

Explanation:

▶▶—MEMBER BEING RESTARTED—ON—*memname*—————▶▶

The operator is attempting to perform a warm start for JES2 on this member. The attempt fails because the member indicated by *memname* has already issued a \$E MEMBER command to restart JES2 on this member. In the message text:

memname

The member name.

System action: JES2 initialization ends.

Operator response: Re-IPL the member and perform a warm start for JES2.

Module: HASPIRDA

Routing Code: 2,10

Descriptor Code: 4

\$HASP492

Explanation:

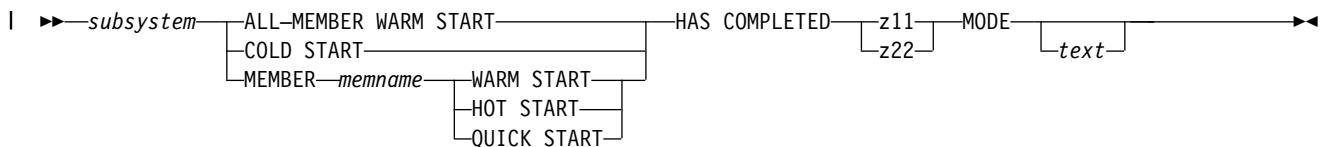

OR



JES2 has completed processing for the member names specified in the message. This message indicates one of the following three conditions:

1. Initialization has completed for the member indicated by *memname*. The type of JES2 initialization—WARM START, HOT START or QUICK START—is indicated.
2. Initialization has completed for all members in the MAS configuration. The type of JES2 initialization—ALL-MEMBER WARM START, or COLD START—is indicated.
3. A RESTART was performed by an active MAS member for the member *memname*, which was previously terminated. The restart was achieved by either a \$E MEMBER command or an AUTOEMEM setting (an active MAS member has the setting AUTOEMEM=ON on its MASDEF initialization statement). The message **HAS COMPLETED** indicates that the RESTART completed successfully. The message **HAS FAILED** indicates that the RESTART did not complete successfully. To recover any work that is still assigned to the failed member, you must restart the failed member by either issuing the \$E MEMBER command or completing a WARM START.

In the message text:

subsystem

The name of the address space as specified on the MVS START command.

memname

The name of this member of the MAS configuration as defined by OWNMEMB on the MASDEF initialization statement.

\$HASP493

| z11 | z22 MODE

The checkpoint mode (\$ACTIVATE LEVEL) that JES2 is starting in.

text is one of the following:

SPOOL VALIDATION WAS DONE DUE TO INITIALIZATION OPTION

Spool validation was completed.

SPOOL VALIDATION WAS BYPASSED DUE TO MISSING SPOOL VOLUMES

One or more spool volumes required to do track group map validation are offline. The track group map was not validated or rebuilt.

SPOOL VALIDATION WAS DONE DUE TO JOB QUEUE ERROR

An error was found in the job queues. The track group map was validated and rebuilt even if SPOOL=NOVALIDATE was specified.

SPOOL VALIDATION WAS DONE DUE TO PRIOR INTERRUPTED VALIDATION

A previous all-member warm start was interrupted in the middle of validating or rebuilding the track group map. The validation must be completed before JES2 can initialize, even if SPOOL=NOVALIDATE was specified.

SPOOL VALIDATION WAS BYPASSED DUE TO BERT SHORTAGE

The track group map could not be rebuilt because not all jobs could be processed. The jobs that were not processed required more BERTs than were available.

System action: JES2 processing continues.

Operator response: For a **RESTART HAS FAILED** message, contact the system programmer.

System programmer response: For a **RESTART HAS FAILED** message, recover any work assigned to the failed member by either issuing a \$E MEMBER command for the failed member, or completing a WARM START for the failed member.

Module: HASPWARM

Routing Code: 1,2,10

Descriptor Code: 4

\$HASP493

Explanation:

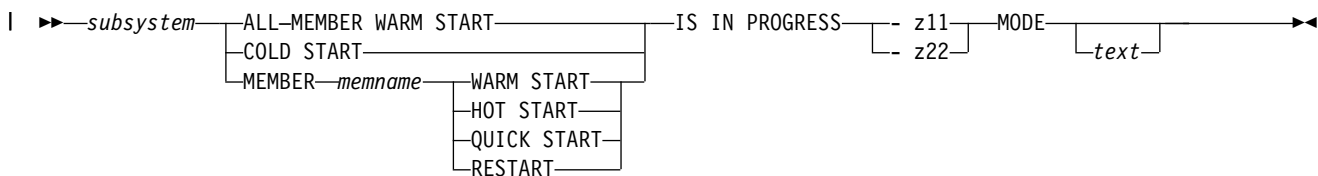

The indicated subsystem (JES2, for example) is being initialized. The message text indicates:

- Whether the initialization is for all members in the MAS configuration or only for the member indicated by *memname*.
- The type of JES2 initialization being performed: a cold start; a warm, hot, or quick start; or a restart resulting from a \$E MEMBER command.
- The checkpoint mode (\$ACTIVATE LEVEL) that JES2 is starting in.
- For an all-member warm start, SPOOL=VALIDATE was included on the start JES2 command and JES2 validates the track group map.

When initialization completes, JES2 deletes this message from the console.

In the message text:

subsystem

The name of the address space as specified on the MVS START command.

memname

The name of this member of the MAS configuration as defined by OWNMEMB on the MASDEF initialization statement.

text SPOOL VALIDATION WILL BE DONE (when SPOOL=VALIDATE was specified).

System action: Processing continues.

Operator response: None.

Module: HASPWARM, HASPIRDA

Routing Code: 2,10

Descriptor Code: 2,7

\$HASP494

Explanation:

▶▶—HOT START DENIED— — INVALID MEMBER ID—▶▶

An attempt was made to perform a hot start on a member of a MAS configuration, but the OWNMEMB parameter on the MASDEF initialization statement specified a member name different from the name in use when the member was last active.

System action: JES2 processing ends.

Operator response: Notify the system programmer.

System programmer response: Correct the member name specified on the OWNMEMB parameter on the MASDEF initialization statement and then have the operator restart JES2.

Module: HASPIRDA

Routing Code: 1,2,10

Descriptor Code: 4

\$HASP495

Explanation:

▶▶—PP BUFFER SIZE EXCEEDS 4096—▶▶

When used to calculate the size of the print/punch (PP) buffer, the size of the job output element (JOE) caused the PP buffer to exceed the maximum allowable (4096) bytes.

System action: JES2 processing ends.

Operator response: Notify the system programmer.

System programmer response: Ensure that the buffer size does not exceed 4096 bytes.

Module: HASPIRMA

Routing Code: 1,2,10

Descriptor Code: 4

\$HASP496

Explanation:

▶▶—*statement keyword=xxxxxxx, reason*—▶▶

JES2 determined that an initialization statement specification conflicted with the value saved in the JES2 checkpoint. This message follows \$HASP442, indicating the incorrect initialization parameter, the value specified on the

\$HASP497

initialization statement and the value saved in the checkpoint.

In the message text:

statement keyword

The name of the initialization statement parameter.

xxxxxxx

The value of the parameter that is specified on the initialization statement.

reason The reason for the conflict can be one of the following texts:

- SAVED VALUE OF *yyyyyyyy* WILL BE USED
- CANNOT BE CHANGED FROM SAVED VALUE OF *yyyyyyyy*
- CANNOT BE CHANGED FROM SAVED VALUE OF *yyyyyyyy* AND MUST BE CORRECTED TO START JES2
- SAVED VALUE OF *yyyyyyyy* EXCEEDS THE MAXIMUM VALUE OF *maxval* SUPPORTED BY THIS RELEASE

In the reason text:

yyyyyyyy

The value of the parameter that is saved in the JES2 checkpoint.

maxval The maximum value of the specified keyword that is supported by this release.

System action: If the message text states SAVED VALUE OF *yyyyyyyy* WILL BE USED, the probable cause is an operator command that was issued to update the parameter, but the initialization statement was not updated. JES2 initialization will continue normally (using the saved value of the parameter).

If the message text states CANNOT BE CHANGED FROM SAVED VALUE OF *yyyyyyyy*, a conflict exists for a statement that cannot be updated on this type of start. This might indicate that an incorrect initialization deck was used to start JES2. If the correct initialization deck was used, an incorrect start was used to update the parameter. See *z/OS JES2 Initialization and Tuning Reference* for the correct procedures to update the parameter. If any \$HASP496 messages have this format, JES2 will issue the \$HASP441 message to determine if JES2 initialization should continue with the saved value.

If the message text states CANNOT BE CHANGED FROM SAVED VALUE OF *yyyyyyyy* AND MUST BE CORRECTED TO START JES2, a conflict exists for a statement that cannot be changed on this type of start. You must correct the initialization statement or do a cold start to change the parameter. This message will be followed by message \$HASP428.

If the message text states SAVED VALUE OF *yyyyyyyy* EXCEEDS THE MAXIMUM VALUE OF *maxval* SUPPORTED BY THIS RELEASE, JES2 WARM start processing is terminated because the value of the specified keyword in the checkpoint exceeds the maximum value that is supported by the release, which is trying to warm start. This happens when a lower level JES2 is warm started with a higher limit, which a higher release or higher maintenance level of JES2 supports. The value of the keyword must be decreased on the higher level of JES2 before a lower level JES2 warm starts.

Operator response: See message \$HASP422.

System programmer response: See message \$HASP422.

Module: HASPWARM, HASPIRDA

Routing Code: 1,2,10

Descriptor Code: 4

\$HASP497

Explanation:

►►—OUTPUT QUEUES—┌—ERROR CORRECTION IN PROGRESS, RC=—rc—┐
└—REBUILD IN PROGRESS—┘

In the message text:

rc *rc* identified the type of queue error detected. Reason codes X'80' to X'FF' are errors encountered in the output queue.

JES2 found an error in the output queues during verification. If **ERROR CORRECTION** is displayed, JES2 is attempting to correct the error. If **REBUILD** is displayed, uncorrectable errors were found and JES2 is now in the process of totally rebuilding the output queues (because the operator explicitly requested it). See message \$HASP498.

When processing is complete, JES2 deletes this message from the console.

System action: JES2 processing continues.

Operator response: None.

Module: HASPJOS

Routing Code: 2,10

Descriptor Code: 2,7

\$HASP498

Explanation:

▶▶—OUTPUT QUEUES ERROR,—RC=—*rc*— — REPLY Y TO REBUILD OR N TO TERMINATE JES2————▶▶

In the message text:

rc *rc* identified the type of queue error detected. Reason codes X'80' to X'FF' are errors encountered in the output queue.

JES2 found an error in the output job queues during verification. JES2 attempted to correct the error, but that recovery process failed because of either an abend or a JES2 catastrophic error. If the operator requests, JES2 will attempt to recover from the error by totally rebuilding the JOT.

System action: JES2 waits for the operator to reply.

Operator response: Notify the system programmer of the error and respond to this message.

If JES2 should rebuild the output queues, reply Y to this message. The FIFO queuing structure will be lost in the rebuild process. Some output may also be lost.

If JES2 should not rebuild the output queues, reply N to this message. JES2 issues the \$HASP428 message and then ends.

System programmer response: Use the indicative dump and the SVC dump (if any) to diagnose and correct the error.

Module: HASPJOS

Routing Code: 1,2,10

Descriptor Code: 4

\$HASP499

Explanation:

▶▶—NON-CORRECTABLE JOB OUTPUT—QUEUES ERROR FOUND,—RC=—*rc*————▶▶

In the message text:

rc *rc* identified the type of queue error detected. Reason codes X'80' to X'FF' are errors encountered in the output queue.

JES2 found an error in the output queues during verification. JES2 attempted to recover, but both error correction and a rebuild of the output queues failed.

System action: JES2 issues the \$HASP428 message and then ends. Some output may have been lost in the attempted recovery process.

Operator response: Notify the system programmer.

System programmer response: Use the indicative dump and the SVC dump (if any) to diagnose and correct the error. This error will require a JES2 cold start because JES2 cannot rebuild the output queues because of either an abend or a JES2 catastrophic error.

Module: HASPJOS

Routing Code: 1,2,10

Descriptor Code: 4

Chapter 9. Five-hundreds

The following JES2 messages are numbered in the 500-599 range.

\$HASP500

Explanation:

▶▶—CONNECTION CONTROL RECEIVE ON—*lna* - —*text*————▶▶

JES2 received an NJE signon connection control record over the line *lna* and the connection failed. For active lines, the first \$HASP500 message is highlighted. All subsequent \$HASP500 messages are logged, but will not remain on the screen.

During initialization, the first \$HASP500 message is always highlighted.

In the message text:

lna The line number.

The variable text and reason code indicate the type of error that occurred.

text is one of the following:

NJE DEVICES UNAVAILABLE, RC=01

Explanation: No NJE function device control tables were available to perform data-stream transmission over the connection.

System action: JES2 rejects the signon and continues processing.

Operator response: Notify the system programmer.

System programmer response: Increase the value of the LINENUM parameter on the NJEDEF initialization statement; this requires a JES2 warm start.

Module: HASPNPM

Routing Code: 1,2,8,10

Descriptor Code: 4

INVALID LINE PASSWORD, RC=02

Explanation: The line password was not valid.

System action: JES2 rejects the signon and continues processing.

Operator response: The operator at the other end will receive I/O errors and may contact you. If the operator contacts you, check with your system programmer to determine whether that operator's node should be authorized to sign on to this node.

System programmer response: If the node requesting signon should be authorized, have your operator either give the correct password for this line to the operator at that node or delete the password for this line using the \$T LINE(nnnn),P= command.

Module: HASPNPM

Routing Code: 1,2,8,10

Descriptor Code: 4

INVALID NODE NAME, RC=03

Explanation: Either the sending system identified itself to be the same node as the receiving node or the name was not recognized as a valid node name. This message may also appear if an NJE notification connection control record is received and the node names are not recognized.

In the message text:

nodename

The name of the node.

System action: JES2 rejects the signon and continues processing.

Operator response: Notify the system programmer.

System programmer response: If the name displayed should be valid, check the JES2 NODE(nnnn) initialization statements to ensure the names are properly specified.

Module: HASPNPM

Routing Code: 1,2,8,10

Descriptor Code: 4

INVALID NODE PASSWORD, RC=04

Explanation: The node password was incorrect.

System action: JES2 rejects the signon and continues processing.

Operator response: The operator at the other end will receive I/O errors and may contact you. If the operator contacts you, check with the system programmer to determine whether that operator's node should be authorized to sign on to this node.

System programmer response: If the node requesting signon should be authorized, have your operator either give the correct node password to the operator at that node or delete the password for this node using the \$T NODE,P=(VERIFY=password,SEND=password) command.

Module: HASPNPM

Routing Code: 1,2,8,10

Descriptor Code: 4

INVALID CONNECTION RESISTANCE, RC=05

Explanation: The resistance value supplied by the transmitting subsystem, when added to the receiving subsystem resistance value, exceeded the maximum allowable value. The probable cause for this error is that the JES2 subsystems at one or both ends of the connection have many modifications.

System action: JES2 rejects the signon and continues processing.

Operator response: Notify the system programmer.

System programmer response: Check user modifications to ensure the maximum resistance values are not exceeded.

Module: HASPNPM

Routing Code: 1,2,8,10

Descriptor Code: 4

INVALID CONTROL SEQUENCE, RC=06

Explanation: The resistance value supplied by the transmitting subsystem, when added to the receiving subsystem resistance value, exceeded the maximum allowable value. The probable cause for this error is that the JES2 subsystems at one or both ends of the connection have many modifications.

System action: The proper connection protocol was not followed.

Operator response: Notify the system programmer.

System programmer response: Check for consistent connection definitions.

Module: HASPNPM

Routing Code: 1,2,8,10

Descriptor Code: 4

CONNECTION INCLUDES LOCAL NODE AND MEMBER, RC=07

Explanation: JES2 received a connection record that defines an already active connection for a member on the local node.

System action: JES2 rejects the connection record and continues processing.

System programmer response: Examine trace identifier 24 to determine the source of the record and if the connection as defined at the source node needs to be corrected.

Module: HASPNPM

Routing Code: 1,2,8,10

Descriptor Code: 4

INVALID NCC RECORD, RC=08

Explanation: The network connection control (NCC) record contained an incorrect length. The length field contains either a zero value or a length value that extends the current record beyond the end of the data buffer. This message may indicate hardware I/O errors or that an incorrect record was built by another node or MAS member.

System action: JES2 purges the data buffer and schedules the line for signoff.

Operator response: Reestablish the connection with the proper \$S N command. (See *z/OS JES2 Commands*). If the problem continues, notify the system programmer.

System programmer response: Examine incoming data buffers on this line to determine if the session partner is violating SNA protocols.

Module: HASPNPM

Routing Code: 1,2,8,10

Descriptor Code: 4

LINE NOT TRANSPARENT, RC=09

Explanation: The line did not have the text-transparency capability. LINE(nnnn) initialization statements define capabilities for lines.

System action: JES2 rejects the signon and continues processing.

Operator response: Notify the system programmer.

System programmer response: Check line capabilities and, if they are incorrect, correct the specifications on the LINE(nnnn) initialization statement(s). Install text transparency or use alternate lines for NJE communications.

Module: HASPNPM

Routing Code: 1,2,8,10

Descriptor Code: 4

NECESSARY STORAGE NOT AVAILABLE, RC=10

Explanation: An insufficient amount of storage was available for the connection.

System action: JES2 rejects the signon and continues processing.

Operator response: Notify the system programmer.

System programmer response: Determine why storage is not available. When storage is available, notify the other system that it needs to reconnect.

Module: HASPNPM

Routing Code: 1,2,8,10

Descriptor Code: 4

CES EXCEEDS TOLERANCE, RC=11

Explanation: A node attempted to sign on to a line connected to this system but the value of their connection event sequence (CES) is greater than the sum of the TOD clock plus the value of TIMETOL specified on the NJEDEF initialization statement.

System action: JES2 rejects the signon attempt.

Operator response: Either increase the value of the NJEDEF TIMETOL parameter or correct the time on one of the two systems involved.

Note: To correct the time, re-IPL the system. Do not use the MVS SET command to set the time.

System programmer response: None.

Module: HASPNPM

Routing Code: 1,2,8,10

Descriptor Code: 4

INVALID MEMBER(S), – nodename (member#), RC=12

Explanation: JES2 received a status record on line *lna* for a connection between 2 nodes where either the primary or secondary member number is not valid.

In the message text:

nodename

The name of the node of the invalid member number.

member #

The member number specified in the record.

System action: JES2 rejects the record.

Operator response: Notify the system programmer.

System programmer response: Examine trace identifier 24 to identify the source of the record in error and isolate the member transmitting the erroneous records.

The member must equal 1 for JES2 nodes at JES2 Version 5 and OS/390.

Module: HASPNPM

Routing Code: 1,2,8,10

Descriptor Code: 4

FUTURE CES BETWEEN *nodea* AND *nodeb*, RC=13

Explanation: JES2 received a connection record with a CES value that exceeds the value specified on the TIMETOL parameter of the NJEDEF initialization statement.

In the message text:

nodea AND *nodeb*

The nodes represented on the connection record.

System action: JES2 rejects the connection record.

System programmer response: Examine trace identifier 24, which contains the rejected record for the nodes and members involved.

Module: HASPNPM

Routing Code: 1,2,8,10

Descriptor Code: 4

UNSUPPORTED SIGNON FEATURES, RC=14

Explanation: A node attempted to signon to this node, requesting a feature not supported by line *vvvvvvvv*.

System action: JES2 rejects the connection record.

System programmer response: Examine trace identifier 21 to determine the identity of the node attempting to signon and ensure the features requested by that node are correct.

Module: HASPNPM

Routing Code: 1,2,8,10

Descriptor Code: 4

nodename **INCORRECT VALUE FOR PATHMGR, RC=15**

Explanation: JES2 detected a node that either:

- Attempted to sign on as a JES2 node but was defined with PATHMGR=NO
- Attempted to sign on as a non-JES2 node but was defined with PATHMGR=YES.

Note: This error might occur if you are trying to connect a JES2 node that contains a CONNECT statement with a JES2 node that contains PATHMGR=YES. In JES2 versions before 4.1.0, specifying a CONNECT statement was equivalent to defining the node as PATHMGR=NO. This would cause the node to sign on as a non-JES2 node. In the message text:

nodename

The name of the node that attempted to sign on.

System action: JES2 rejects the connection record.

Operator response: Notify the system programmer.

System programmer response: Do the following:

- If the definition of the node is incorrect:
 1. Use the \$T NODE(*nnnn*) command to correct the definition of the node so that the value of the PATHMGR parameter agrees with the software in use on the node.
 2. Update the NODE(*nnnn*) initialization statement for the node with the correction.
- If the definition of the node is correct:
 1. Use the Environmental Recording, Editing and Printing Program (EREP) to format the logrec data set.
 2. Locate the symptom record for this time period with the description **NCC RECORD REJECTED**.
 3. Contact the IBM Support Center for assistance.
- Check the CONNECT statements on both nodes. If one of the nodes contains a CONNECT statement and the other node has PATHMGR=YES, check the version of the nodes involved. See *z/OS JES2 Initialization and Tuning Reference* for more information about conditions when using the CONNECT statement.

Module: HASPNPM

Routing Code: 1,2,8,10

Descriptor Code: 4

NON PATH MANAGER CES, RC=16

Explanation: JES2 received a network connection control (NCC) record that indicates that the record is for a non-path manager node connection.

System action: JES2 rejects the connection record.

Operator response: Notify the system programmer.

System programmer response: Do the following:

1. Use the Environmental Recording, Editing and Printing Program (EREP) to format the logrec data set.
2. Locate the symptom record for this time period with the description **NCC RECORD REJECTED**.
3. Contact the IBM Support Center for assistance.

Module: HASPNPM

Routing Code: 1,2,8,10

Descriptor Code: 4

DUPLICATE NODE AND MEMBER – *nodename*, (*member#*) RC=17

Explanation: JES2 received a status record on line *lna* for a connection between two nodes where the primary node and member are the same as the secondary node and member.

nodename

The name of the node specified in the record.

member#

The member number specified in the record.

System action: JES2 rejects the record.

Operator response: Notify the system programmer.

System programmer response: Examine trace identifier 24 to identify the source of the record in error and isolate the member transmitting the erroneous records.

Module: HASPNPM

Routing Code: 1,2,8,10

Descriptor Code: 4

INCORRECT MULTI-TRUNK PROTOCOL, RC=18

Explanation: During NJE signon processing, JES2 determines that the two nodes do not agree that this is the first line to connect the two nodes. Either the issuing node has either:

- Multiple lines to the other node, but the network connection control (NCC) record indicates this is the first line, or
- No other line to the other node, but the NCC record indicates that this is not the first line.

System action: JES2 signs off all lines on this member connecting the two nodes.

Operator response: Attempt to restart networking to the other node. If the problem reoccurs, drain all lines on all members of both nodes that connect the two nodes. When the lines have drained, restart the lines and restart the NJE sessions.

System programmer response: Examine trace identifiers 21 and 24 to determine the cause of the error. Determine which node has the incorrect number of active lines and correct the problem.

Module: HASPNPM

Routing Code: 1,2,8,10

Descriptor Code: 4

CES RECEIVED DURING SIGNON IS LESS THAN PREVIOUS SIGNON, RC=19

Explanation: JES2 received a network connection control (NCC) record on line *lna* which has a connection event sequence (CES) value that is less than a CES value previously associated with this connection.

System action: JES2 fails the signon attempt.

Operator response: Verify that the time-of-day clock on each node is set correctly. Attempt to restart the NJE session at some later time.

System programmer response: This problem can be caused if a node was IPLed with a time-of-day clock value that is less than that used when the system was brought down. If this is the case, NJE cannot be restarted until the time-of-day clock has reached the CES last associated with the connection. Use the \$D CONNECT command to display the CES associated with a connection.

Module: HASPNPM

Routing Code: 1,2,8,10

Descriptor Code: 4

DUPLICATE CES BETWEEN *nodea(memba)* and *nodeb(membb)*, RC=20

Explanation: JES2 received a network connection control (NCC) record on line *lna*. This record has the same connection event sequence (CES) value as the current known status of the connection, but a different resistance value.

nodea and *nodeb*

The nodes represented in the connection record.

memba and *membb*

The members represented in the connection record.

System action: JES2 rejects the record.

System programmer response: This message is most likely indicative of a problem which occurred at node *nodea* or *nodeb*, rather than at this node, which is just detecting the error. At *nodea* and *nodeb*, examine the trace id 21-24 to determine the origin of conflicting NCC records. If possible, restart all connections between *nodea(memba)* and *nodeb(membb)* to establish a new CES for the connection.

Module: HASPNPM

Routing Code: 1,2,8,10

Descriptor Code: 4

SECURE SIGNON FAILURE, RC=21

Explanation: JES2 received a signon network connection control record on line *lna*. The encrypted string in the signon record does not match the expected value. This is either because the encryption key specified on the other end of the connection does not match the encryption key on this end of the connection, or the other end of the connection is not using a secure signon protocol.

System action: JES2 rejects the signon record.

Operator response: Verify that the encryption key specified in the APPCLU profile for this node and the adjacent node are correct.

System programmer response: This problem can be caused if a node was IPLed with a time-of-day clock value that is less than that used when the system was brought down. If this is the case, NJE cannot be restarted until the time-of-day clock has reached the CES last associated with the connection. Use the \$D CONNECT command to display the CES associated with a connection.

Module: HASPNPM

Routing Code: 1,2,8,10

Descriptor Code: 4

\$HASP501 • \$HASP502

\$HASP501

Explanation:

▶▶—NJE SIGNONS DELAYED, RESPONSES NOT—RECEIVED FROM MEMBER—*member-name*—————▶▶

JES2 is unable to complete an NJE signon because information was requested from another member of the MAS, and that member has not yet responded to the request.

In the message text:

member-name

The name of the member that has not responded

System action: JES2 waits for a response. When a response is received, JES2 deletes the message and the NJE signon proceeds.

Operator response: Review the SYSLOG for JESXCF IXZ0108E messages that might indicate a JESXCF problem. Take the appropriate action as described in the IXZ0108E message. If the delay continues for an extended period of time, contact your system programmer.

System programmer response: If this message remains for an extended period of time, it is likely that a request or response has been lost, possibly indicating that the member *member-name* is experiencing problems or JESXCF is experiencing a problem delivering the messages.

You may be able to complete the signon by either:

- Restarting any lines that are hung in signon and attempting to sign them on again, or
- Restarting member *member-name*

For additional information on dumping JES and JESXCF address spaces and restarting the JESXCF address space, see *z/OS MVS Programming: JES Common Coupling Services*.

Module: HASPNPM

Routing Code: 1,2,10

Descriptor Code: 2,7

\$HASP502

Explanation:

▶▶—NETWORK PATH MANAGER FUNCTIONS—SUSPENDED—————▶▶

A severe error occurred in the network path manager. JES2 attempted recovery of the path manager, but the attempt failed.

System action: JES2 suspends network job entry (NJE) functions but continues with other processing. If this JES2 member is part of a multi-access spool (MAS), the members in the MAS will also consider this member down from an NJE standpoint until the failing MAS is restarted.

Operator response: Notify the system programmer.

System programmer response: Analyze the dumps JES2 wrote and locate the cause of the problem. See *z/OS JES2 Diagnosis* for assistance in analyzing the dumps. If the error is in JES2 code, contact the IBM Support Center. When possible, restart JES2 to recover the lost networking functions.

Module: HASPNPM

Routing Code: 1,2,10

Descriptor Code: 4

\$HASP503

Explanation:

▶▶—ERROR PROCESSING NCC RECORD—RECEIVED ON LINE—*lna*—(—*nodename*—)————▶▶

VALID RESPONSES ARE:

- 'RESTART' - DISCONNECT AND RESTART LINE *lna*
- 'DISC' - DISCONNECT LINE *lna*
- 'CONT' - DO NOT DISCONNECT LINE *lna*

A failure occurred while the path manager was processing an NCC record received on LINE *lna* from node *nodename*.

In the message text:

lna The number of the line.

nodename
 The name of the node.

System action: JES2 issues message \$HASP272 prompting the operator or system programmer enters a valid response to message \$HASP503. If the operator or system programmer enters a response other than one listed in the message text, JES2 issues message \$HASP299 until a correct response is entered.

Operator response: Contact the system programmer.

System programmer response: If the failures are infrequent, it is possible to continue without disconnecting and restarting the line. However, this could prevent the path manager from having a complete picture of the network. Enter a \$D CONNECT command to obtain a current view of the network.

If the line encounters frequent errors, you should disconnect and restart the line or disconnect the line until you can resolve any other problems with the line.

Module: HASPNPM

Routing Code: 1,2,10

Descriptor Code: 2,7

\$HASP504

Explanation:

▶▶—NETWORK PATH MANAGER IS—BEING REINITIALIZED————▶▶

VALID RESPONSES ARE:

- 'RESTART' - DISCONNECT AND RESTART ALL ACTIVE NJE LINES
- 'DISC' - DISCONNECT ALL ACTIVE NJE LINES
- 'CONT' - DO NOT DISCONNECT ACTIVE NJE LINES

The network path manager has failed. A recovery attempt, which included rebuilding the path manager control blocks, received errors too serious to continue. This message requests the operator to reinitialize all network job entry (NJE) resources in an attempt to restart networking functions.

System action: JES2 issues message \$HASP272 prompting the operator or system programmer to enter a valid response to \$HASP503. If the operator or system programmer enters a response other than one listed in the message text, JES2 issues message \$HASP299 until a correct response is entered.

Operator response: Contact the system programmer.

System programmer response: If the failures are infrequent, disconnecting and restarting the nodes may be adequate recovery. However, frequent failures require that you restart the nodes manually with additional debugging aids, for example, traces, in place.

\$HASP506 • \$HASP507

Module: HASPNPM

Routing Code: 1,2,10

Descriptor Code: 2,7

\$HASP506

Explanation:

►►—UPDATING LOCAL NODE NAME—'—xxxxxxx—'—TO—'—yyyyyyyy—'—IS NOT ALLOWED—*reason*—►►

An attempt was made to modify the local node name from *xxxxxxx* to *yyyyyyyy*, on a JES2 restart. The modification is not allowed for one of the following reasons:

ALL MEMBERS ARE NOT AT THE REQUIRED CHECKPOINT LEVEL

A down-level member which does not allow the change is part of the current MAS.

NODE INFORMATION IS NOT IN THE CHECKPOINT

Node information does not exist in the checkpoint because of insufficient space. The message is preceded by the \$HASP562 message.

System action: JES2 initialization will be terminated.

Operator response: Verify that the correct initialization parameters are being used and restart JES2.

System programmer response: If the reason given is that all of the MAS members are not at the required level, you can change the node name through an all-member warm start, or by removing the down-level members from the MAS.

If the reason given is that the node information is not in the checkpoint, increase the size of the checkpoint as indicated by the \$HASP296 or \$HASP542 messages.

Module: HASPIRRE

Routing Code: 1,2,10

Descriptor Code: 4

\$HASP507

Explanation:

►►—COULD NOT CREATE DESTID—FOR NODE—'—Nnnnn—'—►►

JES2 initialization encountered an error attempting to create a DESTID for node *nnnn* because DESTDEF NDEST=USER and the node name defaulted to *Nnnnn*. The problem may be caused by a GETMAIN failure or an internal error in JES2 processing.

System action: JES2 ends

Operator response: Contact the systems programmer and restart JES2.

System programmer response: If the problem is caused by a GETMAIN failure, increase the size of ECSA. If you suspect storage is not the problem, assign a nodename to node *nnnn* by coding a NODE(*nnnn*) statement with the NAME= operand.

Programmer response: None.

Module: HASPIRRE

Routing Code: 1,2,10

Descriptor Code: 4

\$HASP508

Explanation:

▶▶—CONNECTION MADE BETWEEN—node—*n*—AND—node—*m*—ON LINE—*linenum*—USING A RESISTANCE—(*rest*)—▶▶
 ▶▶—GREATER THAN RESTMAX—(*max*)—▶▶

JES2 has successfully signed on to another node but the resistance of the connection is greater than the current value of NJEDEF RESTMAX=.

In the message text:

node Name of one of the nodes in the connection.

m Member number corresponding to node.

linenum Line over which the signon occurred.

rest Resistance of connection.

max Current value of NJEDEF RESTMAX.

System action: Signon is allowed to complete. Data can be received over the line but no data is sent.

Operator response: Contact the system programmer.

System programmer response: Either restart the line with a lower resistance or increase the value of NJEDEF RESTMAX=.

Module: HASPNPM

Routing Code: 1,2,10

Descriptor Code: 4

\$HASP509

Explanation:

▶▶—RMTnnnn—CONDEST VALUE HIGHER THAN—HIGHEST REMOTE NUMBER—DEFINED—▶▶

A BSC/SNA remote statement specified a CONDEST value higher than the highest number defined for an RJE workstation.

The highest number defined for an RJE workstation at an installation is determined by the RMTNUM= value on the TPDEF initialization statement. In the message text:

nnnn The number of the remote.

System action: The system issues requests that JES2 be restarted.

Operator response: Correct the CONDEST parameter for this RJE workstation and restart JES2.

Module: HASPIRRE

Routing Code: 1,2,10

Descriptor Code: 4

\$HASP510

Explanation:

▶▶—TPDEF RMTNUM PARAMETER—INCREASED TO—*nnnn*—▶▶

JES2 displays this message after initialization when the RMTNUM= parameter on the TPDEF initialization statement has been increased because the number for a defined RJE workstation is greater than this parameter value. In the message text:

\$HASP512 • \$HASP513

nnnn The highest number for an RJE workstation defined on this member at initialization.

System action: Processing continues.

Operator response: None.

Module: HASPIRPL

Routing Code: 1,2,10

Descriptor Code: 4

\$HASP512

Explanation:

▶▶—REMOTE DESTINATION TABLE—ERROR NAME=*name*—▶▶

An error was detected while building the remote destination table named in the message text. The error occurred because either:

- A NODE statement or a DESTID statement specified a node number higher than the NODENUM specified on the NJEDEF statement, or
- When defining the destination, an incorrect DEST= parameter was detected, or the symbolic DEST= parameter was used as a DESTID subscript or node name in a subsequent initialization statement.

In the message text:

name The name of the remote destination table.

System action: JES2 deletes the remote destination table (RDT) entry.

Operator response: Notify the system programmer.

System programmer response: Examine the initialization statements to determine which of the errors described above is causing the problem. Then do one of the following:

- Either change the node number on the NODE or DESTID statement, OR increase the NODENUM value on the NJEDEF initialization statement.
- Either change the destination of the NODE or DESTID statement OR change the sequence of DESTID/NODE statements in the initialization stream. The DESTID statement that was flagged as an error should appear AFTER the initialization statement that creates the destination name (that is, the name must be defined before it is used).

If necessary, have the operator restart JES2.

Module: HASPIRRE

Routing Code: 1,2,10

Descriptor Code: 4

\$HASP513

Explanation:

▶▶—*jobid*—*devname*—ERROR OCCURRED WHEN—*text*—▶▶
└—*jobname*—┘

Where *text* is one of the following:

- ACCESSING GROUPING DATA
- FREEING GROUPING DATA
- FREEING SWBTUREQ WORK AREA
- USING SWBTUREQ RETRIEVE SERVICE
- SJFREQ SERVICE SET ERROR CODE
- SWBTUREQ SERVICE SET ERROR CODE

- USING SJFREQ KEYLIST SERVICE
- USING INSTALLATION EXIT 41

The SYSOUT receiver *devname* abnormally ended.

In the message text:

jobid The job identifier.

jobname
The name of the job.

devname
The name of the failed device.

System action: If the error only affects the current job, JES2 purges that job and the SYSOUT receiver continues to process other jobs. If the error affects all work for *devname*, JES2 issues message \$HASP514 and ends the SYSOUT receiver.

Operator response: Dump JES2 and notify the system programmer of the error.

System programmer response: Examine dump to determine the cause of the error. If unable to find the cause, contact the IBM Support Center.

Module: HASPNSR

Routing Code: 10

Descriptor Code: 4

\$HASP515

Explanation:

▶▶—*jobid—jobname—HAS DIFFERENT JDVT NAMES—(name1 name2)—*—————▶▶

SYSOUT received from a node contains a data set or copy of a data set that contains two different JCL definition vector table names (JDVT).

In the message text:

jobid The job identifier.

jobname
The name of the job.

name1 and name2
The JDVT names involved. The message indicates the default JDVT with '****'.

System action: JES2 issues message \$HASP543 and rejects the incoming job. The sending node places the output into hold.

Operator response: Notify the system programmer.

System programmer response: The system programmer at the sending node should ensure that only one JDVT name is in use.

Module: HASPNSR

Routing Code: 8,10

Descriptor Code: 4

\$HASP516

Explanation:

▶▶—ERROR OBTAINING JCL—GROUPING KEYWORDS— — *text* —————▶▶

\$HASP517 • \$HASP518

Where *text* is one of the following:

- STORAGE IN EPVT IS NOT AVAILABLE
- STORAGE IN ECSA IS NOT AVAILABLE
- UNDEFINED JCL DEFINITION NAME
- CALLER IS NOT INITIALIZATION PCE

JES2 cannot determine which OUTPUT JCL keywords it should use to group SYSOUT.

System action: JES2 initialization ends.

Operator response: Obtain a dump of JES2 and notify the system programmer.

System programmer response: Examine the dump to determine the cause of failure. If unable to locate the cause, contact the IBM Support Center.

Module: HASPIRMA

Routing Code: 1,2,10

Descriptor Code: 4

\$HASP517

Explanation:

▶▶—JOB QUEUE REBUILD HAS COMPLETED—*nnnnn*—

ELEMENT(S) DISCARDED
ELEMENT(S) PENDING DISCARDED

—▶▶

JES2 found an error in the job queues during verification. To recover, JES2 totally rebuilt the job queues. If JES2 moved any damaged JQEs to either the free or rebuild queue, the number *nnnnn* provides the number of JQEs moved. Recovery processing has completed. In the message text:

nnnnn The number of JQEs queued to either the free or rebuild queue.

text is one of the following:

ELEMENT(S) DISCARDED

During an all-member warm start, damaged JQEs were moved to the free queue.

ELEMENT(S) PENDING DISCARD

During a JES2 warm start (quick, hot, single-member) damaged JQEs were moved to the rebuild queue awaiting discard. The rebuild queue temporarily holds jobs (JQEs) that were actively being processed on either this MAS member or another. JES2 returns these JQEs to the free queue at a later time.

System action: JES2 processing continues. Some jobs and their output might have been lost in the recovery process.

Operator response: None.

System programmer response: None.

Module: HASPJOS

Routing Code: 1,2,10

Descriptor Code: 4

\$HASP518

Explanation:

▶▶—ROUTE CODE NUMBER—*n*—ON—*device* —NOT VALID—▶▶

JES2 initialization processing has determined that a route code on the specified device is not valid for that device type. *n* in the message indicates which route code (1-4) is in error. The problem may be caused by:

- A local or remote printer or punch with a route code that resolves to a non-local destination

- A local route code with an incorrect user routing.

System action: The route code in error is deleted from the list of route codes. Initialization continues until all local or all remote devices have been processed, at which point the \$HASP441 message is issued. The operator has the option of terminating JES2 initialization. If initialization is allowed to complete, the route code in error can be corrected through an operator command.

Operator response: Reply as directed by the \$HASP441 message.

System programmer response: Correct the route code specification in the initialization stream for the device specified in the message.

Module: HASPIRMA

Routing Code: 1,2,10

Descriptor Code: 4

\$HASP519

Explanation:

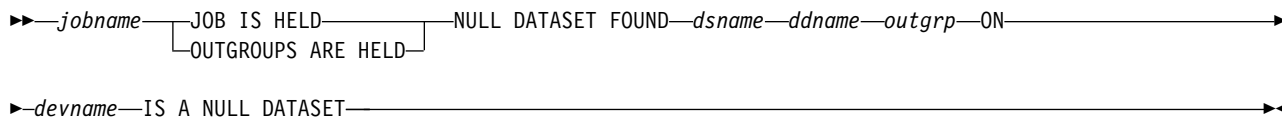

The SYSOUT transmitter has recognized a null data set being transmitted. In the message text:

jobname The name of the job.

dsname The name of the data set.

ddname The ddname of the data set.

outgrp The output group of the data set.

devname
 The name of the device.

Note: A *jobid* might precede message \$HASP519; see "JES2 message format" on page 1.

System action: The SYSOUT transmitter stops transmitting data sets for its current job and issues an RTAM "close" to cause the SYSOUT receiver to delete any output it has already received (that is, purge the received job). The transmitter will hold the job or the JOES it has acquired.

JOB IS HELD appears in the message for **SPOOL OFFLOAD**.

OUTGROUPS ARE HELD appears in the message for SNA NJE, BSC NJE or TCP/IP NJE networks.

Operator response: Determine if the data set is a null data set. Purge the null data set before releasing the job or outgroup for retransmission. If **OUTGROUPS ARE HELD** appears in the message, the held data sets can be displayed using the \$L command and the data set can be made selectable for retransmission using the \$T command.

System programmer response: None.

Module: HASPNST, HASCNJST

Routing Code: 1,2,8,10

Descriptor Code: 4

\$HASP520

Explanation:



The job transmitter indicated by *devname* has begun transmitting the indicated job to another node for processing.

\$HASP521 • \$HASP522

In the message text:

jobname

The name of the job.

devname

The name of the device.

Note: A jobid may precede \$HASP520. See "JES2 message format" on page 1.

System action: Processing continues.

Operator response: None.

Module: HASPNJT

Routing Code: 1,2,7

Descriptor Code: 4

\$HASP521

Explanation:

▶▶—*jobname*—INVALID DATA BLOCK—————▶▶

The job transmitter has encountered an error in reading the indicated job's JCL or instream data for transmission to another node. This message may indicate either an incorrect data record on the JES2 spool or hardware I/O errors on the JES2 spool.

In the message text:

jobname

The name of the job.

Note: A jobid may precede \$HASP521. See "JES2 message format" on page 1.

System action: JES2 queues the job for output. Neither transmission for processing nor processing of this job will be attempted. The job transmitter continues processing the next job.

Operator response: Notify the system programmer.

System programmer response: To determine if hardware I/O errors have occurred on the JES2 spool, check the system log for message \$HASP094 and any other messages indicating spool hardware I/O errors. Use this information to correct the problem.

Module: HASPNJT

Routing Code: 1,2,7

Descriptor Code: 4

\$HASP522

Explanation:

▶▶—*jobname* - - —*devname*—RESTARTED—
 └ ,JOB HELD ─┘—————▶▶

The operator has entered a \$E command directed to the job transmitter indicated by *devname* or the transmitter has received an error indication from RTAM.

In the message text:

jobname

The name of the job.

devname

The name of the device.

Note: A jobid may precede \$HASP522. See “JES2 message format” on page 1.

System action: The job transmitter stops transmitting its current job and issues an RTAM “negative close” to cause the job receiver to delete the job that it has partially received. The transmitter will requeue the job for transmission. If JOB HELD appears in the message, the transmitter received an error indication from RTAM when sending an end of file. The job is held to avoid immediate retransmission in case the job was actually received correctly.

Operator response: If JOB HELD appears in the message, determine whether the job was correctly received before releasing it.

Note: This message can also be issued when the job transmitter attempts to send an NJE job to a receiving node that does not have **job** authority on the sending node definition. Ensure that the receiving node has your node correctly defined and check your definitions for that node by doing the following:

1. Enter a \$D JOBQ 'jobname' command for the job indicated in the \$HASP522 message.
2. This will result in the \$HASP890 message, providing the target node id.
3. Enter a \$D NODE command for that id to receive the \$HASP826 message, which displays the settings for that node.
4. Enter the \$T NODE command to define the target node for **job** authority, if necessary.

Module: HASPNJT

Routing Code: 1,2,7

Descriptor Code: 4

\$HASP523

Explanation:

►►—*jobname* – – —*devname*—DELETED—◄◄

The indicated job, which was being transmitted by the job transmitter indicated by *devname* has been canceled. In the message text:

jobname
The name of the job.

devname
The name of the device.

Note: A jobid may precede \$HASP523. See “JES2 message format” on page 1.

System action: JES2 queues the job for output.

Operator response: None.

Module: HASPNJT

Routing Code: 1,2,7

Descriptor Code: 4

\$HASP524

Explanation:

►►—*devname*—INACTIVE—◄◄

The job transmitter indicated by *devname* has completed transmitting its current job and has found no more jobs that it can transmit.

In the message text:

devname
The name of the device.

\$HASP525 • \$HASP526

System action: The job transmitter waits for a job to be added to the transmission queue.

Operator response: None.

Module: HASPNJT

Routing Code: 1,2,7

Descriptor Code: 4

\$HASP525

Explanation:

▶▶ *jobname*—ON—*devname*—programmer—FROM—*userid*—AT—*nodename*—▶▶

An intermediate node received a job statement on the indicated device.

In the message text:

jobname

The name that appears as the job name on the JOB JCL statement.

devname

The JES2 identifier for the device reading in the job.

programmer

The information contained in the programmer name field on the JOB JCL statement, if any.

userid The userid associated with the job as specified by the USER parameter on the JOB JCL statement or as propagated by the MVS security authorization facility (SAF). If JES2 cannot identify the userid that originated this job, this field will display *UNKNOWN.

nodename

The name of the node from which this job originated. If JES2 cannot identify the node from which this job originated, this field will display *UNKNOWN.

Note: A job identifier may precede message \$HASP525. See “JES2 message format” on page 1.

System action: Unless rerouted, the job is forwarded to its final destination when a path is available.

Operator response: None.

Module: HASPRDR

Routing Code: 7

Descriptor Code: 4

\$HASP526

Explanation:

▶▶ *jobname*—TRANSMITTED FOR EXECUTION AT—*nodename*—▶▶

The indicated job has been transmitted from its system of origin to the indicated node for processing. This message appears on a TSO terminal, not on the operator's console, and only appears if the indicated job specified NOTIFY=*userid* on its job card. If apostrophes are imbedded in the job name, they are replaced by quotation marks. In the message text:

jobname

The name of the job.

nodename

The name of the node.

Note: A jobid may precede \$HASP526. See “JES2 message format” on page 1.

System action: The job is purged from the originating system and will not be accessible using TSO STATUS/CANCEL/OUTPUT until its output (if any) is received.

Operator response: None.

Module: HASPNJT

Routing Code: 8

Descriptor Code: 4

\$HASP527

Explanation:

▶▶—*jobname*—HELD - - —PASSWORD ENCRYPTION FAILED—▶▶

JES2 detected a failure while encrypting the password in the indicated job for transmission over the network. In the message text:

jobname

The name of the job which contains the password JES2 was attempting to encrypt.

Note: A jobid may appear before \$HASP527 if your installation includes the jobid in the console message format.

System action: JES2 puts the job in HELD status and requeues the job for transmission.

Operator response: Notify the system programmer.

System programmer response: Examine SYSLOG to see if your security product has issued error messages before this message. Determine why password encryption failed. Failed password encryption will be brought to the security administrator's attention. Contact operator when problem is corrected.

Module: HASPNJT

Routing Code: 1,2,8,9,10

Descriptor Code: 4

\$HASP528

Explanation:

▶▶—LINE1*na*—INPUT HELD - - —NJE HOP COUNT EXCEEDED—▶▶

JES2 has held a job or SYSOUT entering this system from the network. The hop count in the header of the job or SYSOUT is greater than the maximum number of hops specified in the MAXHOP parameter of the NJEDEF initialization statement. This message could indicate a possible loop in the network.

In the message text:

lna The line number.

Note: A job identifier precedes this message. See "JES2 message format" on page 1.

System action: The system continues processing. The system also issues message \$HASP686.

Operator response: Do the following:

1. Note the line number and job identifier displayed in this message.
2. Enter a \$D J command to determine the destination of the job or SYSOUT.
3. Enter a \$D PATH(nodename) command to determine the paths to the destination of the job or SYSOUT.
4. Look at all paths to the destination node that use the line indicated in the \$HASP528 message to see if there is a loop in that path.
5. Correct any network definitions in error.
6. Release the held job or SYSOUT after the definitions are correct.

\$HASP529

Module: HASPNSR, HASPRDR

Routing Code: 8

Descriptor Code: 4

\$HASP529

Explanation:

▶▶ *jobname*—*jobid*—FROM—*origin-node* ———— REJECTED BY ———— *detecting-node*
 └── THROUGH—*adjacent-node* ───┘ └── *device* ───┘ ▶▶

▶ — — — *nodename* — IS NOT DEFINED —————▶▶

A 'store-and-forward' node received a job destined for a node that is not defined. The probable cause is an error in the routing table of either the origin node, adjacent node, or detecting node. In the message text:

jobname

The name of the job

jobid

The original jobid of the job

origin-node

The node at which the job was submitted

adjacent-node

The 'store-and-forward' node sending the job to the detecting node. If *THROUGH adjacent-node* does not appear in the message text, the job was received directly from the *origin-node*, that is, there is no 'store-and-forward' between the origin and detecting nodes.

detecting node

The node detecting the error, if the problem is not detected locally

device

The device detecting the error, if the problem is detected locally

nodename

The node name which is not defined as a valid node name at the *detecting-node*

System action: The job is rejected by the *detecting-node* and remains at the *adjacent-node* in a held state.

Operator response: Note the jobname and jobid of any jobs for which the message was issued and contact the system programmer. After the system programmer has resolved the network routing error, release any jobs or SYSOUT that were held at the *adjacent-node*.

Programmer response: The failure is caused because the adjacent node does not believe the node *nodename* can be reached through the detecting node, and *nodename* is not recognized as a valid nodename there. Possible cause are:

- A NODE(nnn) statement was omitted from the initialization data set at the *detecting-node*
- A DESTID(nodename) statement was either omitted from the initialization data set at the *detecting-node* or specified non-nodal routing
- A NODE(nnn) statement was purposely omitted from the initialization data set at the *detecting-node*, but the network definitions at the adjacent node cannot account for that omission

Detecting Module: HASPRDR, HASPNSR

Routing Code: 8,10

Descriptor Code: 4

\$HASP530

Explanation:



SYSOUT data sets for the indicated job are being transmitted by the SYSOUT transmitter indicated by *devname*. In the message text:

jobname

The name of the job.

devname

The name of the device.

nnnn

The number of records associated with this job.

Note:

1. *nnnn* may not represent the total number of records to be transmitted or received because of multiple copies or multiple destinations.
2. If the job is selected by an offload device, *nnnn* **RECORD[S]** will not be displayed because JES2 does not count the number of held data set records.

Note: A jobid may precede \$HASP530. See “JES2 message format” on page 1.

System action: Processing continues.

Operator response: None.

Module: HASPNJT

Routing Code: 8,10

Descriptor Code: 4

\$HASP531

Explanation:



The SYSOUT transmitter indicated by *devname* has encountered an error while reading a SYSOUT data set for transmission. This message may indicate one of the following:

- An incorrect data record on JES2 spool
- Hardware I/O errors on JES2 spool

Note: An incorrect data block could result from the interruption of a job before the last write to an obtained track could be completed. In this case, the message does not indicate an error. The first form of this message is displayed on the operator's console. The second form of this message is transmitted as the last line of the data set for programmer information.

In the message text:

jobname

The name of the job.

devname

The name of the device.

nodename

The name of the node.

\$HASP532

Note: A jobid may precede \$HASP531. See "JES2 message format" on page 1.

System action: Further reading and transmission of the current data set is halted. The SYSOUT transmitter continues processing with the next data set.

Operator response: Notify the system programmer.

System programmer response: To determine if hardware I/O errors have occurred on the JES2 spool, check the system log for message \$HASP094 and any other messages indicating spool hardware I/O errors. Also, check the system log during the job's processing for an abend, which would result in an incomplete data block. Use this information to correct the problem.

Module: HASPNST

Routing Code: 8,10

Descriptor Code: 4

\$HASP532

Explanation:

```
▶▶—jobname - - —devname—RESTARTED—  
      |,JOB HELD—  
      |,OUTGROUP NON-SELECTABLE—
```

One of the following occurred:

- The operator has entered a \$E command directed to the SYSOUT transmitter indicated by *devname*.
- The transmitter has received an error indication from RTAM.
- The sending node does not have the proper authority defined for the target node. (See the note under **Operator Response**.)

In the message text:

jobname

The name of the job.

devname

The name of the device.

Note: A jobid may precede \$HASP532. See "JES2 message format" on page 1.

System action: The SYSOUT transmitter stops transmitting data sets for its current job and issues an RTAM "close" to cause the SYSOUT receiver to delete any output it has already received (that is, purge the received job). The transmitter will place the JOEs it has acquired back in the network JOE queue for transmission at a later time.

If **JOB HELD** appears in the message, the transmitter received an error indication from RTAM when sending a job header, job trailer, or an end-of-file. The job is held to avoid immediate retransmission in case the job was actually received correctly.

If **OUTGROUP NON-SELECTABLE** appears in the message, the transmitter received an error indication from RTAM when sending a data set header or a data set. The data set is marked non-selectable to avoid immediate retransmission.

Operator response: If **JOB HELD** appears in the message, determine whether the JOB was correctly received before releasing it. If **OUTGROUP NON-SELECTABLE** appears in the message, the non-selectable data set can be displayed using the \$L command and the data set can be made selectable for retransmission using the \$T command.

Note: This message can also be issued when the SYSOUT transmitter attempts to send an NJE job to a receiving node that does not have **job** authority on the sending node definition. Ensure that the receiving node has your node correctly defined and check your definitions for that node by doing the following:

1. Enter a \$D JOBQ 'jobname' command for the job indicated in the \$HASP522 message.
2. This will result in the \$HASP890 message, providing the target node id.

3. Enter a \$D NODE command for that id to receive the \$HASP826 message, which displays the settings for that node.
4. Enter the \$T NODE command to define the target node for **job** authority, if necessary.

Module: HASPNJT

Routing Code: 8

Descriptor Code: 4

\$HASP533

Explanation:

▶▶—*jobname* - - —*devname*—DELETED—▶▶

The operator has entered a \$C command directed to the SYSOUT transmitter indicated by *devname* or has canceled the job and specified the purge operand.
In the message text:

jobname

The name of the job.

devname

The name of the device.

Note: A jobid may precede \$HASP533. See “JES2 message format” on page 1.

System action: The SYSOUT transmitter stops transmitting data sets for its current job and issues an RTAM “negative close” to cause the SYSOUT receiver to delete any output it has already received (that is, purge the received job). The transmitter will remove the job output elements (JOEs) it has acquired from the network JOE queue. The data sets represented by the JOEs will not be available for output. If, after removing the JOEs, there is no more work to be performed for the job, the job will be queued for purging.

Operator response: None.

Module: HASPNJT

Routing Code: 8

Descriptor Code: 4

\$HASP534

Explanation:

▶▶—*devname*—INACTIVE—▶▶

The SYSOUT transmitter indicated by *devname* has completed transmitting its current job and has found no more work to send in the network job output element (JOE) queue.
In the message text:

devname

The name of the device.

System action: JES2 processing continues.

Operator response: None.

Module:

HASPNJT

Routing Code: 8

Descriptor Code: 4

\$HASP535 •

\$HASP535

Explanation:

▶▶—CKPT MODE FORCED TO—DUPLICATE DUE TO USE OF STRNAME—*strname*—▶▶

JES2 was requested to run in DUAL mode for checkpoint data set operations. However, one or both of the active data sets resides in a coupling facility structure (the STRNAME= subparameter was specified for both the CKPT*n*= parameter and the NEWCKPT*n* parameter on the CKPTDEF initialization statement); JES2 will not operate in DUAL mode if a coupling facility structure is used for a checkpoint data set. In the message text:

strname

The name of the coupling facility structure.

System action: JES2 forces the checkpoint mode to duplex and processing continues.

Operator response: None.

Module:

HASPSXIT

Routing Code: 1,2,10

Descriptor Code: 4

\$HASP536

Explanation:

▶▶—MEMBER—*member_name* — —CONNECT TO STRNAME—*strname*—FOR—

CKPT1
CKPT2

—▶▶

▶—FAILED, RC=—*rc*—RSN=—*rsn*—ERRCODE=—*xx*, —*text*—▶▶

JES2 could not connect to the coupling facility structure for the specified checkpoint data set. In the message text:

strname

The name of the coupling facility structure.

CKPT1 JES2 was attempting to connect to the coupling facility structure *strname* for CKPT1.

CKPT2 JES2 was attempting to connect to the coupling facility structure *strname* for CKPT*n*.

rc Hexadecimal return code from the connect service. See *z/OS MVS Programming: Sysplex Services Reference*.

rsn Hexadecimal reason code from the connect service. See *z/OS MVS Programming: Sysplex Services Reference*.

errcode, text

One (or more) of the additional decimal codes and accompanying text messages provided by JES2.

The first four digits display the return codes for the IXLCONN macro, while the next four digits display the reason code field. The following list shows ERRCODE and *text*:

01, STRUCTURE DOES NOT HAVE A DISP OF KEEP

Explanation: Specifies that this structure was not initially allocated by JES2.

System programmer response: Ensure that you have specified the correct value for STRNAME. If you have, delete the structure and let JES2 attempt to connect to it again. If this method does not succeed, specify a new value for STRNAME.

02, STRUCTURE DATA SIZE IS INCORRECT

Explanation: Specifies that this structure was not initially allocated by JES2.

System programmer response: Ensure that you have specified the correct value for STRNAME. If you have, delete the structure and let JES2 attempt to connect to it again. If this method does not succeed, specify a new value for STRNAME.

03, STRUCTURE IS NOT A LIST

Explanation: Specifies that this structure was not initially allocated by JES2.

System programmer response: Ensure that you have specified the correct value for STRNAME. If you have, delete the structure and let JES2 attempt to connect to it again. If this method does not succeed, specify a new value for STRNAME.

04, STRUCTURE DOES NOT SUPPORT NAMES REFERENCES

Explanation: Specifies that this structure was not initially allocated by JES2.

System programmer response: Ensure that you have specified the correct value for STRNAME. If you have, delete the structure and let JES2 attempt to connect to it again. If this method does not succeed, specify a new value for STRNAME.

05, STRUCTURE DOES NOT HAVE ENOUGH LIST HEADERS

Explanation: Specifies that this structure was not initially allocated by JES2.

System programmer response: Ensure that you have specified the correct value for STRNAME. If you have, delete the structure and let JES2 attempt to connect to it again. If this method does not succeed, specify a new value for STRNAME.

06, STRUCTURE DOES NOT HAVE ENOUGH LOCK ENTRIES

Explanation: Specifies that this structure was not initially allocated by JES2.

System programmer response: Ensure that you have specified the correct value for STRNAME. If you have, delete the structure and let JES2 attempt to connect to it again. If this method does not succeed, specify a new value for STRNAME.

07, STRUCTURE NOT ALREADY USED

Explanation: Specifies that JES2 does not see checkpoint data set forwarded through the reconfiguration dialog.

System programmer response: Ensure that you have specified the correct value for STRNAME. If you have, delete the structure and let JES2 attempt to connect to it again. If this method does not succeed, specify a new value for STRNAME.

08, STRUCTURE IS NOT LARGE ENOUGH

Explanation: Specifies that JES2 finds structure too small for use.

System programmer response: See *z/OS JES2 Initialization and Tuning Guide* to determine how large the structure should be. Either delete the structure and redefine it, or change the value for STRNAME and allow JES2 to attempt to connect to a structure of the proper size.

09, ACTIVE CONNECTION ALREADY EXISTS

Explanation: Specifies that a system with the same name (MASDEF OWNMEMB=*member*) is already connected to the structure.

System programmer response: Either change the MASDEF OWNMEMB= name for this system or bring the other system down.

• **\$HASP537**

10, NO MORE CONNECTIONS AVAILABLE

Explanation: No more connections are available to the coupling facility.

System programmer response: You can end the program of some address spaces connected to the structure, or change the value of STRNAME and let JES2 attempt to connect to the structure again.

11, STRUCTURE IS NOT IN ACTIVE POLICY

Explanation: The structure accessed for the checkpoint data set is defined in a coupling facility resource management (CFRM) administrative policy that is not currently active at your installation.

System programmer response: For more information on administrative policies, see *z/OS MVS Setting Up a Sysplex* .

12, XES IS NOT AVAILABLE

Explanation: The XES component is unavailable.

System programmer response:

- On a cold start or an all-member warm start:
 - Change the coupling facility name.
 - Use a DASD data set (DSNAME= VOL=) instead of STRNAME=.
- On a hot start, or a single member warm start
 - Enter the reconfiguration dialog to change the checkpoint data set specifications.

13, MASDEF OWNMEMB= VALUE NOT VALID FOR XES

Explanation: The connection name (CONNNAME=) that JES2 passed to XES is not valid. JES2 creates the connection name by concatenating the string 'JES2_' with the name of the local member as specified on either the OWNMEMB= parameter of the MASDEF initialization statement or the default name specified as the SID specification in the MVS SMFPRMnn PARMLIB member.

System programmer response: Ensure that the value specified on the OWNMEMB= parameter is valid and contains characters that are valid as a XES connection name. Correct the OWNMEMB= value if necessary and allow JES2 to attempt to reconnect the member. For MASDEF OWNMEMB= naming convention information and for the SMFPRMnn PARMLIB member, see *z/OS MVS Initialization and Tuning Reference*.

14, ERROR BUILDING LEID TABLE DURING CF ALLOCATE

Explanation: A read of the LEID table failed during coupling facility allocation processing.

System programmer response: Contact the IBM support center.

\$HASP537

Explanation:

▶▶—THE CURRENT CHECKPOINT USES—*nnnn*—4K RECORDS—▶▶

JES2 issues a message during initialization to inform system programmers of the checkpoint size requirements for the current checkpoint configuration. If this is a cold start, the number is based on the parameters specified in the initialization deck. If this is a warm start, the size is based on the current checkpoint configuration.

nnnn Specifies the number of 4K checkpoint records required for the checkpoint configuration. This includes normal 4K data records, the change log 4K records, and an approximation for data control (such as the master record).

Note: The number given is an approximation of the space needed to hold the checkpoint. Because all records are not 4K in length, there is some error because of rounding. The exact space required will depend on whether a coupling facility or DASD is used and the type of DASD. The number presented is within 5 of the actual value needed.

System action: JES2 continues processing.

\$HASP540 • \$HASP542

In the message text:

class The class name.

device The device name.

System action: Processing terminates.

Operator response: None.

Module:

HASPNSR, HASCNJSR

Routing Code: 8

Descriptor Code: 4

\$HASP540

Explanation:

▶▶—*jobname*—ON—*devname*—FROM—*userid*—AT—*nodename*—*nnnn*—RECORD—*S*—▶▶

The SYSOUT receiver indicated by *devname* has begun to receive system output (SYSOUT) data for the indicated job.
In the message text:

jobname

The name of the job as it appears on the JOB JCL statement.

devname

The name of the device on which the job is entering the system.

userid

The userid associated with the job, either as it appears on the JOB JCL statement or as propagated from another session. If JES2 cannot identify the userid that originated this job, this field will display *UNKNOWN.

nodename

The name of the node from which the job originated. If JES2 cannot identify the node from which this job originated, this field will display *UNKNOWN.

nnnn

The number of records associated with this job. (Note that *nnnn* may not represent the total number of records to be transmitted or received because of multiple copies or multiple destinations.)

Note: A job identifier may precede message \$HASP540. See “JES2 message format” on page 1.

System action: Processing continues.

Operator response: None.

Module:

HASPNSR, HASCNJSR

Routing Code: 8

Descriptor Code: 4

\$HASP542

Explanation:

▶▶—MEMBER—*member_name* — — —STRUCTURE—*strname*—▶▶

- ▶—IS NOT LARGE ENOUGH TO CONTAIN ALL CHECKPOINT DATA.—————▶
- ▶—THE CURRENT SIZE IS ccccccK. THE SIZE MUST BE INCREASED————▶
- ▶—TO HOLD AN ADDITIONAL aaaaaa 4K ELEMENTS. THIS WOULD————▶
- ▶—REQUIRE A STRUCTURE SIZE OF AT LEAST nnnnnnK.—————▶

JES2 attempted to use the coupling facility structure *strname*, but the structure is not large enough to contain the checkpoint data set. In the message text:

member_name

The name of the JES2 member.

strname

The name of the coupling facility structure.

cccccK The current size of the structure

aaaaaa The number of 4K elements that would not fit in the current structure.

nnnnnnK

The minimum structure size needed to hold all the checkpoint data. JES2 determined this size by adding 4 times *aaaaaa* to the current structure size; however, this does not account for any control data associated with the 4K elements. If *aaaaaa* is larger than 50, then a structure of this size might not be large enough to hold the checkpoint.

System action: JES2 stops processing.

Operator response: Notify the system programmer.

System programmer response: Specify a new, larger coupling facility structure that has been defined in the active CFRM administrative policy. To determine the exact size required, calculate the total storage required to hold *aaaaaa* 4K elements on the coupling facility on which the structure is to be placed and then add that value to *ccccc*. If a large enough structure does not exist, move the checkpoint to DASD and restart JES2. See *z/OS MVS Setting Up a Sysplex* for more information about CFRM policies.

Module: HASPCKDS

Routing Code: 2,10

Descriptor Code: 4

\$HASP543

Explanation:

▶▶—*jobname* - - —*devname*—DELETED————▶▶

One the following occurred:

- HASPRTAM has indicated to the SYSOUT receiver or job receiver that an error has occurred.
- The SYSOUT transmitter has indicated an improper CLOSE to the SYSOUT receiver.
- The job transmitter has indicated an improper CLOSE to the job receiver.
- The operator entered a \$C or \$E directed to either the SYSOUT receiver or job receiver.
- The job receiver encountered errors reading or moving the job header or job trailer.
- The job receiver encountered an incorrect job card or incorrect input cards.
- The security subsystem used by the JES2 NJE receiver has determined that the job or SYSOUT cannot be received for security reasons based on the NODES class profiles.

In the message text:

jobname

The name of the job.

\$HASP544

devname

The name of the device.

Note: A jobid may precede \$HASP543. See "JES2 message format" on page 1. The appearance of a jobid and job name also depend on processing.

System action: The SYSOUT receiver or job receiver stops receiving data from the current job and queues the current job for purging. The SYSOUT receiver or job receiver will be held or queued at the transmitting node.

Operator response:

None.

Module: HASPNSR, HASPRDR

Routing Code: 8

Descriptor Code: 4

\$HASP544

Explanation:

▶▶—ALL CHECKPOINT DATA SETS—ARE IN VOLATILE COUPLING FACILITIES. —————▶

▶—COUPLING FACILITY FAILURE(S) COULD CAUSE—LOSS OF ALL JES2 CHECKPOINT DATA. —————▶

┌ CHOICES ─┐

CHOICES:

|—SHOULD JES2 CONTINUE TO USE—VOLATILE CHECKPOINT STRUCTURE(S)? —————▶

▶—YES — —CONTINUE USING THE VOLATILE COUPLING FACILITIES —————|

┌—NO — — INVOKE THE CHECKPOINT RECONFIGURATION DIALOG —————┐

JES2 has detected that all checkpoint data sets reside in volatile coupling facilities.

Note: A coupling facility is always considered volatile unless you have taken measures to protect against the loss of power to that coupling facility. See *ES/9000 and ES/3090 PR/SM Planning Guide* for a description of how to monitor the volatility of coupling facilities. When VOLATILE=(ALLCKPT=WTOR), JES2 issues the WTOR indicated within brackets in the message text to inform the operator of the condition and waits for the reply. When VOLATILE=(ALLCKPT=DIALOG), JES2 issues this highlighted message so that the operator knows why the system has entered the checkpoint reconfiguration dialog.

System action: When VOLATILE=(ALLCKPT=WTOR), if a reply of 'YES' is given to the WTOR indicated within brackets in the message text, JES2 continues using the checkpoint data set even though it is volatile. If a reply of 'NO' is given, JES2 enters the reconfiguration dialog. When VOLATILE=(ALLCKPT=DIALOG), JES2 initiates a checkpoint reconfiguration dialog after this message appears on the operator console.

Operator response: When VOLATILE=(ALLCKPT=WTOR), reply 'YES' if JES2 is to continue using the volatile structure, or reply 'NO' if JES2 is to enter the reconfiguration dialog. When VOLATILE=(ALLCKPT=DIALOG), no response is required.

Module: HASPCKPT

Routing Code: 1,2,10

Descriptor Code: 2,4,7

\$HASP545

Explanation:

▶▶—*devname*—SKIPPING TO END-OF-JOB—▶▶

The operator has entered a \$C command directed to the network SYSOUT receiver or the network job receiver. This message may also be issued by the offload job or SYSOUT receivers when an I/O error has occurred on the offload data set.

In the message text:

devname

The name of the SYSOUT receiver or the job receiver.

System action: The SYSOUT receiver or the job receiver accepts and discards records until the end of the current job is reached. The SYSOUT receiver accepts records from the SYSOUT transmitter; the job receiver accepts input records from the job transmitter.

Operator response: None.

Module: HASPNSR, HASPRDR

Routing Code: 8

Descriptor Code: 4

\$HASP546

Explanation:

▶▶—*jobname*—[*(—jobid—FROM—orgnode—)*]
 SYSTEM OUTPUT—[RECEIVED AT—*nodename*]
 DELETED—▶▶

SYSOUT data for the indicated job has been received or deleted at its ultimate destination, indicated by *nodename*. If the job originated at a different node, that node (*orgnode*) and the original *jobid* are displayed in the message text. If apostrophes are imbedded in the job name, they are replaced by quotation marks.

In the message text:

jobname

The name of the job.

jobid The job identifier.

orgnode

The name of the originating node of the job.

nodename

The name of the node receiving the job.

Note:

1. This message is sent to the terminal where the user is logged on only if the NOTIFY=userid is specified on the JCL JOB statement.
2. A jobid referencing the current JES2 jobid on this system may precede \$HASP546. See "JES2 message format" on page 1.

System action: Processing continues.

User response: If the user identified on the NOTIFY parameter is logged on at node *nodename*, that user may enter STATUS, CANCEL, or OUTPUT commands for the job's SYSOUT.

Module: HASPNSR, HASCNJSR

Routing Code: 1,2,8

Descriptor Code: 4

\$HASP547 • \$HASP549

\$HASP547

Explanation:

▶▶—*devname*—INPUT NOT ACCEPTED - - —JOB QUEUE FULL—▶▶

The NJE SYSOUT receiver indicated by *devname* received a request to accept a job from a connected node, but was unable to add the job to the JES2 queue.

In the message text:

devname

The name of the device.

System action: The SYSOUT transmitter on the connected node will drain after receiving the rejection.

Operator response: Notify the system programmer that the job queue has become full. If possible, drain JES2 input devices to reduce the load on the job queue.

System programmer response: Increase the value of the JOBNUM parameter on the JOBDEF initialization statement at the next JES2 cold start.

Module: HASPNSR

Routing Code: 1,2,8

Descriptor Code: 4

\$HASP548

Explanation:

▶▶—MAIL TO—(*nodename/userid*)—DELETED, INVALID USERID—▶▶

JES2 issues this message to a TSO user who attempted to transmit a file to an incorrect userid. In the message text: the node name and userid are those of the target of the transmitted file. This message is sent only if the TSO user transmitting the file codes NOTIFY= on the JOB statement.

In the message text:

nodename

The name of the target node.

userid The target userid.

System action: JES2 invokes an installation exit. This exit may be coded so that the file is deleted or sent to a different userid. This exit may also be coded to change the "INVALID USERID" message text to any appropriate message text of 20 characters or less.

Operator response: None.

User response: Transmit the file to a valid userid.

Module: HASPHOPE

Routing Code: 2,10

Descriptor Code: 4

\$HASP549

Explanation:

▶▶—MAIL FROM—(*nodename/userid*)—

RECORDS (nnnnnnnnn)
└── PAGES (nnnnnnnnn) ──┘

—▶▶

JES2 sends this message to the TSO user who has received a transmitted file from another node or a spool reload procedure.

Note: The \$HASP549 message might not be received by the target user. The following factors influence the receipt of the message:

- The JES2 NJEDEF initialization statement.
\$HASP549 is only received by the target user if you specified MAILMSG=Yes. For more information about the NJEDEF MAILMSG parameter, see *z/OS JES2 Initialization and Tuning Reference*.
- Response bits from JES2 exit 40 are as follows:

X040RFNT

JES2 ignores the NJEDEF MAILMSG= parameter and issues the \$HASP549 message.

X040RNNT

JES2 ignores the NJEDEF MAILMSG= parameter and does not issue the \$HASP549 message.

For more information about Exit 40, see *z/OS JES2 Installation Exits*.

- The status of the target user.
If the target user is logged on to the target node, they will receive the \$HASP549 message.
If the target user is logged off, the \$HASP549 message is added to the shared SYS1.BROADCAST or userid.BROADCAST data set.

In the message text:

nodename

The name of the sending node.

userid The sending userid.

nnnnnnnnnn

The number of records or pages being sent.

System action: Processing continues.

Operator response: None.

Module:

HASPHOPE

Routing Code: –

Descriptor Code: –

\$HASP550

Explanation:

▶▶—THE COUPLING FACILITY WHICH—CONTAINS CKPTn HAS JUST—BECOME VOLATILE—▶▶
 ▶—[SHOULD JES2 CONTINUE USING THIS FACILITY?]—▶

VALID RESPONSES ARE:

- 'YES' – CONTINUE USING THE VOLATILE COUPLING FACILITY
- 'NO' – INVOKE THE CHECKPOINT RECONFIGURATION DIALOG

JES2 has detected that one of the two checkpoint data sets resides in a volatile coupling facility. When VOLATILE=(ONECKPT=WTOR), JES2 issues the entire highlighted message (including the portion in brackets) and waits for the operator's reply.

Note: A coupling facility is always considered volatile unless you have taken measures to protect against the loss of power to that coupling facility. See *ES/9000 and ES/3090 PR/SM Planning Guide* for a description of how to monitor the volatility of coupling facilities. When VOLATILE=(ONECKPT=DIALOG), JES2 issues only the unbracketed portion of the highlighted message so that the operator knows why the system has entered the checkpoint reconfiguration dialog. Valid responses are:

\$HASP552 • \$HASP553

YES Resume normal processing using the now volatile coupling facility.

NO Invoke the checkpoint reconfiguration dialog to discontinue JES2 use of this coupling facility.

System action: When VOLATILE=(ONECKPT=WTOR), a reply of 'YES' causes JES2 to continue using the checkpoint data set even though it is volatile. A reply of 'NO' causes JES2 to enter the reconfiguration dialog. When VOLATILE=(ONECKPT=DIALOG), the JES2 members enter the checkpoint reconfiguration dialog after this message appears on the operator console.

Operator response: When VOLATILE=(ONECKPT=WTOR), consult the bracketed portion of the highlighted message and reply 'YES' if JES2 is to continue using the volatile structure, or reply 'NO' if JES2 is to enter the reconfiguration dialog. When VOLATILE=(ONECKPT=DIALOG), no response is necessary.

System programmer response: None

Module:

HASPCKPT

Routing Code: 1,2,10

Descriptor Code: 2,4,7

\$HASP552

Explanation:

▶▶—A CHECKPOINT DATA SET WRITE—IS CURRENTLY IN PROGRESS. JES2—WILL WAIT FOR THE WRITE TO COMPLETE—▶▶
▶—BEFORE ALLOWING TERMINATION—PROCESSING TO CONTINUE.—▶▶

A \$PJES2,ABEND command was issued to withdraw JES2 from the system. However, JES2 detected that there was still an active write request against a checkpoint data set on a coupling facility. To guarantee that the data in the coupling facility is consistent, JES2 is delaying terminate processing until the write request completes.

System action: JES2 delays termination processing until the write request completes.

Operator response: Notify the system programmer.

System programmer response: Allow JES2 to wait for the write request to complete. However, if you think that JES2 must be terminated immediately, issue the \$PJES2,ABEND,FORCE command. Note that forcing JES2 to terminate while the member is processing a write request can damage the integrity of the checkpoint data set. This wait can occur if a structure on a coupling facility is being dumped. Enter the DISPLAY XCF,STRUCTURE operator command to obtain the dump id. Then you can enter the SETXCF,FORCE operator command to end the dump. For more information on these system commands, see *z/OS MVS System Commands*.

Module:

HASPCOMM

Routing Code: 1,2,10

Descriptor Code: 4,7

\$HASP553

Explanation:

▶▶—\$P JES2,ABEND,FORCE COMMAND—DENIED ISSUE THE \$P JES2,ABEND—COMMAND FIRST—▶▶

A \$PJES2,ABEND,FORCE command was issued to withdraw JES2 from the system. However, the \$PJES2,ABEND command had not been issued first.

System action: JES2 ignores the command.

Operator response: Enter the \$PJES2,ABEND command.

Module:

HASPCOMM

Routing Code: 1,2,10

Descriptor Code: 4

\$HASP554

Explanation:

▶—MEMBER—*member_name* — — —A MISMATCH EXISTS—BETWEEN WHAT JES2 WAS EXPECTING ON—————▶
 ▶—CKPTn AND WHAT WAS PROVIDED BY THE—COUPLING FACILITY RC=—*rsnc*—————▶◀

MEMBER *member_name* — — A MISMATCH EXISTS

BETWEEN WHAT JES2 WAS EXPECTING ON
 CKPTn AND WHAT WAS PROVIDED BY THE
 COUPLING FACILITY RC=*rsnc*

JES2 finds that the information on the in-storage copy of the checkpoint data set and the copy of the checkpoint data set that resides on a coupling facility structure do not match.

It is possible that you are attempting to start a JES2 member with initialization parameters that are incompatible with the initialization parameters that are either:

- a. Currently in effect in the MAS
- or
- b. Different from those specified at cold-start time

Under these circumstances, the format of the checkpoint data set already in effect can be very different from the one expected on the member you are attempting to start. This discrepancy can cause various errors to occur, including the display of this message.

This is an example of conditions that can cause these errors to occur:

You have attempted to change a cold start initialization parameter during a warm start (for example, JOBNUM= on the JOBDEF initialization statement). See the *z/OS JES2 Initialization and Tuning Reference* for a description of initialization parameters that require a cold start.

See the JES2 Migration Notebook applicable for the highest JES2 release running in the MAS for more details on checkpoint compatibility.

In the message text:

rsnc The reason code associated with the cause of this occurrence.

***rsnc* Explanation**

- 01** Specifies that more checkpoint records exist on the coupling facility than JES2 expected to process.
- 02** Specifies that fewer checkpoint records exist on the coupling facility than JES2 expected to process.

System action: JES2 enters the checkpoint reconfiguration dialog.

Operator response: Notify system programmer

System programmer response: Correct the initialization parameters so that they are compatible with the with the cold start initialization parameters currently in effect.

Module:

HASPCFLE

Routing Code: 1,2,10

\$HASP555 • \$HASP562

Descriptor Code: 4

\$HASP555

Explanation:

▶▶—NO CHECKPOINT RECORDS FOUND IN CKPT_n—DATA—COUPLING FACILITY STRUCTURE IS EMPTY—▶▶

NO CHECKPOINT RECORDS FOUND IN CKPT_n DATA

SET COUPLING FACILITY STRUCTURE IS EMPTY

JES2 has detected an unusable checkpoint data set that resides on a coupling facility structure while attempting to warm start. If you cold started with a checkpoint defined on a coupling facility structure, but replied 'N' in response to the \$HASP441 message that asks to confirm the checkpoint data sets, JES2 connects to, but does not use, that structure. If you attempt to use this structure in a subsequent warm start, this message results.

System action: JES2 enters the checkpoint reconfiguration dialog.

Operator response: Notify the system programmer and respond to the checkpoint reconfiguration dialog messages. If you are unfamiliar with the dialog process, see *z/OS JES2 Initialization and Tuning Guide* for sample scenarios.

System programmer response: Determine why the checkpoint data set being used is empty. If possible, specify a different checkpoint data set either in the JES2 initialization data set or in console mode.

Module: HASPIRDA

Routing Code: 1,2,10

Descriptor Code: 4

\$HASP561

Explanation:

▶▶—NJEDEF NODENUM=*mmmmm*,—SAVED VALUE OF—*nnnnn*—WILL NOT BE USED—▶▶

The JES2 initialization parameter NJEDEF NODENUM=*mmmmmm* was specified, and the number of nodes was successfully increased from *nnnnn* to *mmmmmm*.

System action: JES2 initialization continues.

Operator response: None

System programmer response: None

Module: HASPIRRE

Routing Code: 1,2,10

Descriptor Code: 4

\$HASP562

Explanation:

▶▶—UNABLE TO INCREASE NJEDEF NODENUM FROM—*mmmmm*—TO—*nnnnn*—▶▶

▶—UNABLE TO EXPAND JES2 CHECKPOINT TO INCLUDE—*nnnnn*—NODES—▶▶

JES2 was unable to create checkpointed structures large enough to contain all defined NJE nodes. The number of nodes might have been increased on the NJEDEF NODENUM= initialization statement, or the checkpointed structures previously created (for example, because an earlier release of JES2 was used).

System action: JES2 prompts the operator to verify that initialization should continue without these checkpointed structures.

Operator response: Verify that the correct initialization parameters are being used and reply to the \$HASP441 message as appropriate.

System programmer response: Increase the size of the checkpoint as indicated by the \$HASP296 or \$HASP542 message.

Module: HASPIRDA

Routing Code: 1,2,10

Descriptor Code: 4

\$HASP563

Explanation:

```
▶▶—NODE(n)—<NAME=—xxxxxxx—>—<LOCAL NODE>—DEFINITION—<HAS|CANNOT BE>—————▶
▶—CHANGED NODE(n)—keyword=value—<WILL BE|CANNOT BE>—CHANGED TO—keyword=value—————▶▶
```

During initialization, this message is issued to indicate that parameters on the NODE statement were different on this restart of JES2 from the values in the current checkpointed NITC structures. The message indicates whether the new value of the parameter will be accepted or not.

After initialization, this message is issued to indicate that JES2 detected a change to a parameter value in the checkpointed NITC structure because of a modification from another MAS member. This message is for informational purposes only.

System action: During initialization JES2 prompts the operator to verify that initialization should continue with the specified values.

Operator response: Verify that the correct initialization parameters are being used and reply to the \$HASP441 message as appropriate.

System programmer response: None

Module: HASPIRRE

Routing Code: 1,2,10

Descriptor Code: 4

\$HASP564

Explanation:

```
▶▶—UNABLE TO—<FIND|CREATE|SHARE>—————▶
▶—jesx—NIT DATA SPACE—<$DSPSERV|IARVSERV>—<RC=—nnnnnnnn—>—<,RSN=—nnnnnnnn—>—————▶▶
```

JES2 was unable to create a dataspace to shadow NIT information for use by other address spaces. The failing service and applicable return and reason codes are issued in the message.

System action: JES2 initialization is terminated.

Operator response: Contact system programmer

System programmer response: Contact IBM service

Module: HASPIRRE

Routing Code: 1,2,10

Descriptor Code: 4

\$HASP565

\$HASP565

Explanation:

- ▶▶—LINE REQUEST FROM NETSRV—*nn*—FOR—*nodename*—————▶▶
- ▶—REJECTED —<DEDICATED LINE LINE—*nnnn*—IS NOT AVAILABLE, RC=1>—————▶
- ▶—<DEDICATED LINE LINE—*nnnn*—IS NOT AVAILABLE, RC=2>—————▶
- ▶—<NO IDLE TCP/IP LINES, RC=3>—<SOCKET NOT AVAILABLE, RC=4>—————▶
- ▶—<NODE NAME NOT RECOGNIZED, RC=5>—<NETWORK PATH MANAGER NOT AVAILABLE, RC=6>—————▶▶

A request was received from another NJE node to initiate a NJE connection, but requested resources were not available. One of the following texts will be displayed:

DEDICATED LINE LINEⁿⁿⁿⁿ IS NOT AVAILABLE, RC=1

The requested dedicated line does not exist.

DEDICATED LINE LINEⁿⁿⁿⁿ IS NOT AVAILABLE, RC=2

The requested dedicated line exists but is either already active or not a TCP/IP line.

NO IDLE TCP/IP LINES, RC=3

No available TCP/IP line can be located.

SOCKET NOT AVAILABLE, RC=4

No SOCKET(*xxxx*) definition can be found to match the incoming request.

NODE NAME NOT RECOGNIZED, RC=5

The incoming request is for a NJE node not defined to JES2.

NETWORK PATH MANAGER NOT AVAILABLE, RC=6

The network path manager has previously failed and was unable to recover. A restart of JES2 is required.

SYSTEM RESOURCE SHORTAGE BUFFERS, RC=7

No TP buffers are available.

LINE IS BUSY, RC=8

The specified line is already in use.

SYSTEM RESOURCE SHORTAGE NETDCTS, RC=9

All networking lines defined by the LINENUM parameter on the NJEDEF initialization statement are in use.

INTERNAL ERROR, RC=10

An internal error is detected.

APPCLU CLASS INACTIVE, RC=11

A secure signon is attempted (through SIGNON=SECURE on the NODE statement), but the encryption key can not be used because the RACF APPCLU class is not active.

System action: The request to initiate an NJE session is rejected.

Operator response: Start a qualifying TCP/IP line, and have the other node reissue the request.

System programmer response: Ensure that the correct LINE, NODE, and SOCKET definitions are included in the JES2 initialization parameters, or define them dynamically through \$ADD or \$T operator commands.

Module: HASPTCP

Routing Code: 1,2,10

Descriptor Code: 4

\$HASP566

Explanation:

▶▶<DCT|SCK>—ATTACH FOR—*devname*—FAILED, RC=—*nnnnnnn*————▶▶

On a hot start, JES2 was unable to create a LINE, NETSRV, or SOCKET that was previously active.

System action: JES2 initialization is terminated. You might need to perform an IPL to restart JES2.

Operator response: Contact system programmer.

System programmer response: Contact IBM service.

Module: HASPIRPL

Routing Code: 1,2,10

Descriptor Code: 4

\$HASP567

Explanation:

▶▶—NETSRV—*nnn*—INCORRECT SOCKET -- —<NOT SPECIFIED, RC=01>—<—*name*—IS ACTIVE, RC=02>————▶▶

▶<—*name*—SPECIFIES A NON-LOCAL NODE=VALUE, RC=03>————▶▶

A NETSRV was defined in the initialization deck, or was attempted to be started through the \$S command that either contains a null SOCKET= value (RC=01), a SOCKET= value that is currently being used by another NETSRV device (RC=02), or a SOCKET= value that specifies a NODE other than the local node (RC=03).

System action: JES2 fails the start of the NETSRV device.

Operator response: Contact system programmer.

System programmer response: Verify that the correct initialization SOCKET= values are specified on the NETSRV initialization statement.

Module: HASPIRRE, HASPTCP

Routing Code: 1,2,10

Descriptor Code: 4

\$HASP568

Explanation:

device/nodename - AUTOMATIC CONNECT

device - AUTOMATIC RESTART

If the message contains CONNECT, JES2 NJE processing is attempting to establish an NJE connection on the listed device or NJE node. If the message contains RESTART, JES2 is attempting to restart the listed device. In the message text:

device Name of the device being used to make the connection or being restarted

nodename
Name of the node being connected to

System action: A \$SN is simulated on the device or to the node name listed. Additional messages will be issued to indicate the success or failure of the connection (same messages as are issued in response to a \$SN command.)

Operator response: This message is informational, no specific response is needed.

System programmer response: This message is informational and indicates that a connection is being attempted or a device is being restarted. If the connection is failing or if the destination no longer exists, alter the setting of

\$HASP569

CONNECT= on the device or node listed in the message. To diagnose a failed connection or restart, see descriptions of subsequent messages.

Module: HASPNRM, HASPMSG

Routing Code: 1,2,10

Descriptor Code: 4

\$HASP569

Explanation:

device - error text

JES2 NJE processing encountered an error when attempting to establish an NJE connection on the device listed. In the message text:

device Name of the device being used to make the connection

error text

Description of error based on interface type. For BSC, the error text is from \$HASP675, \$HASP676, \$HASP677, \$HASP678. For SNA, the error text is from \$HASP679. For TCP/IP, the error text is from \$HASP670.

BSC error text

LINE IS BUSY
SYSTEM RESOURCE SHORTAGE BUFFERS
SYSTEM RESOURCE SHORTAGE NETLINES
INTERNAL ERROR
LINE IS NOT TRANSPARENT BISYNCH LINE
SECURE SIGNON FAILED, APPCLU CLASS INACTIVE

SNA error text

JES2/VTAM INTERFACE INACTIVE, RC=01
LINExxxx IS NOT A SNA/VTAM LINE, RC=02
LINExxxx IS NOT ACTIVE, RC=03
LINExxxx IS BUSY, RC=04
NO IDLE SNA LINE IS AVAILABLE, RC=05
applxxxx IS NOT A DEFINED APPL OR NODE, RC=06
nodexxxx IS THE LOCAL NODE, RC=07
ALREADY IN SESSION WITH applxxxx, RC=08
MAXIMUM SESSIONS ALREADY ACTIVE, RC=09
NO STORAGE AVAILABLE FOR APPL, RC=10
THE NODE FOR APPL applxxxx IS INVALID, RC=11
DEDICATED LINE LINExxxx IS NOT AVAILABLE, RC=12
NETWORK PATH MANAGER IS NOT AVAILABLE, RC=13

TCP/IP error text

TCP/IP INTERFACE NOT ACTIVE, RC=01
SOCKET socketnm IS NOT AVAILABLE, RC=02
ALREADY IN SESSION WITH socketnm, RC=03
LINEnnnn IS NOT A TCP/IP LINE, RC=04
DEDICATED LINE LINEnnnn IS NOT AVAILABLE, RC=05
NETWORK PATH MANAGER IS NOT AVAILABLE, RC=06
nodennnn IS THE LOCAL NODE, RC=07
NO IDLE TCP/IP LINE IS AVAILABLE, RC=08
RESOURCE SHORTAGE xxxxxxxx, RC=09
NETWORK PATH MANAGER INTERNAL ERROR, RC=10
SERVER NETSRVxx IS NOT ACTIVE, RC=11
SERVER NETSRVxx IS NOT AVAILABLE, RC=12
LINE LINEnnnn IS NOT AVAILABLE, RC=13
SECURE SIGNON FAILED, APPCLU CLASS INACTIVE, RC=14
SOCKET socketnm DOES NOT SPECIFY A VALID IPADDR, RC=15

System action: The attempt to automatically start an NJE connection fails. Another attempt will be made based on the value of *interval* on CONNECT= statement on the device.

Operator response: The exact reason for the failure is described in the error text. For more information on possible actions to correct the problem, see the corresponding BSC, SNA, or TCP/IP message. If the problem cannot be corrected, adjust the value of CONNECT= statement on the listed device.

System programmer response: See operator response.

Module: HASPNRM, HASPMSG

Routing Code: 1,2,10

Descriptor Code: 4

\$HASP579

Explanation:

▶▶—GETMAIN FAILED DURING DYNAMIC—ALLOCATION ERROR PROCESSING—▶▶

Following an error in the allocation of the offload data set, the offload subtask failed to obtain storage in which to place the dynamic allocation error message text.

System action: JES2 drains the offload device. Other JES2 processing continues.

Operator response: Notify the system programmer.

System programmer response: Determine why there is insufficient storage in the JES2 address space and correct the error.

Module: HASPSTAM

Routing Code: 2,10

Descriptor Code: 4

\$HASP580

Explanation:

▶▶—DYNALLOC FAILED FOR OFFLOADn— --RC=—rc eeeiii—
└—formatted error message—┘▶▶

A dynamic allocation error occurred for the specified device. In the message text:

- n** The number of the offload device.
- rc** The dynamic allocation return code from register 15.
- eeee** The dynamic allocation error code (S99ERROR).
- iiii** The information reason code (S99INFO) from dynamic allocation.

formatted error message

The error message created by the TSO DAIRFAIL routine. It contains the TSO DAIRFAIL IKJxyyn message number.

Note: If an error occurred in TSO DAIRFAIL processing, only the codes are displayed.

System action: JES2 drains the offload device and continues processing.

Operator response: Notify the system programmer.

System programmer response: See *z/OS MVS Programming: Authorized Assembler Services Guide* for an explanation of each code. Correct the problem using the diagnostic information obtained.

Module:

HASPSTAM

Routing Code: 2,10

\$HASP581 • \$HASP582

Descriptor Code: 4

\$HASP581

Explanation:

▶▶—MEMBER—*member-name* — — DYNAMIC ALLOCATE FAILED FOR—*device*—RC=—*rc*—S99ERROR=—*eeee*————▶▶
▶—S99INFO=—*iiii*—*formatted-text*————▶▶

A dynamic allocation request failed. In the message text:

member-name

The name of the JES2 member that experienced the error

device The JES2 logical device that experienced the error

rc The return code from dynamic allocation (DYNALLOC) returned in R15

eeee The DYNALLOC error code (in hexadecimal in the S99ERROR field of the DYNALLOC parameter list)

iiii The DYNALLOC error information code (in hexadecimal in the S99INFO field of the DYNALLOC parameter list)

formatted-text

An explanation from the TSO DAIRFAIL service of why the allocation failed. The corrective actions provided in this formatted text are expressed in terms that might only be applicable in a TSO environment; be certain to use the corresponding MVS or JES2 action. If this message is preceded by \$HASP253 or if an error occurred in the service that generates the formatted text, this *formatted-text* is **not** displayed.

System action: JES2 processing continues without allocating the device. If a JES2 checkpoint reconfiguration is in progress, the operator is prompted for an alternative action.

Operator response: If a JES2 checkpoint reconfiguration is in progress, specify another data set name or volume serial as appropriate.

System programmer response: See *z/OS MVS Programming: Authorized Assembler Services Guide* for an explanation of the DYNALLOC error and information codes. Correct the problem using the diagnostic information obtained.

Module: HASPNUC

Routing Code: 2,10

Descriptor Code: 4

\$HASP582

Explanation:

▶▶—OFFLOAD—*n*—RECEIVERS—

DRAINED
DRAINING

— — OFFLOAD—*n*—IS HALTED————▶▶
▶— — OFFLOAD—*n*—TRANSMITTERS DRAINED— — OFFLOAD—*n*—IS ACTIVE————▶▶

Either a \$S command was entered for the indicated offload device and no receivers/transmitters are able to be started, or a \$P command was entered for each active receiver while the reload operation was in progress.

In the message text:

n The number of the offload device.

System action: If this message is issued during a reload (RECEIVE) operation, the offload device remains halted until you start at least one receiver. You must then restart the offload device to restart the reload operation.

If this message is issued during an offload (TRANSMIT) operation, the offload device remains active and will begin transmitting when one of the offload transmitters has been started.

Operator response: Enter the \$S command for a receiver/transmitter. If the reload operation was in progress, enter

the \$S command for the offload device to restart the operation, or enter the \$P command for the offload device to stop the reload operation.

Module: HASPSTAM

Routing Code: 1,2

Descriptor Code: –

\$HASP587

Explanation:

►► I/O ERROR READING FROM *n* —————
 └─ MAXIMUM EXCEEDED ─┘

An I/O error has occurred while reading from the offload data set.
 In the message text:

n The number of the offload device.

System action: If a pre-processing job is being read, the job in error is purged. If the error occurs while SYSOUT data sets are being read, any data already received will be kept.

If the maximum limit of 10 consecutive errors per reload operation has been exceeded, JES2 automatically drains the offload device. If the maximum limit has not been exceeded, the reload process continues with the next job.

Operator response: None.

Module: HASPSTAM

Routing Code: 1,2

Descriptor Code: –

\$HASP588

Explanation:

►► *jobname* —————
 └(—*jobid*—FROM—*nnnnnnnn*—)┘ └OFFLOADED┘ └AT—*nodename*┘
 └LOADED┘

► *ON—yyyy.ddd* —————
 └FROM—*yyyy.ddd*—DUMP┘

The indicated job has been written to or read from the spool offload data set.

In the message text:

jobname The job name.

jobid The job identifier on the input node.

nnnnnnnn The input node name. This information is displayed only if *nodename* is not the input node.

nodename The node of the system on which the offload occurred. This information is displayed only if the node name is not the input node.

yyyy.ddd The year (*yyyy*) and julian day of the year (*ddd*) the offload took place. **ON** *yyyy.ddd* is displayed when the job is offloaded and **FROM** *yyyy.ddd* **DUMP** is displayed when the job is reloaded.

Note:

\$HASP589

1. This message only appears if NOTIFY=userid was specified on the JCL JOB statement or NOTIFY was requested on the JECL statement and if the installation specified NOTIFY=YES for the offload job transmitter/receiver.
2. The jobid referencing the current JES2 jobid on this system may precede \$HASP588. See "JES2 message format" on page 1.

System action: Processing continues.

Operator response: None.

Module: HASPNJT, HASPRDR

Routing Code: 1,2

Descriptor Code: -

\$HASP589

Explanation:

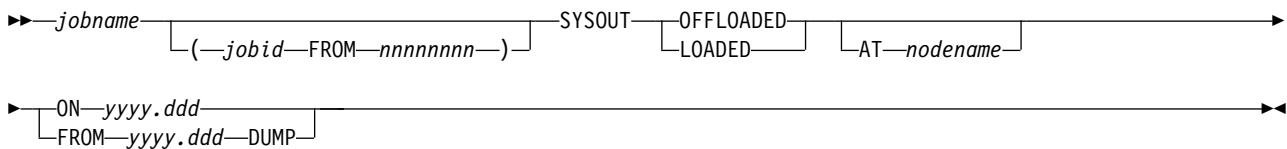

jobname [(*jobid* FROM *nnnnnnnn*)]
SYSOUT { OFFLOADED } { LOADED }
[AT *nodename*] { ON *yyyy.ddd* }
{FROM *yyyy.ddd*}

The indicated job's output has been written to or read from the spool offload data set.

In the message text:

jobname

The job name.

jobid The job identifier on the input node.

nnnnnnnn

The input node name. This information is displayed only if the node name is not the input node.

nodename

The node name of the system on which the offload occurred. This information is displayed only if the node name is not the input node.

yyyy.ddd

The year (yyyy) and julian day of the year (ddd) the offload took place. ON *yyyy.ddd* is displayed when the job is offloaded and FROM *yyyy.ddd* DUMP is displayed when the job is reloaded.

Note:

1. This message only appears if NOTIFY=userid was specified on the JCL JOB statement or if NOTIFY was requested on the JECL statement and the installation specified NOTIFY=YES for the offload SYSOUT transmitter/receiver.
2. The jobid referencing the current JES2 jobid on this system may precede \$HASP589. See "JES2 message format" on page 1.

System action: Processing continues.

Operator response: None.

Module: HASPNSR, HASPNST

Routing Code: -

Descriptor Code: –

\$HASP590

Explanation:

▶▶—ERROR READING PAST END OF—OFFLOADn—DATA SET—▶▶

During a reload operation, JES2 attempted to read past the end of the indicated offload data set. In the message text:

n The number of the offload device.

System action: JES2 drains the indicated offload device and purges any jobs in progress.

Operator response: None.

Module: HASPSTAM

Routing Code: 1,2

Descriptor Code: –

\$HASP591

Explanation:

▶▶—I/O ERROR READING FROM—OFFLOADn DATA SET – —POSSIBLE DATA LOSS—▶▶

An I/O error has occurred while reading a SYSOUT data set from the indicated offload data set. In the message text:

n The number of the offload device.

Note: This message is appended to the SYSOUT data set with the error.

System action: Any SYSOUT data already received will be kept. If this is the eleventh consecutive error to occur for this reload operation, JES2 automatically drains the offload device. If less than 11 errors have occurred, the reload process continues with the next job.

User response: Check your SYSOUT data sets for a possible loss of data. If necessary, resubmit the job.

Module: HASPNSR

Routing Code: 11

Descriptor Code: 6

\$HASP593

Explanation:

▶▶—OFFLOADn—START—REJECTED – DEVICE—ALREADY IN USE—(*sysid*)—▶▶

The operator entered a \$\$ command for an offload device that is currently in use on this system or on another member of the multi-access spool configuration. In the message text:

n The number of the offload device.

sysid The system identifier.

System action: JES2 rejects the command and the device currently in use continues processing.

Operator response: Enter the \$\$ command for another offload device, or drain the currently active device and reenter the \$\$ command for that device.

System Messages, Vol 7 (IEB-IEE) for a description of the accompanying IEE328I message and further diagnostic information. If none of the above diagnostic procedures correct the problem, contact the IBM Support Center for assistance and provide the appropriate *rc* from the message text. When the problem is corrected, restart the initiator through a \$SI command.

Module: HASPXEQ

Routing Code: 1,2,10

Descriptor Code: 4

Chapter 10. Six-hundreds

The following JES2 messages are numbered in the 600-699 range.

\$HASP600

Explanation:

▶▶—AUTOMATIC COMMAND LIMIT REACHED—▶▶

The operator entered a \$TA command, however all installation-specified automatic command elements were found to be in use.

System action: Processing continues.

Operator response: Delete some of the current elements or wait until elements are no longer needed. Inform the system programmer that additional elements are needed.

Module: HASPCOMM

Routing Code: #

Descriptor Code: –

\$HASP601

Explanation:

▶▶—AUTOMATIC COMMANDS HALTED BY—*type*—▶▶

When the operator entered a \$TA command the system found that either the operator has halted the issuing of automatic commands using a \$ZA command or the system automatically issued the \$ZA command. The system will automatically issue a \$ZA command when:

- A backlog exists that prevents JES2 from issuing an automatic command for 5 minutes because it is out of CMBs.
- You alter the time forward by more than 24 hours, or backward by any time period.
- Automatic command processing is left dormant for more than 24 hours.

In the message text:

type Either OPERATOR or SYSTEM. If SYSTEM is displayed, this is an action message until automatic command processing is started with the \$\$ A,ALL command.

System action: The command is ignored. Processing continues.

Operator response: Verify that the current automatic command elements are correct and, if required, enter a \$\$ A,ALL command to begin automatic command issuing.

Module: HASPCOMM

Routing Code: 1-10/#

Descriptor Code: 2,-

\$HASP603

Explanation:

▶▶—*devname*—STATUS=—*status*, —(active job), nn(mm) outtyp,—*list-of-keywords*—▶▶

\$HASP603

Where *status* is one of the following:

ACTIVE
ALLOCATED
BUSY
DRAINED
DRAINING
ENDED
HALTED
INACTIVE
INTERVENTION
NOT RESPONDING
NOT RESPONDING, INTERVENTION
PAUSED
STARTING

The operator entered a \$DU command or a \$T command for a device. JES2 has responded with information regarding the subsystem assigned to or in control of the device, and the current output selection criteria.

In the message:

devname

The name of the device as assigned in the JES2 initialization stream unless the JES2 command was issued from a remote console. In that case, if the *devname* was used in the command, then *devname* will appear in \$HASP603. If *devname* was not used in the command then *devname* will NOT appear in \$HASP603. For example,

From a remote console

\$T PR2,C=B yields \$HASP603 PR2,STATUS=.....

Note: No remote *devname* is displayed.

\$T R475,PR2,C=B yields \$HASP603 R475,PR2,STATUS=.....

Note: *devname* (R475) is displayed.

(active job)

Is the job identification and job name of the job the device is currently processing. An example of (*active job*) is (STC00061 MOUNT).

nn Total number of output images left to process in the current job.

mm The total number of output images for this job.

outtyp The type of output images this device is currently processing. *outtyp* can be **LINES**, **CARDS**, or **PAGES**.

The line count includes only records with a non-zero text length and which do not use immediate machine control characters.

The page count includes begin page structured fields only. Other AFP control records (records that start with the X'5A' control character) are not included in either the record or page count.

status is one of the following:

ACTIVE

JES2 is using the device for job processing and will continue to do so if there are jobs available and eligible for that device.

ALLOCATED

The INTRDR has been created by the job/aside indicated in the OWNER field.

BUSY A device in FSS mode is unable to respond with the current status because a previous command is being processed for this device.

DRAINED

JES2 is not using the device and will not do so until the device is started using a \$S command.

DRAINING

JES2 is currently using the device for the processing of jobs, but will discontinue its use upon completion of the current function.

ENDED

A non-recoverable ABEND occurred during processing for this device. JES2 has suspended all processing for this device. At the time the device was suspended, work might still have been assigned to the device. All processing on that work has also been suspended. You need to perform a JES2 hot start to recover the device and any work assigned to it.

HALTED

JES2 has either requested operator assistance or the operator has halted the device (\$Z) and is waiting for the device to be started using a \$S command.

INACTIVE

JES2 is not using the device but would do so if jobs were available and eligible for that device.

INTERVENTION

An FSS-controlled printer requires operator intervention.

NOT RESPONDING

The FSA informed JES2 that the device is no longer responding to the FSA.

NOT RESPONDING, INTERVENTION

The FSA informed JES2 that the device is no longer responding to the FSA. Device intervention is required. To determine why the device is not responding, check the device or the communication components (for example, VTAM).

PAUSED

JES2 has paused between jobs during printing or punching. The specified device will not be used until it is started (\$S command) or it has been reset from a not-ready to a ready state.

STARTING

The device is in the process of being started. This status is only possible for FSS-owned devices and initiators.

list-of-keywords is a combination of the following:

AUTH

Specifies the JES2-authority level for commands entering the system from this device.

DEVICE

Specifies whether commands that affect devices are authorized to enter the system from this device.

HONORTRC=

Specifies whether (YES) or not (NO) the JES-mode printer honors the TRC=Yes|No parameter specification on the job's OUTPUT JCL statement.

JOB

Specifies whether commands that affect jobs are authorized to enter the system from this device.

SYSTEM

Specifies whether commands that affect system resources (for example, initiators) are authorized to enter the system from this device.

This keyword only applies for local readers.

BURST={YES|NO}

Specifies whether the printed output from a 3800 printer is to be burst into separate sheets. This keyword is blank for impact printers.

This keyword only applies for local printers.

CCTL={YES|NO}

Specifies whether JES2 places carriage control characters in the output stream transmitted to this device.

This keyword only applies to remote printers and punches.

\$HASP603

CHAR(*d*)

The character set(s) currently in use on this printer. This keyword can appear multiple times. The value of *d* starts at **1** and increases for each character set the printer is using. This keyword is blank for impact printers.

This keyword only applies for local printers.

CKPTLINE

The maximum number of lines in a logical page. JES2 uses this value together with the value of CKPTPAGE to determine when to checkpoint the output data sets.

This keyword only applies for local and remote printers and punches.

CKPTMODE={PAGE|SEC}

This keyword specifies the method JES2 is using to checkpoint output on this printer. Valid values for this keyword are **PAGE** and **SEC**. This keyword is **PAGE** for impact printers.

This keyword only applies for local printers.

CKPTPAGE

Specifies the number of pages after which JES2 will checkpoint the output data set.

This keyword only applies for local and remote printers and punches.

CKPTSEC

Specifies the number of seconds after which JES2 will checkpoint the output data set. The value of this keyword is zero for impact printers.

This keyword only applies for local printers.

CLASS

Specifies the job class assigned to jobs that enter the system on this device which do not have the CLASS parameter on the JOB JCL statement.

This keyword only applies for local and remote readers.

CMPT={YES|NO}

Specifies whether a JES2 is capable of compacting data sent to a remote system network architecture (SNA) device. This keyword is **NO** for remote binary synchronous communication (BSC) devices.

This keyword only applies to remote printers and punches.

COMPRESS={YES|NO}

Specifies whether JES2 is capable of compressing data sent to a remote SNA device. This keyword is **NO** for remote BSC devices.

This keyword only applies to remote printers and punches.

COMPACT

Specifies the number of the compaction table JES2 is using for this device. A value of **0** for this keyword means that there is no compaction occurring on this device.

This keyword only applies to remote printers and punches.

COPYMARK={DATASET|JOB|CONSTANT|NONE}

Specifies when this printer is incrementing the copy marks. This keyword is **DATASET** for impact printers.

This keyword only applies for local printers.

CREATOR

Specifies the user identification that created the output that this device is selecting. If this keyword is not explicitly set, the value is blank.

This keyword only applies for local and remote printers and punches.

DEVFCB

Specifies the 1- to 4-character name of the forms control buffer (FCB) that this printer is using as a default. If this keyword is not explicitly set, the value is blank.

This keyword only applies for local printers.

EJECT={YES|NO}

Specifies whether JES2 sends a page eject to a remote printer on the printer's first use following the start of an

RJE session depending upon the assumed position of the printer. JES2 assumes that the remote printer is not positioned at the top of a page on the first use after JES2 is started, restarted, or after a remote session fails and the remote printer is not at the top of a page.

This parameter should be **NO** if this is a remote work station that writes SYSOUT to media other than paper and does not need a page eject in the first line.

This keyword only applies to remote printers. ENDED JES2 encountered an abend in a situation where no active recovery (\$ESTAE) existed. At the time of the abend, the device PCE in control is not considered a required PCE for continued JES2 operations. The device PCE is marked ENDED and JES2 has permanently suspended the device PCE. To recover the device, restart JES2.

DEVFLASH

The 1- to 4-character name of the forms FLASH ID that JES2 is using for this printer.

This keyword only applies for local printers.

This keyword is blank for any of the following:

- If the printer does not have a forms FLASH ID specified
- If this printer is not capable of forms flashing
- If this is an impact printer.

FCB

Specifies the 1- to 4-character forms control buffer (FCB) image or the carriage control tape name that is mounted on this printer.

STD indicates that the FCB image has been marked "STANDARD" in SYS1.IMAGELIB. If the FCB is the same as the DEVFCB setting, then **DEFAULT** is displayed. **DEFAULT** and **STD** are mutually exclusive; they appear as follows:

DEVFCB= specified?	DEVFCB=C?	C=STANDARD?	Resulting FCB
no	N/A	no	(none)
no	N/A	yes	,STD
yes	no	no	(none)
yes	no	yes	(none)
yes	yes	no	,DEFAULT
yes	yes	yes	,DEFAULT

This keyword only applies for local and remote printers.

FCBLOAD

Specifies that whether JES2 provides FCB support for this remote printer.

This keyword only applies to remote printers.

FLASH

The 1- to 4-character name of the forms FLASH ID that JES2 is using for this printer. This keyword is blank if the printer does not have a forms FLASH ID specified or if this printer is not capable of forms flashing.

This keyword is blank for impact printers.

This keyword only applies for local printers.

FLUSH={YES|NO}

Specifies whether JES2 punches a blank card following each data set or data set copy processed by this device.

This keyword only applies to remote punches.

FORMS

Specifies the 1- to 8-character forms identifiers that are loaded on this device. There can be up to 8 forms identifiers loaded.

This keyword only applies for local and remote printers.

FSAROLTR={YES|NO}

Specifies whether the internal rolling trace for an FSS printer is active for this device.

\$HASP603

FSS

The name of the FSS that controls this printer.

This keyword only applies to local printers.

HOLD={YES|NO}

Specifies whether jobs entering the system on this device are to be held until the operator releases the job for processing.

For lines, this keyword specifies whether JES2 is holding a particular network transmitter or receiver.

This keyword only applies to local and remote readers and lines.

HONORTRC={YES|NO}

Specifies whether the TRC=YES|NO parameter specified on the job's OUTPUT JCL statement will be honored or not honored for a given JES—mode printer. HONORTRC= only applies to JES mode printer.

A JES—mode printer (other than 3800 printers) strips off (ignores) the table reference character if HONORTRC=YES and TRC=YES is specified for SYSOUT.

JOBNAME

Specifies the jobname for jobs to be selected by this device.

Note:

1. If the jobname was coded after the slash in the work selection (WS=) list, the jobname displayed may vary depending on the output group being processed.
2. If no jobname was assigned, the JOBNAME= field displays the name of the job currently on the device.

This keyword only applies for local and remote printers and punches.

LASTFORM

The FCB previously used to process output on this printer.

This keyword only applies to local printers.

LIMIT

Specifies the lower and upper record limits for jobs that this device will process. A limit of (0,*) means that this device selects all output.

This keyword only applies for local and remote printers and punches and SYSOUT transmitters.

LRECL

Specifies the logical record length of the data transmitted to this remote SNA device.

This keyword is blank for BSC devices and only applies to remote printers and punches.

MARK={YES|NO}

Specifies whether this printer is marking the edge of the separator page. The value of this keyword is **NO** for impact printers.

This keyword only applies to local printers.

MODE={JES2|FSS}

Specifies that this printer is either JES2-managed (JES2) or functional subsystem-managed (FSS).

This keyword only applies to local printers.

MODIFY

The name of the character set that contains any modifications to the character set(s) currently in use on this printer. This keyword is blank for impact printers.

This keyword only applies to local printers.

MSGCLASS

Specifies the message class assigned to jobs that enter the system on this device which do not have the MSGCLASS parameter on the JOB JCL statement.

This keyword only applies to local, remote and internal readers.

NEWPAGE

Specifies when JES2 treats a 'skip to channel' as a new page.

This parameter only applies to local and remote printers.

NPRO

The number of seconds that output remains in the paper path after which the functional subsystem (FSS) forces the output to the stacker. This keyword is only valid for FSS-managed 3800-3 model printers.

OWNER

Specifies the name and identifier of the job that opened the internal reader. If there is no job identifier, the value of this keyword is N/A. If the internal reader is idle, the value is (.).

This keyword is only valid for internal readers.

PAUSE={YES|NO}

Specifies whether this device pauses between data set groups.

This keyword only applies to local printers and punches.

PLIM

Specifies the lower and upper page limits for jobs that this printer will process. A **PLIM** of (0,*) means that this device selects all output.

This keyword applies to local printers, remote printers and SYSOUT transmitters.

PRESELECT={YES|NO}

Specifies whether this printer keeps two output elements for processing while the printer is active. This keyword is NO for JES2-managed printers.

This keyword only applies to local printers.

PRTYINC

Specifies a number that JES2 adds to the selection priority of each job that enters the system on this device.

This keyword only applies to local and remote readers.

PRTYLIM

Specifies the maximum priority level that JES2 can assign to jobs entering the system on this device.

This keyword only applies to local, remote and internal readers.

PRMODE

Specifies the names JES2 uses to direct output data sets to this device. Up to eight names can appear for this keyword.

This keyword only applies to local and remote printers and punches.

PRTDEST

Specifies the print destination for printed output from jobs that entered the system on this device without a /*ROUTE statement or a DEST parameter on the DD JCL statement or OUTPUT JCL statement.

This keyword only applies to local, remote and internal readers.

PRWIDTH

Specifies the number of characters to be printed on one line.

This keyword only applies to remote printers.

PUNDEST

Specifies the punch destination for punched output from jobs that entered the system on this device without a /*ROUTE JES2 control statement or a DEST parameter on the DD JCL statement or OUTPUT JCL statement.

This keyword only applies to local, remote and internal readers.

QUEUE

Specifies the output classes this device can process. Up to 15 classes can appear on this keyword.

This keyword only applies to remote and local printers and punches.

RANGE

Specifies the range of job identifiers that this device can select.

\$HASP603

This keyword only applies to remote and local printers and punches.

ROUTECD

Specifies the routing codes assigned to this device. A maximum of four routing codes may be assigned.

This keyword only applies to remote and local printers and punches.

SELECT

Specifies the device type and device subaddress to which JES2 sends output queued to this remote device.

This keyword only applies to remote printers and punches.

SEP={YES|NO}

Specifies whether this device initially provides separator pages between output data set groups.

This keyword only applies to remote and local printers and punches.

SEPCHARS

Specifies the character set to use for separator pages on this device. Values for this keyword are:

CURRENT

Specifies that JES2 is using whatever character set is currently loaded on this device when printing separator pages.

DEFAULT

Specifies that JES2 is using the default character set for this device when printing separator pages.

This keyword only applies to local printers.

SEPDS

Specifies whether this device creates data set separator pages for data sets within the job output elements (\$JOE) selected for processing by this device.

This keyword only applies to remote and local printers and punches.

SETUP={HALT|NOHALT}

Specifies whether JES2 halts this device and issues message \$HASP190 after a change of device characteristics.

This keyword only applies to remote and local printers and punches.

SPACE

Specifies the spacing between lines of output.

This keyword only applies to local printers.

SUSPEND={YES|NO}

Specifies whether the device-interrupt feature is active.

This keyword only applies to remote printers and punches.

SYSAFF

Specifies the system(s) in the multi-access spool (MAS) configuration that jobs entering the system on this device can run if SYSAFF is not specified on the /*JOBPARM JES2 control statement.

This keyword only applies to local and remote readers.

TRACE={YES|NO}

Specifies whether tracing is active for this device.

TRKCELL={YES|NO}

Specifies whether JES2 deSPOOLS an entire track cell for processing by this printer. This keyword is **NO** for impact printers.

This keyword only applies to local printers.

UCS

For impact printers, this keyword specifies the universal character set (UCS) in SYS1.IMAGELIB that JES2 is using for this printer. The UCS must match the print train currently mounted on this printer.

For non-impact printers, this keyword specifies the character set that JES2 initially loads into the printer.

A value of **0(STD)** for this keyword indicates that JES2 has not loaded the buffer, but will use a UCS marked as STD in SYS1.IMAGELIB to process output for this printer.

This keyword only applies to local and remote printers.

UCSVERIFY={YES|NO}

Specifies whether JES2 is to perform UCS verification processing when a UCS image is loaded for a 4250 or 4248 printer.

This keyword is **NO** for printers other than local 4250 or 4248 printers.

UNIT={dev|SNA}

Specifies a 4-digit hexadecimal device number assigned to this device. For system network architecture (SNA) networking lines, the value of UNIT is **SNA**.

VOLUME

Specifies 1- to 4-spool volumes from which this device can select output. If this keyword is (**,,,**) the device can select from all spool volumes.

This keyword only applies to local and remote printers and punches.

WRITER

Specifies the writer name assigned to this device.

This keyword only applies to local and remote printers and punches.

WS Specifies the work selection characteristics for this device.

Some of the devices that this keyword applies to include local and remote printers and punches, spool offload devices and the network SYSOUT transmitters.

XEQDEST

Specifies the node at which jobs entering the system on this device will run if a **/*ROUTE** or **/*XEQ** JES2 control statement is not present in the job stream.

This keyword only applies to local, and remote readers.

System action: The system continues processing.

Operator response: None.

Module: HASPIRPL

Routing Code: #

Descriptor Code: -

\$HASP604

Explanation:

▶▶—ID—xxxx—T=—hh.mm.ss—I=—ssss—L=—console—text————▶▶

The operator entered a \$TA command and the response indicates the contents of the command element being created, displayed, modified, or deleted. If the operator is attempting to alter or create an automatic command element and a diagnostic message precedes this message, the element will be deleted.

The fields in the message text are:

xxxx The user-defined or system-defined automatic command identifier.

hh.mm.ss

Time of the current day to enter the command(s) indicated by *text*.

ssss Time interval between each command.

console

The 2- to 8-character console name and optional console area specified in the automatic command. This parameter only affects the response to the \$TA command. To redirect the response to the automatic command, you must specify an *L=console* within the quotes of the command text.

text The command(s) to enter at the time indicated.

\$HASP606 • \$HASP607

System action: Processing continues.

Operator response: None.

Module: HASPCOMM

Routing Code: #

Descriptor Code: –

\$HASP606

Explanation:

▶▶—INSUFFICIENT OPERANDS—▶▶

The operator entered a command without specifying all of the required operands.

System action: The command is ignored and processing continues.

Operator response: Enter the corrected command. See *z/OS JES2 Commands*.

Module:

HASPCOMM

Routing Code: #

Descriptor Code: –

\$HASP607

Explanation:

▶▶—JES2 NOT DORMANT – MEMBER DRAINING,—PJES2,TERM NOT ALLOWED AT THIS TIME,—RC=*rc text*—▶▶

The operator entered a \$P JES2 command or a \$P JES2,TERM command to withdraw JES2 from the system, but not all of JES2's functions have completed.

In the case of a \$P JES2 command, JES2 deletes this message from the console when either all JES2 activity has completed, or a \$S command is entered to resume JES2 processing.

In the case of a \$P JES2,TERM command, the message is just issued as a response to the command.

See the \$HASP608 message for a more detailed list of activity causing JES2 not to be withdrawn.

In the message text:

rc The return code.

text The explanatory text accompanying the return code.

Possible values of *rc* and *text* are:

rc *text*

01 OUTSTANDING I/O

02 OUTSTANDING WTO ACTIVITY

03 ACTIVE PROCESSORS

04 OUTSTANDING HELD PROCESSORS

05 INTERNAL READERS ARE ALLOCATED

06 OUTSTANDING CROSS MEMBER REQUESTS

07 OUTSTANDING SPIN ACTIVITY

08 PROCESSOR(S) ENDED BY PRIOR RECOVERY.

{SOME ENDED PROCESSORS HAVE BEEN DETACHED}

\$PJES2,ABEND IS REQUIRED TO TERMINATE JES2

- 09 OUTSTANDING PSO, SAPI OR END OF MEMORY ACTIVITY
- 10 ACTIVE ADDRESS SPACES
- 11 ACTIVE NETWORKING DEVICES
- 12 COMMAND PROCESSING ACTIVE
- 13 ACTIVE SPOOL MIGRATION
- 14 CHECKPOINT RECONFIGURATION IN PROGRESS

System action: JES2 is not withdrawn and no new functions will be started; however, jobs can continue to be entered.

Operator response: Evaluate the details listed by the \$HASP608 message. This applies to all return codes.

For return codes 1 through 7, stop all JES2 functions (that is, drain all devices, lines, initiators, and stop all jobs), then reenter the \$P JES2 command.

For RC=03, issue the \$DPCE,ACTIVE>0 command to determine what PCEs have active work.

For RC=06, if necessary, enter a \$P JES2,QUICK to have JES2 ignore these requests when withdrawing.

For RC=08, the \$P JES2,ABEND command is required to end JES2.

For RC=09, you might be experiencing a temporary state or it might indicate that an address space is still actively making requests of JES2. If the condition does not clear and is the only reason code listed, then this is likely a system address space (request jobID). Issue a \$DA,STC command to display all remaining address spaces. One of these is probably still actively requesting JES2 services.

For RC=10, issue the \$DA,X command to get a list of active address spaces.

For RC=12, the alternate command processor is actively processing a command. The processor might be waiting for a module to load. Check for GRS contention on any data sets that are in the JES2 STEPLIB or in the link list concatenation.

For RC=13, if necessary, enter the \$MSPL(*source_volume*),CANCEL command to cancel the migration. However, a specific migration might not be eligible for cancellation.

For RC=14, a checkpoint reconfiguration is in progress and must be completed.

Module: HASPCOMM

Routing Code: 1,2,10

Descriptor Code: 2,5,7

\$HASP608

Explanation:

ACTIVE PROCESSORS (PCES)

NAME	COUNT	JOBID
<i>pcename/devname</i>		<i>nnn jobid</i>

ACTIVE ADDRESS SPACES

ASID	JOBNAME	JOBID
<i>asid</i>	<i>jobname</i>	<i>jobid</i>

ACTIVE NETWORKING DEVICES

NAME	STATUS
<i>devname</i>	<i>status</i>

HELD PROCESSORS

NAME
<i>pcename/devname</i>

ALLOCATED INTERNAL READERS

ASID	JOBNAME	JOBID
<i>asid</i>	<i>jobname</i>	<i>jobid</i>

\$HASP608

OUTSTANDING CROSS MEMBER REQUESTS

ASID	JOBNAME	JOBID	COUNT
-----	-----	-----	-----
<i>asid</i>	<i>jobname</i>	<i>jobid</i>	<i>nnn</i>

OUTSTANDING BERT LOCK REQUESTS

JOBNAME	JOBID	LOCKED BY
-----	-----	-----
<i>jobname</i>	<i>jobid</i>	<i>member name</i>

INTERNAL ACTIVITY

TYPE	COUNT
-----	-----
TOTAL PCE I/O	<i>nnn</i>
SAPI REQUESTS (SSI 79)	<i>nnn</i>
PSO REQUESTS (SSI 1)	<i>nnn</i>
END OF MEMORY REQUESTS(EOM)	<i>nnn</i>

OUTSTANDING WTO ACTIVITY

OUTSTANDING SPIN ACTIVITY

PROCESSOR(S) ENDED BY PRIOR RECOVERY

COMMAND PROCESSING ACTIVE

There are the following two alternate forms of the message other than the previous table of activity:

1. ALL AVAILABLE FUNCTIONS COMPLETE

JES2 issues this form of the message as a response to a \$DJES2 command when there is no activity to display.

2. xPJES2 COMMAND ACCEPTED

JES2 issues this form of the message after you issue a \$PJES2 command and the command is accepted. The x is the CONCHAR of the member that issued the \$PJES2 command.

JES2 issues this message as a response to a \$DJES2 command or as a response when a \$PJES2 command is rejected. The message will list the specific reasons why JES2 cannot be withdrawn.

In the message text:

pcname

Long descriptive name of PCE

nnn Count of activity

asid Address space identifier

jobname

Name of the job

jobid Job identifier

devname

Device name associated with PCE

status Device status

member name

The name of the member of the JES2 MAS

System action: If received as a response to a \$PJES2 command, JES2 is not withdrawn and no new functions will be started. However, jobs can continue to be entered.

If received as a response to a \$DJES2 command, command processing is complete and normal processing continues.

Operator response: If received as a response to a \$PJES2 command, then evaluate the following JES2 functions listed to determine if they can be stopped, then re-enter the \$P JES2 command:

- Active processors
- Active address spaces
- Active networking device
- Allocated internal readers

- Outstanding cross member requests (If necessary, a \$P JES2, QUICK will ignore the cross member request when withdrawing.)

For held processors, issue a \$S command to restart the processors. However, if held processors remain, contact the IBM support center.

For internal activity, verify each count is decreasing over time that indicates progress is being made.

If received as a response to a \$DJES2 command, then none.

Module: HASPCOMM

Routing Code: Routed as a command response

Descriptor Code: 4

\$HASP609

Explanation:

▶▶—NUMBER SET TO—*nnnnnn*—▶▶

The operator entered a \$T NUM command indicating that the job number base is to be reset to the value indicated by *nnnnnn*.

In the message text:

nnnnnn

The new starting number.

System action: The base value for assigning job, started task, and TSO identification numbers is set to the value indicated. The next job, started task, or TSO user entering the system will be assigned that value (assuming no other job, started task, or TSO user currently has the value) and the base will be incremented by 1.

Operator response: None.

Module: HASPCOMM

Routing Code: #

Descriptor Code: –

\$HASP610

Explanation:

▶▶—JOB(S) NOT FOUND—▶▶

The operator has entered a job list command and no jobs were found that met the selection criteria.

System action: Processing continues.

Operator response: None.

Module: HASPCOMM, HASPPSO

Routing Code: #

Descriptor Code: –

\$HASP611

Explanation:

▶▶—LIST INCOMPLETE—▶▶

A change in the job queues occurred during command processing. When such a change affects the integrity of the

\$HASP612 • \$HASP614

status information to be displayed, message \$HASP611 will be displayed and processing of the command will be terminated.

System action: Processing continues.

Operator response: Reenter the command. The command entry should be modified to limit responses to required information only.

Module: HASPCOMM

Routing Code: #

Descriptor Code: –

\$HASP612

Explanation:

▶▶—NO ACTIVE JOBS—▶▶

The operator entered a \$DA command. The JES2 system found that no active jobs in the queues met the specifications given in the \$DA command.

System action: Processing continues.

Operator response: None.

Module: HASPCOMM

Routing Code: #

Descriptor Code: –

\$HASP613

Explanation:

▶▶—NO AUTOMATIC COMMAND FOUND—▶▶

The operator entered a \$TA command as a display-only request (\$TA,ALL or \$TAcccc). No automatic command element was found.

Note: The issuing console must have system authority. A setting of AUTH=INFO will result in this message even though automatic commands exist.

System action: Processing continues.

Operator response: Ensure that console authority is sufficient and that the ID (cccc) of the command element is correct. Resubmit the command.

Module: HASPCOMM

Routing Code: #

Descriptor Code: –

\$HASP614

Explanation:

▶▶—OFFLOADn—START REJECTED – —DATA SET IN USE (OFFLOADn—ON—*memname*—▶▶

The operator entered a \$S command to start an offload device, but the corresponding offload data set is currently being used by an offload device on the system identified by *memname*.

In the message text:

n The number of the offload device.

memname

The member name.

System action: The command is rejected and processing continues.

Operator response: Assign another data set to this offload device and reenter the \$\$ command, or drain the offload device currently using the data set and reenter the \$\$ command for this offload device.

Module: HASPSTAM

Routing Code: 1,2

Descriptor Code: –

\$HASP615

Explanation:

▶▶—ACTIVE DATA SETS NOT ROUTED—▶▶

The operator entered a \$R command and JES2 is unable to reroute currently active data sets.

System action: JES2 continues processing.

Operator response: Ensure that the data sets to be rerouted are not active and reenter the \$R command.

Module: HASPCOMM

Routing Code: #

Descriptor Code: –

\$HASP616

Explanation:

▶▶—NO JOBS HELD—▶▶

The operator entered a \$HA command telling the system to hold all jobs on the job queue. No jobs were found.

System action: JES2 continues processing.

Operator response: None.

Module: HASPCOMM

Routing Code: #

Descriptor Code: –

\$HASP617

Explanation:

▶▶—NO JOBS RELEASED—▶▶

The operator entered a \$AA command telling the system to release all jobs held by the \$HA command. No jobs were found to be held by that command.

System action: Processing continues.

Operator response: If jobs are known to be held, use explicit release commands: \$A'jobname', \$AJ, \$AS, or \$AT as appropriate to release the jobs.

Module: HASPCOMM

Routing Code: #

Descriptor Code: –

\$HASP618 • \$HASP621

\$HASP618

Explanation:

▶▶—PCE ATTACH DENIED—▶▶

Installation exit 27 denied the attach of a JES2 processor control element (PCE) during JES2 initialization.

System action: JES2 ends.

Operator response: Notify the system programmer.

System programmer response: Determine why the exit routine denied the PCE attach and correct the problem.

Module: HASPIRMA

Routing Code: 1,2,10

Descriptor Code: 4

\$HASP619

Explanation:

▶▶—NO OUTPUT QUEUED—▶▶

The operator entered a \$DF command and there was no work in the output forms queue for the operands given in the \$DF command.

System action: Processing continues.

Operator response: None.

Module: HASPCOMM

Routing Code: #

Descriptor Code: –

\$HASP620

Explanation:

▶▶—COMMAND REJECTED – —JES2 SHUTDOWN IN PROGRESS—▶▶

During JES2 shutdown processing, the operator entered a command other than \$PJES2,ABEND or \$E CKPTLOCK,HELD BY=.

System action: The command is ignored.

Operator response: Allow JES2 to complete shutdown processing. JES2 must be restarted before you can enter any further commands.

Module: HASPCOMM

Routing Code: #

Descriptor Code: –

\$HASP621

Explanation:

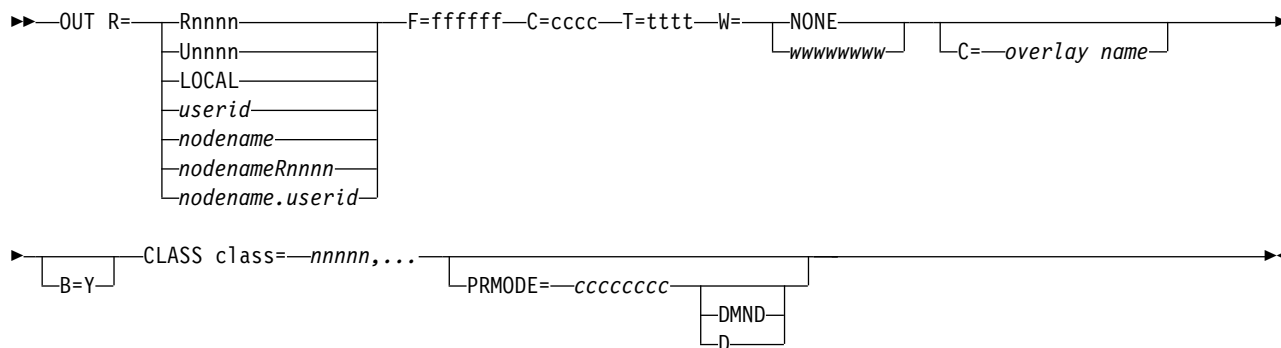

The operator entered a \$D F command to display the output forms queue. The output forms queue contains work for destination R, where R is:

- Rnnnn** A remote device.
- Unnnn** A local device with special routing.
- LOCAL** A local device.
- userid* A userid at this node.
- nodename* A node.
- nodename.Rnnnn* *nnnn* is a remote device at node *nodename*.
- nodename.userid* *userid* is a userid at node *nodename*.

The work requires:

- ffffff* Forms.
- cccc* Carriage control tape or FCB image.
- ttt* Printer train or UCS image.
- wwwwwww* Writer ID.
- NONE** Writer ID not specified.
- overlay name* 3800 forms overlay name.
- B=Y** 3800 burster required.
- class=nnnnn,...** The classes and the number of work elements in each class.

Note: If the number of work elements exceeds 99999 then ***** will display.

PRMODE=ccccccc
Processing mode, where *ccccccc* is the 1- to 8-character name for the processing mode required to process the SYSOUT correctly.

DMND or D
This notation appears in the keyword field when the keyword specification requires demand setup to indicate those characteristics that require demand setup processing

System action: Processing continues.

Operator response: None.

Module: HASPCOMM

\$HASP622 • \$HASP624

Routing Code: #

Descriptor Code: –

\$HASP622

Explanation:

▶▶—RESPONSE LOCATION—*console*—UNAVAILABLE—*id*—▶▶

The operator entered a command directing the response to a console and console area, which was not available to JES2. If the specified console is not available, this message appears on the issuing console. The command entered is displayed immediately preceding this message. If the command causing this message is an automatic command, the identifier of the automatic command is displayed.

In the message text:

console The console and console area that is unavailable.

id The identifier of an automatic command.

System action: Processing continues.

Operator response: Check the condition of the consoles and reenter the command if required.

Module: HASPCOMM

Routing Code: #

Descriptor Code: –

\$HASP623

Explanation:

▶▶—MEMBER DRAINING—▶▶

The operator entered a \$P command and the member has discontinued scheduling work. Jobs that would normally be selectable for processing will not be selected. When a \$\$ command is entered to resume JES2 processing, or when a \$P JES2 command entered to withdraw JES2, JES2 deletes this message from the console.

System action: No new functions are started; however, you may continue to enter jobs.

Operator response: Enter the \$\$ command to resume JES2 processing.

Module: HASPCOMM

Routing Code: #

Descriptor Code: 2

\$HASP624

Explanation:

▶▶—*cmd jobname*—MULTIPLE JOBS FOUND—▶▶

The operator entered the indicated command for the job named in the message text, but JES2 found more than one job with that name. JES2 did not process the command.

In the message text:

cmd The text of the entered command.

jobname

The name of the job.

System action: JES2 issues display messages for the jobs that it found.

Operator response: Reenter the command, specifying the jobid number instead of the job name.

Module: HASPCOMM

Routing Code: #

Descriptor Code: –

\$HASP625

Explanation:

▶▶—*devname*—IN USE—▶▶

The operator entered a \$S or \$T command for the indicated device. The system found the device but could not take the indicated action for one of the following reasons:

- If the command was a \$T, the device is currently active and the operands T=, F=, and C= cannot be used until the device is idle or has been halted for a forms, carriage or train setup.
- If the command was a \$S 1) the device was already allocated to a non-JES2 function or, 2) the system programmer has caused more than one device to be assigned to more than one logical device and JES2 is currently using the device for another function.

In the message text:

devname

The name of the device.

System action: The command is ignored and processing continues.

Operator response: Determine the use of the device and, in the case of the \$T command, wait until the device is idle or JES2 has stopped the device for operator assistance. In the case of the \$S command, wait for the jobs or the JES2 function to deallocate the device before reentering the \$S command for the device. (JES2 deallocates devices when they go into DRAINED status.)

Module: HASPCOMM, HASPFSSP

Routing Code: #

Descriptor Code: –

\$HASP626

Explanation:

▶▶—*devname*—[NOT STARTED –]—INVALID UNIT—▶▶

The operator entered a \$S command for the device indicated by *devname*. The device is not an SNA device and either the UNIT for the device was not specified or an incorrect unit address was specified during initialization.

In the message text:

devname

The name of the device.

System action: Processing continues. The device remains drained.

Operator response: Notify the system programmer.

System programmer response: Correct the unit address specification on the device's initialization statement.

Module:

HASPCOMM, HASPSXDV

Routing Code: 1,2,10

Descriptor Code: 4

\$HASP627 • \$HASP628

\$HASP627

Explanation:

▶▶ *devname* — NOT STARTED — UNIT=*dev* IS — NOT AVAILABLE —▶▶

The operator entered a \$\$ command for the device indicated by *devname*. One of the following is true:

- The device was already allocated to a non-JES2 function.
- The system programmer has assigned the device to a physical unit but JES2 is using that physical unit for a different device function.
- The unit is offline and cannot be allocated.
- The allocation subtask abended.
- The device is assigned to a functional subsystem (MODE=FSS), and the FSS failed to start the device (possibly for one of the above reasons).
- No unit address was specified for this printer.

In the message text:

devname

The name of the device.

dev Specifies a 4-digit hexadecimal device number.

System action: Processing continues with the device remaining drained.

Operator response: Determine the use of the unit assigned to the device.

- If the unit is offline, place it online and use the VARY command to make it available for allocation before reentering the \$\$ command.
- If the unit is busy with a JES2 function, wait for it to complete, enter \$P for the owning device, and reenter the \$\$ command to activate the new function.
- If the unit is allocated to a non-JES2 function, wait until it becomes available before reentering the \$\$ command.
- If the device is in FSS mode and none of the reasons above appear to be the cause of the start failure, look for messages from the FSS indicating possible causes of the problem.
- If the unit has one of the properties listed below, notify the system programmer:
 - The unit is online.
 - The unit is not allocated.
 - The unit is allocated only to JES2 functions.
 - The unit is not busy with a JES2 function.
 - The FSS assigned to the device, if any, did not issue any messages indicating the reason for the start failure.
- If no unit address was specified, it should be specified through a \$T command. The device can be started with a \$\$ command.

System programmer response: Determine why the device is unavailable, then retry the allocation.

Module: HASPCOMM, HASPFSSP, HASPSXDV

Routing Code: 1,2,10

Descriptor Code: 4

\$HASP628

Explanation:

▶▶ *devname* — Start failed — *reason* —▶▶

The operator attempted to start the *devname* device that is specified in the message. The device could not be started because of the reason listed.

In the message text, *devname* is the device that the operator attempted to start.
 In the message text, *reason* is the following reason for the failure:

MOD=CLASS= value is not valid

A \$S OFFLOADx,TYPE=RECEIVE command failed. The offload job receiver specified a MOD=CLASS= value that is either a nonexistent class, or an existing class that is currently set to ACTIVE=NO. The value for MOD=CLASS= must be updated to a valid job class before the offload device can be started.

System action: The start command fails.

Operator response: Contact your system programmer.

System programmer response: Perform the corrective action described for the applicable *reason*, and then retry the start command.

Module: HASPCOMM

Routing Code: #

Descriptor Code: -

\$HASP629

Explanation:

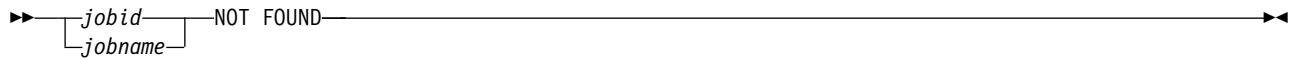

The operator entered a command to set a job's priority or processing class, but JES2 could not find the job. Either the JES2-assigned *jobid* or the *jobname* appears, depending on how the operator identified the job on the command.
 In the message text:

jobid The job identifier.

jobname
 The name of the job.

Note: The *jobid* actually appears *before* the message identifier (\$HASP629) if your installation has entered the K S,MFORM=(J) command to include the jobid in the console message format.

System action: Processing continues.

Operator response: Enter the correct job identification for the required job.

Module: HASPCOMM

Routing Code: #

Descriptor Code: -

\$HASP630

Explanation:

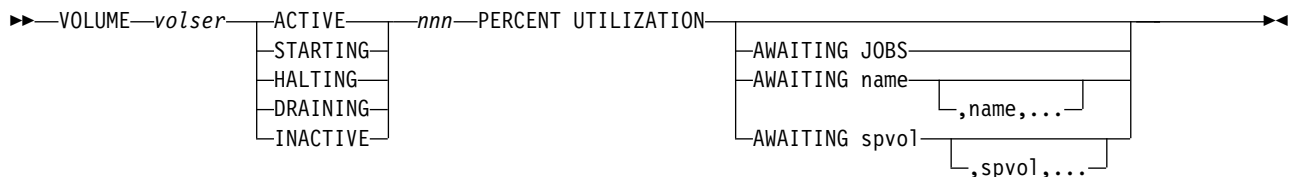

This message is issued when:

- The operator enters the \$D SPOOL command.
- The status of a volume changes.
- A command is entered that will not alter the current status of the spool volume. For example, a \$P SPOOL command is reentered against a volume that is already draining.

\$HASP631

- A SPOOL volume is halted automatically. JES2 halts the spool volume when IOS detects that no channel paths are available. See message IOS002A in *z/OS MVS System Messages, Vol 9 (IGF-IWM)*.

This message shows the status of a spool volume identified by *volser* and the percentage of allocated space on that volume.

In the message text:

volser The volume identifier.

nnn The percentage of allocated space on the volume.

If a spool command is in progress for this volume, the optional text (**AWAITING...**) is displayed, indicating the reason the command has not completed.

The spool device is identified with its *volser* and characterized as:

ACTIVE

The spool volume is in use and JES2 can allocate space on it.

STARTING

The spool volume is in the process of dynamic allocation or formatting.

HALTING

JES2 can no longer allocate space on the spool volume, and no new work will be selected. Currently active jobs will be allowed to complete their current phase of processing.

DRAINING

JES2 can no longer allocate space on the spool volume. The spool volume is in use and will finish processing jobs that have space currently allocated to the spool volume. A DRAINING spool volume results in the \$HASP806 message. The message notifies the member where the DRAIN command was issued that the volume is DRAINED. After the volume is drained, its status no longer appears in this message.

INACTIVE

JES2 can no longer allocate space on the spool volume. JES2 will not process any jobs that already have space allocated on the spool volume. The volume is no longer allocated to JES2.

AWAITING JOBS

The command processor is waiting for jobs to be removed from the volume before processing can complete.

AWAITING *name* [*name...*]

The volume is waiting for processing of a SPOOL command by one or more indicated members.

name is the member name.

AWAITING *spvol* [*spvol...*]

The volume is waiting for one or more indicated spool volumes to be available.

spvol is the spool volume.

System action: JES2 processing continues.

Operator response: None.

Module: HASPCOMM

Routing Code: #

Descriptor Code: -

\$HASP631

Explanation:

▶▶—EVENT TRACE LOG DISASTROUS ERROR — — —TRACING/LOGGING DISABLED—▶▶

The event trace log processor experienced a disastrous error and ended. To recover from the error, the event trace log recovery routine has disabled tracing and logging.

System action: Processing continues.

Operator response: Notify the system programmer of the error. This error prevents the normal shutdown of JES2 (\$P JES2 command). A \$P JES2,ABEND command, followed by a hot start of JES2, is required to restart JES2 and the tracing facility.

System programmer response: Determine why the error occurred and tell the operator if tracing or logging should be restarted.

Module: HASPEVTL

Routing Code: 1,2,10

Descriptor Code: 4

\$HASP635

Explanation:

▶▶—*jobname*—NOT EXECUTING ON—*memname*—▶▶

The operator entered a \$DM command to write a message on a job's JES2 job log; the specified job was not running on the identified system.

In the message text:

jobname

The name of the job.

memname

The member name.

Note: A jobid may precede \$HASP635. See "JES2 message format" on page 1.

System action: The message is not sent; processing continues.

Operator response: None.

Module: HASPCOMM

Routing Code: #

Descriptor Code: –

\$HASP636

Explanation:

▶▶—*cmd*—▶▶

The message text repeats back to the operator, in an out-of-line area on a console, the command the operator entered. In the message text:

cmd The text of the command entered by the operator.

System action: Processing continues.

Operator response: None.

Module: HASPCOMM

Routing Code: #

Descriptor Code: –

\$HASP642 • \$HASP644

\$HASP642

Explanation:

▶▶ *nnnnnn*—HOLD—*sysid*—IND—▶▶

The operator entered a \$DQ command. There are *nnnnnn* jobs held in system *sysid*. (This includes both active and queued jobs.) If IND appears, system *sysid* is in independent mode.

In the message text:

nnnnnn

The number of jobs being held.

sysid The system identifier.

System action: Processing continues.

Operator response: None.

Module: HASPCOMM

Routing Code: #

Descriptor Code: –

\$HASP643

Explanation:

▶▶ *nnnnnn*—PPU—*destid*—ANY—▶▶

The operator entered the \$DQ command. There are *nnnnnn* jobs waiting for print/punch processing with the routing shown in the *destid* field. ANY indicates that the jobs are eligible for processing on any system.

In the message text:

nnnnnn

The number of jobs awaiting processing.

destid The destination of the output.

System action: Processing continues.

Operator response: None.

Module: HASPCOMM

Routing Code: #

Descriptor Code: –

\$HASP644

Explanation:

▶▶ *nnnnnn*—OUT—*sysid*—IND—▶▶

The operator entered a \$DQ command. There are *nnnnnn* jobs waiting for output processing in system *sysid*. If IND appears, system *sysid* is in independent mode.

In the message text:

nnnnnn

The number of jobs awaiting output processing.

sysid The system identifier.

System action: Processing continues.

Operator response: None.

Module: HASPCOMM

Routing Code: #

Descriptor Code: –

\$HASP645

Explanation:

▶▶—*nnnnnn*—XMT—*destid*—▶▶

The operator entered a \$DQ command. There are *nnnnnn* jobs waiting for transmission to the node identified in the *destid* field for processing.

In the message text:

nnnnnn

The number of jobs awaiting transmission.

destid The destination of the output.

System action: Processing continues.

Operator response: None.

Module: HASPCOMM

Routing Code: #

Descriptor Code: –

\$HASP646

Explanation:

▶▶—*nnn.nnnn*—PERCENT SPOOL UTILIZATION—▶▶

The operator entered a \$D N, \$D Q, or \$D SPOOL command. This message gives the total percent of space used from the volumes available for allocation (ACTIVE volumes). Other spool volumes may be known to JES2, but are not included in the total percent utilization (for example, volumes that have a status of DRAINING, HALTING, INACTIVE, and so on).

The utilization percentage is the last response to the \$D N, \$D Q, or \$D SPOOL commands and can be used to gauge the quantity of work the output devices have backlogged. Large percentages of utilization tend to increase overhead in handling SYSIN/SYSOUT data. Full utilization of spool space (100%) causes processing and input of jobs to stop and generally undesirable results follow.

In the message text:

nnn.nnnn

The percentage of spool space being used.

System action: Processing continues.

Operator response: As a general rule, if the utilization appears high, inform the installation management so that appropriate action can be taken. The action depends on the reasons for high utilization. If the percentage approaches 100%, there are several options that can be taken:

- Stop all readers and initiators, make sure that all available output devices are busy (route output to idle devices when possible), and inform time sharing users to release or delete their data sets.
- Start or restart a spool volume using the \$\$ SPOOL command to increase available spool space.
- Use spool offload to temporarily offload work.

Module: HASPCOMM

Routing Code: 1,2,10

Descriptor Code: 4

\$HASP647

Explanation:

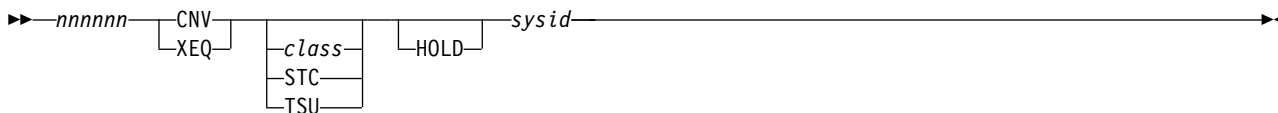

The operator entered a \$DQ command. There are *nnnnnn* jobs waiting for JCL conversion (CNV appears in the message text) or for processing (XEQ appears). The *class* field contains the processing class for the jobs. For CNV, a value appears in the *class* field only if the operator specified a particular class on the command. Otherwise, for CNV, the field is blank and *nnnnnn* is the number of jobs in all classes awaiting JCL conversion. If HOLD appears in the message text, the processing class is being held by the \$HQ command. If STC or TSU appears, the class is the system task or time-sharing user class.

In the message text:

nnnnnn

The number of jobs.

class

The class of the jobs.

sysid

The system identifier.

System action: Processing continues.

Operator response: None.

Module: HASPCOMM

Routing Code: #

Descriptor Code: -

\$HASP648

Explanation:



JES2 issues this message in response to either a \$D or \$T SSI command that specified the SSI(n) keyword.

- All of the keywords defined on the specified initialization statement or command and their current values (if the statement name is specified without any keywords).
- Certain keywords defined on the initialization statement or command and their associated values (if the statement name and those keywords are specified on the DISPLAY statement or command).

In the message text:

SSI(n)

The SSI function number (1-256).

ADDRESS

The hexadecimal address where the SSI function routine has been loaded into storage.

DESCRIPTION

The description of the SSI function.

MODULE

Displays the assembly module containing the SSI function routine.

TRACE

Displays whether the tracing is active (YES) for this function or not (NO).

System action: Processing continues.

Operator response: Inform the system programmer of the status of the displayed SSI function(s).

System programmer response: Use the \$D SSI command to display information on SSI functions and their

corresponding function numbers. Use this information to verify that the SSI functions you want are being traced. If functions you want are not being traced, use the \$T SSI(n),TRACE=YES command to activate tracing. To deactivate tracing, use the \$T SSI(n),TRACE=NO command.

Note: This tracing works in conjunction with trace IDs 11 and 12 (processor-specific). In order to create SSI trace records, ID 11, 12, or both must be active and TRACEDEF ACTIVE=YES must be specified. TRACE=YES may be displayed for SSI function 54, but because it does not invoke the \$SAVE or \$RETURN macro, no trace data is created.

Module: HASCSCAN

Routing Code: #/1,2,10

Descriptor Code: -/4

\$HASP649

Explanation:

▶▶—*cmd*—INVALID COMMAND—▶▶

The command has been identified as a JES2 command; however, the command has been rejected for one of the following reasons:

- The verb was not recognized as a JES2 command verb.
- The first character of the first operand was not recognized to be a legal qualifier of the verb.
- The entry source was not authorized to enter the command.
- The operator directed that the response to this command be displayed on a supported console and area, but that console or area was not currently available to JES2. The system attempts to display this response in the normal message area of the requested console.

In the message text:

cmd The text of the invalid command.

System action: The command is ignored and processing continues.

Operator response: See *z/OS JES2 Commands* for legal verbs, formats, and authority required and reenter the required command correctly from an authorized console.

Module: HASPCOMM

Routing Code: #

Descriptor Code: -

\$HASP650

Explanation:

▶▶—*op*—INVALID OPERAND—OR MISPLACED OPERAND—▶▶

The operator entered a command with the operand shown in the message text. One of the following is true:

- The operand is not one of the valid operands for the command.
- The operator entered the command on a console that is not authorized to use the operand.
- The operator specified an incorrect range on the operand.
- The volser did not match the VOLUME parameter on the SPOOLDEF initialization statement.

In the message text:

op The non-valid operand.

System action: Normally, if one operand is incorrect, no action is taken. However, commands that perform actions sequentially as operands are validated, will stop processing upon encountering the incorrect operand or character,

\$HASP651 • \$HASP653

leaving the action partially complete. Some examples of these commands are: \$AQ, \$HQ, \$C ddd, \$E ddd, \$F ddd, \$I ddd, \$N ddd, \$P ddd, \$S ddd, \$T ddd, \$TM, and \$DU.

Operator response: See *z/OS JES2 Commands* for legal verbs, formats, and authority required and reenter the required command correctly from an authorized console.

Module: HASPCOMM

Routing Code: #

Descriptor Code: –

\$HASP651

Explanation:

▶▶—INVALID SPECIFICATION—▶▶

The operator entered a \$TA command with an incorrect operand specification.

System action: If an automatic command was being created, it will be displayed and deleted. The element identification field in the display will not contain a value. If an automatic command was being altered, it will be displayed and remain unchanged.

Operator response: See *z/OS JES2 Commands* for valid verbs, formats, and authority required and reenter the required command correctly from an authorized console.

Module: HASPCOMM

Routing Code: #

Descriptor Code: –

\$HASP652

Explanation:

▶▶—INSUFFICIENT CSA FOR TRACE—STORAGE REQUEST—▶▶

The operator entered a \$T TRACEDEF, TABLES=nnnn command requesting a new storage amount that is greater than the current amount of storage allocated for trace tables.

Note: This message issued when both CSA and ECSA have been depleted.

System action: Processing continues. The system obtains as many tables as possible from the available CSA and ECSA storage.

Operator response: Notify the system programmer. Note the number of tables obtained. Decrease the number to free CSA and ECSA storage for use by system components.

System programmer response: Determine the reason for the storage constraint and correct the problem.

Module: HASPEVTL

Routing Code: 1,2,10

Descriptor Code: 4

\$HASP653

Explanation:

▶▶

Standard display
Long display
Details display

 —▶▶

Standard display:

```
|—PCE—(—pcetype—)—COUNT=—(—define,allocated,ended—),—ACTIVE=—active,—TRACE=—tr—————|
```

Long display:

```
|—PCE—(—pcetype—)—DESC=—description—COUNT=—(—defined,—allocated,—ended—),—————>
▶—ACTIVE=—active,—TRACE=—tr—————|
```

Details display:

```
|—PCE—(—pcetype—)—NAME=—name,—WAIT=—waitparms,—MOD=—csect,—SEQ=—seq,—————>
▶—TIME—yyyy.ddd.hh:mm:ss, —CURJOB=—jobnnnnn,—————|
  |—ACTIVE=—active,—|
  |—I/O=—iii,—|
  |—ENDED=—yes,—|
  |—EXIT=—eeee————|
```

JES2 issues this message in response to either a \$DPCE or \$TPCE command. The DETAILS operand displays details on every PCE of the specified type. The details display lists PCE/DCT names, where and what the PCE is \$WAITing for, PCE WAIT time, \$ACTIVE count, current I/O count, current jobid (from PCEJQE), and whether the PCE has ended, and the current exit the PCE is waiting on.

The information provided is:

pcetype

The processor type for a group of JES2 processors. This value is the NAME operand for an entry in the JES2 or installation PCE table. For a complete list of the JES2 processor types, see the \$T PCE command description in *z/OS JES2 Commands* or see the Appendix A, "PCE list," on page 553 for a list of PCEs, their names, whether they are required, and a description of their function.

description

Describes the processor type. This value is the DESC operand for an entry in the JES2 or installation PCE table.

tr

Indicates the tracing status for the allocated PCEs for processors of this type. A value of mixed indicates that some PCEs have tracing active and others do not.

Note:

1. If defined as zero, TRACE=*tr*.
2. If TRACE=yes, all processors have processor tracing set.
3. If TRACE=no, no processors have processor tracing set.
4. If TRACE=mixed, the tracing status of the processors is mixed and the \$DU command should be used to determine the status for individual device processors (for example, \$DU,PRT1).

allocated

Indicates the number of defined PCEs that have been created.

defined

Indicates the number of PCEs of this type defined to JES2.

ended

Indicates the number of allocated PCEs that have ended.

active

Indicates the \$ACTIVE count.

name

Name of the specific PCE. This is different from the pcetype if a device (DCT) is associated with the PCE.

waitparms

The parameters pass to the \$WAIT the PCE is in. If the PCE is not \$WAITing, the PCE has ended, or the

\$HASP654 • \$HASP655

PCE has never run, then waitparms is displaying as "N/A" and MOD=, SEQ=, and the TIME= are not displayed. This is always the case for the COMM PCE.

csect Csect name where the PCE has \$WAITed.

seq Sequence number (columns 73-80) from the assembler source, associated with the \$WAIT macro invocation.

yyyy.dd,hh:mm:ss

Time the PCE issued the \$WAIT.

jobnnnnn

Jobid of the job pointed to by PCEJQE.

iii Count of outstanding I/O for this PCE.

ENDED=yes

PCE has been ended.

eee Number of the exit that is currently in control of this PCE.

If the operator specified one or more of these processor types on the \$DPCE command, this message appears for each of the specified types. If the operator entered the \$DPCE command without any processor names, this message appears for each processor type.

System action: Processing continues.

Operator response: None.

Module: HASPCOMM

Routing Code: 1,2,10

Descriptor Code: 4

\$HASP654

Explanation:

▶▶—TRACE DATA LOST —DISCARDING ENTRIES—▶▶

JES2 issues this message when the trace logger determines that an insufficient number of tables was allocated to hold all of the trace data.

System action: Processing continues. Trace entries are discarded until a trace table becomes available. Statistics are kept on the number of trace entries discarded and placed in the trace log listing.

Operator response: Notify the system programmer.

System programmer response: You can trace fewer activities or use the \$T TRACEDEF TABLES=nnnn command to allocate additional trace tables.

Note: Discarding of trace data may have occurred before this message is displayed. Enter the \$D TRACEDEF command to display the number of recent discards; check the log data set to find out how long discarding has been going on and how many trace entries have been discarded.

Module: HASPEVTL

Routing Code: 1,2

Descriptor Code: 2

\$HASP655

Explanation:

▶▶—NO STORAGE AVAILABLE—▶▶

The operator entered a \$OQ or \$O command but no storage is available to service the request. The request is ignored.

System action: JES2 processing continues.

Operator response: Notify the system programmer that this condition has occurred.

System programmer response: Determine why there is insufficient storage in the JES2 address space and correct the error.

Module: HASPCOMM

Routing Code: #

Descriptor Code: -

\$HASP657

Explanation:

▶▶—JES2 EVENT TRACE LOG IS INACTIVE -- —TABLES=0—▶▶

There is an insufficient number of trace tables for tracing. Tracing is turned off (ACTIVE=NO). Either the operator issued a \$T TRACEDEF, TABLES=0 command or the initial request for trace tables failed.

System action: Processing continues without tracing.

Operator response: Notify the system programmer that this condition has occurred. If tracing should be active, you must first allocate trace tables using the \$T TRACEDEF, TABLES=nnnn command.

System programmer response: Tell the operator if trace tables should be allocated.

Module: HASPEVTL, HASPIRMA

Routing Code: 1,2

Descriptor Code: 4

\$HASP659

Explanation:

▶▶—devname—NOT ACTIVE ON—sysid—▶▶

The operator has entered a \$B, \$C, \$E, \$F, \$I, \$N, or \$Z device command, but the specified device is not actively processing a unit of work on the indicated system.

In the message text:

devname

The name of the device you want.

sysid

The system identifier.

System action: Processing continues.

Operator response: None.

Module: HASPCOMM

Routing Code: #

Descriptor Code: -

\$HASP667

Explanation:

\$HASP668 • \$HASP670

▶▶—TRACE—(—*n*—)—START=—YES—
 └—NO—┘

JES2 issues this message in response to a \$D TRACE(*n*) command. For each trace ID specified on the command, this message displays whether that ID is active or inactive. JES2 ignores IDs within a range that are not valid (that is, IDs that are not defined to JES2 with the \$TIDTAB macro).

In the message text:

n The number of the trace.

System action: Processing continues.

Operator response: Inform the system programmer of the status of the displayed trace IDs.

System programmer response: Use the list of trace IDs defined with the \$TIDTAB macro to verify that the required IDs are active. If the required IDs are not active, use the \$\$ TRACE(*n*) command to activate them. You can enter the \$P TRACE(*n*) command to deactivate undesired IDs.

Module: HASCSCAN

Routing Code: #/1,2,10

Descriptor Code: -4

\$HASP668

Explanation:

▶▶—NO DEVICE(S) FOUND—

The operator entered the \$D U command, but JES2 could not find any devices with the characteristics specified in the command operands.

Explanation: The operator entered a \$T PRTnnnn command with either a C=xxxx or a T=xxxx operand. There are not enough buffers available for the \$GETBUF routine.

System action: Processing continues.

System action: Processing continues. No determination was made as to whether the FCB or UCS is standard or non-standard. The DCT remains set by the \$T command; however, the DCTPPSWU (UCS operand) or DCTPPSWB (FCB) is not set.

Operator response: If necessary, reenter the command with different operands.

Operator response: You may want to reset the printer. If a non-standard FCB or UCS was set by the \$T PRTnnnn command, then the DCT is now marked as having a standard FCB or UCS and jobs on the device may run incorrectly.

Module: HASPCOMM

Module: HASPCOMM

Routing Code: 7

Descriptor Code: 4

\$HASP670

Explanation:

▶▶—\$SN, SOCKET=—xxxxxxxx—REJECTED -—*reason*—

The operator attempted to initiate a TCP/IP NJE session using the \$SN command. *reason* is one of the following:

TCP/IP INTERFACE NOT ACTIVE, RC=01

No NETSRV devices have been defined.

SOCKET xxxxxxxx IS NOT AVAILABLE, RC=02

The requested socket has not been defined.

ALREADY IN SESSION WITH xxxxxxxx, RC=03

The requested socket is already in session.

LINEnnnn IS NOT A TCP/IP LINE, RC=04

The line requested did not specify UNIT=TCP.

DEDICATED LINE LINEnnnn IS NOT AVAILABLE, RC=05

The line specified on the NODE(nnn) statement is not usable. It might already be in session.

NETWORK PATH MANAGER IS NOT AVAILABLE, RC=06

JES2 cannot start the connection because the network path manager PCE failed.

NODEnnnn IS THE LOCAL NODE, RC=07

The connection failed because the specified socket specifies the local node.

NO IDLE TCP/IP LINE IS AVAILABLE, RC=08

No line is specified on the \$SN command and JES2 cannot find a started TCP/IP line that was not currently busy.

RESOURCE SHORTAGE BUFFERS|NETLINES, RC=09

A resource shortage exists. NJEDEF LINENUM might be too small.

NETWORK PATH MANAGER INTERNAL ERROR, RC=10

An internal error occurred.

SERVER NETSRVxxx IS NOT ACTIVE, RC=11

The NETSRV default or specified value has not been started.

SERVER NETSRVxxx IS NOT AVAILABLE, RC=12

The specified NETSRV on the NODE(nnn) statement does not exist.

LINE LINEnnnnn IS NOT AVAILABLE, RC=13

The specified line has not been started or is in use by another application.

SECURE SIGNON FAILED, APPCLU CLASS INACTIVE, RC=14

SIGNON=SECURE was specified on the NODE statement for the adjacent node, but a secure signon cannot be done because the APPCLU class has not been activated.

SOCKET socketnm DOES NOT SPECIFY A VALID IPADDR, RC=15

A socket statement specified IPADDR=*LOCAL, but the node is not the local node. *LOCAL is only valid for the local node.

System action: JES2 fails the start of the connection.

Operator response: Contact system programmer.

System programmer response: Verify that the correct initialization SOCKET= values are specified on the NETSRV initialization statement.

Module: HASPTCP

Routing Code: 1, 2, 10

Descriptor Code: 4

\$HASP673

Explanation:

▶▶—MEMBER(n)—keyword=value,...—▶▶

This message is issued in response to a \$D command that specified the MEMBER initialization statement. The message displays the keywords defined on this statement and their current values. For an explanation of the keyword, see either the MEMBER statement in *z/OS JES2 Initialization and Tuning Reference* or the \$D MEMBER command in *z/OS JES2 Commands*.

In the message text:

\$HASP674

n The member number.

keyword

The initialization statement or command parameters.

BOSS Displays YES if this is the first subsystem in this MAS on the MVS. Only BOSS=YES members can run jobs in WLM initiators.

NAME Specifies the name of the member.

IND Specifies that the independent mode status of the member. This is only displayed if the member is defined.

LASTART

Specifies the type and time of the last start. This value is not displayed if the member has never been started.

RESETBY

The identity of the member (the member number) that is performing a \$E MEMBER of this member. This is only displayed while the \$E MEMBER is in progress.

SLEVEL

The service level of the JES2 that is running on this member.

SMFID The SMF id of the MVS system where this member is running. SMFID is not displayed if it is the same as the member name.

SSNAME

The name of the JES2 subsystem running this member.

STATUS

The current status of the member.

SYSNAME

The name of the MVS system where this member is running. SYSNAME is not displayed if it is the same as the member name.

TIME The last time the member accessed the checkpoint. This is not displayed if the member is inactive

VERSION

The version of JES2 that is running on this member.

value The value of the keyword.

System action: Processing continues.

Operator response: None.

Module: HASCSCAN

Routing Code: #

Descriptor Code: -

\$HASP674

Explanation:

▶▶—*text* —SYSTEM UNCONNECTED—▶▶

This message indicates one of the following:

- The operator entered a node send (\$N) command, a global networking (\$G) command, or a display message (\$DM) command specifying another node. The JES2 network path manager determined that the specified node is not currently reachable.
- The operator entered a member send (\$M) command or a display message (\$DM) command specifying another member of this MAS. The TOD clocks of the sending and receiving members are not synchronized (the TOD difference exceeds the tolerance specified by the SYNCTOL parameter on the MASDEF initialization statement).

In the message text:

text The command the operator entered that resulted in this message.

System action: Processing continues.

Operator response: Establish connection with the specified node, and reenter the command. If the receiving member is active, ensure synchronization of the TOD clocks for both members.

Module: HASPCOMM

Routing Code: #

Descriptor Code: -

\$HASP675

Explanation:

▶▶—LINE—*line*—DRAINED, LINE MUST BE STARTED—▶▶

The operator has entered a \$SN command for the identified line in an attempt to start networking with another JES2 node. The line is currently drained.

In the message text:

Ina The number of the drained line.

System action: Processing continues.

Operator response: Start the line with a \$S command and repeat the \$SN command.

Module: HASPCOMM

Routing Code: #

Descriptor Code: -

\$HASP676

Explanation:

▶▶—LINE—*line*—UNAVAILABLE DUE TO SYSTEM RESOURCE SHORTAGE—▶▶
 ┌───┴───┐
 │NETLINES│
 │NETDCTS │
 └───┴───┘
 │BUFFERS │

The operator entered a \$SN command for the identified line in an attempt to start networking with another JES2 node. There is currently a shortage of system resources necessary to establish another network connection. Some possible causes of the resource shortage are:

NETLINES

All networking lines (defined by the LINENUM parameter on the NJEDEF initialization statement) are in use.

NETDCTS

One or more NETDCTs are still marked in use in the NETDCT pool.

BUFFERS

No TP buffers (defined by the BSCBUF and SNABUF parameters on the TPDEF initialization statement) are available.

In the message text:

Ina The line number.

System action: Processing continues.

Operator response: Try the \$SN command later. Notify the system programmer that this condition has occurred.

System programmer response: You may need to increase the value of the LINENUM parameter or the BUFNUM

\$HASP677 • \$HASP679

parameter. In the case of NETDCT shortage, JES2 must be re-IPLed.

Module: HASPCOMM

Routing Code: #

Descriptor Code: –

\$HASP677

Explanation:

▶▶—LINE1na—IS NOT TRANSPARENT BISYNCH LINE—▶▶

The operator has entered a \$SN command for a line that cannot handle binary data.

In the message text:

lna The line number.

System action: Processing continues.

Operator response: Check line definitions. If the line is an SNA line, the A=applid operand is required.

Module: HASPCOMM

Routing Code: #

Descriptor Code: –

\$HASP678

Explanation:

▶▶—LINE1na—BUSY—▶▶

The operator has entered a \$SN command for a line that is currently involved in a JES2 NJE or RJE connection.

In the message text:

lna The line number.

System action: Processing continues.

Operator response: Wait for the line to complete its current JES2 function, enter a \$P command to drain the line, enter a \$S command to start the line, and then reenter the \$SN command.

Module: HASPCOMM

Routing Code: #

Descriptor Code: –

\$HASP679

Explanation:

▶▶—\$SN,A=*applid*—REJECTED – —*reason*—▶▶

The operator attempted to initiate an SNA application-to-application session using the \$SN command.

In the message text:

applid The VTAM application identifier.

reason is one of the following:

JES2/VTAM INTERFACE INACTIVE, RC=01

The JES2/VTAM interface has not been activated. The LOGON1 DCT has either not been defined or not been started using the \$S LOGON1 command.

LINE lna IS NOT A SNA/VTAM LINE, RC=02

The line specified on the \$SN command is a BSC line, not an SNA line.

LINE lna IS NOT ACTIVE, RC=03

The line specified on the \$SN command has not been started. The line must be started before you reissue the \$SN command.

LINE lna IS BUSY, RC=04

The line specified on the \$SN command is already busy for another SNA node or remote.

NO IDLE SNA LINE IS AVAILABLE, RC=05

No line was specified on the \$SN command and JES2 could not find a started SNA line that was not currently busy for another SNA node or remote.

applid IS NOT A DEFINED APPL OR NODE, RC=06

The application name specified on the \$SN command is neither a defined application (APPL) nor the name of an existing node. The name is incorrect, the application should be defined using the \$T APPL(applname) command, or a node should be renamed to that application name.

NODE $nnnn$ IS THE LOCAL NODE, RC=07

The application name specified on the \$SN command either implied a local node or, if no such application exists, was the name of a local node. Networking cannot be initiated from the local node to itself.

ALREADY IN SESSION WITH $applid$, RC=08

The application name specified on the \$SN command either implied, or was the name of, a node already in session with the local node for networking.

MAXIMUM SESSIONS ALREADY ACTIVE, RC=09

Because the maximum number of SNA applications are already active, no additional applications can be started at this time. Use the SESSION parameter on the TPDEF initialization statement to specify the maximum number of applications allowed.

NO STORAGE AVAILABLE FOR APPL, RC=10

An application (APPL) was to be dynamically defined but no storage was available for the necessary control blocks.

THE NODE FOR APPL $applid$ IS INVALID, RC=11

An existing application (APPL) was found for the \$SN command but it references an incorrect node number.

DEDICATED LINE LINE $nnnn$ IS NOT AVAILABLE, RC=12

The line specified on the \$SN command or defined in the NODE($nnnn$) initialization statement is not usable. Possible reasons are:

1. Dedicated line number lna is also dedicated to an RJE device (RMT5,LINE=5).
2. Dedicated line number lna is in disconnect process (draining).
3. Dedicated line number lna has a "password" set on it.
4. User has multiple SNA paths to NODE5 and has set the node for the dedicated line instead of setting the associated APPL statement for a dedicated line.

NETWORK PATH MANAGER IS NOT AVAILABLE, RC=13

JES2 could not start the connection because the network path manager PCE failed. JES2 also issued message \$HASP502 to indicate this condition.

System action: Processing continues.

Operator response: Take appropriate action to correct the condition and then repeat the \$SN command.

System programmer response: For RC=02, reason 1 or 2, this line cannot be used for SNA/NJE line dedication. Another line must be used. For RC=02, reason 3, turn off the password to this line or use another line. For RC=02, reason 4, dedicate the line on the APPL definition instead of the NODE definition.

Module: HASPCOMM

Routing Code: #

Descriptor Code: -

\$HASP680 • \$HASP681

\$HASP680

Explanation:

►►—\$SN,N=—*nodename*—REJECTED — *text*—►►

Where *text* is one of the following:

- NODE NAME NOT VALID, RC=01
- DEDICATED LINE LINE*nnnn* IS NOT AVAILABLE, RC=02

The operator attempted to initiate a networking session using the \$SN command. The command is rejected for one of the following reasons:

NODE NAME NOT VALID, RC=01

The name specified in the command could not be found by JES2. Either the name does not appear on a NODE(*nnnn*) statement or was not defined with a \$T NODE(*nnnn*) command.

DEDICATED LINE LINE*nnnn* IS NOT AVAILABLE, RC=02

The line specified on the \$SN command or defined in the NODE(*nnnn*) initialization statement is not usable.

In the message text:

nodename

The name of the rejected node.

System action: Processing continues.

Operator response: Take appropriate action to correct the condition and then repeat the \$SN command.

Module: HASPCOMM

Routing Code: #

Descriptor Code: —

\$HASP681

Explanation:

►►—N*n*—M*m*—\$GR—*jobname*—INVALID—

DESTINATION NAME
REMOTE NAME

—►►

The operator has entered a global route job command (\$GR) that was accepted by JES2 and transmitted to the appropriate node for action. The destination (or remote) name specified in the command does not appear in the action node's remote destination table.

In the message text:

n The number of the node (**N*n***) or of the MAS member (**M*m***).

jobname

The name of the affected job.

Note: A node id *Nn* and member id *Mm* may precede \$HASP681. See "JES2 message format" on page 1.

System action: Processing continues.

Operator response: Ensure that the destination (or remote) name used is known to the action node and reenter the command.

Module: HASPCOMM

Routing Code: #

Descriptor Code: —

\$HASP682

Explanation:

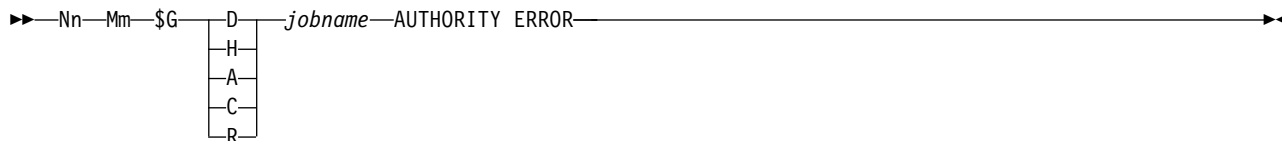

The operator has entered a global command (\$G) that was accepted by JES2 and transmitted to the appropriate node for action. The action node's node information table does not have the entry node defined as having job authority. In the message text:

n The number of the entry node (**Nn**) or of the JES2-assigned MAS member (**Mm**).

jobname
 The name of the affected job.

Note: A node id *Nn* and member id *Mm* may precede \$HASP682. See "JES2 message format" on page 1.

System action: Processing continues.

Operator response: Instruct the action node to give job authority to your node (using the \$T N command) and reenter the \$G command.

Module: HASPCOMM

Routing Code: #

Descriptor Code: –

\$HASP683

Explanation:

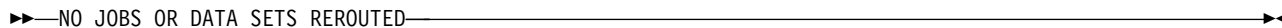

The operator has entered a \$R command. After a search of the job queue for qualifying jobs, no jobs were found that qualified for rerouting.

System action: Processing continues.

Operator response: Make sure the parameters on the \$R command are correct and reenter the \$R command.

Module: HASPCOMM

Routing Code: #

Descriptor Code: –

\$HASP685

Explanation:



In response to a \$D REBLD command, JES2 displays all the JOEs (\$HASP890) and JQEs (\$HASP686) on the rebuild queue. This message follows messages \$HASP890 and \$HASP686 to provide the total of those JQEs and JOEs. In the message text:

nnnnnn
 The number of jobs on the rebuild queue.

mmmmm
 The number of JOEs on the rebuild queue.

\$HASP686

System action: Processing continues.

Operator response: None

System programmer response: None

Module: HASPCOMM

Routing Code: 1,2,10

Descriptor Code: 4

\$HASP686

Explanation:

►►—OUTPUT—(—*jobname*—)—JOB CORR=—*job correlator*—OUTGRP=—*grpid.joeid1.joeid2*—►►

<i>BURST</i> =	{ YES }
	{ DEMAND-SETUP }
<i>CRTIME</i> =	(<i>yyyy.ddd, hh:mm:ss</i>)
<i>FCB</i> =	{ <i>fc</i> b}
	{DEMAND-SETUP}
<i>FLASH</i> =	{ <i>overlay</i> }
	{DEMAND-SETUP}
<i>FORMS</i> =	{ <i>forms</i> }
	{DEMAND-SETUP}
<i>HOLD</i> =	{ <i>holdtype</i> }
	{(<i>holdtype,holdtype</i>)}
<i>HOLDRC</i> =	[(<i>nnn text</i>)]
<i>OFFS</i> =	<i>device[,device...]</i>
<i>OUTDISP</i> =	<i>outdisp</i>
<i>PAGES</i> =	[(<i>nnnn</i> <i>OF mmmmm</i>)]
<i>PRIORITY</i> =	<i>pp</i>
<i>PRMODE</i> =	<i>prmode</i>
<i>QUEUE</i> =	<i>class</i>
<i>REBUILDQ</i> =	YES
<i>RECORDS</i> =	[(<i>nnnn</i> <i>OF mmmmm</i>)]

ROUTECD=	{Rnnnn}
	{Unnnn}
	{LOCAL}
	{userid}
	{nodename}
	{nodename.Rnnnn}
	{nodename.userid}
SECLABEL=	[seclabel]
STATUS	
TSOAVAIL=	{ YES}
	{ NO}
UCS=	{ucs}
	{DEMAND-SETUP}
USERID=	userid
WRITER=	[writer]
RELEASED	
CANCELLED	
NOTE RELEASED, SPECIFY 'PROTECTED'	

The operator entered a \$T O, \$O, \$DO \$TO, \$CO or \$PO command for a job, a started task, or a Time Sharing Option/Extensions (TSO/E) logon. This message displays the current output characteristics for each job output element (JOE) specified on the command. Asterisks (***) appear in the variable field for any characteristic that is not the same for all the data sets in this JOE.

Note: A jobid may precede \$HASP686. See "JES2 message format" on page 1.

The fields in the message text are:

jobname

The name of the job specified on the JOB statement.

job correlator

Displays the 64 displayable/printable character identifier that uniquely identifies this job within the JESplex. The job correlator consists of a system-assigned 31-character value, followed by a semicolon character and a 32-character user-defined value. For JES Symbol Service (IAZSYMBL) documentation on the format of the job correlator, refer to *z/OS JES Application Programming*.

OUTGRP=*grp1d.joeid1.joeid2*

The job output element. The fields in the job output element are:

grp1d The group identifier. This is a 1 to 8-character alphanumeric name either specified by the user's JCL or, if not specified by the user, generated by JES2.

joeid1 A number assigned by JES2 and is used to identify how many job output elements there are within the output group.

\$HASP686

joeid2 A number assigned by JES2 that determines the number of job output elements within the output group identified by *groupid.joeid1*.

BURST={YES|NO|DEMAND-SETUP}

Specifies whether the printer should burst output into separate sheets.

Demand-setup may appear in the keyword field, indicating it is required.

FCB={fcb|DEMAND-SETUP}

The forms control buffer for this output.

Demand-setup may appear in the keyword field, indicating it is required.

FLASH={overlay|DEMAND-SETUP}

The forms overlay frame (FLASH) for this output.

Demand-setup may appear in the keyword field, indicating it is required.

FORMS={forms|DEMAND-SETUP}

The 1 to 8-character forms name for this output.

Demand-setup may appear in the keyword field, indicating it is required.

HOLD={holdtype}

{(holdtype,holdtype)}

Specifies which type(s) of hold the output group is in. The valid types are NONE, OPER, and SYS.

Use the REL= parameter on the \$TO command to release this 'hold' type.

HOLDRC=[((nnn) text)]

Specifies the system hold reason code and an explanation of why the output group is in a held state. The reason codes are:

<i>nnnn</i>	<i>text</i>
001	FSI RELDS UNPRINTABLE-SWB ERROR
002	FSI RELDS UNPRINTABLE-FSA
003	SAF CALL FAILED
004	TRANSMISSION REJECTED
005	HOP COUNT NUMBER EXCEEDS MAXHOP
006	HELD BY SYSOUT API
051	OFFLOAD WITH HOLD
052	PROGRAM CHECK IN HASPPRPU
053	INSTALLATION EXIT PROGRAM CHECK
054	PROGRAM CHECK IN SWBTUREQ

[OFFS=device[,device...]]

The offload device(s) for which the archive bit is set on, indicates that it cannot reselect a job that has been previously offloaded (with DISP=KEEP or DISP=HOLD).

OUTDISP=outdisp

Specifies the output disposition for the output group. Values of *outdisp* are WRITE, KEEP, LEAVE, HOLD, and PURGE.

PAGES=[(nnnn OF mmmm)]

nnnn is the count of pages still to be printed at the time of the last interruption. *mmmm* is the original page count represented by this job output element.

If *nnnn* and *mmmm* are not equal, this job output element was partially processed at an earlier time, but that processing was interrupted.

The page count includes begin page structured fields only. Other AFP control records (records that start with the 'X'5A' control character) are not included in either the record or page count.

PRIORITY=pp

The JES2 scheduling priority.

PRMODE=prmode

The processing mode of the data set.

QUEUE=class

The job class.

REBUILDQ=YES

Specifies that the job is on the rebuild queue and will be purged from the system after its current phase of processing.

RECORDS=[(nnnn OF mmmm)]

nnnn is the count of records still to be printed at the time of the last interruption. *mmmm* is the original record count represented by this job output element.

If *nnnn* and *mmmm* are not equal, this job output element was partially processed at an earlier time, but that processing was interrupted.

The record count includes only records with a non-zero text length and which do not use machine immediate control characters.

ROUTECD=

The Job Output Element has an IP-format destination. The full destination can be viewed through the SDSF's Output Descriptors panel. For a description of an IP-format destination, see the DEST parameter on the OUTPUT JCL statement in *z/OS MVS JCL Reference*.

Rmmm A remote destination at the local node.

Ummm Special local device.

LOCAL

Any local device.

userid a local userid.

nodename

The name of a node.

nodename.Rnnnn

nnnn is a remote number on a node.

nodename.userid

userid is a userid at a node.

SECLABEL=[*sec label*]

The security label of the data sets grouped in the JOE.

STATUS

The current status of the member.

TPJOBID

The transaction job ID associated with the output group.

TPJOBN

The transaction job name associated with the output group.

TSOAVAIL={YES|NO}

Indicates if the output group is available for processing by the TSO output command.

Only an output group that was held when it was created, and has never been released, is available for processing by the TSO/E output command. For example, the \$HASP686 message will display TSOAVAIL=NO if an output group is released by a \$O command and held again with a \$TO NDISP=HOLD command.

UCS={*ucs*|DEMAND-SETUP}

The universal character set for this output.

Demand-setup may appear in the keyword field, indicating it is required.

USERID=*userid*

The user identifier of the submitter of the job.

WRITER=[*writer*]

The external writer specified for this output.

RELEASED

The indicated output group has been released.

CANCELLED

The indicated output group has been canceled.

NOT RELEASED, SPECIFY 'PROTECTED'

The operator entered one of the following against a protected job:

- A \$CO command
- A \$O CANCEL command
- A \$PO command

System action: JES2 processing continues.

System programmer response: If HOLDRC=005, take the actions indicated in the explanation of the \$HASP528 message.

Module: HASPCOMM

Routing Code: #

\$HASP687 • \$HASP691

Descriptor Code: –

\$HASP687

Explanation:

▶▶—UNABLE TO OBTAIN SECURITY—PRODUCT MESSAGES—▶▶

JES2 is unable to obtain messages from the security product for the job or command authority failure.

System action: The job or command is ignored; JES2 processing continues.

Operator response: None.

Module: HASCSRIC

Routing Code: #

Descriptor Code: –

\$HASP690

Explanation:

▶▶—*jobname*—COMMAND REJECTED – —AUTHORIZATION FAILURE—text—COMMAND REJECTED – —▶▶

▶—SOURCE OF COMMAND HAS IMPROPER AUTHORITY—▶▶

A command was entered by an operator or from a console that lacks sufficient authority to issue the command. If JES2 is unable to obtain messages from the security product, the \$HASP687 message is issued; otherwise, *text* indicates that any messages issued by the security product follow the \$HASP690 message.

If **COMMAND REJECTED – SOURCE OF COMMAND HAS IMPROPER AUTHORITY** is displayed, this message will also be issued if the source where the command originated does not have the proper authority to issue the command.

In the message text:

jobname

The name of the job.

Note: A jobid may precede \$HASP690. See “JES2 message format” on page 1.

System action: The command is ignored; JES2 processing continues.

Operator response: Notify the system programmer that this authorization failure has occurred.

System programmer response: Contact the security administrator to determine whether the command should be accepted. Update the appropriate profiles, if necessary, and notify the operator that the command may be reentered.

If **COMMAND REJECTED – SOURCE OF COMMAND HAS IMPROPER AUTHORITY** is displayed, verify that the command should be accepted from the source where the command was issued. If so, then update the authority of the source where the command originated.

Module: HASCSIRQ, HASCSRIC

Routing Code: #

Descriptor Code: –

\$HASP691

Explanation:

▶▶—COMMAND TERMINATED – —*cmd*—▶▶

A program check occurred while JES2 was processing the command identified in the message text. JES2 stopped

processing that command, and the JES2 command processor recovery routine has received control.
In the message text:

cmd The text of the terminated command.

System action: JES2 recovery processing continues.

Operator response: Notify the system programmer.

System programmer response: Follow your installation's procedures for identifying and correcting the problem.

Module: HASPCOMM

Routing Code: *,1,2,10

Descriptor Code: 4

\$HASP692

Explanation:

▶▶—Nn—Mm—\$GR—*jobname*—INVALID ORIG NODE NAME — —*nodename*—▶▶

The operator at MAS member *Mn*, node *Nn*, entered the \$GR command with the O=*nodename* operand. The *nodename* specified is not defined in the node information table of the node to which the command was sent.
In the message text:

n The number of the node or the MAS member.

jobname
The name of the job.

nodename
The invalid node name.

Note: A node id *Nn* and member id *Mm* may precede \$HASP692. See "JES2 message format" on page 1.

System action: JES2 does not process the command.

Operator response: Reenter the command with a valid node name in the O= operand.

Module: HASPCOMM

Routing Code: #

Descriptor Code: –

\$HASP693

Explanation:

▶▶—Nn—Mm—\$GR—*jobname*—JOB NOT FOUND—▶▶

The operator at MAS member *Mn*, node *Nn*, entered the \$GR command for the job named in the message text, but JES2 could not find the job.
In the message text:

n The number of the node or the MAS member.

jobname
The name of the job.

Note: A node id *Nn* and member id *Mm* may precede \$HASP693. See "JES2 message format" on page 1.

System action: JES2 processing continues.

Operator response: Check command authority for this node.

Module: HASPCOMM

\$HASP694 • \$HASP695

Routing Code: #

Descriptor Code: –

\$HASP694

Explanation:

▶▶—*Nn*—*Mm*—\$GR—*jobname*—MULTIPLE JOBS FOUND—▶▶

The operator at MAS member *Mm*, node *Nn*, entered the \$GR command for the job named in the message text, but JES2 found more than one job with that job name.

In the message text:

n The number of the node or of the MAS member.

jobname
 The name of the job.

Note: A node id *Nn* and member id *Mm* may precede \$HASP694. See “JES2 message format” on page 1.

System action: JES2 does not process the command.

Operator response: Reenter the command, specifying the job type (J for a batch job, S for a started task, or T for a TSO user) and the job number. The job number is the number JES2 assigned the job at its originating node. For example, you would enter J110 to specify batch job 110.

Module: HASPCOMM

Routing Code: #

Descriptor Code: –

\$HASP695

Explanation:

▶▶—*jobid jobname*—

TOO FEW JOES
JOB IS BUSY

— - RETRY LATER—▶▶

The operator issued a \$TO or a \$T JOB command for the identified job and one of the following conditions occurred:

TOO FEW JOES

There were not enough job output elements (JOEs) available to satisfy the request.

JOB IS BUSY

The indicated job is currently being processed by JES2.

In the message text:

jobid The job identifier.

jobname
 The name of the job.

System action: Command processing continues although the indicated job is ignored.

Operator response: If **TOO FEW JOES** appears in the message, do what you can to reduce the number of jobs queued for output processing. Notify the system programmer.

If **JOB IS BUSY** appears in the message, for a \$T command, the job is scheduled to be purged and no retry is needed. For a \$TO command, retry the request when the current processing is complete.

System programmer response: If the problem continues, increase the value of the JOENUM parameter on the OUTDEF initialization statement. (A cold start is required to do this.)

Module: HASPCOMM

Routing Code: #

Descriptor Code: -

\$HASP697

Explanation:

▶▶—COMMAND PURGED - —SHARED QUEUES UNAVAILABLE—▶▶

The operator entered a command that requires exclusive control of the JES2 shared queues. These queues are not available because recovery processing is occurring on another system in the multi-access spool configuration, or because a checkpoint reconfiguration is in progress.

System action: The command is not processed.

Operator response: Ensure that another system in the multi-access spool configuration has not failed while holding the checkpoint data set lock. If one has, take corrective action as described under the \$E CKPTLOCK,HELD BY operator command in *z/OS JES2 Commands*. If another system has not failed while holding the checkpoint data set lock, reenter the command.

Module: HASPCOMM

Routing Code: #

Descriptor Code: -

\$HASP698

Explanation:

▶▶—TRACEDEF—*keyword=value,...*,—TABFREE=—*nnnn*—STATS—▶▶

STATS:

|—(—TOTDISC—*ttttt*,—DISCARDS=—*dddd*—IDS=—*a1,a2,...,an*—
|—NONE—|

JES2 issues this message in response to a \$D or \$T command that specified the TRACEDEF initialization statement. It displays the keywords defined on this statement and their current values. The description of the TRACEDEF statement in *z/OS JES2 Initialization and Tuning Reference* explains each of the keywords.

In addition, this message displays related job information. The TABFREE= keyword displays the number of unused trace tables. If this message is issued in response to a \$D or \$T command, it may optionally display statistical information.

In the message text:

keyword

The name of the keyword.

value

The value of the keyword.

nnnn

The number of unused trace tables.

TOTDISC

Total discards (since tracing was started)

tttt

The number of traces discarded since tracing was started.

DISCARDS

Discards (since last successful trace)

dddd

The number of traces discarded since the last successful trace.

\$HASP699

a1,a2,...,an

The active trace IDs.

NONE No trace IDs are currently active.

System action: Processing continues.

Operator response: None.

Module: HASCSCAN

Routing Code: #/1,2,10

Descriptor Code: -4

\$HASP699

Explanation:

▶▶—CONFLICTING OPERAND(S) DETECTED—▶▶

The operator entered a JES2 command that cannot be processed for one of these reasons:

- The command includes operands that are mutually exclusive.
- The command includes operands that are logically inconsistent with conditions in the current JES2 environment.

System action: JES2 ignores the command.

Operator response: Reenter the command with the correct operands.

Module: HASPCOMM

Routing Code: #

Descriptor Code: 4

Chapter 11. Seven-hundreds

The following JES2 messages are numbered in the 700-799 range.

\$HASP700

Explanation:

▶▶—*devname*—NOT STARTED - FSS=—*fssname* - —*reason*—▶▶

The indicated device that is controlled by the functional subsystem cannot complete start processing. The device remains in a drained state.

In the message text:

devname

The name of the unstarted device.

fssname

The name of the functional subsystem.

System action: Normal processing continues with the device drained. If the functional subsystem started, it will remain active.

Operator response: Notify the system programmer. You can reenter the \$\$ command to start the device. If the problem cannot be corrected, do one of the following:

- Enter the \$T device,MODE=JES command and then start the device as a JES-managed device with the \$\$ command. (All devices can be managed as JES devices.)
- Enter the \$T device,FSS= command to move the device to another FSS and then start the device.

In the message, *reason* is one of the following:

FSS NOT CONNECTED

JES2 detected an error in the HASPFSSM cross memory tables.

Operator Response: After the problem has been corrected, restart the printer using the \$\$ PRTnnnn command. (A residual FSS ASID may need to be canceled using the MVS CANCEL command.)

System Programmer Response: Correct the error in the HASPFSSM cross memory tables located in the FSSCB control block; specifically, check the contents of the FSSAXV field.

EXTENDED JCL SERVICES UNAVAILABLE

JES2 previously discovered an error in JCL processing and turned off extended JCL handling.

Operator Response: This device is available only as a JES2-managed device. Use the \$T dev,MODE=JES command to put this device in JES2 mode.

System Programmer Response: Correct the JDT library. After a warm start, this device can be a functional subsystem-managed device.

PROCESSING TO START FSS FAILED

SVC 34 through the MGCR macro failed.

System Programmer Response: Determine why SVC 34 failed using the return code in the accompanying \$HASP703 message. For a description of the return code, see *z/OS MVS Programming: Authorized Assembler Services Reference LLA-SDU*.

FSS FAILED TO CONNECT

The functional subsystem did not connect within a predetermined amount of time. This could be caused by a JCL error in the procedure to start the functional subsystem or by problems in the functional subsystem.

System Programmer Response: This message is accompanied by the \$HASP703 message or other messages indicating the error condition. Use the accompanying messages to correct the problem.

\$HASP700

Do the following:

- Save the console sheet from the primary console.
- Issue the LIST CDS and LIST PTFBY functions of SMP/E, if SMP/E is used to make all changes to the system. Use the LISTIDR function of the AMBLIST service aid program to obtain a list of all members with a PTF or local fix, if any changes are made to the system without SMP/E.
- Save all of the output associated with the problem.
- Contact the IBM Support Center for assistance.

FSA FAILED TO CONNECT

The functional subsystem application did not connect because of an error in the functional subsystem.

System Programmer Response: This message is accompanied by the \$HASP703 message or other messages indicating the error condition. Use the accompanying information to correct the problem.

Do the following:

- Save the console sheet from the primary console.
- Issue the LIST CDS and LIST PTFBY functions of SMP/E, if SMP/E is used to make all changes to the system. Use the LISTIDR function of the AMBLIST service aid program to obtain a list of all members with a PTF or local fix, if any changes are made to the system without SMP/E.
- Save all of the output associated with the problem.
- Contact the IBM Support Center for assistance.

START FSA ORDER UNSUCCESSFUL

The functional subsystem could not process the order to start the functional subsystem application (FSA) successfully.

System Programmer Response: If the device was started under an already active FSA, ensure that the FSS supports multiple FSAs; if not, change JES2 initialization parameters to specify a unique FSS procedure name for this device. Additional information can be found in the \$HASP703 message.

Do the following:

- Save the console sheet from the primary console.
- Issue the LIST CDS and LIST PTFBY functions of SMP/E, if SMP/E is used to make all changes to the system. Use the LISTIDR function of the AMBLIST service aid program to obtain a list of all members with a PTF or local fix, if any changes are made to the system without SMP/E.
- Save all of the output associated with the problem.
- Contact the IBM Support Center for assistance.

STORAGE UNAVAILABLE FOR FSACB

\$GETMAIN for the FSA control block failed.

System Programmer Response: See the return code issued in the \$HASP703 message and see *z/OS MVS Programming: Assembler Services Reference ABE-HSP* for an explanation of the return code.

START DEVICE ORDER UNSUCCESSFUL

The functional subsystem could not process the order to start the device successfully.

System Programmer Response: See the accompanying \$HASP703 message for additional information.

Do the following:

- Save the console sheet from the primary console.
- Issue the LIST CDS and LIST PTFBY functions of SMP/E, if SMP/E is used to make all changes to the system. Use the LISTIDR function of the AMBLIST service aid program to obtain a list of all members with a PTF or local fix, if any changes are made to the system without SMP/E.
- Save all of the output associated with the problem.
- Contact the IBM Support Center for assistance.

CROSS-MEMORY SERVICES UNAVAILABLE

The cross-memory authorization index reserve was not successfully set during initialization. Because of the lack of communication services, the functional subsystem cannot be started.

System Programmer Response: See the \$HASP856 message for additional information about the error condition.

MAXIMUM FSA (DEVICE) COUNT EXCEEDED

The device could not be started because too many devices are already active on the functional subsystem.

System Programmer Response: See the accompanying \$HASP703 message for more information.

Operator Response: You must move the device to a different FSS, drain devices currently active on the FSS, or shut down the FSS and then restart it. For more information, see the operator response for the \$HASP703 message.

DEVICE NUMBER NOT SUPPORTED

The device is assigned a 4-digit device number but the functional subsystem (FSS) does not support 4-digit device numbers.

Operator Response: Notify the system programmer.

System Programmer Response: Use the \$D device command to display the device characteristics. Dynamically reconfigure the device to assign it a 3-digit device number. Use the \$S command to restart the device.

Module: HASPFSSP

Routing Code: 1,2,10

Descriptor Code: 4

\$HASP701

Explanation:

```

▶▶—devname—NOT DRAINED - FSS=fssname - ———— STOP DEVICE ORDER UNSUCCESSFUL —————▶▶
                                     | STOP FSA ORDER UNSUCCESSFUL |
                                     | FSA FAILED TO DISCONNECT |

```

devname NOT DRAINED - FSS=*fssname* -

```

{ STOP DEVICE ORDER UNSUCCESSFUL }
{ STOP FSA ORDER UNSUCCESSFUL }
{ FSA FAILED TO DISCONNECT }

```

The indicated device controlled by functional subsystem *fssname* cannot be completely drained. The device remains in the last phase completed successfully. That is, if the functional subsystem application (FSA) is not successfully stopped after the stop device order is successful, the device is not restarted.

In the message text:

devname

The name of the device.

fssname

The name of the functional subsystem.

STOP DEVICE ORDER UNSUCCESSFUL

The functional subsystem application could not successfully process the order to stop the device.

STOP FSA ORDER UNSUCCESSFUL

The functional subsystem could not successfully process the order to stop the functional subsystem application.

FSA FAILED TO DISCONNECT

The functional subsystem application did not disconnect within a predetermined amount of time after a STOP FSA order was issued.

System action: Normal operation continues. No work is selected by the indicated device. The device is left in the draining state.

Operator response: Notify the system programmer. The \$P command can be entered for the device again. If this message appears during \$PJES2 processing, the system will not withdraw and a \$PJES2,ABEND may be required to withdraw JES2 from the system. Use the MVS CANCEL command to cancel the functional subsystem address space with a dump.

\$HASP702 • \$HASP703

Save the hard-copy log. For systems with remote consoles, save the remote console sheet.

System programmer response: If the system issues message \$HASP703 along with this message, use the return code issued in message \$HASP703 and the appropriate functional subsystem (FSS) documentation to analyze the error.

If you use SMP/E to make all changes to the system, use the LIST CDS and LIST PTFBY functions of SMP/E to obtain a list of the current maintenance from the SMP/E control data set (CDS).

If you make any changes to the system without using SMP/E, run the LISTIDR function of AMBLIST to obtain a list of all members with a PTF or local fix and save the output. Run LISTIDR against the following:

- SYS1.LINKLIB.
- SYS1.SVCLIB
- The library containing the program that issued the message.
- SYS1.LPALIB

Save all the associated output and contact the IBM Support Center for assistance.

Module: HASPFSSP

Routing Code: 1,2,10

Descriptor Code: 4

\$HASP702

Explanation:

```
▶▶—FSS—fssname—NOT STOPPED—STOP FSS ORDER UNSUCCESSFUL—▶▶
                               |
                               |—FSA FAILED TO DISCONNECT—|
```

The functional subsystem could not be stopped, but all functional subsystem applications (FSAs) associated with this functional subsystem have successfully stopped.

In the message text:

fssname

The name of the functional subsystem.

STOP FSS ORDER UNSUCCESSFUL

The functional subsystem could not successfully process the order to stop the functional subsystem.

FSS FAILED TO DISCONNECT

The functional subsystem did not disconnect within a predetermined amount of time after a STOP FSS order was issued.

System action: JES2 does not withdraw from the system while functional subsystems remain active.

Operator response: Notify the system programmer. A \$PJES2,ABEND is required to withdraw JES2 from the system. Use the MVS CANCEL command to cancel the functional subsystem address space with a dump.

System programmer response: If this message is accompanied by the \$HASP703 message, use the return code issued in \$HASP703 and the appropriate FSS documentation to analyze the error.

Module: HASPFSSP

Routing Code: 1,2,10

Descriptor Code: 4

\$HASP703

Explanation:

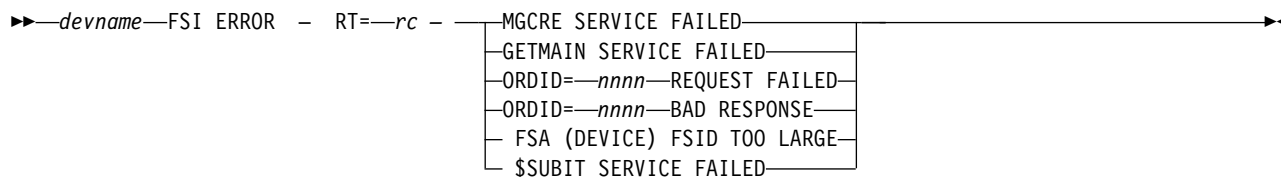

JES2 (HASPFFSSP) detected an incorrect or unsuccessful return code from a system or functional subsystem interface (FSI) service routine during FSI processing. The return code is displayed as the RT= value. The text following the message indicates the service that was detected as failing. If the text indicates an FSI order failure, ORDID= gives the ID of the order that failed.

In the message text:

devname

The name of the device.

rc

A return code.

nnnn

The identifier of the failed order.

MGCRC SERVICE FAILED

The service used to issue the start command to start the FSS address space failed. RT=rc indicates the MGCRC return code.

GETMAIN SERVICE FAILED

The request to allocate virtual storage failed. RT=rc indicates the GETMAIN return code.

ORDID=nnnn REQUEST FAILED

The request for an FSS/FSA order (JES2 command) failed. RT=rc indicates the FSIREQ return code.

ORDID=nnnn BAD RESPONSE

The FSS/FSA returned an incorrect response to an FSS/FSA order (JES2 command).

FSA (DEVICE) FSID TOO LARGE

When the first device was started under this FSS, the number of devices assigned to this FSS at that time was used to perform some FSS initialization. The number was inflated at that time to allow for additional devices to be moved to the FSS using JES2 commands. Because the maximum number of devices for this FSS has now been reached (by moving and starting too many devices), the identifying FSI FSID for this device is too large.

RT=hhhh indicates the maximum number of devices, in hexadecimal, that can be active in this FSS at one time. You must shut down the FSS and restart it to change this number.

\$SUBIT SERVICE FAILED

The \$SUBIT service was used to issue the start command; however, it was unable to complete the request. RT=rc indicates the \$SUBIT return code.

System action: The system action depends upon the current processing being performed. If the service failure is detected during functional subsystem (FSS) start, drain, or stop processing, this message is typically followed by \$HASP700, \$HASP701, or \$HASP702. Refer to this accompanying message for the system action taken. If the failure is detected during functional subsystem interface (FSI) order (JES2 command) processing, this message is followed by \$HASP152, and system operation continues.

Operator response: Notify the system programmer. If the \$HASP703 message is followed by \$HASP700, \$HASP701, or \$HASP702, see the operator response for that message. If the \$HASP703 message is followed by \$HASP152, reenter the JES2 command.

System programmer response: Determine the cause of the service failure from the return code displayed in the message. Correct the problem and see the action for \$HASP700, \$HASP701, or \$HASP702, if appropriate.

Note: If the return code is from the FSI order service, contact the appropriate FSS documentation for a description of the return code and any actions that are required.

Module: HASPFFSSP

Routing Code: 1,2,10

Descriptor Code: 4

\$HASP704

\$HASP704

Explanation:

►►—*jobid jobname*—DATA SET UNPRINTABLE— — OUTGRP—*grpid.joeid1.joeid2*—HELD — —

FSS
JES

—————►

►—REASON—(—*rsnc*—)—HOLDRC=—*nnn,text*—————►

jobid jobname DATA SET UNPRINTABLE – OUTGRP *grpid.joeid1.joeid2*

HELD {FSS|JES} REASON (*rsnc*) HOLDRC=*nnn*,
text

A data set was sent to a functional subsystem application running under the control of the functional subsystem, but the data set could not be printed. As a result, the output group was marked unselectable and was requested.

In the message text:

jobid The job identifier.

jobname
The name of the job.

grpid The group identifier. This is a 1 to 8-character alphanumeric name either specified by the user's JCL or, if not specified by the user, generated by JES2.

joeid1 A number assigned by JES2 and is used to identify how many job output elements there are within the output group.

joeid2 A number assigned by JES2 that determines the number of job output elements within the output group identified by *groupid.joeid1*.

rsnc The reason code returned by either JES2 or the FSS.

nnn The hold reason code.

text An explanation of why JES2 held the output group.

Possible values of *nnn* and *text* are:

nnn *text*

001 FSI RELDS Unprintable - SWB error

002 FSI RELDS Unprintable - FSA

System action: Processing continues.

Operator response: Notify the system programmer. After the problem that caused the data set to be unprintable is fixed, make the data set selectable by entering the \$TO command.

System programmer response:

HOLDRC=

Meaning

001 Indicates that JES2 processing (in module FSSM) in an FSS address space detected a problem with SWB data. Check SYSLOG for prior JES2 messages for additional information concerning this error.

002 Indicates that a functional subsystem application (FSA) detected an error and issued a release data set (RELDS) order to JES2 to indicate that the FSA cannot print the data set. Check SYSLOG and any output that was produced by the FSA for messages concerning why the FSA issued the RELDS.

Based on prior SYSLOG or output messages, correct the problem that caused the data set to be nonprocessable.

Module: HASPFSSP

Routing Code: 7

Descriptor Code: 4

\$HASP705

Explanation:

▶▶—*device*—TERMINATING - FSS=—*fssname*— - FSA INITIATED TERMINATION————▶▶

The indicated device controlled by the functional subsystem (*fssname*) has requested a stop. In the message text:

device The name of the device.

fssname
The name of the functional subsystem.

System action: Normal operation continues. No work is selected by the indicated device. The device stops and drains.

Operator response: Determine why the device was stopped by examining the FSS-issued messages. Save the dump, the console sheet, remote console sheet, and, for systems with Multiple Console Support (MCS), a copy of the hardcopy log.

Module:

HASPFSSP

Routing Code: 1,2,10

Descriptor Code: 4

\$HASP706

Explanation:

▶▶—*devname* - —WAITING FOR RESPONSE—FROM FSS=—*fssname*—

FSS NOT STOPPED
FSA NOT STOPPED
DEVICE NOT STOPPED
FSS NOT STARTED

————▶▶

▶—TIME=—*nnnn*—MINUTES————▶▶

JES is waiting for a response from the FSS to an outstanding order. JES2 issues this message at five minute intervals until a response is received from the FSS. TIME= is the number of minutes since the message was first issued, and will not be incremented past TIME=995. When JES2 receives the proper response, FSS processing will resume. In the message text,

devname
The name of the device.

fssname
The name of the functional subsystem.

nnn The time in minutes.

System action: Normal operation continues. Nothing is selected by the device until a response is received from the FSS.

Operator response: Notify the system programmer.

System programmer response:

1. Try to identify why the FSS is not responding. If it is not obvious, obtain console dumps from both the JES2 and FSS ASIDS (including private region and CSA) to identify why the FSS is not responding.
2. In the case of installation with PSF, issue the MVS MODIFY command against the failing FSS(PSF) printer. The MODIFY command is described in PSF documents. For example, MODIFY FSSNAME,FORCE,PRTNNNN.
3. If item 2 fails to relieve the problem, issue an MVS CANCEL command against the failing FSS ASID.

\$HASP708

4. If item 3 fails, JES2 needs to be hot started. Use the \$PJES2,ABEND command only if all other attempts to recover the device fail.

Module: HASPFSSP

Routing Code: 1,2,10

Descriptor Code: 4

\$HASP708

Explanation:

```
▶▶-jobname-┐-OPEN-┐-FAILED-┐-RC=-xx-┐-reason-┐-DSNAME=-┐-dsn-▶▶
            └-ddname-┘      └-ERROR-┘
                        └-ERROR - DATA SET WAS NOT CLOSED-┘
```

Where *reason* is one of the following:

SJB LOCK COULD NOT BE OBTAINED
BUFFER DATA SPACE INACCESSIBLE
DATA SET ALREADY OPENED
BUFFER NOT AVAILABLE
SVC111 POINT ERROR
I/O ERROR READING DATA BUFFER
TRACK ADDRESS NOT VALID
END OF DATA NOT FOUND
ERROR PROCESSING SWB
RACROUTE ERROR
AUTHORIZATION FAILURE
DATA SET ON INACTIVE VOLUME
SDB/IRWD VALIDATION ERROR
INTRDR LRECL NOT VALID
INTERNAL \$TRACK ERROR
ERROR PROCESSING SWB, SJF FAILURE
ERROR PROCESSING SWB, GASSIGN
FAILURE
ERROR PROCESSING SWB, CBIO
FAILURE
GETMAIN FAILURE PROCESSING I/O
ERROR

An OPEN macro instruction for a subsystem data set has failed. The *ddname* field indicates the DDNAME of the data set if one could be determined.

In the message text:

jobname

The name of the job.

ddname

The name of the DD statement.

xx

The reason code.

reason Explanatory text accompanying the reason code.

dsn The name of the data set.

FAILED

Indicates that the open request will fail.

ERROR

Indicates that an error was encountered but that the open will be allowed to complete.

ERROR - DATA SET WAS NOT CLOSED

Indicates that an existing data set is being opened however, when created, the data set never went through close processing. Because of this, some data may have been lost.

Possible values of *xx* and *reason*, plus their meanings, are:

<i>xx</i>	<i>reason</i>
01	SJB LOCK COULD NOT BE OBTAINED JES2 is unable to obtain the needed SJB serialization because either the job is terminating or the current holder of the lock is non-dispatchable for dump processing.
02	BUFFER DATA SPACE INACCESSIBLE The current address space does not have access to the PBUF data space.
03	DATA SET ALREADY OPENED The data set has already been opened. It cannot be opened again without an intervening CLOSE.
04	BUFFER NOT AVAILABLE Buffers for a data set were not available.
05	SVC111 POINT ERROR An SVC 111 failed when issued from OPEN processing.
06	I/O ERROR READING DATA BUFFER An I/O error occurred during TGB queuing.
07	TRACK ADDRESS NOT VALID During a job restart, JES2 was unable to find the data for a data set that had existed during the last job checkpoint.
08	END OF DATA NOT FOUND EOD was not found during restart processing for a SYSOUT data set.
09	ERROR PROCESSING SWB Scheduler work blocks (SWBs) could not be processed.
10	RACROUTE ERROR JES2 was unable to obtain the security information for the job requesting the open.
11	AUTHORIZATION FAILURE The userid associated with the job attempting to open a data set did not have the authority to open the data set.
12	DATA SET ON INACTIVE VOLUME An I/O operation was attempted on an inactive volume.
13	SDB/IRWD VALIDATION ERROR The SDB/IRWD address passed to JES2 was not valid. This error might have occurred because the return JOBID SSI was not issued.
14	INTRDR LRECL NOT VALID LRECL for an internal reader data set greater than 256.
15	INTERNAL \$TRACK ERROR An internal error occurred in \$TRACK when issued from OPEN processing.
16	ERROR PROCESSING SWB, SJF FAILURE An SJF failure occurred while processing a SWB from OPEN processing.
17	ERROR PROCESSING SWB, GASSIGN FAILURE An error occurred while assigning a generic grouping token to a PDDB during OPEN processing.
18	ERROR PROCESSING SWB, CBIO FAILURE A CBIO failure occurred while processing a SWB from OPEN processing.
19	GETMAIN FAILURE PROCESSING I/O ERROR A GETMAIN failure occurred while processing a TGB from OPEN processing.

Note: A jobid may precede \$HASP708. See "JES2 message format" on page 1.

System action: JES2 processing continues.

Operator response: Notify the system programmer.

\$HASP709

System programmer response: Correct the problem as appropriate and resubmit the job. For reason code 11, see your security administrator to ensure the userid being used for this job is properly defined to your security product.

Module: HASCDSOC

Routing Code: 10

Descriptor Code: 6

\$HASP709

Explanation:

▶▶—JES2 INITIALIZATION DELAYED — *reason* —▶▶

This highlighted message indicates that JES2 initialization processing has been delayed because of the reason displayed. This message informs the operator of a delay of at least 30 seconds (except as noted on specific delay reasons listed below). Action may only be required if the delay persists.

In the message text, *reason* is one of the following:

CHECKPOINT DATA SET RESERVE

JES2 is waiting for exclusive control of the checkpoint. If the checkpoint is on DASD, an MVS RESERVE has been issued. If the checkpoint is on a coupling facility structure, a LOCK request has been issued for the structure.

One possible cause of the delay is an active member with a high value set for MASDEF HOLD=.

ASSIGNABLE UNIT INITIALIZATION

JES2 issued a call to the MVS IEFAUINT service to initialize all assignable units (for example, tape drives). This service might perform I/O to any assignable devices which can cause a delay if there is a problem with the I/O.

JES2AUX ADDRESS SPACE CREATE

JES2 initialization processing has started processing to create the JES2AUX address space. JES2 is waiting for the address space to be created and complete its initialization processing. Something has delayed this process. Determine what the status of the JES2AUX address space is and resolve the cause of the delay.

JESXCF JOIN

JES2 issued the MVS IXZXIXAT macro to join the XCF group as specified on the XCFGRPNM= parameter of the MASDEF initialization statement. If there are problems with JES XCF or with accessing the sysplex couple data set, the request could be delayed.

JESXCF HAS NOT RESPONDED TO AN IXZXIXIF REQUEST FOR MEMBER INFORMATION

JES2 issued the MVS IXZXIXIF macro to obtain current member information of all members of the XCF group as specified on the XCFGRPNM= parameter of the MASDEF initialization statement. If there are problems with JES XCF or with accessing the sysplex couple data set, the request could be delayed. This reason is issued when JES2 detects a delay of at least 3 seconds.

IXCQUERY REQUEST

JES2 issued the MVS IXCQUERY macro to determine if a structure as specified on either the CKPTn= or NEWCKPTn= parameter of the CKPTDEF initialization statement exists. If there is a problem with JES XCF or with accessing the sysplex couple data set, the request could be delayed.

QUERYING OTHER MEMBER FOR CKPT SPECIFICATION

JES2 issued the MVS IXZXIXSM macro to send a request for information to other members in the MAS. JES2 is waiting for a member to reply with the current JES2 checkpoint configuration information. The request can be delayed if: a checkpoint reconfiguration is currently in progress, JES XCF is experiencing a problem delivering messages, or another member of the MAS is experiencing problems.

ISSUING ENF SIGNAL EXIT FOR EVENT CODE 40

JES2 has issued a call to the ENFREQ service to issue the ENF signal exit for event code 40. Something has delayed this process.

JES2 INITIALIZATION DELAYED - SPOOL MIGRATION RESTART

JES2 has detected an active migration and is performing the processing to deal with this member initializing during the active migration.

System action: JES2 initialization continues or may wait for some MVS service to complete. When the requested function completes, the messages is deleted.

Operator response: If the delay continues for an extended period of time, attempt to determine the cause of the delay and correct the problem.

System programmer response: This message may be informational only and the delay may be normal in your environment. However if this message remains for an extended period of time, an MVS corrective action might be required.

Module: HASPIRMA, HASPIRDA, HASPIRPL, HASPIRSI

Routing Code: 1,2,10

Descriptor Code: 2,7

\$HASP710

Explanation:

▶▶—THIS LEVEL OF JES2 IS— INCOMPATIBLE WITH—*reason*—ONE OR MORE ACTIVE MEMBERS—————▶▶

▶—MEMBER=—*memname*,—REASON=—*reason*— , . . . , —MEMBER=—*memname*,—REASON=—*reason*—————▶

During initialization processing, JES2 detected active members in the MAS that are incompatible with the initializing member.

In the message text:

memname

The name of the active member that is incompatible with the initializing member.

reason

The reason that the active member is incompatible.

The *reason* is one of the following:

MEMBER IS DOWN-LEVEL

The member is at a lower release than the initializing member.

MEMBER IS UP-LEVEL

The member is at a higher release than the initializing member.

MEMBER LEVEL IS NOT SET

The member level is not set.

System programmer response: If the releases are compatible, compatibility PTFs may be required on either the initializing member or the members identified by the message. If the problem cannot be resolved, search problem reporting data bases for a fix for the problem. If no fix exists, contact the IBM Support Center.

Module: HASPIRDA

Routing Code: 1,2,10

Descriptor Code: 4

\$HASP711

Explanation:

▶▶—ERROR ESTABLISHING—JES2 PC LINKAGE—*reason*—————▶▶

JES2 encountered an error when attempting to define the program call (PC) linkage. If this is a hot start, the new PC linkage table is not the same as the one used on the last start. The table cannot be changed on a hot start. You must

\$HASP712

either start the correct service level of JES2 or re-IPL your system. If an error text (*reason*) is displayed, it indicates a problem building the PC linkage.

If *errcode*=4, then the ASCRE to create the JES2 auxiliary address space failed. RC= and REASON= are the return code and reason code from the ASCRE service.

If *errcode*=8, then an error was encountered in the JES2 auxiliary address space.

In the message text:

reason One of the following:

- NUMBER OF SYSTEM PC ROUTINES CHANGED ON A HOT START
- ATTRIBUTES OF SYSTEM PC ROUTINES CHANGED ON A HOT START
- ERROR=*errcode*,RC=*return_code*, REASON=*reason_code*

System action: PC linkage is not established. Processing continues.

System programmer response: Contact the IBM Support Center for more information.

Module: HASPSRAX

Routing Code: 1,2,10

Descriptor Code: 4

\$HASP712

Explanation:

▶▶—ERROR DURING WORKLOAD MANAGER—*func*—SRVCLASS=—*srvclass*—▶▶

▶,—RC=—*return code*—REASON=—*reason code*—▶▶

A WLM error has been detected.

Func Explanation

CONNECT

Error connecting to WLM. JES2 terminates.

WLM Service: IWMCONN

POLICY QUERY

Error obtaining current WLM SERVICE definition.

WLM Service: IWMPQRY

BATCH REGISTRATION and BATCH DEREGISTRATION

Error during registering or deregistering the batch class.

WLM Service: IWMBREG, IWMBDREG

CLASSIFICATION

An unrecoverable error was IWMCLSFY detected while classifying a job.

WLM Service: IWMCLSFY

DISCONNECT

Error disconnecting from IWMDISC WLM.

WLM Service: IWMDISC

SRVCLASS=

The WLM Service class that was being processed for functions of BATCH REGISTRATION and BATCH DEREGISTRATION.

REASON=

The reason code returned by the WLM request

RC= The return code from the WLM request.

System action: System continues. If the func issuing the message is CONNECT, JES2 ends.

System programmer response: Contact the IBM support center.

Module: HASPIRPL, HASPCKPT, HASPTERM, HASPXEQ

Routing Code: 1,2,10

Descriptor Code: 4

\$HASP713

Explanation:

▶▶—INCLUDE DSNAME=—*dsname*,—VOLSER=—*volser*,—UNIT=—*unit*—▶▶

JES2 issues this message in response to an INCLUDE or a D INCLUDE initialization statement. It displays the current data set JES2 is reading initialization statements from.

dsname The data set name and optional member name from which JES2 is reading initialization statements.

volser The volume serial number of the data set being read.

unit The unit value for the data set (if specified on an INCLUDE initialization statement).

The description of the INCLUDE statement in *z/OS JES2 Initialization and Tuning Reference* explains the parameters displayed in this message.

System action: Processing continues.

Operator response: None.

System programmer response: None.

Module: HASCSCAN

Routing Code: 1,2,10

Descriptor Code: 4

\$HASP714

Explanation:

▶▶—JES2 TERMINATION PROCESSING AWAITING—*nnnnnnnn*—ADDRESS SPACES—▶▶

▶
└ DUMP INITIATED. ISSUE \$PJES2,ABEND FOR IMMEDIATE JES2 SHUTDOWN ┘▶▶

JES2 is attempting to terminate in response to a \$PJES2 command. There are *nnnnnnnn* address space(s) other than JES2 which are preventing JES2 termination.

System action: This message will continue to be displayed until JES2 is able to shut down, or until JES2 detects that there is no progress being made in address space termination. In this case, a dump is taken of the address space(s) that are preventing JES2 termination. Note that if you receive the "DUMP INITIATED" form of \$HASP714 and a dump was not taken, this indicates that JES2 termination is proceeding as intended.

Operator response: Notify the system programmer.

System programmer response: Save the dump taken as indicated by the \$HASP714 message and contact the IBM support center. The \$PJES2,ABEND command may be issued to allow JES2 to terminate after the dump has been taken.

Module: HASPXEQ

Routing Code: 1,2,10

Descriptor Code: 2,7

\$HASP715 • \$HASP720

\$HASP715

Explanation:

ADDRESS SPACES AWAITING RETURN JOBJID

ASID	JOBNAME
-----	-----
<i>asid</i>	<i>jobname</i>

Note: JES2 displays up to 5 ASIDs and JOBNAMEs.

JES2 is attempting to terminate in response to a \$PJES2 command. The listed address spaces are preventing JES2 termination because they have not performed a return jobid call.

System action: The message will continue until JES2 detects that no more address space requires a return jobid call.

Operator response: Notify the system programmer.

System programmer response: Perform a return jobid for the listed address spaces.

Module: HASPXEQ

Routing Code: 1,2,10

Descriptor Code: 2,7

\$HASP720

Explanation:

▶▶—WARM START DENIED —*reason*—▶▶

The warm start was denied, where *reason* is one of the following:

EAV EXTENDED ADDRESSING SUPPORT HAS BEEN ACTIVATED IN THE MAS. THIS RELEASE DOES NOT SUPPORT EAV EXTENDED ADDRESSING.

JES2 members prior to z/OS V1R12 are not allowed to join the MAS once EAV Extended Addressing Support has been enabled with SPOOLDEF,CYL_MANAGED=ALLOWED. Even if CYL_MANAGED=FAIL is later set, members prior to JES2 z/OS V1R12 will not be allowed to join the MAS.

SPOOL VOLUME VOLSER IS IN A MIGRATING STATE. THIS RELEASE DOES NOT SUPPORT MIGRATING SPOOL VOLUMES.

JES2 members prior to JES2 z/OS V1R13 are not allowed to join the MAS if a \$MSPL migrate SPOOL command is active or pending, or if the SPOOL volume is MAPPED. A z/OS V1R13 member existing in a mixed MAS will reject a migrate SPOOL command.

SPOOLDEF VOLUME= PREFIX CONTAINS GENERIC CHARACTERS. THIS RELEASE DOES NOT SUPPORT GENERICS IN THE SPOOL VOLUME PREFIX.

JES2 members prior to JES2 z/OS V1R13 are not allowed to join the MAS because they do not support generic characters in the SPOOL volume prefix. A z/OS V1R13 member existing in a mixed MAS will reject a \$T SPOOLDEF command that tries to utilize a generic SPOOL volume prefix.

SPOOL VOLUME VOLSER DATA SET IS BEING EXTENDED. THIS RELEASE DOES NOT SUPPORT EXTENDING SPOOL VOLUME DATA SETS.

JES2 members prior to JES2 z/OS V1R13 are not allowed to join the MAS if a \$TSPL,SPACE= extend SPOOL command is active or pending. A z/OS V1R13 member existing in a mixed MAS will reject an extend SPOOL command.

A multiple character job class or a job class group is currently defined. This release does not support job class groups and only supports single character batch job classes.

JES2 members prior to JES2 z/OS V2R1 are not allowed to join the MAS if a multiple character job class or a job class group is defined in the MAS.

The first \$HASP720 condition encountered will cause the message to display and the WARM start to fail. The other \$HASP720 conditions might also exist. The \$HASP720 message might be preceded by a \$HASP896 DAS VERIFICATION AND REBUILD HAS COMPLETED message, which is typical and does not indicate an error in the DAS.

System action: The WARM start is terminated.

Operator response: None.

System programmer response: None.

Module: HASPIRDA

Routing Code: 1,2,10

Descriptor Code: 4

\$HASP732

Explanation:

▶▶ GRPDEF ZJCNUM=*zjcs*, ZJCFREE=*free*, ZJCWARN=*cc* ▶▶

▶ CONCURRENT_MAX=*conmax* JOBGROUP_JOB_MAX=*jobmax*, ▶

Alternate output:

GRPDEF	CURRENT ZJC UTILIZATION
TYPE	COUNT
-----	-----
<i>name</i>	<i>count</i>

This message is issued in response to a \$D or \$T command that specified the GRPDEF statement. The message displays the keywords defined on this statement and their current values.

This message displays the following GRPDEF information:

ZJCNUM

The number of ZJCs (Zone Job Container) entries defined in the checkpoint.

ZJCFREE

The current number of free ZJC entries.

ZJCWARN

The threshold of ZJC utilization at which the \$HASP050 message should be issued.

CONCURRENT_MAX

Displays the maximum number of dependent jobs that can exist in a single concurrent set within a job group. A value of zero indicates concurrent sets are not supported.

JOBGROUP_JOB_MAX

Displays the maximum number of dependent jobs that can be defined to a single job group.

This message is also issued in response to a \$D command that specified GRPDEF with the ZJCUSE keyword. The message displays all of the types of ZJCs that are supported by the system and the number of ZJCs associated with each type.

name (column 1)

The name associated with the ZJC usage.

count (column 2)

The count of ZJCs that are associated with this name.

System action: Processing continues.

System programmer response: None.

Module: HASCSCAN

System action: None.

Operator response: None.

System programmer response: None.

| **Module:**

| HASPCKDA, HASPSPOL

| **Routing Code:** 1, 2

| **Descriptor Code:** 4

\$HASP741

Explanation:

▶▶—VOLUME—xxxxxx—EXTEND UNSUCCESSFUL—ERROR CODE—=—yyzzzzzzzzzz—▶▶

The extend of spool volume xxxxxx was unsuccessful. Error code yyzzzzzzzzzz was returned, and possibly one of the following explanations:

- Error code = 60, Insufficient space.
- Error code = 64, No extent on volume.
- Error code = 68, Already that size.

System action: The SPOOL extend is discontinued.

Operator response: For an insufficient space message, specify SPACE=MAX for the largest extent possible on the volume.

Use a VTOC reporting utility, such as IEHLIST, to determine the layout and size of data sets on the volume in relation to the JES2 spool data set extent.

System programmer response: None.

Module: HASPSPOL.

Routing Code: 1,2

Descriptor Code: 4

\$HASP742

Explanation:

▶▶—CANNOT EXTEND VOLUME—xxxxxx—IT IS INACTIVE—▶▶

The extend of SPOOL volume xxxxxx was unsuccessful because the volume is inactive.

System action: The spool extend is discontinued.

Operator response: Start the SPOOL volume using the \$\$SPL command and then attempt the extend.

System programmer response: None.

Module: HASPSPOL

Routing Code: 1,2

Descriptor Code: 4

\$HASP743

Explanation:

▶▶—CANNOT EXTEND VOLUME—xxxxxx—IT IS A MAPPED VOLUME OR IS—ASSOCIATED WITH AN ACTIVE MIGRATION—▶▶

\$HASP744 • \$HASP745

The extend of SPOOL volume *xxxxxx* was discontinued because it is a mapped volume or is associated with an active migration.

System action: The SPOOL extend is discontinued.

Operator response: A MAPPED volume cannot be extended. If the spool volume is associated with an active migration, wait for the migration to complete and retry the extend.

System programmer response: None.

Module: HASPSPOL

Routing Code: 1,2

Descriptor Code: 4

\$HASP744

Explanation:

▶▶—CANNOT EXTEND VOLUME—*xxxxxx*—IT IS IN THE WRONG FORMAT—▶▶

SPOOL volume *xxxxxx* cannot be extended because it is in the wrong format.

System action: The SPOOL extend is discontinued.

Operator response: None.

System programmer response: None.

Module: HASPSPOL

Routing Code: 1,2

Descriptor Code: 4

\$HASP745

Explanation:

| ▶▶—Volume *volserData* set *dsname* EXTEND UNSUCCESSFUL—▶▶
|

| ▶▶—Internal Error, diagnostic code *wyyyzz*—▶▶
|

| ▶▶—Error code = 60, Insufficient space.—▶▶
|

| ▶▶—Error code = 64, No extent on volume.—▶▶
|

| ▶▶—Error code = 68, Already that size.—▶▶
|

| JES2 was unable to extend the checkpoint or SPOOL data set displayed. The reason for the failure is listed.

| **Internal Error, diagnostic code** *wyyyzz*

| An internal error was encountered. The reason code listed in that of the internal service. Contact IBM service for more information on the reason for the failure.

| **Error code = 60, Insufficient space**

| There was insufficient contiguous space to satisfy the request. Data sets can only be extended if there is free space after the current data set.

- | **Error code = 64, No extent on volume**
- | This should not occur but the internal service attempted to access the data set on the volume and was
- | unable to locate it. This is likely because the data set was deleted.
- | **Error code = 68, Already that size**
- | The data set is already the size requested.
- | **System action:** The extend of the SPOOL or checkpoint data set listed was discontinued.
- Operator response:** Notify the system programmer.
- System programmer response:** Contact your service representative with the message information.
- | **Module:** HASPCKDA, HASPSPOL
- Routing Code:** 1,2
- Descriptor Code:** 4

\$HASP750

Explanation:

▶▶—JES2 FSI ERROR. CODE=*code*,—RC=*rc*—*text*————▶▶

A catastrophic error has occurred within the JES2 functional subsystem interface (FSI) support routines (HASPFSM) for which JES2 has issued a \$ERROR macro. The message is issued from the HASPFSM catastrophic error routine, FSMCATER, invoked through the \$ERROR macro. In the message text:

- cde** The decimal code returned from the FSI.
- rc** The return code returned from the FSI.
- text** The explanatory text accompanying the codes.

Register 15 contains the return code (rt) in the first four digits, and the reason code (rc) in the last four digits:

```
0008|0001
  rt  rc
```

The following list shows cde, rc, and text:

cde **text**

\$F00 GETCELL SERVICES ERROR

An error occurred within the FSMGETQC routine in module HASPFSM. A reason code is displayed and placed in register 15 indicating one of the following errors:

- | rc | Meaning |
|-----------|--|
| 01 | The number of cells to get (passed through \$GETQC in R1) is less than or equal to 0 or greater than QCTLIMIT. |
| 02 | A SETLOCK RELEASE request failed. The return code from SETLOCK is in bits 0-15 of the reason code. |
| 03 | The GETCELL service failed. The return code from GETCELL is in bits 0-15 of the reason code. |

\$F01 FREECEL SERVICES ERROR

An error occurred within the FSMFREQC routine in module HASPFSM. A reason code is set indicating one of the following errors:

- | rc | Meaning |
|-----------|--|
| 01 | The number of cells to get (passed through \$FREQC in R1) is less than or equal to 0 or greater than QCTLIMIT. |
| 02 | The FREECELL service failed. The return code from FREECELL is in bits 0-15 of the reason code. |

\$HASP750

\$F02 GETCELL EXTENSION ERROR

An error occurred within the FSMBLDQC routine in module HASPFSSM. A reason code is set indicating one of the following errors:

rc	Meaning
----	---------

05	The BLDCPOOL service failed. The return code from BLDCPOOL is in bits 0-15 of the reason code.
----	--

06	The GETMAIN request for the (additional) cell pool failed. The return code from GETMAIN is in bits 0-15 of the reason code.
----	---

\$F03 QUICKCELL INIT ERROR

An error occurred within the FSMQCT routine in module HASPFSSM. A reason code is set indicating the following error:

rc	Meaning
----	---------

01	A GETMAIN request failed (through \$GETMAIN). The return code from GETMAIN is in bits 0-15 of the reason code.
----	--

\$F05 SJF REQUEST ERROR ON RELDS

An error occurred within the FSMQCT routine in module HASPFSSM. A reason code is set indicating one of the following errors:

rc	Meaning
----	---------

03	The SJF DELETE request failed. The return code from the SJF request is in bits 0-15 of the reason code.
----	---

04	The SJF TERMINATE request (in subroutine FSMSJTER) failed. The return code from the SJF request is in bits 0-15 of the reason code.
----	---

\$F06 GETBLK SERVICE ERROR

An error occurred within the FSMGTBLK routine in module HASPFSSM. A reason code is set indicating one of the following errors:

rc	Meaning
----	---------

01	An RPL cell obtained from the free cell chain does not contain the correct eye-catcher.
----	---

02	A GETR cell obtained from the free cell chain does not contain the correct eye-catcher.
----	---

\$F07 RETBLK SERVICE ERROR

An error occurred within the FSMGTBLK routine in module HASPFSSM. A reason code is set indicating one of the following errors:

rc	Meaning
----	---------

01	An RPL cell passed by the caller does not contain the correct eye-catcher.
----	--

02	A GETR cell passed by the caller does not contain the correct eye-catcher.
----	--

\$F08 RPL HAS INCORRECT DATA

Validation of the RPL passed from JES2 HASCHAM get processing detected incorrect data. The reason code indicates the field that has an error.

rc	Meaning
----	---------

04	The address of the LRC (RPLCCHAR) is zero.
----	--

08	The address of the data buffer (RPLAREA) is zero.
----	---

System action: An SDUMP is requested with the title set to the \$HASP750 message text and an ABEND 02C is issued. The functional subsystem (FSS) ESTAE routine might attempt recovery or end the FSS address space. If the FSS recovers, normal processing resumes from the point of recovery. If the FSS ends, normal JES2 processing continues but the device operated by the failed functional subsystem/functional subsystem application (FSS/FSA) is drained.

Operator response: Notify the system programmer. Wait for the FSA or FSS task to recover, or stop and for the JES2

device to drain. If the FSS is stopped, attempt to restart the device that was being operated by the failed FSA/FSS through the \$S command. If the device is not restarted or fails again, and if the device can be directly managed by JES2, then the device may be switched to JES mode using the \$T device, MODE=JES command, followed by the \$S device commands.

System programmer response: Analyze the message(s) issued and the dump requested from the JES2 or FSS address space. Look for the reason code and additional service routine return codes in register 15 at the time of the abend. If the reason code indicates a temporary out of storage condition, take action to alleviate the shortage and tell the operator to restart the device.

Note: Quickcell services return codes are documented under the X'6FB' ABEND code in z/OS MVS System Codes.

Module:

HASPFSSM

Routing Code:1,2,10

Descriptor Code:11

\$HASP751

Explanation:

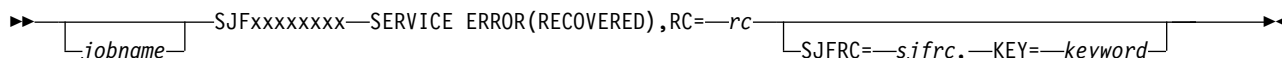

The scheduler JCL facility (SJF) service xxxxxxxx encountered an error while processing the indicated job. SJF sent error return code *rc* to the JES2 FSI support module and the module has recovered. In the message text:

jobname

The name of the job.

xxxxxxx

The name of the SJF service.

rc

The return code.

If the error occurred in SJF UPDATE service, additional information is displayed:

sjfrc

The reason code returned by SJF.

keywd

The name of the keyword found to be in error.

Note: A jobid may precede \$HASP751. See “JES2 message format” on page 1. The \$HASP750 message explains the *rc* value.

System action: The indicated output group is returned from the FSS to JES2. It is then requeued to the output queue and marked as unselectable (S=N). The \$HASP704 message is issued when the output group is requeued.

Operator response: Enter the \$TO command to correct the output keyword in error and make the output group reselectable (S=Y). Because the output group may have originated on another node connected to JES2, you may have to contact the job originator to correct the problem for subsequent jobs.

Notify the system programmer that this error has occurred.

Module:

HASPFSSM

Routing Code: 10

Descriptor Code: 6

\$HASP776 • \$HASP777

\$HASP776

Explanation:

▶▶—FAILURE DURING JESXCF— ATTACH PROCESSING—SERVICE=—*service*—RET=—*rc*—RSN=—*rsnc*—▶▶
└─*jobname*─┘

▶—MEMBER=—*nodename*—\$—*memb*—GROUP=—*xcfgrpnm*—▶▶

JES2 MAS member *memb* used the IXCJOIN macro to join the JES2 XCF group. The attempt failed.
In the message text:

service JESXCF/MVS service that failed.

rc The hexadecimal return code from the IXCJOIN macro.

rsnc The hexadecimal reason code from the IXCJOIN macro.

nodename\$memb

The XCF member name, where:

nodename

The name of the JES2 node containing *memb*.

memb The identifier of the JES2 member attempting to join the XCF group.

xcfgrpnm

The name of the XCF group this member was attempting to join, as specified on the XCFCGRPNM parameter of the MASDEF initialization statement.

The values for *rc* and *rsnc* are listed under the IXCJOIN macro in *z/OS MVS Programming: Authorized Assembler Services Reference EDT-IXG*.

System action: JES2 initialization ends.

Operator response: Notify the system programmer.

System programmer response: Search the problem reporting data bases for a fix to the problem. If none exists, contact the IBM support center with the return and reason codes.

Module:

HASPXCF

Routing Code: 1,2,10

Descriptor Code: 4

\$HASP777

Explanation:

▶▶—FAILURE DURING THE UPDATE OF USER—STATE STAT FOR A JES2 XCF MEMBER—▶▶

▶—RET=*rc* RSN=*rsnc* MEMBER=*nodename\$memb* GROUP=*xcfgrpnm*—▶▶

FAILURE DURING THE UPDATE OF USER STATE DATA FOR A JES2 XCF MEMBER

RET=*rc* RSN=*rsnc* MEMBER=*nodename\$memb*
GROUP=*xcfgrpnm*

MAS member *memb* attempted to update its XCF user state field with the IXCSETUS macro. The attempt failed.

In the message text:

rc The hexadecimal return code from the IXCSETUS macro.

rsnc The hexadecimal reason code from the IXCSETUS macro.

nodename\$memb

The XCF member name, where:

nodename

The name of the JES2 node containing *memb*.

memb The identifier of the JES2 member attempting to update its user state field.

xcfgprnm

The XCF group name.

The values for *rc* and *rsnc* are listed under the IXCSETUS macro in *z/OS MVS Programming: Authorized Assembler Services Reference EDT-IXG*.

System action: JES2 issues \$HASP095 message with \$XC1 code and then ends.

Operator response: Notify the system programmer.

The XCF member *nodename\$memb* may remain in the sysplex. To display the status of *nodename\$memb*, enter the D XCF,GROUP,*xcfgprnm*,*nodename\$memb* command where *xcfgprnm* is the JES2 XCF group name specified on the MASDEF initialization statement.

System programmer response: Search the problem reporting data bases for a fix to the problem. If none exists, contact the IBM support center with the return and reason codes.

Module:

HASPCXCF

Routing Code: 1,2,10

Descriptor Code: 4

\$HASP778

Explanation:

```
▶▶—FAILURE DURING THE QUERY OF A JES2 MEMBER'S—XCF DATA—RET=—rc—RSN=—rsnc—————▶
▶—MEMBER=—nodename—$—memb—GROUP=—xcfgprnm—————▶▶
```

This member used the IXZXIXIF macro to query the status of the member *nodename\$memb*. The attempt failed. In the message text:

rc The hexadecimal return code from the IXCQUERY macro.

rsnc. The hexadecimal reason code from the IXCQUERY macro.

nodename\$memb

The identifier of the XCF member

nodename

The name of the JES2 node containing *memb*.

memb The identifier of the JES2 member.

xcfgprnm

The XCF group the member is attempting to query.

The values for *rc* and *rsnc* are listed under the IXZXIXIF macro in *z/OS MVS Programming: Authorized Assembler Services Reference EDT-IXG*.

System action: JES2 will terminate if the failure occurs during JES2 initialization. After initialization, JES2 will not be able to reset the lock.

Operator response: Notify the system programmer. The XCF member *nodename\$memb* may remain in the sysplex. To display the status of *nodename\$memb*, enter the D XCF,GROUP,*xcfgprnm*,*nodename\$memb* command where *xcfgprnm* is the JES2 XCF group name specified on the MASDEF initialization statement.

\$HASP779 • \$HASP780

System programmer response: Search the problem reporting data bases for a fix to the problem. If none exists, contact the IBM support center with the return and reason codes.

Module:

HASPCXCF

Routing Code: 1,2,10

Descriptor Code: 4

\$HASP779

Explanation:

▶▶—FAILURE DURING THE REMOVAL OF THIS JES2—MEMBER'S XCF PARTICIPATION—————▶▶

▶—RET=rc RSN=rsnc MEMBER=nodename\$memb GROUP=xcfgprnm—————▶▶

XCF member *nodename\$memb* used the IXCLEAVE macro to leave the JES2 XCF group. The attempt failed. In the message text:

rc The hexadecimal return code from the IXCLEAVE macro.

rsnc The hexadecimal reason code from the IXCLEAVE macro.

nodename\$memb

The identifier of the XCF member attempting to leave the XCF group.

nodename

The name of the JES2 node containing *memb*.

memb The identifier of the JES2 member.

xcfgprnm

The XCF group the member is attempting to leave.

The values for *rc* and *rsnc* are listed under the IXCLEAVE macro in *z/OS MVS Programming: Authorized Assembler Services Reference EDT-IXG*.

System action: JES2 issues \$HASP095 message with \$XC1 code and ends.

Operator response: Notify the system programmer.

The XCF member *nodename\$memb* may remain in the sysplex. To display the status of *nodename\$memb*, enter the D XCF,GROUP, *xcfgprnm**nodename\$sysid* command where *xcfgprnm* is the JES2 XCF group name specified on the MASDEF initialization statement.

System programmer response: Search the problem reporting data bases for a fix to the problem. If none exists, contact the IBM support center with the return and reason codes.

Module:

HASPCXCF

Routing Code: 1,2,10

Descriptor Code: 4

\$HASP780

Explanation:

▶▶—FAILURE DURING THE XCF DELETE OF A JES2—MEMBER'S XCF PARTICIPATION—————▶▶

▶—RET=rc RSN=rsnc MEMBER=nodename\$memb GROUP=xcfgprnm—————▶▶

An attempt to delete inactive JES2 XCF group member *nodename\$memb* with the IXCDELET macro has failed.

In the message text:

rc The hexadecimal return code from the IXCDELETE macro.

rsnc The hexadecimal reason code from the IXCDELETE macro.

nodename\$memb

The name of the XCF member to be deleted, where:

nodename

The name of the JES2 node containing *memb*.

memb The identifier of the JES2 member.

xcfgrpm

The XCF group name.

The values for *rc* and *rsnc* are listed under the IXCDELETE macro in *z/OS MVS Programming: Authorized Assembler Services Reference EDT-IXG*.

System action: The function is aborted, a dump is taken, and processing continues.

Operator response: Notify the system programmer.

The XCF member *nodename\$memb* may remain in the sysplex. To display the status of *nodename\$memb*, enter the D XCF,GROUP,*xcfgrpm*,*nodename\$memb* command where *xcfgrpm* is the JES2 XCF group name on the MASDEF initialization statement.

System programmer response: Search the problem reporting data bases for a fix to the problem. If none exists, contact the IBM support center with the return and reason codes.

Module:

HASPXCF

Routing Code: 1,2,10

Descriptor Code: 4

\$HASP783

Explanation:

▶▶—THE AUTOMATIC RESTART— FOR JOBS ON A FAILED—JES2 MEMBER HAS BEEN BYPASSED — —MEMBER=—*memname*—▶▶

In response to message IXC402D, the operator indicated that the MVS system on which *memname* was active is down, when the member was, in fact, still active. Therefore, although the AUTOEMEM option was enabled, restarting of jobs from *memname* requires operator intervention. See *z/OS MVS System Messages, Vol 10 (IXC-IZP)* for information about message IXC402D.

In the message text:

memname

The member name of the failed JES2 MAS member.

System action: JES2 will not restart jobs on *memname*.

Operator response: Ensure that the MVS system is now actually down. Use the \$E MEMBER command to restart the jobs from JES2 member *memname*.

Module:

HASPXCF

Routing Code: 1,2,10

Descriptor Code: 4

\$HASP784 • \$HASP787

\$HASP784

Explanation:

▶▶—ATTEMPTING AUTOMATIC RESET OF JES2—MEMBER—*memname*—————▶▶

JES2 is attempting an automatic reset of the software lock on the checkpoint data set that is held by the JES2 MAS member *memname*.

In the message text:

memname

The member name of the JES2 member holding the software lock on the checkpoint data set.

System action: JES2 attempts to obtain the software lock on the checkpoint data set.

Operator response: None.

Module:

HASPCCKPT

Routing Code: Note 13

Descriptor Code: 4

\$HASP785

Explanation:

▶▶—AGED XCF MEMBER DATA HAS BEEN DELETED—MEMBER—*nodename*—\$—*memb*—GROUP—*xcfgprnm*—————▶▶

JES2 XCF group member *nodename**\$memb* has been deleted from the group because it has become aged. A member ages when it either remains across sysplex IPLs or is in the failed state for more than one day. A sysplex IPL duration is from the time the first system IPLs into the sysplex until the last system becomes inactive.

In the message text:

nodename\$memb

The identifier of the aged XCF member, where:

nodename

The name of the JES2 node containing *memb*.

memb The identifier of the JES2 member.

xcfgprnm

The XCF group name.

System action: The XCF member data for *nodename**\$memb* is removed.

Operator response: None.

Module:

HASPXCF

Routing Code: 1,2,10

Descriptor Code: 4

\$HASP787

Explanation:

▶▶—FAILURE DURING THE XCF JOIN— BECAUSE A DUPLICATE—JES2 XCF MEMBER IS ACTIVE —————▶▶

▶MEMBER=—*nodename*—\$—*memb*—GROUP=—*xcfgrpnm*—▶

MAS member *memb* is attempting to join the JES2 XCF group but cannot because a member with an identical name already belongs to the group. Each MAS should have a unique XCF group name. However, if there is more than one MAS with the same node name, sharing the same JES2 XCF group, and at least one member in each shares the same name, this failure can occur.

In the message text:

nodename\$memb

The XCF member name, where:

nodename

The name of the node containing *memb*.

memb The identifier of the member attempting to join the group.

xcfgrpnm

The XCF group name.

System action: JES2 initialization ends.

Operator response: Decide which JES2 MAS member should be joined to the XCF group and stop the JES2 member that doesn't belong in the JES2 XCF group. In addition, notify the system programmer.

System programmer response: If more than one MAS should happen to exist in a sysplex environment, each MAS should define a unique XCF group for JES2 to join. This can be done by specifying a unique name in the XCFGRPNM parameter on the MASDEF initialization statement for all MAS's in the sysplex.

See *z/OS JES2 Initialization and Tuning Guide* and *z/OS JES2 Initialization and Tuning Reference* for information on the XCFGRPNM parameter.

Module:

HASPXCF

Routing Code: 1,2,10

Descriptor Code: 4

\$HASP788

Explanation:

▶▶—FAILURE DURING THE XCF JOIN— BECAUSE A MAXIMUM—NUMBER OF XCF GROUPS ARE ACTIVE —▶▶

▶MEMBER=—*nodename*—\$—*memb*—GROUP=—*xcfgrpnm*—▶

JES2 member *memb* attempted to join the JES2 XCF group, but could not because the maximum number of groups is already defined to the sysplex. The MAXGROUP attribute on the DEFINEDS statement (of the IXCL1DSU format utility) did not allow enough groups while formatting the sysplex couple data set. See *z/OS MVS Setting Up a Sysplex* for more information.

In the message text:

nodename\$memb

The XCF member name, where:

nodename

The name of the JES2 node containing *memb*.

memb The identifier of the JES2 member attempting to join the sysplex group.

xcfgrpnm

The XCF group name.

System action: JES2 initialization ends.

System programmer response: Format the sysplex couple data set with a sufficient maximum number of groups to include the JES2 XCF group.

\$HASP789 • \$HASP790

Module:

HASPCXCF

Routing Code: 1,2,10

Descriptor Code: 4

\$HASP789

Explanation:

▶▶—FAILURE DURING THE XCF JOIN— BECAUSE A MAXIMUM—NUMBER OF XCF MEMBERS ARE ACTIVE —————▶

▶—MEMBER=—*nodename*—\$—*memb*—GROUP=—*xcfgprnm*—————▶▶

JES2 member *memb* attempted to join the JES2 XCF group, but could not because the maximum number of members is already defined to the sysplex. The MAXMEMBER attribute on the DEFINEDS statement (of the IXCL1DSU format utility) did not allow enough members while formatting the sysplex couple data set. See *z/OS MVS Setting Up a Sysplex* for more information.

In the message text:

nodename\$memb

The XCF member name, where:

nodename

The name of the JES2 node containing *memb*.

memb The identifier of the JES2 member attempting to join the sysplex group.

xcfgprnm

The XCF group name.

System action: JES2 initialization ends.

System programmer response: Format the sysplex couple data set with a sufficient maximum number of members to include the total number of members in the sysplex, or restart node *nodename* with a different XCF group name.

Module: HASPCXCF

Routing Code: 1,2,10

Descriptor Code: 4

\$HASP790

Explanation:

▶▶—ENFREQ ACTION=SIGNAL has failed.—The ENF service has repeatedly given RC=—*xx*.—————▶

▶—There have been—*nnnnn*—occurrences of RC=—*xx*—in the last—*ssss*— seconds.—————▶▶

\$HASP790 ENFREQ ACTION=SIGNAL has failed. The ENF service has repeatedly given RC=*xx*. There have been *nnnnn* occurrences of RC=*xx* in the last *ssss* seconds.

JES2 has received RC=8 from the ENF service. This means that the signal could not be delivered by the service. This message is issued every minute, at most, and shows the number (*nnnnn*) of occurrences of RC=8 in the last (*ssss*) seconds.

System action: JES2 deletes the ENF signal.

System programmer response: This message indicates that the ENF service is unable to process the request. Notify IBM Service.

Module: HASCENF

Routing Code: 2,10

Descriptor Code: 4

\$HASP791

Explanation:

▶▶—JES HAS JOINED AN XCF GROUP—THAT DOES NOT INCLUDE—ALL ACTIVE MAS MEMBERS—▶▶

THIS MEMBER'S INFORMATION:

NAME=*name1*,GROUP=*group1*,
 SYSPLEX=*plexname1*,ID=*plexid1*.

OTHER MAS MEMBER INFORMATION:

NAME=*name2*,GROUP=*group2*,
 SYSPLEX=*plexname2*,ID=*plexid2*.

⋮

NAME=*name2*,GROUP=*group2*,SYSPLEX=
plexname2,ID=*plexid2*.

During initialization processing, member *name1* of the MAS determined that there are active JES2 members that are not in the same XCF group in which it is a member.

A member is considered active if it has accessed the checkpoint data set within the specification of SYNCTOL= parameter on the MASDEF initialization statement.

In the message text:

name1 The name of the JES2 member that is initializing.

group1 The name of the XCF group that this JES2 member joined.

plexname1
 The name of the sysplex in which this JES2 member is active.

plexid1 The 8-byte sysplex identifier associated with the sysplex.

name2 The name of the JES2 member in a group different from the group member *name1* joined.

group2 The name of the XCF group that member *name2* joined.

plexname2
 The name of the sysplex in which member *name2* is active.

plexid2 The 8-byte sysplex identifier associated with the sysplex.

All members of a JES2 MAS must be in the same sysplex and they must be members of the same XCF group. The members identified in the message are active in either more than one sysplex (*plexname* or *plexid* are different) or more than one XCF group (*group*).

System action: JES2 initialization ends.

Operator response: Notify the system programmer.

System programmer response: If the XCF group names (*group1* and *group2*) do not match, change either the XCFGRPNAME= parameter specification on the MASDEF initialization statement or the local node name specified on the NODE(*nnnn*) NAME= initialization statement for the *nnnn* specified on the NJEDEF OWNNODE= initialization statement. See *z/OS JES2 Initialization and Tuning Guide* for defining JES2 to the cross-system coupling facility (XCF) and the relationship of the required initialization statements.

If the sysplex names or IDs (*plexname* or *plexid*) do not match, re-IPL MVS so that it is within the same sysplex as the other JES2 MAS members.

When the problem is corrected, restart JES2.

Module:

HASPXCF

Routing Code: 2,10

\$HASP792

Descriptor Code: 4

\$HASP792

Explanation:

▶▶—JES2 HAS JOINED XCF GROUP—*xcfggrpnm*—THAT INCLUDES ACTIVE MEMBERS THAT—ARE NOT PART OF THIS MAS—▶▶
▶| MEMBER |—,....,—| MEMBER |—▶▶

MEMBER:

|—MEMBER=—*node\$member*,—REASON=—*reason*—|

During initialization processing, JES2 detected active members in the same XCF group as the initializing member, but the other members are not within the same MAS as the initializing member.

In the message text:

xcfggrpnm

The JES2 XCF group that JES2 had joined.

node\$member

The XCF member name of the active member.

reason The reason why the initializing member believes the listed member(s) are not part of the local MAS. *reason* is one of the following:

MEMBER IS NOT JES2

The member has not identified itself as JES2. This indicates that the member is running a pre-SP5.1 release of JES2.

INCORRECT MEMBER NAME FORMAT

Either the XCF member name is not in the format used by JES2 (that is, *node-name\$member-name*) or the node name used by JES2 or the node name contained in the XCF member name does not match the node name of the initializing member.

DIFFERENT COLD START TIME

The cold start time of the listed member(s) does not match the cold start time of the initializing member. This indicates that the initializing member is performing a cold start when another member is active. This can also be caused on a warm start if the two members are not pointing to the same volumes for checkpoint. One such case is two volumes with the same volume serial with the required checkpoint data sets on each volume. If one system accesses the first volume and the second system accesses the other volume, then this message would indicate the problem.

Note: Only one JES2 MAS is allowed in an XCF group.

System action: If JES2 is performing a hot start, or if there are members active in the XCF group that are part of the local MAS, JES2 initialization continues.

If JES2 is not performing a hot start and all active members of the XCF group are not part of the local MAS, JES2 initialization terminates.

Operator response: Notify the system programmer.

System programmer response: In order to determine who has registered to the JES2 XCFGRPNM that may not be part of the SYSPLEX, you can issue

```
D XCF,GROUP,xcfggrpnm,ALL
```

where:

'xcfggrpnm' is the name of the JES2 XCF Group name in which your JESPLEX resides. This provides you with more information about the member/s that are not part of this SYSPLEX.

If this is a cold start, be certain all previously active members are inactive (either \$P JES2 or the MVS on which JES2 was active has been partitioned out of the sysplex), then restart JES2.

If this is not a cold start, or you are certain all previously active JES2 members are inactive, then either JES2 is attempting to join the wrong XCF group or there is an application attempting to use JES XCF inappropriately. Verify that the MASDEF XCFGRPNM= and NJEDEF OWNNODE= parameters are set correctly to define all MAS members to a single XCF group. See *z/OS JES2 Initialization and Tuning Guide* for defining JES2 to the cross-system coupling facility (XCF) and the relationship of the required initialization statements. Or see *z/OS MVS Programming: JES Common Coupling Services* if you are using JES XCF to modify or extend standard JES2 messaging.

Module: HASPXCF

Routing Code: 2,10

Descriptor Code: 4

Chapter 12. Eight-hundreds

The following JES2 messages are numbered in the 800-899 range.

\$HASP800

Explanation:

▶▶—*jobname*—THE JES2 EVENT TRACE LOG—IS NOW ACTIVE————▶▶

The JES2 trace log processor has been started as the result of the START=Y keyword on the TRACEDEF command or initialization statement. The trace log processor automatically starts up after a JES2 restart if trace data was being processed at the time of failure. This message is only issued when trace entries are ready to be written to the trace log data set. If tracing is inactive, the trace log writer will not start.

In the message text:

jobname

The name of the job.

Note: A jobid may precede \$HASP800. See “JES2 message format” on page 1.

System action: The trace table entries being produced by event trace are now being written to the trace log data set for later printing.

Operator response: None.

Module: HASPEVTL

Routing Code: 1,2

Descriptor Code: 4

\$HASP801

Explanation:

▶▶—*jobname*—THE JES2 EVENT TRACE LOG—QUEUED TO CLASS—*c*—(—OUTDISP=—*outdisp*—)————▶▶

The JES2 trace log data set was “spun-off” because the operator entered a \$T TRACEDEF,SPIN or a \$T TRACEDEF, LOG=(START=NO), or because the line limit of the data set (set by the LOG=SIZE= parameter on the TRACEDEF initialization statement) was reached.

In the message text:

jobname The name of the job

c The output class of the trace log

outdisp One of the following:

WRITE JES2 processes the output and then removes the output from the system.

HOLD JES2 will not process the data set until you change the output disposition to KEEP or WRITE.

KEEP JES2 processes the data set and then changes the output disposition to LEAVE.

LEAVE JES2 will not process the data set until you change the output disposition to KEEP or WRITE.

PURGE

JES2 will remove the output from the system.

Note: Do not use this value when tracing as JES2 purges the trace output immediately upon creation.

\$HASP802 • \$HASP803

Note: A jobid may precede \$HASP801. See "JES2 message format" on page 1.

System action: The contents of the event trace log have been written to a SYSOUT data set of the SYSOUT class designated by *c*. The data set is (HELD) if the SYSOUT class was defined as a held class during JES2 initialization. If this message is in response to a \$T TRACEDEF, LOG=(START=NO) command, the system issues message \$HASP802.

Operator response: None.

Module: HASPEVTL

Routing Code: 1,2

Descriptor Code: 4

\$HASP802

Explanation:

▶▶—*jobname*—THE JES2 EVENT TRACE LOG—IS INACTIVE—▶▶

The operator entered a \$T TRACEDEF, LOG=(START=NO) command and all trace table entries (if any) were written to the trace log data set. JES2 has issued the \$HASP801 message.
In the message text:

jobname

The name of the job.

Note: A jobid may precede \$HASP802. See "JES2 message format" on page 1.

System action: The trace entries produced by an event trace are no longer written to the trace log data set. If an event trace is still in effect (\$T TRACEDEF,ACTIVE=YES), then trace entries continue to be added to the JES2 trace tables for subsequent examination in a system dump, if necessary.

Operator response: None required. To restart the trace log processor, enter the \$T TRACEDEF,LOG=(START=YES) command.

Module: HASPEVTL

Routing Code: 1,2

Descriptor Code: 4

\$HASP803

Explanation:

▶▶—*jobname*—JES2 EVENT TRACE LOGGING—TERMINATED -- INSUFFICIENT— STORAGE IN CSA (SP231)—▶▶

An attempt to acquire storage for an input/output table (IOT) has failed. This storage is necessary for the processing of the trace log data set.
In the message text:

jobname

The name of the job.

Note: A jobid may precede \$HASP803. See "JES2 message format" on page 1.

System action: The same processing occurs as described under message \$HASP802. The log processor is stopped. A display of the event trace (\$D TRACEDEF) will indicate LOG=(START=NO).

Operator response: Notify the system programmer. When it is determined that sufficient storage is available to continue, restart the trace log processor by entering the \$T TRACEDEF LOG=(START=YES) command.

System programmer response: Determine which resource is using the CSA. Free common storage if you need tracing. Enter the \$T TRACEDEF, LOG=(START=YES) command to restart trace logging.

Module: HASPEVTL

Routing Code: 1,2

Descriptor Code: –

\$HASP804

Explanation:

▶▶—*jobname*—THE JES2 EVENT TRACE LOG—IS EMPTY—▶▶

A \$T TRACEDEF,SPIN command was entered when no trace data was available.
In the message text:

jobname

The name of the job.

Note: A jobid may precede \$HASP804. See “JES2 message format” on page 1.

System action: Processing continues.

Operator response: Enter \$D TRACEDEF to display the status of tracing and the active trace IDs. If necessary, change the IDs that are traced or active.

Module: HASPEVTL

Routing Code: 1,2

Descriptor Code: 4

\$HASP805

Explanation:

▶▶—*jobname*—SYMREC ISSUED FROM—*module*—WITH A DESCRIPTION OF—*desc*—▶▶

JES2 issued an MVS symptom record (SYMREC) request and SYMREC=YES is specified on the DEBUG initialization statement. This message indicates that JES2 detected an error (or a potential error) and further diagnostic information is available in LOGREC.

In the message text:

jobname

The name of the job that was in control when JES2 issued the SYMREC request. This *jobname* is JES2 if the symptom record was issued out of the JES2 address space.

module

The name of the JES2 module or exit routine in control when JES2 issued the symptom record request.

desc

The descriptive text associated with the SYMREC.

System action: Processing continues.

System programmer response: Examine LOGREC to determine the cause of the SYMREC and correct the problem. See *z/OS JES2 Diagnosis* for an explanation of the SYMREC and suggested corrective actions.

Because some SYMRECs are informational only, you might not want to receive this message. To suppress \$HASP805:

- Do not activate the JES2 DEBUG facility (DEBUG=NO and DEBUG SYMREC=NO are the default initialization specifications).
- If the SYMREC is issued from an installation exit, specify DEBUGMSG=NO on the \$SYMTAB macro to suppress this message even if the DEBUG initialization statement indicates that SYMREC=YES. See *z/OS JES2 Macros* for a description of the \$SYMTAB macro.

Module: HASCLINK

Routing Code: 2

Descriptor Code: 4

\$HASP806

Explanation:

▶▶—VOLUME—*volser*—DRAINED—▶▶

The operator entered a \$P SPOOL command. The \$HASP806 message is sent to the requesting system when JES2 has completed the dynamic deallocation of the spool identified by *volser*. JES2 no longer keeps a record of the spool volume's existence.

In the message text:

volser The volume identifier.

System action: JES2 processing continues without the spool volume.

Operator response: You may remove the volume from the JES2 environment.

Module: HASPSPOL

Routing Code: 1,2

Descriptor Code: 4

\$HASP807

Explanation:

▶▶— DURING SPOOL MIGRATION, THE PATH TO— SOURCE DATASET— *volser*— HAS BEEN LOST—▶▶

OR

▶▶— DURING SPOOL MIGRATION, THE PATH TO TARGET— DATASET— *volser*— HAS BEEN LOST—▶▶

OR

▶▶— DURING SPOOL MIGRATION, THE PATHS TO BOTH— TARGET— *volser*—AND SOURCE— *volser*—▶▶

▶— DATASETS HAVE BEEN LOST—▶▶

OR

▶▶— SPOOL MIGRATION RECOVERY CANNOT READ— BITMAP FROM TARGET— *volser*—▶▶

OR

▶▶— SPOOL MIGRATION CANNOT WRITE— BITMAP TO TARGET— *volser*—▶▶

JES2 has encountered an I/O error during a spool migration, which is preventing the spool migration from completing. The problem could be a lost communication path to the specific spool volumes listed in the message. However, in the case of migration recovery, the problem could be an error reading information from the specified volume. The spool migration is interrupted, and application I/O might be suspended, until this condition is cleared. If the migration was performing the COPY phase, the following additional text will be displayed:

▶▶—THERE ARE TWO OPTIONS. CORRECT THE PATH(S)—AND RETRY OR JUST CANCEL THE MIGRATION—▶▶

If the migration was performing the CATCHUP phase, the following additional text will be displayed:

▶▶—THERE ARE THREE OPTIONS. CORRECT THE PATH(S)—AND RETRY. IF THIS IS NOT POSSIBLE, THEN EITHER—▶▶

►QUIT AND USE THE SOURCE DATASET, OR FORCECOMPLETE—AND USE THE TARGET DATASET—►

Reply to message \$HASP814 using one of the actions described previously.

System action: Processing stops.

Operator response: Notify the system programmer.

Programmer response: A corrective action is required to resume normal operation of the system. If the error can be corrected, then correct the error and reply RETRY. The system will resume the SPOOL migration where it left off. If the condition cannot be corrected and FORCECOMPLETE reply is not an option, then reply CANCEL to stop the SPOOL migration.

If a FORCECOMPLETE reply is an option, then the migration has completed to a point where some write operations have completed on the source and some write operations have completed on the target. At this point, neither the source nor the target have a complete set of information and one, or both, are no longer accessible. If the problem is a non-correctable problem with a volume, and the data is lost, then select the option that keeps the volume that has data.

For example, if the source data set has been destroyed and you get this message, a FORCECOMPLETE reply will mark the migration complete and whatever data was written to the target is available. If the target data set has been destroyed, a CANCEL will roll back the migration and leave the data on the source accessible. If both are lost and this is not a recovery, then either option can be chosen.

If this is a recovery, then JES2 was unable to read the required bitmap to resume. If this indicates a problem with the target volume, then reply CANCEL to roll back the migration and keep the source. If this target is accessible, and the migration has made it to the catchup phase, then reply with FORCECOMPLETE to use the data copied to the target.

Module: HASPSPOL

Routing Code: 1,2,10

Descriptor Code: 2,7

\$HASP808

Explanation:

►►—MIGRATION OF SOURCE=—*SPOOL1*—VOLUME—TO TARGET=—*SPOOL2*—VOLUME—*result*—►►

The operator entered a \$MSPL command to migrate source spool volume *SPOOL1* to target spool volume *SPOOL2*. The command *result* is one of the following:

- 1 Migration cancelled.
- 2 Target volume no longer exists.
- 6 Migration cancelled. Unable to obtain 64 bit private storage.
- 9 Migration INITIALIZING phase started.
- 11 Migration cancelled. Target volume is already a source of a migration or a mapped volume.
- 12 Migration cancelled. Target volume is not active, has insufficient space in the track group map, or is extending.
- 13 Migration cancelled. Migrator subtask could not be attached.
- 14 Migration cancelled. Migration assistant subtask could not be attached.
- 15 Migration cancelled. JESXCF mailbox create failed for migration mailbox.
- 16 Migration cancelled. JESXCF mailbox create failed for runtime mailbox.
- 17 Migration cancelled. Unable to obtain 31 bit private storage.
- 18 Migration cancelled. Unable to obtain 31 bit private storage.
- 19 Migration cancelled. Unable to obtain 64 bit common storage.
- 20 Migration cancelled. JESXCF mailbox create failed for migration assistant mailbox.

\$HASP809

- 21 Migration cancelled. Internal error in migrator subtask.
- 22 Migration cancelled. Internal error in migration assistant subtask.
- 33 Migration activity completed. Migration was successful.
- 34 Migration cancelled. Source dataset allocation failed.
- 35 Migration cancelled. Internal error in migrator subtask.
- 37 Migration cancelled. Insufficient contiguous free space on target volume.
- 39 Migration cannot be cancelled.
- 48 Migration phase INITIALIZING is starting.
- 50 Migration phase CLEANUP pending. Unable to obtain DAS BERT lock.
- 51 Migration activity completed. Migration was cancelled.
- 57 Migration cancelled. Assistant subtask unable to attach unique JESXCF group.
- 58 Migration cancelled. Migrator subtask unable to attach unique JESXCF group.
- 59 Member *xxxx* is performing Migrator Takeover for member *yyyy*.

System action: None.

Operator response: If the migration completed successfully, you can remove the source volume from the JES2 environment. If the migration was not successful, you can rerun the \$MSPL command once the problem has been resolved.

Module: HASPSPOL

Routing Code: 1,2

Descriptor Code: 4

\$HASP809

Explanation:

▶▶—MIGRATION OF SOURCE=—*SPOOL1*—VOLUME—TO TARGET=—*SPOOL2*—VOLUME—*result*—▶▶

The operator entered a \$MSPL command to migrate source spool volume *SPOOL1* to target spool volume *SPOOL2*. The command *result* is one of the following for a merge migration (for a move migration, -MERGE would be replaced with -MOVE):

- 3 Initiated start of target volume.
- 4 Initiated drain of source volume.
- 5 Completed allocation of target volume.
- 7 BACKOUT processing completed unallocation of the target volume.
- 10 Migrator and spool assistant subtasks have been attached.
- 24 Migration phase SETUP-MERGE is starting.
- 25 Migration phase SETUP-MERGE is complete.
- 26 Migration phase COPY-MERGE is starting.
- 27 Migration phase COPY-MERGE is complete.
- 28 Migration phase CATCHUP-MERGE is starting.
- 29 Migration phase CATCHUP-MERGE is complete.
- 30 Migration phase CLEANUP-MERGE is starting.
- 31 Migration phase CLEANUP-MERGE is complete.
- 32 Migration phase SETUP-MERGE is starting.

- 38 Migration cancelled. Phase CANCEL-MERGE is starting.
- 40 Migration cancelled. Phase BACKOUT-MERGE is starting.
- 41 Migration cancelled. Phase BACKOUT-MERGE is starting.
- 42 Migration cancelled. Phase CLEANUP-MERGE is starting.
- 43 Migration phase CANCEL-MERGE is complete.
- 44 Migration cancelled. Phase BACKOUT-MERGE is starting.
- 45 Migration cancelled. Phase BACKOUT-MERGE is starting.
- 46 Migration completed. Target volume exceeded maximum number of track groups that can be mapped.
- 47 Migration phase CLEANUP-MERGE is starting.
- 49 Migration phase INITIALIZING is complete. Migrator and spool assistant subtasks have been attached.

System action: None.

Operator response: If the migration completed successfully, you can remove the source volume from the JES2 environment. If the migration was not successful, you can rerun the \$MSPL command once the problem has been resolved.

Module: HASPSPOL

Routing Code: 1,2

Descriptor Code: 4

\$HASP810

Explanation:

▶▶—*volser*—INVALID ON MEMBER—*memname*— — REASON CODE =—*rsnc*—▶▶

This message is issued at the member initiating the start spool (\$S SPOOL) command because the indicated member cannot start the spool volume identified by *volser* because of reason code *rsnc*. The member that had the error received a full descriptive message explaining the error.

In the message text:

volser The volume identifier.

memname
The member name.

rsnc The reason code issued in the message to the command originator indicating an error on another member.

Possible values of *rsnc* are:

rsnc	Meaning
4	Volume not mounted
8	Duplicate spool volumes
12	Allocation error
16	Formerly mounted spool volume not mounted
20	Extent error
24	Previously mounted spool volume not formatted
28	ENQ already help for volume
32	UCBINFO macro failed
36	IOSCDR macro failed
40	NED not found by IOSCDR

\$HASP811 • \$HASP813

44 DIAGNOSE instruction error

System action: The member returns the volume to its state (drained or inactive) before the command was issued.

Operator response: When the problem is corrected on the other member, reenter the start spool (\$S SPOOL) command.

Module: HASPSPOL

Routing Code: 1,2,10

Descriptor Code: 4

\$HASP811

Explanation:

▶▶—REPLY Y TO CONTINUE OR N TO—TERMINATE START PROCESSING—▶▶

There is not enough space in the master TGM (track group map) to map all of the track groups on the spool volume. Messages \$HASP850 and \$HASP854 accompany this message showing how many of the track groups on the volume volser are mapped in the master TGM.

System action: Spool command processing waits for the operator to reply.

Operator response: Reply Y or N. If you reply Y, JES2 starts the volume using only the number of track groups indicated in the \$HASP850 message. To fully use the volume later, increase TGSPACE=(MAX=) . If you reply N, JES2 drains the volume.

Module: HASPSPOL

Routing Code: 1,2,10

Descriptor Code: 4

\$HASP812

Explanation:

▶▶—DESTDEF—*response*—, . . . ,—▶▶

JES2 issues this message in response to a DISPLAY initialization control statement or a \$D or \$T command that specifies the DESTDEF initialization statement. It displays the current value of the keywords required. The description of the DESTDEF statement in *z/OS JES2 Initialization and Tuning Guide* explains each of the keywords.

System action: Processing continues.

Operator response: None.

Programmer response: None.

Module: HASCSCAN

Routing Code: #

Descriptor Code: -

\$HASP813

Explanation:

▶▶—RESET OF CHECKPOINT LOCK FAILED - —NOT HELD BY—MEMBER—*member_name*—
INITIALIZATION—▶▶

The reset of the checkpoint data set lock failed because the member specified on the '\$E CKPTLOCK,HELDBY=' command did not hold the lock, or the lock was not held by a member that failed during initialization.

System action: Processing continues.

Operator response: If the \$HASP263 message includes the message text "LOCK HELD BY MEMBER *member_name*" or the \$HASP264 is still being issued, verify that the member name specified on the '\$E CKPTLOCK,HELDBY=' command matches the member name specified in one of these two messages.

Programmer response: None.

Module: HASPCKPT

Routing Code: 1,2,10

Descriptor Code: 4

\$HASP814

Explanation:

▶▶—MIGRATION AND PATH(S) LOST. SEE \$HASP807.—REPLY RETRY OR CANCEL—▶▶

OR

▶▶—MIGRATION AND PATH(S) LOST. SEE \$HASP807.—REPLY RETRY, QUIT OR FORCECOMPLETE—▶▶

JES2 has lost the communication path to the data sets mentioned in the \$HASP807 message that was displayed prior to the \$HASP814 message.

System action: Processing stops awaiting operator response.

Operator response: Reply using one of the responses documented in the message text.

Module: HASPSPOL

Routing Code: 1,2,10

Descriptor Code: 4

\$HASP815

Explanation:

▶▶—CONNECT NODEA—*nodename*, —MEMBERA=—*mema*, —NODEB=—*nodename*, —MEMBERB=—*memb*, —▶▶

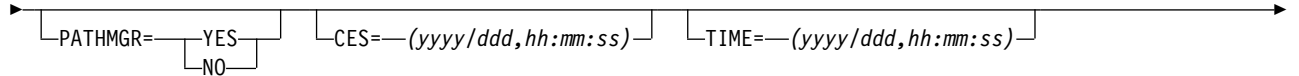
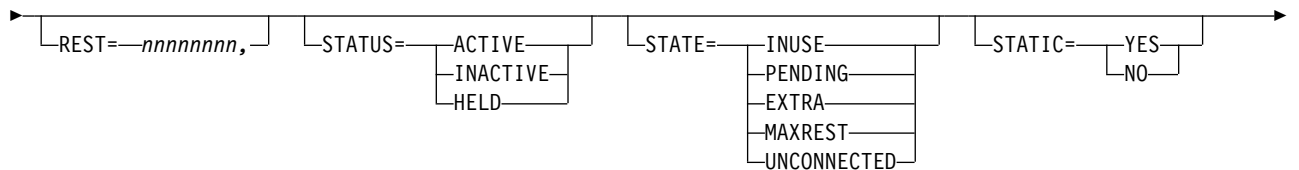

The operator entered a command to display or change a network connection. In the message text:

nodename The name of a node.

memb The number of a member.

\$HASP816

nnnnnnnn

The resistance of the connection.

yyyy/ddd

A Julian date.

hh:mm:ss

Time in hours, minutes, and seconds.

TIME= displays the time JES2 received the connection record for a connection or the time the operator entered a command which changed a static connection. CES= displays the connection event sequence (CES) for non-static connections. STATUS=*status* displays the current status of the connection as follows:

ACTIVE

The connection exists and the signon process has completed.

HELD The connection exists but the nodes are currently in the process of signing on.

INACTIVE

The connection exists but the nodes have not signed on.

ACTIVE(*status*)

A static connection exists and is treated as active for the purposes of path determination. The actual connection is **not** active but has a status of *status* (that is, one of the other status types listed here).

STATE Displays additional information for an ACTIVE connection.

INUSE Connection is currently in use in some path to a node.

PENDING

An INUSE STATIC connection to an adjacent node for which the corresponding line is not currently signed on.

EXTRA

Connection is currently not part of any path and is not needed to reach any node.

MAXREST

Connection is not in use because all paths that can make use of it have reached their resistance limit (as specified on NJEDEF RESTMAX).

UNCONNECTED

Static connection between two nodes, neither of which are reachable by any path.

System action: Processing continues

Operator response: None.

Module: HASPCOMM, HASPNPM

Routing Code: #

Descriptor Code: -

\$HASP816

Explanation:

▶▶—SUBNET—(vvvvvvvv)—*node1,node1,...*—————▶▶

The system issues this message in response to an operator-entered \$D SUBNET command or a D SUBNET JES2 read in the initialization deck.

The nodes *node1,node2,...* are all defined with the value *vvvvvvvv* for SUBNET= on the NODE(nnnn) statement. In the message text:

vvvvvvvv

The name of the subnet.

node1 and node2

Names of nodes.

System action: Processing continues.

Operator response: None.

Module: HASCSCAN, HASPCOMM

Routing Code: #

Descriptor Code: -

\$HASP817

Explanation:

▶▶—SUBTDEF GSUBNUM=*value*—————▶▶

This message is issued in response to a \$D SUBTDEF command and displays the value of the GSUBNUM keyword. In the message text:

value The value of the GSUBNUM keyword.

System action: Normal processing continues.

Operator response: None.

Module: HASCSCAN

Routing Code: 1,2,10

Descriptor Code: 4

\$HASP818

Explanation:

▶▶—REDIRECT—(*inputcon*)—DA=*outcon*,—DF=*outcon*,—DI=*outcon*,—DJ=*outcon*,—DN=*outcon*,—▶▶
▶—DQ=*outcon*,—DU=*outcon*,—DSPL=*outcon*,—LJ=*outcon*,—DEF=*outcon*,—DCONNECT=*outcon*,—▶▶
▶—DNODE=*outcon*—————▶▶

JES2 issues this message in response to a \$ADD, \$T or \$D REDIRECT command. In the message text:

inputcon

The 2- to 8-character console name or the console identifier specified in the command.

outcon

The 2- to 8-character console name or console identifier and the optional display area JES2 directs the response for specific display commands.

For example, if the *inputcon* is POOL2 and DA=TAPE2, JES2 directs responses to \$DA commands entered on POOL2 to TAPE2.

Operator response: None.

Module: HASCSCAN

Routing Code: #

Descriptor Code: -

\$HASP819

Explanation:

\$HASP820

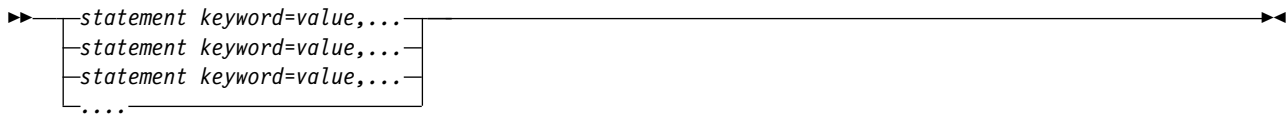

JES2 issues this message in response to a \$D command that specified the LOADMOD initialization statement. Depending on what information you specified on the \$D command, the response is one of the following:

- All of the keywords defined on the specified initialization statement or command and their current values (if the statement name is specified without any keywords).
- Certain keywords defined on the initialization statement or command and their associated values (if the statement name and those keywords are specified on the DISPLAY statement or command).

In the message text:

statement

The command. The following is to be displayed:

LOADMOD(jxxxxxxx)

keyword

The command parameters. The following can be displayed:

modname

The name of the load module.

ADDRESS

The address in storage where the load module begins.

LENGTH

The load module length.

ROUTINES

Displays the routines that are defined in \$ENTRY macros in the module.

Only routine names for installation load modules will be included.

SPLEVEL

The value the module assigned to the SPLEVEL= parameter on the \$MODULE macro. You can specify a value to display only those modules that have assigned a specific value to the \$MODULE SPLEVEL= parameter.

RMODE

The link-edit attributes of the load module.

STORAGE

The type of storage in which the load module resides.

TABLES

Displays the tables that are defined through TABLE=DYNAMIC entries in the module, along with the type of table. Only table names for installation load modules will be included.

System action: Processing continues.

Operator response: None.

Module: HASCSCAN

Routing Code: #/1,2,10

Descriptor Code: -4

\$HASP820

Explanation:

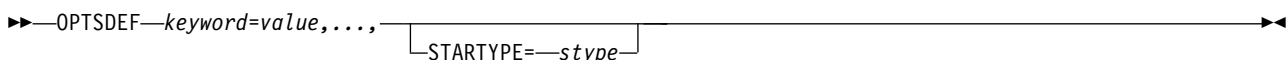

JES2 issues this message in response to a DISPLAY initialization control statement or \$D command that specified the OPTSDEF initialization statement. If issued during initialization, this message displays all the keywords defined on the OPTSDEF statement and their current values. If issued after initialization has completed, this message displays only certain OPTSDEF keywords in addition to the type of start that was performed (STARTYPE=*stype*). The description of the OPTSDEF statement in *z/OS JES2 Initialization and Tuning Reference* explains each of the keywords.

In the message text:

keyword

The name of the keyword.

value The value of the keyword.

stype The type of start performed.

System action: Processing continues.

Operator response: None.

Module: HASCSCAN

Routing Code: #/1,2,10

Descriptor Code: -4

\$HASP821

Explanation:

▶▶—APPL—(*applid*)—keyword=value,...—◀◀

JES2 issues this message in response to a \$D, \$T, or \$ADD command that specified the APPL initialization statement. It displays the keywords defined on this statement and their current values. The description of the APPL statement in *z/OS JES2 Initialization and Tuning Reference* explains each of the keywords.

In the message text:

applid The VTAM application identifier of the node.

keyword

The name of the keyword.

value The value of the keyword.

System action: Processing continues.

Operator response: None.

Module: HASCSCAN

Routing Code: #/1,2,10

Descriptor Code: -4

\$HASP822

Explanation:

▶▶—DESTID—(*destname*)—keyword=value,...—STATUS=—*status*—◀◀

JES2 issues this message in response to a \$D, \$T, or \$ADD command that specified the DESTID initialization statement. It displays the keywords defined on this statement and their current values. The STATUS= keyword indicates the correlation (if any) between the DESTID and the name of a node.

In the message text:

destname

The destination name.

\$HASP823

keyword

The name of the keyword.

value The value of the keyword.

The possible values for *status* are:

- **NODENAME** – if *destname* matches the name of a node.
- **DESTID** – if *destname* does not match the name of a node.
- **NODENAME + DESTID** – if the status was previously DESTID and the node name was then changed to match the destname.

The description of the DESTID statement in *z/OS JES2 Initialization and Tuning Reference* explains the remaining parameters displayed in this message.

System action: Processing continues.

Operator response: None.

Module: HASCSCAN

Routing Code: #/1,2,10

Descriptor Code: -4

\$HASP823

Explanation:

▶▶—EXIT—(*nnn*)—*keyword=value*,...—STATUS=—

ENABLED
DISABLED
ENABLED/ENTERED

—,USECOUNT=—*mmm*—▶▶

JES2 issues this message in response to a \$D or \$T EXIT(*nnn*) command. It displays the keywords defined on this statement and their current values. The description of the EXIT(*nnn*) statement in *z/OS JES2 Initialization and Tuning Reference* explains the remaining keywords.

The STATUS= keyword describes the current state of EXIT*nnn*. The USECOUNT= keyword displays a count of the processes using the exit at this time. STATUS=DISABLED/ENTERED indicates that the exit received control although it was in a disabled state. This situation can occur if the installation invokes an exit with a \$EXIT TYPE=ENTER call without first checking if the exit was enabled with a TYPE=TEST call. The exit routine receives control unconditionally.

In the message text:

nnn The exit number.

keyword

The name of the keyword.

value The value of the keyword.

mmm The number of processors using the exit.

System action: Processing continues.

Operator response: None.

Module: HASCSCAN

Routing Code: #/1,2,10

Descriptor Code: -4

\$HASP824

Explanation:

▶▶—FSS—(*fssname*)—keyword=*value*,...—
 └ASID=*asid*┘

JES2 issues this message in response to a \$D, \$T, or \$ADD command that specified the FSSDEF initialization statement. It displays the keywords defined on this statement and their current values. If the specified FSS is currently active, the message also displays the ASID= keyword, which indicates the address space in which the FSS is running. The description of the FSSDEF statement in *z/OS JES2 Initialization and Tuning Reference* explains each of the keywords.

In the message text:

fssname

The name of the functional subsystem.

keyword

The name of the keyword.

value

The value of the keyword.

asid

The address space identifier.

System action: Processing continues.

Operator response: None.

Module: HASCSCAN

Routing Code: #/1,2,10

Descriptor Code: -4

\$HASP825

Explanation:

▶▶—INITINFO—
 └*Start_command*┘ └DSN=*PARM_DSN*—,—VOLSER=*PARM_VOL*—,—┘
 ▶ └UNIT=*PARM_UNIT*—,—CARDS=*PARM_COUNT*┘ └DSN=*STEP_DSN*—,—VOLSER=*STEP_VOL*—,—┘
 ▶ └UNIT=*STEP_UNIT*┘

JES2 issues this message in response to a DISPLAY initialization control statement or \$D command that specified the INITINFO initialization statement. If issued during initialization, this message displays all keywords that are defined on the INITINFO statement and their current values. However, the HASPPARM data set list only includes the data set and counts processed to this point. If issued after initialization has completed, this message displays the final values for the HASPPARM data sets that were used.

In the message text:

Start_command

The command that was used to start JES2.

PARM_DSN

The name of a data set (including member name) that was used to obtain initialization statements. Statements input in response to WTORS will display "CONSOLE". If statements are read from the logical PARMLIB concatenation, LOGICAL_PARMLIB(member) will be displayed.

PARM_VOL

The volume serial that is associated with the *PARM_DSN* value.

\$HASP826

PARM_UNIT

The unit address that is associated with the *PARM_DSN* value.

PARM_COUNT

The count of cards read from the *PARM_DSN* data set. If this value is read during initialization, this is the total count to this point. If this value results from an operator command, this is the total cards read.

STEP_DSN

The name of a data set that is in the STEPLIB concatenation for the address space.

STEP_VOL

The volume serial that is associated with the *STEP_DSN* value.

STEP_UNIT

The unit address that is associated with the *STEP_DSN* value.

System action: Processing continues.

Operator response: None.

Module: HASCSCAN

Routing Code: #/1,2,10

Descriptor Code: -4

\$HASP826

Explanation:

▶▶—NODE—(*nnnn*)—*nodename*—*keyword=value,...*—STATUS=—(*path1,path2,..*)—▶▶

JES2 issues this message in response to a \$D or \$T NODE(*nnnn*) command. The message displays the keywords defined on this statement and their current values.

In the message text:

nodename

The name of the node.

keyword

The name of the keyword.

value

The value of the keyword.

path1,path2

The available paths to the node.

path status is one of the following:

UNCONNECTED

This system cannot reach the target node at this time.

OWNNODE

Displays the name of the node from which the \$D or \$T command was entered.

VIA/LINE*nnnn*

The path to the target node goes through line *nnnn*.

VIA/*member-name*

The path to the target node begins with *member-name* in this multi-access spool configuration.

PENDING/*node-M**nnnn*

There is no active line to the target node even though static connections describe a path to the target.

AWAITING RESET WITH *node*

The primary trunk of a multi-trunk connection to *node* has gone down and the new primary is in the process of being established.

SIGNON/LINE*nnnn*

The path to the target node will be through line *nnnn* as soon as the current signon completes.

ownnode

The name of the sending node.

System action: Processing continues.

Operator response: None.

Module: HASCSCAN

Routing Code: #/1,2,10

Descriptor Code: -4

\$HASP827

Explanation:

▶▶—*parameter=value*—▶▶

This message is issued in response to the \$D or \$T command. It displays the specified parameter and its current value. A description of the displayed parameter can be found in *z/OS JES2 Initialization and Tuning Reference*. In the message text:

parameter

The name of the parameter,

value The value of the parameter.

System action: None.

Operator response: None.

Module: HASCSCAN

Routing Code: 1,2,10

Descriptor Code: 4

\$HASP828

Explanation:

▶▶—CKPTDEF VERSIONS/APPLCOPY—OFF DUE TO ERROR—▶▶

Because an error occurred during the initialization of the VERSIONING/APPLCOPY subtask, JES2 has altered the value of VERSION/APPLCOPY.

System action: Processing continues.

Operator response: None.

Module:

HASPIRMA

Routing Code: 2,10

Descriptor Code: 4

\$HASP829

Explanation:

▶▶—CKPTDEF—*keyword=value,...*—▶▶

\$HASP830 • \$HASP831

This message is issued in response to a:

- \$D CKPTDEF command
- \$T CKPTDEF command
- CKPTDEF reply to a \$HASP272 checkpoint reconfiguration message. (In this case, this message is highlighted and is not deleted until the subsequent \$HASP272 reply.)

Only the CKPTDEF parameters that are modifiable during the dialog are displayed. If, during a reconfiguration dialog, you need to see the complete set of CKPTDEF specifications, issue the `$D CKPTDEF` command. If you only need to see specific parameter settings (for example, CKPT1 and CKPT2), issue the `$D CKPTDEF,CKPT1,CKPT2` command. The description of the CKPTDEF statement in *z/OS JES2 Initialization and Tuning Reference* explains each of the parameters.

In the message text:

keyword

The name of the keyword.

value The value of the keyword.

System action: Processing continues.

Operator response: None.

Module: HASCSCAN

Routing Code: 1,2,10

Descriptor Code: 2,7, Note 27

\$HASP830

Explanation:

►►—CONDEF—*keyword=value, ..., —BUFFER=—nnn*—————◄◄

This message is issued in response to a \$D or \$T CONDEF command. The message displays the keywords defined on this statement and their current values.

In the message text:

keyword

The name of the keyword.

value The value of the keyword.

nnn The number of free buffer consoles

The description of the CONDEF statement in *z/OS JES2 Initialization and Tuning Reference* explains each of the keywords.

System action: Processing continues.

Operator response: None.

Module: HASCSCAN

Routing Code: 1,2,10

Descriptor Code: 4

\$HASP831

Explanation:

►►—NJEDEF—*keyword=value, ..., —OWNNAME=—nodename*—————◄◄

This message is issued in response to a \$D or \$T NJEDEF command. The message displays the keywords defined on this statement and their current values.

In the message text:

keyword

The name of the keyword.

value The value of the keyword.

nodename

The name of the node on which the operator entered the \$D and \$T command.

OWNNAME is the NJE node name of the local JES2 MAS complex. The description of the NJEDEF statement in *z/OS JES2 Initialization and Tuning Reference* explains each of the keywords.

System action: Processing continues.

Operator response: None.

Module: HASCSCAN

Routing Code: 1,2,10

Descriptor Code: 4

\$HASP832

Explanation:

▶▶—JOBPRTY—(—n—)—keyword=value,...————▶▶

This message is issued in response to a \$D or \$T JOBPRTY(*n*) command. The message displays the keywords defined on this statement and their current values. The description of the JOBPRTY(*n*) statement in *z/OS JES2 Initialization and Tuning Reference* explains each of the keywords.

In the message text:

n The priority number.

keyword

The name of the keyword.

value The value of the keyword.

System action: Processing continues.

Operator response: None.

Module: HASCSCAN

Routing Code: 1,2,10

Descriptor Code: 4

\$HASP833

Explanation:

▶▶—PRINTDEF—keyword=value,...————▶▶

This message is issued in response to a \$D or \$T PRINTDEF command. The message displays the keywords defined on this statement and their current values. The description of the PRINTDEF statement in *z/OS JES2 Initialization and Tuning Reference* explains each of the keywords.

In the message text:

keyword

The name of the keyword.

value The value of the keyword.

System action: Processing continues.

\$HASP835 • \$HASP836

Operator response: None.

Module: HASCSCAN

Routing Code: 1,2,10

Descriptor Code: 4

\$HASP835

Explanation:

▶▶—JOBDEF—*keyword=value,...*—JNUMBASE=—*nnn*, —JNUMFREE=—*mmm*, —JOBFREE=—*xxx*, —JOBRLDQ=YES▶▶

This message is issued in response to a \$D or \$T JOBDEF command. It displays the keywords defined on this statement and their current values. The description of the JOBDEF statement in *z/OS JES2 Initialization and Tuning Reference* explains each of the keywords.

In addition, this message displays the following related job information:

JNUMBASE

Displays the most recently assigned job number in the JES2 configuration.

JNUMFREE

Displays the number of job numbers in the RANGE= value on the JOBDEF statement that are not in use.

JOBFREE

Displays the number of free job queue elements (out of the number defined in JOBDEF JOBNUM=).

JOBRLDQ=YES

Notes that there are jobs on the rebuild queue.

In the message text:

keyword

The name of the keyword.

value The value of the keyword.

nnn The starting number.

mmm The number of available job numbers.

xxx The number of free job queue elements.

System action: Processing continues.

Operator response: None.

Module: HASCSCAN

Routing Code: 1/#,2,10

Descriptor Code: -4

\$HASP836

Explanation:

▶▶—OUTDEF—*keyword=value,...*—JOEFREE=—*nnnn*, —JOERBLDQ=YES▶▶

This message is issued in response to a \$D or \$T OUTDEF command. The message displays the keywords defined on this statement and their current values. The description of the OUTDEF statement in *z/OS JES2 Initialization and Tuning Reference* explains each of the keywords. In addition, this message displays the following related job information:

JOEFREE

The number of free job queue elements (JOEs).

JOERBLDQ

An indication or whether there are any JOEs on the rebuild queue.

In the message text:

keyword

The name of the keyword.

value

The value of the keyword.

nnnnn

The number of free job output elements.

System action: Processing continues.

Operator response: None.

Module: HASCSCAN

Routing Code: 2,10

Descriptor Code: 4

\$HASP837

Explanation:



This message is issued in response to a \$D or \$T JOBCLASS(*n*), STCCCLASS, or TSUCLASS command. The message displays the keywords defined on the statement and their current values. The description of the initialization statements in *z/OS JES2 Initialization and Tuning Reference* explains each of the keywords.

In the message text:

n

The job class.

keyword

The name of the keyword.

value

The value of the keyword.

System action: Processing continues.

Operator response: None.

Module: HASCSCAN

Routing Code: 2,10

Descriptor Code: 4

\$HASP838

Explanation:

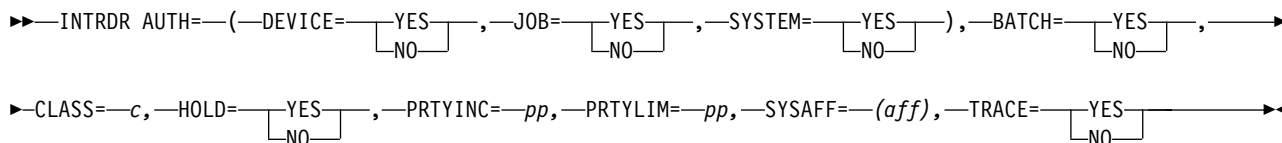

In the message text:

\$HASP839

AUTH

Specifies the JES2-authority level for commands entering the system from this device.

DEVICE

Specifies whether commands that affect devices can enter the system from this device.

JOB

Specifies whether commands that affect jobs can enter the system from this device.

SYSTEM

Specifies whether commands that affect system resources (for example, initiators) can enter the system from this device.

BATCH

Specifies whether batch jobs can use the internal readers.

CLASS

Specifies the job class assigned to jobs that enter the system on this device which do not have the CLASS parameter on the JOB JCL statement.

c A letter or decimal number that represents a class.

HOLD

Specifies whether jobs entering the system on this device are to be held until the operator releases the job for execution.

PRTYINC

Specifies a number that JES2 adds to the selection priority of each job that enters the system on this device.

pp A decimal number with a maximum of 15.

PRTYLIM

Specifies the maximum priority level that JES2 can assign to jobs entering the system on this device.

pp A decimal number with a maximum of 15.

dddd

A decimal number with a maximum value of 32,767.

SYSAFF

Specifies the system(s) in the multi-access spool (MAS) configuration that jobs entering the system on this device can run if SYSAFF is not specified on the /*JOBPARM JES2 control statement.

aff

Three letters or numbers.

TRACE

Specifies whether tracing is active for this device.

System action: Processing continues.

Operator response: None.

Module: HASCSCAN

Routing Code: 1,2,10

Descriptor Code: 4

\$HASP839

Explanation:

▶▶—TPDEF—*keyword=value,...*—AUTONUM=—*nnnn*,—BSCBUF=—(—| STATS |—)—SNABUF=—(—| STATS |—)—▶▶

▶—SESSIONS=—(—| STATS |—)—FROZEN=—*zzzz*—▶▶

STATS:

|—LIMIT=—*llll*,—WARN=—*www*,—FREE=—*ffff*—|

This message is issued in response to a \$D or \$T TPDEF command. The message displays the keywords defined on this statement and their current values.

The AUTONUM display-only parameter shows the number of remotes in autologon mode as specified by RMT(*nnnn*) Autolog=Yes.

BSCBUF= displays the maximum number (*llll*), the threshold percent for warning messages (*www*) and the free buffers (*ffff*) below 16-megabytes in virtual storage.

SNABUF= displays the maximum number (*llll*), the threshold percent for warning messages (*www*) and the free buffers (*ffff*) above 16-megabytes in virtual storage.

SESSIONS= displays the maximum number (*llll*) of VTAM sessions defined, the threshold percent for warning messages (*www*), and the number of free (*ffff*) and frozen (*zzzz*) VTAM sessions. (FREE= and FROZEN= are display-only parameters.)

The description of the TPDEF statement in *z/OS JES2 Initialization and Tuning Reference* explains each of the keywords. In the message text:

keyword

The name of the keyword.

value The value of the keyword.

nnnn The number of remotes in autologon mode.

llll A maximum number of keywords.

www A threshold percentage for warning messages.

ffff The number of free buffers.

zzzz The number of frozen VTAM sessions.

System action: Processing continues.

Operator response: None.

Module: HASCSCAN, HASPCOMM

Routing Code: 1,2,10

Descriptor Code: 4

\$HASP840

Explanation:

►►—BUFDEF—*keyword=value,...*,—BELOWBUF=—(—LIMIT=—*llll*,—WARN=—*www*,—FREE=—*ffff*—)—————►

►—EXTBUF=—(—LIMIT=—*llll*,—WARN=—*www*,—FREE=—*ffff*—)—————►►

This message is issued in response to a \$D or \$T BUFDEF command.

The message displays the keywords defined on this statement and their current values. BELOWBUF= displays the maximum number (*llll*), the threshold percent for warning messages (*www*) and the free buffers below 16-megabytes in virtual storage. EXTBUF= displays the maximum number (*llll*), the threshold percent for warning messages (*www*) and the free buffers above 16 megabytes in virtual storage. The description of the BUFDEF statement in *z/OS JES2 Initialization and Tuning Reference* explains each of the keywords.

In the message text:

keyword

The name of the keyword.

value The value of the keyword.

lll A maximum number of keywords.

www A threshold percentage for warning messages.

\$HASP841 • \$HASP842

fff The number of free buffers.

System action: Processing continues.

Operator response: None.

Module: HASCSCAN

Routing Code: 1,2,10

Descriptor Code: 4

\$HASP841

Explanation:

▶▶—SMFDEF—*keyword=value, . . .*,—BUFFREE=—*nnnn*—————▶▶

This message is issued in response to a \$D or \$T SMFDEF command. The message displays the keywords defined on this statement and their current values. The number of free SMF buffers is also included in the message text through the BUFFREE= keyword. The description of the SMFDEF statement in *z/OS JES2 Initialization and Tuning Reference* explains each of the keywords.

In the message text:

keyword

The name of the keyword.

value The value of the keyword.

nnnn The number of free buffers.

System action: Processing continues.

Operator response: None.

Module: HASCSCAN

Routing Code: 1,2,10

Descriptor Code: 4

\$HASP842

Explanation:

▶▶—OUTCLASS—*keyword=value, . . .*,—————▶▶

This message is issued in response to a \$D or \$T OUTCLASS(n) command. The message displays the keywords defined on this statement and their current values. The description of the OUTCLASS(n) statement in *z/OS JES2 Initialization and Tuning Reference* explains each of the keywords.

In the message text:

n The output class.

keyword

The name of the keyword.

value The value of the keyword.

System action: Processing continues.

Operator response: None.

Module: HASCSCAN

Routing Code: 1,2,10

Descriptor Code: 4

\$HASP843

Explanation:

▶▶—MASDEF—*keyword=value,...*————▶▶

This message is issued in response to a \$D or \$T MASDEF command. The message displays the keywords defined on this statement and their current values. The description of the MASDEF statement in *z/OS JES2 Initialization and Tuning Reference* explains each of the keywords. Also see \$D MASDEF and \$T MASDEF in *z/OS JES2 Commands*. In the message text:

keyword

The name of the keyword.

value The value of the keyword.

System action: Processing continues.

Operator response: None.

Module: HASCSCAN

Routing Code: 1,2,10

Descriptor Code: 4

\$HASP844

Explanation:

▶▶—SPOOLDEF—*keyword=value,...*—TGSPACE=—(—FREE=—*nnnnn*—)————▶▶

This message is issued in response to a \$D or \$T SPOOLDEF command. The message displays the keywords defined on this statement and their current values.

The keyword LASTVAL has a time stamp that represents the last time the system was either cold started, warm started using SPOOL=validate, or when there is a detected error as a result of SPOOL=validate and the source of the error will be reported in message \$HASP492.

The number of free track groups on active spool volumes is also included in the message text with the TGSPACE=(FREE= keyword).

The description of the SPOOLDEF statement in *z/OS JES2 Initialization and Tuning Reference* explains the SPOOLDEF keywords. Also see \$D SPOOLDEF and \$T SPOOLDEF in *z/OS JES2 Commands*

GCRATE displays the current rate of garbage collection by spool space management as either NORMAL (an approximate 7-day cycle) or FAST (accelerated without 7-day pacing). If GCRATE=FAST is in effect, JES2 also displays the percentage of garbage collection completed as FAST,nn.nn% FINISHED.

Note: GCRATE= is set by \$T command and displayed by \$D command only.

In the message text:

keyword

The name of the keyword.

value The value of the keyword.

nnnnnn

The number of free track groups.

Note: The value assigned to SPOOLNUM is always displayed as a multiple of 32.

System action: Processing continues.

Operator response: None.

Module: HASCSCAN

Routing Code: 1,2,10

Descriptor Code: 4

\$HASP845 • \$HASP846

\$HASP845

Explanation:

►►—ESTxxx—keyword=value,...,—————►►

This message is issued in response to a \$D or \$T ESTxxxx command. The message displays the keywords defined on this statement and their current values. The description of the ESTxxxx statement in *z/OS JES2 Initialization and Tuning Reference* explains each of the keywords.

In the message text:

xxxx One of the following:

BYTE

IME

LNCT

PAGE

PUN

keyword

The name of the keyword.

value The value of the keyword.

System action: Processing continues.

Operator response: None.

Module: HASCSCAN

Routing Code: 1,2,10

Descriptor Code: 4

\$HASP846

Explanation:

►►—RECVOPTS(type)—keyword=value,...,—————►►

This message is issued in response to a \$D or \$T RECVOPTS command. The message displays the keywords defined on this statement and their current values. The description of the RECVOPTS statement in *z/OS JES2 Initialization and Tuning Reference* explains each of the keywords.

In the message text:

type The type of recovery option.

keyword

The name of the keyword.

value The value of the keyword.

System action: Processing continues.

Operator response: None.

Module: HASCSCAN

Routing Code: #/2,10

Descriptor Code: -4

\$HASP847

Explanation:

▶▶—PUNCHDEF—*keyword=value,...*—▶▶

This message is issued in response to a \$D command that specified the PUNCHDEF initialization statement. The message displays the keywords defined on this statement and their current values. The description of the PUNCHDEF statement in *z/OS JES2 Initialization and Tuning Reference* explains each of the keywords. In the message text:

keyword

The name of the keyword.

value The value of the keyword.

System action: Processing continues.

Operator response: None.

Module: HASCSCAN

Routing Code: 1,2,10

Descriptor Code: 4

\$HASP848

Explanation:

▶▶—OUTPRTY(n)—*keyword=value,...*—▶▶

This message is issued in response to a \$D or \$T OUTPRTY(n) command. The message displays the keywords defined on this statement and their current values. The description of the OUTPRTY(n) statement in *z/OS JES2 Initialization and Tuning Reference* explains each of the keywords. In the message text:

n The output priority number.

keyword

The name of the keyword.

value The value of the keyword.

System action: Processing continues.

Operator response: None.

Module: HASCSCAN

Routing Code: 1,2,10

Descriptor Code: 4

\$HASP849

Explanation:

▶▶—PCEDEF—*keyword=value,...*—▶▶

This message is issued in response to a \$D command that specified the PCEDEF initialization statement. The message displays the keywords defined on this statement and their current values. (For example, the STACNUM keyword displays the number of STATUS/CANCEL PCEs available.) The description of the PCEDEF statement in *z/OS JES2 Initialization and Tuning Reference* explains each of the keywords. In the message text:

\$HASP850 • \$HASP851

keyword

The name of the keyword.

value The value of the keyword.

System action: Processing continues.

Operator response: None.

Module: HASCSCAN

Routing Code: #/1,2,10

Descriptor Code: -4

\$HASP850

Explanation:

▶▶—*nnnnnn*—TRACK GROUPS ON—*volser*—▶▶

This message shows that *nnnnnn* track groups are mapped in the master TGM (track group map) for the HASPACE data set on the spool volume indicated by *volser*.

If message \$HASP811 or \$HASP854 accompany this message, there was not enough space in the master TGM to map all of the track groups on spool volume *volser*. JES2 mapped *nnnnnn* of the track groups, but *nnnnnn* is less than the total number of track groups on the volume.

In the message text:

nnnnnn The number of track groups.

volser The volume identifier.

Message \$HASP854 is returned even if the requisite number of track groups seemed to be available, based on the MAX and INUSE values returned by \$D SPOOLDEF. This message is issued because JES2 attempts to allocate the complete data set based on the spool calculations for each device type, as described in *z/OS JES2 Initialization and Tuning Guide*.

JES2 reached the MAX value setting before it could complete the allocation of the spool data set. The value returned by the \$HASP850 message is only the number of track groups that JES2 was able to allocate, and not the entire data set that is required to use the spool data set.

System action: JES2 processing continues in most cases. However, if message \$HASP811 or \$HASP854 accompany this message, JES2 waits for the operator to reply to message \$HASP811 or \$HASP854.

Operator response: None.

Module: HASPSPOL, HASPIRDA

Routing Code: 1,2,10

Descriptor Code: 4

\$HASP851

Explanation:

▶▶—*nnnnnn*—TOTAL TRACK GROUPS MAY BE ADDED—▶▶

The master TGM (track group map) contains enough space to map *nnnnnn* more track groups. This space is available to map track groups on additional spool volumes that are started using the \$S SPOOL command. The \$HASP850 message gives an exact map of how the space is being used. This message is written to the system log during JES2 initialization, or when a volume is started or drained.

In the message text:

nnnnnn

The number of track groups.

System action: JES2 processing continues.

System programmer response: Use this value to determine the amount of spool space that can be added to the JES2 configuration.

Module: HASPSPOL

Routing Code: 1,2,10

Descriptor Code: 4

\$HASP852

Explanation:

```
| ►►CKPTSPACE BERTNUM=brts,—BERTFREE=free,—BERTWARN=cc—————►
| ►CKPT1=(—CAPACITY=cap1,—UNUSED=unuse2,—TRACKS=trks1),—————►
|                                     └──SIZE=b1ks1──┘
| ►CKPT2=(—CAPACITY=cap2,—UNUSED=unuse2,—TRACKS=trks2),—————►
|                                     └──SIZE=b1ks2──┘
```

| Alternate output:

```
| CKPTSPACE CURRENT BERT UTILIZATION
| TYPE                COUNT    CB COUNT
| -----
| name                count   cbcount
```

| This message is issued in response to a \$D command that specified the CKPTSPACE statement. The message displays the keywords defined on this statement and their current values.

This message displays the following CKPTSPACE information:

BERTNUM

The number of BERT (Block Extent Reuse Table) entries defined in the checkpoint.

BERTFREE

The current number of free BERT entries.

BERTWARN

The threshold of BERT utilization at which the \$HASP050 message should be issued.

CKPT1 Displays information about the number of 4K records in this checkpoint data set.

CAPACITY

The maximum capacity of the CKPT1 data set in 4K records.

UNUSED

The number of 4K records that are unused by the CKPT1 data set

TRACKS

If CKPT1 is currently in use on a DASD data set, this displays the number of tracks in the data set.

SIZE

If CKPT1 is currently in use on a coupling facility structure, this displays the current size of the structure in 1K blocks.

CKPT2 Displays information about the number of 4K records in this checkpoint data set.

CAPACITY

The maximum capacity of the CKPT2 data set in 4K records.

UNUSED

The number of 4K records that are unused by the CKPT2 data set

TRACKS

If CKPT2 is currently in use on a DASD data set, this displays the number of tracks in the data set.

\$HASP853

| **SIZE** If CKPT2 is currently in use on a coupling facility structure, this displays the current size of the
| structure in 1K blocks.

| This message is also issued in response to a \$D command that specified CKPTSPACE with the BERTUSE keyword.
| The message displays all of the types of BERTs that are supported by the system and the number of BERTs associated
| with each type. The types depend on level of JES2 you are using and any BERT types added by exits or vendor
| products.

| *name* (**column 1**)

| The name associated with the BERT usage. INTERNAL is listed for BERTs that are used to manage the BERT
| table.

| *count* (**column 2**)

| The count of BERTs that are associated with this name.

| *cbcount* (**column 3**)

| The count of control block instances that are using this type of BERT. BERTs are used to store data
| associated with a control block. One control block can require multiple BERTs to represent it. This value
| helps understand if the usage is due to the size of the control blocks or the number of control blocks.

System action: Processing continues.

System programmer response: None.

Module: HASCSKAN

\$HASP853

Explanation:

▶—REPLY—┐
 ├──GO, QUIT, OR PURGE──┐
 └──QUIT OR PURGE──┘

One of the following two situations has occurred:

1. This message is issued during a cold start if there is not enough space in the TGM (track group map) to map all of the track groups on spool volume *volser* in messages \$HASP850 and \$HASP854, which precede this message. \$HASP850 indicates how many track groups for this volume are currently mapped in the track group map.
2. This message is issued during an all-member warm start if a spool volume was mounted during earlier JES2 processing, but is not mounted and online currently. The volume that cannot be allocated and any related volumes are identified in the preceding \$HASP867 message.

System action: JES2 waits for the operator to reply.

Operator response: Notify the system programmer and reply GO, QUIT, or PURGE depending on the action you want taken.

During a cold start:

GO Initialization continues. JES2 reduces the extents for the spool volume to fit it into the track group map. No more volumes can be mapped in the TGM unless you first drain some volumes. Also, to fully use the volume later, increase TGSPACE=(MAX=), then drain and restart the volume.

QUIT

JES2 ends.

PURGE

JES2 initialization continues but the volume is not used.

During an all-member warm start:

GO Initialization continues without the volume. JES2 places the volume in an INACTIVE state. The track groups are inaccessible until you remount and restart the volume using the \$S SPOOL command. On an all-member warm start, this option is only presented if spool validation was **not** requested or required. Any active spool migration is canceled (even during the CATCHUP phase) and the volume is reset to the pre-migration state with a status of DRAINING. All volumes that are mapped to the failing volume are also marked INACTIVE.

QUIT

JES2 ends.

PURGE

JES2 drains the volume and removes all jobs that have space on the volume. All tracks that are allocated to these jobs will be lost until an all-member warm start is performed—if you have specified SPOOL=VALIDATE as a start option—or within 7 days as provided by the JES2 spool reclamation function, whichever occurs first. If a spool migration target is the problem volume, then the spool migration is canceled, even during the CATCHUP phase. Any volume that is mapped to the problem volume is also removed.

Note: If a spool migration is cancelled due to the processing for this message, the spool volume that was allocated for the migration on the target volume remains marked as allocated and will be cleaned up by the JES2 spool reclamation function. If jobs have additional spool space allocated on the target volume after the cancellation, this will be cleaned up the next time the JES2 spool reclamation function runs after the job is purged.

System programmer response: To fully use the volume later, reply N to \$HASP811 or PURGE to \$HASP853. Increase the TGSPACE=(MAX=) value with a \$T SPOOLDEF operator command. Restart the specified volume, *volser*.

If this is a COLD start, to fully use the volume later, reply PURGE to \$HASP853. Once JES2 has started, increase the TGSPACE=(MAX=) value with a \$T SPOOLDEF operator command and start the specified volume.

Module: HASPIRDA

Routing Code: 1,2,10

Descriptor Code: 4

\$HASP854

Explanation:

▶▶—MAXIMUM NUMBER OF TRACK GROUPS EXCEEDED WHILE ALLOCATING VOLUME—*volser*————▶▶

This message is issued during JES2 initialization or in response to a \$\$ SPOOL command. There is not enough space in the master track group (TGM) map to map all of the track groups on the spool volume identified by *volser*. Use TGSPACE=(MAX=) on the SPOOLDEF statement to set or reset space available to the TGM.

In the message text:

volser The volume identifier.

System action: Message \$HASP850 accompanies this message, showing how many of the track groups on volume *volser* are mapped in the master TGM. This message is followed by message \$HASP853 during initialization or by message \$HASP811 during start spool processing to request operator intervention.

Operator response: Reply to the \$HASP853 or \$HASP811 message.

Module: HASPIRDA, HASPSPOL

Routing Code: 1,2,10

Descriptor Code: 4

\$HASP855

Explanation:

▶▶—JCL PROCESSING LIMITED DUE TO—ERROR IN SYSTEM JDT————▶▶

During JES2 initialization, scheduler JCL facility (SJF) services were invoked that returned a non-zero return code. Because of the error in the JCL definition table (JDT) library, full JCL processing is not allowed by JES2.

System action: JES2 will prompt the operator to determine if JES2 initialization should continue and attempt to issue a dump if the SJF service did not issue one. If JES2 initialization is continued with the error, then JES2 bypasses all future use of SJF processing and will not honor the JCL OUTPUT statement.

Operator response: Notify the system programmer.

\$HASP856 • \$HASP857

System programmer response: Correct the JDT library.

Module: HASPIRMA

Routing Code: 1,2,10

Descriptor Code: 2,7

\$HASP856

Explanation:

▶▶—JES2 FSS SERVICES PROHIBITED DUE TO—CROSS MEMORY AXxxx ERROR, RC=—rc—————▶▶

JES2 failed to establish the cross memory authorization index (AX) required for support of the functional subsystems. In the message text:

xxx Either RES or SET.

rc A return code.

System action: Functional subsystem address spaces will not be started by JES2.

Operator response: Save the hard-copy log and notify the system programmer. For systems with remote consoles, save the remote console sheet.

If the functional subsystem supported devices are also supported in JES mode, you may enter the \$T command to set the devices to MODE=JES. The devices are then available for direct JES2 use.

System programmer response: Determine the reason for the AXRES or AXSET error and correct it. If you want, have the operator stop and restart JES2. For a description of the return code, see *z/OS MVS Programming: Assembler Services Reference ABE-HSP*.

If you use SMP/E to make all changes to the system, run LIST CDS and LIST PTFBY functions of SMP/E to obtain a list of the current maintenance from the SMP/E control data set (CDS).

If you make any changes to the system without using SMP/E, run the LISTIDR function of AMBLIST to obtain a list of all members with a PTF or local fix and save the output. Run LISTIDR against the following:

- SYS1.LINKLIB.
- SYS1.SVCLIB
- The library containing the program that issued the message.
- SYS1.LPALIB

Contact the IBM Support Center for assistance.

Module: HASPIRMA

Routing Code: 1,2,10

Descriptor Code: 2,7

\$HASP857

Explanation:

▶▶—WARNING - EXITnnn—NOT DEFINED WITHIN CURRENTLY—LOADED JES2 MODULES—————▶▶

There is a JES2 initialization statement for EXIT(nnn), but that exit is not defined. That is, there is no module loaded that issues the \$EXIT macro instruction for exit point *nnn*.

In the message text:

nnn The number of the exit.

System action: JES2 initialization continues.

Operator response: Notify the system programmer.

System programmer response: This is only an informational message. Verify that the exit will be loaded at a later time or that the exit is not required.

Module: HASPIRPL

Routing Code: 1,2,10

Descriptor Code: 4

\$HASP858

Explanation:

▶▶—EXIT ROUTINE—*nnn*—(—EXIT*nnn*—)—NOT FOUND—▶▶

The exit routine name that appears in the message text was specified on the EXIT(*nnn*) initialization statement, but JES2 could not find that routine. Either there is no LOAD initialization statement for the module containing the routine, or there is no \$ENTRY macro instruction defining the routine name as an entry point.

In the message text:

name The name of the exit routine.

nnn The number of the exit.

System action: JES2 issues messages \$HASP859 and \$HASP441, then waits for the operator to reply.

Operator response: Notify the system programmer. Reply Y or N to message \$HASP441. If you reply Y, JES2 ignores the missing exit routine and processes any other exit routines specified for EXIT*nnn*. If you reply N, JES2 issues message \$HASP428 and ends.

System programmer response: Determine why the exit routine cannot be found and correct the problem.

Module: HASPIRPL

Routing Code: 1,2,10

Descriptor Code: 2,7

\$HASP859

Explanation:

▶▶—REQUESTED EXIT ROUTINE(S)—NOT FOUND—▶▶

JES2 cannot find the exit routine name indicated in the preceding \$HASP858 message.

System action: JES2 issues message \$HASP441 and waits for the operator to reply.

Operator response: Notify the system programmer. Reply Y or N to message \$HASP441. If you reply Y, JES2 ignores the missing exit routine and processes any other exit routines specified for EXIT*nnn*. If you reply N, JES2 issues message \$HASP428 and ends.

System programmer response: Determine why the exit routine cannot be found and correct the problem.

Module: HASPIRPL

Routing Code: 1,2,10

Descriptor Code: 2,7

\$HASP860

Explanation:

▶▶—REQJOBID JESLOG=—*xxxxxxxx*—▶▶

JES2 issues this message in response to a \$D or \$T REQJOBID command. The message displays the keywords defined

\$HASP861 • \$HASP862

on this statement and their current values. Request JOB ID jobs (For example, RACF or NETVIEW) will have this JESLOG specification supplied by default.

In the message text:

xxxxxxx

Displays the current system setting for spinning off JESLOG data (JESMSGLG and JESYSMSG data sets).

System action: Processing continues.

Operator response: None.

System programmer response: None.

Module: HASCSCAN

Routing Code: 1,2,10

Descriptor Code: 4

\$HASP861

Explanation:

▶▶—INVALID BADTRACK STATEMENT—VOL—*volser*—
 └—ADDR—*bbcchh*—▶▶

A BADTRACK initialization statement is incorrect:

- If **VOL** *volser* appears in the message text, the volume serial number specified on the initialization statement is incorrect.
- If **ADDR** *bbcchh* appears, the range of track addresses specified on the initialization statement includes a track address that is incorrect or is not on the specified volume.

The variables are:

bb The bin identifier, or zero.

cc The cylinder identifier.

hh The head identifier.

System action: JES2 ignores the incorrect BADTRACK initialization statement.

Operator response: Notify the system programmer.

System programmer response: Correct the incorrect BADTRACK initialization statement.

Module: HASPIRDA

Routing Code: 1,2,10

Descriptor Code: 4

\$HASP862

Explanation:

▶▶—JES2 CANNOT START BECAUSE A—CHECKPOINT RECONFIGURATION IS—IN PROGRESS—▶▶

This member is unable to initialize because a checkpoint reconfiguration is in progress.

System action: JES2 issues \$HASP428 requesting that the operator correct the problems noted in previous messages.

Operator response: Wait for the checkpoint reconfiguration to complete, then restart JES2.

System programmer response: None.

Module: HASPCKRR

Routing Code: 1,2,10

Descriptor Code: 4

\$HASP863

Explanation:

- ▶▶—MORE THAN 10 SPOOL I/O ERRORS OCCURRED.—SHOULD JES2 CONTINUE THE WARM START?—————▶▶
- ▶—VALID RESPONSES ARE:—'CONTINUE' - CONTINUE THE WARM START—————▶
- ▶—'ABEND' - TERMINATE JES2 WITH \$V02 ABEND—————▶▶

JES2 warm start processing has detected at least 10 errors accessing SPOOL. This message is followed by the \$HASP272 WTOR. This can be caused by a mismatch between the SPOOL and the checkpoint data sets or by starting with an old SPOOL or checkpoint data set. At this point, JES2 has not written any significant data to the SPOOL or checkpoint data sets.

If you reply CONTINUE to \$HASP272, JES2 will initialize and write updated data to the current checkpoint and SPOOL data sets. If you reply ABEND, JES2 terminates and can be restarted with the correct checkpoint and SPOOL data sets.

System action: JES2 issues the \$HASP272 WTOR to query the operator for continuation options.

Operator response: Verify that the current checkpoint data and SPOOL data sets are correct. If you are restarting after losing a SPOOL volume or from an old checkpoint data set because of another error, then the I/O errors should be expected. If there was no prior error and this message is unexpected, then there might be a problem with the current checkpoint. Reply ABEND and restart JES2 using the PARM=CONSOLE option. When JES2 issues the \$HASP469 message, use the DISPLAY reply to examine the checkpoint and SPOOL data sets being used and ensure that they are correct.

System programmer response: None.

Module: HASPWARM

Routing Code: 1,2,10

Descriptor Code: 2,7

\$HASP864

Explanation:

- ▶▶—INITIALIZATION TERMINATED BY—INSTALLATION EXIT—*nn*—(ROUTINE—*routine*—)—————▶▶

This message is issued when one of the following installation exits determines that JES2 initialization should end:

- 0 – Pre-initialization exit
- 19 – Initialization parameter statement exit
- 24 – Post-initialization exit

In the message text:

nn The number of the installation exit.

routine The name of the exit routine that requested JES2 initialization to be terminated.

System action: Processing continues and initialization ends.

Operator response: Notify the system programmer.

System programmer response: Correct the problem that installation exit 0 found or change the initialization deck to disable exit 19 or exit 24.

Module: HASPIRA

Routing Code: 1,2,10

Descriptor Code: 4

\$HASP865 • \$HASP866

\$HASP865

Explanation:

►►—CONFIRM MEMBER—(*nn*)—NAME=—*memname1*—IS TO BE—CHANGED TO—*memname2*—
—DELETED—
—ADDED—

JES2 detects that a request was made during a restart of JES2 to change, delete, or add member name *memname* for a member of a multi-access spool configuration:

- When the member name is being changed, *nn* indicates the old number and *memname1* indicates the old name for the member indicated by the NAME= parameter on the MEMBER initialization statement; *memname2* indicates the new member name.
- When the member name is being deleted from the configuration, *memname1* indicates the member for NAME= being deleted.
- When a member name is being added to the configuration, *memname1* indicates the member name for the member being added.

In the message text:

nn The member number.

memname
 The member name.

Note: The NAME= *memname* parameter on the MEMBER initialization statement defines a member of a multi-access spool configuration to JES2.

System action: The \$HASP870 message is issued to request what action should be taken.

Operator response: Notify the system programmer.

System programmer response: When \$HASP870 is issued, see the description of the responses under the system action. Give the appropriate reply.

Module: HASPIRDA

Routing Code: 1,2,10

Descriptor Code: 4

\$HASP866

Explanation:

►►—*devname*—IMPLICIT— FSS DEFINITION INVALID,—NO FSS ASSIGNMENT MADE—

The device initialization statement for *devname* specified FSS=xxxx, indicating the device was supported by an FSS. An FSS(xxxx) initialization statement was not provided for this FSS. Although JES2 attempted, after parameter processing, to process the implicitly defined FSS(xxxx), it encountered an error. A GETMAIN for the FSS definition may have failed.

In the message text:

devname
 The name of the device.

System action: Processing continues. The FSS will not be defined and the device will not be supported by an FSS.

Operator response: Notify the system programmer. If the FSS should be created, use the \$ADD FSS(xxxx) command when the hot start completes. The device can be moved to the FSS using the \$T device,FSS=xxxx command.

System programmer response: Either correct the initialization statements or have the operator create the FSS.

Module: HASPIRMA

Routing Code: 1,2,10

Descriptor Code: 4

\$HASP867

Explanation:

▶▶—Unable to allocate spool data set,—the source of an active migration—————▶

▶—VOL=—*volser1*—DSN=—*dsname1*—Volume(s) that are mapped to— *volser1*—VOL=—*volser2*—DSN=—*dsname2*————▶

▶—Volume actively migrating to— *volser1*—VOL=—*volser3*—DSN=—*dsname1*—PHASE=—*phase*————▶▶

Valid responses are:

GO Continues the JES2 warm start and halts the volume.

QUIT Terminates the JES2 warm start.

PURGE

Removes the volume and mapped volume(s) and purges all jobs that are using the volume.

While performing an all member warm start, JES2 was unable to allocate the volume *volser1* and *dsname1*. Because of spool migration processing, this can impact other spool volumes. If there are volumes mapped to the affected volume or actively migrating to the volume, those volumes are listed in the message.

In the message text:

volser1/dsname1

The volume serial and data set name of the spool volume that cannot be allocated.

volser2/dsname2

The volume serial and data set name of spool volumes that are mapped to the volume that cannot be allocated. One set of volume serials and data set names are listed for each volume mapped to the volume.

volser3/dsname3

The volume serial and data set name of the volume that is actively being migrated to the volume that cannot be allocated.

phase

The migration phase that the spool volume was in when the system went offline: INITIALIZING, SETUP, COPY, CATCHUP, CANCEL, CLEANUP or BACKOUT.

You must respond with one of the following options:

GO This option (if available) continues JES2 initialization and marks the listed volume (*volser1*) as INACTIVE. Use this option if the condition that prevented the allocation is correctable without a loss of data. If there is an active spool migration with *volser1* as the Source or Target volume, then that migration is cancelled, even if it is in the CATCHUP phase. This can result in the loss of any updates that were made during the COPY phase. If there are any volumes (*volser2*) listed as mapped to *volser1*, then they will also be halted. Once the problem with *volser1* is corrected, issue the **\$\$ SPOOL**(*volser1*) command to restart the volume and all volumes that are mapped to it.

QUIT This option terminates JES2 initialization.

PURGE

This option removes the listed volume from the spool configuration. All jobs and SYSOUT on the volume are lost. Use this option if the condition that prevented the allocation is permanent and the volume (and its contents) cannot be restored. If this volume is the source of an active spool migration, the migration is cancelled and the source volume is deleted and all data is lost. If this volume is the target of an active spool migration, the migration is cancelled but the source volume (*volser3*) remains available. If there are volumes mapped to this volume (*volser2*), this option removes all mapped volumes from the spool configuration.

System action: System issues the \$HASP853 message and waits for the operator to reply.

Operator response: Notify the system programmer.

System programmer response: Use the previous error messages to determine why the volume cannot be allocated.

\$HASP868 • \$HASP870

If this is a recoverable situation (such as the volume is offline), correct the problem, reply **QUIT** to the message and restart JES2.

If this is a situation that will require some time to correct (such as the device needs to be restarted), then reply **GO** to allow JES2 to complete initialization and mark the affected volumes as inactive. Once the problem is corrected, issue the **\$\$ SPOOL** command to restart the failed volume.

If this situation cannot be recovered (such as the device is damaged beyond repair), then reply **PURGE**. Any job that is using the volume will be purged from the system.

Module: HASPIRDA

Routing Code: 1,2,10

Descriptor Code: 2,7

\$HASP868

Explanation:

▶▶—AFFINITY INVALID ON DEVICE—*devname*—▶▶

The system affinity list is incorrect for the specified offload job transmitter or offload job receiver.
In the message text:

devname

The name of the device.

System action: JES2 processing continues. The indicated offload job transmitter or offload job receiver is defined with a default affinity list.

Operator response: When JES2 initialization is complete, use the \$T OFFn.JT or the \$TOFFn.JR command to set the correct system affinity list.

Module: HASPIRMA

Routing Code: 1,2,10

Descriptor Code: 4

\$HASP869

Explanation:

▶▶—.... - JOB NOT FOUND—▶▶

This message is issued in response to a ZAPJOB command when no jobs are found that match the input parameters. This message is only issued during JES2 initialization processing.

System action: Processing continues.

Operator response: None.

Module: HASCSCAN

Routing Code: 1,2,10

Descriptor Code: 4

\$HASP870

Explanation:

▶▶—REPLY Y TO CONFIRM, N TO REFUSE—OR T TO TERMINATE—▶▶

JES2 detects that a change to a member name has been requested. The message \$HASP865 precedes this message specifying the requested change.

System action: A reply of Y causes the change requested in message \$HASP865 to occur. JES2 initialization will continue with the new member name assigned to the configuration.

A reply of N causes the requested change to be ignored. If this member did not make the request, JES2 initialization will continue with the member name unchanged from the previous start of JES2.

A reply of T causes JES2 initialization to end.

Operator response: Give the appropriate response as described above. If you reply T, the system programmer should correct the initialization data set by assigning the correct member name or deleting the member name from the MEMBER initialization statement. When the member names are corrected, restart JES2.

System programmer response: Correct the initialization data set as described above.

Module: HASPIRA

Routing Code: 1,2,10

Descriptor Code: 4

\$HASP871

Explanation:

▶▶—WARNING— - SYS1.IMAGELIB FAILED TO OPEN—▶▶

During JES2 initialization, an error was encountered attempting to open the SYS1.IMAGELIB data set.

System action: Message \$HASP872 follows, requesting operator action.

Operator response: None. See message \$HASP872.

System programmer response: Determine the cause of the error and take corrective action.

Note: Data management message IEC119I may have been issued to aid in problem determination.

Module: HASPIRMA

Routing Code: 1,2,10

Descriptor Code: 4

\$HASP872

Explanation:

▶▶—REPLY 'Y' TO CONTINUE INITIALIZATION, —'N' TO TERMINATE OR 'R' TO RETRY—▶▶

JES2 encountered an error during initialization while trying to attach a JES2 subtask. This message is prompting the operator to decide if initialization should continue or not.

System action:

- If the response is Y, JES2 proceeds with initialization. Errors may occur when JES2 tries to process jobs.
- If the response is N, JES2 issues message \$HASP428 and ends.
- If the response is R, JES2 tries to attach the subtask again. If the subtask is attached, initialization continues. If the subtask is not attached, JES2 issues message \$HASP872 again.

Operator response: Notify the system programmer. Reply Y, N, or R.

System programmer response: Determine the cause of the error, and take corrective action.

Module: HASPIRA

Routing Code: 1,2,10

Descriptor Code: 4

\$HASP873 • \$HASP875

\$HASP873

Explanation:

▶▶—*ttttttt*—ATTACH FAILED— - INSUFFICIENT STORAGE—▶▶

There is not enough storage available for the dynamic DTE service routine (\$DTEDYNA) to complete attach processing for subtask *ttttttt*.

In the message text:

ttttttt The name of the subtask.

System action: Control is returned to the JES2 processor that tried to attach the subtask. The type of processing (recovery, end, or normal) depends on the individual JES2 processor.

Operator response: Notify the system programmer.

System programmer response: Determine why there is insufficient storage in the JES2 address space and correct the error.

Module: HASPDYN

Routing Code: 1,2,10

Descriptor Code: 4

\$HASP874

Explanation:

▶▶—JES2 VERSION—*vvvvvvvv*— IS INCOMPATIBLE WITH MVS—▶▶

JES2 detects that the SP level of this version of JES2 *vvvvvvvv* is not compatible with the level of MVS under which it is running.

In the message text:

vvvvvvvv

The version number of JES2.

System action: JES2 issues the \$HASP428 message and then ends.

Operator response: Notify the system programmer.

System programmer response: Determine the correct version of JES2 to run on the current MVS system and then reinitialize your system.

Module: HASPIRMA

Routing Code: 1,2,10

Descriptor Code: 4

\$HASP875

Explanation:

▶▶—*module* - —*reason*, —RC=—*rsnc*—▶▶

Either the \$MODLOAD routine detected an error during the loading of the specified module or the \$MODCHK routine detected an error during verification. The variable text and reason code indicate the exact reason for the error. These are explained under the programmer response section.

In the message text:

module

The name of the module.

reason Explains the reason for the error.

rsnc The reason code accompanying *reason*.

Note: This message is issued only if MESSAGE=YES is specified on the \$MODLOAD or \$MODCHK macros.

Explanation:

►►—INSUFFICIENT STORAGE FOR LOAD—MODULE TABLE ENTRY, RC=01—◄◄

An attempt was made to allocate a load module table entry for the displayed load module, but no storage was available. There is no logical limit on the number of entries, except the amount of available storage.

Explanation: An attempt to load the module failed. The module is probably not in the correct library (STEPLIB, LINKLIST, or LPA).

Explanation: Because the module is not reentrant, it could not be loaded into the common storage area (CSA).

Explanation: On this JES2 hot start, an attempt was made to either load a module into CSA or to load a module that was in LPA. New common storage modules cannot be loaded on a hot start because the existing modules may be in use for common storage exits and the exit routines cannot be changed.

Explanation: A request was made to load a module into CSA, but no CSA storage was available.

Explanation: The module being loaded is marked as RMODE 31 and resides above 16 megabytes in virtual storage. All JES2 code must be marked RMODE 24.

Explanation: During module verification, a JES2-format module was checked to ensure its load module name matched the name in the module information table (MIT). The check failed.

Note: No JES2 uses of \$MODCHK specify that this type of check should be done at this time; the programmer specified this verification.

Explanation: The version number in the module information table (MIT) for this module does not match the version of the JES2 release that is running.

Explanation: The module was assembled with a set of MVS macro libraries different from the set used to assemble the JES2 system that is running (for example MVS/ESA rather than z/OS).

Explanation: The \$MODCHK routine determined that this module is not in common storage. This error should not occur with the modules that JES2 loads because it forces these modules into CSA if they are not in LPA.

Explanation: The module information table (MIT) for the module is not valid for one or more of the following reasons:

- The module is not long enough to contain a module information table.
- The module does not begin with CL4'MIT'.
- The MITETBL pointer to the MIT entry table, which is generated at the end of the module, points to an address outside the range of the module.

Explanation: No verification checks were done by \$MODCHK because the address operand was not coded on the \$MODCHK macro and the entry point was not found in the load module table (\$LMT).

Note: This is probably because JES2 or an installation exit called \$MODCHK before a successful \$MODLOAD was performed.

Explanation: The module user version character string for this module in the module information table (as defined by &UVERS in \$HASPGBL), does not match the version of the JES2 release that is running.

Explanation: The user version character string for this module in the module information table (MIT) does not match the IBM-defined value.

Explanation: An IBM module was loaded into common storage during JES2 initialization saving the service routine's entry point address information. At least one entry point was defined (through the \$ENTRY macro) to have its address placed at an invalid offset within the CADDR control block.

Explanation: An IBM module was loaded into common storage during JES2 initialization saving the service routine's entry point address information. At least one entry point was defined (through the \$ENTRY macro) to have its address placed at an invalid offset within the CADDR control block where another entry point address has already been placed.

\$HASP875

System action: The system action depends on the module displayed and the specific circumstances:

- If the JES2 initialization module (HASPINIT) or one of its subsystem support modules had an error, JES2 initialization processing stops.
- If an MVS module that JES2 may load (for example, IEE7603D) had an error, JES2 asks the operator whether JES2 initialization should end.
- If the error occurred while processing a LOADMOD initialization statement, \$SCAN begins requesting input from the operator console instead of the normal parmlib input. This allows the operator to correct the error, if necessary.
For this type of error, the message displayed is actually \$HASP003 with one of the variable texts listed below.
- If the exit incurred an error (\$MODLOAD or \$MODCHK was called from an installation exit), the system action depends on the caller of the service.

Operator response: Notify the system programmer.

System programmer response: The response depends on the type of error that occurred. See the values of *reason* and *rsnc* and their explanations below:

INSUFFICIENT STORAGE FOR LOAD MODULE TABLE ENTRY, RC=01

System programmer response: Resolve the lack of storage. You may accomplish this by reducing the number of LOADMOD initialization statements or by increasing the common storage area (CSA) for the system.

MODULE COULD NOT BE LOADED, RC=02

System programmer response: Place the module in the appropriate library from which JES2 can successfully load it.

MODULE IS NOT REENTRANT, RC=03

System programmer response: Ensure that the code in the module is reentrant. Use the linkage editor to mark it reentrant for JES2 load processing.

NEW CSA/LPA LOADMODS INVALID ON HOT START, RC=04

System programmer response: If it is necessary to load new common storage modules or replace existing ones, perform a warm start of JES2.

INSUFFICIENT STORAGE TO LOAD MODULE, RC=05

System programmer response: Resolve the lack of storage by either increasing the CSA for the system or by freeing other CSA uses.

MODULE IS INVALID, RMODE MUST BE 24, RC=06

System programmer response: Regenerate the module with RMODE 24.

MODULE NAME DOES NOT MATCH ITS MIT, EXPECTED-mit_exp ACTUAL-mit_act, RC=07

System programmer response: Rename the load module to match the name in the MIT.

MODULE VERSION IS INVALID, EXPECTED-ver_exp ACTUAL-ver_act, RC=08

System programmer response: Reassemble the module at the same version level as the JES2 release currently running.

MODULE ASSEMBLED WITH INVALID MACRO LIBRARIES, EXPECTED-lib_exp ACTUAL-lib_act, RC=09

System programmer response: Reassemble the module with the correct macro library level.

MODULE IS NOT IN COMMON STORAGE, RC=10

System programmer response: Either place the module in LPA, or change your exit \$MODLOAD calls to request that the module be placed in CSA.

MODULE MIT IS INVALID, CANNOT LOCATE LMT, RC=11

MODULE MIT IS INVALID, MODULE TOO SMALL, RC=11

MODULE MIT IS INVALID, INCORRECT MITETBL ADDRESS, RC=11

MODULE MIT IS INVALID, INCORRECT EYECATCHER, EXPECTED-mit ACTUAL-mit, RC=11

System programmer response: Reassemble the module with the correct JES2 module structure, using a \$MODULE

macro to start the module (and generate the MIT), and a \$MODEND macro to end the module (and generate the MITETBL).

MODULE NOT FOUND – MODULE CANNOT BE VERIFIED, RC=12

System programmer response: Either code the ADDR= parameter for load modules when calling \$MODCHK or ensure the JES2 load module was loaded successfully by \$MODLOAD.

MODULE USER VERSION IS INVALID EXPECTED-uver_exp ACTUAL-uver_act, RC=15

System programmer response: Reassemble the module at the same version level as the JES2 release currently running.

MODULE IBM USER VERSION IS INVALID, RC=16

System programmer response: Ensure that the object deck is at the correct maintenance level. If the object deck is at the correct maintenance level and the error persists, contact your IBM support representative.

MODULE \$ENTRY ADDRESS TABLE OFFSET(S) NOT VALID, RC=17

System programmer response: Ensure that the module being loaded to common storage matches the version of JES2 code currently performing JES2 initialization.

MODULE CONTAINS DUPLICATE ADDRESS TABLE \$ENTRY, RC=18

System programmer response: Ensure that the module being loaded to common storage matches the version of JES2 code currently performing JES2 initialization.

Module: HASPCSV, HASPIRSI

Routing Code: 1,2,10

Descriptor Code: 4

\$HASP876

Explanation:

▶▶—MEMBER—*memname*—IS ACTIVE, — DELETION — IGNORED —▶▶
 | |
 | CHANGE |

JES2 detects that a member name change has been requested for member *memname*, which is currently active. The \$HASP865 message precedes this message specifying the requested action. In the message text:

memname
 The member name.

System action: JES2 issues the \$HASP441 message, asking whether to continue initialization and ignore the message, or stop.

Operator response: Notify the system programmer. When the member name is correct, restart JES2.

System programmer response: Respond to the \$HASP441 message. If you respond N, you should correct the initialization data set by assigning the correct *memname* on the MEMBER initialization statement.

Module: HASPIRDA

Routing Code: 1,2,10

Descriptor Code: 2,7

\$HASP877

Explanation:

▶▶—OWNMEMB=—*memname*—SPECIFIED ON MASDEF—IS ALREADY ACTIVE AS MEMBER(nn)—▶▶

This message informs the operator that the OWNMEMB specified during initialization matches an active member. To

\$HASP878 • \$HASP879

prevent a possible \$K03 abend of the existing member, message \$HASP441 is issued asking if initialization should continue.

In the message text:

memname

The member name.

nn The number of the currently active member.

System action: When the \$HASP441 message is issued, JES2 waits for a reply.

Operator response: If you are initializing a JES2 member with a name that is identical to the OWNMEMB of a currently active member, respond N to the \$HASP441 message. Verify, using the \$D MEMBER,NAME command on an already active system, that there are no other members active by the same name using this checkpoint. If you respond Y to \$HASP441 and there's another member active by that name, that member will be abended.

If this member is being restarted, SYNCTOL has not expired and you should respond Y to the \$HASP441 message. This will end the other JES2 member with the same name.

Module: HASPIRDA

Routing Code: 1,2,10

Descriptor Code: 2,7

\$HASP878

Explanation:

▶▶—*devname*—ATTACH FAILED— — INITIALIZATION ERROR—▶▶

JES2 has attempted to attach the subtask specified by *dtename*, but the subtask encountered an error during its initialization. The error encountered depends upon the individual subtask.

In the message text:

dtename

The name of the failed subtask.

System action: JES2 detaches the specified subtask.

Operator response: Notify the system programmer.

System programmer response: Determine why the subtask failed to initialize and whether JES2 should continue without the subtask.

Module: HASPDYN

Routing Code: 2,10

Descriptor Code: 4

\$HASP879

Explanation:

▶▶—RMT(nnn) DEVTYPE=—*unit*,—STATUS=—*status*,—*keyword=value*,...—▶▶

JES2 issues this message in response to a:

- \$D or \$T command that specified the RMT(nnnn) initialization statement.
- \$DU or \$T command that either implicitly or explicitly specified the RMT(nnnn) initialization statement.
- \$S or \$P command that specified SNA RMT(nnnn) device(s).

If this message is issued in response to a \$DU, \$S, or \$P command, only DEVTYPE= and STATUS= may be displayed. Otherwise, the message displays all the keywords on the RMT(nnnn) statement that are related to this type of remote (SNA or BSC, as defined by the DEVTYPE= keyword) and their current values. The descriptions of the BSC and SNA RMT(nnnn) statements in *z/OS JES2 Initialization and Tuning Reference* explain the keywords.

In the message text:

- nnnn** The number of the remote.
- unit** The type of remote (either SNA or BSC).
- status** The status of the device. The values for *status* are listed below.
- keyword**
The name of the keyword.
- value** The value of the keyword.

The STATUS= keyword displays the current status of the remote device. Possible values for *status* are:

- INACTIVE
- ACTIVE/LINE*nnnn*
- INACTIVE/LINE*nnnn*

System action: Processing continues.

Operator response: None.

Module:

HASCSCAN

Routing Code: #/1,2,10

Descriptor Code: -4

\$HASP880

Explanation:

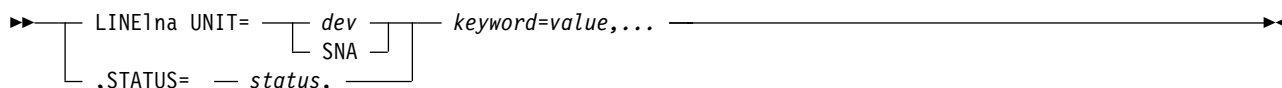

JES2 issues this message in response to a:

- \$D or \$T command that specified the LINE(*nnnn*) initialization statement.
- \$DU command that either implicitly or explicitly specified the LINE(*nnnn*) initialization statement.
- \$S, \$P, or \$E command that specified LINE(*nnnn*) devices.

If this message is issued in response to a \$DU, \$S, \$P, or \$E command, only UNIT= and STATUS= may be displayed. Otherwise, the message displays all the keywords on the LINE(*nnnn*) statement that are related to this type of line (SNA or BSC, as defined by the UNIT= parameter) and their current values. The description of the LINE(*nnnn*) statement in *z/OS JES2 Initialization and Tuning Reference* explains most of the keywords. Further information can be found under \$HASP603.

In the message text:

lna The line number.

dev | SNA

Specifies a 4-digit hexadecimal device number for a binary synchronous communication (BSC) line. For system network architecture (SNA) lines, UNIT=SNA.

status The status of the device. The values for *status* are:

- DRAINED/*rname*
- DRAINING/*rname*
- INACTIVE/*rname* or *nname*
- ACTIVE/*rname* or *nname*
- SIGNON/*nname*

\$HASP881

- **SIGNON/AWAITING-MAS**(*member-name*) *nname*
- **SIGNON/AWAITING**-*ncc* or *nname*

keyword

The name of the keyword.

value The value of the keyword. See *z/OS JES2 Initialization and Tuning Reference* for an explanation of most keywords.

This keyword might be **DISCON**={**QUIESCE** | **INTERRUPT** | **NO**} which is a 'display only' keyword. **DISCON**= displays the disconnect status for the line with possible values of:

Value Meaning

NO The line is not in the process of disconnecting

QUIESCE

When the current work on the line completes, the line will disconnect

INTERRUPT

The line is interrupting the current transmission and when complete will disconnect the line.

The **STATUS=** keyword displays the current status of the device. The possible values for *status* are listed below, where *nname* or *nname* is optionally displayed, indicating the remote name (RMTnnnn) or node name for which the line is currently in use or permanently assigned.

In the **STATUS=** text:

member-name

The name of the member of the local MAS, or list of member names, from which signon responses are required before the signon can complete.

ncc The NCC record type (J, K, or L) next expected from node *nname* to allow the signon to continue.

System action: Processing continues.

Operator response: None.

Module:

HASCSCAN

Routing Code: #/1,2,10

Descriptor Code: -4

\$HASP881

Explanation:

►►—LOGONn APPLID=—*id*,—STATUS=—*status*,—keyword=*value*,...—◄◄

JES2 issues this message in response to a:

- \$D or \$T command that specified the LOGON(n) initialization statement.
- \$DU command that either implicitly or explicitly specified the LOGON(n) initialization statement.
- \$S, \$P, or \$E command that specified LOGONn devices.

If this message is issued in response to a \$DU, \$S, \$P, or \$E command, it is possible that only APPLID= and STATUS= are displayed. Otherwise, it displays all the keywords defined on the LOGON(n) statement and their current values. The description of the LOGON(n) statement in *z/OS JES2 Initialization and Tuning Reference* explains most of the keywords. Further information can be found under \$HASP603.

In the message text:

n The number of the logon.

id The VTAM application identifier.

status The status of the device. The values for *status* are listed below.

keyword

The name of the keyword.

value The value of the keyword.

The STATUS= keyword displays the current status of the LOGONn device. The possible values for *status* are:

- DRAINED
- DRAINING
- INACTIVE
- ACTIVE

System action: Processing continues.

Operator response: None.

Module: HASCSCAN

Routing Code: #/1,2,10

Descriptor Code: -4

\$HASP882

Explanation:

▶▶—OFFLOADn DSN=—*dsname*,—STATUS=—*status*,—*keyword=value*,...—◀◀

JES2 issues this message in response to a:

- \$D or \$T command that specified the OFFLOAD(n) initialization statement.
- \$DU command that either implicitly or explicitly specified the OFFLOAD(n) initialization statement.

If this message is issued in response to a \$DU command, it is possible that only DSN= and STATUS= are displayed. Otherwise, it displays all the keywords defined on the OFFLOAD(n) statement and their current values. The description of the OFFLOAD(n) statement in *z/OS JES2 Initialization and Tuning Reference* explains each of the keywords.

In the message text:

n The number of the offload device.

dsname

The data set name.

status The status of the device. The values for *status* are listed below.

keyword

The name of the keyword.

value The value of the keyword.

The UNIT= keyword may be displayed in the message text. If a device number was specified, the device number will be displayed exactly as entered, and will be in one of the following formats:

```
UNIT=ddd
UNIT=/ddd
UNIT=/dddd
```

The STATUS= keyword displays the current status of the OFFLOADn device. The possible values for *status* are:

- DRAINED
- DRAINING
- STARTING
- INACTIVE

\$HASP883 • \$HASP884

- ACTIVE
- HALTED

System action: Processing continues.

Operator response: None.

Module: HASCSCAN

Routing Code: #/1,2,10

Descriptor Code: -4

\$HASP883

Explanation:

►►—OFFn.JR—STATUS=—*status*,—*keyword=value*,...—◄◄

JES2 issues this message in response to a:

- \$D or \$T command that specified the OFFn.JR initialization statement.
- \$DU command that either implicitly or explicitly specified the OFFn.JR initialization statement.

If this message is issued in response to a \$DU command, it is possible that only STATUS= is displayed. Otherwise, it displays all the keywords defined on the OFFn.JR statement and their current values. The description of the OFFn.JR statement in *z/OS JES2 Initialization and Tuning Reference* explains each of the keywords.

In the message text:

n The number of the offload device.

status The status of the device. The values for *status* are listed below.

keyword The name of the keyword.

value The value of the keyword.

The STATUS= keyword displays the current status of the OFFn.JR device. The possible values for *status* are:

- DRAINED
- DRAINING,*(jobid jobname)*
- STARTABLE
- STARTING
- INACTIVE
- ACTIVE,*(jobid jobname)*

System action: Processing continues.

Operator response: None.

Module: HASCSCAN

Routing Code: #/1,2,10

Descriptor Code: -4

\$HASP884

Explanation:

►►—OFFn.JT—STATUS=—*status*,—*keyword=value*,...—◄◄

JES2 issues this message in response to a:

- \$D or \$T command that specified the OFFn.JT initialization statement.

- \$DU command that either implicitly or explicitly specified the OFFn.JT initialization statement.

If this message is issued in response to a \$DU command, it is possible that only STATUS= is displayed. Otherwise, it displays all the keywords defined on the OFFn.JT statement and their current values. The description of the OFFn.JT statement in *z/OS JES2 Initialization and Tuning Reference* explains each of the keywords.

In the message text:

- n** The number of the offload device.
- status** The status of the device. The values for *status* are listed below.
- keyword**
The name of the keyword.
- value** The value of the keyword.

The STATUS= keyword displays the current status of the OFFn.JT device. The possible values for *status* are:

- DRAINED
- DRAINING,(*jobid jobname*)
- STARTABLE
- STARTING
- INACTIVE
- ACTIVE,(*jobid jobname*)

System action: Processing continues.

Operator response: None.

Module: HASCSCAN

Routing Code: #/1,2,10

Descriptor Code: -4

\$HASP885

Explanation:

▶▶—OFFn.SR—STATUS=—*status*,—*keyword=value*,...—◀◀

JES2 issues this message in response to a:

- \$D or \$T command that specified the OFFn.SR initialization statement.
- \$DU command that either implicitly or explicitly specified the OFFn.SR initialization statement.

If this message is issued in response to a \$DU command, it is possible that only STATUS= is displayed. Otherwise, it displays all the keywords defined on the OFF(n).SR statement and their current values. The description of the OFF(n).SR statement in *z/OS JES2 Initialization and Tuning Reference* explains each of the keywords.

In the message text:

- n** The number of the offload device.
- status** The status of the device. The values for *status* are listed below.
- keyword**
The name of the keyword.
- value** The value of the keyword.

The STATUS= keyword displays the current status of the OFF(n).SR device. The possible values for *status* are:

- DRAINED
- DRAINING,(*jobid jobname*)
- STARTABLE

\$HASP886

- STARTING
- INACTIVE
- ACTIVE,(*jobid jobname*)

A route code in this display can have one of the following forms:

- LOCAL
- Rnnnn
- Unnnn
- *userid*
- *nodename*
- *nodename.Rnnnn*
- *nodename.userid*
- *nodename.**
- *

If the message shows * as the route code, this device is selecting all output regardless of the route code value. If the message shows *nodename.** as the route code, this device is selecting output for the node, *nodename* regardless of the *userid*.

System action: Processing continues.

Operator response: None.

Module: HASCSCAN, HASPCOMM

Routing Code: #/1,2,10

Descriptor Code: -4

\$HASP886

Explanation:

►►—OFFn.ST—STATUS=—*status*,—*keyword=value*,...—————◄◄

JES2 issues this message in response to a:

- \$D or \$T command that specified the OFFn.ST initialization statement.
- \$DU command that either implicitly or explicitly specified the OFFn.ST initialization statement.

If this message is issued in response to a \$DU command, it is possible that only STATUS= is displayed. Otherwise, it displays all the keywords defined on the OFFn.ST statement and their current values. The description of the OFFn.ST statement in *z/OS JES2 Initialization and Tuning Reference* explains each of the keywords.

In the message text:

n The number of the offload device.

status The status of the device. The values for *status* are listed below.

keyword The name of the keyword.

value The value of the keyword.

The STATUS= keyword displays the current status of the OFFn.ST device. The possible values for *status* are:

- DRAINED
- DRAINING,(*jobid jobname*)
- STARTABLE
- STARTING
- INACTIVE

- **ACTIVE**,(*jobid jobname*)

A route code in this display can have one of the following forms:

- LOCAL
- Rnnnn
- Unnnn
- userid
- nodename
- nodename.Rnnnn
- nodename.userid
- nodename.*
- *

If the message shows * as the route code, this device is selecting all output regardless of the route code value. If the message shows nodename.* as the route code, this device is selecting output for the node, *nodename* regardless of the userid.

System action: Processing continues.

Operator response: None.

Module: HASCSCAN

Routing Code: #/1,2,10

Descriptor Code: -4

\$HASP887

Explanation:

▶▶—EXIT ROUTINE—xxxxxxx,—NOT LOCATED IN COMMON STORAGE—▶▶

The exit effector for the JES2 user environment determined that the load module containing the named exit routine xxxxxxxx was not found in common storage. Exit routines called from the JES2 USER, FSS, or SUBTASK environment must be made accessible by placing them into CSA or LPA.

System action: Exit routine xxxxxxxx will not be called and the job/task for which the exit routine was invoked will be terminated with ABEND code 0F7, REASON code x'98'.

Operator response: Notify the system programmer.

System programmer response: The STORAGE keyword on the JES2 LOADMOD initialization statement controls the required storage location of the load module. Specify one of the following JES2 initialization statements:

- LOADMOD(lmodname) STORAGE=LPA /* lmodname resides in LPA */
- LOADMOD(lmodname) STORAGE=CSA /* lmodname to reside in CSA */

An IPL must also be performed in conjunction with the correct specification of the JES2 LOADMOD initialization statement.

Module: HASCSIRQ

Routing Code: 1,2,10

Descriptor Code: 7,11

\$HASP889 • \$HASP890

\$HASP889

Explanation:

▶▶—SRVCLASS—(xxxxxxxx)—keyword=value,...—————▶▶

JES2 issues this message in response to \$ADD, \$D, \$S, \$P, or \$T SRVCLASS command. The keywords defined and their current values are displayed.

System action: Processing continues.

Operator response: None

System programmer response: None

Module: HASCSCAN

Routing Code: Routed as a command response

Descriptor Code: 4

\$HASP890

Explanation:

▶▶—JOB—(—jobname—),—STATUS=—(—status—),—CLASS=—class,—JOB CORR=—job correlator,—————▶▶

▶▶—PRIORITY=—priority,—SYSAFF=—sysaff,—HOLD=—hold,—CMDAUTH=—(auth1,auth2)—,—USERID=—userid,—————▶▶

▶▶—SPOOL=(VOLUMES=—name—),—TGS=—nnnn,—PERCENT=—(xxx.xx)d,—ARM_ELEMENT=—

YES
NO

—CARDS=—FFF,—————▶▶

▶▶—REBUILD=—

YES
NO

—INITASID=—

asid
NONE

—CRTIME=—timestamp,—SRVCLASS=—srvclass,—————▶▶

▶▶—SCHENV=—schenv,—SCHENV_AFF=—(member)—,—SECLABEL_AFF=—(member)—,————▶▶

▶▶—CC=—(—

codestr
CODE=code
RC=CODE

,ABEND=(Sxxx.Unnnn)—,CODE=code—,RC=CODE—) —DELAY=—

BUSY_ON_DEVICE
HOLD
LIMIT
LOCKED
SCHENV
SECLABEL
SPOOLS_NOT_AVAILABLE
SYSAFF
MEMBER_STATUS
QUEUE_ERROR

————▶▶

Alternate output 1:

▶▶—JOB—(—job group name—),—JOB_GROUP_STATUS=—group status,—ONERROR=—on error action,—————▶▶

▶▶—ERROR=—error expression,—JOB CORR=—job correlator,—SYSAFF=—sysaff,—HOLD=—hold,—————▶▶

▶▶—CMDAUTH=—(auth1,auth2)—,—OWNER=—userid,—SPOOL=(VOLUMES=—name—),—TGS=—nnnn,—————▶▶

▶▶—PERCENT=—(xxx.xx)d,—CARDS=—FFF,—REBUILD=—

YES
NO

—INITASID=—

asid
NONE

—CRTIME=—timestamp,—————▶▶

▶▶—SCHENV=—schenv,—SCHENV_AFF=—(member)—,—SECLABEL_AFF=—(member)—,————▶▶

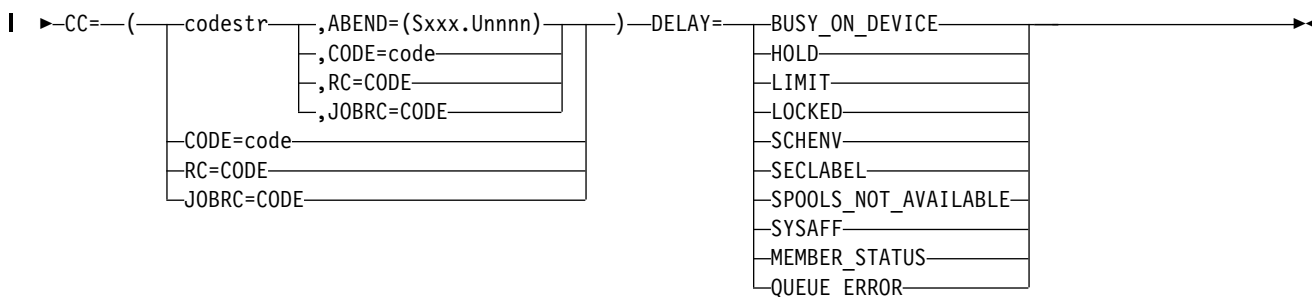

|
| Alternate output 2:

```

| JOB(CONCUR01) JOB GROUP JOB LIST
| JOB NAME      JOB ID      JOB STAT      COMP STAT
| -----
| jobname      jobid      job stat      comp stat

```

| Alternate output 3:

```

| JOB(CONCUR01) JOB GROUP JOB IN ERROR LIST
| LIST OF JOBS TO RESUBMIT
| JOB NAME      JOB ID      JOB STAT      COMP STAT
| -----
| jobname      jobid      job stat      comp stat

```

| Alternate output 4:

```

| JOB(CONCUR01) JOB GROUP DEPENDENCY LIST
| PARENT        DEP JOB      DEP STAT      COMP ACT
| -----
| parname      depname      dep stat      comp act

```

| Alternate output 5:

```

| JOB(CONCUR01) JOB GROUP CONCURRENT JOB LIST
| JOB NAME      CONC JOB
| -----
| jobname      conjob

```

| Alternate output 6:

```

| ►►JOB(—job group name—),—JOB_NAME=—jobname,—JOBID=—jobid,—JOB_STATUS=—job stat,—
| ►QUEUE=—queue,—COMP_STAT=—comp stat,—JOBSET_NAME=—jobset name,—FLUSH_ACTION=—flush action,—

```

| Alternate output 7:

```

| ►►JOB(—job group name—),—PARENT_JOB=—parname,—DEP_JOB=—depname,—DEP_STATUS=—dep stat,—
| ►COMP_ACT=—comp act,—WHEN=—when,—ENDACTION=—end action,—OTHERWISE=—otherwise action,—

```

| This message is issued in response to a \$D \$T, \$A, \$H, \$E, \$P, \$C, or \$S command. The message displays the current status of the indicated job. If the message is in response to the LONG parameter, JES2 also displays all the information following the HOLD= keyword in the message.
| In the message text:

| **jobname** The job name appearing on the job statement or in the start procedure operand.

| **status** The STATUS= keyword describes the current state of the job.

- | • AWAITING ARM RESTART – The job is waiting to be restarted by the automatic restart management. This message appears after the job ends and before the automatic restart management sends a restart request to JES2. If the automatic restart management sends a request to JES2 to restart the job, the job's status changes to AWAITING EXECUTION.

\$HASP890

- Awaiting CNVT/WAIT=YES – Similar to Awaiting Conversion, except that this job must run on a conversion processor that can wait for an MVS resource. These jobs have attempted conversion once before but failed because an MVS resource was not available (such as a PROCLIB data set that needs to be recalled from HSM or a ENQ that is not available).
- Awaiting Conversion – The job is waiting for JCL conversion.
- Awaiting Execution – The job is waiting to run.
- Awaiting Hardcopy – The job is waiting to be printed or punched.
- Awaiting Output – The job has finished running and is awaiting output processing.
- Awaiting Purge – The job is waiting to be purged.
- Awaiting Spin – A job has completed execution and is waiting for all the SPIN data sets that were created to complete the process of being spun. All SPIN data sets must have output elements built before the job can move to the next phase.
- Awaiting Xmitter – The job is on the Xmitter queue, waiting to be sent to another node for processing.
- \$ – The job is a started task.
- @ – The job is a time-sharing user.
- BERT LOCKED / member-name(/pcename) – This indicates that an update-mode copy of the job has been obtained by member “member-name”, under the specified processor (“pcename”). When issued in response to a \$C, \$E, \$H, or \$P job command, the command has been accepted but the processing of the command will be deferred until the lock becomes available.
- c – The processing class.
- CONVERTING – MVS is converting the job's JCL.
- *devname* – The JES2 name of any input or output device performing a function for the job.
- EXECUTING – The job is running.
- IN OUTPUT – The job is in OUTPUT processing.
- ON COMMAND – A command is currently modifying the JOEs for this job.
- ON JOEPURGE – A JOE for this job is currently being purged.
- ON PRSYSOUT – The external writer or an application using the external writer interface (the process SYSOUT or PSO interface) is processing output for the job.
- ON RESTART – Job is currently being ARM restarted.
- ON ROUT – Job is put through the transmission or reception process to build the job's control blocks for transmission to the final destination.
- ON SAPI – Output for this job is being processed by an application using the SAPI interface. This interface is used by both IBM and OEM products to access SYSOUT data sets on SPOOL. Applications using the SAPI interface can act as printers, archiving agents, or browsers of SYSOUT data sets.
- ON SPINNING – A JOE is being created for a sysout data set that was spun off.
- ON TSOOUTPUT – The TSO OUTPUT command or an application using the same interface as the TSO output command (the process sysout or PSO interface) is processing output for this job.
- SPINNING – The job is busy in SPIN processing.
- *UNKNOWN* – The job has a job type is not valid.
- *xnode* – The node to which the job will be sent for processing.

class The class that is assigned to the specified job.

job correlator

Displays the 64 displayable/printable character identifier that uniquely identifies this job within the JESplex. The job correlator consists of a system-assigned 31-character value, followed by a semicolon character and a 32-character user-defined value. For JES Symbol Service (IAZSYMBL) documentation on the format of the job correlator, refer to *z/OS JES Application Programming*.

priority

Priority (0-15) that is specified for the job.

sysaff Indicates where a job is eligible to run in the shared JES2 configuration.

hold The job is currently held or will be held at the end of the current phase.

- | 1. HOLD=(ALL) will appear after a \$H A,ALL command is issued. To reactivate all jobs issue a \$A A command
- | 2. HOLD=(JOB) will appear after a \$H J'jobname' is issued. To reactivate a particular job issue a \$A J'jobname' command.

| **auth1[,auth2]**

| Displays the remote(s) or node(s) that can enter commands that affect this job.

| *auth1* and *auth2* are obtained from one of the following:

- | • The default output route code associated with the input device on which the job entered the system.
- | • The remote or node specified on a /*ROUTE PRINT JES2 control statement which becomes the default print routing for the job.
- | • The remote or node specified on a /*ROUTE PUNCH JES2 control statement which becomes the default punch routing for the job.

| If JES2 determines that *auth1* and *auth2* specify the same remote, JES2 only displays *auth1*.

| *auth1* and *auth2* can have one of the following forms:

| **Rnnnn** A remote work station.

| **Unnnn** A special local device.

| **LOCAL**

| Any local device.

| *name* A destination represented by a symbolic name defined by the installation.

| **userid=**

| The userid that submitted the job.

| **SPOOL=(VOLUMES=(name))**

| The volume name consists of the SPOOL prefix followed by the unique identifying characters. Example: (SPOOL1,2,3,4...). The SPOOL prefix is specified on the SPOOLDEF initialization statement. NONE indicates that there are no spool volumes.

| **TGS=nnnnn**

| The number of track groups allocated to this job.

| JES2 displays five asterisks (****) for TGS= when the number of track groups exceeds 8,355,585.

| **PERCENT=xxx.xxx**

| The percentage of defined spool space being occupied by this job. Defined spool space is the amount of spool space known to JES2, that is, all spool space that is not drained.

| JES2 displays six asterisks (**.***) for PERCENT= when the number of track groups exceeds 8,355,585.

| **ARM ELEMENT={YES | NO}**

| Indicates whether (YES) or not (NO) the job uses the automatic restart manager services.

| **FFF** Number of input cards in the job stream.

| **INITASID={asid | NONE}**

| The system-assigned identifier for the address space, if applicable.

| **CRTIME=timestamp**

| The job creation time.

| **REBUILD={YES | NO}**

| The job is on the rebuild queue. After the current phase of processing, the job will be removed from the system.

| **SRVCLASS=svclass**

| The WLM service class associated with the job. If the service class is in the process of being reset by the \$TJOBnn,SRVCLASS= command the service class may display as *RESUME.

| **SCHENV=schenv**

| The scheduling environment.

\$HASP890

| **SCHENV_AFF**=(*member*)
| The members in the JES2 configuration on which the scheduling environment is available.

| **SECLABEL_AFF**=(**member**)
| The members in the JES2 configuration on which the security label (SECLABEL) is available. This is only
| displayed if the RACF "SECLABEL by system" option is active.

| **CC**={(*codestr*,**ABEND**=(**Sxxx.Unnnn**)), (*codestr*,**CODE**=*code*), (*codestr*,**RC**=*code*), (*codestr*,**JOBRC**=*code*), (**CODE**=*code*),
| (**JOBRC**=*code*),(**RC**=*code*)}

| The job completion code. The *codestr* can be one of the following values:

- | • COMPLETED
- | • ENDED_BY_CC
- | • JCLERROR
- | • CANCELLED
- | • ABENDED
- | • CNVT_ABEND
- | • SECURITY_FAILURE
- | • EOM_FAILURE
- | • CNVT_ERROR
- | • SYSTEM_FAILURE

| **DELAY**={*BUSY_ON_DEVICE*,*HOLD*,*LIMIT*,*LOCKED*, *SCHENV*,*SECLABEL*,*SPOOLS_NOT_AVAILABLE*,
| *SYSAFF*,*MEMBER_STATUS*, *QUEUE_ERROR*}

| Displays reasons why a pre-execution job will not enter execution.

| **BUSY_ON_DEVICE**
| The job will not execute because it is busy on a device (such as an offload job transmitter).

| **HOLD** The job will not execute because it is held, its job class is held, or another job with the same
| jobname is executing.

| **LIMIT** The job will not execute because the job class execution limit has been reached (as specified by
| JOBCLASS XEQCOUNT=(MAX=)).

| **LOCKED**
| The job will not execute because it's being updated by JES2.

| **SYSAFF**
| Each of the members for which the job has affinity (SYSAFF) is inactive, or the job has specified
| independent state, and the JES2 member is not independent (IND=NO).

| **SCHENV**
| The job's scheduling environment is not available on any member, or is available only on systems
| where JES2 is inactive. Use the \$DJ'jobname',LONG command to find out what scheduling
| environment a job requires. Then use the D WLM,SCHENV=schenv-name command to find out the
| current status of the scheduling environment on each system in the sysplex.

| The SCHENV state masks other reasons why the job might be ineligible to run, such as the \$P and
| \$P XEQ commands having been issued. Also, note that the SCHENV delay is detected only after a
| job goes through conversion. If a job is delayed before conversion because of system affinity
| requirements, scheduling environments are not considered in determining delay status.

| **MEMBER_STATUS**
| A combination of system affinity, scheduling environment restrictions, and security label
| (SECLABEL) availability are preventing the job from running, or, other member states prevent the
| job from running on systems where the job is otherwise eligible. These states include:

- | • \$P command has been issued
- | • \$P XEQ command has been issued
- | • BOSS=NO (used in a poly-JES environment only)

When used as a command filter, the string MEMBER_STATUS matches on jobs delayed for SYSAFF, SCHENV, SECLABEL, or MEMBER_STATUS. To get detail on why a job is delayed, display job status with the \$DJ'jobname',LONG command or display member status with the \$DJMEMBER(member-name) command.

SECLABEL

The security label (SECLABEL) assigned to the job is not defined as active on any member that is active.

QUEUE_ERROR

Job is in a WLM mode job class but is not currently on a WLM work queue. If the job class has just been updated to MODE=WLM, then this may be a temporary state while the jobs are being re-queued.

SPOOLS_NOT_AVAILABLE

At least one SPOOL volume that the job is using is halting or has been halted.

Yes Display only jobs which are delayed for any of the above reasons.

No Display only jobs which are not delayed for any of the above reasons.

This message is also issued in response to \$D, \$T, \$A, \$H, \$P or \$C commands issued for job groups. Refer to "Alternate output 1" above for an example. The message displays the current status of the indicated job group. If the message is in response to the LONG parameter, JES2 also displays all the information following the HOLD= keyword in the message. The message text may contain some of the fields defined for the original message output. In addition, the following may appear in the message text:

job group name

The job group name appearing on the JOBGROUP JCL statement

group status

Describes the current status of the job group. Valid values are:

PENDING

No jobs have been registered to the job group.

ACTIVE_INIT

At least one job has registered to the job group, but not all jobs have been registered.

ACTIVE

All job group jobs have registered and some jobs may be actively running.

SUSPENDING

At least one job group job has a completion status of INERROR. A subset of the remaining job group jobs will not be able to run until the job in error is resubmitted. Other jobs that can run will run.

SUSPENDED

At least one job group job has a completion status of INERROR. All jobs that could run have run.

HELD The job group is marked as HELD. No new job group jobs will be able to start running. Jobs that were running when the job group was held will continue to run. Use the \$AG command to release the job group.

FLUSHING

A non-recoverable error causes the job group to terminate. All jobs that have not executed are being cancelled. The job group status will change to COMPLETE when the last actively running job completes.

COMPLETE

All job group jobs that could run have run. All jobs that did not run have been cancelled (flushed). The job group status will change to COMPLETE when the last actively running job completes.

ZOD_NOT_FND

The job group was not activated after the JOBGROUP JCL was processed. The job group cannot run. Any errors must be corrected and the job group resubmitted.

\$HASP890

on error action

The action to take when a job group is determined to be in error. This applies when the condition defined on the ERROR= keyword for the job group is encountered, or when a dependency is considered to have failed. Valid values are:

STOP No new jobs in the job group are run. Jobs actively running are allowed to complete. Jobs determined to be in error based on the ERROR= keyword value can be resubmitting. Resubmitting all in error jobs will clear the error state and allow the job group processing to continue.

SUSPEND

New jobs that have their dependencies satisfied are allowed to run. Jobs determined to be in error based on the ERROR= keyword value are considered to have not run and can be resubmitting. Resubmitting all in error jobs will clear the error state and allow the job group processing to continue.

FLUSH All jobs that have not run will be cancelled (flushed). No new jobs will be run. When the last actively running job completes the job group status is set to COMPLETE.

This message is also issued in response to a \$DG command that uses the JOBS keyword. The message displays all jobs defined to the job group, and alternate view 2 provides an example of the output. Fields in the view are:

jobname (column 1)

The name of the job defined to the job group.

jobid (column 2)

The job ID of the job registered to the job definition associated with the job group. This field is set to NONE if a job is not registered to the job group.

job stat (column 3)

The status of the job definition within the job group processing. Valid values are:

NOT REG

The job has not registered with the job group. Either the JCL for the job has not been submitted or it contained errors.

PEND DEP

The job has dependencies that have not been satisfied so the job cannot run.

HELD The job is registered and is eligible to run, but it is held.

ACTIVE

The job is actively running.

DELAYED

The job is eligible to run but has a resource delay that keeps it from being selected. Use \$DJ,DELAY to determine the specific reasons why the job is delayed.

NOT ELIG

The job is not eligible to be selected to run, due to the error state of the job group.

Q= The job has completed running or is no longer eligible to run. It can also be a job that is part of a concurrent set that is waiting to be selected to run. Valid values indicating what queue the job is on:

HARDCPY	hardcopy queue
OUT	output queue
XMT	transmit queue
SPIN	spin processing
PURGE	purge queue
SETUP	setup queue

comp stat (column 4)

The completion status of the job definition in the job group processing. Valid values are:

PENDING

The job has unresolved or pending dependencies

ACTIVE

The job is registered and is eligible to run

COMPLETE

The job's job group processing has completed

FLUSHED

The job was cancelled (flushed) and is no longer eligible to run

INERROR

The job was marked in error and the job group is SUSPENDING or SUSPENDED. Resubmit the job to clear the error condition and allow job group processing to continue.

This message is also issued in response to a \$DG command that uses the INERROR keyword. The message displays all jobs defined to the job group that are in error, and Alternate output 3 provides an example of the output. Fields in the view are:

jobname (column 1)

The name of the job defined to the job group

jobid (column 2)

The job ID of the job registered to the job definition associated with the job group. This field is set to NONE if a job is not registered to the job group.

job stat (column 3)

The status of the job definition within the job group processing. Valid values are:

NOT REG

The job has not registered with the job group. Either the JCL for the job has not been submitted or it contained errors.

PEND DEP

The job has dependencies that have not been satisfied so the job cannot run.

HELD The job is registered and is eligible to run, but it is held.

ACTIVE

The job is actively running

DELAYED

The job is eligible to run but has a resource delay that keeps it from being selected. Use \$DJ,DELAY to determine the specific reasons why the job is delayed.

NOT ELIG

The job is not eligible to be selected to run, due to the error state of the job group.

Q= The job has completed running or is no longer eligible to run. It can also be a job that is part of a concurrent set that is waiting to be selected to run. Valid values indicating what queue the job is on:

HARDCPY	hardcopy queue
OUT	output queue
XMT	transmit queue
SPIN	spin processing
PURGE	purge queue
SETUP	setup queue

comp stat (column 4)

The completion status of the job definition in the job group processing. For this \$DG,INERROR view this column would show INERROR.

This message is also issued in response to a \$DG command that uses the DEPlist keyword. The message displays all dependencies defined to the job group, and alternate view 4 provides an example of the output. Fields in the view are:

parname (column 1)

The name of the job defined to the job group who is the parent in the dependency relationship.

depname (column 2)

The name of the job defined to the job group who is the dependent job in the dependency relationship (the child of the parent job).

\$HASP890

dep stat (column 3)

The status of the dependency within the job group processing. Valid values are:

PENDING

The evaluation of the dependency is pending. The parent job has not run and has not been flushed.

COMPLETE

The evaluation of the dependency is complete. The parent job completed running or was flushed and the completion action of the dependency has been assigned.

comp act (column 4)

The completion action of the dependency in the job group processing. Indicates the processing that will occur on the dependent job (child) when all its dependencies are complete and all dependency completion actions can be evaluated. Valid values are:

SATISFY

This dependency was satisfied by the parent job running. If this completion action alone was evaluated the dependent job would be eligible to run.

FLUSH The results of the parent job indicate the dependent job should be cancelled (flushed) and not run.

FAIL The results of the parent job indicate the dependent job should be marked as failed. The dependent job will not run. The job group is marked in error and the ONERROR setting of the job group will determine subsequent job group processing.

This message is also issued in response to a \$DG command that uses the CONjobs keyword. The message displays all job definitions in the job group that should run simultaneously as part of a concurrent set. Alternate view 5 provides an example of the output. Fields in the view are:

jobname (column 1)

The name of a job defined to the job group.

conjob (column 2)

The name of a different job defined to the job group that should run with "jobname" as part of a concurrent set.

This message is also issued in response to a \$DG command that uses the JOBFull keyword. The message displays all job definitions in the job group. Instead of listing the jobs in a tabular format like \$DG,JOBS, the \$DG,JOBFull command lists the output in keyword=value format, and provides additional keyword values beyond those displayed by \$DG,JOBS. Alternate view 6 provides an example of the output. Fields in the view are:

jobname

The name of the job defined to the job group.

jobid The job ID of the job registered to the job definition associated with the job group. This field is set to NONE if a job is not registered to the job group.

job stat

The status of the job definition within the job group processing. Valid values are:

NOT REG

The job has not registered with the job group. Either the JCL for the job has not been submitted or it contained errors.

PEND DEP

The job has dependencies that have not been satisfied so the job cannot run.

HELD The job is registered and is eligible to run, but it is held.

ACTIVE

The job is actively running.

DELAYED

The job is eligible to run but has a resource delay that keeps it from being selected. Use \$DJ,DELAY to determine the specific reasons why the job is delayed.

NOT ELIG

The job is not eligible to be selected to run, due to the error state of the job group.

| **Q=** The job has completed running or is no longer eligible to run. It can also be a job that is part of a
 | concurrent set that is waiting to be selected to run. Valid values indicating what queue the job is
 | on:
 | HARDCPY hardcopy queue
 | OUT output queue
 | XMT transmit queue
 | SPIN spin processing
 | PURGE purge queue
 | SETUP setup queue

| **queue** The job has completed running or is no longer eligible to run. It can also be a job that is part of a concurrent
 | set that is waiting to be selected to run. Valid values indicating what queue the job is on:
 | HARDCPY hardcopy queue
 | OUT output queue
 | XMT transmit queue
 | SPIN spin processing
 | PURGE purge queue
 | SETUP setup queue

| **comp stat**
 | The completion status of the job definition in the job group processing. Valid values are:
 | **PENDING**
 | The job has unresolved or pending dependencies.
 | **ACTIVE**
 | The job is registered and is eligible to run.
 | **COMPLETE**
 | The job's job group processing has completed.
 | **FLUSHED**
 | The job was cancelled (flushed) and is no longer eligible to run.
 | **INERROR**
 | The job was marked in error and the job group is SUSPENDING or SUSPENDED. Resubmit the job
 | to clear the error condition and allow job group processing to continue.

| **jobset name**
 | The name of the jobset that this job was assigned to when the job group definition entered the system.

| **flush action**
 | Indicates the condition that would cause this job to be flushed. Valid values are:
 | **ALLFLUSH**
 | If all dependencies for this job indicate a completion status of FLUSHED then this job will be
 | flushed.
 | **ANYFLUSH**
 | If any dependencies for this job indicate a completion status of FLUSHED then this job will be
 | flushed.

| This message is also issued in response to a \$DG command that uses the DEPFULL keyword. The message displays all
 | dependencies defined to the job group, and alternate view 7 provides an example of the output. Fields in the view
 | are:

| **parname**
 | The name of the job defined to the job group who is the parent in the dependency relationship.

| **depname**
 | The name of the job defined to the job group who is the dependent job in the dependency relationship (the
 | child of the parent job).

| **dep stat**
 | The status of the dependency within the job group processing. Valid values are:
 | **PENDING**
 | The evaluation of the dependency is pending. The parent job has not run and has not been flushed.

\$HASP891

COMPLETE

The evaluation of the dependency is complete. The parent job completed running or was flushed and the completion action of the dependency has been assigned.

comp act

The completion action of the dependency in the job group processing. Indicates the processing that will occur on the dependent job (child) when all its dependencies are complete and all dependency completion actions can be evaluated. Valid values are:

SATISFY

This dependency was satisfied by the parent job running. If this completion action alone was evaluated the dependent job would be eligible to run.

FLUSH The results of the parent job indicate the dependent job should be cancelled (flushed) and not run.

FAIL The results of the parent job indicate the dependent job should be marked as failed. The dependent job will not run. The job group is marked in error and the ONERROR setting of the job group will determine subsequent job group processing.

when An conditional expression like IF/THEN/ELSE in JCL that is evaluated using the parent job's return or ABEND code once this dependency is marked COMPLETE. If the evaluation is TRUE the ENDACTION is taken. If the evaluation is FALSE the OTHERWISE action is taken.

end action

Value used to set the dependency completion status if a supplied WHEN expression evaluates to TRUE. Valid values are:

SATISFY

This dependency was satisfied by the parent job running. If this completion action alone was evaluated the dependent job would be eligible to run.

FLUSH The results of the parent job indicate the dependent job should be cancelled (flushed) and not run.

FAIL The results of the parent job indicate the dependent job should be marked as failed. The dependent job will not run. The job group is marked in error and the ONERROR setting of the job group will determine subsequent job group processing.

otherwise action

Value used to set the dependency completion status if a supplied WHEN expression evaluations to FALSE. Valid values are:

SATISFY

This dependency was satisfied by the parent job running. If this completion action alone was evaluated the dependent job would be eligible to run.

FLUSH The results of the parent job indicate the dependent job should be cancelled (flushed) and not run.

FAIL The results of the parent job indicate the dependent job should be marked as failed. The dependent job will not run. The job group is marked in error and the ONERROR setting of the job group will determine subsequent job group processing.

System action: Processing Continues.

System programmer response: None.

Module: HASCSCAN

Routing Code: #

Descriptor Code: -

\$HASP891

Explanation:

►►—OUTPUT—(—*jobname*—)—JOB CORR=—*job correlator*—READY=—(—*c=nnnn*,...—)—HELD=—(—*yyyy*—)—►►

This message is issued in response to a \$L command. The message displays the count of output by class for the indicated job.

In the message text:

jobname

The job name appearing on the job statement or in the start procedure operand.

job correlator

Displays the 64 displayable/printable character identifier that uniquely identifies this job within the JESplex. The job correlator consists of a system-assigned 31-character value, followed by a semicolon character and a 32-character user-defined value. For JES Symbol Service (IAZSYMBL) documentation on the format of the job correlator, refer to *z/OS JES Application Programming*.

READY=(c=nnnn,...)

Displays the count of ready queued output in each output class. Ready queued output is output with output dispositions of WRITE or KEEP. If the job has no ready queued output, NONE is displayed.

HELD=(yyyy)

Displays the count of held queued output in each output class. Held queued output is output with output dispositions of HOLD or LEAVE. If the job has no held queued output, NONE is displayed.

System action: Processing Continues.

System programmer response: None.

Module: HASCSCAN

Routing Code: #

Descriptor Code: -

\$HASP892

Explanation:

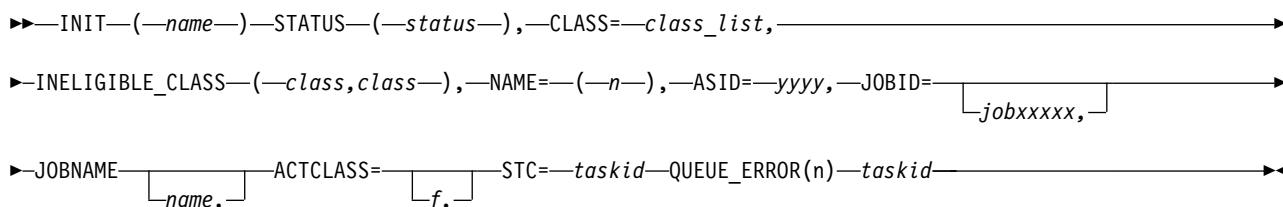

In the message text:

INIT(name)

The initiator number.

status The STATUS(*status*) describes the current state of the initiator. *status* can be one of the following:

- INACTIVE
- ACTIVE
- DRAINING
- DRAINED
- HALTING
- HALTED
- STARTING
- RESTARTING
- UNKNOWN

class_list

Identifies the job classes, in priority order, that the initiator uses to select the next job.

class,class

Displays those classes which are associated with the initiator by ineligible to select work. Classes are displayed with an indicator as to why the class is ineligible.

n The initiator name.

\$HASP893

yyyy The address space identifier (ASID) of the initiator. JES2 supplies the correct asid if this initiator is active on this member of the multi-access spool (MAS) configuration. If the initiator is active on another member of the MAS, the value of the asid will be NONE.

jobxxxxxx

The number of the job the initiator is currently processing, if the initiator is processing a batch job.

JOBNAME=name

The name of the job or transaction program currently running.

f

The class of the active job or transaction program.

taskid

The identifier of the task that started the initiator. The identifier has the form STCnnnn.

QUEUE_ERROR(*n*)

Where *n* is one of the following:

Reason Code

Meaning

- | | |
|---|--|
| 1 | JES2 cannot find the CAT |
| 2 | The JQE8RBLD flag is on (the job is on the rebuild queue) |
| 3 | The job is in a WLM job class, but the JQX1WLM flag is not on (this occurs in a mixed MAS if the job converts on a pre-z/OS V1R5 system) |
| 4 | JES2 cannot find the WSC |

System action: Processing Continues.

System programmer response: None.

Module: HASCSCAN

Routing Code: #

Descriptor Code: -

\$HASP893

Explanation:

```
▶▶—VOLUME—(—valid—)—STATUS—xxx.yyy,—COMMAND=—(—command—),—TGNUM—tgnum,—————▶
▶—TGINUSE=—tginuse,—TRKPERTGB=—trkpertgb,—PERCENT=—

|                |
|----------------|
| <i>percent</i> |
| N/A            |

,—AWAITING, —UNITDATA=—————▶
▶—EXTENT=xx,TRKRANGE=(1111,hhh),BASETRAK=bbbbbb,—RECMAX=mm,TRKPERCYL=tt—MAPTARGET=—MIGDATA=—————▶
▶—MIGRATOR—MPERCENT—PHASE—RESERVED—TARGET=—DSNAME=—————▶▶
```

The operator issued the \$D, \$M, \$P, \$S or \$T command for a spool volume.

valid The name of the spool volume.

status=*xxx,yyy*

The state the volume is currently in.

STATUS has two parts when applicable, such as: STATUS=DRAINING, AWAITING(JOBS). The *xxx* value is the first status value. The *yyy* value is one of the following second status values:

- MINI-FORMATTING (member list)
- AWAITING (MINI-FORMAT)
- AWAITING (JOBS)
- AWAITING (member list)
- AWAITING (MIGRATION)

command

The command entered by the operator for this volume.

tgnum Displays the total number of tracks groups (either in use or free) on this spool volume.

tginuse Displays the number of track groups in use on this spool volume.

trkpertgb

Displays the number of tracks in each track group on this spool volume.

percent Displays the percentage on this spool volume that is utilized.

N/A Displays when the volume is starting and no tracks are assigned to the volume. When no tracks are assigned, the average cannot be calculated

AWAITING

Lists any spool volumes whose unavailability is preventing this spool volume from draining, most likely because jobs which have space on that volume cannot purge.

UNITDATA=

Unit data (if requested) displays information about the SPOOL extent. If BASETRAK= is displayed, then relative addressing is being used to access the SPOOL volume. In the message:

xx The extent number of the volume (the 'M' in MTTR).

llll The low range for track addresses (the 'TT' in MTTR).

hhhh The high range for track addresses.

bbbbbb

The base track address. Add this value to the 'TT' in MTTR to get an absolute track address.

mm Number of records per track (upper limit of 'R' in MTTR).

tt Tracks per cylinder for this device.

MAPTARGET=Yes | No

Indicates if the volume is the target of a MAPPED spool volume. The **Yes** value indicates the volume is the target of a MAPPED volume. The **No** value indicates the volume is not the target of a MAPPED volume.

MIGDATA=(LARGEST_FREE | SPACE_USED)

On a per spool volume basis, displays the largest contiguous free space or the highest used location. The unit of measurement is tracks.

Note: To track the progress of a spool migration, JES2 stores internal structures on the target spool volume. To determine the total free space that is required on the target spool volume for the migration, the size of these internal structures (approximately four tracks) must be added to the value displayed by the MIGDATA=SPACE_USED parameter on the source volume.

MIGRATOR

Displays the name of the JES2 MAS member that is performing the migration of a MIGRATING spool volume.

MPERCENT

Displays the percentage of the migration that has completed.

PHASE

Filters the migrating volumes by the current phase:

PENDING

The spool volume has been scheduled for migration and is awaiting the start of migration.

INITIALIZING

The migration environment is initializing.

SETUP Setup for a migration is processing.

COPY The dataset on the source spool volume is being migrated to the target spool volume.

\$HASP894 • \$HASP895

CATCHUP

Tracks that were changed by runtime operations during the COPY phase are being recopied.

CANCEL

Migrator subtasks are being cleaned up due to an operator canceling an active migration or the migration process detecting an error.

BACKOUT

Updates are being backed out due to an operator canceling an active migration or the migration process detecting an error.

CLEANUP

General cleanup at the end of migration is processing.

RESERVED=Yes | No

Indicates if the spool volume is selectable and not allocatable. The **Yes** value indicates the spool volume is reserved. The **No** value indicates the spool volume is not reserved.

TARGET=*volser*

Displays a target spool volume serial number (*volser*) of 1-6 characters.

DSNAME=*data_set_name*

Displays the JES2 spool data set *data_set_name* of 1-44 characters.

System action: Processing Continues.

System programmer response: None.

Module: HASCSCAN

Routing Code: #

Descriptor Code: -

\$HASP894

Explanation:

▶▶—DISPLAY COMPLETE—◀◀

This message is displayed on completion of the display command.

System action: Processing continues.

System programmer response: None.

Module: HASCSCAN

Routing Code: 1,2,10

Descriptor Code: 4

\$HASP895

Explanation:

| ▶▶—^{z11}—CHECKPOINT MODE IS NOW ACTIVE—JES2 CHECKPOINT MODE IS CURRENTLY—^{z11}—*msgtext*—◀◀
| └─z22┘

| In the message text, *msgtext* can include the following additional messages:

- CURRENT CHECKPOINT SIZE IS *nnnn* 4K RECORDS
- CURRENT NUMBER OF BERTS IS *nnnn*
- PERCENT BERTS UTILIZED IS *nnnn* PERCENT
- TIPS PROCESSOR IS ACTIVE
- THE CURRENT CHECKPOINT:

- CONTAINS *nnnn* BERTS AND BERT UTILIZATION IS *nnnn* PERCENT.
- CONTAINS *nnnn* 4K RECORDS.
- | • z22 CHECKPOINT MODE ACTIVATION WILL:
 - | - EXPAND CHECKPOINT SIZE TO *nnnn* 4K RECORDS.
 - | - REQUIRE *nnnn* ADDITIONAL BERTS AND UTILIZATION WOULD REACH *nnnn* PERCENT.
- | • z22 ACTIVATION WILL SUCCEED IF ISSUED FROM THIS MEMBER.
- | • z22 ACTIVATION WILL FAIL IF ISSUED FROM THIS MEMBER (or \$ACTIVATE TO z11 MODE WILL FAIL IF ISSUED FROM THIS MEMBER). THE FOLLOWING ISSUES PREVENT ACTIVATION:
 - | - NOT ENOUGH FREE BERTS FOR z22 ACTIVATION. A MINIMUM OF *nnnn* ADDITIONAL BERTS ARE REQUIRED TO AVOID A CRITICAL BERT SHORTAGE.
 - | - AN EXTREME BERT SHORTAGE PREVENTS z22 CHECKPOINT ACTIVATION. JES2 IS IN A NON-STABLE STATE. RESTART JES2 AS SOON AS MORE BERTS HAVE BEEN MADE AVAILABLE.
 - | - LARGEDS SUPPORT MUST BE ACTIVATED.
 - | - CKPTn IS TOO SMALL BY *nnnn* 4K RECORDS.
 - | - CKPTn IS NOT ACCESSIBLE.
 - | - ALL MAS MEMBERS ARE NOT AT THE REQUIRED PRODUCT/SERVICE LEVEL TO SUPPORT ACTIVATION. MAS MEMBERS MUST BE AT z/OS RELEASE 22.
 - | - RC=(94)JOB/OUTPUT QUEUE ERROR DETECTED RC=&RETCDE. z22 ACTIVATION IS NOT ALLOWED. SEE DESCRIPTION OF HASP003 REASON CODE 94 FOR MORE INFORMATION.
 - | - A SPOOL IS USING NON-DEFAULT DATA SET NAME.
 - | - SPOOL MIGRATION IS IN PROGRESS OR A MAPPED VOLUME WAS FOUND

| This message displays the current checkpoint mode and information about the current checkpoint configuration. It is displayed after either an \$ACTIVATE or a \$D ACTIVATE command is issued. It is also issued after JES2 is started with the UNACTIVATE parameter on an all-member WARM or an all-member HOT start. In addition, if the current checkpoint mode is z11, this message provides the following information:

- | • Information about the future checkpoint configuration after the activation to z22 mode occurs.
- | • An indication on whether the checkpoint activation to z22 mode will succeed or not.
- | • All issues that prevent checkpoint activation to z22 mode.

See the \$D ACTIVATE command listed in *z/OS JES2 Commands* for examples of how these additional messages will appear when issued.

System action: Processing continues.

System programmer response: None.

Module: HASCSCAN

Routing Code: 1,2,10

Descriptor Code: 4

\$HASP896

Explanation:

►►—DAS VERIFICATION AND REBUILD HAS COMPLETED— FOR VOLID—== *valid*— RC—== *rsnc*—————►►

Verification of the \$DAS (the control block that represents a JES2 spool volume) structure has found an error. In the message text:

- valid* Specifies the name of the spool volume.
- rsnc* Specifies the reason code for the DAS rebuild:
(verifying volumes on work q)
- 01** DASVOLID zero

\$HASP896

- 02 DASVOLID, RCDVOLID mismatch
- 03 Volume wrongly on workq
- 04 DASFLAG error
- 05 Draining and halting volume
- 11 DAS, RECY flag1 mismatch
- 12 DAS, RECY flag2 mismatch
- 13 DAS, RECY flag3 mismatch
- 14 DAS, RECY flag4 mismatch
- 15 DAS, RECY flag5 mismatch
- 16 DAS, RECY flag6 mismatch
- 17 DAS, RECY flag7 mismatch
- 18 DAS, RECY flag8 mismatch
- 1A DAS, RECY flagA mismatch
- 21 DASALOCS, RCDALOCS mismatch
- 22 DONE mask not correct on a starting volume
- 23 DONE mask not correct on a draining/halting volume
- 24 DASERROR,DASERCDE mismatch
- 25 DASERROR,DASERCDE mismatch
- 26 DASERROR,DASERCDE mismatch
- 27 DASERROR,DASERCDE mismatch
- 28 DASERROR,DASERCDE mismatch

(verifying volumes on track q)

- 41 DASVOLID zero
- 42 DASVOLID, RCDVOLID mismatch
- 43 DAS not marked as in TGM
- 44 DASALOCS, RCDALOCS mismatch
- 45 Mapped vol, member allocated
- 46 No member allocated, not inactive
- 47 DASFLAG error
- 48 No status flags set on active volume
- 49 No status flags set on inactive volume
- 4A Draining and halting volume
- 51 DAS, RECY flag1 mismatch
- 52 DAS, RECY flag2 mismatch
- 53 DAS, RECY flag3 mismatch
- 54 DAS, RECY flag4 mismatch
- 55 DAS, RECY flag5 mismatch
- 56 DAS, RECY flag6 mismatch
- 57 DAS, RECY flag7 mismatch

- 58 DAS, RECY flag8 mismatch
- 5A DAS, RECY flagA mismatch
- 61 DASERROR,DASERCDE mismatch
- 62 DASERROR,DASERCDE mismatch
- 63 DASERROR,DASERCDE mismatch
- 64 DASERROR,DASERCDE mismatch
- 65 DASERROR,DASERCDE mismatch

(verifying volume extent data)

- 81 Recs/track mismatch
- 82 Min tcelsiz mismatch
- 83 TG size mismatch
- 84 Trk/cyl value mismatch
- 85 Trk/grp value mismatch
- 86 TGM offset mismatch
- 87 First track mismatch
- 88 Low track mismatch
- 89 High track mismatch
- 8A TG value mismatch
- 8B DASMP SZ value mismatch
- 8C Large DS TG value mismatch
- 8D Large DS DASMP SZ value mismatch
- 91 Offline volume error

System action: JES2 rebuilds the \$DAS structure to correct the error. The status of spool volumes might have changed, which could result in pending commands being lost.

In addition, the track group map for affected volumes is marked as unavailable until it can be verified by the SPOOL garbage collector, which can result in a decrease in performance due to the decrease in available SPOOL space.

Operator response: None.

System programmer response: Contact IBM.

Module: HASPIRDA

Routing Code: 1, 2, 10

Descriptor Code: 4

\$HASP897

Explanation:

▶▶—SOCKET(xxxxxxxx)—STATUS=stat/line/netserv,—keyword=value,————▶▶

This message is issued in response to \$ADD, \$T, or \$D SOCKET command. The message displays the keywords defined and their current values.

System action: Processing continues.

Operator response: None

System programmer response: None

\$HASP898 • \$HASP899

Module: HASCSCAN

Routing Code: 1, 2, 10

Descriptor Code: 4

\$HASP898

Explanation:

▶▶—NETSRV—*nnn keyword=value,...*————▶▶

This message is issued in response to \$ADD, \$T, \$S, \$E, \$P, or \$D NETSRV command. The message displays the keywords defined and their current values.

System action: Processing continues.

Operator response: None

System programmer response: None

Module: HASCSCAN

Routing Code: 1, 2, 10

Descriptor Code: 4

\$HASP899

Explanation:

\$command

ACTIVE NETWORKING DEVICES

NAME	STATUS
-----	-----
<i>devname</i>	<i>status</i>

JES2 issues this notice message in response to a \$D, \$E, \$P, \$S, or \$Z NETWORK command. In the message text:

command

The command that was issued

devname

The name of an active networking device

status The current status of the networking device

System action: The \$D, \$E, \$P, \$S, or \$Z command has completed and JES2 processing continues.

Operator response: This message is the normal response to the NETWORK command. However, there might be other messages indicating the success or failure of the NETWORK command.

System programmer response: None

Module: HASCSCAN, HASPMMSG

Routing Code: Routed as a command response

Descriptor Code: 5

Chapter 13. Nine-hundreds

\$HASP900 through \$HASP949: JES2 does not use these message IDs. They are for customer use only.

Messages in this range

JES2 supplies sample installation exits in SYS1.SAMPLIB. Some of these exits issue messages within this range. If you customize any of these exits in your installation, be aware of any such message or reassign the message IDs to not conflict with any other installation-defined messages.

Also note: JES2 messages in the range \$HASP9500 through \$HASP9999 are also available for customer use only. See Chapter 18, “Nine-thousands,” on page 511 for information on messages in that range.

Chapter 14. One-thousands

The following JES2 messages are numbered in the 1000-1999 range.

| **\$HASP1110**

| **Explanation:**

| **►►—JOBGROUP—*name*—ILLEGAL JOBGROUP CARD *reason*—►►**

| The message is displayed when JES2 detected an error on the JOBGROUP statement while parsing JCL statements.
| The problem encountered is identified by *reason*.
| In the message text:

| **JOBGROUP *name***

| The name of the affected job group.

| *reason* is one of the following:

| **Illegal jobgroup card - Multiple jobgroup/job cards detected**

| Under normal conditions, multiple job/jobgroup statements are allowed. For example, they are allowed
| from an internal reader (a SUBMIT from ISPF EDIT). However, JES2 does not permit multiple job/jobgroup
| statements in the following situations:

- An NJE job stream from VM RSCS or from another JES2 node that uses /*XMIT.
- Started jobs that use IEFJOBS support, where only one JOB card is permitted in the started member.

| **operand field does not terminate in comma or blank**

| Operand field must terminate with a comma or blank.

| **name field contains invalid characters**

| Name field contains invalid characters.

| **could not obtain a ZJC from the CPOOL**

| Could not obtain a ZJC from the cell pool. This is virtual storage capacity issue.

| **cccccccccc card not valid within JOBGROUP**

| Card denoted by cccccccccc is not valid within JOBGROUP.

| **value of USER= exceeds 8 characters**

| The specified keyword has a value longer than the maximum allowed for the keyword.

| **value of USER=parameter is not valid**

| The value provided for the specified keyword is not valid.

| **value of GROUP= exceeds 8 characters**

| The specified keyword has a value longer than the maximum allowed for the keyword.

| **value of GROUP= parameter is not valid**

| The value provided for the specified keyword is not valid.

| **value of PASSWORD= has too many operands**

| Value of PASSWORD has too many operands.

| **value of TYPE= must be SCAN**

| The value provided for the specified keyword must be SCAN.

| **value of HOLD= must be NO or YES**

| The value provided for the specified keyword must be NO or YES.

| **value of ONERROR must be STOP, SUSPEND, or FLUSH**

| The value provided for the specified keyword must be STOP, SUSPEND, or FLUSH.

\$HASP1110

- | **value of SYSAFF= parameter is not valid**
| The value provided for the specified keyword is not valid.
- | **SYSTEM and SYSAFF cannot both be specified**
| SYSTEM= and SYSAFF= are mutually exclusive keywords.
- | **SYSTEM specified more than once**
| SYSTEM has been specified more than once.
- | **value of SYSTEM= parameter is not valid**
| The value provided for the specified keyword is not valid.
- | **SYSTEM= names JGLOBAL and JLOCAL are ignored**
| JGLOBAL and JLOCAL are used in a JES3 environment. They are tolerated in a JES2 environment but provide no function. This situation results in one of the following:
 - The message ID and the reason text are the only text written.
 - The message appears only in the JESYSMSG data set.
 - The condition is treated as a warning, not an error.
- | **SYSTEM of -ANY not valid**
| It is not valid to remove all members from SYSAFF by using "-ANY".
- | **SYSTEM invalid begins with "-" on second or later value**
| "-" is allowed only before the first system name.
- | **value of SECLABEL= exceeds 8 characters**
| The specified keyword has a value longer than the maximum allowed for the keyword.
- | **value of SCHENV= is too long**
| The specified keyword has a value longer than the maximum allowed for the keyword.
- | **SCHENV already set**
| SCHENV has been specified more than once.
- | **SCHENV parameter is missing**
| The SCHENV parameter was specified without a value. A value must be provided if the keyword is provided.
- | **duplicate keyword - ccccccc**
| Duplicate keyword – ccccccc not allowed on JOBGROUP card.
- | **unknown keyword**
| Unknown keyword – unknown keyword found on JOBGROUP card.
- | **ERROR= operator not valid**
| An invalid operator specified for ERROR=. Valid operators are ~, !, NOT, >, GT, <, LT, ~>, !>, NG, ~<, !<, NL, =, EQ, ~=, !=, NE, >=, GE, <=, LE, &, AND, | and OR.
- | **ERROR= dependency ccccccc and dddddddd not found**
| CCCCCCCC and dddddddd are job names which denote a dependency in error.
- | **ERROR= dependency ccccccc and dddddddd invalid**
| CCCCCCCC and dddddddd are job names which denote a dependency in error.
- | **ERROR= invalid character**
| Invalid character found.
- | **ERROR= has exceeded its limit**
| RPN (Reverse Polish Notation) list is full. The ERROR= parameter has exceeded its limit. Reduce the parameter size and resubmit the JOBGROUP.
- | **ERROR= is too complex**
| Internal operator stack is full. The ERROR= parameter is too complex. Reduce the complexity and resubmit the JOBGROUP.
- | **ERROR= only (or blank allowed before NOT**
| only (or blank allowed before NOT.

- | **ERROR= operator not within valid context**
| Operator not used within a valid context. Check operator use in relation to RUN, RC, ABENDCC, or
| ABEND.
- | **ERROR= character before/after operator is not valid**
| Invalid character preceding or following a textual operator. Valid textual operators are NOT, GT, LT, NG,
| NL, EQ, NE, GE, and LE. All these operators must be preceded with a blank or "'". The character following
| the operator must be a blank or "'".
- | **ERROR= ABEND/RUN only supports logical operators**
| ABEND and RUN only support logical operators AND(&) or OR(|).
- | **ERROR= must start with (**
| ERROR= must start with '('.
- | **ERROR= ABENDCC, ABEND, RC, or RUN within invalid context**
| ABENDCC, ABEND, RC, or RUN is not contained within a valid context.
- | **ERROR= ABENDCC code contains too many digits**
| ABENDCC code contains too many digits.
- | **ERROR= expression ended unexpectedly**
| Statement is incomplete.
- | **ERROR= misplaced AND or OR**
| Misplaced logical operator.
- | **ERROR= ABENDCC operand within invalid context**
| Context surrounding ABENDCC is invalid.
- | **ERROR= operator is missing**
| Missing operator.
- | **ERROR= ABENDCC code must start with U or S**
| ABENDCC code must start with U (user) or S (system) abend code.
- | **ERROR= last 3 chars of ABENDCC sys code must be HEX**
| Last three characters of ABENDCC system code must be hexadecimal.
- | **ERROR= last 4 chars of ABENDCC user code must be DEC**
| Last four characters of ABENDCC user code must be decimal.
- | **ERROR= mismatched parenthesis**
| Unequal number of left and right parenthesis.
- | **ERROR= mismatched left parenthesis**
| Misplaced left parenthesis.
- | **ERROR= RC, ABEND, ABENDCC, or RUN required**
| At least one -- RC, ABEND, ABENDCC, or RUN is required.
- | **ERROR= RC integer cannot be greater than 4095**
| RC value must fall within the 0-4095 range.
- | **ERROR= user abend code cannot be larger than 4095**
| ABENDCC user code cannot be larger than 4095.
- | **ERROR= only 4 digits allowed for RC value**
| Only 4 digits allowed for RC integer.
- | **ERROR= ABENDCC missing equal operator**
| ABENDCC requires (EQ or =) operator. ABENDCC only supports the equal operator.
- | **ERROR= expression is empty**
| Empty expression is not allowed.
- | **ERROR= ABEND does not support integer**
| ABEND does not support integer.
- | **ERROR= ABENDCC or RC is incomplete**
| ABENDCC or RC is incomplete.

\$HASP1111

- | **ERROR= AND or OR must be not preceded by "("**
| Logical operators AND, &, or OR, |, must not be preceded by "(".
 - | **ERROR= AND or OR must not be followed by ")"**
| Logical operators AND, &, or OR, |, must not be followed by ")".
 - | **ERROR= RUN does not support integer**
| RUN does not support integer.
 - | **System action:** The message is written to the JESYSMSG data set. The job group is queued for output processing.
 - | **Operator response:** None.
 - | **Programmer response:** See *z/OS MVS JCL Reference* for information about coding JOBGROUP statements. Correct the JOBGROUP statement and resubmit the job group.
 - | **Module:** HASCSRIP
 - | **Routing Code:** N/A
 - | **Descriptor Code:** N/A
-

\$HASP1111

Explanation:

| ►►—JOBGROUP—*name*—ENDGROUP CARD *reason*—————►►

- | The message is displayed when JES2 detected an error on the ENDDGROUP statement while parsing JCL statements.
- | The problem encountered is identified by *reason*.
- | In the message text:

JOBGROUP *name*

- | The name of the affected job group.

| *reason* is one of the following:

Maximum jobs for the job group exceeded

- | The supplied job group defines more jobs (GJOB and SJOB statements) than the maximum number of jobs allowed to be defined to a job group, as defined by the JOBGROUP_JOB_MAX parameter on the GRPDEF command. Use the JES2 command \$D GRPDEF for the defined maximum value.

At least one concurrent set exceeds the defined maximum.

- | The supplied job group defines a concurrent set containing more jobs than are allowed in a single concurrent set, as defined by the CONCURRENT_MAX parameter on the GRPDEF command. Use the JES2 command \$D GRPDEF for the defined maximum value.

operand field does not terminate in comma or blank

- | Operand field must terminate with a comma or blank.

JOBGROUP is valid but has not been activated.

- | TYPE=SCAN was specified on the job card. The job group is valid but has not been activated.

JOBGROUP has been activated

- | Job group has been activated and is ready to accept jobs.

JOBGROUP ccccccc contains errors

- | Job group ccccccc contains errors.

empty JOBGROUP is not allowed

- | Job group contains no job specifications.

ccccccc not allowed with JOBSET context

- | ccccccc denotes job group name.

JOBGROUP capacity has been exceeded

- | Maximum number of active job groups has been reached. Purge job groups which may no longer be needed.

- | **JOBGROUP already active**
- | Job group with the same name already active.
- | **JOBGROUP activation requires Z22 checkpoint level**
- | \$ACTIVATE Z22 mode required to use job groups.
- | **duplicate dependency between ccccccc and dddddddd**
- | One or more duplicate dependencies have been found. The ccccccc and dddddddd identify the jobs which
- | comprise a duplicate dependency. Look for matching pair and resolve the issue.
- | **unresolved dependency between ccccccc and dddddddd**
- | One or more unresolved dependencies have been found. The ccccccc and dddddddd identify the jobs
- | which comprise the unresolved dependency. Usually this is due to a missing GJOB or JOBSET.
- | **circular dependency between ccccccc and dddddddd**
- | One or more circular dependencies have been found. The ccccccc and dddddddd identify the jobs which
- | are part of the circular dependency. Resolve the dependency and resubmit the job group.
- | **ENDGROUP name missing**
- | ENDCARD statement is missing job group name.
- | **ccccccc name does not match JOBGROUP**
- | ENDCARD card name ccccccc does not match job group name. The name used on associated
- | JOBGROUP/ENDCARD statements must match.
- | **ccccccc not within valid JOBGROUP context**
- | ENDCARD card ccccccc is being used outside of a valid job group context.
- | **ccccccc incorrectly used within JOBSET context**
- | ENDCARD card is incorrectly coded within job set context.
- | **JQESERV - JQA passed not found**
- | Internal problem encountered when checkpointing job group. Report to IBM service.
- | **JQESERV - Severe error encountered**
- | Internal problem encountered when checkpointing job group. Report to IBM service.
- | **JQESERV - Checkpoint queues not owned**
- | Internal problem encountered when checkpointing job group. Report to IBM service.
- | **unknown keyword**
- | unknown keyword found on JOBSET card.
- | **System action:** The message is written to the JESYSMSG data set. The job group is queued for output processing.
- | **Operator response:** None.
- | **Programmer response:** See *z/OS MVS JCL Reference* for information about coding ENDCARD statements. Correct
- | the ENDCARD statement and resubmit the job group.
- | **Module:** HASCSRIP
- | **Routing Code:** N/A
- | **Descriptor Code:** N/A

\$HASP1112

Explanation:

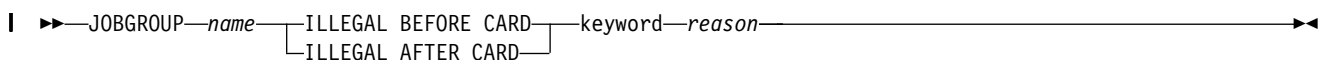

The message is displayed when JES2 detected an error on the BEFORE or AFTER statement while parsing JCL statements. The problem encountered is identified by keyword and *reason*.
 In the message text:

JOBGROUP *name*
 The name of the affected job group.

\$HASP1112

- | keyword and *reason* are one of the following:
- | **operand field does not terminate in comma or blank**
 - | Operand field must terminate with a comma or blank.
- | **NAME= is required for BEFORE and AFTER**
 - | Name keyword is required for both BEFORE and AFTER statements.
- | **NAME= requires at least one parameter**
 - | At least one job must be specified.
- | **NAME= parameter must not be blank**
 - | NAME= parameter must not be blank.
- | **NAME= supports up to 10 names**
 - | More than 10 names have been specified.
- | **NAME= duplicate dependency between ccccccc dddddddd**
 - | Specified name created a duplicate dependency. The ccccccc and dddddddd identify the jobs which comprise the duplicate dependency.
- | **NAME= circular dependency between ccccccc dddddddd**
 - | Specified name created a circular dependency. The ccccccc and dddddddd identify the jobs which comprise a circular dependency.
- | **previous card must be GJOB or JOBSET**
 - | BEFORE and AFTER statements must follow a GJOB or a JOBSET statement. Multiple BEFORE and AFTER statements may be grouped together.
- | **previous GJOB or JOBSET statement was invalid**
 - | Previous GJOB or JOBSET statement was invalid.
- | **not within a valid JOBGROUP context**
 - | BEFORE or AFTER statement not used within valid job group context.
- | **must immediately follow JOBSET**
 - | BEFORE or AFTER statement must immediately follow JOBSET statement. No intervening SJOB statements are allowed.
- | **could not obtain ZOD work area**
 - | During processing JES2 could not obtain work area. This is due to insufficient 64 bit storage.
- | **could not obtain a ZDB from the CPOOL**
 - | During processing JES2 could not obtain a ZDB from CPOOL. This is due to insufficient 64 bit storage.
- | **WHEN= operator not valid**
 - | An invalid operator specified for WHEN=. Valid operators are \neg , !, NOT, >, GT, <, LT, \neg >, !>, NG, \neg <, !<, NL, =, EQ, \neg =, !=, NE, >=, GE, <=, LE, &, AND, | and OR.
- | **WHEN= dependency ccccccc and dddddddd not found**
 - | CCCCCCCC and dddddddd are job names which denote a dependency.
- | **WHEN= dependency ccccccc and dddddddd invalid**
 - | CCCCCCCC and dddddddd are job names which denote a dependency.
- | **WHEN= invalid character**
 - | Invalid character found.
- | **WHEN= has exceeded its limit**
 - | RPN (Reverse Polish Notation) list is full. The WHEN= parameter has exceeded its limit. Reduce the parameter size and resubmit the job group.
- | **WHEN= is too complex**
 - | Internal operator stack is full. The WHEN= parameter is too complex. Reduce the complexity and resubmit the job group.
- | **WHEN= only (or blank allowed before NOT**
 - | Only (or blank allowed before NOT.

- | **WHEN= operator not within valid context**
| Operator not used within a valid context. Check operator use in relation to RUN, RC, ABENDCC, or
| ABEND.
- | **WHEN= character before/after operator is not valid**
| Invalid character preceding or following a textual operator. Valid textual operators are NOT, GT, LT, NG,
| NL, EQ, NE, GE, and LE. All these operators must be preceded with a blank or (. The character after the
| operator must be a blank or (.
- | **WHEN= ABEND/RUN only supports logical operators**
| ABEND and RUN only support logical operators AND(&) or OR(|).
- | **WHEN= must start with (**
| WHEN= must start with '('.
- | **WHEN= ABENDCC, ABEND, RC, or RUN within invalid context**
| ABENDCC, ABEND, RC, or RUN is not contained within a valid context.
- | **WHEN= ABENDCC code contains too many digits**
| ABENDCC code contains too many digits.
- | **WHEN= expression ended unexpectedly**
| Statement is incomplete.
- | **WHEN= misplaced AND or OR**
| Misplaced logical operator.
- | **WHEN= ABENDCC operand within invalid context**
| Context surrounding ABENDCC is invalid.
- | **WHEN= operator is missing**
| Missing operator.
- | **WHEN= ABENDCC code must start with U or S**
| ABENDCC code must start with U (user) or S (system) abend code.
- | **WHEN= last 3 chars of ABENDCC sys code must be HEX**
| Last three characters of ABENDCC system code must be hexadecimal.
- | **WHEN= last 4 chars of ABENDCC user code must be DEC**
| Last four characters of ABENDCC user code must be decimal.
- | **WHEN= mismatched parenthesis**
| Unequal number of left and right parenthesis.
- | **WHEN= mismatched left parenthesis**
| Misplaced left parenthesis.
- | **WHEN= RC, ABEND, ABENDCC, or RUN required**
| At least one -- RC, ABEND, ABENDCC, or RUN is required.
- | **WHEN= RC integer cannot be greater than 4095**
| RC value must fall within the 0-4095 range.
- | **WHEN= user abend code cannot be larger than 4095**
| ABENDCC user code cannot be larger than 4095.
- | **WHEN= only 4 digits allowed for RC value**
| Only 4 digits allowed for RC integer.
- | **WHEN= ABENDCC missing equal operator**
| ABENDCC requires (EQ or =) operator. ABENDCC only supports the equal operator.
- | **WHEN= expression is empty**
| Empty expression is not allowed.
- | **WHEN= ABEND does not support integer**
| ABEND does not support integer.
- | **WHEN= ABENDCC or RC is incomplete**
| ABENDCC or RC in incomplete.

\$HASP1114

- | **WHEN= AND or OR must be not preceded by "("**
| Logical operators AND, &, or OR, |, must not be preceded by "(".
- | **WHEN= AND or OR must not be followed by ")"**
| Logical operators AND, &, or OR, |, must not be followed by ")".
- | **WHEN= RUN does not support integer**
| RUN does not support integer.
- | **ACTION= must be SATISFY, FLUSH, or FAIL**
| Only valid parameters for ACTION= are SATISFY, FLUSH, or FAIL.
- | **ACTION= dependency between ccccccc dddddddd not found**
| Dependency specified by jobs ccccccc and dddddddd is not found.
- | **ACTION= dependency between ccccccc dddddddd is not valid**
| Dependency specified by jobs ccccccc and dddddddd is not valid.
- | **OTHERWISE= dependency between ccccccc dddddddd is not valid**
| Dependency specified by jobs ccccccc and dddddddd is not valid.
- | **OTHERWISE= must be FLUSH, FAIL or SATISFY**
| OTHERWISE= must be FLUSH, FAIL or SATISFY.
- | **OTHERWISE= dependency ccccccc dddddddd not found**
| Dependency specified by jobs ccccccc and dddddddd is not found.
- | **duplicate keyword - ccccccc**
| Duplicate keyword – ccccccc not allowed on BEFORE or AFTER card.
- | **unknown keyword**
| Unknown keyword found on BEFORE or AFTER card.
- | **statement label is too long**
| The supplied label on the BEFORE or AFTER statement is too long.
- | **System action:** The message is written to the JESYSMSG data set. The job group is queued for output processing.
- | **Operator response:** None.
- | **Programmer response:** See *z/OS MVS JCL Reference* for information about coding BEFORE and AFTER statements.
| Correct the BEFORE or AFTER statement and resubmit the job group.
- | **Module:** HASCSRIP
- | **Routing Code:** N/A
- | **Descriptor Code:** N/A

\$HASP1114

Explanation:

- | **▶▶—JOBGROUP—*name*—ILLEGAL CONCURRENT CARD *reason*—▶▶**
- |
- | The message is displayed when JES2 detected an error on the CONCURRENT statement while parsing JCL statements. The problem encountered is identified by *reason*.
- | In the message text:
- | **JOBGROUP *name***
| The name of the affected job group.
- | *reason* is one of the following:
- | **operand field does not terminate in comma or blank**
| Operand field must terminate with a comma or blank.
- | **NAME= is a required parameter**
| NAME= is a required parameter on CONCURRENT statement.

| **NAME= requires at least one job**
 | At least one job name required.

| **NAME= supports up to 10 jobs**
 | Maximum of ten jobs may be specified.

| **NAME= duplicate dependency between ccccccc dddddddd**
 | Dependency specified by jobs ccccccc and dddddddd is a duplicate.

| **NAME= circular dependency between ccccccc dddddddd found**
 | Dependency specified by jobs ccccccc and dddddddd is circular.

| **previous card must be GJOB**
 | Card previous to CONCURRENT must be GJOB.

| **previous GJOB card was invalid**
 | Card previous to CONCURRENT was GJOB but was not valid.

| **could not obtain a ZDB from the CPOOL**
 | During processing JES2 could not obtain a ZDB from CPOOL. This is due to insufficient 64 bit storage.

| **could not obtain ZOD work area**
 | During processing JES2 could not obtain work area. This is due to insufficient 64 bit storage.

| **NAME= parameter must not be blanks**
 | NAME= parameter must not be blanks.

| **duplicate keyword - ccccccc**
 | Duplicate keyword – ccccccc not allowed on CONCURRENT card.

| **unknown keyword**
 | Unknown keyword found on CONCURRENT statement.

| **statement label is too long**
 | The supplied label on the CONCURRENT statement is too long.

| **System action:** The message is written to the JESYSMSG data set. The job group is queued for output processing.

| **Operator response:** None.

| **Programmer response:** See *z/OS MVS JCL Reference* for information about coding CONCURRENT statements.
 | Correct the CONCURRENT statement and resubmit the job group.

| **Module:** HASCSRIP

| **Routing Code:** N/A

| **Descriptor Code:** N/A

| \$HASP1115

| **Explanation:**

| ►►—JOBGROUP—*name*—ILLEGAL SJOB CARD *reason*—————▶▶

| The message is displayed when JES2 detected an error on the SJOB statement while parsing JCL statements. The problem encountered is identified by *reason*.
 | In the message text:

| **JOBGROUP** *name*
 | The name of the affected job group.

| *reason* is one of the following:

| **operand field does not terminate in comma or blank**
 | Operand field must terminate with a comma or blank.

| **job name missing**
 | SJOB missing job name.

\$HASP1116

- | **ccccccc card not within JOBGROUP context**
- | SJOB with name ccccccc is defined outside of a valid job group context.
- | **ccccccc not within a valid JOBSET context**
- | SJOB with name ccccccc is defined outside of a valid job set context.
- | **duplicate ccccccc job name found**
- | SJOB denoted by ccccccc defines a duplicate job.
- | **ccccccc - JOBSET not found**
- | JOBSET denoted by ccccccc not found.
- | **SJOB ccccccc name is not valid**
- | Name ccccccc on SJOB statement is not valid. The name must follow conventional job name rules.
- | **ccccccc associated JOBSET is not valid**
- | Job set denoted by ccccccc is not valid.
- | **could not obtain a ZJI from the CPOOL**
- | Could not obtain a ZJI from the CPOOL. This is due to insufficient 64 bit storage.
- | **ccccccc job not found when applying ALLFLUSH**
- | Job denoted by ccccccc is not found when applying ALLFLUSH.
- | **duplicate keyword - ccccccc**
- | Duplicate keyword – ccccccc not allowed on SJOB card.
- | **unknown keyword**
- | Unknown keyword found on SJOB card.
- | **System action:** The message is written to the JESYSMSG data set. The job group is queued for output processing.
- | **Operator response:** None.
- | **Programmer response:** See *z/OS MVS JCL Reference* for information about coding SJOB statements. Correct the SJOB statement and resubmit the job group.
- | **Module:** HASCSRIP
- | **Routing Code:** N/A
- | **Descriptor Code:** N/A

\$HASP1116

- | **Explanation:**
- | **►►—JOBGROUP—*name*—ILLEGAL GJOB CARD *reason*—◄◄**
- |
- | The message is displayed when JES2 detected an error on the GJOB statement while parsing JCL statements. The problem encountered is identified by *reason*.
- | In the message text:
- | **JOBGROUP *name***
- | The name of the affected job group.
- |
- | *reason* is one of the following:
- | **operand field does not terminate in comma or blank**
- | Operand field must terminate with a comma or blank.
- | **duplicate job ccccccc found**
- | Duplicate job ccccccc has already been defined by GJOB or SJOB.
- | **job name is missing**
- | GJOB statement is missing job name.
- | **GJOB ccccccc not within JOBGROUP context**
- | GJOB statement with name ccccccc not within valid job group context.

- | **GJOB ccccccc not valid within JOBSET context**
- | GJOB statement is not valid within job set context.
- | **GJOB ccccccc name is not valid**
- | Job name on GJOB statement must follow conventional job name rules.
- | **duplicate dependency between ccccccc dddddddd**
- | Duplicate dependency between jobs ccccccc and dddddddd found.
- | **could not obtain a ZJI from the CPOOL**
- | Could not obtain a ZJI from the CPOOL. This is due to insufficient 64 bit storage.
- | **could not obtain a ZDB from the CPOOL**
- | Could not obtain a ZDB from the CPOOL. This is due to insufficient 64 bit storage.
- | **circular dependency between ccccccc dddddddd found**
- | Circular dependency found between jobs ccccccc and dddddddd.
- | **FLUSHTYP= keyword parameter missing**
- | Value missing for FLUSHTYP= keyword.
- | **FLUSHTYP must be ANYFLUSH or ALLFLUSH**
- | FLUSHTYP parameter value must be ANYFLUSH or ALLFLUSH.
- | **corresponding job not found setting ANYFLUSH**
- | Job not found when setting ANYFLUSH.
- | **duplicate keyword - ccccccc**
- | duplicate keyword – ccccccc not allowed on GJOB card.
- | **unknown keyword**
- | Unknown keyword found on GJOB statement.
- | **System action:** The message is written to the JESYSMSG data set. The job group is queued for output processing.
- | **Operator response:** None.
- | **Programmer response:** See *z/OS MVS JCL Reference* for information about coding GJOB statements. Correct the GJOB statement and resubmit the job group.
- | **Module:** HASCSRIP
- | **Routing Code:** N/A
- | **Descriptor Code:** N/A

| \$HASP1117

| **Explanation:**

| ►►—JOBGROUP—*name*—ILLEGAL JOBSET CARD *reason*—————►►

| The message is displayed when JES2 detected an error on the JOBSET statement while parsing JCL statements. The problem encountered is identified by *reason*.
 | In the message text:

| **JOBGROUP** *name*
 | The name of the affected job group.

| *reason* is one of the following:

| **operand field does not terminate in comma or blank**
 | Operand field must terminate with a comma or blank.

| **JOBSET nesting is not allowed**
 | Job sets cannot be nested.

| **duplicate job ccccccc found**
 | Duplicate job ccccccc found. Look for matching GJOB, SJOB, or JOBSET name.

\$HASP1118

- | **ccccccc not within a valid JOBGROUP context**
| JOBSET statement was used outside of a valid job group context.
 - | **missing JOBSET name**
| Name missing on JOBSET statement.
 - | **could not obtain ZOD work area**
| During processing JES2 could not obtain work area. This is due to insufficient 64 bit storage.
 - | **JOBSET limit has been exceeded**
| JOBSET limit has been exceeded.
 - | **FLUSHTYP= keyword parameter missing**
| Value is missing for FLUSHTYP= parameter.
 - | **FLUSHTYP must be ANYFLUSH or ALLFLUSH**
| FLUSHTYP parameter value must be ANYFLUSH or ALLFLUSH.
 - | **corresponding job not found setting ANYFLUSH**
| Job not found when setting ANYFLUSH.
 - | **duplicate keyword - ccccccc**
| duplicate keyword – ccccccc not allowed on JOBSET card.
 - | **unknown keyword**
| Unknown keyword found on JOBSET card.
 - | **System action:** The message is written to the JESYSMSG data set. The job group is queued for output processing.
 - | **Operator response:** None
 - | **Programmer response:** See *z/OS MVS JCL Reference* for information about coding JOBSET statements. Correct the JOBSET statement and resubmit the job group.
 - | **Module:** HASCSRIP
 - | **Routing Code:** N/A
 - | **Descriptor Code:** N/A
-

\$HASP1118

Explanation:

- | **▶▶—JOBGROUP—*name*—ILLEGAL ENDSET CARD *reason*—◀◀**
- |
- | The message is displayed when JES2 detected an error on the ENDSET statement while parsing JCL statements. The problem encountered is identified by *reason*.
- | In the message text:
- | **JOBGROUP *name***
| The name of the affected job group.
- | *reason* is one of the following:
- | **operand field does not terminate in comma or blank**
| Operand field must terminate with a comma or blank.
- | **ccccccc not within valid JOBGROUP context**
| ENDSET statement used outside of a valid job group context.
- | **ccccccc not within valid JOBSET context**
| ENDSET statement used outside of a valid job set context.
- | **ccccccc and JOBSET label mismatch**
| ENDSET denoted by ccccccc does not match JOBSET label.
- | **missing name**
| Name is missing on ENDSET statement.

| **circular dependency between cccccc ddddddd**
 | Circular dependency found between jobs cccccc and ddddddd.

| **duplicate dependency between cccccc ddddddd**
 | Duplicate dependency found between jobs cccccc and ddddddd.

| **JOBSET was not found**
 | Job set was not found.

| **could not obtain a ZJB from the CPOOL**
 | Could not obtain a ZJB from the CPOOL. This is due to insufficient 64 bit storage.

| **unknown keyword**
 | Unknown keyword found on ENDSET statement.

| **System action:** The message is written to the JESYSMSG data set. The job group is queued for output processing.

| **Operator response:** None.

| **Programmer response:** See *z/OS MVS JCL Reference* for information about coding ENDSET statements. Correct the ENDSET statement and resubmit the job group.

| **Module:** HASCSRIP

| **Routing Code:** N/A

| **Descriptor Code:** N/A

| **\$HASP1130**

| **Explanation:**

| ►►—JECL card—cccccccccc—encountered—►►

| The input processing encountered a JECL statement in the JCL stream of a job, for which the statement level option on the JECLDEF initialization statement/command is WARN or FAIL.

| **System action:** The message is written to the JESYSMSG data set when the job is converted. The job is queued for output processing after conversion, unless the message is a warning only.

| **Operator response:** None.

| **Programmer response:** None.

| **Module:** HASCSRIP, HASCINJR

| **Routing Code:** N/A

| **Descriptor Code:** N/A

| **\$HASP1131**

| **Explanation:**

| ►►—JECL card—cccccccccc—ignored—►►

| The input processing encountered a JECL statement in the JCL stream of a job, for which the statement level option on the JECLDEF initialization statement/command is WARN, but that is not supported in the current release of JES2. This message is issued instead of message HASP1130 to indicate that JES2 detected this JECL statement but will not process it.

| **System action:** The message is written to the JESYSMSG data set when the job is converted. Processing of the job continues.

| **Operator response:** None.

| **Programmer response:** None.

| **Module:** HASCSRIP

\$HASP1132 • \$HASP1201

| **Routing Code:** N/A

| **Descriptor Code:** N/A

\$HASP1132

| **Explanation:**

| ►►—Obsolete keyword—*kkkkkkkk*—ignored—►►

| This message is issued when processing a JES3 JECL statement for which the statement level option on the JECLDEF initialization statement/command is set to PROCESS. It indicates that a keyword *kkkkkkkk* was encountered, but the keyword is considered obsolete. JES2 will ignore this keyword.

| **System action:** The message is written to the console and to the JESYSMSG data set when the job is converted. The keyword is ignored and processing of the job continues.

| **Operator response:** None.

| **Programmer response:** Use a modern replacement for the function of this keyword – usually a corresponding JCL function. See *z/OS MVS JCL Reference* for the suitable JCL function.

| **Module:** HASCSRIP

| **Routing Code:** N/A

| **Descriptor Code:** N/A

\$HASP1133

| **Explanation:**

| ►►—Unsupported keyword—*kkkkkkkk*—used—►►

| This message is issued when JES3 JECL statement is encountered for which the statement level option on the JECLDEF initialization statement/command is set to PROCESS and this keyword is either not supported by the current level of the JES2 or for which there is no equivalent JES2 function.

| **System action:** The message is written to the JESYSMSG data set when the job is converted. The keyword is ignored and processing of the job continues.

| **Operator response:** None.

| **Programmer response:** Use a JCL function equivalent to the function of this keyword. See *z/OS MVS JCL Reference* for the suitable JCL function. If this JES3 function is not supported by JES2, submit request to IBM to consider adding support in a future.

| **Module:** HASCSRIP

| **Routing Code:** N/A

| **Descriptor Code:** N/A

\$HASP1201

| **Explanation:**

| ►►—Concurrent set containing job—*jobname*—in job group—*groupname*—is entering execution.—►►

| This form of \$HASP1201 message is issued when all jobs in a concurrent set pass all checks to be eligible for execution and JES2 starts the process of starting all jobs in the concurrent set.

| OR

| ►►—Concurrent set containing job—*jobname*—in job group—*groupname*—►►

|
| ▶—is delayed due to delay— *reason*—————▶

|
| This form of \$HASP1201 message is issued when one or more jobs in a concurrent set fail some checks to be eligible
| for execution. The concurrent set is delayed. JES2 retries attempt to start the concurrent set when all conditions are
| satisfied.
| OR

| ▶▶—Concurrent set containing job— *jobname*—in job group— *groupname*—————▶

|
| ▶—is delayed due to internal error RC=retcode.—————▶

|
| This form of \$HASP1201 message is issued when JES2 encounters an internal error when preparing a concurrent set
| for execution. This is abnormal situation. Contact the IBM Support Center to report this error.
| In the message text:

| *jobname* The name of a job that represents this concurrent set.

| *groupname*
| The name of the affected job group.

| **retcode** The code of internal error.

|
| *reason* is one of the following:

| **WITH= selection failed for a job in the set.**
| One or more of the jobs in the concurrent set specified WITH= on the SCHEDULE statement. The reference
| job is not active on any member in JES2 MAS.

| **Job in set is held.**

| • One or more of the jobs in the concurrent job set are held.
| • The job group is held.
| • At least one class of one of the jobs in the concurrent set is held.

| **Job within set is marked BUSY.**
| One of the jobs in the concurrent set is marked BUSY on JES2 device.

| **Job is ineligible for selection**
| No active JES2 members are available to select the concurrent set.

| **A job in the set is not active (it is FLUSHED or IN_ERROR)**
| One or more jobs within the concurrent set are not active, therefore, the set is delayed.

| **All WLM members are in independent mode.**
| Service class of the concurrent set does not have affinity to any active member.

| **Due to lack of service class affinity.**
| No JES2 members with the required service class affinity are available to select the concurrent set.

| **No members can select work due to job(s) JQESAF - JQASCHAF - JQASCLAF affinities.**
| No JES2 members with the required affinities are available to select the concurrent set.

| **Due to SECLABEL affinity (JQASCLAF).**
| No JES2 members with the required combination of SECLABELs are available to select the concurrent set.

| **Due to lack of scheduling environment affinity (JQASCHAF).**
| No JES2 members with the required combination of scheduling environments are available to select the
| concurrent set.

| **Due to SPOOLS used mask.**
| One or more SPOOL volumes that are required by the jobs in the concurrent set is not available.

| **Job locked within set.**
| One of the jobs in the concurrent set is locked.

| **No members available to select work based on associated job(s) class member affinity.**
| No JES2 members with the required combination of job classes are available to select the concurrent set.

\$HASP1210

- | **No members available to select work based on associated job(s) class MAX job limits.**
| Job class of some of the jobs in the concurrent set is at the maximum job class limit.
- | **Due to \$P or non-BOSS member status.**
| A JES2 member has stopped processing or is not WLM BOSS.
- | **Minimum BCP level not available.**
| No JES2 member is available with the z/OS level suitable for all jobs in the concurrent set.
- | **No capacity to run set at this time.**
| WLM has indicated that it does not have capacity to run the concurrent set currently.
- | **Set already queued for execution.**
| The concurrent set is already in the process of being started.
- | **No BOSS member up to handle concurrent set.**
| There are no JES2 BOSS members to put the concurrent set into execution.
- | **\$DCONSET request sent to another member.**
| JES2 determined the concurrent set should be run on another member and has sent a request to that member to put the concurrent set into execution.
- | **All jobs in set are independent mode but no independent members available.**
| All jobs in the concurrent set are independent mode, but no independent mode JES2 members are available.
- | **Set contains jobs running independent and non-independent mode.**
| The jobs within the concurrent job set contain a mixture of independent mode jobs and non-independent mode jobs, so they cannot be put into execution on any system.
- | **All jobs in set are non-independent mode but no non-independent members.**
| All jobs in the concurrent set are non-independent mode, but all JES2 members are independent mode.
- | **System action:** The message is written to the console and to the job group's JESMSGLG data set.
- | **Operator response:** None if this is expected state.
- | For delay form of the messages, if you want the concurrent set to be put into execution, remove the described reason for the delay.
- | For internal error form of the message, inform the system programmer.
- | **System programmer response:** For internal error form of the message, contact the IBM Support Center to report this error.
- | **Module:** HASPXEQ
- | **Routing Code:** 1,2,10
- | **Descriptor Code:** N/A

\$HASP1210

Explanation:

- | ►—Internal error occurred in job group— *groupname*—RC=retcode.—◀
- |
- | JES2 encountered an internal error while processing the job group indicated.
- | In the message text:
| *groupname*
| The name of the affected job group.
- | **retcode** The code of internal error.
- | **System action:** The message is written to the console and to the job group's JESMSGLG data set. Job group state remains unchanged.
- | **Operator response:** Report this error to the system programmer.
- | **System programmer response:** Contact the IBM Support Center to report this error.

| **Module:** HASCJZDN
| **Routing Code:** 1,2,10
| **Descriptor Code:** N/A

| **\$HASP1300**

| **Explanation:**

| ►►—*jobname*—registered to job group—*jobgroupname*—————►►

| This message is issued when a job is placed under control of a job group.
| In the message text:

| **jobname**
| The name of the job.

| **jobgroupname**
| The name of the job group.

| **System action:** The message is written to the console and to the job group's JESMSGLG data set. Processing of the job continues under control of the job group.

| **Operator response:** None.

| **Programmer response:** None.

| **Module:** HASCJZDN

| **Routing Code:** 2,9,10

| **Descriptor Code:** 6

| **\$HASP1301**

| **Explanation:**

| ►►—*jobname*—in job group—*jobgroupname*—queued for execution—————►►

| This message is issued when all dependencies for this job in the job group have been satisfied and the job is allowed to transition to the execution phase.
| In the message text:

| **jobname**
| The name of the job.

| **jobgroupname**
| The name of the job group.

| **System action:** The message is written to the console and to the job group's JESMSGLG data set. The job is moved to the execution queue.

| **Operator response:** None.

| **Programmer response:** None.

| **Module:** HASCJZDN

| **Routing Code:** 2,10,11

| **Descriptor Code:** 6

\$HASP1301 • \$HASP1303

\$HASP1301

Explanation:

►►—Concurrent set containing job—*jobname*—in job group—*jobgroupname*—queued for execution—►►

This message is issued when all dependencies for all jobs in a concurrent set of jobs in the job group have been satisfied and this set of jobs is allowed to transition to the execution phase.

In the message text:

jobname

The name of the job that represents the concurrent set.

jobgroupname

The name of the job group.

System action: The message is written to the console and to the job group's JESMSGLG data set. JES2 chooses one job in the concurrent set and moves it to the execution queue. JES2 uses this job to represent entire concurrent set during the execution phase.

Operator response: None.

Programmer response: None.

Module: HASCJZDN

Routing Code: 2,10,11

Descriptor Code: 6

\$HASP1302

Explanation:

►►—*jobname*—in job group—*jobgroupname*—requires re-submission—►►

This message is issued when the job group definition determines that job must be re-submitted before it can be considered successful. For example, the job was canceled or action for the job was specified as FAIL based on its execution result (see WHEN= and ACTION= keywords on AFTER or BEFORE job group definition statements).

In the message text:

jobname

The name of the job.

jobgroupname

The name of the job group.

System action: The message is written to the console and to the job group's JESMSGLG data set. Job group state for the job is set to IN-ERROR.

Operator response: None.

Programmer response: None.

Module: HASCJZDN

Routing Code: 2,10,11

Descriptor Code: 6

\$HASP1303

Explanation:

►►—*jobgroupname*—is suspended—►►

This message is issued when the job group is suspended, for example, when one of the jobs it controls is canceled.

| In the message text:

| **jobgroupname**

| The name of the job group.

| **System action:** The message is written to the console and to the job group's JESMSG LG data set. Job group is placed in the SUSPENDED state.

| **Operator response:** None.

| **Programmer response:** Resubmit one or more jobs to resume processing of the job group. Use \$Dgnn,JOBS command to see which jobs in the job group require resubmission.

| **Module:** HASCJZDN

| **Routing Code:** 2,10,11

| **Descriptor Code:** 6

| \$HASP1304

| **Explanation:**

| ►►—*job group—jobgroupname—is complete*—————►►

| This message is issued when the job group completes, that is, when all jobs it controls have completed or have been flushed. Job group also becomes complete after it was canceled.

| In the message text:

| **jobgroupname**

| The name of the job group.

| **System action:** The message is written to the console and to the job group's JESMSG LG data set. Job group is placed in COMPLETE state and is moved to the output queue.

| **Operator response:** None.

| **Programmer response:** None.

| **Module:** HASCJZDN

| **Routing Code:** 2,10,11

| **Descriptor Code:** 6

| \$HASP1305

| **Explanation:**

| ►►—*jobname—in job group—jobgroupname—is flushed*—————►►

| This message is issued when the job group definition determines that job must be flushed. (See WHEN= and ACTION= keywords on AFTER or BEFORE job group definition statements.)

| In the message text:

| **jobname**

| The name of the job.

| **jobgroupname**

| The name of the job group.

| **System action:** The message is written to the console and to the job group's JESMSG LG data set. The job definition in the job group is placed in the FLUSHED state. If job was registered for that job definition, this job is canceled and queued for the output processing.

| **Operator response:** None.

| **Programmer response:** None.

\$HASP1306 • \$HASP1307

| **Module:** HASCJZDN

| **Routing Code:** 2,10,11

| **Descriptor Code:** 6

| \$HASP1306

| **Explanation:**

| ►►—*job group—jobgroupname*—will be flushed—————►◄

| This message is issued when the definition of the job group determines that entire job group should be flushed.
| In the message text:

| **jobgroupname**

| The name of the job group.

| **System action:** The message is written to the console and to the job group's JESMSGLG data set. Job group is transitioned to the COMPLETE state. All jobs currently registered to this job group are canceled and queued for the output processing.

| **Operator response:** None.

| **Programmer response:** If flushing was not intended, determine which job caused the flush action, correct the error, and resubmit the job group and jobs. See *z/OS MVS JCL Reference* for information about job groups.

| **Module:** HASCJZDN

| **Routing Code:** 2,10,11

| **Descriptor Code:** 6

| \$HASP1307

| **Explanation:**

| ►►—*jobname*—in job group—*jobgroupname*—is cancelled due to the state of the job group—————►◄

| This message is issued when the submitted job is registered to the job group, but state of the job group or state of this job's definition in a job group determine, that this job should not run. For example, if job group is already complete or if this job was flushed before it was registered according to the job group's definitions.
| In the message text:

| **jobname**

| The name of the job.

| **jobgroupname**

| The name of the job group.

| **System action:** The message is written to the console and to the job group's JESMSGLG data set. Job is canceled and queued for the output processing.

| **Operator response:** None.

| **Programmer response:** None.

| **Module:** HASCJZDN

| **Routing Code:** 2,10,11

| **Descriptor Code:** 6

\$HASP1701

Explanation:

▶▶ Member—(— *membernum*—)—==— *membername*— updated— NULL—=>— *xxxx*— by— *yyy*— PCE—————▶◀

or the long form:

▶▶ Member—(— *membernum*—)—==— *membername*— updated— *xxxx*—=>— *xxxx*— by— *yyy*— PCE—————▶

▶ XCF_MEMBER—==— *xcfmembername*—,—---- XMAFLAG3—==—(— *zzz*—)—,— XMAQNEWS—==— *nn*—————▶◀

The message is displayed when DEBUG MEMBER_STATE=YES is set and JES2 detects a state change in a MAS member.

Note: A *jobid* can precede message \$HASP1701. See “JES2 message format” on page 1.

In the message text:

membernum

A numeric value from 1-32 of the MAS member for which the state change was detected.

membername

A 1-4 alphanumeric and special (\$,#, or @) character name of the MAS member for which the state change was detected.

xxxx The member state (either a change from this state or to this state), which can be one of the following values: UNDEFINED, UNDEFINED-PENDING, INITIALIZING, ACTIVE, TERMINATING, DORMANT, AWAITING-ALICE-PROCESSING, TERMINATED, DRAINED, MVS_GONE, JES2_FAILED, or JESXCF-FAILED.

yyy The PCE that caused the member's state change.

zzz The XMAFLAG3 value.

xcfmembername

The XCF member name, in the format *nodename*\$*membername*, where *nodename* is the name of the JES2 node containing the member.

nn The XMANEWS value.

System action: JES2 processing continues.

Operator response: None.

Programmer response: None.

Module: HASPXCF

Routing Code: 2, 10

Descriptor Code: 4

Chapter 15. Two-thousands

The following messages are in the 2000 number range.

\$HASP2101

Explanation:

▶▶—JES2— *jes2_level*—is not supported on— *mvs_level*—▶▶

The message is displayed when the JES2 level that you are attempting to install is not supported on the installed MVS level.

In the message text:

jes2_level

The JES2 level that you are attempting to install.

mvs_level

The installed MVS level.

System action: JES2 processing waits for a user response.

Operator response: Reply CONTINUE to initialize JES2 in this unsupported environment. Reply TERM to shut down JES2.

Programmer response: None.

Module: HASPXCF

Routing Code: 2, 10

Descriptor Code: 4

Chapter 16. Four-thousands

The following messages are in the 4000 number range.

\$HASP4401

Explanation:

▶▶—JES2 cannot start because a checkpoint reconfiguration occurred————▶▶

JES2 initialization processing has detected that a checkpoint reconfiguration occurred while JES2 was initializing. The initialization processing has lost proper serialization of the checkpoint and cannot continue. JES2 is terminated and must be re-started.

System action: JES2 initialization processing is terminated.

Operator response: Restart JES2.

Programmer response: None.

Module: HASPIRDA

Routing Code: 1,2,10

Descriptor Code: 4

Chapter 17. Five-thousands

The following messages are in the 5000-5999 number range.

\$HASP5001

Explanation:

▶▶—NETSRV—*xxx*—IS WAITING FOR OMVS INITIALIZATION—▶▶

A network server device NETSRV*xxx* has been started but OMVS is not yet available. If the NETSRV specifies START=YES in the initialization deck, this might be a normal occurrence as the OMVS address space requires JES2 to complete its initialization.

System action: The start of the device is delayed until OMVS initialization completes.

Operator response: If the message persists, ensure that OMVS is correctly initialized.

Programmer response: None

Module: HASCNJAS

Routing Code: 1, 2, 8, 10

Descriptor Code: 7, 11

\$HASP5002

Explanation:

▶▶—NETSRV—*xx*—INITIALIZATION ERROR - RC=—*nnnnnnn*—FROM—*service*—▶▶

The initialization of a NETSRV address space failed. The failing service and return code are displayed in the message.

System action: Processing continues.

Operator response: Contact system programmer.

Programmer response: Contact IBM service.

Module: HASCNJAS

Routing Code: 1, 2, 8, 10

Descriptor Code: 4

\$HASP5068

Explanation:

▶▶—NETSRV—*xxx*— *yyyyyyyy*—SUBTASK—*<nnn>*— - ABEND LIMIT EXCEEDED, —*nnn*— OF—*yyyyyyyy*—▶▶

▶—SUBTASKS REMAIN—▶▶

A subtask in the NETSRV address space has exceeded the abend threshold and has been terminated.

System action: Processing continues without the subtask. If the number of remaining subtasks is 0, the NETSRV address space is terminated and the NETSRV is drained.

Operator response: None

System programmer response: See other error message to determine the cause of the subtask abends.

\$HASP5069 • \$HASP5087

Module: HASCNJRC

Routing Code: 1, 2, 10

Descriptor Code: 7, 11

\$HASP5069

Explanation:

▶▶—NETSRV—xxx—SYSTEM DUMP SUPPRESSED BY—<SLIP>—<DUMP ANALYSIS ELIMINATION>—————▶
▶<INSTALLATION REQUEST>—————▶▶

JES2 requested an SVC dump in a NETSRV address space.

JES2 found that:

- The requested dump contained the same symptoms as an existing dump by the dump analysis elimination (DAE) routine.
- A SVC dump was suppressed by a SLIP NODUMP command.
- A SVC dump was suppressed by a request from the installation (for example, DUMP=NO at IPL or CHNGDUMP SET,NODUMP).

System action: Processing continues.

Operator response: None

System programmer response: See other error messages to determine why a dump was requested.

Module: HASCNJRC

Routing Code: 1, 2, 10

Descriptor Code: 4

\$HASP5081

Explanation:

▶▶—NETSRV—xxx—SYSTEM DUMP UNSUCCESSFUL—————▶▶

The SDUMP requested from a JES2 NETSRV address space has failed. A probable cause is that the dump data set is full.

System action: Processing continues.

Operator response: Notify the system programmer.

System programmer response: Determine the reason(s) why the SDUMP failed and correct the problem.

Module: HASCNJRC

Routing Code: 1, 2, 10

Descriptor Code: 4

\$HASP5087

Explanation:

▶▶—NETSRV—xxx—RECOVERY FAILED, CODE=S—xxx—————▶▶

An ABEND occurred during recovery processing in a JES2 network server address space.

System action: As SDUMP is requested and the task in the NETSRV address space is terminated.

Operator response: None

System programmer response: See other error message to determine the cause of the recovery abends.

Module: HASCNJRC

Routing Code: 1, 2, 10

Descriptor Code: 4

\$HASP5088

Explanation:

▶▶—NETSRV—xxx—ABEND ANALYSIS—▶▶

Explanation: JES2 writes this message to SYSLOG when JES2 processing in a NETSRV address space abends. This message contains the requested indicative dump information.

In the message text:

xxxxxxx

SMP function modification ID for the current JES2 product.

lmodname

The name of the load module in which the error occurred.

ssss

Subsystem name (such as JES2 or JESA).

vvvvvvvv

Subsystem version identifier.

uuuuuuuu

Installation version identifier (defaults to blanks).

yyyy.ddd

Year and day of the message.

hh.mm.ss

The time in hours (hh), minutes (mm), and seconds (ss) when JES2 wrote the message.

tasktype

The type of subtask under which the ABEND occurred. This could be GENERAL or REQUEST for JES2 subtask, or a LINE device name for connection subtasks.

nnn

The subtask number for general purpose subtasks.

jobname

The job name of the job being processed by this subtask.

jobid

The job ID of the job being processed by this subtask.

devname

The device name of the transmitter or receiver subdevice currently processing the job.

The next 6 fields are repeated for each module from the module that initiated the processing through the failing module.

modname

Name of the module.

stradr

Beginning address of the JES2 module.

offset

Offset into the JES2 module of the failing instruction or the call to the next module.

ptfnum

The number of the last PTF applied to this module. If there have been no PTFs applied to this module, this field reads NONE. If this module is part of an installation exit, this field reads UNKNOWN.

rtn-or-abend

The name of the last routine called by this module. This field always contains the abend or error for the failing module.

callname1

The module that invoked the subtask.

\$HASP5090

<i>rtname</i>	The name of the last routine called by the subtask caller.
<i>instr</i>	The actual failing instruction. It is not given if the home ASID is not the same as the primary ASID.
<i>psw</i>	PSW at the time of the error.
<i>n</i>	Instruction length code.
<i>mmm</i>	Interruption code.
<i>tea_addr</i>	Translation exception address related to the program check. If the abend was a program check, this is the translation exception address associated with the program check. If none is available, this field will not be displayed.
<i>Modname</i>	<i>Address + offset</i> Breaking event address. If supported by the hardware, this is the address of the last branch instruction before a program check. This is useful for diagnosing wild branch instructions.
<i>asid</i>	Address space identifiers (ASID) at the time of abend (home asid, primary asid, and secondary asid). All the address spaces indicated by this message are included in the SDUMP(s) written from this abend by JES2. These ASID values are not given on a SNAP dump if JES2 ends because of a catastrophic error (cde \$nnn) caused by a JES2 \$ERROR macro, or if an SDWA was not allocated for this abend. If the home ASID is not the same as the primary ASID, then the failing instruction is not given in the \$HASP088 message.
<i>r0-r15</i>	Contents of the registers at the time of the error. Addresses which are qualified by ALETs are indicated with a Q by the address.

System action: When the indicative dump completes, JES2 issues message \$HASP098.

System programmer response: If the home ASID is not the primary ASID, diagnose one or more of the associated dumps and recognize that the \$HASP5088 message trace indicates activity within the JES2 address space (HOME), while the actual abend location is in the primary address space and has occurred in a cross-memory "PC" routine.

Module: HASCNJRC

Routing Code: 1, 2, 10

Descriptor Code: 4

\$HASP5090

Explanation:

▶▶—CALLER ADDRESS ARRAY—OVERFLOWED—▶▶

JES2 processing is attempting to build the calling sequence for the \$HASP5088 message. The calling sequence includes routines in the JES2 CSA modules. Because the linkage stack is used in these routines, the list of routines called is kept in a separate table. When JES2 attempts to access that table, the pointer to the current entry occurs outside the end of table, probably the result of an error in the caller array.

System action: JES2 does not include any of the CSA routines in the \$HASP5088 message. The rest of the message is issued normally.

Operator response: None

System programmer response: When debugging the error, you must examine the linkage stack entries to determine which CSA routines were called.

Module: HASCNJRC

Routing Code: 1, 2, 10

Descriptor Code: 4

\$HASP5091

Explanation:

▶▶—NETSRV—*xxx*—IS ACTIVE—▶▶

The operator issued a \$NETSRV*xxx* or START=YES was specified on the initialization statement for the NETSRV device. Address space initialization has completed successfully for the device.

System action: The NETSRV address space continues.

Operator response: None

System programmer response: None

Module: HASCNJAS

Routing Code: 1, 2, 8, 10

Descriptor Code: 4

\$HASP5093

Explanation:

▶▶—CALLER ADDRESS ARRAY—UNDERFLOWED—▶▶

JES2 processing is attempting to build the calling sequence for the \$HASP5088 message. The calling sequence includes routines in the JES2 CSA modules. Because the linkage stack is used in these routines, the list of routines called is kept in a separate table. When JES2 attempts to access the table, the pointer to the current entry occurs before the beginning of the table, probably the result of an error in the caller array.

System action: JES2 does not include any of the CSA routines in the \$HASP5088 message. The rest of the message is issued normally.

Operator response: None

System programmer response: When debugging the error, you must examine the linkage stack entries to determine which CSA routines were called.

Module: HASCNJRC

Routing Code: 1, 2, 10

Descriptor Code: 4

\$HASP5095

Explanation:

▶▶—NETSRV—*xxx*—ABEND CODE=S—*cde*—(RC=—*rsnc*—)▶▶

An error has called a JES2 ESTAE in the NETSRV address space to receive control. In the message text:

NETSRVxxx

The name of the NETSRV device under which the ABEND occurred

cde One of the system completion codes documented in *z/OS MVS System Codes*

rsnc The reason code associated with the cause of this occurrence

System action: An SDUMP is requested and recovery is attempted.

Operator response: Notify the system programmer.

System programmer response: Use the dump obtained to diagnose the error.

\$HASP5532

Module: HASCNJRC

Routing Code: 1, 2, 10

Descriptor Code: 4

\$HASP5532

Explanation:

►►—*jobname devname*—SEVERE ERROR —*reason*—◄◄

An error occurred or was detected when sending or receiving *jobname* on the device *devname*.
reason may be one of the following:

JQE/JOE MISMATCH, RC=1

The selected JOE no longer points to the correct JQE.

JOE SPIN/NONSPIN MISMATCH, RC=2

Multiple spin data sets, or a combination of spin and non-spin data sets, were selected.

SUBTASK ERROR, RC=3

A general purpose subtask failed while processing a job.

OPEN FAILURE, RC=4

An OPEN failed for a SYSIN or SYSOUT data set.

CLOSE FAILURE, RC=5

A CLOSE failed for a SYSIN or SYSOUT data set.

SPOOL I/O FAILURE, RC=6

A GET or a PUT failed while reading or writing a data set.

\$CBIO FAILURE, RC=7

A control block I/O failed.

HEADER/TRAILER BUILD ERROR, RC=8

An invalid NJE header or trailer was received, or returned by \$EXIT 56 or 57.

RECORD SEQUENCE ERROR, RC=9

An incorrect sequence of NJE records was received.

GENERIC GROUPING ERROR, RC=10

The SYSOUT receiver encountered a generic grouping error.

SJF ERROR, RC=11

An error was encountered while processing SWBs.

SECURITY CHECK FAILED, RC=12

A security check failed.

System action: The transmit or receive stream is terminated.

Operator response: None

System programmer response: See other error messages and traces to determine the cause of the failure.

Module: HASCNJJT, HASCNJJR, HASCNJST, HASCNJSR

Routing Code: 1, 2, 10

Descriptor Code: 4

Chapter 18. Nine-thousands

\$HASP9500 through \$HASP9999: JES2 does not use these message IDs. They are for customer use only.

Messages in this range

JES2 supplies sample installation exits in SYS1.SAMPLIB. Some of these exits issue messages within this range. If you customize any of these exits in your installation, be aware of any such message or reassign the message IDs to not conflict with any other installation-defined messages.

\$HASP9049

Explanation:

▶▶—XXXXXXXX—COMMAND NOT RECOGNIZED—▶▶

A command has been routed to the JES2 monitor for processing because it started with the JES2 command character followed by a 'J' (for example \$J BADCOMMAND) but the monitor did not recognize the command. Under normal circumstances, any command the monitor does not recognize is routed to the JES2 address space for processing. However, if JES2 issued this message, the JES2 address space must be unable to accept commands. In the message text:

XXXXXXXX

The first 10 characters of the unrecognized command.

System action: JES2 rejects the command.

Operator response: Correct the error and reissue the command.

System programmer response: None.

Module: HASJCMDS

Routing Code: Routed as a command response

Descriptor Code: 5

\$HASP9050

Explanation:

▶▶—XXXXXXXX—OPERAND NOT RECOGNIZED—▶▶

An operand was detected for a JES2 monitor command that is either not allowed or not recognized. In the message text:

XXXXXXXX

The first 10 characters of the unrecognized operand.

System action: JES2 rejects the command.

Operator response: Correct the error and reissue the command.

System programmer response: None.

Module: HASJCMDS

Routing Code: Routed as a command response

Descriptor Code: 5

\$HASP9051 • \$HASP9053

\$HASP9051

Explanation:

▶▶—xxxxxxxx—LOCATION UNAVAILABLE—▶▶

An L= operand was detected for a JES2 monitor command that specified an area or console that either does not exist or is not available to the monitor. If the specified console is not available, this message appears on the issuing console.

In the message text:

xxxxxxxx

The location specified on the command.

System action: JES2 rejects the command.

Operator response: Correct the error and reissue the command.

System programmer response: None.

Module: HASJCMDS

Routing Code: Routed as a command response

Descriptor Code: 5

\$HASP9052

Explanation:

▶▶—INVALID SUBSCRIPT—xxxxxxxx—▶▶

An invalid subscript was specified for a monitor command that does not support subscripts. Problems include unrecognized values and too many subscripts. The first 8 characters of the subscript are displayed in the command.

In the message text:

xxxxxxx

The subscript where the error was encountered.

System action: The command is rejected. If multiple subscripts were specified, JES2 might process any valid subscripts.

Operator response: Correct the error and reissue the command.

System programmer response: None.

Module: HASJCMDS

Routing Code: Routed as a command response

Descriptor Code: 5

\$HASP9053

Explanation:

▶▶—*command*—REJECTED, MONITOR TERMINATING—▶▶

While the JES2 monitor was in the process of terminating, it found that commands were queued for processing. JES2 does not process these commands and returns \$HASP9053 to the command issuer.

In the message text:

command

The first 10 characters of the command that is being rejected.

System action: Command is not processed.

Operator response: None.

System programmer response: None.

Module: HASJCMDS

Routing Code:Routed as a command response

Descriptor Code: 5

\$HASP9084

Explanation:

▶▶—JES2 MONITOR ADDRESS SPACE STARTED FOR—*jes2*————▶▶

JES2 started the monitor either because JES2 is initializing or the monitor was restarted after having been terminated by a \$JSTOP command or an ABEND.

In the message text:

jes2 The name of the JES2 subsystem being monitored.

System action: Processing continues.

Operator response: None.

System programmer response: None.

Module: HASJMON

Routing Code: 2, 10

Descriptor Code: 4

\$HASP9085

Explanation:

▶▶—JES2 MONITOR ADDRESS SPACE STOPPED FOR—*jes2*————▶▶

JES2 stopped the monitor either because JES2 is terminating or in response to a \$JSTOP command.

In the message text:

jes2 The name of the JES2 subsystem no longer being monitored.

System action: If a \$JSTOP command was issued and JES2 is still active, then the monitor will be restarted within a few minutes. If JES2 is terminating, then the monitor is not restarted.

Operator response: None.

System programmer response: None.

Module: HASJMON

Routing Code: 2,10

Descriptor Code: 4

\$HASP9090

Explanation:

▶▶—xxxxxxxx—COMMAND REJECTED - AUTHORIZATION FAILURE————▶▶

A JES2 monitor command was entered by an operator or from a console that lacks sufficient authority to issue the command. The security product might issue a related message, such as ICH408I, which can be used to further identify the source of the problem.

In the message text:

\$HASP9100

xxxxxxxx

The first 10 characters of the command that was rejected.

System action: The command is rejected.

Operator response: Monitor commands cannot be issued without proper authority from the security product.

System programmer response: Contact the security administrator to determine whether the command should be accepted. Update the appropriate profiles, if necessary, and notify the operator that the command might be reentered.

Note: the first qualifier for the entity name of JES2 monitor commands is not the same as the first qualifier for JES2 commands. For the JES2 monitor, the entity names start with *jes2MON* where *jes2* is the name of the JES2 address space being monitored.

Module: HASJCMDS

Routing Code: Routed as a command response

Descriptor Code: 5

\$HASP9100

Explanation:

▶▶—D MONITOR—————▶▶

NAME	STATUS	ALERTS
----	-----	-----
<i>taskname</i>	<i>status</i>	<i>alert</i>

JES2 issues this message in response to a \$JDMONITOR monitor command. This message describes the current status of each of the tasks and subtasks that make up the JES2 monitor. If any of the tasks are unable to perform their normal functions, this message would describe the problem.

In the message text:

taskname

Name of the task or subtask being described.

status Current status of the task or subtask. Can be one of:

ACTIVE

Subtask is operating normally.

INITIALIZING

Subtask is initializing

TERMINATED

Subtask has shut down.

TERMINATING

Main task is terminating subtasks.

alert The reason why a task or subtask is unable to perform its normal functions. For example:

AWAITING JES2

The JES2 main task is not currently available.

RECOVERING

The subtask is in the process of recovering from an ABEND.

System action: Continues normal processing.

Operator response: None.

System programmer response: None.

Module: HASJCMDS

Routing Code: Routed as a command response

Descriptor Code: 5

\$HASP9101

Explanation:

▶▶—MONITOR STOPPING—▶▶

JES2 issues this message in response to a \$JSTOP monitor command before the address space is stopped.

System action: JES2 starts the JES2 monitor address space termination processing. When the monitor address space has stopped, JES2 issues the \$HASP9085 message. If the JES2 address space is still active, JES2 automatically restarts the monitor address space within a few minutes.

Operator response: None.

System programmer response: None.

Module: HASJCMDS

Routing Code: Routed as a command response

Descriptor Code: 5

\$HASP9102

Explanation:

▶▶—MONITOR MODULE INFORMATION—▶▶

NAME	ADDRESS	LENGTH	ASSEMBLY	DATE	LASTAPAR	LASTPTF
----	-----	-----	-----	----	-----	-----
<i>modname</i>	<i>address</i>	<i>length</i>	<i>mm/dd/yy</i>	<i>hh.mm</i>	<i>apar</i>	<i>ptf</i>

JES2 issues this message in response to a \$JDMONITOR monitor command. This message describes the modules that make up the JES2 monitor to reflect the current modules running in the monitor address space. If the JES2 address space was hot started, then the address information displayed on this command might be different from the address information displayed in a \$DMODULE JES2 command.

In the message text:

modname

Name of the module being described.

address

Current address of the module in the monitor address space.

length

Current length of the module.

mm/dd/yy hh.mm

The date and time the module was assembled.

apar

The last APAR that was applied to the module.

ptf

The last PTF that was applied to the module. If the PTF does not correspond to the APAR that is displayed, this implies that the last service that was applied to the module was a ++APAR.

System action: Continues normal processing.

Operator response: None.

System programmer response: None.

Module: HASJCMDS

Routing Code: Routed as a command response

Descriptor Code: 5

\$HASP9103 • \$HASP9104

\$HASP9103

Explanation:

▶▶—DETAIL—▶▶

JES2 issues this message in response to a \$JDDetails monitor command. This is a header message that is followed by the \$HASP9104, \$HASP9105 and \$HASP9106 messages.

System action: Processing continues, and JES2 issues the \$HASP9104, \$HASP9105, and \$HASP9106 messages.

Operator response: None.

System programmer response: None.

Module: HASJCMDS

Routing Code: Routed as a command response

Descriptor Code: 5

\$HASP9104

Explanation:

▶▶—JES2 RESOURCE USAGE SINCE—*yyyy.ddd hh:mm:ss*—▶▶

RESOURCE	LIMIT	USAGE	LOW	HIGH	AVERAGE
-----	-----	-----	---	----	-----
<i>name</i>	<i>limit</i>	<i>current</i>	<i>low</i>	<i>high</i>	<i>average</i>

JES2 issues this message in response to a \$JDDetails monitor command. This message describes, in a single response, the current utilization statistics for various JES2 resources. The statistics are reset every hour, within one minute past the hour.

Note: Resources are sampled, thus it is possible that a brief spike in usage of a resource could be missed by the sampling and the high reflected in the message might not reflect the actual highest utilization.

In the message text:

yyyy.ddd hh:mm:ss

Date and time the statistics were last reset.

name Name of the resource being monitored. For more information on resource names see the \$HASP050 message.

limit The limit for the resource at the current time. Because of changes by operator commands, this could be different from the limit at the time the sampling interval started.

current Amount of the resource currently in use.

low In the interval, the lowest amount of the resource in use.

high In the interval, the highest amount of the resource in use.

average In the interval, the average amount of the resource in use.

System action: JES2 continues processing and immediately issues message \$HASP9105.

Operator response: None.

System programmer response: None.

Module: HASJCMDS

Routing Code: Routed as a command response

Descriptor Code: 5

\$HASP9105

Explanation:

▶▶—JES2 SAMPLING STATISTICS SINCE—*yyyy.ddd hh:mm:ss*—————▶▶

TYPE	COUNT	PERCENT
----	-----	-----
ACTIVE	<i>count</i>	<i>percent</i>
IDLE	<i>count</i>	<i>percent</i>
LOCAL LOCK	<i>count</i>	<i>percent</i>
NON-DISPATCHABLE	<i>count</i>	<i>percent</i>
PAGING	<i>count</i>	<i>percent</i>
OTHER WAITS	<i>count</i>	<i>percent</i>
TOTAL SAMPLES	<i>count</i>	

JES2 issues this message in response to a \$JDDetails monitor command. This message displays the break down of JES2 main task CPU samples for the current interval. The counts are reset within one minute past the hour.

In the message text:

yyyy.ddd hh:mm:ss

The date and time the counts were last reset.

count In the current interval, the number of samples of this type.

percent In the current interval, the percentage of samples of this type.

Samples are divided into the following types:

ACTIVE

JES2 main task was active.

IDLE JES2 was waiting at the normal MVS wait.

LOCAL LOCK

JES2 main task is waiting to obtain the local lock.

NON-DISPATCHABLE

JES2 main task TCB has been marked non-dispatchable for other than an MVS wait.

PAGING

JES2 main task is waiting for paging activity.

OTHER WAITS

JES2 main task is in an MVS wait other than the normal wait for work.

TOTAL SAMPLES

Total number of sampled in this interval.

System action: JES2 processing continues and immediately issues message \$HASP9106.

Operator response: None.

System programmer response: None.

Module: HASJCMDS

Routing Code: Routed as a command response

Descriptor Code: 5

\$HASP9106

Explanation:

\$HASP9107

▶▶—JES2 MAIN TASK MVS WAIT TABLE—▶▶

DATE	TIME	ADDRESS	MODULE	OFFSET	WT-COUNT	SM-COUNT	PCE	EXIT
----	----	-----	-----	-----	-----	-----	---	---
<i>yyyy.ddd</i>	<i>hh:mm:ss</i>	<i>address</i>	<i>modname</i>	<i>+offset</i>	<i>wait_cnt</i>	<i>samplect</i>	<i>pce</i>	<i>exit</i>

JES2 issues this message in response to a \$JDDetails monitor command. This message displays JES2 main task MVS WAIT table. When the sampling code detects the JES2 main task is in an MVS WAIT, other than the normal wait for work, an entry is either added or updated in this table. This table is not reset unless the monitor is restarted. Entries in this table are not in any particular order.

In the message text:

yyyy.ddd hh:mm:ss

The date and time this wait last started. If multiple waits at the same address are detected, this is the start time of the latest wait.

address Address where the wait was detected.

modname+offset

The module name and offset that corresponds to the *address*. If the address cannot be identified, JES2 displays **UNKNOWN+000000**.

wait_cnt

The number of times this wait was detected by the sampling logic.

samplect

The number of samples taken at this address. If you use the formula $samplect/(wait_cnt*20)$ you get the average wait time for this wait.

pce

The PCE ID of the PCE in control at the time of this wait. If **MLT** is displayed, then multiple PCEs have waited at this wait.

exit

The exit number of the exit in control at the time of this wait. The values displayed can be:

number Only this exit was in control.

JCO JES2 code only was in control. No exits were in control.

MLT Multiple exits were in control, however, never JES2 code.

JNX Both exits and JES2 code were in control.

Note: Since data is sampled without serialization, it is possible that a single sample could have inconsistent sample data. In rare cases, a PCE or exit associated with a WAIT might not be correct.

System action: Command processing is complete. Normal processing continues.

Operator response: None.

System programmer response: None.

Module: HASJCMDS

Routing Code: Routed as a command response

Descriptor Code: 5

\$HASP9107

Explanation:

▶▶—No JES2 ERROR COUNTS SINCE *yyyy.ddd hh:mm:ss*—▶▶

ERR-TYPE	COUNT
-----	-----
<i>errtype</i>	<i>count</i>

JES2 issues this message in response to a \$JDDETAILS monitor command. This message displays the current counts for various types of JES2 errors. The statistics are reset every hour, within one minute past the hour. If there are no errors from the time since JES2 last sampled, JES2 issues the NO JES2 ERROR COUNTS form of the message.

In the message text:

yyyy.ddd hh:mm:ss

The date and time this wait last started. If multiple waits at the same address are detected, this is the start time of the latest wait.

errtype Type of the error. The different types of errors are:

- main task
- disastrous
- CBIO
- other errors in addition to the error counts for each subtask

count The number of times JES2 detected this error.

System action: Command processing is complete. Normal processing continues.

Operator response: None.

System programmer response: None.

Module: HASJCMDS

Routing Code: Routed as a command response

Descriptor Code: 5

\$HASP9108

Explanation:

▶— JES2 STORAGE USAGE (PAGES) SINCE *yyyy.ddd hh:mm:ss* —▶

AREA	REGION	USAGE	LOW	HIGH	AVERAGE
<16M USER	<i>region</i>	<i>usage</i>	<i>low</i>	<i>high</i>	<i>average</i>
<16M SYSTEM	<i>region</i>	<i>usage</i>	<i>low</i>	<i>high</i>	<i>average</i>
>16M USER	<i>region</i>	<i>usage</i>	<i>low</i>	<i>high</i>	<i>average</i> >
16M SYSTEM	<i>region</i>	<i>usage</i>	<i>low</i>	<i>high</i>	<i>average</i>

JES2 issues this message in response to a \$JDDETAILS monitor command. The message describes the current storage utilization. The statistics are reset every hour, within one minute past the hour.

In the message text:

yyyy.ddd hh:mm:ss

The date and time the statistics were last reset.

region The region size (number of 4K pages).

usage Amount of storage currently in use (number of 4K pages).

low In the interval, the lowest amount of storage used (number of 4K pages).

high In the interval, the highest amount of storage used (number of 4K pages).

average In the interval, the average amount of storage used (number of 4K pages).

System action: Command processing is complete. Normal processing continues.

Operator response: None.

System programmer response: None.

Module: HASJCMDS

\$HASP9120 • \$HASP9122

Routing Code: Routed as a command response

Descriptor Code: 5

\$HASP9120

Explanation:

▶▶—\$HASP9120 D JES—▶▶

▶▶—\$HASP9120 D STATUS—▶▶

JES2 issues this message in response to a \$JDJES or a \$JDSTATUS monitor command. This is a header message that is followed by the \$HASP9121, \$HASP9122 (\$JDJES) and \$HASP9150 messages.

System action: Processing continues and JES2 immediately issues the \$HASP9121, \$HASP9122 (\$JDJES), and \$HASP9150 messages.

Operator response: None.

System programmer response: None.

Module: HASJCMDS

Routing Code: Routed as a command response

Descriptor Code: 5

\$HASP9121

Explanation:

▶▶—\$HASP9121 NO OUTSTANDING ALERTS—▶▶

▶▶—\$HASP9121 OUTSTANDING ALERTS—▶▶

JES2 issues this message in response to a \$JDJES or a \$JDSTATUS monitor command. This message is the header for alert messages that follow. Alerts represent conditions detected by the monitor that are not considered normal. Each alert has a message number associated with it. See the description of the alert message for more information. If there are no outstanding alerts, the *NO OUTSTANDING ALERTS* form of the message is issued.

System action: Displays any outstanding alerts and continues with the command response.

Operator response: If an alert message is displayed, consult the explanation for the alert message for further information.

System programmer response: None.

Module: HASJCMDS

Routing Code: Routed as a command response

Descriptor Code: 5

\$HASP9122

Explanation:

▶▶—\$HASP9122 NO INCIDENTS BEING TRACKED—▶▶

▶▶—\$HASP9122 INCIDENTS BEING TRACKED—▶▶

JES2 issues this message in response to a \$JDJES monitor command. This message is the header for incident tracking messages that follow. Incidents are tracked when a potential problem is detected but the duration of the incident is not long enough to be considered abnormal. Incidents that last long enough become alerts. Each incident that is tracked has a message number associated with it. See the description of the incident message for more information. If there are no incidents being tracked, the *NO INCIDENTS BEING TRACKED* form of the message is issued.

System action: Displays data for incidents being tracked and continues with the command response.

Operator response: If any incident tracking messages are displayed, consult the explanation for the message for further information.

System programmer response: None.

Module: HASJCMDS

Routing Code: Routed as a command response

Descriptor Code: 5

\$HASP9130

Explanation:

▶▶—D HISTORY—▶▶

JES2 issues this message in response to a \$JDHISTORY monitor command. This is a header message that is followed by the \$HASP9131 and \$HASP9132 messages.

System action: Processing continues and JES2 immediately issues the \$HASP9131 and \$HASP9132 messages.

Operator response: None.

System programmer response: None.

Module: HASJCMDS

Routing Code: Routed as a command response

Descriptor Code: 5

\$HASP9131

Explanation:

▶▶—JES2—*name*—USAGE HISTORY—▶▶

DATE	TIME	LIMIT	USAGE	LOW	HIGH	AVERAGE
----	----	-----	-----	---	---	-----
yyyy.ddd	hh:mm:ss	limit	usage	low	high	average

JES2 issues this message in response to a \$JDHISTORY monitor command. This message displays the history of resource usage over time. When the resource statistics are reset, the old values are saved and displayed in this message. Up to 72 samples are displayed for each resource which represents 72 hours of resource usage.

Note: Resources are sampled, thus it is possible that a brief spike in usage of a resource may be missed by the sampling and the high reflected in this message may not reflect the actual highest utilization.

In the message text:

name The name of the resource being monitored. For more information on resource names see the \$HASP050 message.

yyyy.ddd hh:mm:ss
The date and time when the interval started. The most current interval is displayed first.

\$HASP9132

limit The limit for the resource when the interval ended. Because of changes by operator commands, this may be different from the limit at the time the sampling interval started.

usage Resource usage at the end of the interval.

low The lowest amount of the resource in use during the interval.

high The highest amount of the resource in use during the interval.

average The average amount of the resource in use during the interval.

System action: Processing continues and JES2 issues the \$HASP9132 message.

Operator response: None.

System programmer response: None.

Module: HASJCMDS

Routing Code: Routed as a command response

Descriptor Code: 5

\$HASP9132

Explanation:

▶▶—MAIN TASK SAMPLING PERCENT HISTORY—◀◀

DATE	TIME	COUNT	ACTIVE	IDLE	WAIT	L-LOCK	N-DISP	PAGING
----	----	-----	-----	-----	-----	-----	-----	-----
yyyy.ddd	hh:mm:ss	count	active	idle	wait	llock	ndisp	paging

JES2 issues this message in response to a \$JDHISTORY monitor command. This message displays the history of JES2 main task CPU samples over time. When the counts are reset, the old values are saved and displayed in this message. JES2 displays up to 72 set of counts representing 72 hours of CPU statistics.

In the message text:

yyyy.ddd hh:mm:ss

The date and time when the interval started. The most current interval is displayed first.

count The number of samples collected in the interval.

active Percent of samples when JES2 main task was actively running.

idle Percent of samples when JES2 was waiting in a normal z/OS wait.

wait Percent of samples when JES2 main task is in a z/OS wait other than the normal wait for work.

llock Percent of samples when JES2 main task is waiting to obtain the local lock.

ndisp Percent of samples when JES2 main task TCB has been marked non-dispatchable for other than a z/OS wait.

paging Percent of samples when JES2 main task is waiting for paging activity.

System action: Processing continues normally.

Operator response: None.

System programmer response: None.

Module: HASJCMDS

Routing Code: Routed as a command response

Descriptor Code: 5

\$HASP9133

Explanation:

▶▶—JES2 ERROR HISTORY—◀◀

DATE	TIME	MAIN	DISTERR	CBIO	SUBTASK	OTHER
-----	-----	-----	-----	-----	-----	-----
yyyy.ddd hh:mm:ss		main	disterr	cbio	subtask	other

JES2 issues this message in response to a \$JDHISTORY monitor command. This message displays the history of counts of various JES2 error types over time. When the counts are reset, the old values are saved and displayed in this message. JES2 displays up to 72 sets of counts representing 72 hours of error statistics.

In the message text:

yyyy.ddd hh:mm:ss

The date and time when the interval started. The most current interval is displayed first.

main The total number of main task errors at the end of the interval.

disterr The total number of the disastrous errors at the end of the interval.

cbio The total number of CBIO failures at the end of the interval

subtask The total number of errors of all the subtasks of JES2 at the end of the interval

Other The total number of PQE and CKPT errors at the end of the interval

System action: Processing continues normally.

Operator response: None.

System programmer response: None.

Module: HASJCMDS

Routing Code: Routed as a command response

Descriptor Code: 5

\$HASP9134

Explanation:

▶▶— JES2—*name*—STORAGE USE HISTORY (PAGES)—◀◀

DATE	TIME	REGION	USAGE	LOW	HIGH	AVERAGE
-----	-----	-----	-----	-----	-----	-----
yyyy.ddd hh:mm:ss		region	usage	low	high	average

JES2 issues this message in response to a \$JDHISTORY monitor command. This message displays the history of storage utilization over time. When the counts are reset, the old values are saved and displayed in this message. JES2 displays up to 72 sets of data representing 72 hours of storage utilization.

In the message text:

name The name of the storage type being monitored.

yyyy.ddd hh:mm:ss

The date and time when the interval started. The most current interval is displayed first.

region The region size when the interval ended (number of 4K pages).

usage Amount of storage in use at the end of the interval (number of 4K pages).

low During the interval, the lowest amount of storage used (number of 4K pages).

\$HASP9150 • \$HASP9151

high During the interval, the highest amount of storage used (number of 4K pages).

average During the interval, the average amount of storage used (number of 4K pages).

System action: Command processing is complete. Normal processing continues.

Operator response: None.

System programmer response: None.

Module: HASJCMDS

Routing Code: Routed as a command response

Descriptor Code: 5

\$HASP9150

Explanation:

▶▶—\$HASP9150 NO JES2 NOTICES—▶▶

▶▶—\$HASP9150 JES2 NOTICES—▶▶

JES2 issues this message in response to a \$JDJES or a \$JDSTATUS monitor command. This message is the header for notice messages (\$HASP9151–\$HASP9162) that follow. Notices are potentially normal conditions but might explain why JES2 is not operating as expected. Conditions that result in notices are not time oriented. If the condition exists at the time of the command, the corresponding notice message is issued. Each notice has a message number associated with it. See the description of the notice message for more information. If there are no outstanding notices, JES2 issues the *NO JES2 NOTICES* form of the message.

System action: Displays any outstanding notices and continues with the command response.

Operator response: If a notice message is displayed, consult the explanation for the notice message for further information.

System programmer response: None.

Module: HASJCMDS

Routing Code: Routed as a command response

Descriptor Code: 5

\$HASP9151

Explanation:

▶▶—JES2 ADDRESS SPACE NOT ACTIVE—▶▶

JES2 issues this notice message in response to a \$JDJES or a \$JDSTATUS monitor command. This message indicates that the JES2 address space has been abnormally terminated and is not available for processing.

System action: Display continues.

Operator response: If the \$HASP9197 message is also displayed, the JES2 address space cannot be restarted and you must re-IPL the system to recover JES2 functions.

If you do not receive the \$HASP9157 message, use the \$D A,JES2 command to determine if the JES2 address space currently exists. If the JES2 address space is not present, use the appropriate procedure to restart JES2. If JES2 does exist, it is probably early in its initialization process and might be waiting for a reply to a WTO. Issue a \$D R,JOB=JES2 command to display any outstanding requests from JES2. See the description of any messages displayed for additional information. If no requests are outstanding the problem might be caused by a WTO buffer shortage. Look for a IEA404A message (D R,MSG=IEA404A). If there is no buffer shortage and the condition persists, contact your system programmer.

System programmer response: If the JES2 address space is present and this message is displayed, then either JES2

cannot complete termination or JES2 is unable to complete early initialization. Having determined there are no outstanding requests (D R,JOB=JES2), look for ENQ problems (D GRS,ANALYZE) and also ensure there is no WTO buffer shortage (no IEA404A message). If no problems are found, DUMP the JES2 address space and determine why JES2 is not responding. Contact IBM support as appropriate.

Module: HASJCMDS

Routing Code: Routed as a command response

Descriptor Code: 5

\$HASP9152

Explanation:

▶▶—JES2 INITIALIZING—◀◀

JES2 issues this notice message in response to a \$JDJES or a \$JDSTATUS monitor command. This message indicates that the JES2 address space is initializing and is not yet available for processing.

System action: Display continues.

Operator response: The JES2 address space is in its initialization process and might be waiting for a reply to a WTOR or JES2 might have also issued a \$HASP709 message indicating an initialization delay. Issue a D R,JOB=JES2 command to display any outstanding requests from JES2. See the description of any messages displayed for additional information. If no requests are outstanding and the condition persists, contact your system programmer.

System programmer response: If this condition persists, JES2 is unable to complete initialization processing. Having determined there are no outstanding requests (D R,JOB=JES2), look for ENQ problems (D GRS,ANALYZE). If no problems are found, DUMP the JES2 address space and determine why JES2 is not responding. Contact IBM support as appropriate.

Module: HASJCMDS

Routing Code: Routed as a command response

Descriptor Code: 5

\$HASP9153

Explanation:

▶▶—JES2 TERMINATING—◀◀

JES2 issues this notice message in response to a \$JDJES or a \$JDSTATUS monitor command. This message indicates that the JES2 address space is terminating and is not available for processing.

System action: Display continues.

Operator response: The JES2 address space is in the process of terminating and might be waiting for a reply to a WTOR. Issue a D R,JOB=JES2 command to display any outstanding requests from JES2. See the description of any messages displayed for additional information. If no requests are outstanding ensure a WTO buffer shortage does not exist. Look for a IEA0404A message (D R,MSG=IEA0404A). If no problems are found and the condition persists, contact your system programmer.

System programmer response: If this condition persists, JES2 is unable to complete termination processing. Having determined there are no outstanding requests (D R,JOB=JES2), look for ENQ problems (D GRS,ANALYZE) and WTO buffer shortages (IEA404A message). If no problems are found, DUMP the JES2 address space and determine why JES2 is not responding. Contact IBM support as appropriate.

Module: HASJCMDS

Routing Code: Routed as a command response

Descriptor Code: 5

\$HASP9154 • \$HASP9155

\$HASP9154

Explanation:

▶▶—CKPT RECONFIGURATION IN PROGRESS—▶▶

JES2 issues this notice message in response to a \$JDJES or a \$JDSTATUS monitor command. This message indicates that the JES2 is reconfiguring the checkpoint data sets and is not available for processing.

System action: Display continues.

Operator response: The JES2 address space is in the process of reconfiguring the checkpoint data sets and might be waiting for a reply to a WTOR (locally or on another member) or copying data to a new checkpoint data set. First determine if a WTOR is outstanding by issuing a D R,JOB=JES2,CN=(ALL) command to display any outstanding requests from JES2. Because the reconfiguration can be driven by any member of the MAS, route this command to all systems. See the description of any messages displayed for additional information. If no requests are outstanding it is possible that the checkpoint data is being copied to the new data set. Depending on load, this can take a few minutes. However, if the condition persists, contact your system programmer.

System programmer response: If this condition persists, JES2 might be unable to complete a reconfiguration request. Having determined there are no outstanding request (D R,JOB=JES2), look for XCF or JESXCF signalling problems. The reconfiguration dialog uses JESXCF and SCF to coordinate the reconfiguration process. If signalling is lost, that might explain the problem. Also determine if any JES2 system(s) are down but not partitioned out of the SYSPLEX. Because all members must respond to a reconfiguration request, JES2 might be waiting for a member that is no longer active. Check also for any ENQ problems (D GRS,ANALYZE) that might be blocking the JES2 address space. If you find no problems, DUMP the JES2 address space and determine why JES2 is not responding. Contact IBM support as appropriate.

Module: HASJCMDS

Routing Code: Routed as a command response

Descriptor Code: 5

\$HASP9155

Explanation:

▶▶—\$HASP9155 MEMBER IS NOT BOSS (WILL NOT RUN WLM INITS)—▶▶

JES2 issues this notice message in response to a \$JDJES or a \$JDSTATUS monitor command. This message indicates that this member is not a manager or "boss" of WLM service class queues. WLM is limited to one queue manager per MVS image.

For batch jobs, each WLM service class queue is considered a separate queue. If there are multiple members of an MAS active on a single MVS image, only one of them can manage the WLM service class queues. This implies that WLM will not start WLM managed initiators on the second JES2. Members that can run WLM initiators are considered the manager or "boss" of the work queues.

The primary subsystem is always considered the "boss", while a secondary subsystem in the same MAS is not a "boss". Secondary subsystems in a separate MAS manage a separate work queue from the primary subsystem and thus can be a manager ("boss") of their queues. Which of the secondary subsystems is the "boss" is based on the order in which the subsystems are defined.

Any system that is not a "boss" displays this message and BOSS=NO in response to the \$D MEMBER command.

System action: Display continues

Operator response: None.

System programmer response: None.

Module: HASJCMDS

Routing Code: Routed as a command response

Descriptor Code: 5

\$HASP9156

Explanation:

▶▶—ADDRESS SPACES WAITING FOR SPOOL SPACE—◀◀

JES2 issues this notice message in response to a \$JDJES or a \$JDSTATUS monitor command. This message indicates that there is at least one address space waiting for SPOOL space. This might be a normal condition that occurs as part of the SPOOL allocation cycle on your system. However, if the condition persists in combination with other symptoms, it might indicate a potential problem.

System action: Display continues.

Operator response: At least one address space is waiting for SPOOL space. If the command response indicates other problems (such as the JES2 address space is not active) then “an address spaces waiting for SPOOL space” is a result of that problem. However, if no other problems are indicated in the response and this condition persists in combination with other symptoms, there might be a problem.

First, determine if the SPOOLS are full by issuing a \$DSPOOL command. The \$HASP646 message will indicate the percent of SPOOL in use. If this is high, then freeing SPOOL space will address this condition. If there is sufficient free space, determine what address spaces are waiting for SPOOL space by issuing the D GRS,RES=(SYSZJES2,AWAITING*) command. If the address spaces appearing in the message are different each time the command is issued, then this is a performance problem caused by this member not accessing the checkpoint data set frequently enough. If the same address space is appearing in the message and that address space is not functioning properly, JES2 might have a problem allocating SPOOL space. Contact your system programmer as appropriate.

System programmer response: This message is issued if at least one address space is waiting for SPOOL space at the time of the command. Depending on the timing of the command and the allocation of SPOOL space, this might be a normal condition. This could also be a normal side effect of other problems that may be indicated in the command response.

If you suspect a performance problem, then examine the settings HOLD= and DORMANCY= on the MASDEF statement. Adjusting these settings can reduce the time address spaces wait for SPOOL space; however, this might cause delays elsewhere.

Another source of potential performance problems is your SPOOLDEF FENCE= settings and the AFFINITY= setting on your SPOOL volumes. Use of these parameters can limit the SPOOL space available to an application. This is especially true if FENCE=(ACTIVE=YES,VOLUMES=1) and you have a large number of SPOOL volumes (greater than 64). If this is the case, consider increasing the number of volumes you fence to. If you suspect a problem, collect a dump of the JES2 address space and a dump of the address space waiting for SPOOL space. If you have symptoms other than this message and are unable to determine the cause, contact the IBM Support Center.

Module: HASJCMDS

Routing Code: Routed as a command response

Descriptor Code: 5

\$HASP9157

Explanation:

▶▶—CANNOT RESTART JES2, IPL REQUIRED—◀◀

JES2 issues this notice message in response to a \$JDJES or a \$JDSTATUS monitor command. This message indicates that JES2 has terminated and cannot be restarted without IPLing the system. This occurs when JES2 suspects that the integrity of the checkpoint data has been lost which could allow multiple instances of the same job to be running on two systems. JES2 also issues this message in response to a \$PJES2,TERM command. This message is normally preceded by a \$HASP9151 JES2 ADDRESS SPACE NOT ACTIVE message.

System action: Display continues.

Operator response: To restart JES2, you must re-IPL the system.

\$HASP9158 • \$HASP9160

System programmer response: To determine why a re-IPL is required, examine SYSLOG looking for \$HASP088 messages or \$PJES2,TERM commands.

Module: HASJCMDS

Routing Code: Routed as a command response

Descriptor Code: 5

\$HASP9158

Explanation:

▶▶—JES2 PROCESSING STOPPED, \$\$ NEEDED—▶▶

JES2 issues this notice issued in response to a \$JDJES or a \$JDSTATUS monitor command. This message indicates that either:

- A \$P command was issued and a \$HASP623 message is outstanding.
- A \$PJES2 was issued and rejected and a \$HASP623 message is outstanding.
- JES2 was started with the REQ start parameter (as opposed to NOREQ) and a \$HASP400 message is outstanding. Until you issue a \$S command, JES2 cannot process any new work.

System action: Display continues.

Operator response: To allow work to be processed, issue a \$S command.

System programmer response: None.

Module: HASJCMDS

Routing Code: Routed as a command response

Descriptor Code: 5

\$HASP9159

Explanation:

▶▶—JES2 EXECUTION PROCESSING STOPPED (\$PXEQ)—▶▶

JES2 issues this notice message in response to a \$JDJES or a \$JDSTATUS monitor command. This message indicates that a \$PXEQ command has been issued and that a \$HASP222 message is outstanding. Until you issue a \$SXEQ command, JES2 cannot start any new batch jobs.

System action: Display continues.

Operator response: To allow new batch jobs to be selected, issue a \$SXEQ command.

System programmer response: None.

Module: HASJCMDS

Routing Code: Routed as a command response

Descriptor Code: 5

\$HASP9160

Explanation:

▶▶—AT LEAST ONE PCE HAS ENDED—▶▶

JES2 issues this notice message in response to a \$JDJES or a \$JDSTATUS monitor command. This message indicates that at least one JES2 PCE has ended. A PCE is ended when it encounters an ABEND from which it cannot recover. A \$HASP068 message identifies and describes the PCE that has ended. Rather than bringing JES2 down at that time, JES2 continues processing without the function provided by that PCE. You must restart JES2 to recover the PCE.

System action: Display continues.

Operator response: Determine when it is best to restart JES2 to recover the function. If SYSLOG is available, look for the \$HASP068 message that was issued when the PCE ended. You can also determine which PCEs have ended by issuing the \$DPCE(*),ENDED>0 command. When the time is appropriate to restart JES2, issue the \$PJES2,ABEND command, reply to the WTOR, and then restart JES2.

System programmer response: None.

Module: HASJCMDS

Routing Code: Routed as a command response

Descriptor Code: 5

\$HASP9161

Explanation:

▶▶—NOT ALL SPOOL VOLUMES ARE AVAILABLE—▶▶

JES2 issues this notice message in response to a \$JDJES or a \$JDSTATUS monitor command. This message indicates that at least one SPOOL volume is not active. This can be the result of a command issued to purge or halt a volume or as the result of a volume being halted because of errors on the volume. The result is that performance of active jobs might be impacted because not all SPOOL volumes are available or job and SYSOUT cannot be selected for processing because the needed SPOOL volumes are not available.

System action: Display continues.

Operator response: To determine what volumes are not available, issue the \$DSPPOOL,STATUS<>ACTIVE command. If the volume should be active, issue the \$SSPOOL(*volume*) command to start the correct volume.

System programmer response: None.

Module: HASJCMDS

Routing Code: Routed as a command response

Descriptor Code: 5

\$HASP9162

Explanation:

▶▶—PCES WAITING FOR SPOOL SPACE—▶▶

JES2 issues this notice message in response to a \$JDJES or a \$JDSTATUS monitor command. This message indicates that there is at least one PCE waiting for SPOOL space. This might be a normal condition that occurs as part of the SPOOL allocation cycle on your system. However, if the condition persists in combination with other symptoms, it might indicate a potential problem.

System action: Display continues.

Operator response: At least one PCE is waiting for SPOOL space. If the command response indicates other problems (such as checkpoint reconfiguration in progress) then a PCE waiting for SPOOL space is a result of that situation. However, if no other problems are indicated in the response and this condition persists in combination with other symptoms, this message might indicate a problem situation.

First, determine if the SPOOL volumes are full by issuing a \$DSPPOOL command. The \$HASP646 message indicates the percent of SPOOL in use. If this is high, then freeing SPOOL space will address this condition. If there is sufficient free space, determine what PCEs are waiting for SPOOL space by issuing the \$DPCE,DETAILS=WAIT command and looking for PCEs with WAIT=TRACK. If the PCEs differ each time the command is issued, then this is a performance problem caused by this member not accessing the checkpoint data set frequently enough. If the same PCE is appearing in the message and that PCE is not functioning properly, there might be a problem allocating SPOOL space. Contact your system programmer as appropriate.

System programmer response: JES2 issues this message if at least one PCE is waiting for SPOOL space at the time

\$HASP9163 • \$HASP9164

the operator issued the \$JDJES or \$JDSTATUS command. Depending on the timing of the command and the allocation of SPOOL space, this may be a normal condition. This could also be a normal side effect of other problems that might be indicated in the command response.

If you suspect a performance problem, then examine the settings HOLD= and DORMANCY= on the MASDEF statement. Adjusting these settings can reduce the time PCEs wait for SPOOL space but might cause delays elsewhere.

Another source of potential problems is the SPOOLDEF FENCE= settings and the AFFINITY= setting on your SPOOL volumes. Use of these parameters can limit the SPOOL space available to a PCE. This is especially true if FENCE=(ACTIVE=YES,VOLUMES=1) and you have a large number of SPOOL volumes (greater than 64). If this is the case, consider increasing the number of volumes within the "fence".

If you suspect a problem, obtain a dump of the JES2 address space. If you determine symptoms other than this message and are unable to determine the cause, contact the IBM Support Center.

Module: HASJCMDS

Routing Code: Routed as a command response

Descriptor Code: 5

\$HASP9163

Explanation:

▶▶—FAST SPOOL GARBAGE COLLECTION (SPOOLDEF GCRATE=FAST)—▶▶

JES2 issues this notice message in response to a \$JDJES or a \$JDSTATUS monitor command. This message indicates that fast SPOOL garbage collection is in progress as a result of the \$T SPOOLDEF,GCRATE=FAST command. Fast SPOOL garbage collection significantly increases the number of I/Os to SPOOL from the JES2 address space. This increased I/O might impact overall spool access time.

System action: Processing continues.

Operator response: None

System programmer response: Fast SPOOL garbage collection is intended to quickly free SPOOL space after certain error scenarios. When JES2 scans all SPOOL volumes, the garbage collection rate automatically reverts to its normal rate. However, if the increased I/O to SPOOL is affecting other jobs in the system you can stop the process using the \$TSPOOLDEF,GCRATE=NORMAL command. To determine the percent of SPOOL that JES2 has scanned since FAST mode was enabled, issue the command \$D SPOOLDEF,GCRATE and see the resulting \$HASP844 message.

Module: HASJCMDS

Routing Code: Routed as a command response

Descriptor Code: 5

\$HASP9164

Explanation:

▶▶—NETWORK PATH MANAGER—FUNCTIONS SUSPENDED—▶▶

JES2 issues this notice message in response to a \$JDJES or a \$JDSTATUS monitor command. The message indicates that the network path manager has failed and you might need to perform a JES2 restart to initiate any new network connections. JES2 issues a \$HASP502 before this message to indicate this condition.

System action: Processing continues.

Operator response: None

System programmer response: See the \$HASP502 message for appropriate actions.

Module: HASJCMDS

Routing Code: 1, 2, 10

Descriptor Code: 4

\$HASP9165

Explanation:

▶▶—NODE INFORMATION NOT—STORED IN CHECKPOINT—▶▶

JES2 issues this notice message in response to a \$JDJES or a \$JDSTATUS monitor command. The message indicates that node information is not currently stored in the checkpoint. It is therefore possible for mismatches in NODE definitions to exist between members of the MAS, leading to inconsistent job or SYSOUT routing.

System action: Processing continues.

Operator response: None

System programmer response: Ensure that the JES2 checkpoint is large enough to contain the NIT information, and either restart JES2 or issue a \$TNJEDEF,NODENUM= to include the NIT information in the checkpoint.

Module: HASJCMDS

Routing Code: 1, 2, 10

Descriptor Code: 4

\$HASP9166

Explanation:

▶▶—LOCAL NODE NAME—CHANGED SINCE XCF JOIN—▶▶

JES2 issues this notice message in response to a \$JDJES or a \$JDSTATUS monitor command. The message indicates that the name of the local node has changed since the last restart of JES2. If JES2 fails, it may be necessary to specify MASDEF XCFGRPNM= to rejoin the MAS as this value defaults to the local node name.

System action: Processing continues.

Operator response: None

System programmer response: If MASDEF XCFGRPNM= is not specified in your JES2 initialization deck, you might need to specify a value equal to the previous node name for failed systems to be able to re-enter the MAS.

Module: HASJCMDS

Routing Code: 1, 2, 10

Descriptor Code: 4

\$HASP9167

Explanation:

▶▶—WLM POLICY DIFFERENCE DETECTED (CLASSIFICATION STOPPED)—▶▶

JES2 issues this notice message in response to a \$JDJES or a \$JDSTATUS monitor command. The message indicates that the WLM policy identifier in the JES2 checkpoint is not the same as the current WLM policy identifier on this member. This condition is normal after a new WLM policy has been activated until that policy has been propagated to all system in a SYSPLEX. However, if this condition persists, it might indicate an error condition.

System action: This member will not classify new work that enters the MAS. No new batch jobs will continue past conversion processing.

Operator response: If this condition persists, notify your system programmer.

System programmer response: If this condition persists, collect diagnostic information (a dump of the JES2 and WLM address space) and restart this system.

\$HASP9168 • \$HASP9170

Module: HASJCMDS

Routing Code: Routed as a command response

Descriptor Code:5

\$HASP9168

Explanation:

▶▶—JES2 DUBBED BY OMVS—BUT NOT PERMANENT PROCESS—▶▶

JES2 issues this notice message in response to a \$JDJES or a \$JDSTATUS monitor command. The message indicates that JES2 has not been dubbed a permanent process by OMVS.

System action: JES2 is in a state where OMVS might terminate it with an EC6 abend if OMVS is terminated.

Operator response: Brief intervals during OMVS initialization might occur where this condition is normal. However, if the condition persists, collect diagnostic information (a dump of the JES2 address space) and restart this system.

Module: HASJCMDS

Routing Code: Routed as a command response

Descriptor Code:5

\$HASP9169

Explanation:

▶▶—MEMBER CANNOT GET CKPT LOCK (PROBABLY HELD BY ANOTHER MEMBER)—▶▶

JES2 issues this notice message in response to a \$JDJES or a \$JDSTATUS monitor command. The message indicates that JES2 is not able to access the JES2 checkpoint. This is normally caused by another member holding the checkpoint and not releasing it.

System action: Most JES2 activities, such as running jobs and printing output, require access to the JES2 checkpoint. If this condition persists, JES2 functions will eventually stop.

Operator response: Determine which JES2 member is holding the checkpoint lock by looking for HASP9207 message on other members of the MAS. (Issue a ROUTE *ALL, \$JDSTATUS if all members use \$ as the JES2 command prefix.) If a member is holding the JES2 checkpoint, perform problem determination on that member and restart JES2 if needed.

System programmer response: If this condition occurs too frequently, consider adjusting the MASDEF LOCKOUT parameter. The condition is detected when the time specified on LOCKOUT has elapsed and the checkpoint lock has not been obtained.

Module: HASJCMDS

Routing Code: Routed as a command response

Descriptor Code:5

\$HASP9170

Explanation:

▶▶—AT LEAST ONE SPOOL VOLUME HALTED DUE TO I/O ERRORS—▶▶

JES2 issues this notice message in response to a \$JDJES or a \$JDSTATUS monitor command. The message indicates that at least one SPOOL volume has been placed in halting status (or has halted) because an I/O error has occurred when JES2 attempts to access data on that volume.

System action: Display continues.

Operator response: To determine which volumes are in a halting or halted state, issue a \$DSPOOL command.

Review syslog to determine why the volume was halted (look for \$HASP630 VOLUME volume HALTING messages), and correct the cause of the I/O error. When the problem has been resolved, issue the \$S SPOOL(volume) command to return the volume to normal operations. If the problem cannot be resolved, issue the \$P SPOOL(volume), CANCEL command to delete the volume and all jobs and SYSOUT that has space on the volume.

System programmer response: None.

Module: HASJCMDS

Routing Code: Routed as a command response

Descriptor Code:5

\$HASP9171

Explanation:

▶▶—LOCAL MEMBER IS IN INDEPENDENT MODE—▶▶

JES2 issues this notice message in response to a \$JDJES or a \$JDSTATUS monitor command. This message indicates that the local JES2 member is running in independent mode. Jobs submitted by members in independent mode can only be processed on members that are in independent mode. Jobs submitted by members that are not in independent mode cannot be processed on members in independent mode.

If a job is not converting, executing, or going through output processing, it might be because the independent state of the job is not the same as the member you believe should process the job. Use the \$D JOB command to view the system affinity of the job and the \$D MEMBER command to view the independent mode of the member.

System action: Display continues.

Operator response: None

System programmer response: None

Module: HASJCMDS

Routing Code: Routed as a command response

Descriptor Code:5

\$HASP9172

Explanation:

▶▶—AT LEAST ONE OTHER MEMBER IS IN INDEPENDENT MODE—▶▶

JES2 issues this notice message in response to a \$JDJES or a \$JDSTATUS monitor command. This message indicates that at least one other JES2 member is running in independent mode. Jobs submitted by members in independent mode can only be processed on members that are in independent mode. Jobs submitted by members that are not in independent mode cannot be processed on members in independent mode.

If a job is not converting, executing, or going through output processing, it might be because the independent state of the job is not the same as the member you believe should process the job. Use the \$D JOB command to view the system affinity of the job and the \$D MEMBER command to view the independent mode of the member.

System action: Display continues.

Operator response: None

System programmer response: None

Module: HASJCMDS

Routing Code: Routed as a command response

Descriptor Code:5

\$HASP9173 • \$HASP9175

\$HASP9173

Explanation:

NJE AUTOMATIC CONNECT PROCESSING
DISABLED

JES2 issues this notice message in response to a \$JDJES or a \$JDSTATUS monitor command. The message indicates that the automatic processing of NJE connection has been disabled because of a \$P NETWORK or a \$Z NETWORK command. This implies that when an NJE connection drops, JES2 will not automatically attempt to re-establish the connection, even if CONNECT=(YES) has been specified on the NODE, APPL, LINE, or SOCKET statement.

System action: Display continues.

Operator response: As part of normal system termination, an installation might issue a \$P NETWORK command. In that case, this condition is considered normal. If this is not the case, you can enable automatic NJE connection processing by issuing a \$S NETWORK command.

System programmer response: None

Module: HASJCMDS

Routing Code: Routed as a command response

Descriptor Code:5

\$HASP9174

Explanation:

NJE AUTOMATIC RESTART PROCESSING
DISABLED

JES2 issues this notice message in response to a \$JDJES or a \$JDSTATUS monitor command. The message indicates that the automatic restart processing of NJE device has been disabled because of a \$P NETWORK or a \$Z NETWORK command. This implies that when an NJE device drains, JES2 will not automatically attempt to restart the device, even if RESTART=(YES) has been specified on the LINE, LOGON, or NETSRV statement.

System action: Display continues.

Operator response: As part of normal system termination, an installation might issue a \$P NETWORK command. In that case, this condition is considered normal. If this is not the case, you can enable automatic NJE device restart processing by issuing a \$S NETWORK command.

System programmer response: None

Module: HASJCMDS

Routing Code: Routed as a command response

Descriptor Code:5

\$HASP9175

Explanation:

NON-DEFAULT VALUES SPECIFIED FOR
DESTDEF

This is an informational message only, and not an indication of any error. JES2 issues this message in response to a \$JDJES or a \$JDSTATUS monitor command, indicating that one of the following keywords on the DESTDEF statement is not set to the default value: NDEST, RDEST, RMDEST, RMTDEST or UDEST. If any of these keywords is set to USER, \$HASP9175 is issued to indicate that a non-default setting is being used.

System action: Display continues.

Operator response: None.

System programmer response: None
Module: HASJCMDS
Routing Code: Routed as a command response
Descriptor Code:5

\$HASP9176

Explanation:

ENVIRONMENT ERRORS, RESTART JES2
 WHEN MORE BERTS AVAILABLE

JES2 issues this notice message in response to the \$JDJES or \$JDSTATUS monitor command. This message indicates that a BERT (Block Extension Reuse Table) shortage was encountered while attempting to perform an internal function.

System action: Display continues.

Operator response:

1. Increase the number of free BERTs by using one of the following methods:
 - Increase the number of BERTs for JES2 processing by using the \$T CKPTSPACE,BERTNUM=nnn command. If the number of BERTs cannot be increased because of checkpoint space, use one of the following methods:
 - Decrease the number of JOEs (\$T OUTDEF,JOENUM=nnnnn) and then try increasing the number of BERTs again.
 - Decrease the number of JQEs (\$T JOBDEF,JOBNUM=nnnn) and then try increasing the number of BERTs again.
 - Allocate a new larger checkpoint data set or structure and perform a checkpoint reconfiguration (\$T CKPTDEF,RECONFIG=YES) to begin using the new data set or structure. Then try increasing the number of BERTs again.
 - Reduce the number of jobs in the preexecution phase (refer to results of \$DN,Q=XEQ).
2. Restart JES2 after the number of free BERTs has been increased. For example, perform a JES2 hot start after a \$P JES2,ABEND command.

System programmer response: None
Module: HASJCMDS
Routing Code: Routed as a command response
Descriptor Code:5

\$HASP9177

Explanation:

JESXCF CROSS SYSTEM DATA RETRIEVAL
 INTERFACE IS NOT AVAILABLE

JES2 issues this message in response to a \$JDJES or \$JDSTATUS monitor command. The message indicates that the JESXCF interface for cross system data retrieval is unavailable on this member. This member will not be able to respond to requests for information from another JES2 MAS member for spool dataset browse or for JES Properties SSI 82 initiator information.

JES2 also issues this message to the console when the JESXCF interface for cross system data retrieval is unavailable, and attempts to recover it have been unsuccessful.

When the JESXCF interface for cross system data retrieval is unavailable, it might be due to a system configuration problem. Multiple members might have attempted to join the JESXCF group for cross system data retrieval using the same name. The MASDEF parameters XCFGRPNM and OWNMEMB might be set to the same value on more than one member.

\$HASP9178 • \$HASP9179

When the JESXCF interface for cross system data retrieval is unavailable on a member, applications making cross system data retrieval requests of that member will hang waiting for information.

System action: Display or JES2 processing continues.

Operator response: None.

System programmer response: Correct the system configuration, if necessary, and WARM start JES2.

Module: HASJCMDS or HASCSRAX

Routing Code: Routed as a command response for the JES2 notice. The console message uses routing codes 1, 2, 10, 42.

Descriptor Code: 5 as a command response for the JES2 notice. 4 for the console message.

| \$HASP9178

| **Explanation:**

| DEADLINE SCHEDULING IS NOT AVAILABLE ON THIS MEMBER

| JES2 issues this notice message in response to a \$JDJES or a \$JDSTATUS monitor command.

| This message is issued when the JES2 determines that deadline scheduling (DLS) is no longer being performed on this member, because the DLS PCE has failed. JES2 issues a \$HASP262 when this happens.

| **System action:** Processing continues.

| **Operator response:** None.

| **System programmer response:** See the \$HASP262 message for appropriate actions.

| **Module:** HASJCMDS

| **Routing Code:** 1,2,10

| **Descriptor Code:** 4

| \$HASP9179

| **Explanation:**

| JOBGROUP LOGGING SUBTASK IS NOT AVAILABLE

| JES2 issues this message when job group logging subtask fails and also in response to a \$JDJES or \$JDSTATUS monitor command. This message indicates that the subtask responsible for the job group logging function has failed and is no longer available on this member. JES2 tries to recover and to re-direct job group logging activity to other active members. If no active JES2 member is available, job group logging cannot be performed and messages intended for the job group logging datasets may be lost. To resume job group logging function, start another JES2 member or restart this JES2 member.

| **System action:** The message is written to the console. JES2 processing continues.

| **Operator response:** None.

| **System programmer response:** If JES2 is unable to find an active member to re-direct job group logging activity, start another JES2 member or restart this JES2 member. If problem persists, collect diagnostic information and contact your IBM service representative.

| **Module:** HASJCMDS or HASCSRAX

| **Routing Code:** Routed as a command response for the JES2 notice. The console message uses routing codes 1, 2, 10, 42.

| **Descriptor Code:** 5 as a command response for the JES2 notice, 4 for the console message.

\$HASP9201

Explanation:

▶▶—JES2 MAIN TASK WAIT DETECTED AT—*module+offset*—DURATION—*hh:mm:ss.xx*—PCE—*pcename*—————▶
▶—EXIT—*exit*—JOB ID—*jobid*—COMMAND—*jes2_command*—————▶▶

JES2 issue this alert message in response to a \$JDJES or a \$JDSTATUS monitor command or as a highlighted message. Based on context, this message can indicate an alert or an incident JES2 is tracking. This message indicates that the monitor has detected the main task is in an unexpected wait.

In the message text:

module+offset or *address*

Module and offset or address where the wait occurred.

hh:mm:ss.xx

The length of time the wait has lasted.

pcename

The name of the PCE in control during the wait.

exit

The exit number in control during the wait (or NONE).

jobid

Job ID or job index associated with the current PCE (or NONE).

jes2_command

If the current PCE is the command processor, the current command is being processed. If the current PCE is not the command processor, this line is not displayed.

Note: Since data used to build this message is sampled without serialization, it is possible, in rare situations, for the PCE, exit, or job information to not correspond to the address being displayed.

System action: If the condition persists, JES2 reissues this message every 30 seconds with updated information.

Operator response: Monitor alerts indicate potential reasons why JES2 is not functioning properly. If this condition persists, notify the system programmer.

System programmer response: Except for rare situations, JES2's main task should not encounter z/OS WAITs. z/OS WAITs in the main task can cause deadlocks that might impact multiple members of a MAS. Determine where the main task is waiting and why. If an exit was in control at the time of the wait, then the exit may need to be rewritten to subtask the code that causes the WAIT. Even if the message does not indicate an exit, the code might be getting control as a result of installation customization, for example, an installation—written SCAN driver command. If the source of the wait cannot be immediately determined, take a dump of the JES2 address space to help determine where and why the wait has occurred. If you determined that the wait is a result of IBM—distributed code, contact the IBM support center.

Module: HASJSPLR

Routing Code: 1,2,10,42 or as a command response

Descriptor Code: 2,7 or 5 when a command response

\$HASP9202

Explanation:

▶▶—POTENTIAL JES2 MAIN TASK LOOP DETECTED NEAR—*module+offset*—DURATION—*hh:mm:ss.xx*—————▶
▶—PCE—*pcename*—EXIT—*exit*—JOB ID—*jobid*—COMMAND—*jes2_command*—————▶▶

JES2 issues this alert message in response to a \$JDJES or a \$JDSTATUS monitor command or as a highlighted message. Based on context, this message can indicate an alert or an incident being tracked. This message indicates a potential loop condition exists in the JES2 main task. Loops cant indicate a problem or complex processing that takes a long time to complete. One way to determine if the loop is making progress is by studying the job information in the message. If it is changing over time then the loop might eventually complete. If it is not changing, it might

\$HASP9203

indicate a problem with the processing or the current job. In general, most functions in JES2 process jobs in job number order, and warm start processes jobs in job—index order.

In the message text:

module_offset or *address*

Module and offset or address near the center of the loop.

hh:mm:ss.xx

The length of time the loop has lasted.

pcename

The name of the PCE in control during the loop.

exit

The exit number in control during the loop (or NONE).

jobid

The job id or job index associated with the current PCE (or NONE).

jes2_command

If the current PCE is the command processor, the current command is being processed. If the current PCE is not the command processor, this line is not displayed.

Note: Because data used to build this message is sampled without serialization, it is possible, in rare situations, for the PCE, exit, or job information to not correspond to the address being displayed. Loop detected is limited to detecting situations where a single segment of code is constantly executing. If the loop involves code that calls a service routine or spans a large area of memory, the loop detection logic might not identify it as a loop. Instead, JES2 issues the \$HASP9203 message indicating a long PCE dispatch may be issued.

System action: If the condition persists, JES2 reissues this message every 30 seconds with updated information.

Operator response: Monitor alerts indicate potential reasons why JES2 is not functioning properly. If this condition persists and is impacting normal JES2 operations, notify your system programmer.

System programmer response: Loops can be an indication of a tuning problem, a complex process that takes a long time to complete, or an error situation. Examine the job information displayed in the messages to determine if it is being updated. If no progress is being made, you will need to abend and restart JES2.

First, capture a dump of the JES2 address space using a z/OS DUMP command. While JES2 is dumping, JES2 might delete and reissue the \$HASP9202 message. When dump processing completes, issue a \$PJES2,ABEND command followed by a \$PJES2,ABEND,FORCE command. The \$PJES2,ABEND,FORCE command is needed because the main task is in a loop. When JES2 terminates, you can then restart it. Analyze the dump to determine what code is looping and the cause of the loop. If the problem is in exit code (or exit-invoked code) correct the exit logic. If the problem is caused by IBM-distributed code, contact the IBM support center.

Module: HASJSPLR

Routing Code: 1,2,10,42 or as a command response

Descriptor Code: 2,7 or 5 when a command response

\$HASP9203

Explanation:

▶▶—LONG PCE DISPATCH—DURATION—*hh:mm:ss.xx*—PCE—*pcename*—EXIT—*exit*—JOB ID—*jobid*————▶
▶—COMMAND—*jes2_command*————▶▶

JES2 issues this alert message in response to a \$JDJES or a \$JDSTATUS monitor command or as a highlighted message. Based on context, this message can indicate an alert or an incident JES2 is tracking. This message indicates that a particular PCE has been dispatched, from a JES2 dispatcher point of view, for the duration indicated. A long PCE dispatch might indicate a problem or complex processing that is taking a long time to complete. It could also be caused by a loop that spans a large area of memory or involves calling a service in a separate module. One way to determine if the long dispatch is making progress is by studying the job information in the message. If it is changing over time then the process might eventually complete. If it is not changing, it might indicate a problem with the processing or the current job. In general, most functions in JES2 process jobs in job number order, and warm start processes jobs in job—index order.

In the message text:

hh:mm:ss.xx

The length of time the PCE has been dispatched.

pcename

The name of the PCE in control.

exit

The exit number in control (or NONE).

jobid

The job id or job index associated with current PCE (or NONE).

jes2_command

If the current PCE is the command processor, the current command is being processed. If the current PCE is not the command processor, this line is not displayed.

Note: Because data used to build this message is sampled without serialization, it is possible, in rare situations, for the PCE, exit, or job information to not correspond to the address being displayed.

System action: If the condition persists, JES2 reissues this message every 30 seconds with updated information.

Operator response: Monitor alerts indicate potential reasons why JES2 is not functioning properly. If this condition persists and is impacting normal JES2 operations, notify your system programmer.

System programmer response: Long PCE dispatches can be an indication of a tuning problem, a complex process that takes a long time to complete or an error situation. If the JES2 main task is not getting enough CPU resource, it could appear to the monitor as a loop. Use the D A,JES2 command or a performance monitor to ensure that JES2 is indeed consuming CPU. When you have eliminated CPU performance problems, check if the PCE displayed is the command processor and examine the command that was entered. Some commands can take a long time to complete, such as a command to alter all 200,000 jobs or 500,000 JOEs in the system. If progress is being made (job number displayed is being updated) for a complex command, then this might be normal processing.

First, deal with the current situations by either waiting for the command to complete or ABEND JES2 and then restarting it. When this situation has been addressed, consider entering multiple commands with job ranges, for example \$PJQ(1-20000), \$PJQ(20001-40000), and so forth). As each command completes, JES2 can perform other processes preventing JES2 from being able to process other requests.

If the problem is not a complex command, determine if progress is being made by examining the job ID in the message. If no progress is being made, there might be a problem. First, issuing the z/OS MVS DUMP command to capture a dump of the JES2 address space. Then issue a \$PJES2,ABEND command followed by a \$PJES2,ABEND,FORCE command to terminate JES2. When JES2 terminates, you can then restart it. Analyze the dump to determine what code is running and the cause of the long dispatch. If the problem is in exit code, or exit-invoked code, correct the exit logic. Some logic, for example, that performs adequately when there were only 20,000 jobs in the job queue might have problems with 200,000 jobs. If the problem is caused by IBM-distributed code, contact the IBM support center.

Module: HASJSPLR

Routing Code: 1,2,10,42 or as a command response

Descriptor Code: 2,7 or 5 when a command response

\$HASP9204

Explanation:

▶▶—JES2 MAIN TASK BUSY—DURATION—*hh:mm:ss.xx*—PCE—*pcename*—EXIT—*exit*—JOB ID—*jobid*————▶
▶—COMMAND—*jes2_command*————▶▶

JES2 issue this alert message in response to a \$JDJES or a \$JDSTATUS monitor command or as a highlighted message. Based on context, this message can indicate an alert or an incident JES2 is tracking. This message indicates that the main task has not entered its normal MVS wait for the duration specified. This can be caused by a number of situations:

- A multi-PCE loop in which one PCE completes processing, posts a second PCE and waits. When the second PCE gets control, it does some work, posts the first PCE and waits. First PCE posts second, and so forth.

\$HASP9205

- Recurring problems getting basic resources such as the local lock or storage. Often other items are tracked but other alerts are not issued because the resource problems only last a second at a time. Issuing a \$JDJES command and looking at incidents being tracked can help you identify what is happening.
- Normal processing in a very busy NJE/RJE environment. If this is impacting other functions, you might study your networking parameters to determine if tuning them could reduce JES2 overhead. For more information on tuning JES2 networking see *z/OS JES2 Initialization and Tuning Guide*.

In the message text:

hh:mm:ss.xx

The length of time the main task has been running without entering its normal MVS wait.

pccname

The name of the PCE in control.

exit

The exit number in control (or NONE).

jobid

The job ID or job index associated with current PCE (or NONE).

jes2_command

If the current PCE is the command processor, the current command is being processed. If the current PCE is not the command processor, this line is not displayed.

Note: Because data used to build this message is sampled without serialization, it is possible, in rare situation, for the PCE, exit, or job information to not correspond to the address being displayed.

System action: If condition persists, JES2 reissues this message every 30 seconds with updated information.

Operator response: Monitor alerts indicate potential reasons why JES2 is not functioning properly. If this condition persists, notify the system programmer.

System programmer response: Use the \$JDDetails command to examine the distribution of samples in the JES2 sampling statistics. If most samples are in the ACTIVE and IDLE categories, the problem is that JES2 is busy processing work or is unable to get CPU resources. If JES2's main task is ready to run but cannot get the CPU, because of tuning problems, the samples appear as ACTIVE. Determine if this is a CPU problem by issuing the D A,JES2 command or a analyze performance monitor statistics to determine if JES2 is consuming CPU resources. If JES2 is not, this is a tuning problem.

If this is not a tuning problem, it could be a multi-PCE loop. If a large percentage of samples are not ACTIVE or IDLE, JES2 is being delayed in attempting to process normal requests. These delays are increasing the amount of time it takes JES2 to complete processing of normal requests to the point that a backlog might be building. Issue the \$JDJES command a number of times looking for incidents JES2 is tracking. Tracking messages can help to identify the cause of the problem. If the problem persists and is impacting your system, capture a dump of the JES2 address space and analyze the JES2 dispatcher TRACE to determine what PCEs are being dispatched and the processing they are performing. Restarting JES2 might clear the situation. If after diagnosis, you determine the problem is caused by IBM-distributed code, contact the IBM support center.

Module: HASJSPLR

Routing Code: 1,2,10,42 or as a command response

Descriptor Code: 2,7 or 5 when a command response

\$HASP9205

Explanation:

▶▶—PCE WAITING FOR BERT LOCK—DURATION—*hh:mm:ss.xx*—PCE—*pccname*—EXIT—*exit*—JOB ID—*jobid*—▶▶
▶—COMMAND—*jes2_command*—MEMBER CANNOT GET CKPT LOCK (PROBABLY HELD BY ANOTHER MEMBER)—▶▶

JES2 issues this alert message in response to a \$JDJES or a \$JDSTATUS monitor command or as a highlighted message. Based on context, this message can indicate an alert or an incident that JES2 is tracking. This message indicates that a PCE is unable to continue processing because it cannot obtain the BERT lock for a job that it is processing. The message contains the job ID of the job whose lock is unavailable. JES2 only issues this message when

a PCE has stopped processing jobs because a BERT lock is not available. If a job is not selected for processing because a BERT lock is held, this message is not displayed.

If the optional text "MEMBER CANNOT GET CKPT LOCK" is displayed, the probable reason why the BERT lock cannot be obtained is that the checkpoint lock is held by another member. To determine which JES2 member is holding the checkpoint lock, look for HASP9207 message on other members of the MAS. (Issue a ROUTE *ALL,\$JDSTATUS if all members use \$ as the JES2 command prefix.) If a member is holding the JES2 checkpoint, perform problem determination on that member and restart JES2 if needed.

In the message text:

hh:mm:ss.xx

The length of time the PCE has been waiting for the BERT lock.

pccname

The name of the PCE waiting.

exit

The exit number in control (or NONE).

jobid

The job ID whose lock is being requested.

jes2_command

If the current PCE is the command processor, the current command is being processed. If the current PCE is not the command processor, this line is not displayed.

System action: If condition persists, JES2 reissues this message every 2 minutes.

Operator response: Monitor alerts indicate potential reasons why JES2 is not functioning properly. If this condition persists, notify your system programmer.

System programmer response: Issue the \$DJQ(job#) command to determine what process is holding the BERT lock and on what member and by what process the lock is being held. The BERT lock holder information is displayed in the STATUS= keyword. **ALL diagnosis must be done on the member that holds the lock.** Dumps of the member that issues this message will most likely of limited value. Issue the \$DPCE(*pccname*), DETAILS=JOBID=*jobid* command to determine why the lock is not being released for the PCE that holds the lock. It is possible that the PCE that holds the lock has ended. In that case, JES2 should release the lock within approximately one minute.

Determine where the PCE is waiting. If in an exit module, verify the logic in that module. A dump of the member which is holding the lock might be needed to determine why the lock has not been released. Possibly the JES2 member that holds the lock is not functioning and needs to be restarted. If this is the case, restart JES2 on the member that holds the lock. Further checking into the PCE that is waiting for the lock might also be required. Because PCEs should not wait for BERT locks except in rare situations, examine the \$HASP9205 message for an exit number. If there is an exit number present, examine the exit to determine if it can wait for a BERT lock, either directly or by calling a service that gets the BERT lock with WAIT=YES. Then determine if that is appropriate processing or if the exit should bypass jobs that are locked.

Module: HASJSPLR

Routing Code: 1,2,10,42 or as a command response

Descriptor Code: 2,7 or 5 when a command response

\$HASP9206

Explanation:

▶▶—PCE WAITING FOR JOB LOCK—DURATION—*hh:mm:ss.xx*—PCE—*pccname*—EXIT—*exit*—JOB ID—*jobid*————▶▶

▶—COMMAND—*jes2_command*—MEMBER CANNOT GET CKPT LOCK (PROBABLY HELD BY ANOTHER MEMBER)————▶▶

JES2 issue this alert message in response to a \$JDJES or a \$JDSTATUS monitor command or as a highlighted message. Based on context, this message can indicate an alert or an incident JES2 is tracking. This message indicates that a PCE is unable to continue processing because it cannot obtain the job lock for a job it is processing. The message contains the job ID of the job whose lock is unavailable. JES2 only issues this message when a PCE has stopped processing jobs because a job lock is not available. If a job is not selected for processing because a job lock is held, then this message is not displayed.

If the optional text "MEMBER CANNOT GET CKPT LOCK" is displayed, the probable reason why the job lock cannot be obtained is that the checkpoint lock is held by another member. To determine which JES2 member is

\$HASP9207

holding the checkpoint lock, look for HASP9207 message on other members of the MAS. (Issue a ROUTE *ALL,\$JDSTATUS if all members use \$ as the JES2 command prefix.) If a member is holding the JES2 checkpoint, perform problem determination on that member and restart JES2 if needed.

Under normal processing, jobs that are job locked are not selected for processing. This prevents a problem with one job from impacting the processing performed by a PCE. However, there are normal situations where a PCE has started processing for a job and cannot proceed until the job lock is available. This includes conversation processing. In all situations, the first aspect you need to address is the lock holder not the lock "waiter". To determine what PCE holds the job lock, issue the command \$DPCE(*),DETAILS=JOBID=*jobid* command with the JOBID indicated in this message on the member that holds the lock. You might need to router this command to all members to locate the member owning the lock. In response, the \$HASP9206 message will indicate the PCE and the PCE that holds the lock.

In the message text:

hh:mm:ss.xx

The length of time the PCE has been waiting for the JOB lock.

pcename

The name of the PCE waiting.

exit

The exit number in control (or NONE).

jobid

The job id or job index whose lock is being requested.

jes2_command

If the current PCE is the command processor, the current command is being processed. If the current PCE is not the command processor, this line is not displayed.

System action: If the condition persists, JES2 reissues this message every 2 minutes.

Operator response: Monitor alerts indicate potential reasons why JES2 is not functioning properly. If this condition persists, notify your system programmer.

System programmer response: Issue the \$DPCE(*),DETAILS=JOBID=*jobid* command to determine what process is holding the JOB lock. **You must perform your diagnosis on the member that holds the lock.** Dumps of the member that issues this message will most likely be of limited value. Determine why the lock is not being released by examining the output from the \$DPCE command. It is possible that the PCE that holds the lock has ended. In that case, JES2 should release the lock within approximately one minute. Determine where the PCE is waiting. If in an exit module, verify the logic in that module. A dump of the member which is holding the lock might be needed to determine why the lock has not been released. It could be that the JES2 member that holds the lock is not functioning and needs to be restarted. If this is the case, restart JES2 on the member that holds the lock. Further examination of the PCE that is waiting for the lock might also be required. Because PCEs should not wait for job locks except under rare situations, examine the \$HASP9205 message for an exit number. If there is an exit number present, examine the exit to determine if it is appropriate to wait for a job lock, either directly or by calling a service that gets the job lock with WAIT=YES, or if the exit should bypass jobs that are locked.

Module: HASJSPLR

Routing Code: 1,2,10,42 or as a command response

Descriptor Code: 2,7 or 5 when a command response

\$HASP9207

Explanation:

▶▶—JES CHECKPOINT LOCK HELD—DURATION—*hh:mm:ss.xx*—▶▶

JES2 issues this alert message in response to a \$JDJES or a \$JDSTATUS monitor command or as a highlighted message. Based on context, this message can indicate an alert or an incident JES2 is tracking. This message is issued when the checkpoint data set has been held for significantly longer than was specified on the MASDEF HOLD= statement. The alert is issued in conjunction with other alerts to inform the operator of the multi-system aspect of this problem. If this member is holding the checkpoint lock, other members of the JES2 MAS cannot process JES2 requests. If this message appears without any other alerts, it might indicate a checkpoint problem. Issue the \$DPCE(CKPT),DETAILS command to display what the checkpoint PCE is doing.

In the message text:

hh:mm:ss.xx

The length of time this member has held the checkpoint data set lock.

System action: If the condition persists, JES2 reissues this message every 30 seconds.

Operator response: Monitor alerts indicate potential reasons why JES2 is not functioning properly. This message indicates that a problem exists that might impact all member of your MAS. Unless this message appears without any other monitor alerts, this message addresses the impact of a problem rather than the problem itself. If this condition persists, notify the system programmer.

System programmer response: This message indicates the multi-member nature of another problem that exists. However, if this message appears without any other monitor alerts, it might indicate one of the following problems:

- A potential problem with the JES2 checkpoint PCE. Issue a \$DPCE(CKPT),DETAILS command to determine where the checkpoint PCE is waiting. If the PCE is not being dispatched, for example, wait time not advancing, this is the cause of the problem. If the wait is in exit code, review your exit code. If the wait is in IBM –distributed code, request a dump of the JES2 member issuing the message and contact the IBM support center.
- A problem with the checkpoint data set. Consider issuing a \$TCKPTDEF, RECONFIG=YES command to re-configure the checkpoint and use a different checkpoint data set. For more information about this command, see *z/OS JES2 Initialization and Tuning Guide* and *z/OS JES2 Commands*.

Module: HASJSPLR

Routing Code: 1,2,10,42 or as a command response

Descriptor Code: 2,7 or 5 when a command response

\$HASP9208

Explanation:

▶▶—JES2 MAIN TASK LOCAL LOCK WAIT AT—*module+offset*—DURATION—*hh:mm:ss.xx*—PCE—*pcename*————▶▶

▶—EXIT—*exit*—JOB ID—*jobid*—COMMAND—*jes2_command*————▶

JES2 issues this alert message in response to a \$JDJES or a \$JDSTATUS monitor command or as a highlighted message. Based on context, this message can indicate an alert or an incident JES2 is tracking. This message indicates that the JES2 main task has been waiting for the z/OS local lock for the duration specified. The z/OS local lock should be a short–duration lock held while performing critical z/OS functions. If the lock cannot be obtained, there is a problem in the address space.

In the message text:

module+offset or *address*

Module and offset or address where the main task was suspended waiting for the local lock.

hh:mm:ss.xx

The length of time the main task was waiting for the local lock.

pcename

The name of the PCE in control during the wait.

exit

The exit number in control during the wait (or NONE).

jobid

The job id or job index associated with the current PCE (or NONE).

jes2_command

If the current PCE is the command processor, the current command is being processed. If the current PCE is not the command processor, this line is not displayed.

Note: Because data used to build this message is sampled without serialization, it is possible, in rare situations, for the PCE, exit, or job information to not correspond to the address being displayed.

System action: If the condition persists, JES2 reissues this message every 30 seconds with updated information.

Operator response: Monitor alerts indicate potential reasons why JES2 is not functioning properly. If this condition persists, notify your system programmer.

System programmer response: Obtain a dump of the JES2 address space. Determine what process owns the local

\$HASP9209

lock and why it is not being released. Some common causes include:

- Storage fragmentation resulting in long periods in MVS GETMAIN or STORAGE services attempting to locate free storage to satisfy the request. This is often caused by storage-free requests freeing less storage than was obtained.
- Delays resolving a page fault because the page data set could not be accessed, for example, reserved by another member of the SYSPLEX or I/O contention with a non-page data set.

Module: HASJSPLR

Routing Code: 1,2,10,42 or as a command response

Descriptor Code: 2,7 or 5 when a command response

\$HASP9209

Explanation:

```
▶▶—JES2 MAIN TASK NON-DISPATCHABLE AT—module+offset—DURATION—hh:mm:ss.xx—————▶▶
▶—DURATION—hh:mm:ss.xx—PCE—pcename—EXIT—exit—JOB ID—jobid—COMMAND—jes2_command————▶▶
```

JES2 issues this alert message in response to a \$JDJES or a \$JDSTATUS monitor command or as a highlighted message. Based on context, this message can indicate an alert or an incident JES2 is tracking. This message indicates that the main task has not been dispatchable for the duration indicated. This can be caused by when dumping the JES2 address space. This might also be caused by a subtask marking the main task non-dispatchable, often because of a STEP-MUST-COMPLETE ENQ.

In the message text:

module+offset or *address*

Module and offset or address where the main task was made non-dispatchable.

hh:mm:ss.xx

The length of time the main task was non-dispatchable.

pcename

The name of the PCE in control during the wait.

exit

The exit number in control during the wait (or NONE).

jobid

The job id or job index associated with the current PCE (or NONE).

jes2_command

If the current PCE is the command processor, the current command is being processed. If the current PCE is not the command processor, this line is not displayed.

Note: Because data used to build this message is sampled without serialization, it is possible, in rare situations, for the PCE, exit, or job information to not correspond to the address being displayed.

System action: If the condition persists, JES2 reissues this message every 30 seconds with updated information.

Operator response: Monitor alerts indicate potential reasons why JES2 is not functioning properly. If this condition persists, notify your system programmer.

System programmer response: If there is a dump in progress, this is normal processing. If there is no dump in progress, look for ENQs held by the JES2 address space or general ENQ contention using the D GRS,C and D GRS,ANALYZE commands. Look for subtasks in the JES2 address spaces that might be waiting for ENQs. Attempt to obtain a dump of the JES2 and GRS address spaces using the z/OS DUMP command. Depending on the situation, a dump of JES2 might not be possible and a stand-alone dump might be needed. Examine the main task TCB to determine why it is not dispatchable. Examine subtasks to determine if they are the cause of the non-dispatchability. One cause of problems in this area has been subtasked exits that obtain a STEP-MUST-COMPLETE ENQ as a result of requests to the security product to update security data. When the ENQ is issued, the main task stops which can create, in some cases, a deadlock situation. If the problem persists and appears to be in IBM-distributed JES2 code, contact the IBM support center.

Module: HASJSPLR

Routing Code: 1,2,10,42 or as a command response

Descriptor Code: 2,7 or 5 when a command response

\$HASP9210

Explanation:

▶▶—JES MAIN TASK PAGING WAIT AT—*module+offset*—DURATION—*hh:mm:ss.xx*—PCE—*pcename*—EXIT—*exit*—▶▶
 ▶—JOB ID—*jobid*—COMMAND—*jes2_command*—▶▶

JES2 issues this alert message in response to a \$JDJES or a \$JDSTATUS monitor command or as a highlighted message. Based on context, this message can indicate an alert or an incident JES2 is tracking. This message indicates JES2 has been trying to resolve a page fault for the duration specified. There are many reasons for this, not all are related to paging but rather to locking problems.

In the message text:

module+offset or *address*

Module and offset or address where the paging wait occurred.

hh:mm:ss.xx

The length of time the wait has lasted.

pcename

The name of the PCE in control during the wait.

exit

The exit number in control during the wait (or NONE).

jobid

The job ID or job index associated with the current PCE (or NONE).

jes2_command

If the current PCE is the command processor, the current command is being processed. If the current PCE is not the command processor, this line is not displayed.

Note: Because data used to build this message is sampled without serialization, it is possible, in rare situations, for the PCE, exit, or job information to not correspond to the address being displayed.

System action: If the condition persists, JES2 reissues this message every 30 seconds with updated information.

Operator response: Monitor alerts indicate potential reasons why JES2 is not functioning properly. If this condition persists, notify your system programmer.

System programmer response: Ensure that there are no problems with the paging data sets, real frames shortages, or any of the storage management components and their setting. Examine tuning parameters related to these areas. If you cannot determine the cause, request dumps of the JES2 and master address spaces, ASID 3 and DSPNAME=(1,IARPFT) and contact the IBM support center.

Module: HASJSPLR

Routing Code: 1,2,10,42 or as a command response

Descriptor Code: 2,7 or 5 when a command response

\$HASP9211

Explanation:

▶▶—JES MAIN TASK NOT RUNNING—DURATION—*hh:mm:ss.xx*—▶▶

JES2 issues this message in response to a \$JDJES or a \$JDSTATUS monitor command or as a highlighted message. Based on context, this message can indicate an alert or an incident JES2 is tracking. This message is issued when the JES2 main task has been waiting at its normal wait for the duration specified. There are indicators that the main task does have work to do and should be running, but it is not.

In the message text:

hh:mm:ss.xx

The length of time the main task has been waiting at its normal z/OS wait.

\$HASP9212 • \$HASP9213

System action: If the condition persists, JES2 reissues this message every 30 seconds with updated information.

Operator response: Monitor alerts indicate potential reasons why JES2 is not functioning properly. If this condition persists, notify your system programmer.

System programmer response: JES2's main task might not be running because of improper tuning of MVS parameters or because of a problem in the JES2 address space. If the condition persists, investigate tuning and operational considerations first. For example, consider if online applications have been tuned to run before JES2 (not a recommended practice), or if the operator has issued a command that requires heavy use of system resources.

If the condition persists after investigating a tuning or operational issue, obtain a dump of the JES2 address space and determine why the JES2 main task is not being dispatched. Common problems include the following:

- A service or an exit has reset the main task STIMER so that the main task is not "waking up."
- A POST SRB is unable to run because the local lock is not available. Determine which function is holding the local lock and why.

If the problems appear to be in IBM-distributed code, contact the IBM support center. Restarting JES2 might correct the problem, however, if the condition is a result of tuning, attempting to restart JES2 can aggravate the condition.

Module: HASJSPLR

Routing Code: 1,2,10,42 or as a command response

Descriptor Code: 2,7 or 5 when a command response

\$HASP9212

Explanation:

▶▶—MVS NOT DISPATCHING—JES2 MAIN TASK DURATION—*hh:mm:ss.xx*————▶▶

This is an alert message which is issued in response to a \$JDJES or a \$JDSTATUS JES2 monitor command or as a highlighted message. Based on context, this message may indicate an alert or an incident being tracked. This message is issued when the JES2 main task has not been dispatched by MVS for a long period of time.

With this message, all indicators show that JES2 should be running but it has not used any CPU resource (in contrast to \$HASP9211 where JES2 is waiting at its normal MVS wait for work).

In the message text:

hh:mm:ss.xx

The length of time since the main task last received any CPU resource.

System action: If the condition persists, JES2 reissues this message every 30 seconds with updated information.

Operator response: Monitor alerts indicate potential reasons why JES2 is not functioning properly. If this condition persists, notify your system programmer.

System programmer response: Most likely the JES2 main task is not being dispatched by MVS is because there is higher priority work in the system that is using all available CPU resources. Either the other work in the system is consuming more CPU resources than it should (for example, the system is in a loop), or the priority assigned to the JES2 address space is too low. Determine which processes are using all the available CPU resources and either stop that work or raise the priority of the JES2 address space. Note that restarting JES2 does not solve the problem and might not be possible in this situation.

Module: HASJSPLR

Routing Code: 1,2,10,42 or as a command response

Descriptor Code: 2,7 or 5 when a command response

\$HASP9213

Explanation:

▶▶—LONG JES2 COMMAND PROCESSING—JES2 MAIN TASK DURATION—*hh:mm:ss.xx*—PCE—*pcname*—EXIT—*exit*————▶▶

▶JOB ID—*jobid*—COMMAND—*jes2_command*—MEMBER CANNOT GET CKPT LOCK (PROBABLY HELD BY ANOTHER MEMBER)————▶

This is an alert message that is issued in response to a \$JDJES or a \$JDSTATUS JES2 monitor command or as a highlighted message. Based on context, this message might indicate an alert or an incident being tracked. This message is issued when the JES2 command processor has been processing a single command for a long period of time.

In the message text:

lh:mm:ss.xx

The length of time that the wait has lasted.

pcename

The name of the PCE in control during the wait.

exit

The exit number in control during the wait (or NONE).

jobid

The job ID or job index associated with the current PCE (or NONE).

jes2_command

If the current PCE is the command processor, the current command is being processed. If the current PCE is not the command processor, this line is not displayed.

Note: Because data used to build this message is sampled without serialization, it is possible, in rare situations, for the PCE, exit, or job information not to correspond to the address being displayed.

System action: If the condition persists, JES2 reissues this message every 30 seconds with updated information.

Operator response: Monitor alerts indicate potential reasons why JES2 is not functioning properly. If the optional "MEMBER CANNOT GET CKPT LOCK" text is displayed, the probable reason that commands are not being executed is that the checkpoint lock is held by another member. To determine which member is holding the checkpoint lock, look for the HASP9207 message on other members of the MAS (issue a ROUTE *ALL,\$JDSTATUS if all members use \$ as the JES2 command prefix). If a member is holding the JES2 checkpoint, perform problem determination on that member and restart JES2 if needed. If this condition persists, notify your system programmer.

System programmer response: Perform processing recommended for the HASP9207 message on the member that is holding the checkpoint lock.

Module: HASJSPLR

Routing Code: 1,2,10,42 or as a command response

Descriptor Code: 2,7 or 5 when a command response

\$HASP9250

Explanation:

▶▶RESOURCE— *resource*—UTILIZATION IS AT—*nnn.nn%*————▶▶

JES2 issues this notice message in response to a \$JDJES or a \$JDSTATUS monitor command. The message indicates that the listed resource is above the warning threshold.

In the message text:

resource The name of the resource involved.

nnn.nn%

The current utilization of the resource.

System action: Processing continues.

Operator response: Perform the actions listed for the specific resource in the \$HASP050 message.

System programmer response: Perform the actions listed for the specific resource in the \$HASP050 message.

Module: HASJCMDS

Routing Code: Routed as a command response

Descriptor Code: 5

\$HASP9301 • \$HASP9302

\$HASP9301

Explanation:

▶▶—JES2 MAIN TASK ALERTS CLEARED—▶▶

JES2 issue this message when it also issued a main task alert (\$HASP9201, \$HASP9202, \$HASP9203, \$HASP9204, \$HASP9208, \$HASP9209, \$HASP9210, and \$HASP9211) and JES2 is no longer tracking any main task incidents no are there any main task alerts. Even if all the main task alert messages have been deleted, JES2 will not issue the \$HASP9301 message if it is still tracking any main task incidents.

System action: Continues normal processing

Operator response: None.

System programmer response: None.

Module: HASJSPLR

Routing Code: 2,10,42

Descriptor Code: 4

\$HASP9302

Explanation:

▶▶—JES2 CHECKPOINT LOCK RELEASED—▶▶

JES2 issues this message when a “checkpoint lock held”condition indicated by a \$HASP9207 alert has been cleared.

System action: Continues normal processing

Operator response: None.

System programmer response: None.

Module: HASJSPLR

Routing Code: 2,10,42

Descriptor Code: 4

Chapter 19. Health Check messages

The following messages contain Health Check information.

\$HASPH022E

Explanation:

| ►►—JES2 address space *jesname*—can activate checkpoint mode z22.—————►◀

| Health check IBMJES2,JES2_Upgrade_CKPT_Level detected that all requirements for activating to checkpoint mode
| z22 have been satisfied. The checkpoints are large enough. CYL_MANAGED support is activated and all MAS
| members are at z/OS release 2.2.

In the message text:

jesname The name of the JES2 address space.

| **System action:** JES2 will continue to run with checkpoint mode z11.

Operator response: Report this message to your system programmer.

| **System programmer response:** Determine if activating to the latest checkpoint mode is appropriate for your system
| installation. If so, you can successfully issue the \$ACTIVATE,LEVEL=z22 command at this time. For more
| information on activating to the latest checkpoint mode, see z/OS JES2 Commands.

Module: HASJRCHK

Routing Code: N/A

Descriptor Code: 12

\$HASPH023I

Explanation:

| ►►—JES2 address space *jesname*—requires an additional *reccnt*—4K records for *ckptname*.—————►◀

| The specified checkpoint does not have enough space for the activation of checkpoint mode z22. Additional 4K
| records are required.

In the message text:

jesname The name of the JES2 address space.

reccnt The number of additional 4K records required.

ckptname

The name of the checkpoint.

| **System action:** JES2 will continue to run with checkpoint mode z11.

Operator response: Report this message to your system programmer.

| **System programmer response:** Before you can successfully activate to checkpoint mode z22, the size of the JES2
| checkpoint needs to be increased. For more information on checkpoint reconfiguration, see z/OS JES2 Commands and
| z/OS JES2 Initialization and Tuning Guide.

Module: HASJRCHK

Routing Code: N/A

Descriptor Code: 12

\$HASP024I • \$HASP026I

\$HASP024I

Explanation:

▶▶—JES2 address space *jesname*—requires an additional *bertcnt* BERTs.————▶▶

| There are not enough BERTs available for the activation of checkpoint mode z22, Additional BERTs need to be
| created.

In the message text:

jesname The name of the JES2 address space.

bertcnt The number of additional BERTs required.

| **System action:** JES2 will continue to run with checkpoint mode z11.

Operator response: Report this message to your system programmer.

| **System programmer response:** Before you can successfully activate to checkpoint mode z22, additional BERTs need
| to be created.

Module: HASJRCHK

Routing Code: N/A

Descriptor Code: 12

\$HASP025I

Explanation:

| ▶▶—JES2 address space *jesname*—requires the activation of CYL_MANAGED support.————▶▶

| CYL_MANAGED support has not been activated. Activating to checkpoint mode z22 requires that CYL_MANAGED
| support is activated.

In the message text:

jesname The name of the JES2 address space.

| **System action:** JES2 will continue to run with checkpoint mode z11.

Operator response: Report this message to your system programmer.

| **System programmer response:** Before you can successfully activate to checkpoint mode z22, you must activate
| CYL_MANAGED support.

Module: HASJRCHK

Routing Code: N/A

Descriptor Code: 12

\$HASP026I

Explanation:

| ▶▶—JES2 address space *jesname*—detected that one or more MAS members—are not at z/OS release 2.2.————▶▶

| Activating to checkpoint mode z22 requires that all members of the MAS are at z/OS release 2.2.

In the message text:

jesname The name of the JES2 address space.

| **System action:** JES2 will continue to run with checkpoint mode z11.

Operator response: Report this message to your system programmer.

| **System programmer response:** Before you can successfully activate to checkpoint mode z22, each member in the MAS must be upgraded to z/OS release 2.2.

Module: HASJRCHK

Routing Code: N/A

Descriptor Code: 12

\$HASP027I

Explanation:

| ►►—JES2 address space *jesname*—is using checkpoint mode z22.—————►►

| This message indicates that the activation to checkpoint mode z22 has successfully completed.
In the message text:

jesname The name of the JES2 address space.

| **System action:** JES2 will continue to run with checkpoint mode z22.

Operator response: N/A

System programmer response: N/A

Module: HASJRCHK

Routing Code: N/A

Descriptor Code: N/A

\$HASP028E

Explanation:

| ►►—JES2 address space *jesname*—can not activate checkpoint mode z22.—————►►

| Health check IBMJES2,JES2_Upgrade_CKPT_Level detected that one or more requirements for activating to checkpoint mode z22 have not been satisfied. See the additional health checker messages to determine the specific requirements that have not been satisfied.

In the message text:

jesname The name of the JES2 address space.

| **System action:** JES2 will continue to run with checkpoint mode z11.

Operator response: Report this message to your system programmer.

| **System programmer response:** Determine whether activating to the latest checkpoint mode is appropriate for your system installation. If so, you should make the necessary changes before attempting to activate to checkpoint mode z22. For more information on activating to the latest checkpoint mode, see *z/OS JES2 Commands*.

Module: HASJRCHK

Routing Code: N/A

Descriptor Code: 12

\$HASP029E

Explanation:

| ►►—JES2 address space *jesname*—has an extreme BERT shortage.—————►►

JES2 has an extreme shortage of BERT resources. JES2 is in an unstable state and should be restarted as soon as more BERTs can be made available.

\$HASP030E

In the message text:

jesname The name of the JES2 address space.

| **System action:** JES2 will continue to run with checkpoint mode it is currently in (z11 or z22).

Operator response: Report this message to your system programmer.

| **System programmer response:** Before you can successfully change the checkpoint mode, you must eliminate the extreme BERT shortage condition.

Module: HASJRCHK

Routing Code: N/A

Descriptor Code: 12

\$HASP030E

Explanation:

▶▶—JES2 address space *jesname*—detected a JOB/Output Queue error.—————▶▶

| An internal error has been detected in the JES2 Job or Output queue. This error could result in various errors in processing jobs or output. At least one member of the JES2 MAS must be restarted (hot started) to correct the error. This condition will prevent the changing of the current JES2 checkpoint mode. More information can be obtained about this problem by running the \$DACTIVATE command.

In the message text:

jesname The name of the JES2 address space.

| **System action:** JES2 will continue to run with checkpoint mode it is currently in (z11 or z22).

Operator response: Report this message to your system programmer.

| **System programmer response:** Before you can successfully change the current checkpoint mode, you must eliminate the Job or Output Queue error condition. This can be done by restarting (hot starting) any member of the MAS.

Module: HASJRCHK

Routing Code: N/A

Descriptor Code: N/A

Appendix A. PCE list

The \$HASP069 message provides an indication that JES2 is running in a "partial recovery status" mode. When a "not required" PCE fails, JES2 still processes work. That is, upon recovery, JES2 has lost functions associated with PCE processing. When a "required" PCE fails, JES2 fails and terminates.

Contact the system programmer to determine if continued processing is acceptable at an installation level and then diagnose the problem. The following table contains a list of PCEs, their names, whether they are required, and a description of their function.

PCE Description/Name	Required (Yes or No)	Function
Acquire Lock and Initiate Cleanup Executor (ALICE)	N	This PCE is responsible for finishing warmstart for individual jobs which failed to be recovered during normal warmstart processing because of BERT lock or BERT shortage conditions. If this PCE is ended, then these jobs will not be warmstarted on this member. If there are other members, then the ALICE PCE on those members will perform the function.
ARM Support Processor (RESTART)	N	This PCE is responsible for handling Automatic Restart Management (ARM) requests from other address spaces. These requests are handled synchronously by the JES2 address space. If the ARM PCE is ended, jobs that use ARM may hang in ARM registration/deregistration.
ASYN I/O Processor (ASYN)	Y	This PCE handles I/O completions for SPOOL, unit record devices, and BSC lines.
BERT Lock Post Processor (BERTLOCK)	N	This PCE handles requests for jobs that are currently locked. If one PCE of this type is ended, then the other PCEs will pick up the work of that PCE. There should be minimal impact to performance. If all PCEs of this type are terminated, then work in the SYSPLEX may hang.
Checkpoint Processor (CKPT)	Y	This PCE performs all I/O to the checkpoint data set. It is also responsible for the checkpoint reconfiguration process.
Command Processor (COMM)	Y	This PCE handles all JES2 commands for this member.
Distributed Available Work Notification Processor (DAWN)	N	This PCE performs the appropriate \$#POSTing of all jobs that have space allocated to the spool volume being started. JES2 might not pick up output on a volume that is started for processing. A \$S command or a \$S dev command causes output to be selected.
Deadline Scheduling Processor (DLS)	N	This PCE is responsible for deadline scheduling functions (HOLDUNTL and STARTBY). One member in MAS is designated to perform most of this processing. This member is indicated by message HASP261. PCEs of this type on other members perform a limited local function. If this PCE is ended, then DLS PCE on another member will take over the function.

PCE Description/Name	Required (Yes or No)	Function
Elapsed Time Monitor (TIME)	N	This PCE is responsible for monitoring the execution time for jobs and issuing the \$HASP308 message if the estimated time is exceeded. If this PCE is ended, then the \$HASP308 message is never issued.
End of Memory Processor (EOM)	N	This PCE is responsible for freeing resources associated with jobs that do not terminate normally and still own JES2 resources at the end of memory. If all PCEs of this type are ended, then these jobs will remain in execution, from a JES2 perspective, and JES2 resources held by these jobs will not be released.
ENF Listen Processor (ENF)	N	This PCE listens for ENFs from WLM to indicate a change in scheduling environment, WLM policy activation, and MVS service class resets. If this PCE is ended, then JES2 will be unaware of any policy activations and scheduling environment changes. This could cause jobs to hang on this member.
Event Trace Log (EVTL)	N	This PCE manages the JES2 \$TRCLOG data set. It converts trace information from JES2 trace buffers in SYSOUT associated with the \$TRCLOG job. If this PCE is ended, then no trace data can be recorded to the \$TRCLOG data set.
Execution Services (EXEC)	Y	This PCE is responsible for placing jobs, STCs and TSUs into execution and processing their normal and abnormal termination (including re-queuing jobs to be executed again).
FSS Cleanup at EOM (FCLEANUP)	N	This PCE handles cleaning up FSS address spaces that go through end of memory without performing normal address space termination. If this PCE is ended, then FSS printers that go through the end of memory will hang.
Internal Reader Cleanup Processor (IRCLEAN)	N	This PCE cleans up internal readers that are no longer active. If an internal reader cleanup PCE is ended, a job that is active on the internal reader is not cleaned up until you restart JES2. If all the internal reader cleanup PCEs on a system end, then jobs on internal readers will no longer be cleaned up and internal reader data structures in ECSA does not free. If JES2 is not restarted, ECSA usage will increase and eventually you might need to do an IPL.
JCL Converter (CNVT)	N	These PCEs (with their subtasks) perform JCL conversion for all JOBS, STCs and TSUs. In general, there are two types of converter processors. One processor can wait for MVS resources (like HSM migrates) and ones that can not. If a converter PCE is ended, then the work can be picked up by other converters (possibly converters on other members). If all converter PCEs on a system end, then TSO logons and started task converters may hang. If all the converter PCEs on a system end, then TSO logons and started tasks will hang (as will batch jobs with system affinities).
JESXCF Interface (XCF)	Y	This PCE processes system status messages from JESXCF and maintains the current status or all members of the MAS.

PCE Description/Name	Required (Yes or No)	Function
JESXCF Request Processor (XCFCMND)	N	This PCE processes command requests received from JESXCF. It is used to receive information on who owns the checkpoint and initialization queries about where the checkpoint data set currently resides. If this PCE is ended, requests from other members can not be processed. This will have little impact on JES2 operations. However, messages sent to this PCE will accumulate in JESXCF and could eventually result in JESXCF ABENDs.
Job Priority Aging (PRTY)	N	This PCE updates the priority of JOBS on your system in accordance with the JOBDEF initialization statement. Priority aging only occurs on the lowest numbered active member of a MAS. If this PCE is ended, and this is the lowest active member, then priority aging of JOBS will stop. If this is not the lowest active member or if a lower numbered member is started, then there is no impact of this processor ending. SYSOUT priority aging is not affected.
Job Route Receiver (NET.RR)	N	This PCE (with the job route transmitter) handles jobs that are on the NJE transmit queue but are routed locally. This normally occurs when a \$R XEQ command is used to change a network routed job to the local node. If this PCE is ended, then the job it is processing is typically hung. Other jobs can be processed by the job route transmitter/receiver on other MAS members.
Job Route Transmitter (NET.RT)	N	This PCE (with the job route receiver) handles jobs that are on the NJE transmit queue but are routed locally. This normally occurs when a \$R XEQ command is used to change a network routed job to the local node. If this PCE is ended, then the job it is processing is typically hung. Other jobs can be processed by the job route transmitter/receiver on other MAS members.
JOE Index Processor (JOEI)	N	This PCE performs asynchronous management functions for the JOE index, such as initial building of the JOE index and deleting empty nodes from the index. This processing is distributed across all members in MAS. If this PCE is ended, JOEI PCEs on other members will continue to perform the function.
JQE Request processor (JQRP)	N	This PCE processes requests for JQEs from other address spaces other than the JES2 address space. If a JQRB PCE is ended, the job it was processing will remain in its current state and the requesting task (internal reader or NJE/TCP receiver) might hang. If all the JQRB PCEs on a system end, you can submit jobs through internal readers, NJE/TCP job receivers will no longer be able to accept new jobs, and request jobid processing hangs.
Line Manager (MLLM)	N	This PCE handles all BSC and SNA communication (NJE and RJE). If this PCE is ended, then all NJE and RJE communications stop.
MAS Command Processor (JCMD)	Y	This PCE processes job commands (such as \$CJ) that require an action to be taken on a member other than where the command was entered.

PCE Description/Name	Required (Yes or No)	Function
Miscellaneous (MISC)	N	This PCE is responsible for periodic functions that need to be performed in JES2. It deletes PCEs that are no longer needed, frees locks for PCEs that have ABENDED, frees jobs and SYSOUT that is on the rebuild queue, cleans up deleted dynamic PROCLIBs, and maintains the job number usage index. If this PCE is ended, then local functions performed by this PCE will cease. The cleaning of the rebuild queues and the maintenance of the job number usage index can be performed by miscellaneous PCEs on other members.
Network Path Manager (NPM)	N	This PCE manages NJE signon and routing. If this PCE is ended, then no new NJE sessions can be established and NJE routing cannot be changed. Existing NJE connections will continue to function. If network connections on other nodes start to change (sessions come up or go down), it is possible that jobs and SYSOUT could be mis-routed, resulting in jobs switching between nodes.
Network Resource Monitor (NRM)	N	This PCE checks the availability of NJE devices and initiates their starts appropriately.
NJE Job Receiver (NET.JR)	N	These PCEs handle Jobs being received over a line through NJE. If a job receiver is ended, then it can no longer process new jobs. Depending on the state of the device, other receivers on the same line may hang. If this is the only job receiver on the line, or if all the jobs receivers on a line have ended, then jobs will no longer be received on that line. However, if a line does not have dedicated network receivers and transmitters and the line is restarted, the ended PCE is discarded and a new PCE (if there are any available) will be used.
NJE Job Transmitter (NET.JT)	N	These PCEs handle Jobs being sent out over a line through NJE. If a job transmitter is ended, then it can no longer process new jobs. Depending on the state of the device, other transmitters on the same line may hang. If this is the only job transmitter on the line, or if all the job transmitters on a line have ended, then jobs will no longer be sent on that line. However, if a line does not have dedicated network receivers and transmitters and the line and restarted, the ended PCE is discarded and a new PCE (if there are any available) will be used.
NJE SYSOUT Receiver (NET.SR)	N	These PCEs handle SYSOUT being received over a line through NJE. If a SYSOUT receiver is ended, then it can no longer process new SYSOUT data sets. Depending on the state of the device, other receivers on the same line may hang. If this is the only SYSOUT receiver on the line, or if all SYSOUT receivers on the line have ended, then SYSOUT will no longer be received on that line. However, if a line does not have dedicated network receivers and transmitters and the line and restarted, the ended PCE is discarded and a new PCE (if there are any available) will be used.

PCE Description/Name	Required (Yes or No)	Function
NJE SYSOUT Transmitter (NET.ST)	N	These PCEs handle SYSOUT being transmitted over a line through NJE. If a SYSOUT transmitter is ended, then it can no longer process new SYSOUT data sets. Depending on the state of the device, other transmitters on the same line may hang. If this is the only SYSOUT transmitter on the line, or if all SYSOUT transmitters on the line have ended, then SYSOUT will no longer be received on that line. However, if a line does not have dedicated network receivers and transmitters and the line and restarted, the ended PCE is discarded and a new PCE (if there are any available) will be used.
Offload Job Receiver (OFF.JR)	N	These PCEs handle Jobs being read using SPOOL Reload. There is one job receiver per offloader (OFFLOADn). If an offload job receivers is ended, then it stops processing all jobs. Since offload receivers sequentially process records read from an offload tape, this offloader's reload process stops because the receiver has ended. Other offloaders are not affected.
Offload Job Transmitter (OFF.JT)	N	These PCEs handle jobs being written using SPOOL offload. There is one job transmitter per offloader (OFFLOADn). If an offload job receivers is ended, then it stops processing all jobs. Since there is only one transmitter per offload, jobs will no longer be written by this offloader. SYSOUT transmission is not affected. Other offloaders are not affected.
Offload SYSOUT Receiver (OFF.SR)	N	These PCEs handle SYSOUT being read using SPOOL Reload. There is one SYSOUT receiver per offloader (OFFLOADn). If an offload SYSOUT receiver is ended, then it stops processing all SYSOUT. Since offload receivers sequentially process records read from an offload tape, this offloader's reload process stops because the receiver has ended. Other offloaders are not affected.
Offload SYSOUT Transmitter (OFF.ST)	N	These PCEs handle SYSOUT being written using SPOOL offload. There is one SYSOUT transmitter per offloader (OFFLOADn). If an offload SYSOUT transmitter is ended, then it stops processing all SYSOUT. Since there is only one transmitter per offloader, SYSOUT will no longer be written by this offloader. Job transmission is not affected. Other offloaders are not affected.
Output Priority Aging (PRTYO)	N	This PCE updates the priority of SYSOUT on your system in accordance with the OUTDEF initialization statement. Priority aging only occurs on the lowest numbered active member of a MAS. If this PCE is ended, and this is the lowest active member, then priority aging of SYSOUT will stop. If this is not the lowest active member or is a lower numbered member is started, then there is no impact of this processor ending. JOB priority aging is not affected.

PCE Description/Name	Required (Yes or No)	Function
Output Processor (HOPE)	N	This PCE creates Job Output Elements (JOEs) for jobs that have completed execution or have been received on an NJE SYSOUT receiver. If an output PCE is ended, then the work can be picked up by other output processors (including those on other members of the MAS). If all output processors are terminated, then jobs will hang in the output phase and their output cannot be printed.
Printer (PRT)	N	Each PCE of this type manages a local printer whether it is in JES or FSS mode. If a PCE of this type is ended, then that printer will stop functioning. Other printers are not affected. A \$ADD PRINTER command can be used to define a new logical JES2 printer to manage the physical printer.
Process SYSOUT Processor (PSO)	N	These PCEs handle requests made through the Process SYSOUT SSI (PSO). These requests typically are associated with TSO users (RECEIVE or OUTPUT commands, or SDSF), external writers, and applications that examine SYSOUT. When a PSO PCE is ended, then the address space the PCE was processing requests from, may be hung. If all PSO PCEs are ended, then any PSO request will result in the requesting address space being hung.
Punch (PUN)	N	Each PCE of this type manages a local punch. If a PCE of this type is ended, then that punch will stop functioning. Other punches are not affected.
Purge Processor (PURGE)	N	These PCEs handle the purging of SPOOL space for JOBS and SPIN SYSOUT data sets. If one of these PCE is ended, the unit of work it was purging will hang in purge processing. Depending on the resources held by the PCE at the time it is ended, other purge processors on the same member may also hang. Purge processors on other members will not be affected and can pick up any work not hung on ended PCEs.
Reader (RDR)	N	Each PCE of this type manages a local card reader. If a PCE of this type is ended, then that card reader will stop functioning. Other card readers are not affected.
Remote Console Processor (MCON)	Y	This PCE handles messages and commands that are being sent to RJE, NJE and other members of the MAS. This PCE manages the \$MASCOMM job.
Resource Monitor (RESOURCE)	N	This PCE is responsible for tracking resource usage and issues the \$HASP050 message if a shortage is detected. If this PCE is ended, then local resources monitored by this PCE will stop. The monitoring of MAS scope resources can be performed by resource monitor PCEs on other members.
RJE Reader (RMT.RDR)	N	Each PCE of this type manages a card reader at an RJE workstation. If a PCE of this type is ended, then that remote reader will stop functioning. Depending on the state of the device, other readers on the same remote may hang. The remote may not be able to completely logoff JES2 and could become unusable until JES2 is hot started.

PCE Description/Name	Required (Yes or No)	Function
RJE Printer (RMT.PRT)	N	Each PCE of this type manages a printer at an RJE workstation. If a PCE of this type is ended, then that remote printer will stop functioning. Depending on the state of the device, other printers and punches on the same remote may hang. The remote may not be able to completely logoff JES2 and could become unusable until JES2 is hot started.
RJE Punch (RMT.PUN)	N	Each PCE of this type manages a card punch at an RJE workstation. If a PCE of this type is ended, then the remote card punch will stop functioning. Depending on the state of the device, other printers and punches on the same remote may hang. The remote may not be able to completely logoff JES2 and could become unusable until JES2 is hot started.
Spool Garbage Collector (SNF)	N	This PCE is responsible for recovering SPOOL space that was not freed during normal job purge processing. If this PCE is ended, then these unowned tracks of SPOOL will not be reclaimed on this member. If there are other members, then the SPOOL management PCE on those members will perform the function.
Spool Offload I/O Manager (SOM)	N	This PCE processes asynchronous events related to the JES2 SPOOL offload facility. If this PCE is ended, than all active offload devices will eventually hang. Also, no new offload devices can be started.
SWB Modify Processor (SJFSERV)	N	This PCE handles SWB modify requests for applications such as SDSF. If this PCE is ended, then SWB modify requests can not be processed. Since these requests are asynchronous, no address spaces will be delayed by this. However, since SWB changes are not being made, users of applications such as SDSF may start submitting multiple requests to JES2. These requests each consume some ECSA and if no action is taken for an extended period of time, ECSA can be exhausted.
SYSOUT API Processor (SPI)	N	These PCEs handle SAPI requests from applications. If one PCE of this type is ended, then the application whose request is currently being processed will hang. If all the SAPI PCEs are ended, then any application requesting access to SYSOUT through SAPI will eventually hang.
Spin Output Processor (SPIN)	N	These PCEs handle the processing of spin data sets created locally and those received through NJE. Not all PCEs of this type perform all functions. Only half process jobs received from NJE. If a PCE of this type ends, then the SYSOUT data sets being processed (or in the case of NJE, the job being processed) will hang. If all PCEs of this type end, then no local SYSOUT can be processed. Jobs that create spin output will complete execution but will hang in the spin phase in JES2. Also, ECSA usage can increase rapidly. The NJE function of the spin PCE will be spread across multiple members. If all the spin PCEs in the MAS capable of processing NJE SYSOUT have ended, then through NJE SYSOUT will continue to be received and none will be available for further processing.

PCE Description/Name	Required (Yes or No)	Function
Spool Command Processor (SPOOL)	N	This PCE handles operator commands against SPOOL volumes (\$S, \$Z, \$P). In addition it reformats SPOOL track groups that encounter I/O errors (halting SPOOL volumes if serious errors were encountered). If this PCE is ended, then no spool commands can complete (regardless of the member the command was issued on). Also, JES2 will be unable to automatically halt a SPOOL volume in the event of a serious error. If there are I/O errors on spool, then requests to handle these errors will back up the ECSA and could eventually cause ECSA to be exhausted.
SSI Status/Cancel Services (STAC)	N	These PCEs handle status and cancel SSI requests from application address spaces (such as the TSO STATUS and CANCEL commands). If a PCE of this type is ended, then any address space using the status or cancel SSI will hang.
STIMER/TTIMER Processor (TIMER)	Y	This PCE manages JES2 internal timer requests.
Warm Start Processor (WARM)	Y	These PCEs are required during JES2 initialization but not required after initialization completes. These PCEs handle warm start processing and \$E MEMBER commands. If an abend occurs during warm start processing, JES2 will terminate. If this PCE is processing a \$E command, then the PCE will be ended. If a PCE of this type is ended, then the member it was resetting (\$Eing) will not complete reset processing. No other member can reset this member and the member can not be restarted. If all the warm start PCEs are ended, then no \$E MEMBER commands will be processed on this member. However, warm start PCEs on other members can process new reset requests.

Appendix B. Accessibility

Accessible publications for this product are offered through IBM Knowledge Center (<http://www.ibm.com/support/knowledgecenter/SSLTBW/welcome>).

If you experience difficulty with the accessibility of any z/OS information, send a detailed message to the "Contact us" web page for z/OS (<http://www.ibm.com/systems/z/os/zos/webqs.html>) or use the following mailing address.

IBM Corporation
Attention: MHVRCFS Reader Comments
Department H6MA, Building 707
2455 South Road
Poughkeepsie, NY 12601-5400
United States

Accessibility features

Accessibility features help users who have physical disabilities such as restricted mobility or limited vision use software products successfully. The accessibility features in z/OS can help users do the following tasks:

- Run assistive technology such as screen readers and screen magnifier software.
- Operate specific or equivalent features by using the keyboard.
- Customize display attributes such as color, contrast, and font size.

Consult assistive technologies

Assistive technology products such as screen readers function with the user interfaces found in z/OS. Consult the product information for the specific assistive technology product that is used to access z/OS interfaces.

Keyboard navigation of the user interface

You can access z/OS user interfaces with TSO/E or ISPF. The following information describes how to use TSO/E and ISPF, including the use of keyboard shortcuts and function keys (PF keys). Each guide includes the default settings for the PF keys.

- *z/OS TSO/E Primer*
- *z/OS TSO/E User's Guide*
- *z/OS V2R2 ISPF User's Guide Vol I*

Dotted decimal syntax diagrams

Syntax diagrams are provided in dotted decimal format for users who access IBM Knowledge Center with a screen reader. In dotted decimal format, each syntax element is written on a separate line. If two or more syntax elements are always present together (or always absent together), they can appear on the same line because they are considered a single compound syntax element.

Each line starts with a dotted decimal number; for example, 3 or 3.1 or 3.1.1. To hear these numbers correctly, make sure that the screen reader is set to read out

punctuation. All the syntax elements that have the same dotted decimal number (for example, all the syntax elements that have the number 3.1) are mutually exclusive alternatives. If you hear the lines 3.1 USERID and 3.1 SYSTEMID, your syntax can include either USERID or SYSTEMID, but not both.

The dotted decimal numbering level denotes the level of nesting. For example, if a syntax element with dotted decimal number 3 is followed by a series of syntax elements with dotted decimal number 3.1, all the syntax elements numbered 3.1 are subordinate to the syntax element numbered 3.

Certain words and symbols are used next to the dotted decimal numbers to add information about the syntax elements. Occasionally, these words and symbols might occur at the beginning of the element itself. For ease of identification, if the word or symbol is a part of the syntax element, it is preceded by the backslash (\) character. The * symbol is placed next to a dotted decimal number to indicate that the syntax element repeats. For example, syntax element *FILE with dotted decimal number 3 is given the format 3 * FILE. Format 3* FILE indicates that syntax element FILE repeats. Format 3* * FILE indicates that syntax element * FILE repeats.

Characters such as commas, which are used to separate a string of syntax elements, are shown in the syntax just before the items they separate. These characters can appear on the same line as each item, or on a separate line with the same dotted decimal number as the relevant items. The line can also show another symbol to provide information about the syntax elements. For example, the lines 5.1*, 5.1 LASTRUN, and 5.1 DELETE mean that if you use more than one of the LASTRUN and DELETE syntax elements, the elements must be separated by a comma. If no separator is given, assume that you use a blank to separate each syntax element.

If a syntax element is preceded by the % symbol, it indicates a reference that is defined elsewhere. The string that follows the % symbol is the name of a syntax fragment rather than a literal. For example, the line 2.1 %OP1 means that you must refer to separate syntax fragment OP1.

The following symbols are used next to the dotted decimal numbers.

? indicates an optional syntax element

The question mark (?) symbol indicates an optional syntax element. A dotted decimal number followed by the question mark symbol (?) indicates that all the syntax elements with a corresponding dotted decimal number, and any subordinate syntax elements, are optional. If there is only one syntax element with a dotted decimal number, the ? symbol is displayed on the same line as the syntax element, (for example 5? NOTIFY). If there is more than one syntax element with a dotted decimal number, the ? symbol is displayed on a line by itself, followed by the syntax elements that are optional. For example, if you hear the lines 5 ?, 5 NOTIFY, and 5 UPDATE, you know that the syntax elements NOTIFY and UPDATE are optional. That is, you can choose one or none of them. The ? symbol is equivalent to a bypass line in a railroad diagram.

! indicates a default syntax element

The exclamation mark (!) symbol indicates a default syntax element. A dotted decimal number followed by the ! symbol and a syntax element indicate that the syntax element is the default option for all syntax elements that share the same dotted decimal number. Only one of the syntax elements that share the dotted decimal number can specify the ! symbol. For example, if you hear the lines 2? FILE, 2.1! (KEEP), and 2.1 (DELETE), you know that (KEEP) is the

default option for the FILE keyword. In the example, if you include the FILE keyword, but do not specify an option, the default option KEEP is applied. A default option also applies to the next higher dotted decimal number. In this example, if the FILE keyword is omitted, the default FILE(KEEP) is used. However, if you hear the lines 2? FILE, 2.1, 2.1.1! (KEEP), and 2.1.1 (DELETE), the default option KEEP applies only to the next higher dotted decimal number, 2.1 (which does not have an associated keyword), and does not apply to 2? FILE. Nothing is used if the keyword FILE is omitted.

*** indicates an optional syntax element that is repeatable**

The asterisk or glyph (*) symbol indicates a syntax element that can be repeated zero or more times. A dotted decimal number followed by the * symbol indicates that this syntax element can be used zero or more times; that is, it is optional and can be repeated. For example, if you hear the line 5.1* data area, you know that you can include one data area, more than one data area, or no data area. If you hear the lines 3* , 3 HOST, 3 STATE, you know that you can include HOST, STATE, both together, or nothing.

Notes:

1. If a dotted decimal number has an asterisk (*) next to it and there is only one item with that dotted decimal number, you can repeat that same item more than once.
2. If a dotted decimal number has an asterisk next to it and several items have that dotted decimal number, you can use more than one item from the list, but you cannot use the items more than once each. In the previous example, you can write HOST STATE, but you cannot write HOST HOST.
3. The * symbol is equivalent to a loopback line in a railroad syntax diagram.

+ indicates a syntax element that must be included

The plus (+) symbol indicates a syntax element that must be included at least once. A dotted decimal number followed by the + symbol indicates that the syntax element must be included one or more times. That is, it must be included at least once and can be repeated. For example, if you hear the line 6.1+ data area, you must include at least one data area. If you hear the lines 2+, 2 HOST, and 2 STATE, you know that you must include HOST, STATE, or both. Similar to the * symbol, the + symbol can repeat a particular item if it is the only item with that dotted decimal number. The + symbol, like the * symbol, is equivalent to a loopback line in a railroad syntax diagram.

Notices

This information was developed for products and services offered in the U.S.A. or elsewhere.

IBM may not offer the products, services, or features discussed in this document in other countries. Consult your local IBM representative for information on the products and services currently available in your area. Any reference to an IBM product, program, or service is not intended to state or imply that only that IBM product, program, or service may be used. Any functionally equivalent product, program, or service that does not infringe any IBM intellectual property right may be used instead. However, it is the user's responsibility to evaluate and verify the operation of any non-IBM product, program, or service.

IBM may have patents or pending patent applications covering subject matter described in this document. The furnishing of this document does not give you any license to these patents. You can send license inquiries, in writing, to:

IBM Director of Licensing
IBM Corporation
North Castle Drive
Armonk, NY 10504-1785
U.S.A

For license inquiries regarding double-byte character set (DBCS) information, contact the IBM Intellectual Property Department in your country or send inquiries, in writing, to:

Intellectual Property Licensing
Legal and Intellectual Property Law
IBM Japan, Ltd.
19-21, Nihonbashi-Hakozakicho, Chuo-ku
Tokyo 103-8510, Japan

The following paragraph does not apply to the United Kingdom or any other country where such provisions are inconsistent with local law: INTERNATIONAL BUSINESS MACHINES CORPORATION PROVIDES THIS PUBLICATION "AS IS" WITHOUT WARRANTY OF ANY KIND, EITHER EXPRESS OR IMPLIED, INCLUDING, BUT NOT LIMITED TO, THE IMPLIED WARRANTIES OF NON-INFRINGEMENT, MERCHANTABILITY OR FITNESS FOR A PARTICULAR PURPOSE. Some states do not allow disclaimer of express or implied warranties in certain transactions, therefore, this statement may not apply to you.

This information could include technical inaccuracies or typographical errors. Changes are periodically made to the information herein; these changes will be incorporated in new editions of the publication. IBM may make improvements and/or changes in the product(s) and/or the program(s) described in this publication at any time without notice.

Any references in this information to non-IBM Web sites are provided for convenience only and do not in any manner serve as an endorsement of those Web sites. The materials at those Web sites are not part of the materials for this IBM product and use of those Web sites is at your own risk.

Notices

IBM may use or distribute any of the information you supply in any way it believes appropriate without incurring any obligation to you.

Licenses of this program who wish to have information about it for the purpose of enabling: (i) the exchange of information between independently created programs and other programs (including this one) and (ii) the mutual use of the information which has been exchanged, should contact:

Site Counsel
IBM Corporation
2455 South Road
Poughkeepsie, NY 12601-5400
USA

Such information may be available, subject to appropriate terms and conditions, including in some cases, payment of a fee.

The licensed program described in this information and all licensed material available for it are provided by IBM under terms of the IBM Customer Agreement, IBM International Program License Agreement, or any equivalent agreement between us.

Information concerning non-IBM products was obtained from the suppliers of those products, their published announcements or other publicly available sources. IBM has not tested those products and cannot confirm the accuracy of performance, compatibility or any other claims related to non-IBM products. Questions on the capabilities of non-IBM products should be addressed to the suppliers of those products.

All statements regarding IBM's future direction or intent are subject to change or withdrawal without notice, and represent goals and objectives only.

If you are viewing this information softcopy, the photographs and color illustrations may not appear.

COPYRIGHT LICENSE:

This information might contain sample application programs in source language, which illustrate programming techniques on various operating platforms. You may copy, modify, and distribute these sample programs in any form without payment to IBM, for the purposes of developing, using, marketing or distributing application programs conforming to the application programming interface for the operating platform for which the sample programs are written. These examples have not been thoroughly tested under all conditions. IBM, therefore, cannot guarantee or imply reliability, serviceability, or function of these programs. The sample programs are provided "AS IS", without warranty of any kind. IBM shall not be liable for any damages arising out of your use of the sample programs.

Policy for unsupported hardware

Various z/OS elements, such as DFSMS, HCD, JES2, JES3, and MVS, contain code that supports specific hardware servers or devices. In some cases, this device-related element support remains in the product even after the hardware devices pass their announced End of Service date. z/OS may continue to service element code; however, it will not provide service related to unsupported hardware devices. Software problems related to these devices will not be accepted

for service, and current service activity will cease if a problem is determined to be associated with out-of-support devices. In such cases, fixes will not be issued.

Minimum supported hardware

The minimum supported hardware for z/OS releases identified in z/OS announcements can subsequently change when service for particular servers or devices is withdrawn. Likewise, the levels of other software products supported on a particular release of z/OS are subject to the service support lifecycle of those products. Therefore, z/OS and its product publications (for example, panels, samples, messages, and product documentation) can include references to hardware and software that is no longer supported.

- For information about software support lifecycle, see: IBM Lifecycle Support for z/OS (<http://www.ibm.com/software/support/systemsz/lifecycle/>)
 - For information about currently-supported IBM hardware, contact your IBM representative.
-

Programming Interface Information

This publication documents information that is NOT intended to be used as programming Interfaces of JES2.

Trademarks

IBM, the IBM logo, and [ibm.com](http://www.ibm.com) are trademarks or registered trademarks of International Business Machines Corp., registered in many jurisdictions worldwide. Other product and service names might be trademarks of IBM or other companies. A current list of IBM trademarks is available at Copyright and Trademark information (<http://www.ibm.com/legal/copytrade.shtml>).



Product Number: 5650-ZOS

Printed in USA

SA32-0989-03

