

z/OS



# JES2 Installation Exits

*Version 2 Release 2*

**Note**

Before using this information and the product it supports, read the information in "Notices" on page 437.

This edition applies to Version 2 Release 2 of z/OS (5650-ZOS) and to all subsequent releases and modifications until otherwise indicated in new editions.

© **Copyright IBM Corporation 1988, 2015.**

US Government Users Restricted Rights – Use, duplication or disclosure restricted by GSA ADP Schedule Contract with IBM Corp.

# Contents

**Figures . . . . . xv**

**Tables . . . . . xvii**

**About this document . . . . . xix**

Who should use this document . . . . . xix

How this document is organized . . . . . xix

Where to find more information . . . . . xix

Additional information . . . . . xix

**How to send your comments to IBM . . . . . xxi**

If you have a technical problem . . . . . xxi

**Summary of changes for z/OS  
Version 2 Release 2 (V2R2) as  
updated December, 2015 . . . . . xxiii**

Summary of changes for z/OS Version 2 Release 2  
(V2R2) . . . . . xxiii

z/OS Version 2 Release 1 summary of changes . . . . . xxiv

**Chapter 1. Introduction . . . . . 1**

What is a JES2 exit? . . . . . 3

Environment . . . . . 5

**Chapter 2. Writing an exit routine. . . . . 7**

Language . . . . . 7

Operating environment. . . . . 7

JES2 environments . . . . . 7

Synchronization . . . . . 10

Reentrant code considerations . . . . . 11

Linkage conventions . . . . . 11

Addressing mode of JES2 exits . . . . . 13

Addressing mode requirements. . . . . 13

Residency mode requirements . . . . . 13

Received parameters . . . . . 13

Return codes . . . . . 14

Control blocks . . . . . 14

Determining the JES2 release level. . . . . 16

Service routine usage . . . . . 19

Exit logic . . . . . 19

Exit-to-exit communication . . . . . 19

Exit point-to-exit routine communication . . . . . 20

Exit routine-to exit point communication . . . . . 20

Exit-to-operator communication . . . . . 20

Required mapping macros . . . . . 20

JES2 main task environment exits . . . . . 21

JES2 subtask environment exits. . . . . 21

Functional subsystem address space environment  
exits. . . . . 22

User environment exits . . . . . 22

User environment exit considerations. . . . . 24

Reentrancy . . . . . 24

Accessing CKPTed Data Area . . . . . 24

Accessing \$CATs . . . . . 25

Storage considerations. . . . . 25

One time exit initialization code . . . . . 25

Tracing . . . . . 26

Recovery . . . . . 26

Loading non-JES2 modules . . . . . 26

**Chapter 3. Controlling the loading of  
installation-defined load modules . . . . . 29**

Loading and placement of installation load modules . . . . . 29

Dynamic Load Modules . . . . . 31

Dynamic Load Module Considerations . . . . . 32

\$\$\$\$LOAD and \$\$\$DEL routines . . . . . 33

\$\$\$DEL Routine . . . . . 36

Special Considerations for LPA Modules. . . . . 38

**Chapter 4. Enabling an exit . . . . . 41**

**Chapter 5. Getting listings of JES2 data  
areas . . . . . 43**

**Chapter 6. Sample exit routines . . . . . 45**

**Chapter 7. Multiple exit routines in a  
single module. . . . . 47**

**Chapter 8. Testing your exit routine .. 51**

Packaging the exit . . . . . 51

Initializing the exit in the system . . . . . 52

Passing control to exit routines . . . . . 55

Job-related exits . . . . . 55

**Chapter 9. Tracing status . . . . . 57**

**Chapter 10. Establishing  
installation-defined exits . . . . . 59**

**Chapter 11. Hints for coding JES2 exit  
routines . . . . . 61**

Assembler instructions . . . . . 61

Constants . . . . . 61

DSECTs. . . . . 61

Registers . . . . . 62

Miscellaneous . . . . . 62

**Chapter 12. IBM-defined exits . . . . . 65**

Exit selection table . . . . . 65

Exit implementation table . . . . . 75

**Chapter 13. Exit 0: Pre-initialization .. 79**

Function . . . . . 79

Environment . . . . . 79

Task. . . . . 79

|   |    |
|---|----|
| AMODE/RMODE requirements . . . . .                                  | 79 |
| Supervisor/problem program . . . . .                                | 79 |
| Recovery . . . . .  | 79 |
| Job exit mask . . . . .   | 79 |
| Mapping macros normally required . . . . .                          | 79 |
| Point of processing . . . . .                                       | 79 |
| Programming considerations . . . . .                                | 80 |
| Register contents when Exit 0 gets control . . . . .                | 81 |
| Register contents when Exit 0 passes control back to JES2 . . . . . | 81 |
| Coded example . . . . .   | 82 |

**Chapter 14. Exit 1: Print/punch separators . . . . . 83**

|   |    |
|---|----|
| Function . . . . .  | 83 |
| Environment . . . . .   | 84 |
| Task . . . . .  | 84 |
| AMODE/RMODE requirements . . . . .                            | 84 |
| Restrictions . . . . .  | 84 |
| Recovery . . . . .  | 84 |
| Job exit mask . . . . .                                       | 84 |
| Mapping macros normally required . . . . .                    | 84 |
| Point of processing . . . . .                                 | 84 |
| Programming considerations . . . . .                          | 84 |
| Register contents when Exit 1 gets control . . . . .          | 86 |
| Register contents when control passes back to JES2: . . . . . | 88 |
| Coded example . . . . .                                       | 88 |

**Chapter 15. Exit 2: JOB/JOBGROUP JCL statement scan (JES2 main task) . . . . . 89**

|   |    |
|---|----|
| Function . . . . .  | 89 |
| Recommendations for implementing Exit 2 . . . . .                   | 89 |
| Environment . . . . .   | 91 |
| Task . . . . .  | 91 |
| AMODE/RMODE requirements . . . . .                                  | 91 |
| Supervisor/problem program . . . . .                                | 92 |
| Restrictions . . . . .  | 92 |
| Recovery . . . . .  | 92 |
| Job exit mask . . . . .   | 92 |
| Storage recommendations . . . . .                                   | 92 |
| Mapping macros normally required . . . . .                          | 92 |
| Point of processing . . . . .                                       | 92 |
| Extending the JCT control block . . . . .                           | 93 |
| Programming considerations . . . . .                                | 93 |
| Register contents on entry to exit 2 . . . . .                      | 93 |
| Register contents when exit 2 passes control back to JES2 . . . . . | 96 |
| Coded example . . . . .   | 97 |

**Chapter 16. Exit 3: JOB/JOBGROUP statement accounting field scan (JES2 main task) . . . . . 99**

|                                      |     |
|--------------------------------------|-----|
| Function . . . . .                   | 99  |
| Related exits . . . . .              | 99  |
| Environment . . . . .                | 99  |
| Task . . . . .                       | 99  |
| AMODE/RMODE requirements . . . . .   | 99  |
| Supervisor/problem program . . . . . | 100 |
| Restrictions . . . . .               | 100 |

|   |     |
|---|-----|
| Recovery . . . . .  | 100 |
| Job exit mask . . . . .   | 100 |
| Mapping macros normally required . . . . .                          | 100 |
| Point of processing . . . . .                                       | 100 |
| Extending the JCT control block . . . . .                           | 102 |
| Programming considerations . . . . .                                | 102 |
| Register contents when Exit 3 gets control . . . . .                | 104 |
| Register contents when Exit 3 passes control back to JES2 . . . . . | 106 |
| Coded example . . . . .   | 106 |

**Chapter 17. Exit 4: JCL and JES2 control statement scan (JES2 main task) . . . . . 107**

|   |     |
|---|-----|
| Function . . . . .  | 107 |
| Environment . . . . .   | 107 |
| Task . . . . .  | 107 |
| AMODE/RMODE requirements . . . . .                                  | 107 |
| Supervisor/problem program . . . . .                                | 108 |
| Restrictions . . . . .  | 108 |
| Recovery . . . . .  | 108 |
| Job exit mask . . . . .   | 108 |
| Mapping macros normally required . . . . .                          | 108 |
| Point of processing . . . . .                                       | 108 |
| Programming considerations . . . . .                                | 108 |
| Register contents when Exit 4 gets control . . . . .                | 112 |
| Register contents when Exit 4 passes control back to JES2 . . . . . | 115 |
| Coded example . . . . .   | 115 |

**Chapter 18. Exit 5: JES2 command preprocessor . . . . . 117**

|   |     |
|---|-----|
| Function . . . . .  | 117 |
| The JES2 command translator migration aid: . . . . .                | 117 |
| Environment . . . . .   | 119 |
| Task . . . . .  | 119 |
| AMODE/RMODE requirements . . . . .                                  | 119 |
| Supervisor/problem program . . . . .                                | 119 |
| Recovery . . . . .  | 119 |
| Job exit mask . . . . .   | 119 |
| Mapping macros normally required . . . . .                          | 119 |
| Point of processing . . . . .                                       | 119 |
| Programming considerations . . . . .                                | 120 |
| Register contents when Exit 5 gets control . . . . .                | 122 |
| Register contents when Exit 5 passes control back to JES2 . . . . . | 122 |
| Coded example . . . . .   | 123 |

**Chapter 19. Exit 6: JES2 converter exit (subtask) . . . . . 125**

|   |     |
|---|-----|
| Function . . . . .                                | 125 |
| Related exits . . . . .                           | 125 |
| Recommendations for implementing Exit 6 . . . . . | 125 |
| Environment . . . . .                             | 127 |
| Task . . . . .                                    | 127 |
| Restrictions . . . . .                            | 127 |
| AMODE/RMODE requirements . . . . .                | 127 |
| Supervisor/problem program . . . . .              | 127 |
| Recovery . . . . .                                | 127 |

|   |     |
|---|-----|
| Job exit mask . . . . .   | 127 |
| Storage recommendations . . . . .                                   | 127 |
| Mapping macros typically required . . . . .                         | 128 |
| Point of processing . . . . .                                       | 128 |
| Programming considerations . . . . .                                | 128 |
| Register contents when Exit 6 gets control. . . . .                 | 128 |
| Register contents when Exit 6 passes control back to JES2 . . . . . | 130 |
| Coded example. . . . .  | 131 |

**Chapter 20. Exit 7: Control block I/O (JES2) . . . . . 133**

|   |     |
|---|-----|
| Function . . . . .  | 133 |
| Related exits. . . . .  | 133 |
| Recommendations for implementing Exit 7 . . . . .                   | 133 |
| Programming considerations . . . . .                                | 134 |
| Point of processing . . . . .                                       | 134 |
| Environment . . . . .   | 134 |
| Task . . . . .  | 134 |
| AMODE/RMODE requirements . . . . .                                  | 134 |
| Supervisor/problem program . . . . .                                | 134 |
| Recovery . . . . .  | 134 |
| Job exit mask . . . . .   | 135 |
| Mapping macros normally required . . . . .                          | 135 |
| Register contents on entry to Exit 7 . . . . .                      | 135 |
| Register contents when Exit 7 passes control back to JES2 . . . . . | 136 |
| Coded example. . . . .  | 136 |

**Chapter 21. Exit 8: Control block read/write (user, subtask, and FSS) .. 137**

|  |     |
|--|-----|
| Function . . . . .                             | 137 |
| Related exits. . . . .                         | 137 |
| Programming considerations . . . . .           | 137 |
| Point of processing . . . . .                  | 137 |
| Environment . . . . .                          | 138 |
| Task . . . . .                                 | 138 |
| AMODE/RMODE requirements . . . . .             | 138 |
| Restrictions . . . . .                         | 138 |
| Recovery . . . . .                             | 138 |
| Job exit mask . . . . .                        | 138 |
| Mapping macros normally required . . . . .     | 138 |
| Register contents on entry to Exit 8 . . . . . | 138 |
| Register contents on return to JES2 . . . . .  | 139 |
| Coded example. . . . .                         | 140 |

**Chapter 22. Exit 9: Output excession options . . . . . 141**

|  |     |
|--|-----|
| Function . . . . .                         | 141 |
| Related exits. . . . .                     | 141 |
| Environment . . . . .                      | 141 |
| Task . . . . .                             | 141 |
| AMODE/RMODE requirements . . . . .         | 141 |
| Supervisor/problem program . . . . .       | 141 |
| Restrictions . . . . .                     | 141 |
| Recovery . . . . .                         | 142 |
| Job exit mask . . . . .                    | 142 |
| Mapping macros normally required . . . . . | 142 |
| Point of processing . . . . .              | 142 |
| Programming considerations . . . . .       | 142 |

|   |     |
|---|-----|
| Register contents on entry to Exit 9 . . . . .                      | 142 |
| Register contents when Exit 9 passes control back to JES2 . . . . . | 144 |
| Coded example. . . . .  | 145 |

**Chapter 23. Exit 10: \$WTO screen .. 147**

|  |     |
|--|-----|
| Function . . . . .   | 147 |
| Environment . . . . .  | 147 |
| Task . . . . .   | 147 |
| AMODE/RMODE requirements . . . . .                                   | 147 |
| Supervisor/problem program . . . . .                                 | 147 |
| Recovery . . . . .   | 147 |
| Job exit mask . . . . .  | 147 |
| Mapping macros normally required . . . . .                           | 147 |
| Point of processing . . . . .  | 147 |
| Programming considerations: . . . . .                                | 148 |
| Register contents when Exit 10 gets control . . . . .                | 148 |
| Register contents when Exit 10 passes control back to JES2 . . . . . | 149 |
| Coded example. . . . .   | 149 |

**Chapter 24. Exit 11: Spool partitioning allocation (\$TRACK) . . . . . 151**

|  |     |
|--|-----|
| Function . . . . .   | 151 |
| Related exits. . . . .   | 151 |
| Recommendations for implementing Exit 11 . . . . .                   | 151 |
| Environment . . . . .  | 152 |
| Task . . . . .   | 152 |
| AMODE/RMODE requirements . . . . .                                   | 152 |
| Supervisor/problem program . . . . .                                 | 152 |
| Restrictions . . . . .   | 152 |
| Recovery . . . . .   | 152 |
| Job exit mask . . . . .  | 152 |
| Mapping macros normally required . . . . .                           | 152 |
| Point of processing . . . . .  | 152 |
| Programming considerations . . . . .                                 | 153 |
| Register contents when Exit 11 gets control . . . . .                | 154 |
| Register contents when Exit 11 passes control back to JES2 . . . . . | 154 |
| Coded example. . . . .   | 155 |

**Chapter 25. Exit 12: Spool partitioning allocation (\$STRAK) . . . . . 157**

|  |     |
|--|-----|
| Function . . . . .   | 157 |
| Related exits. . . . .   | 157 |
| Recommendations for implementing Exit 12 . . . . .                   | 157 |
| Environment . . . . .  | 158 |
| Task . . . . .   | 158 |
| AMODE/RMODE requirements . . . . .                                   | 158 |
| Supervisor/problem program . . . . .                                 | 158 |
| Restrictions . . . . .   | 158 |
| Job exit mask . . . . .  | 158 |
| Mapping macros normally required . . . . .                           | 159 |
| Point of processing . . . . .  | 159 |
| Programming considerations . . . . .                                 | 159 |
| Register contents when Exit 12 gets control . . . . .                | 160 |
| Register contents when Exit 12 passes control back to JES2 . . . . . | 160 |
| Coded example. . . . .   | 161 |

**Chapter 26. Exit 14: Job queue work select – \$QGET . . . . . 163**

Function . . . . . 163  
Environment . . . . . 163  
    Task . . . . . 163  
        AMODE/RMODE requirements . . . . . 163  
        Supervisor/problem program . . . . . 163  
        Recovery . . . . . 163  
        Job exit mask . . . . . 163  
        Mapping macros normally required . . . . . 163  
Point of processing . . . . . 164  
Programming considerations . . . . . 164  
Register contents when Exit 14 gets control . . . 166  
Register contents when Exit 14 passes control back to JES2 . . . . . 167  
Coded example. . . . . 168

**Chapter 27. Exit 15: Output data set/copy select. . . . . 169**

Function . . . . . 169  
Programming considerations . . . . . 169  
Environment . . . . . 171  
    Task . . . . . 171  
        AMODE/RMODE requirements . . . . . 171  
        Recovery . . . . . 171  
        Job exit mask . . . . . 171  
        Mapping macros normally required . . . . . 171  
Point of processing . . . . . 171  
Contents of registers on entry to Exit 15 . . . . . 171  
Contents of register when Exit 15 returns to JES2 . 173  
Coded example. . . . . 173

**Chapter 28. Exit 16: Notify . . . . . 175**

Function . . . . . 175  
Environment . . . . . 175  
    Task . . . . . 175  
        AMODE/RMODE requirements . . . . . 175  
        Supervisor/problem program . . . . . 175  
        Recovery . . . . . 175  
        Job exit mask . . . . . 175  
Mapping macros normally required . . . . . 175  
Point of processing . . . . . 175  
Programming considerations . . . . . 175  
Register contents when Exit 16 gets control . . . 176  
Register contents when Exit 16 passes control back to JES2 . . . . . 176  
Coded example. . . . . 177

**Chapter 29. Exit 17: BSC RJE SIGNON/SIGNOFF . . . . . 179**

Function . . . . . 179  
Environment . . . . . 179  
    Task . . . . . 179  
        AMODE/RMODE requirements . . . . . 179  
        Supervisor/problem program . . . . . 179  
        Recovery . . . . . 179  
        Job exit mask . . . . . 179  
        Storage recommendations . . . . . 179  
        Mapping macros normally required . . . . . 179

Point of processing . . . . . 179  
Programming considerations . . . . . 180  
Register contents when Exit 17 gets control . . . 180  
Register contents when Exit 17 passes control back to JES2 . . . . . 181  
Coded example. . . . . 182

**Chapter 30. Exit 18: SNA RJE LOGON/LOGOFF . . . . . 183**

Function . . . . . 183  
Environment . . . . . 183  
    Task . . . . . 183  
        AMODE/RMODE requirements . . . . . 183  
        Supervisor/problem program . . . . . 183  
        Recovery . . . . . 183  
        Job exit mask . . . . . 183  
        Mapping macros normally required . . . . . 183  
Point of processing . . . . . 183  
Programming considerations . . . . . 184  
Register contents when Exit 18 gets control . . . 184  
Register contents when Exit 18 passes control back to JES2 . . . . . 185  
Coded example. . . . . 185

**Chapter 31. Exit 19: Initialization statement . . . . . 187**

Function . . . . . 187  
Environment . . . . . 187  
    Task . . . . . 187  
        AMODE/RMODE requirements . . . . . 187  
        Supervisor/problem program . . . . . 187  
        Recovery . . . . . 187  
        Job exit mask . . . . . 187  
        Mapping macros normally required . . . . . 187  
Point of processing . . . . . 187  
Programming considerations . . . . . 188  
Register contents when Exit 19 gets control . . . 189  
Register contents when Exit 19 passes control back to JES2 . . . . . 190  
Coded example. . . . . 190

**Chapter 32. Exit 20: End of input . . . 191**

Function . . . . . 191  
Environment . . . . . 191  
    Task . . . . . 191  
        AMODE/RMODE requirements . . . . . 191  
        Supervisor/problem program . . . . . 191  
        Recovery . . . . . 191  
        Job exit mask . . . . . 191  
        Mapping macros normally required . . . . . 191  
Point of processing . . . . . 191  
Programming considerations . . . . . 192  
Register contents when Exit 20 gets control . . . 193  
Register contents when Exit 20 passes control back to JES2 . . . . . 195  
Coded example. . . . . 195

**Chapter 33. Exit 21: SMF record . . . 197**

Function . . . . . 197  
Environment . . . . . 197

|  |     |
|--|-----|
| Task . . . . .   | 197 |
| AMODE/RMODE requirements . . . . .                                   | 197 |
| Supervisor/problem program . . . . .                                 | 197 |
| Recovery . . . . .   | 197 |
| Job exit mask . . . . .  | 197 |
| Mapping macros normally required . . . . .                           | 197 |
| Point of processing . . . . .  | 197 |
| Programming considerations . . . . .                                 | 197 |
| Register contents when Exit 21 gets control . . . . .                | 198 |
| Register contents when Exit 21 passes control back to JES2 . . . . . | 198 |
| Coded example. . . . .   | 198 |

**Chapter 34. Exit 22: Cancel/status .. 199**

|  |     |
|--|-----|
| Function . . . . .   | 199 |
| Environment . . . . .  | 199 |
| Task . . . . .   | 199 |
| AMODE/RMODE requirements . . . . .                                   | 199 |
| Supervisor/problem program . . . . .                                 | 199 |
| Recovery . . . . .   | 199 |
| Job exit mask . . . . .  | 199 |
| Mapping macros normally required . . . . .                           | 199 |
| Point of processing . . . . .  | 199 |
| Programming considerations . . . . .                                 | 199 |
| Register contents when Exit 22 gets control . . . . .                | 200 |
| Register contents when Exit 22 passes control back to JES2 . . . . . | 201 |
| Coded example. . . . .   | 202 |

**Chapter 35. Exit 23: FSS job separator page (JSPA) processing. . . . . 203**

|  |     |
|--|-----|
| Function . . . . .   | 203 |
| Recommendations for implementing Exit 23 . . . . .                   | 203 |
| Environment . . . . .  | 203 |
| Task . . . . .   | 203 |
| AMODE/RMODE requirements . . . . .                                   | 203 |
| Supervisor/problem program . . . . .                                 | 203 |
| Recovery . . . . .   | 203 |
| Job exit mask . . . . .  | 203 |
| Restrictions . . . . .   | 204 |
| Mapping macros normally required . . . . .                           | 204 |
| Point of processing . . . . .  | 204 |
| Programming considerations . . . . .                                 | 204 |
| Register contents when Exit 23 gets control . . . . .                | 204 |
| Register contents when Exit 23 passes control back to JES2 . . . . . | 205 |
| Coded example. . . . .   | 205 |

**Chapter 36. Exit 24: Post-initialization 207**

|  |     |
|--|-----|
| Function . . . . .                                       | 207 |
| Environment . . . . .                                    | 207 |
| Task . . . . .   | 207 |
| AMODE/RMODE requirements . . . . .                       | 207 |
| Supervisor/problem program . . . . .                     | 207 |
| Recovery . . . . .                                       | 207 |
| Job exit mask . . . . .                                  | 207 |
| Mapping macros normally required . . . . .               | 208 |
| Point of processing . . . . .                            | 208 |
| Creating an information string through Exit 24 . . . . . | 208 |
| Programming considerations . . . . .                     | 208 |

|  |     |
|--|-----|
| Register contents when Exit 24 gets control . . . . .                | 209 |
| Register contents when Exit 24 passes control back to JES2 . . . . . | 210 |
| Coded example. . . . .   | 210 |

**Chapter 37. Exit 25: JCT read . . . . . 211**

|  |     |
|--|-----|
| Function . . . . .   | 211 |
| Related exits. . . . .   | 211 |
| Environment . . . . .  | 211 |
| Task . . . . .   | 211 |
| AMODE/RMODE requirements . . . . .                                   | 211 |
| Supervisor/problem program . . . . .                                 | 211 |
| Recovery . . . . .   | 211 |
| Job exit mask . . . . .  | 211 |
| Mapping macros normally required . . . . .                           | 211 |
| Point of processing . . . . .  | 211 |
| Programming considerations . . . . .                                 | 212 |
| Register contents when Exit 25 gets control . . . . .                | 212 |
| Register contents when Exit 25 passes control back to JES2 . . . . . | 212 |
| Coded example. . . . .   | 213 |

**Chapter 38. Exit 26: Termination/resource release . . . . . 215**

|  |     |
|--|-----|
| Function . . . . .   | 215 |
| Environment . . . . .  | 215 |
| Task . . . . .   | 215 |
| AMODE/RMODE requirements . . . . .                                   | 215 |
| Supervisor/problem program . . . . .                                 | 215 |
| Recovery . . . . .   | 215 |
| Job exit mask . . . . .  | 215 |
| Mapping macros normally required . . . . .                           | 215 |
| Point of processing . . . . .  | 215 |
| Programming considerations . . . . .                                 | 216 |
| Register contents when Exit 26 gets control . . . . .                | 216 |
| Register contents when Exit 26 passes control back to JES2 . . . . . | 216 |
| Coded example. . . . .   | 217 |

**Chapter 39. Exit 27: PCE attach/detach . . . . . 219**

|  |     |
|--|-----|
| Function . . . . .   | 219 |
| Environment . . . . .  | 219 |
| Task . . . . .   | 219 |
| AMODE/RMODE requirements . . . . .                                   | 219 |
| Supervisor/problem program . . . . .                                 | 219 |
| Recovery . . . . .   | 219 |
| Job exit mask . . . . .  | 219 |
| Mapping macros normally required . . . . .                           | 219 |
| Point of processing . . . . .  | 219 |
| Programming considerations . . . . .                                 | 219 |
| Register contents when Exit 27 gets control . . . . .                | 219 |
| Register contents when Exit 27 passes control back to JES2 . . . . . | 220 |
| Coded example. . . . .   | 220 |

**Chapter 40. Exit 28: subsystem interface (SSI) job termination . . . . . 221**

|                    |     |
|--------------------|-----|
| Function . . . . . | 221 |
|--------------------|-----|

|  |     |
|--|-----|
| Environment . . . . .  | 221 |
| Task . . . . .   | 221 |
| AMODE/RMODE requirements . . . . .                                   | 221 |
| Supervisor/problem program . . . . .                                 | 221 |
| Recovery . . . . .   | 221 |
| Job exit mask . . . . .  | 221 |
| Mapping macros normally required . . . . .                           | 221 |
| Point of processing . . . . .  | 221 |
| Programming considerations . . . . .                                 | 221 |
| Expanding the JCT control block . . . . .                            | 222 |
| Register contents when Exit 28 gets control . . . . .                | 222 |
| Register contents when Exit 28 passes control back to JES2 . . . . . | 223 |
| Coded example. . . . .   | 223 |

**Chapter 41. Exit 29: Subsystem interface (SSI) end-of-memory . . . . . 225**

|  |     |
|--|-----|
| Function . . . . .   | 225 |
| Environment . . . . .  | 225 |
| Task . . . . .   | 225 |
| AMODE/RMODE requirements . . . . .                                   | 225 |
| Supervisor/problem program . . . . .                                 | 225 |
| Recovery . . . . .   | 225 |
| Job exit mask . . . . .  | 225 |
| Mapping macros normally required . . . . .                           | 225 |
| Point of processing . . . . .  | 225 |
| Programming considerations . . . . .                                 | 225 |
| Register contents when Exit 29 gets control . . . . .                | 225 |
| Register contents when Exit 29 passes control back to JES2 . . . . . | 226 |
| Coded example. . . . .   | 227 |

**Chapter 42. Exit 30: Subsystem interface (SSI) data set OPEN and RESTART . . . . . 229**

|  |     |
|--|-----|
| Function . . . . .   | 229 |
| Environment . . . . .  | 229 |
| Task . . . . .   | 229 |
| AMODE/RMODE requirements . . . . .                                   | 229 |
| Supervisor/problem program . . . . .                                 | 229 |
| Recovery . . . . .   | 229 |
| Job exit mask . . . . .  | 229 |
| Mapping macros normally required . . . . .                           | 229 |
| Point of processing . . . . .  | 229 |
| Programming considerations . . . . .                                 | 230 |
| Register contents when Exit 30 gets control . . . . .                | 230 |
| Register contents when Exit 30 passes control back to JES2 . . . . . | 231 |
| Coded example. . . . .   | 232 |

**Chapter 43. Exit 31: Subsystem interface (SSI) allocation . . . . . 233**

|                                      |     |
|--------------------------------------|-----|
| Function . . . . .                   | 233 |
| Environment . . . . .                | 233 |
| Task . . . . .                       | 233 |
| AMODE/RMODE requirements . . . . .   | 233 |
| Supervisor/problem program . . . . . | 233 |
| Recovery . . . . .                   | 233 |
| Job exit mask . . . . .              | 233 |

|  |     |
|--|-----|
| Mapping macros normally required . . . . .                           | 233 |
| Point of processing . . . . .  | 233 |
| Programming considerations . . . . .                                 | 233 |
| Register contents when Exit 31 gets control . . . . .                | 234 |
| Register contents when Exit 31 passes control back to JES2 . . . . . | 235 |
| Coded example. . . . .   | 236 |

**Chapter 44. Exit 32: Subsystem interface (SSI) job selection . . . . . 237**

|  |     |
|--|-----|
| Function . . . . .   | 237 |
| Related exits. . . . .   | 237 |
| Environment . . . . .  | 237 |
| Task . . . . .   | 237 |
| AMODE/RMODE requirements . . . . .                                   | 237 |
| Supervisor/problem program . . . . .                                 | 237 |
| Recovery . . . . .   | 237 |
| Job exit mask . . . . .  | 237 |
| Mapping macros normally required . . . . .                           | 237 |
| Point of processing . . . . .  | 237 |
| Programming considerations . . . . .                                 | 238 |
| Register contents when Exit 32 gets control . . . . .                | 238 |
| Register contents when Exit 32 passes control back to JES2 . . . . . | 241 |
| Coded example. . . . .   | 242 |

**Chapter 45. Exit 33: Subsystem interface (SSI) data set CLOSE . . . . . 243**

|  |     |
|--|-----|
| Function . . . . .   | 243 |
| Related exits. . . . .   | 243 |
| Environment . . . . .  | 243 |
| Task . . . . .   | 243 |
| AMODE/RMODE requirements . . . . .                                   | 243 |
| Supervisor/problem program . . . . .                                 | 243 |
| Recovery . . . . .   | 243 |
| Job exit mask . . . . .  | 243 |
| Mapping macros normally required . . . . .                           | 243 |
| Point of processing . . . . .  | 243 |
| Programming considerations . . . . .                                 | 244 |
| Register contents when Exit 33 gets control . . . . .                | 244 |
| Register contents when Exit 33 passes back control to JES2 . . . . . | 245 |
| Coded example. . . . .   | 246 |

**Chapter 46. Exit 34: Subsystem interface (SSI) data set unallocation . . . . . 247**

|  |     |
|--|-----|
| Function . . . . .   | 247 |
| Related exits. . . . .   | 247 |
| Environment . . . . .  | 247 |
| Task . . . . .   | 247 |
| AMODE/RMODE requirements . . . . .                                   | 247 |
| Supervisor/problem program . . . . .                                 | 247 |
| Recovery . . . . .   | 247 |
| Job exit mask . . . . .  | 247 |
| Mapping macros normally required . . . . .                           | 247 |
| Point of processing . . . . .  | 247 |
| Programming considerations . . . . .                                 | 247 |
| Register contents when Exit 34 gets control . . . . .                | 248 |
| Register contents when Exit 34 passes control back to JES2 . . . . . | 249 |



Coded example. . . . . 249

**Chapter 47. Exit 35: Subsystem interface (SSI) end-of-task . . . . . 251**

Function . . . . . 251  
Environment . . . . . 251  
    Task . . . . . 251  
        AMODE/RMODE requirements . . . . . 251  
        Supervisor/problem program . . . . . 251  
        Recovery . . . . . 251  
        Job exit mask . . . . . 251  
        Mapping macros normally required . . . . . 251  
Point of processing . . . . . 251  
Programming considerations . . . . . 251  
Register contents when Exit 35 gets control . . . . . 251  
Register contents when Exit 35 passes control back to JES2 . . . . . 252  
Coded example. . . . . 253

**Chapter 48. Exit 36: Pre-security authorization call. . . . . 255**

Function . . . . . 255  
Environment . . . . . 255  
    Task . . . . . 255  
        AMODE/RMODE requirements . . . . . 255  
        Supervisor/problem program . . . . . 255  
        Recovery . . . . . 255  
        Job exit mask . . . . . 255  
        Mapping macros normally required . . . . . 255  
Point of processing . . . . . 256  
Programming considerations . . . . . 256  
Register contents when Exit 36 gets control . . . . . 258  
Register contents when Exit 36 passes control back to JES2 . . . . . 260  
Coded example. . . . . 260

**Chapter 49. Exit 37: Post-security authorization call. . . . . 261**

Function . . . . . 261  
Environment . . . . . 261  
    Task . . . . . 261  
        AMODE/RMODE requirements . . . . . 261  
        Supervisor/problem program . . . . . 261  
        Recovery . . . . . 261  
        Job exit mask . . . . . 261  
        Mapping macros normally required . . . . . 261  
Point of processing . . . . . 262  
Programming considerations . . . . . 262  
Register contents when Exit 37 gets control . . . . . 262  
Register contents when Exit 37 passes control back to JES2 . . . . . 265  
Coded example. . . . . 265

**Chapter 50. Exit 38: TSO/E receive data set disposition . . . . . 267**

Function . . . . . 267  
Environment . . . . . 267  
    Task . . . . . 267  
        AMODE/RMODE requirements . . . . . 267

Supervisor/problem program . . . . . 267  
Recovery . . . . . 267  
Job exit mask . . . . . 267  
Mapping macros normally required . . . . . 268  
Point of processing . . . . . 268  
Programming considerations . . . . . 268  
Register contents when Exit 38 gets control . . . . . 268  
Register contents when Exit 38 passes control back to JES2 . . . . . 269  
Coded example. . . . . 269

**Chapter 51. Exit 39: NJE SYSOUT reception data set disposition . . . . . 271**

Function . . . . . 271  
Environment . . . . . 271  
    Task . . . . . 271  
        AMODE/RMODE requirements . . . . . 271  
        Supervisor/problem program . . . . . 271  
        Recovery . . . . . 271  
        Job exit mask . . . . . 271  
        Mapping macros normally required . . . . . 271  
Point of processing . . . . . 271  
Programming considerations . . . . . 271  
Register contents when Exit 39 gets control . . . . . 272  
Register contents when Exit 39 passes control back to JES2 . . . . . 273  
Coded example. . . . . 273

**Chapter 52. Exit 40: Modifying SYSOUT characteristics. . . . . 275**

Function . . . . . 275  
Environment . . . . . 275  
    Task . . . . . 275  
        AMODE/RMODE requirements . . . . . 275  
        Supervisor/problem program . . . . . 275  
        Recovery . . . . . 275  
        Job exit mask . . . . . 275  
        Mapping macros normally required . . . . . 275  
Point of processing . . . . . 275  
Programming considerations . . . . . 275  
Contents of registers when Exit 40 gets control . . . . . 276  
Register contents when Exit 40 passes control back to JES2 . . . . . 277  
Coded example. . . . . 278

**Chapter 53. Exit 41: Modifying output grouping key selection . . . . . 279**

Function . . . . . 279  
Environment . . . . . 279  
    Task . . . . . 279  
        AMODE/RMODE requirements . . . . . 279  
        Supervisor/problem program . . . . . 279  
        Recovery . . . . . 279  
        Job exit mask . . . . . 279  
        Mapping macros normally required . . . . . 280  
Point of processing . . . . . 280  
Programming considerations . . . . . 280  
Register contents when Exit 41 gets control . . . . . 280  
Register contents when Exit 41 passes control back to JES2 . . . . . 281

Coded example. . . . . 281

**Chapter 54. Exit 42: Modifying a notify user message . . . . . 283**

Function . . . . . 283  
Environment . . . . . 283  
    Task . . . . . 283  
        AMODE/RMODE requirements . . . . . 283  
        Supervisor/problem program . . . . . 283  
        Recovery . . . . . 283  
        Job exit mask . . . . . 283  
        Mapping macros normally required . . . . . 283  
Point of processing . . . . . 283  
Programming considerations . . . . . 284  
Register contents when Exit 42 gets control . . . . . 284  
Register contents when Exit 42 passes control back to JES2 . . . . . 285  
Coded example. . . . . 287

**Chapter 55. Exit 43: APPC/MVS TP selection/change/termination. . . . . 289**

Function . . . . . 289  
Related exits. . . . . 289  
Recommendations for implementing Exit 43 . . . . . 289  
Environment . . . . . 290  
    Task . . . . . 290  
        AMODE/RMODE requirements . . . . . 290  
        Supervisor/problem program . . . . . 290  
        Locks held before entry . . . . . 290  
        Restrictions . . . . . 290  
        Recovery . . . . . 290  
        Job exit mask . . . . . 290  
        Storage recommendations . . . . . 290  
        Mapping macros normally required . . . . . 290  
Point of processing . . . . . 290  
Programming considerations . . . . . 291  
Register contents when Exit 43 gets control . . . . . 291  
Register contents when Exit 43 passes control back to JES2 . . . . . 292  
Coded example. . . . . 292

**Chapter 56. Exit 44: JES2 converter exit (JES2 main) . . . . . 293**

Function . . . . . 293  
Related exits. . . . . 293  
Recommendations for implementing Exit 44 . . . . . 293  
Environment . . . . . 293  
    Task . . . . . 293  
        AMODE/RMODE requirements . . . . . 294  
        Supervisor/problem program . . . . . 294  
        Recovery . . . . . 294  
        Job exit mask . . . . . 294  
        Mapping macros normally required . . . . . 294  
Point of processing . . . . . 294  
Programming considerations . . . . . 294  
Register contents when Exit 44 gets control . . . . . 294  
Register contents when Exit 44 passes control back to JES2 . . . . . 296  
Coded example. . . . . 297

**Chapter 57. Exit 45: Pre-SJF service request . . . . . 299**

Function . . . . . 299  
Environment . . . . . 299  
    Task . . . . . 299  
        AMODE/RMODE requirements . . . . . 299  
        Supervisor/problem program . . . . . 299  
        Recovery . . . . . 299  
        Job exit mask . . . . . 299  
        Storage recommendations . . . . . 299  
        Mapping macros normally required . . . . . 299  
Point of processing . . . . . 299  
Programming considerations . . . . . 300  
Register contents when Exit 45 gets control . . . . . 300  
Register contents when Exit 45 passes control back to JES2 . . . . . 302  
Coded example. . . . . 303

**Chapter 58. Exit 46: Modifying an NJE data area before its transmission. . . . . 305**

Function . . . . . 305  
Related exits. . . . . 305  
Recommendations for implementing Exit 46 . . . . . 305  
Environment . . . . . 306  
    Task . . . . . 306  
        AMODE/RMODE requirements . . . . . 306  
        Supervisor/problem program . . . . . 306  
        Recovery . . . . . 306  
        Job exit mask . . . . . 306  
        Mapping macros normally required . . . . . 306  
Point of processing . . . . . 306  
Programming considerations . . . . . 306  
Register contents when Exit 46 gets control . . . . . 307  
Register contents when Exit 46 passes control back to JES2 . . . . . 308  
Coded example. . . . . 309

**Chapter 59. Exit 47: Modifying an NJE data area before receiving the rest of the NJE job . . . . . 311**

Function . . . . . 311  
Related exits. . . . . 311  
Environment . . . . . 311  
    Task . . . . . 311  
        AMODE/RMODE requirements . . . . . 311  
        Supervisor/problem program . . . . . 311  
        Recovery . . . . . 312  
        Job exit mask . . . . . 312  
        Mapping macros normally required . . . . . 312  
Point of processing . . . . . 312  
Programming considerations . . . . . 312  
Register contents when Exit 47 gets control . . . . . 312  
Register contents when Exit 47 passes control back to JES2 . . . . . 314  
Coded example. . . . . 314

**Chapter 60. Exit 48: Subsystem interface (SSI) SYSOUT data set unallocation . . . . . 315**

Function . . . . . 315  
 Environment . . . . . 315  
 Task . . . . . 315  
 AMODE/RMODE requirements . . . . . 315  
 Supervisor/problem program . . . . . 315  
 Recovery . . . . . 315  
 Job exit mask . . . . . 315  
 Mapping macros normally required . . . . . 315  
 Point of processing . . . . . 315  
 Programming considerations . . . . . 315  
 Register contents when Exit 48 gets control . . . . . 316  
 Register contents when Exit 48 passes control back to JES2 . . . . . 317  
 Coded example. . . . . 317

**Chapter 61. Exit 49: Job queue work select - QGOT . . . . . 319**

Function . . . . . 319  
 Environment . . . . . 319  
 Task . . . . . 319  
 AMODE/RMODE requirements . . . . . 319  
 Supervisor/problem program . . . . . 319  
 Recovery . . . . . 320  
 Job exit mask . . . . . 320  
 Mapping macros normally required . . . . . 320  
 Point of processing . . . . . 320  
 Programming considerations . . . . . 320  
 Register contents when Exit 49 gets control . . . . . 320  
 Register contents when Exit 49 passes control back to JES2 . . . . . 322  
 Coded example. . . . . 322

**Chapter 62. Exit 50: End of input . . . . . 323**

Function . . . . . 323  
 Recommendations for implementing Exit 50 . . . . . 323  
 Environment . . . . . 323  
 Task . . . . . 323  
 AMODE/RMODE requirements . . . . . 323  
 Supervisor/problem program . . . . . 323  
 Recovery . . . . . 323  
 Job exit mask . . . . . 324  
 Mapping macros normally required . . . . . 324  
 Point of processing . . . . . 324  
 Programming considerations . . . . . 324  
 Register contents when Exit 50 gets control . . . . . 326  
 Register contents when Exit 50 passes control back to JES2 . . . . . 328  
 Coded example. . . . . 328

**Chapter 63. Exit 51: Job phase change exit (\$QMOD) . . . . . 329**

Function . . . . . 329  
 Environment . . . . . 329  
 Task . . . . . 329  
 AMODE/RMODE requirements . . . . . 329  
 Supervisor/problem program . . . . . 329

Restrictions . . . . . 329  
 Recovery . . . . . 329  
 Job exit mask . . . . . 329  
 Mapping macros normally required . . . . . 329  
 Point of processing . . . . . 330  
 Programming considerations . . . . . 330  
 Register contents when Exit 51 gets control . . . . . 331  
 Register contents when Exit 51 passes control back to JES2 . . . . . 333  
 Coded example. . . . . 333

**Chapter 64. Exit 52: JOB/JOBGROUP JCL statement scan (JES2 user environment) . . . . . 335**

Function . . . . . 335  
 Recommendations for implementing Exit 52 . . . . . 335  
 Environment . . . . . 338  
 Task . . . . . 338  
 AMODE/RMODE requirements . . . . . 338  
 Supervisor/problem program . . . . . 338  
 Restrictions . . . . . 338  
 Recovery . . . . . 338  
 Job exit mask . . . . . 338  
 Storage recommendations . . . . . 338  
 Mapping macros normally required . . . . . 338  
 Point of processing . . . . . 338  
 Extending the JCT control block . . . . . 339  
 Programming considerations . . . . . 339  
 Register contents on entry to Exit 52. . . . . 340  
 Register contents when Exit 52 passes control back to JES2 . . . . . 343  
 Coded example. . . . . 344

**Chapter 65. Exit 53: JOB/JOBGROUP statement accounting field scan (JES2 user environment) . . . . . 345**

Function . . . . . 345  
 Related exits. . . . . 345  
 Recommendations for implementing Exit 53 . . . . . 345  
 Environment . . . . . 346  
 Task . . . . . 346  
 AMODE/RMODE requirements . . . . . 346  
 Supervisor/problem program . . . . . 346  
 Restrictions . . . . . 346  
 Recovery . . . . . 346  
 Job exit mask . . . . . 346  
 Mapping macros normally required . . . . . 346  
 Point of processing . . . . . 346  
 Extending the JCT control block . . . . . 348  
 Programming considerations . . . . . 349  
 Register contents when Exit 53 gets control . . . . . 351  
 Register contents when Exit 53 passes control back to JES2 . . . . . 353  
 Coded example. . . . . 353

**Chapter 66. Exit 54: JCL and JES2 control statement scan (JES2 user environment) . . . . . 355**

Function . . . . . 355

|  |     |
|--|-----|
| Recommendations for implementing Exit 54 . . .                       | 355 |
| Environment . . . . .  | 356 |
| Task . . . . .   | 356 |
| AMODE/RMODE requirements . . . . .                                   | 356 |
| Supervisor/problem program . . . . .                                 | 356 |
| Restriction . . . . .  | 356 |
| Recovery . . . . .   | 356 |
| Job exit mask . . . . .  | 356 |
| Mapping macros normally required . . . . .                           | 356 |
| Point of processing . . . . .  | 356 |
| Programming considerations . . . . .                                 | 357 |
| Register contents when Exit 54 gets control . . .                    | 362 |
| Register contents when Exit 54 passes control back to JES2 . . . . . | 364 |
| Coded example. . . . .   | 364 |

**Chapter 67. Exit 55: NJE SYSOUT reception data set disposition . . . . . 365**

|  |     |
|--|-----|
| Function . . . . .   | 365 |
| Environment . . . . .  | 365 |
| Task . . . . .   | 365 |
| AMODE/RMODE requirements . . . . .                                   | 365 |
| Supervisor/problem program . . . . .                                 | 365 |
| Recovery . . . . .   | 365 |
| Job exit mask . . . . .  | 365 |
| Mapping macros normally required . . . . .                           | 365 |
| Point of processing . . . . .  | 365 |
| Programming considerations . . . . .                                 | 365 |
| Register contents when Exit 55 gets control . . .                    | 366 |
| Register contents when Exit 55 passes control back to JES2 . . . . . | 367 |
| Coded example. . . . .   | 367 |

**Chapter 68. Exit 56: Modifying an NJE data area before its transmission. . . . . 369**

|  |     |
|--|-----|
| Function . . . . .   | 369 |
| Related exits. . . . .   | 369 |
| Recommendations for implementing Exit 56 . . .                       | 369 |
| Environment . . . . .  | 369 |
| Task . . . . .   | 369 |
| AMODE/RMODE requirements . . . . .                                   | 370 |
| Supervisor/problem program . . . . .                                 | 370 |
| Recovery . . . . .   | 370 |
| Job exit mask . . . . .  | 370 |
| Mapping macros normally required . . . . .                           | 370 |
| Point of processing . . . . .  | 370 |
| Programming considerations . . . . .                                 | 370 |
| Register contents when Exit 56 gets control . . .                    | 371 |
| Register contents when Exit 56 passes control back to JES2 . . . . . | 373 |
| Coded example. . . . .   | 374 |

**Chapter 69. Exit 57: Modifying an NJE data area before receiving the rest of the NJE job . . . . . 375**

|                        |     |
|------------------------|-----|
| Function . . . . .     | 375 |
| Related exits. . . . . | 375 |
| Environment . . . . .  | 375 |
| Task . . . . .         | 375 |

|  |     |
|--|-----|
| AMODE/RMODE requirements . . . . .                                   | 375 |
| Supervisor/problem program . . . . .                                 | 375 |
| Recovery . . . . .   | 375 |
| Job exit mask . . . . .  | 376 |
| Mapping macros normally required . . . . .                           | 376 |
| Point of processing . . . . .  | 376 |
| Programming considerations . . . . .                                 | 376 |
| Register contents when Exit 57 gets control . . .                    | 377 |
| Register contents when Exit 57 passes control back to JES2 . . . . . | 378 |
| Coded example. . . . .   | 379 |

**Chapter 70. Exit 58: Subsystem interface (SSI) end-of-step . . . . . 381**

|  |     |
|--|-----|
| Function . . . . .   | 381 |
| Environment . . . . .  | 381 |
| Task . . . . .   | 381 |
| AMODE/RMODE requirements . . . . .                                   | 381 |
| Supervisor/problem program . . . . .                                 | 381 |
| Recovery . . . . .   | 381 |
| Job exit mask . . . . .  | 381 |
| Mapping macros normally required . . . . .                           | 381 |
| Point of processing . . . . .  | 381 |
| Programming considerations . . . . .                                 | 381 |
| Register contents when Exit 58 gets control . . .                    | 381 |
| Register contents when Exit 58 passes control back to JES2 . . . . . | 383 |

**Chapter 71. Exit 59: JES2 converter exit (subtask) . . . . . 385**

|  |     |
|--|-----|
| Function . . . . .   | 385 |
| Related exits. . . . .   | 385 |
| Recommendations for implementing Exit 59 . . .                       | 385 |
| Environment . . . . .  | 385 |
| Task . . . . .   | 385 |
| Restrictions . . . . .   | 385 |
| AMODE/RMODE requirements . . . . .                                   | 386 |
| Supervisor/problem program . . . . .                                 | 386 |
| Recovery . . . . .   | 386 |
| Job exit mask . . . . .  | 386 |
| Storage recommendations . . . . .                                    | 386 |
| Mapping macros typically required . . . . .                          | 386 |
| Point of processing . . . . .  | 386 |
| Programming considerations . . . . .                                 | 386 |
| Register contents when Exit 59 gets control . . .                    | 387 |
| Register contents when Exit 59 passes control back to JES2 . . . . . | 388 |

**Chapter 72. Exit 60: JES2 converter exit (subtask) . . . . . 389**

|  |     |
|--|-----|
| Function . . . . .                             | 389 |
| Related exits. . . . .                         | 389 |
| Recommendations for implementing Exit 60 . . . | 389 |
| Environment . . . . .                          | 391 |
| Task . . . . .                                 | 391 |
| Restrictions . . . . .                         | 391 |
| AMODE/RMODE requirements . . . . .             | 391 |
| Supervisor/problem program . . . . .           | 391 |
| Recovery . . . . .                             | 391 |
| Job exit mask . . . . .                        | 391 |

|  |     |
|--|-----|
| Storage recommendations . . . . .                                    | 391 |
| Mapping macros normally required . . . . .                           | 392 |
| Point of processing . . . . .  | 392 |
| Programming considerations . . . . .                                 | 392 |
| Register contents when Exit 60 gets control . . . . .                | 392 |
| Register contents when Exit 60 passes control back to JES2 . . . . . | 394 |
| Coded example. . . . .   | 395 |

**Chapter 73. JES2 exit migration considerations . . . . . 397**

|  |     |
|--|-----|
| JES2 z/OS V1R11 migration details . . . . .                | 397 |
| JES2 z/OS V1R11 checkpoint activation . . . . .            | 397 |
| JES2 z/OS V1R11 exits and macros . . . . .                 | 397 |
| JES2 z/OS V2R1 migration details . . . . .                 | 398 |
| JES2 z/OS 2.1 input phase processing . . . . .             | 398 |
| JES2 z/OS 2.1 conversion phase processing . . . . .        | 399 |
| JES2 z/OS 2.1 data structure processing . . . . .          | 400 |
| JES2 z/OS 2.1 Exit 6 considerations . . . . .              | 400 |
| JES2 z/OS 2.1 Exit 7 and Exit 8 considerations . . . . .   | 401 |
| JES2 z/OS 2.1 Exit 36 and Exit 37 considerations . . . . . | 401 |
| JES2 z/OS 2.1 Exit 44 considerations . . . . .             | 401 |
| JES2 z/OS 2.1 Exit 59 considerations . . . . .             | 401 |

**Appendix A. JES2 exit usage limitations . . . . . 403**

**Appendix B. Sample code for Exit 17 and Exit 18 . . . . . 405**

**Appendix C. Job-related exit scenarios . . . . . 409**

|                         |     |
|-------------------------|-----|
| Exit sequence . . . . . | 409 |
|-------------------------|-----|

|  |     |
|--|-----|
| Selected exits . . . . .               | 410 |
| SPOOL control blocks . . . . .         | 412 |
| Checkpoint control blocks . . . . .    | 413 |
| \$JCT/JMR relationship . . . . .       | 417 |
| Input phase . . . . .                  | 418 |
| Job input sources . . . . .            | 418 |
| Job input service processing . . . . . | 419 |
| Conversion phase . . . . .             | 421 |
| Execution phase . . . . .              | 424 |
| Spin phase . . . . .                   | 427 |
| Output phase . . . . .                 | 427 |
| Hardcopy phase . . . . .               | 428 |
| NJE hardcopy phase exits . . . . .     | 430 |
| Purge phase . . . . .                  | 430 |

**Appendix D. Accessibility . . . . . 433**

|   |     |
|---|-----|
| Accessibility features . . . . .                    | 433 |
| Consult assistive technologies . . . . .            | 433 |
| Keyboard navigation of the user interface . . . . . | 433 |
| Dotted decimal syntax diagrams . . . . .            | 433 |

**Notices . . . . . 437**

|   |     |
|---|-----|
| Policy for unsupported hardware. . . . .    | 438 |
| Minimum supported hardware . . . . .        | 439 |
| Programming Interface Information . . . . . | 439 |
| Trademarks . . . . .                        | 439 |

**Index . . . . . 441**



---

## Figures

|   |    |  |     |
|---|----|--|-----|
| 1. Areas of JES2 modification . . . . .   | 2  | 7. Example of an Exit Routine Employing a User<br>Defined Exit . . . . .       | 42  |
| 2. A JES2 Exit . . . . .  | 4  | 8. Example of Providing Multiple Exits within a<br>Single Load Module. . . . . | 48  |
| 3. EXIT Point Variations . . . . .  | 4  | 9. Exit Routines Load Module . . . . .   | 52  |
| 4. JES2 and FSS Address Spaces . . . . .  | 10 | 10. Exit Placement . . . . .   | 54  |
| 5. Methods of Packaging an Exit Routine . . . . .                                   | 30 | 11. Job input sources . . . . .  | 418 |
| 6. Example of Assembly and Link-Edit of a<br>Installation-Written Routine . . . . . | 41 |  |     |





---

## Tables

|    |   |   |     |     |   |     |
|----|---|---|-----|-----|---|-----|
| 1. | JES2-Provided Global Assembler Variables (&VERSION and &J2VRSN) for Currently Supported JES2 Releases . . . . . | 16  |     | 11. | Selected JES2 Job Control Table Fields        | 347 |
| 2. | Directed Load and Use of Modules Based on LOADMOD(jxxxxxx) STORAGE= Specification . . . . .                     | 29  |     | 12. | Reader and converter exits usage . . . . .    | 403 |
| 3. | Exit Selection Table . . . . .  | 65  |     | 13. | Job-Related Exits . . . . .                   | 410 |
| 4. | Exit Implementation Table . . . . .   | 75  |     | 14. | \$JCT/JMR Definitions. . . . .                | 417 |
|    | 5.  | Selected JES2 Job Control Table Fields      | 100 | 15. | Job Input Service Exits - Main Task . . . . . | 419 |
|    | 6.  | Old/New Comparison of JES2 Commands         | 118 | 16. | Job Input Service Exits - User Environment    | 420 |
|    | 7.  | Comparison of Exit 11 and Exit 12 . . . . . | 151 | 17. | Conversion phase processing . . . . .         | 422 |
|    | 8.  | Comparison of Exit 12 and Exit 11 . . . . . | 157 | 18. | Execution Phase Exits . . . . .               | 424 |
|    | 9.  | Security Function Codes . . . . .           | 256 | 19. | Spin Phase Processing . . . . .               | 427 |
|    | 10.   | Security Function Codes . . . . .           | 263 | 20. | Output Phase Processing. . . . .              | 427 |
|    |   |   |     | 21. | Hardcopy Phase Processing . . . . .           | 429 |
|    |   |   |     | 22. | NJE Hardcopy Phase Processing . . . . .       | 430 |
|    |   |   |     | 23. | Purge Phase Exits . . . . .                   | 430 |



---

## About this document

This document supports z/OS® (5650-ZOS).

This document provides system programming information concerning the use of IBM-defined and installation-defined JES2 exit routines. It describes how to establish JES2 exit routines to tailor JES2 without in-line source code modification.

---

## Who should use this document

This document is intended for JES2 system programmers or for anyone responsible for customizing JES2.

---

## How this document is organized

The organization and content of this document is as follows:

- Chapter 1 describes the processing concepts of JES2 exits.
- Chapter 2 describes how to write an exit.
- Chapter 3 lists the IBM-defined exits, describes how to choose which exits to implement, and what to consider when writing an exit routine.
- Appendix A describes JES2 exit usage limitations.
- Appendix B provides sample code for Exits 17 and Exit 18.
- Appendix C describes job-related exit scenarios.
- Appendix D describes z/OS product accessibility.

---

## Where to find more information

This document references the following documents for further details about specific topics. Abbreviated forms of these are used throughout this document. The following table lists all abbreviated titles, full titles, and their order numbers that are not listed in *z/OS V2R2 Information Roadmap*. See that document for all z/OS documents.

| Short Title Used in This document   | Title   | Order Number |
|-------------------------------------|---|--------------|
| <i>CICS/ESA Customization Guide</i> | <i>CICS/ESA Customization Guide</i>                               | SC33-1165    |
|                                     | <i>A Structured Approach to Describing and Searching Problems</i> | SC34-2129    |

---

## Additional information

Additional information about z/OS elements can be found in the following documents.

| Title   | Order Number | Description  |
|---|--------------|--|
| <i>z/OS V2R2 Introduction and Release Guide</i> | GA32-0887    | Describes the contents and benefits of z/OS as well as the planned packaging and delivery of this new product. |

| Title  | Order Number | Description   |
|--|--------------|---|
| <i>z/OS Planning for Installation</i>                | GA32-0890    | Contains information that lets users: <ul style="list-style-type: none"> <li>• Understand the content of z/OS</li> <li>• Plan to get z/OS up and running</li> <li>• Install the code</li> <li>• Take the appropriate migration actions</li> <li>• Test the z/OS system</li> </ul> |
| <i>z/OS V2R2 Information Roadmap</i>                 | SA23-2299    | Describes the information associated with z/OS including z/OS documents and documents for the participating elements.   |
| <i>z/OS Summary of Message and Interface Changes</i> | SA23-2300    | Describes the changes to messages for individual elements of z/OS.<br><b>Note:</b> This document is provided in softcopy only on the message bookshelf of the z/OS collection kit.  |

---

## How to send your comments to IBM

We appreciate your input on this publication. Feel free to comment on the clarity, accuracy, and completeness of the information or provide any other feedback that you have.

Use one of the following methods to send your comments:

1. Send an email to [mhvrcfs@us.ibm.com](mailto:mhvrcfs@us.ibm.com).
2. Send an email from the "Contact us" web page for z/OS (<http://www.ibm.com/systems/z/os/zos/webqs.html>).

Include the following information:

- Your name and address.
- Your email address.
- Your telephone or fax number.
- The publication title and order number:  
z/OS V2R2 JES2 Installation Exits  
SA32-0995-02
- The topic and page number that is related to your comment.
- The text of your comment.

When you send comments to IBM, you grant IBM a nonexclusive right to use or distribute the comments in any way appropriate without incurring any obligation to you.

IBM or any other organizations use the personal information that you supply to contact you only about the issues that you submit.

---

## If you have a technical problem

Do not use the feedback methods that are listed for sending comments. Instead, take one of the following actions:

- Contact your IBM service representative.
- Call IBM technical support.
- Visit the IBM Support Portal at z/OS Support Portal (<http://www-947.ibm.com/systems/support/z/zos/>).



---

## Summary of changes for z/OS Version 2 Release 2 (V2R2) as updated December, 2015

The following changes are made for z/OS V2R2 as updated December, 2015.

### Changed

- Modified Exits 20 and 51 for job groups. For Exit 20, see “Programming considerations” on page 192 and for Exit 51 see “Register contents when Exit 51 gets control” on page 331.

---

## Summary of changes for z/OS Version 2 Release 2 (V2R2)

The following changes are made in z/OS Version 2 Release 2 (V2R2).

### New

- Added new field, X002ECLT and new bits, X002J2CL and X002J3CL to exit 2. See “Register contents on entry to exit 2” on page 93.
- Added new field, X003ECLT and new bits X003J2CL and X003J3CL to exit 3. See “Register contents when Exit 3 gets control” on page 104.
- Added programming considerations note to Exit 9. See “Programming considerations” on page 142.
- Added new field names X044JCLS and X044SCHE under register 1 of exit 44 and notes to programming considerations. See “Register contents when Exit 44 gets control” on page 294, “Register contents when Exit 44 passes control back to JES2” on page 296 and “Programming considerations” on page 294.
- Added new field, X052ECLT and new bits X052J2CL and X052J3CL to exit 52. See “Register contents on entry to Exit 52” on page 340.
- Added new field, X053ECLT and new bits X053J2CL and X053J3CL to exit 53. See “Register contents when Exit 53 gets control” on page 351.

### Changed

- Added note about High-Level Assembler option not being supported. See “Language” on page 7.
- Modified Exits 2, 3, 4, 20, 50, 52, 53, and 54 to change JOB to JOB/JOBGROUP and job to job/job group. See Chapter 15, “Exit 2: JOB/JOBGROUP JCL statement scan (JES2 main task),” on page 89, Chapter 16, “Exit 3: JOB/JOBGROUP statement accounting field scan (JES2 main task),” on page 99, Chapter 17, “Exit 4: JCL and JES2 control statement scan (JES2 main task),” on page 107, Chapter 32, “Exit 20: End of input,” on page 191, Chapter 62, “Exit 50: End of input,” on page 323, Chapter 64, “Exit 52: JOB/JOBGROUP JCL statement scan (JES2 user environment),” on page 335, Chapter 65, “Exit 53: JOB/JOBGROUP statement accounting field scan (JES2 user environment),” on page 345 and Chapter 66, “Exit 54: JCL and JES2 control statement scan (JES2 user environment),” on page 355.
- Added programming considerations note to exit 3. See “Programming considerations” on page 102.
- Added field name X003JCLS to register 0 to exit 3. See “Register contents when Exit 3 gets control” on page 104.
- Modified byte 1, byte 3, register 0, and register 1 of exit 32. See “Register contents when Exit 32 gets control” on page 238.

- Added field name X053J for CLS to register 0 to exit 53. See “Register contents when Exit 53 gets control” on page 351.
- Added programming considerations note to exit 53. See “Programming considerations” on page 349.

### **Deleted**

- None.

## **z/OS Version 2 Release 1 summary of changes**

See the following publications for all enhancements to z/OS Version 2 Release 1 (V2R1):

- *z/OS V2R2 Migration*
- *z/OS Planning for Installation*
- *z/OS Summary of Message and Interface Changes*
- *z/OS V2R2 Introduction and Release Guide*



---

## Chapter 1. Introduction

JES2 is a general job entry subsystem of z/OS and sometimes cannot satisfy all installation-specific needs at a given installation. If you modify JES2 code to accomplish your specific functions, you then are susceptible to the migration and maintenance implications that result from installing new versions of JES2. JES2 exits allow you to modify JES2 processing without directly affecting JES2 code. In this way, you keep your modifications independent of JES2 code, making migration to new JES2 versions easier and making maintenance less troublesome.

### Support statements

#### Attention:

Defining exits and writing installation exit routines is intended to be accomplished by experienced system programmers; the reader is assumed to have knowledge of JES2.

If you want to customize JES2, IBM suggests that you use JES2 installation exits to accomplish this task.

**IBM does not recommend or support alteration of JES2 source code.** If you assume the risk of modifying JES2, then also assure your modifications do not impact JES2 serviceability using IPCS. Otherwise, IBM® Level 2 Support might not be able to read JES2 dumps taken for problems unrelated to the modifications.

Avoid expanding JES2 control blocks. Use alternatives such as:

1. Use fields dedicated for installation use that appear in many major control blocks. Place your data, or a pointer to your data, in these fields. However, beware of setting storage addresses in checkpointed or SPOOL-resident control blocks.
2. Use \$JCTX services rather than modifying \$JCT.
3. Use table pairs and dynamic tables. For example, use dynamic \$BERTTABS with CBOFF=\* instead of modifying \$JQE.

This is a partial list. Evaluate your specific situation and take appropriate action.

#### Note:

JES2 operates in full-function mode (z2 mode under z/OS). All discussion in this document assumes JES2 is running in z2 mode. See Chapter 73, "JES2 exit migration considerations," on page 397 for migration topics.

Figure 1 on page 2, and the text that follows it, illustrates many of those areas where you can modify JES2 processing using the JES2 exit facility:

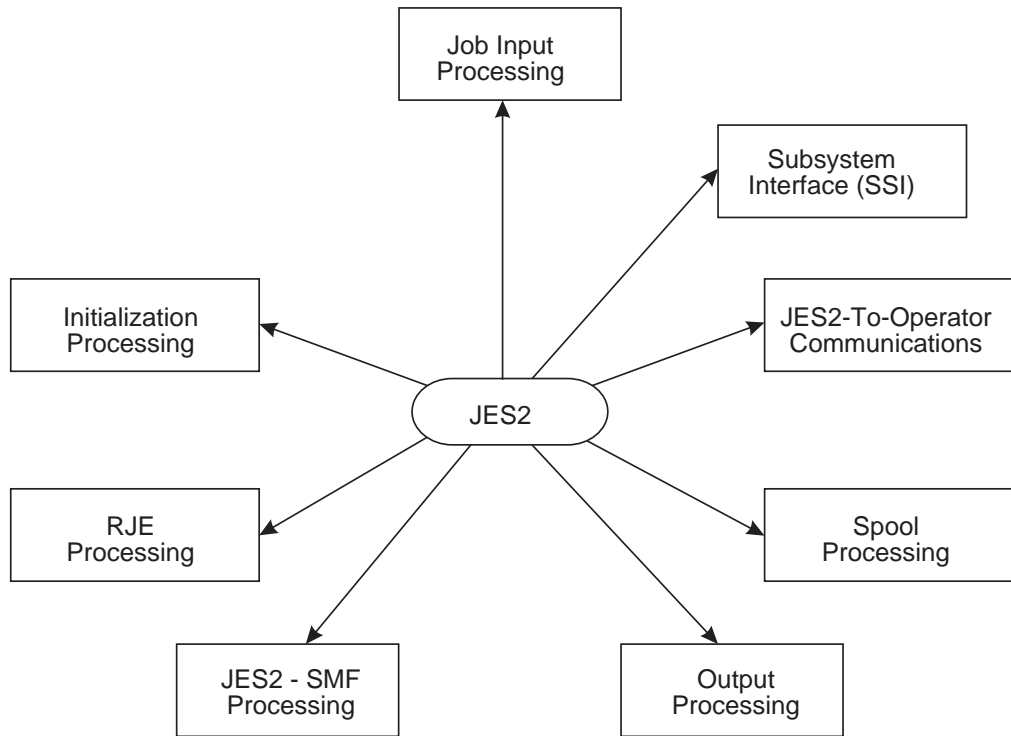

Figure 1. Areas of JES2 modification

- *Initialization Processing*  
You can modify the JES2 initialization process and incorporate your own installation-defined initialization statements in the initialization process. Also, you can change JES2 control blocks before the end of JES2 initialization.
- *Job Input Processing*  
You can modify how JES2 scans and interprets a job's JCL and JES2 control statements. Also, you can establish a job's affinity, execution node, and priority assignments before the job actually runs.
- *Subsystem Interface (SSI) Processing*  
You can control how JES2 performs SSI processing in the following areas: job selection and termination, subsystem data set OPEN, RESTART, allocation, CLOSE, unallocation, end-of-task, and end-of-memory.
- *JES2-to-Operator Communications*  
You can tailor how JES2 communicates with the operator and implement additional operator communications for various installation-specific conditions. Also, you can preprocess operator commands and alter, if necessary, subsequent processing.
- *Spool Processing*  
You can alter how JES2 allocates spool space for jobs.
- *Output Processing*  
You can selectively create your own unique print and punch separator pages for your installation output on a job, copy, or data set basis.
- *JES2-SMF Processing*  
You can supply to SMF added information in SMF records.
- *RJE Processing*

You can implement additional security checks to control your RJE processing and gather statistics about signons and signoffs.

---

## What is a JES2 exit?

JES2 exits provide a clean, convenient, relatively stable interface between JES2 and your installation-written code. Installation-written exit routines are invoked from standard JES2 processing at various strategic locations in JES2 source code. These strategic locations in JES2 source code are called *exit points*. A JES2 exit is established by one or more exit points.

An exit point is defined by the \$EXIT macro and, as illustrated in Figure 2 on page 4, is the exact location in JES2 code where JES2 can pass control to your *exit routine* (that is, your installation-written code). The JES2 exit, identified by the “exit-id code” of nnn, is defined by one exit point at label JLBL in the JES2 code. It is at JLBL in JES2 processing that JES2 passes control to your exit routine.

To use the exit facility you perform the following steps, as illustrated in Figure 2 on page 4.

1. Package your code into one or more exit routines, identifying each exit routine with an entry point name. (In Figure 2 on page 4 there is a series of exit routines noted as entry points X1...Xn.) Then include the exit routine in a load module. In this case LMOD is the load module containing the exit routine.
2. In the JES2 initialization stream include the LOADmod(jxxxxxx) initialization statement, which causes your exit routine's load module to be loaded into either private (PVT), common (CSA), or to locate the module in link pack area (LPA) storage. The linkage editor RMODE attribute determines whether the system loads the module above or below 16 megabytes.

Also include the EXIT(nnn) initialization statement, which associates your exit routines' entry point with the exit point in the JES2 code. The EXIT(nnn) initialization statement matches the exit point “nnn” at label JLBL for the \$EXIT macro in the JES2 code. The EXIT(nnn) initialization statement identifies the label “X1” as the entry point of the exit routine for exit point “nnn”. The LOAD initialization statement identifies LMOD as the load module to be loaded into storage.

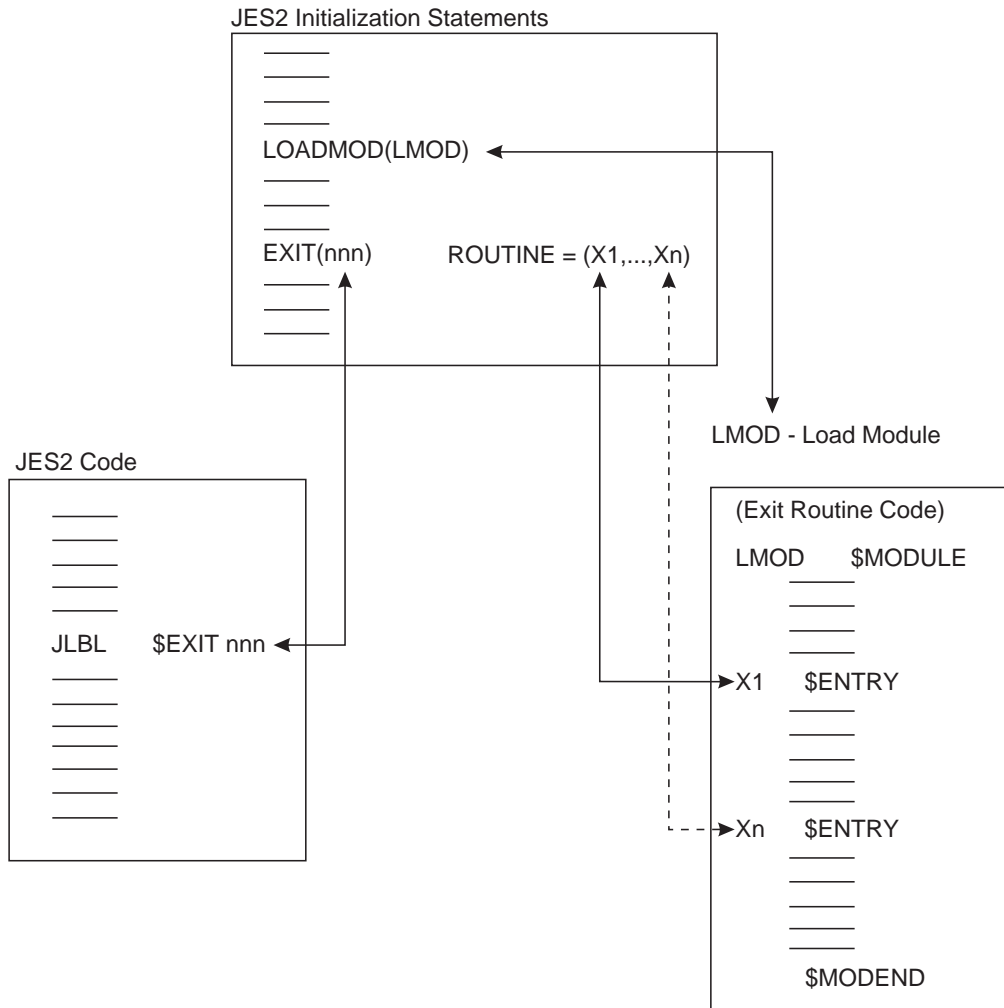

Figure 2. A JES2 Exit

JES2 can have up to 256 exits, each identified by a number from 0 to 255. You specify the number on the required “exit-id code” parameter on the \$EXIT macro.

This exit-id code identifies the JES2 exit. When more than one exit point is defined for a single exit, the \$EXIT macros that defined the multiple exit points have unique labels but are all specified with the same exit-id code – see Figure 3.

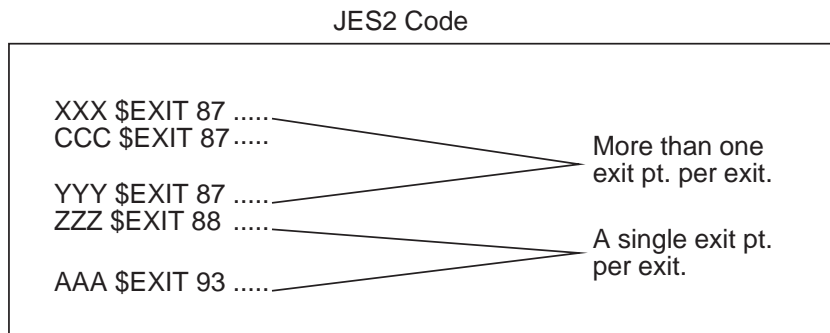

Figure 3. EXIT Point Variations

JES2 code includes a number of *IBM-defined exits*. That is, various exit points – through the \$EXIT macro – have already been strategically placed in the JES2 code. The intended purpose of each of these exits is summarized in Table 3 on page 65. For these IBM-defined exits you need only write your own exit routines and incorporate them through the EXIT(nnn) initialization statement and the LOADmod(jxxxxxx). The selection of the point in JES2 code where the exit point should be placed has already been done for you. To ensure a proper implementation, you should thoroughly understand the IBM-defined exit and its JES2 operating environment. A comprehensive description of each exit is presented in Chapter 12, “IBM-defined exits,” on page 65.

Also, the JES2 exit facility allows you to establish your own exits, should the IBM-defined exits not suffice. Exits established by you are modifications to JES2 and are called *installation-defined exits*, and you define them by placing the \$EXIT macro yourself at appropriate points in the JES2 code (or in your own exit routine code). Note, however, that implementing your own exit can be considerably more difficult than writing an exit routine for an IBM-defined exit. You should realize that in establishing your own exits, you run a greater risk of disruption when installing a new version of JES2 code. The new JES2 code into which you have placed your exits may have significantly changed since your \$EXIT macros were inserted. For more information, see Chapter 10, “Establishing installation-defined exits,” on page 59.

Every exit, both IBM-defined and installation-defined, has a status of *enabled* or *disabled* which is set at initialization through the EXIT(nnn) initialization statement and which can be dynamically altered by the \$T EXIT(nnn) operator command. When an exit is enabled, JES2 checks for the existence of an associated exit routine and then passes control to the exit routine. If no associated exits are found, standard JES2 processing continues. For certain exits, called *job-related exits*, (see “Job-related exits” on page 55) the status can be altered on a job-by-job basis by the action of an exit routine. When an exit is disabled for a particular job (by use of the job mask), it is automatically bypassed by standard JES2 processing.

## Environment

The following topics describe the environment in which the JES2 exits run.

### General

JES2 operates in four environments: JES2 main task, JES2 subtask, user environment, and functional subsystem (FSS) environment. Your exit routine receives control as fully-authorized extensions of JES2, and as such receives control in one of these four environments depending on where the associated exit point is placed. JES2 main task and subtask exit points exist in the HASJES20 load module.

### Program authority

Your exit routine has access to various control blocks and service routines to which the standard JES2 code has access at the exit point, and it runs with the same authorization as the JES2 code from which your exit routine was invoked. Exit routines invoked from the JES2 address space run in supervisor state in either the JES2 main task or JES2 subtask environment with a protect key of “1”. Exit routines invoked from the user environment execute in key 0. Exit routines invoked from the functional subsystem (FSS) address space run in the FSS environment and typically run in protect key 1 (as set by the FSS). Also, exit routines invoked from the FSS address space have access to all service routines supported by HASPFSSM.

## Exit linkage

A JES2 *exit effector* provides linkage services between an exit point and exit routines. It locates and passes control to your exit routines and returns control to JES2. There are two exit effectors: one provides linkage to exit routines that run as extensions to the JES2 main task and the other provides linkage to exit routines that run as extensions to JES2 subtasks or as extensions to routines in the user address space or the FSS.

## Return codes

Your exit routines can affect JES2 processing by directly manipulating JES2 data areas and by passing back return codes. You can have up to 256 individual exit routines associated with a single exit on the EXIT(nnn) initialization statement. These *multiple exit routines* are all called consecutively in the order of their appearance on the EXIT(nnn) initialization statement. Consider the following example:

```
EXIT(175) ROUTINE=(X1,X2,X3,X4,X5,...)
```

For Exit 175, the exit routine identified by label X1 is called before the exit routine identified by X2, and so forth, until all of them (X1 through X5) are called or until one of them generates a nonzero return code, which causes the exit effector to return to the JES2 mainline after the exit point.

## Installation

IBM suggests that any modifications to JES2 code or the installation of JES2 exits be performed utilizing the functions of SMP/E (System Modification Program Extended). This requires the preparation of SMP/E control statements and constructs suitable for SMP/E processing. Applying changes in an SMP/E-controlled environment prevents down-leveling or the application of release incompatible maintenance.

In the case of JES2 exits, if the application of PTF maintenance changes any macros or other components used by the exits, then the affected modules will automatically be reassembled by SMP/E.

For more information about SMP/E, see *SMP/E for z/OS User's Guide*

**Note:** No exit routines are ever required as part of standard JES2 processing. The JES2 exit facility is fully optional. If you have not implemented an exit—that is, if you have not written an exit routine for it, or have not included the exit routine in a load module, or have not associated the routine with the exit at initialization time—the presence of the exit point or points that establish the exit is transparent during standard JES2 processing.

---

## Chapter 2. Writing an exit routine

When you are planning to write a JES2 exit routine, you need to consider the environment in which the exit routine runs and other general programming considerations (such as, the programming language to use to code your exit routine, linkage conventions that are required, return codes to set, and reentrant code requirements to follow). Chapter 12, “IBM-defined exits,” on page 65 provides the specific programming considerations you need for writing exit routines for the IBM-defined exits. You should use Chapter 12, “IBM-defined exits,” on page 65 with the information in this chapter when writing your exit routine. Should you decide to implement your own installation-defined exit in JES2, you need to investigate all the exit-specific programming considerations yourself. See Chapter 10, “Establishing installation-defined exits,” on page 59 for more information.

**Note:** All exit modules must be in APF authorized libraries.

---

### Language

You must write JES2 installation exit routines in basic assembled language. To assemble JES2 or installation exit routines, use High-Level Assembler or any compatible IBM assembler.

**Note:** High-Level Assembler COMPAT(SYSLIST) option is not supported.

---

### Operating environment

For security reasons, the caller of an installation-defined exit in the user's address space must be either in supervisor state or be an authorized program. JES2 will terminate a calling routine with neither of these attributes with a privileged operation exception.

---

### JES2 environments

**When writing an exit routine, you must consider the calling JES2 environment,** because your exit routine runs as an extension of that calling environment (JES2 main task, JES2 subtask, user address space, and functional subsystem). The calling environment has broad implications to your exit routine; it determines the JES2 system services available to your exit routine, the reentry considerations you should consider, the linkage conventions that are necessary, and several other essential factors (such as, control block access, synchronization, recovery, and JES2 programmer macro usage). Specifically, the use of macros in exit routines is limited. Before attempting to use a particular macro in an exit routine, be certain to check the “Environment” section of each macro description in Chapter 4 to determine the environments in which the macro can be used.

Every exit is explicitly defined to JES2 as belonging to one of the four execution environments. The ENVIRON= operand of the \$MODULE macro is specified as either “JES2”, “SUBTASK”, “USER”, or “FSS”. This specification determines which of two exit effectors (the JES2 subroutines that establish the linkage between JES2 and an exit routine) will be called when the exit is enabled. One exit effector establishes linkage to an exit routine from the JES2 main task environment; the other establishes linkage to an exit routine from either the JES2 subtask

environment, the user environment or the FSS. In all environments (JES2 main task, functional subsystem, subtask, and user environment) JES2 linkage conventions (that is, \$SAVE and \$RETURN) are used.

You cannot define an exit “across” environments. That is, when an exit is required to serve the same purpose in two distinct environments, two separate exits must be defined, each with its own identification number. For example, Exit 11, an IBM-defined exit that can give you control to reset the spool partitioning mask, belongs to the JES2 main task environment. Exit 12, which serves the same functional purpose, belongs to the user environment. In implementing these exits, you must write a separate exit routine for each defined exit and adapt the routine to its calling environment.

To stress again, whether defining an exit or writing an exit routine, you must be aware of the operating environment; it influences where your exit is to be defined or what processing your exit routine can really perform. In the descriptions of the following general programming considerations for writing an exit routine, specific environmental influences are described.

JES2 has four execution environments - maintask, subtask, user, and functional subsystem (FSS).

1. **JES2 Main Task** - The JES2 main task is the most common operating environment for JES2 exits. The JES2 main task routines are included in the JES2 load module HASJES20 which is loaded in the private area of the JES2 address space. JES2 main task routines run under the control of the JES2 dispatcher (in HASPNUC). The load module, HASPINIT, which performs JES2 initialization, runs under the main task but is not controlled by the JES2 dispatcher.

The execution of maintask routines, with the exception of asynchronous routines such as I/O appendages, are controlled by the JES2 dispatcher and are represented by a dispatching unit called processor control elements (\$PCEs). \$PCEs, which are analogous to task control blocks (TCBs) in MVS™, are the dispatchable elements in JES2 maintask.

There are two important coding considerations in the JES2 maintask environment.

- **JES2 Reentrancy** - An exit routine called from the JES2 main task must be reentrant in the JES2 sense. Because JES2 processors (\$PCEs) do not relinquish control to another JES2 processor involuntarily, an exit routine, invoked out of a main task processor may use a JES2 nonreentrant work area. Therefore, the work area is serialized unless the exit routine issues a \$WAIT macro (or service called from an exit routine issues the \$WAIT macro). When the exit routine issues the \$WAIT macro directly or through a called routine, control returns to the JES2 dispatcher and the serialization on the nonreentrant work area ceases. The nonreentrant work area may also be passed between exit routines, or between an exit routine and JES2, before a \$WAIT macro call. Work areas to be used “across” a \$WAIT must either be within the processor's work area established as part of the \$PCE or else must be directly owned by the processor. In the same JES2 reentrant sense, an exit routine may search or manipulate a JES2 queue (for example, job queue or job output table) providing it has ownership of the queue (through the \$QSUSE macro) and doesn't issue a \$WAIT macro until the search routine is completed.
- **MVS WAITs** - The JES2 dispatcher controls all processing within the maintask environment; therefore, no routine or exit may issue any macro or



call any service that could result in the execution of an MVS WAIT macro. Issuing MVS WAITs in JES2 maintask is contrary to the design of JES2 and will cause performance problems.

An exception to this rule is JES2 initialization and JES2 termination. During initialization and termination, maintask processing is essentially single threaded. That is, there is only one \$PCE dispatched so that JES2 reentrancy is not a factor. This also removes the concern about MVS WAITs causing a performance problem because during JES2 initialization and termination JES2 is not providing system services for other subsystems, started tasks, time sharing sessions and batch jobs. Therefore, there are no restrictions about MVS WAITs and MVS macros that can result in MVS WAITs in JES2 exits 0, 19, 24, and 26.

If it is necessary to invoke MVS services from JES2 maintask exits that may cause MVS waits, these services should be invoked from a subtask environment. The \$SUBIT macro can be used to cause a routine to execute in a subtask environment. The WAIT/POST synchronization of the subtask is provided as part of this service.

2. **JES2 Subtask** - JES2 subtasks run in the private area of the JES2 address space but run asynchronously with the JES2 main task. Subtasks run under the control of the MVS dispatcher (not the JES2 dispatcher) and their asynchronous operation allows them to perform the WAIT/POST type processing without imposing the same WAIT/POST operations on the JES2 main task. System-wide MVS services are available to programs in this environment.

Many JES2 maintask data areas are directly addressable, but users of these resources must understand when and where serialization of these resources is relevant. Most importantly, subtask should not directly reference the checkpoint area (job queue, job output table, and so on), because in certain portions of the checkpoint cycle this storage area is not addressable. If a subtask requires a view of the checkpoint, use the JES2 checkpoint versioning facility and the appropriate SSI calls.

3. **User Environment** - Some JES2 routines are loaded into common storage (located either in extended or non-extended LPA, PLPA, or CSA) execute in the user's address space. This environment, which permits user programs to interface with JES2, differs greatly from the JES2 maintask environment. System-wide MVS services are available to programs in this environment, but the environment is also more complex. It involves many integrity, synchronization, locking and cross-address space communications considerations. JES2 services in the user environment are limited.

A special operating environment you can use called (USER,ANY). It is intended for environments where a routine is able to be invoked in the USER run-time environment, or under the JES2 main task. For example, Use (USER,ANY) to write a common routine invoked by both Exit 2 and Exit 52. To use it, you can code ENVIRON=(USER,ANY) on your \$MODULE statement or on a \$ENVIRON macro invocation. The (USER,ANY) environment is similar to the USER environment (for instance, R11 is the HCCT address) except for the following differences in the way that \$SAVE and \$RETURN services are implemented:

- a. If the routine is called by the JES2 main task, JES2 main task \$SAVE/\$RETURN services are called. This allows the possibility of a \$WAIT within the routine. With a user-environment \$SAVE that uses the linkage stack, this processing is not possible.
- b. In any environment, a PSV-type save area is obtained rather than using a BAKR to save the registers and environment. This allows services such as \$STORE and \$RESTORE to be used in any environment.

4. **FSS Environment** - The functional subsystem (FSS) resides in the functional subsystem address space. This environment is similar to the user environment in that JES2 services are limited. You must consider task interaction within the FSS. All data areas and control blocks are not accessible from the FSS. The accessible control blocks are the job output element (\$JOE) JOE information block (\$JIB), FSS control block (FSSCB), and FSA control block (FSACB). System-wide MVS services are available to programs in this environment.

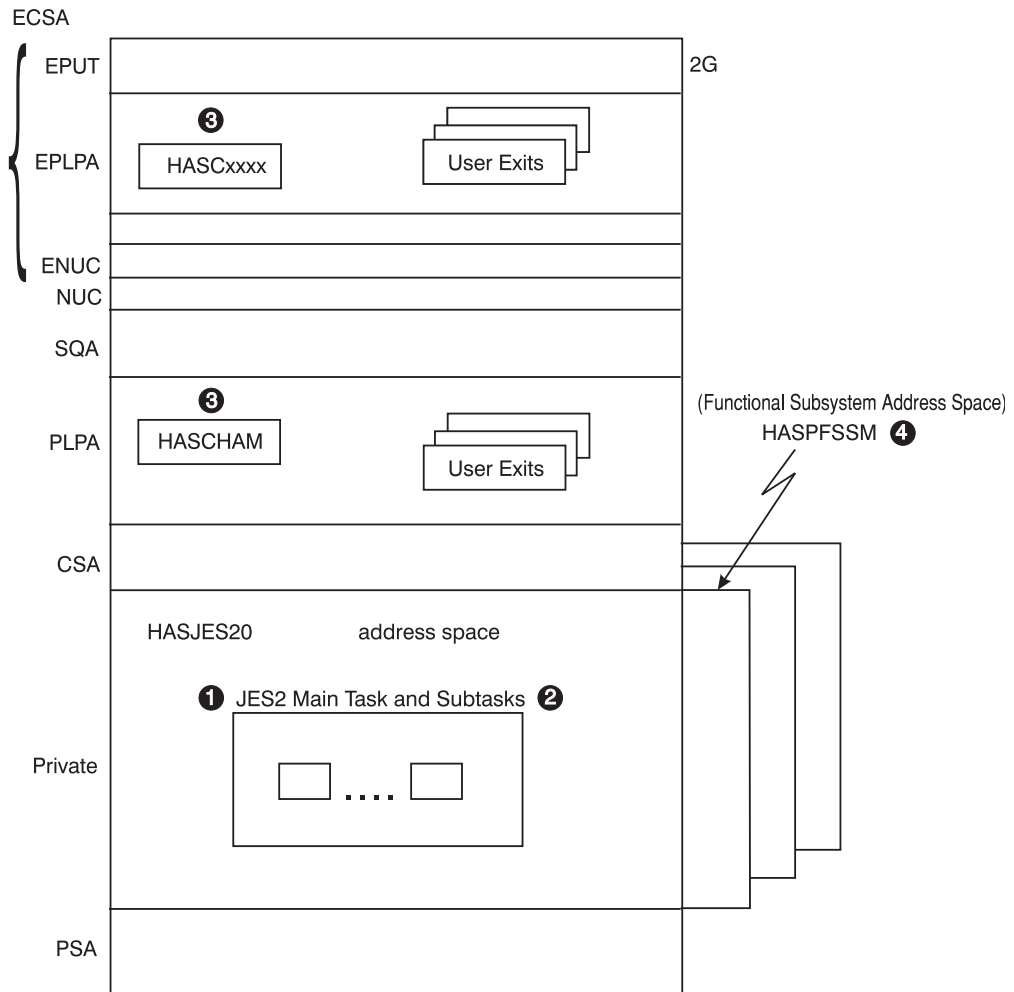

Figure 4. JES2 and FSS Address Spaces

## Synchronization

An exit routine must use synchronization services appropriate to its calling environment.

An exit routine called from the JES2 main task must use the JES2 \$WAIT macro to wait for a JES2 event, resource, or post of a MVS ECB. An exit routine called from a JES2 subtask or from the user environment must use the MVS WAIT macro to wait for a system event. An exit routine called from a functional subsystem must also use MVS WAIT; \$WAIT and \$POST are not valid in this environment.

A JES2 main task exit routine should *not* invoke operating system services which may wait (WAIT), either voluntarily or involuntarily. Be aware of any product that

interfaces with JES2 and attempts to issue MVS services such as STIMER, STIMERM, WAIT, or TTIMER under the JES2 main task, or which invoke MVS services such as allocation, which may issue such macros. An MVS wait from a JES2 main task exit routine would stop all of the JES2 main task processors, including any devices—such as readers, printers, and remote terminals—under their control.

---

## Reentrant code considerations

Reentrant code considerations are contingent on the calling environment.

An exit routine called from the JES2 main task must be reentrant in the JES2 sense. The JES2 dispatching unit, commonly called JES2 processors, running under a processor control element (PCE) perform the processing for the JES2 main task. The JES2 dispatcher controls what PCE is currently active (that is, what JES2 processor is currently running). Because a JES2 processor doesn't relinquish control to another JES2 processor involuntarily, an exit routine, invoked out of a JES2 main task processor may use a nonreentrant work area; the work area is serialized if the exit routine doesn't issue a \$WAIT macro or until the exit routine or service called from an exit routine does issue the \$WAIT macro. When the exit routine issues the \$WAIT macro directly or through a called routine, control returns to the JES2 dispatcher and the serialization on the nonreentrant work area ceases. The nonreentrant work area may also be passed between exit routines, or between an exit routine and JES2, before a \$WAIT macro call. Work areas to be used "across" a \$WAIT must either be within the processor work area established as part of the processor control element (PCE) or else must be directly owned by the processor. In the same JES2 reentrant sense, an exit routine may search or manipulate a JES2 queue providing it has ownership of the queue and doesn't issue a \$WAIT macro until this action is completed.

An exit routine called from a JES2 subtask, from the user environment, or from the FSS environment must be reentrant in the MVS sense. The exit routine must be capable of taking an MVS interrupt at any point in its processing. The exit routine must be able to handle the simultaneity of execution with other subtasks and user address space, or functional subsystem (FSS) routines and with the JES2 main task.

The following actions may produce unpredictable results:

- Modifying control block fields designed for use by the JES2 main task only (for example, \$DOUBLE, \$GENWORK, and so on.)
- Accessing checkpointed data from the subtask, user, or FSS environment.

---

## Linkage conventions

When control is passed to an exit routine, certain general registers contain linkage information. Register 15 always contains the entry point address of the exit routine, and can be used to establish addressability for the exit routine's code. Register 14 contains the address (in the exit effector) to which the exit routine must return control. In the JES2 main task environment, register 13 always contains the address of the processor control element (PCE) of the processor that invoked the exit. In the JES2 subtask environment or the user environment, register 13 always contains the address of an 18-word save area. In the JES2 main task and subtask environments, register 11 always contains the address of the HCT; and in the functional subsystem environment (HASPFSSM), register 11 always contains the address of the HASP functional subsystem communications table (HFCT). In the user environment, register 11 always contains the address of the HASP common

communication table (HCCT). Depending on the exit, registers 0 and 1 might be in use as parameter registers. The use of registers 2 through 10 and 12, typically used as pointer registers, is also exit-dependent.

Some JES2 services are running in 64-bit addressing mode. These services, regardless of whether they are called directly or invoked by a macro, need register 11 to contain a 64-bit pointer to the HCT, HCCT, or HFCT. When JES2 invokes an exit, it ensures that register 11 is a valid 64-bit pointer. Because exits should not need to know which services are running in 64-bit addressing mode, the invoked exit should not corrupt the high order 33 bits of register 11 before invoking any JES2 service.

The use of registers 0 through 15 is documented, for each IBM-defined exit, in the category REGISTER CONTENTS WHEN CONTROL IS PASSED TO THE EXIT ROUTINE. Note that if you install an optional installation-defined exit, you are responsible for modifying JES2 code, preceding your exit, to load any parameters in registers 0 and 1 and any pointers in registers 2 through 10 and 12 that are required by your exit routine.

For multiple exit routines, the exit effector passes registers 2 through 13 to each succeeding exit routine just as they were originally loaded by JES2 when the exit was first invoked. However, register 15 contains the entry point address of the current exit routine and, again, can be used to establish addressability for the exit routine's code. Register 14 contains the address to which the exit routine must return control. This allows you to pass the information to consecutive exit routines. For more information, see Chapter 7, "Multiple exit routines in a single module," on page 47.

**When any exit routine receives control, it must save the caller's registers.** An exit routine called from any environment can save the caller's registers by issuing the JES2 \$SAVE macro.

**When any exit routine relinquishes control, it must restore the caller's registers,** except for registers 0, 1, and 15. An exit routine called from any environment must restore the caller's registers by issuing the JES2 \$RETURN macro.

Just before returning control to JES2, an exit routine must place a return code in register 15 and must place any parameters that it intends to pass, either back to JES2 or to the next consecutive exit routine, in registers 0 and 1. If the return code is greater than zero, or if the current exit routine is the last or only exit routine associated with its exit, this return code is passed back to JES2 at the point of invocation, along with any parameters placed in registers 0 and 1. If, however, the return code is zero and the current exit routine is not the last or only exit routine associated with its exit, the exit effector passes control to the next consecutive exit routine, along with any parameters placed in registers 0 and 1.

IBM suggests that when using BAKR/PR instructions for routine linkage, that you do not use the JES2 dispatching service, \$WAIT, or call any other routines that may result in a \$WAIT. JES2 uses a process of sub-dispatching units of work (PCEs), under a single task.

BAKR is an instruction where a linkage-stack branch stat entry is formed. If a stack entry is created while a unit of work (PCE) is in control and that unit of work is suspended by use of the \$WAIT macro, then the next unit of work to get control could change the state of these stack. Unpredictable results will occur when the PCE that was \$WAITED gets control back and issues a PR instruction.

Special processing in the JES2 dispatcher detects when a PCE issues a \$WAIT while there is something on the linkage stack. An abend, with reason code \$DP2, will be issued to prevent this logic error from propagating more problems. Note that you can use the \$STORE macro before the \$RETURN macro to modify the returned values of registers 0 and 1.

---

## Addressing mode of JES2 exits

All JES2 code (except those sections of code associated with restricted MVS services) runs in 31-bit addressing mode. In this manner, JES2 is able to take advantage of the increased virtual storage provided by the operating system 31-bit addressing mode. (See *z/OS MVS Programming: Assembler Services Guide* for a more complete discussion of 31-bit addressing and required operating systems considerations.)

### Addressing mode requirements

All JES2 exit routines:

- are entered in 31-bit addressing mode
- return in 31-bit addressing mode
- must have all input address parameters to the exit in 31-bit fields. (Although some addresses may be restricted to below a 16-megabyte address for example, the \$PRPUT, \$PBLOCK, and \$SEPPDIR service routines. These should use the \$GETBUF macro to obtain HASP-type buffers because of this restriction.)
- must be compatible with all referenced control blocks

The addressing mode may be changed within an exit by using the \$AMODE macro. It is the user's responsibility to understand the addressing mode considerations of each exit and control the mode accordingly. See the \$AMODE macro description for more information.

### Residency mode requirements

All JES2 installation exits can have a residency mode (RMODE) of ANY. To set the residency mode of an exit assembly module, use the RMODE= parameter on the \$MODULE macro. To set the residency mode of a load module, use the linkage editor's MODE statement.

---

## Received parameters

Received parameters, passed by either JES2 or the preceding exit routine in registers 0 and 1, provide a method of passing information to an exit routine and of informing an exit routine of the current point of processing. For any IBM-defined exit that passes parameters (to the first or only associated exit routine), the specific parameters are documented in the REGISTER CONTENTS WHEN CONTROL IS PASSED TO THE EXIT ROUTINE category of the exit's description. IBM-defined Exit 6, which allows you to receive control both during and after the conversion of a job's JCL to converter/interpreter (C/I) text, presents a typical example. After a single JCL statement has been converted to an C/I text image, Exit 6 places a zero in register 0. After all of the JCL for a particular job has been converted to C/I text, Exit 6 places a 4 in register 0. Your exit routine can determine what action to take by checking this code when it first receives control.

For some exits, the parameter registers also contain pointers to control blocks, to certain control block fields, or to other parameter lists. For a discussion of an exit routine's use of control blocks, see the "Control Blocks" section below.

The received parameters are passed, as modified, from routine to routine. Note that if you install an installation-defined exit, you must ensure that JES2 passes any parameters required by your exit routine in registers 0 and 1; this may require some modification of JES2 source code.

---

## Return codes

A return code provides a convenient way for an exit routine to affect the course of following JES2 processing.

The standard return codes are 0 and 4. If 0 is returned by an exit routine that is not the last or the only exit routine associated with its exit, the exit effector calls the next consecutive exit routine. However, a 0 returned by the last or only exit routine associated with its exit directs JES2 to proceed with standard processing. A 4 returned by any exit routine directs JES2 to proceed unconditionally with standard processing; any succeeding exit routines remain uncalled.

Note that a standard return code does not necessarily suggest that an exit routine has opted to take no action. You can write an exit routine to manipulate certain JES2 data areas and then, by generating a standard return code, direct JES2 to continue with normal processing *based on this altered data*.

The definition of return codes that are greater than 4 is exit-dependent. The specific implementation of return of return codes greater than 4 is documented for each exit under the category, RETURN CODES in each exit's description. A brief indication of the standard processing that results from the return of 0 or 4 is also included for each exit. Note that if you install an optional installation-defined exit, you are responsible for modifying JES2 code, following your exit, to receive and act on any return code greater than 4 generated by your exit routine.

A return code is always a multiple of 4. If your exit routine passes a return code other than 0 or another multiple of 4 to JES2, results are unpredictable. Also, the \$EXIT exit-point definition macro has a MAXRC= operand that specifies the exit's maximum acceptable return code. If your exit routine generates a return code that exceeds this specification and the exit was called from the JES2 main task, the exit effector issues the \$ERROR macro. If the exit was called from a JES2 subtask, from the user environment, or from the FSS environment, the exit effector issues the ABEND macro.

---

## Control blocks

An exit routine has access to various control blocks available in the environment from which it was called.

To simplify exit coding IBM-defined exit routines provide in registers 0-13 pointers to control blocks currently in main storage. Register 1 can contain a pointer to a parameter list, which contains the addresses of control blocks currently in main storage. For a list of the specific pointers provided by an IBM-defined exit, see the REGISTER CONTENTS WHEN CONTROL IS PASSED TO THE EXIT ROUTINE category of the particular exit's description. Note that if you install an installation-defined exit, you have to ensure that any pointers required by your exit routine have been placed in the call registers by JES2 before invocation of your exit; this may require some modification of JES2 source code.

An exit routine can access information available in control blocks. For example, IBM-defined Exit 5, which allows you to perform your own JES2 command

preprocessing, passes the address of the PCE to an associated exit routine. You can write your own command validation algorithm by writing an exit routine that checks various command-information fields in the PCE.

**CAUTION:**

**Because an exit routine runs fully authorized, it is free to alter any field in any control block to which it has access. By altering specific fields in specific JES2 control blocks, an exit routine can pass information to JES2 and to succeeding exit routines and can thereby affect the course of later JES2 processing. Note that JES2 has no protection against any change made to any control block by an exit routine. If you modify a checkpointed control block, you must ensure that it is written to the checkpoint data set either by your exit routine or by JES2. For this reason, you should exercise extreme caution in making control block alterations.**

Avoid expanding JES2 control blocks. Use alternatives such as:

- Use fields dedicated for installation use that appear in many major control blocks. Place your data, or a pointer to your data, in these fields. However, beware of setting storage address in checkpointed or SPOOL resident control blocks.
- Use \$JCTX services rather than modifying \$JCT.
- Use table pairs and dynamic tables. For example, use dynamic \$BERTTABs with CBOFF=\* instead of modifying \$JQE.

This is a partial list. Evaluate your specific situation and take appropriate action.

Except where it would seriously degrade system performance, JES2 provides a reasonable amount of space in its standard control blocks for use by your exit routines. Some storage-resident control blocks, such as PCEs and DCTs, have storage reserved for exit routine use. You can use this storage to establish your own exit-related field or fields within a standard control block or, if you require more storage, you can use four of the bytes as a pointer to a work area acquired by an exit routine using the JES2 \$GETMAIN, \$GETBUF, and \$GETWORK macros or the MVS GETMAIN macro. Disk-resident control blocks provide considerably more space for exit routine use. For performance reasons, no checkpoint-resident control blocks reserve space for use by exit routines.

In addition to using reserved space in the standard JES2 control blocks, you can define and use your own installation-specific control blocks by using the JES2 exit facility. An exit routine can use the JES2 \$GETMAIN, \$GETBUF, and \$GETWORK macros or the MVS GETMAIN macro to acquire storage and build a control block at the appropriate point in processing. For example, a job-related control block can be built by an exit routine associated with IBM-defined Exit 2. You can then use IBM-defined Exits 7 and 8 to write your exit. installation-defined control blocks to spool and to read them from spool into main storage.

Note that if an exit routine references the symbolic name of a control block field, the DSECT for that control block must be requested in the exit routine's module at assembly time (through the \$MODULE macro). Each exit description includes a list of DSECTs normally required at assembly.

An exit routine that needs to access checkpoint control blocks must use appropriate access services. See "Checkpoint control blocks" on page 413 for more information.

---

## Determining the JES2 release level

Other code, whether other IBM program product code, Solution Developer code, or installation-written code might need to determine what level of JES2 is installed. This can be important so that such code can determine what support is required within that code or what support JES2 provides for a particular release. The JES2-provided global assembler variables, `&VERSION` and `&J2VRSN`, provide this indication. Table 1 provides the variable string associated with currently supported releases of JES2.

*Table 1. JES2-Provided Global Assembler Variables (&VERSION and &J2VRSN) for Currently Supported JES2 Releases*

| JES2 Version and Release             | &VERSION and &J2VRSN String |
|--------------------------------------|-----------------------------|
| SP5.1.0                              | 'SP 5.1.0'                  |
| SP5.2.0                              | 'SP 5.2.0'                  |
| OS/390 <sup>®</sup> V1 R1 and higher | 'SP 5.3.0'                  |

Based on the `&VERSION` or `&J2VRSN` value, the value of the string increases for each successive JES2 release. Note that for OS/390 R1 JES2 IBM uses a string value of 'SP 5.3.0' to protect this collating sequence. Consider this value stable and not to be changed or incremented in the future.

To accommodate future JES2 releases, use the following assembly-time variables (also valid for JES2-supported releases if you have installed APAR OW17462):

### Variable

#### Description and Use

#### `&J2LEVEL`

- **Value:** Same as listed in Table 1 except for:

#### Release

##### Value

#### OS/390 R1

'OS 1.1.0'

#### OS/390 R3

'OS 1.3.0'

#### OS/390 R4

'OS 2.4.0'

#### OS/390 R5

'OS 2.5.0'

#### OS/390 R7

'OS 2.7.0'

#### OS/390 R8

'OS 2.8.0'

#### OS/390 R10

'OS 2.10'

#### z/OS V1R2

'z/OS 1.2'

#### z/OS V1R4

'z/OS 1.4'



**z/OS V1R5**  
'z/OS 1.5'

**z/OS V1R7**  
'z/OS 1.7'

**z/OS V1R8**  
'z/OS 1.8'

**z/OS V1R9**  
z/OS 1.9 'z/OS 1.9'

**z/OS V1R10**  
z/OS 1.10 'z/OS1.10'

**z/OS V1R11**  
z/OS 1.11 'z/OS1.11'

**z/OS V1R12**  
z/OS 1.12 'z/OS1.12'

**z/OS V1R13**  
z/OS 1.13 'z/OS1.13'

**z/OS V2R1**  
z/OS 2.1 'z/OS 2.1'

- **Description:** 8-byte string defined as are &VERSION and &J2VRSN
- **HCT Field:** \$LEVEL is &J2LEVEL (OS/390 only)
- **HCCT Field:** CCTLEVEL is &J2LEVEL (OS/390 only)
- **Note:** The format of this field is an 8-byte EBCDIC string; however, **do not** rely upon the string data for release-to-release comparisons, use &J2PLVL for that purpose.

#### **&J2PLVL**

- **Value:** A numeric value that increases by at least a value of 1 for each successive JES2 release.
- **Description:** A value that corresponds to a specific JES2 product release level as follows:

**JES2 Version/ Release**  
**&J2PLVL Value**

**SP5.1.0**  
24

**SP5.2.0**  
25

**OS/390 R1**  
26

**OS/390 R3**  
27

**OS/390 R4**  
28

**OS/390 R5**  
29

**OS/390 R7**  
30

**OS/390 R8**

31

**OS/390 R10**

32

**z/OS 1.2**

33

**z/OS 1.4**

34

**z/OS 1.5**

35

**z/OS 1.7**

36

**z/OS 1.8**

37

**z/OS 1.9**

38

**z/OS 1.10**

39

**z/OS 1.11**

40

**z/OS 1.12**

41

**z/OS 1.13**

42

**z/OS 2.1**

43

- **HCT Field:** \$PLVL is &J2PLVL (OS/390 only)
- **HCCT Field:** CCTPLVL is &J2PLVL (OS/390 only)
- **Note:** The value itself has no inherent meaning.

#### **&J2SLVL**

- **Value:** 0 when a new &J2PLVL is created
- **Description:** A service level within the product level updated for significant JES2 updates
- **HCT Field:** \$SLVL is &J2SLVL(OS/390 only)
- **HCCT Field:** CCTSLVL is &J2SLVL (OS/390 only)
- **Note:** This value will never decrease within a specific value of &J2PLVL

#### **Programming Notes:**

- OS/390  
Run-time field SSCTSUSE points to a 10-byte field structured as follows:  
**Byte 1-8**  
CCTLEVEL  
**Byte 9-10**  
CCTPLVL and CCTSLVL (concatenated)
- Pre-OS/390

Run-time field SSCTSUSE points to an 8-byte field structured as follows:

**Byte 1-8**

CCTPVRSM

Run-time field CCTPVRSM in the HCCT is an 8-byte field that provides the &VERSION / &J2VRSN String as listed in Table 1 on page 16 or stabilized to 'SP 5.3.0' for OS/390.

---

## Service routine usage

Many service routines available to the JES2 main task are also available on an exit routine called from the JES2 main task. You can include an executable JES2 macro instruction at any appropriate point in a JES2 main task exit routine. Not all service routines are available to the functional subsystem environment; those that can be called must be appropriate. Depending on the macro, it provides inline code expansion at assembly time or else calls a JES2 service routine, as a subroutine, in execution.

An exit routine called from a JES2 subtask or from the user environment can use any JES2 service routine that can be called from its environment and any MVS service routine (SVC) that can be called from its environment. You can include a JES2- or MVS-executable macro instruction at any appropriate point in the subtask or user routine. Again, depending on the macro, it provides inline code expansion at assembly time or else calls a JES2 or MVS service routine, as a subroutine, in execution.

---

## Exit logic

Using an exit for other than its intended purpose can increase the risk of degraded performance and system failure and may cause migration problems.

Within the scope of an exit's intended purpose, you have a wide degree of flexibility in devising exit algorithms. For example, you can base spool partitioning on a simple factor, such as job class, or on a complex comparison of several job attributes and current spool volume usage. However, you should remember that as you increase an algorithm's sophistication, you also increase overhead and the risk of error. Exit-specific logic considerations are provided in the "Other Programming Considerations" category for each exit description.

Logic considerations for installing installation-defined exits and for implementing them are provided in Chapter 10, "Establishing installation-defined exits," on page 59.

Note, for both IBM-defined and installation-defined exits, that the ability to associate multiple exit routines with a single exit allows you to devise modular logic segments. Each separate function to be performed after exit invocation can be isolated in its own exit routine. This can be especially useful when you need to provide alternate types of exit processing for different received parameters.

---

## Exit-to-exit communication

Communication among exit routines must be accomplished through mutually accessible control blocks.

---

## Exit point-to-exit routine communication

Several JES2 installation exits, such as installation exits 27 through 35 contain a **condition byte** that provide a means of passing information to your exit routine. JES2 sets this byte to indicate the status of the environment at the time the exit is called. Check the bit settings in this byte to determine what (if any) processing should be done by your exit routine. See the "Register Contents When The Exit Routine Gets Control" section of each exit description for the meaning of the condition byte.

---

## Exit routine-to exit point communication

These same exits provide an interface for your exit routine to inform the caller of your exit of the results of your exit's processing. You turn on bits in the **response byte** to pass this information to the caller. This gives the caller a cumulative response from all exit routines invoked to help the caller determine how to proceed when control is returned to it. Your exit should **not** turn bits in the response byte off, as there are some occasions when some bits of the response byte are turned on initially before control is given to your exit.

---

## Exit-to-operator communication

Except for exit routines called from the HASPCOMM module of HASJES20 and exit routines called from JES2 initialization and termination, exit routines called from the JES2 main task environment can communicate with the operator through the \$WTO macro. Exit routines called from the HASPCOMM module can communicate with the JES2 operator through the \$CWTO macro. Exit routines called from a JES2 subtask or during JES2 initialization and termination can communicate with the operator through the \$\$WTO and \$\$WTOR macros or through the MVS WTO and WTOR macros. Exit routines called from the user environment or functional subsystem environment can communicate with the operator through the MVS WTO and WTOR macros. Note that, if a message is to be associated with jobs processed by a functional subsystem, the job id must be included with the message. notification. Exits 2, 3, and 4 allow you to send an exit-generated message to the operator along with certain return codes by setting a flag in the RXITFLAG byte. Exit 5 allows you to control the standard \$CRET macro "OK" message and to send your own exit-generated message text through the \$CRET macro. Exit 9 allows you to control the standard output overflow message. Exit 10 allows you control over the text and routing of all \$WTO messages. For details, see the individual exit descriptions.

---

## Required mapping macros

Depending on the environment in which an exit executes, you will need to provide the appropriate set of mapping macros to map storage areas. Below, listed by environment, are the standard mapping macros required in order that your exit routine will assemble properly. The DSECTID for the mapping macro should be specified on the \$MODULE macro. You should also note that individual exits also require other specific mapping macros. These are listed under the "DSECTIDs TO BE SPECIFIED ON \$MODULE" heading provided for each exit.

**Note:** The addition of \$MODULE in each exit will cause JES2 to pull in required mapping macros. However, all macros should be explicitly coded to prevent the return of MNOTEs and the possibility of assembly errors. Be certain your exit routines conform to JES2 coding conventions. This will allow easier diagnosis if an error should occur.

## JES2 main task environment exits

- 0-5
- 7
- 10-11
- 14-22
- 24
- 26-27
- 38
- 39
- 40
- 44
- 46-47
- 49
- 51

### **Assuming you minimally code the following for each exit**

- COPY \$HASPGBL
- \$MODULE
- \$ENTRY
- \$SAVE
- \$RETURN
- \$MODEND
- END

### **Required macros**

- \$CADDR (required by \$MODULE)
- \$HASPEQU (required by \$MODULE)
- \$HCT (required by \$MODULE)
- \$MIT (required by \$MODULE)
- \$PADDR (required by \$MODULE)
- \$PARMLST (required by \$MODULE)
- \$PSV (required by \$MODULE)
- \$PCE (required by \$MODULE)
- \$USERCBS (required by \$MODULE)

## JES2 subtask environment exits

- 6
- 8
- 12

### **Assuming you minimally code the following for each exit**

- COPY \$HASPGBL
- \$MODULE
- \$ENTRY
- \$SAVE
- \$RETURN
- \$MODEND

- END

### **Required macros**

- \$CADDR (required by \$MODULE)
- \$HASPEQU (required by \$MODULE)
- \$HCT (required by \$MODULE)
- \$MIT (required by \$MODULE)
- \$PADDR (required by \$MODULE)
- \$PARMLST (required by \$MODULE)
- \$PSV (required by \$MODULE)
- \$USERCBS (required by \$MODULE)

## **Functional subsystem address space environment exits**

- 23
- 25

### **Assuming you minimally code the following for each exit**

- COPY \$HASPGBL
- \$MODULE
- \$ENTRY
- \$SAVE
- \$RETURN
- \$MODEND
- END

### **Required macros**

- \$CADDR (required by \$MODULE)
- ETD (required to support \$HFCT)
- FSIP (required to support \$HFCT)
- \$HASPEQU (required by \$MODULE)
- \$HFCT (required by \$MODULE)
- \$MIT (required by \$MODULE)
- \$PADDR (required by \$MODULE)
- \$PARMLST (required by \$MODULE)
- \$PSV (required by \$MODULE)

## **User environment exits**

- 8-9
- 12
- 28-37
- 41-43
- 45
- 48
- 50
- 52-60

## Assuming you minimally code the following for each exit

- COPY \$HASPGBL
- \$MODULE
- \$ENTRY
- \$SAVE
- \$RETURN
- \$MODEND
- END

## Required macros

- \$CADDR (required by \$MODULE)
- \$HASPEQU (required by \$MODULE)
- \$HCCT (required by \$MODULE)
- \$MIT (required by \$MODULE)
- \$PADDR (required by \$MODULE)
- \$PSV (required by \$MODULE)
- \$USERCBS (required by \$MODULE)

The following programming considerations describe some specific requirements for coding your exit routine:

- Naming and Identifying an Exit Routine

You must begin each exit routine with the JES2 \$ENTRY macro, which you use to name the routine and to identify it to JES2.

For more information, see “Packaging Exit Routines” later in this chapter.

Note that you have flexibility in naming your exit routines, under standard labeling conventions except for Exit 0 (see the description of Exit 0 in Chapter 12, “IBM-defined exits,” on page 65 for more detail).

- Exit Addressability

The \$ENTRY macro is also used to generate a USING statement for your exit routine. The BASE= operand is used to specify the register or registers which provide addressability when the exit routine gets control. However, the \$ENTRY macro does not load the base register.

- Source Module Conventions

The construction of a source module must follow certain conventions depending on how you intend to package the exit routine. Through these conventions, JES2 is able to locate both exit routines and exit points within a module.

- Security

When deciding on whether to implement a specific exit routine, you should consider whether installing a security product with your other system software could satisfy your requirements. You should also consider the affect an exit routine could have in terms of your installation's security policy. Your security auditing may be inaccurate if you change security information in a control block in an exit that occurs after access to a resource has already been granted without additional validation. Similarly, changes made to security information by an exit that occurs before validation, could cause the validation to fail.

- DBCS Assembly Option

DBCS (Double-byte Character Set) is an option that may be invoked when doing assemblies. DBCS is a means of providing support for languages which contain too many symbols to be represented by a single byte character set such as EBCDIC. JES2 supports the High-Level Assembler DBCS option for JES2 exit

routines. All JES2 macros integral in a customer's JES2 exit will abide by DBCS option rules, including the continuation line logic. JES2 macros will not have the same characters specified in both columns 71 and 72. This would be interpreted as a special DBCS continuation character. IBM does not support the DBCS option for reassembly of its modules.

---

## User environment exit considerations

### Reentrancy

JES2 main task exits do not need to be reentrant because there is only one task running in the module at a time. However, multiple tasks can be running code in a user environment exit simultaneously. All user environment exits should be reentrant. The following are some reentrancy problems often overlooked in JES2 exits:

- Building messages directly in data constants in the local CSECT instead of using a work area.
- \$\$WTO processing that sets the command character at the start of a message, even though the message does not have any replaceable text.
- Inline parameter lists used by MVS macros, such as ENQ and DEQ.
- Storing routine addresses into local (CSECT) storage areas.

### Accessing CKPTed Data Area

If you are running code in one of the user environment exits, you might need to access data that is in the JES2 checkpoint data set. To facilitate this, JES2 maintains a "live checkpoint version" in the checkpoint version data space. This live version is an IARVserv shared copy of the instorage checkpoint data set. It is updated by the main task as your exit is looking at the data. It is not advisable to run chains in the live version because the chains can be altered by the main task as you run them. However, if you know where a needed data area is located (a JQE or a JOE for example), and the data area is not going away (it is busy on your device), using a live version is a way to obtain the latest checkpoint data.

If you are in a user environment exit working with a NJE/TCP device (that is you are running in a NETSERV address space), the following code accesses an IASDSERV data area that points to the live version (xx in xxWNSST is SR, ST, JR, or JT for the appropriate device dependent area) :

```

USING DSERV,R5          Est DSERV addressability
SPACE 1
L   R5,xxWNSST          Get NSST address
LAE R5,0(R5)            Clear access register
L   R5,NSSNSCT-NSST(,R5) Get NSCT address
L   R5,NSCDSERV-NSCT(,R5) Get live DSERV addr

```

If you are not sure whether or not you are in a NETSERV address space, you can obtain an IAZDSERV for the live version using the \$DSERV macro. For example:

```

$DSERV FUNC=GET,        Get DSERV
        LIVE=YES,       Use "live" version
        DSERV=(R2)      Save address in R2
:
Code using DSERV in R2
:
$DSERV FUNC=FREE,       Free DSERV
        DSERV=(R2)      Address of DSERV to free

```



## Accessing \$CATs

Input processing exits might need to access a \$CAT to get values for a job being received or being submitted. To access a \$CAT, you need to get an IAZDSERV for a live version, and then obtain a \$CAT from that live version. For example:

```
$DSERV FUNC=GET,      Get DSERV
        LIVE=YES,     Use "live" version
        DSERV=(R2)    Save address in R2
SPACE 1
$DOGCAT ACTION=(FETCH,READ), Get CAT for job class
        JOBCLASS=JRWDBLE,
        DSERV=(R2)
LR      R3,R1         Get CAT address
SPACE 1
USING CAT,R3         DECLARE CAT ADDRESSABILITY
:
Process $CAT in R3
:
$DOGCAT ACTION=RETURN,CAT=CAT Return CAT storage
SPACE 1
$DSERV FUNC=FREE,     Free DSERV
        DSERV=(R2)    Address of DSERV to free
SPACE 1
DROP R3              DROP CAT ADDRESSABILITY
```

If you are implementing code that will only be running in a NETSERV address space, you can replace the \$DSERV calls with the code from the "Accessing CKPTed Data Area" example to obtain the IAZDSERV from the \$NSCT.

## Storage considerations

If an exit requires additional storage, use a subpool other than 0, 240 or 250. Storage allocated in subpool 0 (or in subpools 240 and 250, which are converted to subpool 0 requests) are given a storage key of 0 and SHARED with the jobstep TCB. This can cause any program running in a key other than 0 under the jobstep TCB to experience protection exceptions (abend0c4 rc04) if the program obtained storage in subpool 0 and attempt to modify it.

---

## One time exit initialization code

Some exits want to perform initialization code the first time they are called, for example loading a service module or building a table needed for processing. However, if this is a user environment exit, it is not running in the JES2 address space and is not main task serialized. Without some special serialization (such as an ENQ), it is possible that the code is actually being run simultaneously by two exit invocations. Also, if a data area is being obtained or a module is being loaded, it is possible that the storage is freed when the current address space terminates.

It is easiest to place any one time initialization logic in the post initialization exit 24. If data addresses need to be passed to other exits, either a \$CUCT (an area pointed to by CCTCUCT in the \$HCCT) can be used for a data address or a \$UCADDR (an area pointed to by CCTUCADD and used by \$CALL) can be used for a routine address. Another option is to use a named token. \$TOKENSR provides a JES2 interface to the MVS Name/Token service. You can use tokens to store data that is needed at some later point in processing.

---

## Tracing

Minimal tracing of exit invocation can be performed automatically as part of the exit facility. For this tracing to occur, three conditions are necessary:

1. The trace ID for exit tracing (ID 13) must be enabled.
2. The EXIT(nnn) initialization statement or the \$T EXIT(nnn) operator command must have enabled tracing. For more information, see Chapter 9, “Tracing status,” on page 57.
3. Tracing must be active (TRACEDEF ACTIVE=YES).

This automatic tracing produces a limited trace entry containing such general information as exit point identification, register contents at the time of exit invocation, and the contents of the \$XPL (if part of the \$EXIT interface).

Also, to further trace execution of exit routine code, issue the standard JES2 \$TRACE macro call within an exit routine. This results in a full trace record of exit routine processing.

It is recommended that you use tracing to its fullest extent only in your testing cycle, and that you limit its use in those areas of the standard processing environment—for example, in conversion processing—where it is most likely to degrade system performance.

---

## Recovery

An exit routine *should not* depend on JES2 for recovery. JES2 cannot anticipate the exact purpose of an exit routine and, therefore, any standard JES2 recovery that happens to be in effect when your exit routine is called is, at best, minimal for your particular needs. In other areas of processing, *no* JES2 recovery environment is in effect, and an exit routine error has the potential to cause JES2 to fail. Consequently, *you should provide your own recovery mechanisms within your exit routines.*

For all exits routines for which you provide an \$ESTAE routine, also be certain to add the error recovery area DSECT, \$ERA, to the \$MODULE macro. On entry into the recovery routine set up by \$ESTAE, register 1 points to the ERA.

You can use the standard JES2 \$ESTAE recovery mechanisms in implementing your own recovery within the JES2 main task. You can use the MVS ESTAE recovery mechanism in implementing your own recovery in the SUBTASK, USER, or FSS environments. When recovering in the SUBTASK environment, JES2 frees the save areas associated with the abending subtask. Your recovery should not depend on the presence of a particular save area.

At minimum, a recovery mechanism should place a 0 or 4 return code in register 15. Beyond this, recovery depends on the particular purpose of an exit routine.

---

## Loading non-JES2 modules

The \$MODLOAD service of JES2 allows for the directed load of modules. It loads all the modules that JES2 needs for processing. Directed loading allows for modules to be placed in requestor obtained storage. Modules loaded using the directed load service do not get the normal contents directory entries (CDE) and

thus cannot be found by other LOADs. However, this implies that these modules are not deleted as part of task or address space termination unless the storage they were loaded into is freed.

With logic moving into common storage, non-JES2 modules might need to be available to JES2 code (and exit code) in common storage. The JES2 \$MODLOAD service supports directed loading non-JES2 modules. This includes placing non-JES2 modules in common storage. An exit can load a necessary module into common storage during exit 24 (post initialization) processing, and then use it as needed. JES2 then deletes the module during JES2 shutdown (\$PJES2) processing when it deletes the other JES2 common storage modules.

Non-JES2 modules can be loaded dynamically after initialization completes. See “Dynamic Load Modules” on page 31 for more information.



## Chapter 3. Controlling the loading of installation-defined load modules

### Loading and placement of installation load modules

Use the `LOADmod(jxxxxxxx)` initialization statement or the `$ADD LOADmod(jxxxxxxx)` command to direct the loading of all installation-defined load modules (such as user-defined exits). Exit routines must be loaded in this manner, rather than linking to JES2 load modules. **JES2 only searches for installation-defined exit routines in user modules defined by the `LOADmod(jxxxxxxx)` initialization statement or the `$ADD LOADmod(jxxxxxxx)` command, in the reserved module names `HASPXJ00 – J31`, or in `HASPXIT0`; JES2 does not search for such routines in IBM-defined modules.** The `STORAGE=` parameter specifies the area of storage where the load module is to be loaded. This is the copy that JES2 will use. Table 2 presents a summary of the manner in which JES2 directs the load of a load module based on initial placement of that load module and the `LOADmod(jxxxxxxx) STORAGE=` specification.

Note the following restrictions:

- `STORAGE=LPA` is invalid if the load module is initially placed in `STEPLIB` only, `LINKLIST` only, or both `STEPLIB` and `LINKLIST`. JES2 issues message `$HASP003 RC(31), MODULE COULD NOT BE LOADED`.
- All other `STORAGE=` requests are valid, but you may not receive the expected result (see Table 2).
- You cannot load a module into the link pack area (LPA) following MVS initialization. You may only request that the copy of the module in LPA be used if multiple copies are found.

Table 2. Directed Load and Use of Modules Based on `LOADMOD(jxxxxxxx) STORAGE=` Specification

| Location of Module is:  | <code>STORAGE=PVT</code> , module is found in | <code>STORAGE=CSA</code> , module is found in | <code>STORAGE=LPA</code> , module is found in |
|-------------------------|---|---|---|
| STEPLIB Only            | PVT   | CSA   | <code>\$HASP003</code><br>RC=31               |
| LPA Only                | LPA   | LPA   | LPA   |
| LNKLST Only             | PVT   | CSA   | <code>\$HASP003</code><br>RC=31               |
| STEPLIB and LPA         | PVT<br>(STEPLIB)                              | CSA<br>(STEPLIB)                              | LPA   |
| STEPLIB and LNKLST      | PVT   | CSA<br>(STEPLIB)                              | <code>\$HASP003</code><br>RC=31               |
| LPA and LNKLST          | LPA   | LPA   | LPA   |
| STEPLIB, LPA and LNKLST | PVT<br>(STEPLIB)                              | CSA<br>(STEPLIB)                              | LPA   |

To place the load module either above or below 16 megabytes, use the linkage editor MODE statement or specify the RMODE= parameter on the \$MODULE macro.

Figure 5 illustrates two ways to package an exit routine:

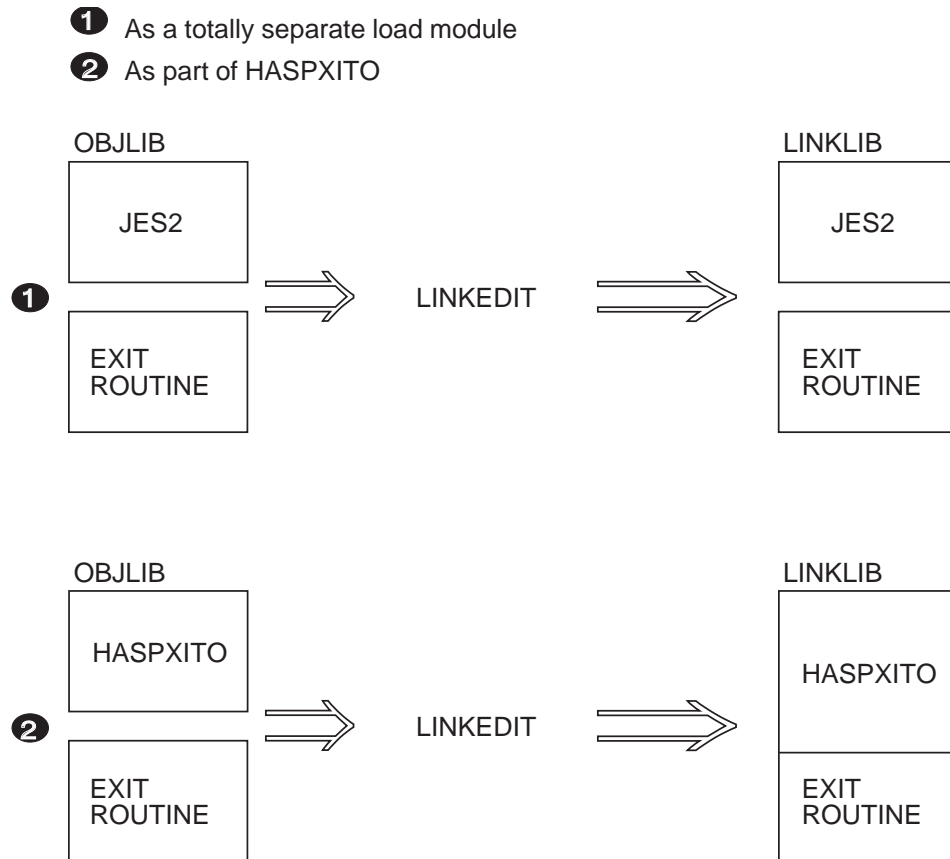

Figure 5. Methods of Packaging an Exit Routine

A JES2 \$MODULE macro must be the first code-generating statement (immediately preceded by COPY \$HASPGBL) in a source module to be assembled and either link edited separately and loaded at initialization or a source module to be added to a standard JES2 load module.

**Note:** The \$MODULE macro call must occur prior to the first use of \$ENTRY or \$EXIT, and a JES2 \$MODEND macro must be coded at the end of both types of source modules.

You can only code one \$MODULE and one \$MODEND macro in each source module. Further, when link editing exits into their own load modules (other than HASJES20), each source module must be linked into its own load module.

To locate the MITs of modules that are added to the standard JES2 load modules, JES2 uses weak external address constants. To locate the MITs of modules that are linked in their own load modules, JES2 assumes that the MIT, generated by \$MODULE, is located at the front of the load module to which it points. The MITETBL, generated by \$MODULE, is located at the end of a module loaded at initialization.

**Note:** For all exit routine source modules, that if an exit routine references the symbolic name of a control block field, the mapping macro for that control block must be included in the \$MODULE macro list in the same source module as the exit routine at assembly time.

Furthermore, see Appendix C, “Hints for Coding JES2 Exit Routines” for a list of required mapping macros for individual exits. These macros are environment dependent and must be coded to prevent assembly errors and error messages.

The ENVIRON= operand of the \$MODULE macro should be used to specify which JES2 operating environment the exit routine(s) is to execute. Each exit description in the “IBM-Defined Exits” reference section in Chapter 12, “IBM-defined exits,” on page 65 includes a list of mapping macros normally required at assembly.

---

## Dynamic Load Modules

Dynamic load modules provide the following functions:

- Load, refresh, and delete installation load modules, which are not part of the IBM base JES2 code, after JES2 initialization processing. The dynamic table pairs and exit routine addresses are updated as needed. The load modules provide load and delete routines to perform any processing that might be needed to adjust data pointers JES2 does not process.

**Note:** This function does not support base JES2 modules, so it can NOT be used to apply IBM service.

- Alter the list of routines associated with an exit point through operator command.

When building a load module with exit routines and dynamic tables, you must decide whether you want to support dynamically loading or deleting these modules after initialization. This is especially useful in a test environment where new versions of a failing exit can be activated without a restart. Depending on the processing done in your exits, supporting dynamic loading and deleting might require no additional code or only a reorganization of your existing logic.

Making load modules dynamically loadable will increase the amount of testing you need to do. You need to not only test the function implemented by your modules, but also ensure that everything works after the module is dynamically loaded, refreshed or deleted. The advantage of dynamic load modules is that when you find a problem in your module, you can correct the problem and get a new version of your code running without major disruptions. If the problem is bad enough, you can delete the module, fix it, and load the fixed version.

If the code is tested and placed in a production environment, IBM suggests that you do not make loading, refreshing, or deleting load modules as a part of your normal operations. This is because it is not always possible to delete old modules from storage. JES2 only deletes a module from storage if it will surely not be used. Some of these old modules will take up space until JES2 or z/OS is restarted (depending on where the module is loaded). Loading, refreshing, and deleting load modules in a production environment must be reserved for emergency situations (if it would save or delay an IPL) or for modules that IBM service has provided to collect additional diagnostic information. If a production environment needs to be altered on a regular basis, it would be better to alter the list of routines associated with an exit point rather than altering what modules are loaded.

## Dynamic Load Module Considerations

When writing new load module or updating an existing module to support dynamic processes, you need to consider the following things:

- The data areas that the modules access. You need to consider the following questions:
  - Does the module accesses a data area that has been created by the installation?
  - How are these data areas created?
  - What points to the data area?
  - Is the area dynamically obtained or is it an area within the load module?

If the exits and tables only access JES2 and z/OS data areas, this is not a concern. Also, if the data area is contained within the module and there are no external pointers to the data area, then that also is not a concern. However, if the data area is installation specific and the address is obtained using a pointer external to the load module (such as the \$UCT pointer in the \$HCT), then you need to consider:

- How is the data area set up? If it is only used by this module, then is a \$\$\$\$LOAD routine needed to initialize it?

**Note:** See “\$\$\$\$LOAD Routine” on page 33 for a description of the \$\$\$\$LOAD routine.

- Does the code deal with the case where the data area already exists (or does it create a second data area)?
- Is the data area in common storage?
- Does it need to be deleted when this module is deleted or when JES2 terminates? Is a \$\$\$\$DEL routine needed to free the data area?

**Note:** See “\$\$\$\$DEL Routine” on page 36 for a description of the \$\$\$\$DEL routine.

- Does anything special need to be done if the module is refreshed instead of being deleted?
- If the data area is in the load module, are there pointers that need to be cleared if the module is deleted or refreshed?
- If the data area is managed by an exit 24 (JES2 initialization) and exit 26 (JES2 termination) pair, should that processing be moved to a \$\$\$\$LOAD and a \$\$\$\$DEL routine?

In general, \$\$\$\$LOAD and \$\$\$\$DEL routines can solve most data area problems to ensure the proper flexibility to alter the data area as needed.

- The creation of installation PCEs (subdispatchable units in the JES2 address space) or DTEs (subtasks in the JES2 address space). If the PCEs or DTEs are defined using dynamic tables or traditional table pairs, the appropriate PCE or subtask is started as part of normal JES2 initialization. However, with dynamic load modules, the installation code decides attaching and detaching the PCEs or DTEs as needed. In general, the simplest way to deal with PCEs and DTEs is to use the appropriate \$PCEDYN or \$DTEDYN macro to detach the old (existing) PCEs or DTEs in the \$\$\$\$DEL routine and reattach them in the \$\$\$\$LOAD routine. To ensure that the PCEs can be attached after initialization, be sure to code the DYNAMIC=YES keyword on the \$PCETAB macro that defines the PCE.

You also need to consider some other things when creating dynamic load modules:



- If you are converting an existing exit to be dynamic, is there logic in exit 24 (post initialization) that should be moved to a \$\$\$\$LOAD routine?
- If you are converting an existing exit to be dynamic, is there logic in exit 26 (JES2 termination) that should be moved to a \$\$\$\$DEL routine?
- Does the installation module include code that front ends or replaces a JES2 service? Front ending is the process of replacing the address of a JES2 service in the \$CADDR, \$PADDR, \$HCT or other data area, with the address of a routine in the module and then calling the JES2 service only after the installation routine runs. If so, care must be taken to ensure that the routine addresses are updated if the installation load module is refreshed or deleted. This is especially true at JES2 termination processing since some are called after installation load modules are deleted at JES2 termination.

**Note:** IBM recommends that you do not front end IBM services. Designing a function that requires front ending IBM services could limit your ability to exploit future IBM functionality to refresh IBM services dynamically.

- Traditional (non-dynamic) tables that are set in the \$MCT data area (or other table pairs) must be updated as modules are loaded or deleted. In general, use of non-dynamic tables can be converted to dynamic tables (which JES2 will automatically process). Otherwise, code can be added to the \$\$\$\$LOAD and \$\$\$\$DEL routines to handle updating these pointers.

If your load module cannot support dynamic processes, there are a number of options to prevent unintended processing:

- Setting DYNAMIC=NO on the \$MODULE statement of the load module will prevent all dynamic processing for this load module. Initialization processing is not affected. Any \$\$\$\$LOAD or \$\$\$\$DEL routines in the module will be called out of JES2 initialization and termination processing.
- From a \$\$\$\$LOAD routine, set the LMT2NDYN bit in flag byte LMTFLG2. The LMT of the module being loaded is passed to the \$\$\$\$LOAD routine in the \$CSVPARM data area. If done during initialization, this has the same effect as setting DYNAMIC=NO on the \$MODULE. However, if the module was not loaded during initialization, using this technique allows the module to be loaded after initialization but not deleted or refreshed later.
- If you can support dynamic processes but there are tables or routines in your module that cannot be deleted, then you can set a return code 8 from a \$\$\$\$DEL routine. This prevents the module from being physically deleted. You should be careful not to set it for every call to the \$\$\$\$DEL routine since if the module is refreshed multiple times, you only need to keep the first copy of the load module in storage. The \$\$\$\$DEL processing should determine if the specific copy of the module that being deleted is the one that needs to remain.

## \$\$\$\$LOAD and \$\$\$\$DEL routines

\$\$\$\$LOAD and \$\$\$\$DEL are reserved routine names on the EXIT ROUTINES=xxxxx initialization statement and the \$T EXIT,ROUTINES=xxxx command. The two reserved routines process when a module is loaded at initialization or is logically deleted at normal JES2 termination.

### \$\$\$\$LOAD Routine

When a load module is loaded by the LOADMOD initialization statement, the \$ADD LOADMOD command, or the \$T LOADMOD,REFRESH command, JES2 searches the load module for a \$ENTRY macro with the name \$\$\$\$LOAD. If the module is found, JES2 calls it after all dynamic tables are linked in.

If the load module is loaded by the \$T LOADMOD,REFRESH command, JES2 processes the following steps:

1. Load new copy of module into storage and verify it is valid.
2. Call the \$\$\$\$DEL routine for the old module.
3. Replace any exit routine addresses that point into the old module with corresponding addresses in the new load module. If no corresponding routine is found in the new module, the routine address is nullified (the routine is not called).
4. Replace dynamic tables that point into the old module with corresponding tables in the new module.
5. Delete any dynamic tables that still point to the old module.
6. Connect any dynamic tables in the new module that have not been connected yet.
7. Call the \$\$\$\$LOAD routine for the new module.
8. Attempt to delete the old module from storage.

**Note:** The \$T LOADMOD,REFRESH command can be issued for an LPA module that is not altered. The new and the old modules are at the same address with two LMTs representing the two modules correspondingly. In this case, the \$\$\$\$LOAD and \$\$\$\$DEL routines are called.

**Environment:** \$\$\$\$LOAD is called in the JES2 main task limited environment (JES2 initialization) and the JES2 main task environment.

**Recovery:** \$ESTAE recovery is in effect. However, the \$\$\$\$LOAD routine *should not* depend on JES2 for recovery. You should provide your own recovery within your \$\$\$\$LOAD routine.

**Point of processing:** After module has been loaded but before control is returned to the requestor of the load.

**Register contents when \$\$\$\$LOAD gets control:**

- R0** Not applicable
- R1** Address of a parameter list mapped by \$CSVARM
- R2-R10**  
Not applicable
- R11**  
Address of the HCT
- R12**  
Not applicable
- R13**  
Address of current PCE (may be initialization PCE)
- R14**  
Return address
- R15**  
Entry address

\$CSVARM (pointed to by register 1 on entry) contains the following bits:

**CSVPID**  
Eye catcher ('CSVPI')

**CSVPSIZE**  
Size of parameter list

**CSVPPER**  
Current version of base section (1)

**CSVPTYPE**  
Routine identifier

**CSVPLDLOAD**  
Indicates \$\$\$\$LOAD routine

**CSVPLMT**  
Address of LMT being loaded

**CSVPMIT**  
Address of module/MIT being loaded

**CSVPLCMD**  
Reason for load:

**CSVPLCJS**  
JES2 performing load

**CSVPLCIN**  
LOADMOD init statement

**CSVPLCAL**  
\$ADD LOADMOD command

**CSVPLCRL**  
\$T LOADMOD,REFRESH command

**CSVPLLOC**  
Where the module was loaded:

**CSVPLPVT**  
Loaded to JES2 private

**CSVPLCSA**  
Loaded to common storage

**CSVPLLPA**  
Loaded to LPA

**CSVPLOLD**  
Address of LMT being replaced (for the \$T LOAD,REFRESH command)

**CSVPL\$DR**  
Address of an additional \$\$\$\$DEL routine (see LPA processing below). This routine gets control before a \$\$\$\$DEL routine in the module is processed.

**Register contents when \$\$\$\$LOAD passes control back to JES2:**

**R0-R1**  
Not applicable (ignored)

**R2-R13**  
Not applicable (unchanged)

**R14**  
Not applicable (ignored)

**R15**

Zero (CSVPLROK)

JES2 does not recognize any return codes from this routine. However, IBM suggests setting R15 to zero to indicate successful processing in case future development adds a return code to this routine.

**\$\$\$\$DEL Routine**

When a load module is deleted because of the \$DEL LOADMOD command, the \$T LOADMOD,REFRESH command, or a second LOADMOD initialization statement for the same module, JES2 searches the load module for a \$ENTRY macro with the name \$\$\$\$\$DEL. If the module is found, JES2 calls it as the first step in the delete processing for the module.

If the load module is deleted by the \$T LOADMOD,REFRESH command, JES2 processes the following steps:

1. Load new copy of module into storage and verify it is valid.
2. Call the \$\$\$\$\$DEL routine for the old module.
3. Replace any exit routine addresses that point into the old module with corresponding addresses in the new load module. If no corresponding routine is found in the new module, the routine address is nullified (the routine is not called).
4. Replace dynamic tables that point into the old module with corresponding tables in the new module.
5. Delete any dynamic tables that still point to the old module.
6. Connect any dynamic tables in the new module that have not been connected yet.
7. Call the \$\$\$\$LOAD routine for the new module.
8. Attempt to delete the old module from storage.

**Note:** The \$T LOADMOD,REFRESH command can be issued for an LPA module that is not altered. The new and the old modules are at the same address with two LMTs representing the two modules correspondingly. In this case, the \$\$\$\$LOAD and \$\$\$\$\$DEL routines are called.

**Environment:** \$\$\$\$\$DEL is called in the JES2 main task limited environment (JES2 initialization) and the JES2 main task environment.

**Recovery:** \$ESTAE recovery is in effect. However, the \$\$\$\$\$DEL routine *should not* depend on JES2 for recovery. You should provide your own recovery within your \$\$\$\$\$DEL routine.

**Point of processing:** As the first step in the processes of deleting a module, before any tables have been unplugged or routine addresses cleared.

**Register contents when \$\$\$\$\$DEL gets control:**

**R0** Not applicable

**R1** Address of a parameter list mapped by \$CSVPARM

**R2-R10**

Not applicable

- R11**  
Address of the HCT
- R12**  
Not applicable
- R13**  
Address of current PCE (may be initialization PCE)
- R14**  
Return address
- R15**  
Entry address

\$CSVPARM (pointed to by register 1 on entry) contains the following bits:

- CSVPID**  
Eye catcher ('CSVP')
- CSVPSIZE**  
Size of parameter list
- CSVVER**  
Current version of base section (1)
- CSVPTYPE**  
Routine identifier
- CSVPDEL**  
Indicates \$\$\$DEL routine
- CSVPLMT**  
Address of LMT being deleted
- CSVPMIT**  
Address of module/MIT being deleted
- CSVPLCND**  
Reason for delete:
  - CSVPCJS**  
JES2 performing delete
  - CSVPCIN**  
LOADMOD init statement
  - CSVPCDL**  
\$DEL LOADMOD command
  - CSVPCRL**  
\$T LOADMOD,REFRESH command
  - CSVPCTR**  
\$PJES2 processing
  - CSVPCSC**  
Secondary call
- CSVPDIND**  
Call flags:
  - CSVPSND**  
Second call after a RC 4/8

**CSVPDFRC**

Module being force deleted

**CSVPDFRE**

Storage for module has been freed

**CSVPDNEW**

Address of LMT for new module that was loaded (for the \$T LOAD,REFRESH command)

**Register contents when \$\$\$\$DEL passes control back to JES2:****R0-R1**

Not applicable (ignored)

**R2-R13**

Not applicable (unchanged)

**R14**

Not applicable (ignored)

**R15**

Return code (ignored if this is a force delete)

**Return code processing:** Return codes from the \$\$\$\$DEL routine are ignored if the module is being force deleted (CSVPDFRC bit on). Otherwise the following processing occurs based on the return code:

**CSVPDROK (0)**

Continue deletion normally. This routine will not be called again.

**CSVDRNN (4)**

Do not delete the module now. JES2 will delete dynamic tables and exit routines without freeing the storage. \$\$\$\$DEL will be called again if all users of the module are gone (with CSVPSND set). If the second call give a return code 4, \$\$\$\$DEL will be called again at about a five minute interval. However, if needed, JES2 can make a force delete call prior to the timer expiring.

**CSVDRND (8)**

Process the same as RC=4 except that JES2 will not call the \$\$\$\$DEL routine again except for the following two cases:

- A force delete of the module is required because of a JES2 termination or an LPA deletion.
- A JES2 hot start and the load module is in CSA or LPA. In this case, any processing for this module on a hot start is allowed though this is a call to the \$\$\$\$DEL routine. Normal return code processing occurs.

## Special Considerations for LPA Modules

Special considerations need to be given to installation load modules placed in LPA. These modules are not actually loaded, deleted or refreshed by JES2. Instead they are managed by MVS using dynamic LPA services and commands.

When JES2 loads a module in LPA, it simply locates the address of the module with a specified name in LPA. If this loading is caused by a \$T LOADMOD,REFRESH command, the LPA module might not be changed and JES2 will reset all its pointers. Therefore, there will be two LMTs, one representing the module being deleted and one representing the same module being loaded. The appropriate \$\$\$\$DEL and \$\$\$\$LOAD routines are called. Special logic might be needed in these routines to properly handle the fact that the new and old modules

are at the same address. In particular, if there is a code in the \$\$\$DEL routine that examines pointers to see if they point into the module being deleted, then in this case, there will be pointers into the old module. However, these pointers are not residual and need to be maintained.

Another consideration with dynamic LPA is the ability for a module to be deleted out from under JES2 using the MVS dynamic LPA commands. It is not expected that this would happen under normal circumstances but JES2 attempts to deal with this situation, should it arise. JES2 is notified after a module has been physically deleted from storage. It marks the LMT to indicate the module has been freed and schedules the module for logical deletion (removal of pointers to the deleted module). Normally logical deletion occurs first but in this case JES2 has no control over the physical deletion. As part of logical deletion JES2 will attempt to call a \$\$\$DEL routine. Unfortunately, since the module is no longer in storage, the module cannot be searched for a normal \$\$\$DEL routine. However, at the time a module is loaded, the \$\$\$LOAD routine has the ability to specify the address of an additional \$\$\$DEL routine in the \$CSV Parm data area (field CSVPL\$DR). This routine cannot be in the module since it is intended for the case when module has been deleted. Instead, it should be in code the \$\$\$LOAD routine has obtained and copied a routine into. It is expected that this routine would set some indicator that the function implemented by this routine is no longer active. Or issue a message that things are no longer functioning.





---

## Chapter 4. Enabling an exit

Figure 6 shows how an exit routine (HASPUEX) can be assembled and link-edited, and how to use the load module name. The source is in SYS1.JESEXITS, and the load module is linked into SYS1.SHASLNKE with the name of HASPUEX. This name must also appear on the LOADmod(jxxxxxxx) initialization statement.

```
//ASM EXEC PGM=IEV90,PARM='OBJECT,NODECK,XREF(SHORT)'  
//SYSLIB DD DSN=SYS1.VnRnMn.ahasrc,DISP=SHR  
// DD DSN=SYS1.MACLIB,DISP=SHR  
// DD DSN=SYS1.AMODGEN,DISP=SHR  
//SYSUT1 DD UNIT=SYSDA,SPACE=(1700,(1200,300))  
//SYSPRINT DD SYSOUT=A  
//SYSIN DD DSN=SYS1.JESEXITS(HASPUEX),DISP=SHR  
//SYSLIN DD DSN=&&OBJ,DISP=(,PASS),UNIT=SYSDA,  
// SPACE=(CYL,(1,1))  
//LINK EXEC PGM=HEWL,COND=(0,LT,ASM),  
// PARM='XREF,LET,REUS'  
//SYSPRINT DD SYSOUT=A  
//SYSUT1 DD UNIT=SYSDA,SPACE=(CYL,(1,1))  
//SYSLMOD DD DSN=SYS1.SHASLNKE,DISP=OLD  
//SYSLIN DD DSN=&&OBJ,DISP=(OLD,DELETE)  
// DD *  
NAME HASPUEX(R)  
/*
```

Figure 6. Example of Assembly and Link-Edit of a Installation-Written Routine

The following JES2 initialization statements can be used to load and associate Exit 1 with the above routine. **Note that the name on the LOADmod(jxxxxxxx) statement must match the load module specified to the linkage editor, and the name on the ROUTINE= parameter on the EXIT(nnn) statement must be the same name as on the \$ENTRY macro.**

```
LOADMOD(HASPUEX) STORAGE=PVT  
EXIT(1) ROUTINE=UEXIT1,STATUS=ENABLED,TRACE=NO
```

Figure 7 on page 42 shows an example exit routine for a user defined exit (UEXIT1). The source is in SYS9.TECH, and the load module is linked into SYS9.TECH.LINKLIB with the name of UEXIT1. This name must also appear on the LOADmod(jxxxxxxx) initialization statement.

```

//STEP1 EXEC PROC=SMPE
//SYSLIB DD DISP=SHR,DSN=SYS1.MACLIB
// DD DISP=SHR,DSN=SYS1.MODGEN
// DD DISP=SHR,DSN=SYS1.V2R10M0.SHASMAC
//SOURCECD DD DISP=SHR,DSN=SYS9.TECH.SOURCE
//SYSPRINT DD SYSOUT=*
//SMPSTS DD DISP=SHR,DSN=SMPE.MVST110.SMPSTS
//TARGET DD DISP=SHR,DSN=SYS9.TECH.LINKLIB
//TECHTX DD DSN=SYS9.TECH.SOURCE,DISP=SHR
//SMPCSI DD DISP=SHR,DSN=SMPE.MVS.GLOBAL.CSI
//SMPPTFIN DD DATA,DLM=$$
++USERMOD(HASXT01) /* IDENTIFY USERMOD */.
++VER(Z038) FMID(HJE7703).
++JCLIN.
//NPL102RA JOB (0020900),'TECH SVCS',CLASS=Z,MSGCLASS=Y,NOTIFY=NPL102
//ASM1 EXEC PGM=ASMA90,REGION=2M,
// PARM='DECK,NOBJECT,XREF(SHORT)'
//SYSIN DD DISP=OLD,DSN=SYS9.TECH.LINKLIB(UEXIT1)
//SYSLIN DD DISP=OLD,DSN=SYS9.TECH.OBJLIB(UEXIT1)
//*
//LINK1 EXEC PGM=IEWL,PARM='XREF,LIST,NORENT'
//SYSLIN DD DISP=OLD,DSN=SYS9.TECH.OBJLIB(UEXIT1)
//SYSLMOD DD DISP=SHR,DSN=SYS9.TECH.LINKLIB
//SYSLIN DD *
INCLUDE TECH(UEXIT1)
ENTRY UEXIT1
NAME UEXIT1(R)
//*
++SRC(UEXIT1) SYSLIB(SMPSTS) DISTLIB(LINKLIB) TXLIB(TECHTX).
$$
//SMPCNTL DD *
SET BDY(MVST110).
RESTORE SELECT(HASXT01) COMPRESS(ALL).
RESETRC.
SET BDY(GLOBAL).
REJECT SELECT(HASXT01) BYPASS(APPLYCHECK) COMPRESS(ALL).
RESETRC.
RECEIVE SELECT(HASXT01) SYSMODS LIST.
SET BDY(MVST110).
APPLY SELECT(HASXT01) REDO ASSEM BYPASS(ID) .
//

```

Figure 7. Example of an Exit Routine Employing a User Defined Exit

---

## Chapter 5. Getting listings of JES2 data areas

When writing and debugging an installation exit, it is sometimes useful to get listings of JES2 data areas similar to what is available in the z/OS data areas books. There are a number of ways to do this depending on what data you need.

To get a listing of all the JES2 data areas, you can assemble the module HASPDOG; the JES2 source code distribution library SYS1.SHASSRC provides this module. You can assemble this module by using either SMP/E, the sample JES2 assembly PROC HASIASM in SYS1.SHASSAMP, or using your own assembly procedure. The output listing contains all the JES2 data areas. If you request the assembler produce a full cross reference using the XREF(FULL) parameter, you will get an alphabetic listing of all the symbols.

You can also use the same source module to get a listing of the z/OS data areas that JES2 uses. To do this, include the assembler parameter SYSPARM((,,GEN,GEN)) on the assembly. You can find the operands of SYSPARM for any JES2 module in *z/OS JES2 Macros* under the SYSP= operand of the \$MODULE macro.

If you need a listing of just one data area (either JES2 or z/OS), you can create an assembler module with only a \$MODULE statement listing the data areas you want listings for and an END statement. The following is an example of an assembler module that creates a listing of the JES2 \$HCT data area. The assembler listing produced will have only the \$MODULE expansion and the \$HCT data area:

```
$MODULE ($HCT,GEN)
END
```

This method works for any mapping macro supported by \$MODULE. All required macros for the assembly are automatically included and only the requested data area is generated in the listing. You can get more than one data area by just adding it to the \$MODULE list:

```
$MODULE ($HCT,GEN),($PCE,GEN)
END
```

This gets the \$HCT and the \$PCE data areas.

You can also add the GEN operand to data area specifications in the \$MODULEs in your exits. This puts any requested data areas on to the listing for your exits.

If there is no label on the \$MODULE and the only operands specified are the data areas to generate, \$MODULE will not generate the JES2 \$MIT data structure. If you do place a label on the \$MODULE invocation or add any other operands, \$MODULE will attempt to build a JES2 load module. Without other structures, it might get assembly errors. Using a \$MODULE without operands or a label can be useful when you need to include JES2 mapping macros in code that is not going to be run as a JES2 exit.



---

## Chapter 6. Sample exit routines

For most exits, IBM provides sample exit routines in SYS1.SHASSAMP. The documentation for each exit indicates whether a sample routine has been provided.



---

## Chapter 7. Multiple exit routines in a single module

When developing and testing installation exits, it is probably easier to keep each exit routine in its own source and load module. In this manner, the routines can be assembled, loaded, and tested independently. If there are many routines, you may want to eventually combine them into a single source and load module for easier maintenance procedures.

Figure 8 on page 48 shows three exit routines in a single module with a general structure that you may want to follow.

```

XITS          TITLE 'SAMPLE JES2 INSTALLATION EXITS - PREAMBLE'
*
*          COMMENT BLOCK FOR MODULE GOES HERE .....
*
*****
HASPUX        COPY $HASPGBL          COPY HASP GLOBALS
              $MODULE ENVIRON=JES2,  REQ'D BY $BUFFER
              RPL,
              $BUFFER,
              $CAT,
              $DCT,
              $HASPEQU,              REQUIRED FOR REG CONVENTIONS
              $HCT,                  REQ'D BY $SAVE,$RETURN,ETC.
              $JCT,
              $JOE,                  REQ'D TO GET SYSOUT CLASS
              $JQE,
              $MIT,                  REQ'D BY HCT
              $PCE,                  REQ'D BY HCT
              $PDDB,                 REQ'D BY $PPPWORK
              $PPPWORK,              REQ'D TO FIND JOE
              $RDRWORK
*
*          ADDITIONAL MAPPING MACROS GO HERE
*
*****
              TITLE 'SAMPLE SEPARATOR PAGE EXIT - ROUTINE 1'
*****
*          COMMENT BLOCK FOR EXIT 1 GOES HERE
*
*****
XIT1RTN1      $ENTRY BASE=R12        EXIT ROUTINE ENTRY POINT
              $SAVE
              LR   R12,R15           LOAD BASE REGISTER
*****
*          INSTALLATION EXIT CODE FOR EXIT 1 ROUTINE 1 GOES HERE
*
*****
RETURN1       LA   R15,8             SET RETURN CODE
              $RETURN RC=(R15)      RETURN TO HASPPRPU
              TITLE 'SAMPLE SEPARATOR PAGE EXIT - ROUTINE 2'
XIT1RTN2      $ENTRY BASE=R12        EXIT ROUTINE ENTRY POINT
              $SAVE
              LR   R12,R15           LOAD BASE REGISTER
              TITLE 'SAMPLE SEPARATOR PAGE EXIT - ROUTINE 1'
*****
*          INSTALLATION EXIT CODE FOR EXIT 1 ROUTINE 2 GOES HERE
*
*****
RETURN2       LA   R15,8             SET RETURN CODE
              $RETURN RC=(R15)      RETURN TO HASPPRPU
              LTORG
              TITLE 'JOB CARD SCAN EXIT'
*****
*          COMMENT BLOCK FOR EXIT 2 ROUTINE 1 GOES HERE
*
*****
XIT2RTN1      $ENTRY BASE=R12        EXIT ROUTINE ENTRY POINT
              $SAVE
              LR   R12,R15           LOAD BASE REGISTER
*****
*          INSTALLATION EXIT CODE FOR EXIT 2 ROUTINE 1 GOES HERE
*
*****
              LA   R15,8             SET RETURN CODE
              $RETURN RC=(R15)      RETURN TO HASPRDR
              LTORG
              $MODEND

```



The following JES2 initialization statements can be used to load and associate exit points 1 and 2 with the above routines.

```
LOADMOD(HASPUEX) STORAGE=PVT  
EXIT(1) ROUTINE=(XIT1RTN1,XIT1RTN2),STATUS=ENABLED,TRACE=NO  
EXIT(2) ROUTINE=XIT2RTN1,STATUS=ENABLED,TRACE=NO
```



---

## Chapter 8. Testing your exit routine

To test your exit routine you need to integrate your exit routine in the system, ensure that it gets control and executes, and verify that the functions it is intended to perform are performed. Verifying that the exit routine performed its function is exit routine-dependent and unique for each exit routine.

You should test and debug your exit routine by running it on a secondary JES2 first. In this way, any errors that occur do not directly affect your main JES2 production system. When the errors in the exit routine are fixed and tested, you can then integrate it into the production JES2 system. Note that the following restrictions apply to JES2 functions when using a secondary JES2:

- Started tasks (STCs) can be directed to either a primary or secondary JES. However, following an IPL, started tasks do not complete start processing until the primary subsystem has been started and completed initialization.
- Time-sharing users (TSUs) may only interface with the primary JES2.
- The MVS I/O attention table can only be associated with the primary JES. Therefore, secondary JESs cannot receive the “unsolicited interrupt” required to support pause-mode for print and punch devices and “hot readers” (that is, readers started through the physical start button without the \$S RDRn JES2 command).
- The MVS log console (SYSLOG) can only be associated with the primary JES.
- Secondary subsystems are started individually rather than automatically during IPL by a start command in the master scheduler JCL (MSTJCL) as is the primary subsystem.

Dynamic loading of modules can simplify the testing of exit routines. JES2 commands allow you to incorporate a new version of your exit routine without the need for an IPL (for user or FSS environment exits), or a restart of JES2 (for JES2 main task or subtask exits). Installation modules can be dynamically loaded, deleted, and refreshed using the \$ADD LOADmod(jxxxxxxx), \$DEL LOADmod(jxxxxxxx), and \$T LOADmod(jxxxxxxx),REFRESH commands. The list of routines associated with a JES2 exit can be dynamically changed with the \$T EXIT(nnn),ROUtines= or the \$T EXIT(nnn),REFRESH command. See “Dynamic Load Modules” on page 31 for more detailed information about the dynamic loading of modules. See *z/OS JES2 Commands* for more information about the commands mentioned above.

---

### Packaging the exit

Exit routines need to be packaged into load modules before they can be loaded into the system and tested.

Modules that contain exit routines which execute in the JES2 main task or subtask environment can be linked into a load module; these exits should be loaded into private storage. Modules that contain exits in the user or functional subsystem environment can be linked together and must be in either LPA or CSA; these exits must be loaded into common storage. **Do not link multiple exit points that must be loaded into different areas of storage into the same load module.**

You can also link edit your exit routines with HASJES20. When you package your exit routines in this manner, it is required that you use a collection of weak external names for the module names. These names should be the same as the label used on the \$MODULE macro of your exit routine. For HASJES20 the “weak external names” are as follows: HASPXJ00, HASPXJ01, ..., HASPXJ31.

You may choose to use one of these packaging techniques exclusively, or you may choose to use both methods in combination, assembling and link editing some routines into the standard JES2 load modules and assembling and link editing others separately and then loading them at initialization. *Creating separate load modules for your exit routines is recommended.* JES2 never makes unconditional direct references to external addresses or entry points in installation-written code. The association between exit routines and JES2 source code is resolved during initialization, or when processing JES2 commands that dynamically change the installation exit environment (for example, \$T EXIT(nnn)).

Figure 9 illustrates a separately linked load module for an exit routine and the MIT and MITETBL structure associated with it. JES2 initialization uses this load module and the information in the MIT and MITETBL to initialize the exit routine in the system. The next topic describes this initialization process.

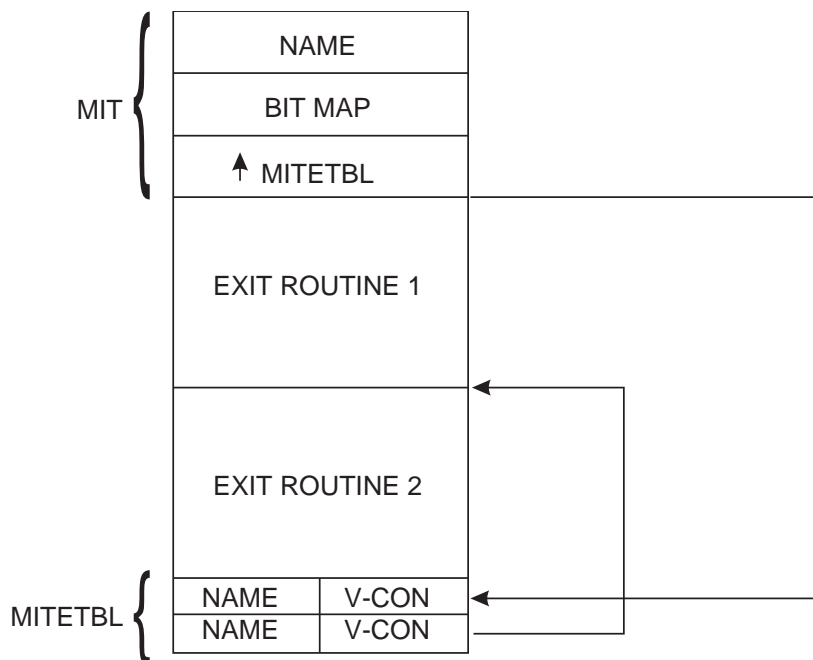

Figure 9. Exit Routines Load Module

## Initializing the exit in the system

Initializing an exit and its exit routines involve the use of the following JES2 initialization statements or JES2 commands:

- LOADMOD(jxxxxxx) or \$ADD LOADmod(jxxxxxx)

Use the LOADMOD(jxxxxxx) initialization statement or the \$ADD LOADmod(jxxxxxx) command to load the modules containing your exit routines. The subscript of the LOADMOD initialization statement or the \$ADD LOADmod(jxxxxxx) command specifies the name of the module to be loaded as defined on the NAME control statement for the linkage editor. The module must

be named according to MVS naming conventions. Exit routines to be called from the user or FSS environment can be loaded into CSA or you can request the LPA version be used by specifying the STORAGE=LPA | CSA parameter specification on the LOADMOD(jxxxxxxx) initialization statement or the \$ADD LOADmod(jxxxxxxx) command. Exit routines to be called from the JES2 main task and subtask environments should be loaded in the private area of the JES2 address space. To place the load module either above or below 16 megabytes, use the linkage editor MODE statement or specify the RMODE= parameter on the \$MODULE macro.

- \$DEL LOADmod(jxxxxxxx) or \$T LOADmod(jxxxxxxx),REFRESH  
Use the \$DEL LOADmod(jxxxxxxx) or the \$T LOADmod(jxxxxxxx),REFRESH command to delete or refresh the modules that contain your exit routines. The subscript of the commands specifies the name of the module that was previously loaded by a \$ADD LOADmod(jxxxxxxx) command, or a LOADMOD(jxxxxxxx) initialization statement.

- EXIT(nnn) or \$T EXIT(nnn),ROUTINES=(xxxxxxx) command  
Use the EXIT(nnn) initialization statement or the \$T EXIT(nnn),ROUTINES=(xxxxxxx) command to associate one or more exit routines with an exit.

Replace *nnn*, the exit number, with the corresponding exit identification number specified on the \$EXIT macro or macros that define the exit point or points that establish the exit. The ROUTINES= parameter can then specify 1 to 255 exit routine names, as specified on the \$ENTRY macro symbol field or macros that identify the corresponding exit routines. For example, you can specify EXIT(123) ROUTINES=(rtn1, rtn2, rtn3). The JES2 exit effector calls multiple exit routines in the sequence of their specification on the EXIT(nnn) statement. If you specify more than one EXIT(nnn) statement with the same identification number, JES2 honors the last statement it encounters during initialization. This specification can be changed post-initialization with the \$T EXIT(nnn),ROUTINES=(xxxxxxx) command. This command not only allows the complete replacement of the list of routines associated with an exit, but also allows routines to be added to or removed from the existing list. See *z/OS JES2 Commands* for more information about changing the list of routines associated with an exit.

**Note:** The LOADMOD(jxxxxxxx) and EXIT(nnn) initialization statements are not positional and do not have to be specified in any required order.

JES2 associates an exit with a routine in the module that was most recently loaded (by either a LOADMOD(jxxxxxxx) initialization statement or a \$ADD LOADmod(jxxxxxxx) command).

**Note:** A \$ADD LOADmod(jxxxxxxx) command does not automatically update the exits which refer to routines in the newly loaded module. The exits must be refreshed (by a \$T EXIT(nnn),REFRESH command) or changed (by a \$T EXIT(nnn),ROUTINES= command) to use those routines.

However, a refresh is not needed to update dynamic tables. Dynamic tables are automatically added, deleted, or refreshed when the applicable JES2 command is issued. In addition, a refresh is not needed to update exits that refer to routines in a deleted or refreshed module. When an exit is associated with a routine that resides in a deleted module, even if the module resides in LPA, the routine will no longer be invoked for the exit (routine address of the exit is nullified). When an exit is associated with a routine that resides in a refreshed module, if the routine exists in the newly loaded module, the routine in the newly loaded module will be

invoked for the exit; if the routine is absent in the newly loaded module, the routine will no longer be invoked for the exit.

In all cases, a \$T EXIT(nnn),REFRESH command refreshes those exits so that they will invoke routines in the most recently loaded module.

Figure 10 illustrates the primary parts of JES2 and their location in storage when initialization completes.

- A User environment
- B User environment
- C JES2 main task and subtasks

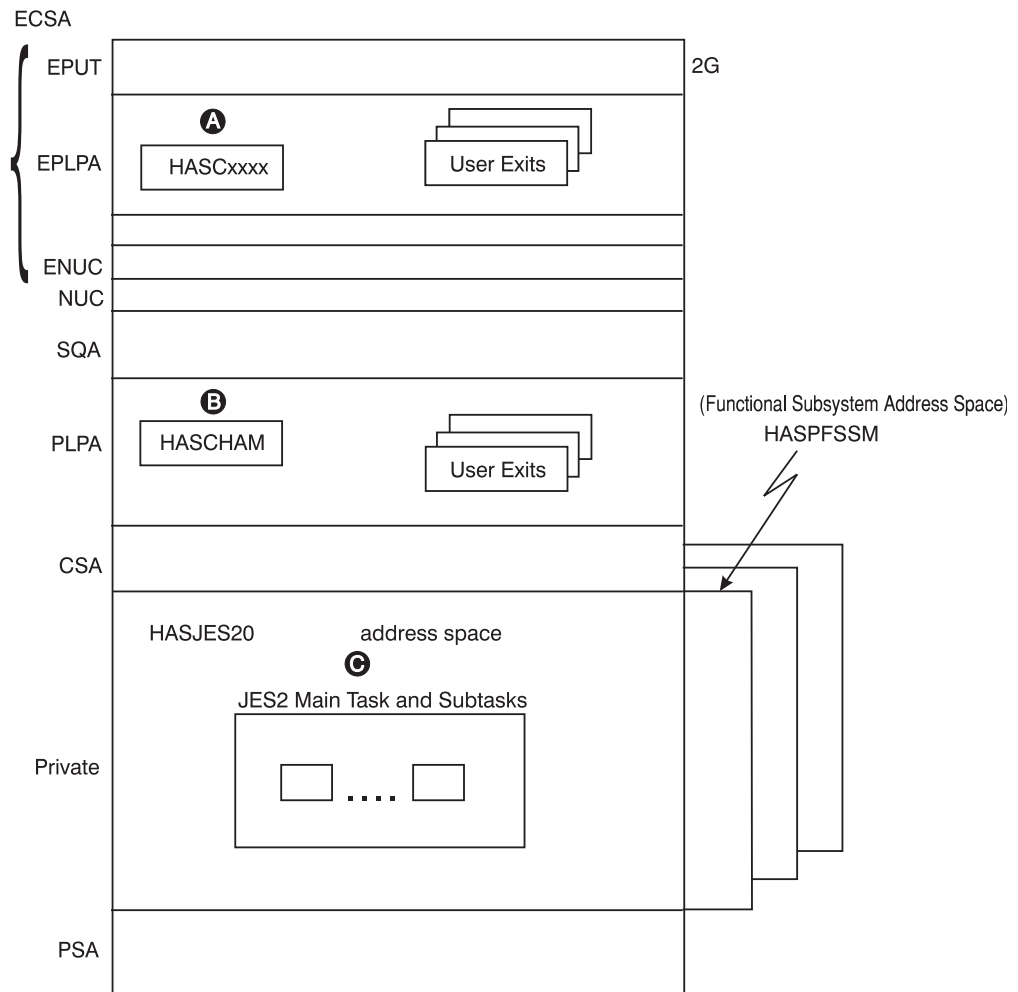

- A** Separate load modules
- B** HASCHAM below the line common module
- C** Separate modules in HASJES20 load module

Figure 10. Exit Placement

---

## Passing control to exit routines

Every exit has a status of *enabled* or *disabled*. If an exit is enabled, JES2 calls its associated exit routine(s) whenever one of the exit's exit points is encountered in processing JES2 code. (Note: The TYPE=TEST form of the \$EXIT macro is an exception; a TEST-type exit point occurs before a TYPE=ENTER exit point to allow JES2 to determine whether the exit is implemented and enabled. If the exit is not both implemented and enabled, JES2 saves processing time by bypassing the call to the exit effector when it encounters the ENTER-type exit point.) When an exit is disabled, its exit points are transparent during JES2 processing and JES2 does not call the exit's associated exit routine(s).

An exit's status is first set at initialization. You can specify either STATUS=ENABLED or STATUS=DISABLED on the EXIT(nnn) initialization statement. If you leave the status of the exit unspecified, STATUS=ENABLED is the default.

An exit's status can then be dynamically controlled by the operator, using the \$T EXIT(nnn) command. Again, the operator has the option of identifying any exit by number, a range of exits, or all exits, and specifying either STATUS=ENABLED or STATUS=DISABLED. The operator can display an exit's status by identifying the exit by number on the \$D EXIT(nnn) command.

When you suspect that an exit routine associated with a particular exit is causing an error, a simple way of isolating the problem is to disable the exit, through an operator command (\$T EXIT(nnn)), to determine if the error still occurs when the exit routine is not allowed to execute. You can also enable tracing as a debugging aid.

An exit can also be dynamically controlled on a job-related basis, using the exit facility.

---

## Job-related exits

Certain exits are identified as *job-related exits*. For these exits, the JOBMASK parameter is specified on the \$EXIT macro or macros defining their exit point or points. JOBMASK is specified with the address of the *job exit mask*, a 256-bit mask in the job control table (JCT), of which each bit corresponds to an exit identification number; bit 0 corresponds to Exit 0, bit 1 corresponds to Exit 1, bit 2 to Exit 2, and so on. (This means, of course, that bit 2 corresponding to Exit 2 is really the third bit in the mask, and so on.) Initially, when the JCT is created, all the bits in the job exit mask are set to one.

For a job-related exit, the status of its corresponding bit in the job-exit mask becomes an additional factor in determining its exit status. If an exit has been enabled in the standard way, by either the EXIT(nnn) initialization statement or the \$T EXIT(nnn) command, and its corresponding bit in the job exit mask is set to one, the exit has a status of enabled and the exit effector calls its associated exit routine(s). If, however, the exit has been enabled in the standard way but its corresponding bit in the job exit mask is set to zero, the exit has a status of disabled and the exit effector does not call its associated exit routine(s) for that particular job. If the exit has been disabled in the standard way, the status of its corresponding bit in the job exit mask is not taken into account; the exit remains disabled. Note that if JOBMASK is not specified on the \$EXIT macro, or if the JCT is not in storage, the job exit mask can have no effect on the status of an exit.

Bits in the job exit mask can be manipulated by an exit routine on a job-by-job basis. The recommended IBM-defined exits for setting the job exit mask are Exit 2 and Exit 52. Exit 2 or Exit 52 is, in most cases, the first exit to be taken for a job, and provides access to most of the job's attributes specified in its JCL and placed in its JCT. For more information, see the descriptions of Exit 2 and Exit 52 in "The IBM-Defined Exits" reference section in Chapter 12, "IBM-defined exits," on page 65.

For each exit description in "The IBM-Defined Exits", the JOB EXIT MASK category lists the exit as either job-related or not job-related. Note that Exits 11 and 12 present special cases.

Appendix C, "Job-related exit scenarios," on page 409 provides scenarios for job-related exits.



---

## Chapter 9. Tracing status

You can also control the status of exit invocation tracing.

Initially, for the tracing to occur automatically, three conditions are necessary:

1. The trace ID for exit tracing (ID 13) must be enabled.
2. The TRACE= operand of the EXIT(nnn) initialization statement must be specified as, or allowed to default to, TRACE=YES.
3. Tracing must be active (TRACEDEF ACTIVE=YES).

If one of these conditions is absent, tracing does not occur.

The status of exit tracing can then be dynamically controlled by the operator, using the \$T EXIT(nnn) command. The operator has the option of identifying any exit by number, a range of exits, or all exits, and specifying either TRACE=YES or TRACE=NO. The operator can display the status of exit tracing by identifying the exit by number on the \$D EXIT(nnn) command.

The status of exit tracing cannot be controlled on a job-related basis.



---

## Chapter 10. Establishing installation-defined exits

JES2 can contain up to 256 exits. IBM has defined some of these. If none of the IBM-defined exits is suited to a particular modification you would like to make, you can consider installing an optional installation-defined exit.

Typically, establishing your own exit is much more difficult than writing an exit routine for an existing IBM-defined exit; it requires a thorough knowledge of the area of processing in which you would like your exit to occur. You should attempt to place a installation-defined exit in a stable area of processing; the risk of error increases with the complexity of the JES2 code in which you place the exit. If possible, you should use your exit in replacing a JES2 function that is already isolated. As an example, IBM-defined Exit 3 allows you to provide an exit routine to completely replace the standard HASPRSCN accounting field scan routine.

You must consider whether the exit will require a single exit point or more than one. You can determine this based on the requirements of your intended modification and on the structure of the IBM code in the area of processing that you intend to modify. You must also consider whether the function you want to modify is contained within a single JES2 execution environment. If it occurs in a second environment, you may have to install a second exit as well.

When you have determined the exact point of processing at which an exit point must occur, use the \$EXIT macro to define it.

First, you should specify the positional ID parameter with the exit's identification number. It is recommended that you begin numbering installation-defined exits with 255 and work down. (If additional IBM-defined exits are added later, your exit numbers will not conflict with the new IBM-defined exit numbers.)

You must define the exit's environment to JES2 using the ENVIRON= operand on the \$MODULE macro. This is specified as either JES2, SUBTASK, USER, or FSS.

If the exit is to be job-related, specify the address of the job exit mask for the JOBMASK= operand. Note that if the JCT is not in storage you will have to point to a copy of the job exit mask.

Use the TYPE= operand to specify the mode of \$EXIT macro operation. To avoid special processing overhead, you can define a TYPE=TEST \$EXIT macro at some location shortly before a TYPE=ENTER \$EXIT macro in JES2 code. A TEST-type \$EXIT macro tests the status of the exit and sets a condition code (not a return code):

- cc=0** No exit routines are to be called
- cc=1** Call exit routines, without tracing
- cc=2** Call exit routines, with tracing

When JES2 encounters the TYPE=ENTER \$EXIT macro, it does not have to retest the exit's status; it just checks the condition code and either bypasses the exit point or calls the exit effector, with or without tracing. Note that a TYPE=TEST \$EXIT macro and a TYPE=ENTER \$EXIT macro must always be used together. If you

omit the TYPE= parameter, the resulting exit point causes JES2 to both determine the status of the exit and then, depending on the status, either to bypass the exit point or to call the exit effector.

Use the AUTOTR= operand to specify that automatic exit effector tracing should (AUTOTR=YES) or should not (AUTOTR=NO) occur.

For more information about exit effector tracing, see "Tracing" in "Writing an Exit Routine" and "Tracing Status" in "Controlling Exit Status" earlier in this chapter.

Along with inserting the \$EXIT macro in JES2 source code, you may have to modify the code before the exit point to pass parameters and pointers to the exit routines, and you may have to modify the code following the exit point to receive exit-generated parameters and to receive any return code greater than 4. For more information, see "Linkage Conventions," "Received Parameters," and "Return Codes" in "Writing an Exit Routine" earlier in this chapter.

**Note:** When using the \$EXIT macro, you may need to include additional control block DSECT mappings in that module. If, for example, the module you are modifying did not previously require the mapping provided by the \$XIT macros, but this macro is required to map the exit parameter list and exit information table (XIT), you must add it (\$XIT) to the \$MODULE macro coded at the beginning of the module.

---

## Chapter 11. Hints for coding JES2 exit routines

Following these hints can help you in the following ways:

- Improve your code's readability and simplify debugging of your exit code.
- Ease migration to a new release or maintenance level.
- Reduce the number of errors in your exit code.

---

### Assembler instructions

- All USING/DROP statements should be paired. No overriding USINGs should be used except when PUSH/POP is used. This helps prevent errors caused by incorrect base registers.
- All TM (test-under-mask) instructions should use BO/BOR/BNO/BNOR/BM/BMR branch instructions rather than BZ/BZR/BNZ/BNZR branch instructions. If this technique is used, the logic of the branch instruction does not have to be modified when adding or deleting flags in the instruction mask.
- Branches to \*- or \*+ should not be used except in macro code. This reduces the possibility of causing errors when inserting new lines of code that change the offset of the instruction to which the code is branching.
- Branch tables should be fully coded and documented. Branches to a non-labeled line immediately after the branch table should not be used.
- To increase code readability, all branch instructions should use the extended mnemonic instructions for both RX and RR machine instruction formats.
- All flag bits in flag-byte fields should be defined by equated symbols. Explicit hexadecimal constants should not be used within instructions to represent flag-bit settings. This allows easy reference to a given flag setting. The SI format instructions TM, OI, NI, and XI should also use equated symbols. To provide easy reference, these instructions should use equated symbols for their masks.
- When the implied length of the target field cannot be used, instructions containing length fields should use equated symbols, not hard-coded lengths. Therefore, only a reassembly is necessary if the length of the field is changed.

---

### Constants

- Rather than using literals, the HCT/HCCT/HFCT DSECTs define many constants which you should use whenever possible. The following are a few examples from the HCT:
  - \$ZEROES – doubleword of binary zeroes
  - \$F1 – fullword binary one
  - \$H4 – halfword binary four
  - \$BLANKS – doubleword of EBCDIC blanks (X'40')

---

### DSECTs

- For ease of migration, mapping DSECTs used as templates should not be explicitly duplicated within source code. An example of this technique is the use of JES2 \$PDDDB macro.
- Whenever possible, the use of locally-defined DSECTs, macros, or equated symbols should be avoided. This technique helps to avoid future migration problems.

- If you leave a control section (CSECT or RSECT) to define a DSECT, to return to the control section, use the &J2SECTN and &J2SECTT; assembly variables.
  - &J2SECTN contains the control section name.
  - &J2SECTT contains the control section type, either CSECT or RSECT.

For example:

```

MYMOD      $MODULE ENVIRON=USER,.....
:
:
*****
*                                     *
* DEFINE DATA                         *
*                                     *
*****
MYDATA     DSECT
           DCs
:
:
*****
*                                     *
* RETURN TO CONTROL SECTION           *
*                                     *
*****
&J2SECTN  &J2SECTT
:
:

```

---

## Registers

- Equated symbols for general purpose registers 0 to 15 (R0-R15) should be used.
- The general-purpose register equates used throughout JES2 are as follows:

|            |   |
|------------|---|
| <b>R0</b>  | Parameter passing                       |
| <b>R1</b>  | Parameter passing                       |
| <b>R11</b> | HCT addressability (JES2 main task)     |
| <b>R11</b> | HCT addressability (JES2 subtasks)      |
| <b>R11</b> | HFCT addressability (FSS)               |
| <b>R11</b> | HCCT addressability                     |
| <b>R12</b> | Local addressability if \$SAVE/\$RETURN |
| <b>R13</b> | PCE addressability (JES2 main task)     |
| <b>R13</b> | Save area address (FSS)                 |
| <b>R13</b> | Save area address                       |
| <b>R14</b> | Return address                          |
| <b>R15</b> | Entry address/return code               |

---

## Miscellaneous

- Returned information used for routines and subroutines should use return codes, not condition codes. All return codes should be passed in register 15.
- Except in critical performance areas, the use of dynamic work areas rather than PCE work areas (for example, using \$GETCMB to obtain a message building work area) is recommended. Dynamic work areas should be used to prevent unnecessary wasted storage caused by defining many unique PCE work area fields.
- The inclusive OR instruction (OC) should not be used to test whether a field is zero or non-zero. The OC can cause unnecessary page-outs, thus incurring

needless system overhead. Rather, the CLC (compare logical) instruction can be used to compare the field with an appropriate constant (for example, \$ZEROES).

- All code should be documented clearly and concisely. A good rule is to document every line of code. In addition, block comments should be used to document every module, routine, and subroutine. These comments should include detailed information about the function of the routine, register values required on entry and exit, register usage within the routine, and possible return codes.





---

## Chapter 12. IBM-defined exits

This reference chapter provides the information you need to write exit routines for the IBM-defined exits.

The exits are described in the order of their identification numbers, the *ID* numbers assigned to them on their respective \$EXIT macros. Each exit description begins with a discussion of its recommended use, followed by a breakdown of environmental considerations, linkage conventions, and other programming considerations specific to the particular exit being described. (Note: For convenience, except where single or multiple exit routines are mentioned specifically, the following descriptions imply either one or more exit routines by the inclusive term “exit routine.” For example, “your exit routine may replace the standard routine” should be understood to mean “your exit routine **or exit routines** may replace the standard routine.”) Table 4 on page 75 summarizes for each exit the CSECT in JES2 from which your exit routine can get control.

---

### Exit selection table

When considering an alteration to a standard JES2 function, you should determine whether one of the IBM-defined exits accommodates your intended change.

The exit selection table ( Table 3) summarizes the available exits and their functions. If you use an IBM-defined exit for other than its intended purpose, you increase the risk of performance degradation and system failure.

Appendix C, “Job-related exit scenarios,” on page 409 contains some scenarios relating to job-related exits. The scenarios may be helpful to you in deciding what exits to use in particular situations.

Table 3. Exit Selection Table

| Exit | Exit Title         | Purpose                            | Some specific uses  |
|------|--------------------|------------------------------------|---|
| 0    | PRE-INITIALIZATION | Control the initialization process | <ul style="list-style-type: none"><li>• Provide verification of JES2 initialization options, specifically \$HASP426 and \$HASP427 messages.</li><li>• Acquire user control blocks and user work areas for use in initialization (such as the user control table (UCT)).</li><li>• Provide addresses of user tables in the master control table (MCT).</li><li>• Determine whether JES2 initialization is to continue.</li><li>• Allow implementation of installation-defined initialization options and parameters.</li></ul> |

Table 3. Exit Selection Table (continued)

| Exit | Exit Title  | Purpose  | Some specific uses  |
|------|---|--|---|
| 1    | JES2 PRINT/PUNCH<br>JOB SEPARATOR                     | Create you own print and punch job separators and control production of standard separators.                 | <ul style="list-style-type: none"> <li>• Selectively produce unique separators or variations on the standard separators.</li> <li>• Unconditionally produce standard separators.</li> <li>• Unconditionally suppress production of the standard separators.</li> <li>• Selectively produce separators for particular users or particular job classes.</li> <li>• Provide a different separator card on a punch device.</li> <li>• Place the company's logo on header page.</li> <li>• Provide accounting information on the trailer page.</li> </ul>  |
| 2    | JOB STATEMENT<br>SCAN (Main Task)                     | Scan the complete JOB statement image and set corresponding fields in the appropriate JES2 control blocks.   | <ul style="list-style-type: none"> <li>• Alter JOB statement parameters including a job's class, priority, and other attributes.</li> <li>• Supply additional JOB statement parameters.</li> <li>• Selectively cancel or purge jobs.</li> <li>• Set the job exit mask in the JCT for subsequent exits.</li> <li>• Set the spool partitioning mask in the JCT.</li> <li>• Initialize or modify other fields in the JCT, including your own installation defined fields.</li> <li>• Modify other job-related control blocks.</li> <li>• Build your own installation-defined job-related control blocks.</li> <li>• Enforce security and standards.</li> <li>• Initialize or modify the user portion of the job correlator.</li> </ul> |
| 3    | JOB STATEMENT<br>ACCOUNTING<br>FIELD SCAN (Main Task) | Scan the JOB statement accounting field and set corresponding fields in the appropriate JES2 control blocks. | <ul style="list-style-type: none"> <li>• Alter accounting field information.</li> <li>• Supply additional accounting field information.</li> <li>• Perform your own accounting field scan.</li> <li>• Process nonstandard accounting fields.</li> <li>• Selectively cancel jobs.</li> <li>• Set the job exit mask in the JCT for future exits.</li> <li>• Initialize or modify other fields in the JCT, including your own installation-defined fields.</li> <li>• Pass information to subsequent exits through the JCT user fields.</li> <li>• Modify other job-related control blocks.</li> <li>• Enforce security and standards.</li> </ul>  |

Table 3. Exit Selection Table (continued)

| Exit | Exit Title   | Purpose   | Some specific uses   |
|------|--|---|--|
| 4    | JCL AND JES2 CONTROL STATEMENT SCAN (Main Task)        | Scan JCL (not including JOB statements).  | <ul style="list-style-type: none"> <li>Alter JCL parameters and JES2 control statements.</li> <li>Supply additional JCL parameters.</li> <li>Supply a JCL continuation statement.</li> <li>Alter JES2 control statements.</li> <li>Supply an additional JES2 control statement.</li> <li>Perform your own JES2 control statement processing.</li> <li>Suppress standard JES2 processing.</li> <li>Process your own installation defined JES2 control statement subparameters.</li> <li>Selectively cancel or purge jobs.</li> <li>Enforce security and standards.</li> </ul> |
| 5    | JES2 COMMAND PREPROCESSOR                              | Process JES2 commands received by the JES2 command processor.   | <ul style="list-style-type: none"> <li>Alter received commands</li> <li>Alter particular fields, such as those pertaining to command authority, in the command processor work area for the PCE to affect subsequent command processing.</li> <li>Perform your own command validation checking.</li> <li>Process your own installation-defined commands, operands, and suboperands.</li> <li>Selectively terminate command processing and notify the operator of command cancellation.</li> </ul>   |
| 6    | CONVERTER/ INTERPRETER TEXT SCAN (Subtask Environment) | Scan converter/interpreter text after conversion from individual JCL images and after all of the converter/interpreter text for a particular job has been created. Exit 6 is called when the converter is run in the JES2 address space. See exit 60 when the converter is run in the JES2CI address space. | <ul style="list-style-type: none"> <li>Scan the resolved JCL, including PROCLIB expansion that will be used by the job.</li> <li>Modify individual converter/interpreter text images.</li> <li>Enforce security and standards.</li> </ul>  |
| 7    | CONTROL BLOCK READ/WRITE (JES2)                        | Receive control whenever control block I/O is performed by the JES2 main task.  | <ul style="list-style-type: none"> <li>Read or write your own installation-defined job-related control blocks to spool along with the reading and writing of JES2 control blocks.</li> </ul>   |
| 8    | CONTROL BLOCK READ/WRITE (USER)                        | Receive control whenever control block (CB) I/O is performed by a JES2 subtask or by a routine running in the user address space.   | <ul style="list-style-type: none"> <li>Read or write installation-defined job-related control blocks to spool along with reading and writing of the JES2 control block.</li> </ul>   |

Table 3. Exit Selection Table (continued)

| Exit | Exit Title                              | Purpose   | Some specific uses   |
|------|---|---|--|
| 9    | JOB OUTPUT OVERFLOW                     | Receive control whenever an executing job is producing more output than was estimated.  | <ul style="list-style-type: none"> <li>• Selectively allow JES2 to follow the defined output overflow error procedure.</li> <li>• Selectively direct JES2 to take special action for the current job only to: <ul style="list-style-type: none"> <li>– Cancel the job</li> <li>– Cancel the job with a dump</li> <li>– Allow the job to continue</li> <li>– Extend the job's estimated output to a specific new limit</li> <li>– Control how often the output overflow message is displayed</li> <li>– Suppress the default error message</li> </ul> </li> </ul> |
| 10   | \$WTO SCREEN                            | Receive control whenever JES2 is ready to queue a \$WTO message.  | <ul style="list-style-type: none"> <li>• Scan messages.</li> <li>• Change the text of a message.</li> <li>• Alter a message's console routing.</li> <li>• Selectively suppress messages.</li> </ul>  |
| 11   | SPOOL PARTITIONING ALLOCATION – \$TRACK | Receive control from the main task when there are no more track groups available on the spool volumes from which the current job is permitted to allocate space.                          | <ul style="list-style-type: none"> <li>• Expand the spool partitioning mask.</li> <li>• Suppress spool partitioning by allowing JES2 to use the allocation default.</li> </ul>   |
| 12   | SPOOL PARTITIONING ALLOCATION – \$STRAK | Receive control from the JES2 subtask or user address space when there are no more track groups available on the spool volumes from which the current job is permitted to allocate space. | <ul style="list-style-type: none"> <li>• Expand the spool partitioning mask.</li> <li>• Suppress spool partitioning by allowing JES2 to use the allocation default.</li> </ul>   |
| 14   | JOB QUEUE WORK SELECT                   | Receive control to search the job queue for work.   | <ul style="list-style-type: none"> <li>• Use tailored search algorithms to select work from the job queue.</li> <li>• Selectively bypass searching the job queue for work.</li> </ul>  |
| 15   | OUTPUT DATA SET/COPY                    | Receive control to handle the creation of separator pages on a data set or copy basis.  | <ul style="list-style-type: none"> <li>• Selectively generate separator pages for each data set to be printed.</li> <li>• Selectively generate separator pages for each copy made of a data set.</li> <li>• Selectively vary the number of copies made of a data set.</li> <li>• Selectively pick data sets and generate separator pages for them.</li> <li>• Change default print translation tables.</li> </ul>  |

Table 3. Exit Selection Table (continued)

| Exit | Exit Title                  | Purpose   | Some specific uses  |
|------|-----------------------------|---|---|
| 16   | NOTIFY                      | Receive control to examine or modify messages that are sent.  | <ul style="list-style-type: none"> <li>• Alter routing of the notify message.</li> <li>• Examine the notify message before it is sent to the receiver and make selective changes.</li> <li>• Suppress sending the notify message to the receiver.</li> <li>• Replace the notify message before it is sent to the receiver with an entirely new one.</li> </ul>  |
| 17   | BSC RJE<br>SIGN-ON/SIGN-OFF | Receive control to manage and monitor RJE operations for BSC. | <ul style="list-style-type: none"> <li>• Selectively perform additional security checks over and above the standard password processing of the signon card image.</li> <li>• Selectively limit both the number and types of remote devices that can be on the system at any one time.</li> <li>• Selectively bypass security checks.</li> <li>• Implement installation-defined scanning of signon card images.</li> <li>• Collect statistics concerning RJE operations on the BSC line and report the results of the activity.</li> </ul> |
| 18   | SNA RJE<br>LOGON/LOGOFF     | Receive control to manage and monitor RJE operations for SNA. | <ul style="list-style-type: none"> <li>• Selectively perform additional security checks over and above the standard password processing of the logon image.</li> <li>• Selectively limit both the number and types of remote devices that can be on the system at any one time.</li> <li>• Selectively bypass security checks.</li> <li>• Implement installation-defined scanning of images.</li> <li>• Collect statistics concerning RJE operations on the line and report the results of the activity.</li> </ul>                       |
| 19   | INITIALIZATION<br>STATEMENT | Receive control for each initialization statement.            | <ul style="list-style-type: none"> <li>• Insert installation initialization statements.</li> <li>• Scan an initialization statement before the JES2 scan and perform parameter checking.</li> <li>• Selectively alter values supplied on an initialization statement to meet specific installation needs.</li> <li>• Optionally cause JES2 to bypass a particular initialization statement.</li> <li>• Optionally cause JES2 to terminate.</li> </ul>   |

Table 3. Exit Selection Table (continued)

| Exit | Exit Title                        | Purpose   | Some specific uses   |
|------|-----------------------------------|---|--|
| 20   | END OF JOB INPUT<br>(Main Task)   | Alter the status of the job at the end of job input   | <ul style="list-style-type: none"> <li>• Selectively assign a job's system affinity, execution node, and priority based on an installation's unique requirements and processing workload.</li> <li>• Based on an installation's own defined criteria, terminate a job's normal processing and selectively print or not print its output.</li> <li>• JCT is available for updating.</li> <li>• Provide job tracking.</li> <li>• Initialize or modify the user portion of the job correlator.</li> </ul> |
| 21   | SMF RECORD                        | Receive control when JES2 is about to queue an SMF buffer.  | <ul style="list-style-type: none"> <li>• Selectively queue or not queue the SMF record for processing by SMF.</li> <li>• Obtain and create SMF control blocks before queuing.</li> <li>• Alter content and length of SMF control blocks before queuing.</li> </ul>   |
| 22   | CANCEL/STATUS                     | Receive control to implement an installation's own algorithms governing job selection and ownership for TSO/E CANCEL/STATUS.  | <ul style="list-style-type: none"> <li>• Allow an installation to implement its own algorithms for job queue searching and for TSO/E CANCEL/STATUS.</li> </ul>   |
| 23   | FSS JOB SEPARATOR                 | Receive control to modify the job separator page area (JSPA) that is used by page-mode printers such as the AFP printer to generate the job separator page for an output group. | <ul style="list-style-type: none"> <li>• Control what information is passed to a page-mode printer functional subsystem application (FSA) through the JSPA.</li> <li>• Suppress the printing of job separator pages.</li> <li>• Suppress the printing of the JESNEWS data set.</li> </ul>  |
| 24   | POST<br>INITIALIZATION            | Receive control to make modifications to JES2 control blocks before the end of JES2 initialization.   | <ul style="list-style-type: none"> <li>• Make final modifications to selected JES2 control blocks before the end of JES2 initialization.</li> <li>• Initialize any special installation-defined control blocks.</li> <li>• Terminate JES2 during the initialization process.</li> </ul>  |
| 25   | JCT READ (FSS)                    | Receive control whenever JCT read I/O is performed by a JES2 functional subsystem address space (HASPSSM).  | <ul style="list-style-type: none"> <li>• Read or write your own installation-defined job-related control blocks to spool along with the reading of the JCT.</li> </ul>   |
| 26   | TERMINATION /<br>RESOURCE RELEASE | Free resources obtained during previous installation exit routine processing during any JES2 termination.   | <ul style="list-style-type: none"> <li>• Free resources obtained by user-exit routine processing that JES2 continues to hold following a \$P JES2 command, JES2 initialization termination, or JES2 abend.</li> </ul>  |
| 27   | PCE<br>ATTACH/DETACH              | Allocate and deallocate resources. Deny a PCE attach.   | <ul style="list-style-type: none"> <li>• Obtain resources whenever a PCE is attached.</li> <li>• Free resources before the detach of a PCE.</li> <li>• Deny the attach of a PCE.</li> </ul>  |

Table 3. Exit Selection Table (continued)

| Exit | Exit Title  | Purpose  | Some specific uses  |
|------|---|--|---|
| 28   | SSI JOB TERMINATION                                   | Receive control before the freeing of job-related control blocks.                                  | <ul style="list-style-type: none"> <li>Free resources obtained by Exit 32.</li> <li>Suppress job termination-related messages.</li> <li>Replace JES2 job termination messages with installation-defined messages.</li> </ul>  |
| 29   | SSI END-OF-MEMORY                                     | Free resources obtained on the address space level.  | <ul style="list-style-type: none"> <li>Free resources obtained by Exit 32.</li> </ul>   |
| 30   | SSI DATA SET OPEN/RESTART                             | Receive control during SSI data set OPEN and RESTART processing.                                   | <ul style="list-style-type: none"> <li>Examine data set characteristics for validity checking, authorization, and alteration.</li> </ul>  |
| 31   | SSI DATA SET ALLOCATION                               | Receive control during SSI data set allocation.  | <ul style="list-style-type: none"> <li>Affect how JES2 processes data set characteristics.</li> <li>Fail an allocation.</li> </ul>  |
| 32   | SSI JOB SELECTION                                     | Receive control during SSI job selection processing.   | <ul style="list-style-type: none"> <li>Perform job-related processing such as allocation of resources and I/O for installation-defined control blocks.</li> <li>Suppress job selection-related messages.</li> <li>Replace job selection-related messages with installation-defined messages.</li> </ul> |
| 33   | SSI DATA SET CLOSE                                    | Receive control during SSI data set CLOSE processing.  | <ul style="list-style-type: none"> <li>Examine data set characteristics for validity checking, authorization, or alteration.</li> <li>Free resources obtained at OPEN.</li> </ul>   |
| 34   | SSI DATA SET UNALLOCATION                             | Receive control during SSI unallocation processing.  | <ul style="list-style-type: none"> <li>Free resources obtained by Exit 30</li> <li>Undo processing performed by Exit 30, such as changing data set characteristics.</li> </ul>  |
| 35   | SSI END-OF-TASK                                       | Receive control during end of task processing.   | <ul style="list-style-type: none"> <li>Free task-related resources.</li> </ul>  |
| 36   | Pre-security Authorization Call                       | Receive control before calling SAF.  | <ul style="list-style-type: none"> <li>Provide additional information to SAF</li> <li>Change information provided to SAF</li> <li>eliminate call to SAF</li> <li>Perform additional security authorization checking above what SAF provides</li> </ul>  |
| 37   | Post-security Authorization Call                      | Receive control after calling SAF.   | <ul style="list-style-type: none"> <li>Change the result of SAF verification</li> <li>Perform additional security authorization checking above what SAF provides</li> </ul>   |
| 38   | TSO/E Receive Data Set Disposition                    | Receive control during processing of a TSO/E RECEIVE command                                       | <ul style="list-style-type: none"> <li>Change the default processing (delete) if a TSO/E user cannot receive a data set with any security information in the user profile.</li> </ul>   |
| 39   | NJE SYSOUT Reception Data Set Disposition (Main Task) | Receive control when your system receives a data set from another node that fails security checks. | <ul style="list-style-type: none"> <li>Override the security decision and accept the data set</li> <li>Change the security information and accept the data set</li> <li>Delete the data set</li> </ul>  |

Table 3. Exit Selection Table (continued)

| Exit | Exit Title                                  | Purpose   | Some specific uses   |
|------|---|---|--|
| 40   | Modifying SYSOUT characteristics            | Receives control before JOEs are created for the job.   | <ul style="list-style-type: none"> <li>• Change the class of a SYSOUT data set to affect grouping.</li> <li>• Change the destination of a SYSOUT data set.</li> </ul>  |
| 41   | Modifying Output Grouping Key Selection     | Receives control during JES2 initialization after the default output grouping keys have been selected, but before any grouping is done.                                   | <ul style="list-style-type: none"> <li>• Change which OUTPUT JCL keywords JES2 uses for generic grouping.</li> </ul>   |
| 42   | Modifying a Notify User Message             | Receives control after input has been validated and authorization checking has been done for the userid and node.   | <ul style="list-style-type: none"> <li>• Cancel the message</li> <li>• Change the destination of the message</li> <li>• Change the message text</li> </ul>   |
| 43   | Transaction Program Select/Terminate Change | Receives control during transaction: <ul style="list-style-type: none"> <li>• select processing</li> <li>• termination processing</li> <li>• change processing</li> </ul> | <ul style="list-style-type: none"> <li>• Create installation-specific control blocks for the TP</li> <li>• Modify output limits associated with any SYSOUT data sets created by the TP</li> <li>• Issue messages to the TP's message log</li> </ul>            |
| 44   | Exit for Converter Main Task                | Receives control after the converter subtask has converted the job's JCL and before JES2 writes the job-related control blocks to spool.                                  | <ul style="list-style-type: none"> <li>• Change fields in the \$JQE and \$JCT</li> <li>• Detect and hold duplicate TSO logons</li> </ul>   |
| 45   | Pre-SJF Service Request                     | Receives control from a request for scheduler JCL facility (SJF) services.  | <ul style="list-style-type: none"> <li>• Examine the request to determine if the system should continue to process the request for SJF services.</li> <li>• Redirect error messages for a request.</li> </ul>  |
| 46   | Transmitting an NJE Data Area               | Receives control before JES2 transmitting an NJE job header, NJE data set header, or a NJE job trailer.   | <ul style="list-style-type: none"> <li>• Remove installation-defined sections that were previously added to an NJE data area</li> <li>• Add or change information in an NJE data area before transmitting it to another node in the network.</li> </ul>        |
| 47   | Receiving an NJE Data Area                  | Receives control before receiving an NJE job header, NJE data set header, or an NJE job trailer.  | <ul style="list-style-type: none"> <li>• Add or remove installation-defined sections that were previously added to an NJE data area</li> <li>• Add or change information in an NJE data area before transmitting it to another node in the network.</li> </ul> |
| 48   | SSI SYSOUT data set unallocation            | Receive control after JES2 has merged the characteristics from the SSOB into the PDDB.  | <ul style="list-style-type: none"> <li>• Control whether JES2 spins the SYSOUT data set.</li> </ul>  |
| 49   | Job Queue Work Select - QGOT                | Receives control whenever JES2 work selection has located a pre-execution job for a device.   | <ul style="list-style-type: none"> <li>• Provide an algorithm to accept or not accept a JES2-selected job.</li> <li>• Control WLM initiator job selection.</li> </ul>  |



Table 3. Exit Selection Table (continued)

| Exit | Exit Title                            | Purpose  | Some specific uses  |
|------|---------------------------------------|--|---|
| 50   | END OF JOB INPUT (User Environment)   | Alter the status of the job at the end of job input  | <ul style="list-style-type: none"> <li>• Selectively assign a job's system affinity, execution node, and priority based on an installation's unique requirements and processing workload.</li> <li>• Based on an installation's own defined criteria, terminate a job's normal processing and selectively print or not print its output.</li> <li>• JCT is available for updating.</li> <li>• Provide job tracking.</li> <li>• Initialize or modify the user portion of the job correlator.</li> </ul>  |
| 51   | Job phase change exit (\$QMOD)        | Change job phase   | <ul style="list-style-type: none"> <li>• Track jobs as they move from phase to phase.</li> <li>• Perform main task processing for jobs that arrive through the internal reader or NJE/TCP</li> <li>• Cause or prevent re-execution of jobs</li> <li>• Implement phase change rules for jobs</li> </ul>  |
| 52   | JOB STATEMENT SCAN (User Environment) | Scan the complete JOB statement image and set corresponding fields in the appropriate JES2 control blocks. | <ul style="list-style-type: none"> <li>• Alter JOB statement parameters including a job's class, priority, and other attributes.</li> <li>• Supply additional JOB statement parameters.</li> <li>• Selectively cancel or purge jobs.</li> <li>• Set the job exit mask in the JCT for subsequent exits.</li> <li>• Set the spool partitioning mask in the JCT.</li> <li>• Initialize or modify other fields in the JCT, including your own installation defined fields.</li> <li>• Modify other job-related control blocks.</li> <li>• Build your own installation-defined job-related control blocks.</li> <li>• Enforce security and standards.</li> <li>• Initialize or modify the user portion of the job correlator.</li> </ul> |

Table 3. Exit Selection Table (continued)

| Exit | Exit Title   | Purpose  | Some specific uses   |
|------|--|--|--|
| 53   | JOB STATEMENT ACCOUNTING FIELD SCAN (User Environment)       | Scan the JOB statement accounting field and set corresponding fields in the appropriate JES2 control blocks. | <ul style="list-style-type: none"> <li>• Alter accounting field information.</li> <li>• Supply additional accounting field information.</li> <li>• Perform your own accounting field scan.</li> <li>• Process nonstandard accounting fields.</li> <li>• Selectively cancel jobs.</li> <li>• Set the job exit mask in the JCT for future exits.</li> <li>• Initialize or modify other fields in the JCT, including your own installation-defined fields.</li> <li>• Pass information to subsequent exits through the JCT user fields.</li> <li>• Modify other job-related control blocks.</li> <li>• enforce security and standards.</li> </ul> |
| 54   | JCL AND JES2 CONTROL STATEMENT SCAN (User Environment)       | Scan JCL (not including JOB statements).   | <ul style="list-style-type: none"> <li>• Alter JCL parameters and JES2 control statements.</li> <li>• Supply additional JCL parameters.</li> <li>• Supply a JCL continuation statement.</li> <li>• Alter JES2 control statements.</li> <li>• Supply an additional JES2 control statement.</li> <li>• Perform your own JES2 control statement processing.</li> <li>• Suppress standard JES2 processing.</li> <li>• Process your own installation defined JES2 control statement subparameters.</li> <li>• Selectively cancel or purge jobs.</li> <li>• Enforce security and standards.</li> </ul>   |
| 55   | NJE SYSOUT Reception Data Set Disposition (User Environment) | Receive control when your system receives a data set from another node that fails security checks.           | <ul style="list-style-type: none"> <li>• Override the security decision and accept the data set</li> <li>• Change the security information and accept the data set</li> <li>• Delete the data set</li> </ul>   |
| 56   | Transmitting an NJE Data Area (User Environment)             | Receives control before JES2 transmitting an NJE job header, NJE data set header, or a NJE job trailer.      | <ul style="list-style-type: none"> <li>• Remove installation-defined sections that were previously added to an NJE data area</li> <li>• Add or change information in an NJE data area before transmitting it to another node in the network.</li> </ul>  |
| 57   | Receiving an NJE Data Area (User Environment)                | Receives control before receiving an NJE job header, NJE data set header, or an NJE job trailer.             | <ul style="list-style-type: none"> <li>• Add or remove installation-defined sections that were previously added to an NJE data area</li> <li>• Add or change information in an NJE data area before transmitting it to another node in the network.</li> </ul>   |

Table 3. Exit Selection Table (continued)

| Exit | Exit Title  | Purpose   | Some specific uses  |
|------|---|---|---|
| 58   | End of Step (User environment)                      | Receives control when a step in a job completes execution (does not get control for steps that are skipped).  | <ul style="list-style-type: none"> <li>Alter the step return code or job return code processing</li> <li>Cause or prevent the job from being restarted after this step.</li> </ul>  |
| 59   | Post interpretation (User Environment)              | Receives control when INTERPRET=JES is specified after the interpreter has been run but before the SWA control blocks are written.  | <ul style="list-style-type: none"> <li>Examine SWA blocks for the job</li> <li>Perform locate processing for data sets used by job</li> <li>Enforce security and standards</li> </ul>   |
| 60   | CONVERTER/ INTERPRETER TEXT SCAN (USER environment) | Scan converter/interpreter text after conversion from individual JCL images and after all of the converter/interpreter text for a particular job has been created. Exit 60 is called when the converter is run in the JES2CI address space. See exit 6 when the converter is run in the JES2 address space. | <ul style="list-style-type: none"> <li>Scan the resolved JCL, including PROCLIB expansion that will be used by the job.</li> <li>Modify individual converter/interpreter text images.</li> <li>Enforce security and standards.</li> </ul> |

## Exit implementation table

The following table is a reference to the various CSECTs from which IBM-defined exits can be taken and the JES2 environment in which the exit may be taken, including an indication regarding whether the exit is subject to job exit mask suppression. Use this table to help you implement your exit routines. See the \$MODULE macro for descriptions of the environments.

Table 4. Exit Implementation Table

| Exit | Exit Title                                | Containing CSECT           | Environment (\$MODULE ENVIRON=)           |
|------|---|----------------------------|---|
| 0    | PRE-INITIALIZATION                        | HASPIRMA                   | JES2 (Initialization) Job Exit Mask – N/A |
| 1    | PRINT/PUNCH SEPARATOR                     | HASPPRPU                   | JES2 Job Exit Mask                        |
| 2    | JOB STATEMENT SCAN                        | HASPRDR                    | JES2 Job Exit Mask                        |
| 3    | JOB STATEMENT ACCOUNTING FIELD SCAN       | HASPRDR                    | JES2 Job Exit Mask                        |
| 4    | JCL AND JES2 CONTROL STATEMENT SCAN       | HASPRDR                    | JES2 Job Exit Mask                        |
| 5    | JES2 COMMAND PREPROCESSOR                 | HASPCOMM                   | JES2 Job Exit Mask – N/A                  |
| 6    | CONVERTER/INTERPRETER TEXT SCAN (Subtask) | HOSCNAV subtask of HASCCNV | SUBTASK Job Exit Mask                     |
| 7    | CONTROL BLOCK READ/WRITE (JES2)           | HASPNUC                    | JES2 Job Exit Mask                        |
| 8    | CONTROL BLOCK READ/WRITE (USER)           | HASCSRDS                   | USER Job Exit Mask                        |
| 9    | JOB OUTPUT OVERFLOW                       | HASCHAM                    | USER Job Exit Mask                        |
| 10   | \$WTO SCREEN                              | HASPCON                    | JES2 Job Exit Mask – N/A                  |

Table 4. Exit Implementation Table (continued)

| Exit | Exit Title                                | Containing CSECT | Environment (\$MODULE ENVIRON=)           |
|------|---|------------------|---|
| 11   | SPOOL PARTITIONING ALLOCATION - \$STRACK  | HASPTRAK         | JES2 Job Exit Mask                        |
| 12   | SPOOL PARTITIONING ALLOCATION - \$STRACK  | HASCSRIC         | USER Job Exit Mask                        |
| 14   | JOB QUEUE WORK SELECT                     | HASPJQS          | JES2 Job Exit Mask - N/A                  |
| 15   | OUTPUT DATA SET/COPY SEPARATORS           | HASPPRPU         | JES2 Job Exit Mask                        |
| 16   | NOTIFY                                    | HASPHOPE         | JES2 Job Exit Mask                        |
| 17   | BSC RJE SIGN-ON/SIGN-OFF                  | HASPBSC          | JES2 Job Exit Mask - N/A                  |
| 18   | SNA RJE LOGON/LOGOFF                      | HASPSNA          | JES2 Job Exit Mask - N/A                  |
| 19   | INITIALIZATION STATEMENT                  | HASPIRPL         | JES2 (Initialization) Job Exit Mask - N/A |
| 20   | END OF JOB INPUT                          | HASCSRIP         | JES2 Job Exit Mask                        |
| 21   | SMF RECORD                                | HASPNUC          | JES2 Job Exit Mask - N/A                  |
| 22   | CANCEL/STATUS                             | HASPSTAC         | JES2 Job Exit Mask - N/A                  |
| 23   | JOB SEPARATOR PROCESSING (JSPA)           | HASPFSSM         | FSS Job Exit Mask                         |
| 24   | POST INITIALIZATION                       | HASPIRA          | JES2 (Initialization) Job Exit Mask - N/A |
| 25   | JCT READ I/O (FSS)                        | HASPFSSM         | FSS Job Exit Mask                         |
| 26   | TERMINATION/RESOURCE RELEASE              | HASPTERM         | JES2 (Termination) Job Exit Mask - N/A    |
| 27   | PCE ATTACH/DETACH                         | HASPDYN          | JES2 Job Exit Mask - N/A                  |
| 28   | SSI JOB TERMINATION                       | HASCJBST         | USER Job Exit Mask                        |
| 29   | SSI END-OF-MEMORY                         | HASCJBTR         | USER Job Exit Mask - N/A                  |
| 30   | SSI DATA SET OPEN and RESTART             | HASCDSOC         | USER Job Exit Mask                        |
| 31   | SSI DATA SET ALLOCATION                   | HASCDSAL         | USER Job Exit Mask                        |
| 32   | SSI JOB SELECTION                         | HASCJBST         | USER Job Exit Mask                        |
| 33   | SSI DATA SET CLOSE                        | HASCDSOC         | USER Job Exit Mask                        |
| 34   | SSI DATA SET UNALLOCATE                   | HASCDSAL         | USER Job Exit Mask                        |
| 35   | SSI END-OF-TASK                           | HASCJBTR         | USER Job Exit Mask - N/A                  |
| 36   | Pre-Security Authorization Call           | HASCSRIC         | USER Job Exit Mask                        |
| 37   | Post-Security Authorization Call          | HASCSRIC         | USER Job Exit Mask                        |
| 38   | TSO/E Receive Data Set Disposition        | HASPPSO          | JES2 Job Exit Mask - N/A                  |
| 39   | NJE SYSOUT Reception Data Set Disposition | HASPNET          | JES2 Job Exit Mask - N/A                  |
| 40   | Modifying SYSOUT Characteristics          | HASPHOPE HASPXEQ | JES2 Job Exit Mask - N/A                  |
| 41   | Modifying Output Grouping Key Selection   | HASCGGKY         | USER Job Exit Mask - N/A                  |

Table 4. Exit Implementation Table (continued)

| Exit | Exit Title   | Containing CSECT | Environment (\$MODULE ENVIRON=) |
|------|--|------------------|---------------------------------|
| 42   | Modifying a Notify User Message                              | HASCSIRQ         | USER Job Exit Mask – N/A        |
| 43   | Transaction Program Select/Terminate/Change                  | HASCTP           | USER<br>Job Exit Mask           |
| 44   | JES2 Converter Exit  | HASPCNVT         | JES2<br>Job Exit Mask           |
| 45   | Pre-SJF Exit Request   | HASCSJFS         | USER<br>Job Exit Mask           |
| 46   | Transmitting an NJE Data Area                                | HASPNET          | JES2<br>Job Exit Mask           |
| 47   | Receiving an NJE Data Area                                   | HASPNET          | JES2<br>Job Exit Mask           |
| 48   | SSI SYSOUT Data Set Unallocation                             | HASCDLAL         | USER<br>Job Exit Mask           |
| 49   | Job Queue Work Select - QGOT                                 | HASPJQS          | JES2 Job Exit Mask – N/A        |
| 50   | END OF JOB INPUT (User Environment)                          | HASCSRIP         | USER<br>Job Exit Mask           |
| 51   | Job phase change exit (\$QMOD)                               | HASPJQS          | JES2<br>Job Exit Mask           |
| 52   | JOB STATEMENT SCAN (User Environment)                        | HASCINJR         | USER<br>Job Exit Mask           |
| 53   | JOB STATEMENT ACCOUNTING FIELD SCAN (User Environment)       | HASCINJR         | USER<br>Job Exit Mask           |
| 54   | JCL AND JES2 CONTROL STATEMENT SCAN (User Environment)       | HASCINJR         | USER<br>Job Exit Mask           |
| 55   | NJE SYSOUT Reception Data Set Disposition (User Environment) | HASCNJSR         | USER<br>Job Exit Mask           |
| 56   | Transmitting an NJE Data Area (User Environment)             | HASCNJE          | USER<br>Job Exit Mask           |
| 57   | Receiving an NJE Data Area (User Environment)                | HASCNJE          | USER<br>Job Exit Mask           |
| 58   | End of Step (User environment)                               | HASCJBTR         | USER<br>Job Exit Mask - N/A     |

Table 4. Exit Implementation Table (continued)

| Exit | Exit Title  | Containing CSECT | Environment (\$MODULE ENVIRON=) |
|------|---|------------------|---------------------------------|
| 59   | Post interpretation (User environment)              | HASCCNVS         | USER<br>Job Exit Mask           |
| 60   | CONVERTER/ INTERPRETER TEXT SCAN (USER environment) | HASCCNVS         | USER<br>Job Exit Mask           |

---

## Chapter 13. Exit 0: Pre-initialization

---

### Function

This exit allows you to control the start of the initialization process through various means, such as:

- Processing JES2 initialization options, specifically the JES2 cataloged procedure parameter field or the replies to the \$HASP426 and \$HASP427 WTORs. The options can optionally be altered or bypassed.
- Acquiring installation-defined control blocks and installation work areas for later initialization
- Providing user fields and addresses of installation-defined tables in the MCT. The table pointers in the master control table (MCT) allow your installation to extend JES2 processing of user tables to define JES2 initialization to extend or tailor certain table-driven JES2 functions. Define user table pointers in the MCT as MCTstmTU, where 'stm' is the JES2 initialization statement that you are replacing. See "Defining JES2 Tables" for a list of the MCT names.
- Determining whether JES2 initialization is to continue.

---

### Environment

#### Task

JES2 main task (Initialization) – JES2 dispatcher disabled. You must specify ENVIRON=JES2 on the \$MODULE macro.

#### AMODE/RMODE requirements

RMODE ANY, AMODE 31

#### Supervisor/problem program

JES2 places exit 0 in supervisor state and PSW key 1

#### Recovery

JES2 does not have a recovery environment established at the processing point for Exit 0 (the JES2 ESTAE will process termination but not recover).

#### Job exit mask

Exit 0 is not subject to suppression.

#### Mapping macros normally required

\$HASPEQU, \$HCT, \$MIT, \$PCE, \$CIRWORK

---

### Point of processing

This exit is taken in the initialization routine that processes the initialization options (IROPTS, in module HASPIRMA). The initialization options are taken from the parameter field specified through the JES2 procedure or START command, or are requested from the operator through the \$HASP426 WTOR message if necessary. The point of processing for this exit is just before parsing and analyzing

## Exit 0

the options and setting appropriate flags. Exit 0 may be called a multiple number of times, because new options may be requested repetitively through the \$HASP427 WTOR message until valid options are specified or the exit directs JES2 to bypass the options analysis.

The exit control blocks and the exit effector are not initialized at this point in IROPTS when Exit 0 gets control. Therefore, the normal JES2 exit facility initialization parameters cannot be used. IROPTS searches for module HASPXIT0 in the HASPINIT load module and then, if necessary, in the HASJES20 load module. The name HASPXIT0 is defined as a weak external reference (WXTRN) in both load modules. If HASPXIT0 is not found through this search, JES2 attempts to locate a separate load module named HASPXIT0. *Creating separate load modules for your exit routines is recommended.* If HASPXIT0 is found in STEPLIB or LINKLIST, a temporary XIT and XRT are built for the exit facility and the \$EXIT macro. The HASPXIT0 module's MIT is searched for all entry point names of the form 'EXIT0nnn' and the entry point names found and the associated addresses are placed in the temporary XRT in the order they are found.

If HASPXIT0 is found during JES2 initialization, an entry for that module is placed in the exit facility LMT as if a LOADmod(jxxxxxxx) initialization statement had been processed for it and the module is not deleted. Therefore other exit routines (e.g., for Exits 19 and 24) and installation-defined tables (e.g., initialization statement \$SCANTAB tables) can be assembled in the same module with the Exit 0 routines without having them deleted by JES2 after initialization completes. Note, however, that HASPXIT0 will be deleted from storage with HASPINIT if HASPXIT0 is linkedited with the HASPINIT load module. Exit 0 can also be invoked using the MVS Dynamic exit facility. JES2 invokes exit HASP.\$EXIT0 immediately after the call to routines in HASPXIT0. The interface to any routines called in this fashion is identical to those invoked from HASPXIT0.

---

## Programming considerations

1. Tracing for this exit is disabled because of its sequence in the initialization process.
2. Because Exit 0 is called early in JES2 initialization, some main task services may not be functional and most control blocks and interfaces are not yet established. The JES2 dispatcher is not yet functional, so MVS protocol should be used in Exit 0 routines (such as, WAIT rather than \$WAIT, ESTAE rather than \$ESTAE.).
3. If Exit 0 returns a return code of 12, IROPTS issues message \$HASP864 indicating that Exit 0 terminated initialization. IROPTS then returns to the IRLOOP with return code 8, indicating that the \$HASP428 message should be issued before final termination.
4. The initialization options string passed to Exit 0 is first 'folded', that is all the characters are 'folded' up to their capitalized versions.
5. The processing that JES2 does for the initialization options string after calling Exit 0 is performed using the JES2 \$SCAN facility and a table that defines the options input allowed and how to process it. The table is actually composed of two tables, an installation-defined table followed by a JES2-defined table.  
By specifying installation-defined tables, an installation can implement its own initialization options or replace the JES2 definition for existing options. Thus this function can be accomplished without implementing Exit 0, or with an implementation of Exit 0. Also, the \$SCAN facility itself can be used from an Exit 0 to process initialization options.
6. If HASPXIT0 contains dynamic tables, the tables will automatically be used when HASPXIT is loaded. It is also possible to include dynamic tables in a



module invoked by HASP.\$EXIT0. However, when using HASP.\$EXIT0, include any tables in a separate load module and invoke the \$MODLOAD service to access the modules. If HASP.\$EXIT0 is refreshed, any tables that the load module contains might move to a different storage location without JES2's knowledge, resulting in unpredictable results.

**Attention:** This exit should be thoroughly tested in an environment that is totally inaccessible to your production JES2 environment (the data set containing the test version of the module that contains exit 0 should not be in the link list).

This exit cannot be disabled other than by replacing or removing the load module. A situation where JES2 cannot be initialized may occur if the exit is improperly coded. This risk can be minimized by using Exit 24 to define user tables for commands, rather than Exit 0. However, for installation defined installation statements, Exit 0 must be used.

Also, if the MCT table entries are modified, the associated tables must not be in the HASPINIT load module. This is because the HASPINIT load module is deleted after initialization, and the tables will become inaccessible. Note that this restriction applies regardless of whether the tables define initialization statements, commands, or messages.

---

## Register contents when Exit 0 gets control

The contents of the registers on entry to this exit are:

### Register

#### Contents

|      |   |
|------|---|
| 0    | A code indicating where the initialization options were specified   |
| 0    | Options passed are from the EXEC card, the PARM field   |
| 4    | Options passed are from the \$HASP426 message WTOR reply  |
| 8    | Options passed are from a \$HASP427 message WTOR reply  |
| 1    | Address of a 2-word parameter list with the following structure:  |
|      | <b>Word 1 (+0)</b>  |
|      | address of the initialization options string  |
|      | <b>Word 2 (+4)</b>  |
|      | length of the initialization options string   |
| 2-10 | Not applicable  |
| 11   | Address of \$HCT  |
| 12   | Not applicable  |
| 13   | Address of the initialization \$PCE – the PCE work area for this \$PCE is the common initialization routine work area, mapped by the \$CIRWORK macro. |
| 14   | Return address  |
| 15   | Entry address   |

---

## Register contents when Exit 0 passes control back to JES2

Upon return from this exit, the register contents must be:

## Exit 0

### Register

#### Contents

- 0-13 Not applicable
- 14 Return Address
- 15 A return code

A return code of:

- 0 Tells JES2 that if additional exit routines are associated with this exit, call the next consecutive exit routine. If no additional exit routines are associated with this exit, continue with normal IROPTS processing.
- 4 Tells JES2 to ignore any additional exit routines associated with this exit and to continue with normal IROPTS processing.
- 8 Tells JES2 to bypass processing of the options string and assume the current values for the JES2 initialization options flags are correct.
- 12 Tells JES2 to terminate processing. This results in the \$HASP864 error message to the operator.

---

## Coded example

Modules HASX00A and HASX00B in SYS1.SHASSAMP contain samples of exit 0.

---

## Chapter 14. Exit 1: Print/punch separators

---

### Function

This exit allows you to:

- Produce your own print/punch separators
- Control production of standard print/punch separators for batch jobs or transaction programs (TP)
- Create separators that include the security label for the job output for JES2 managed printers, if your security policy requires it.

When using this exit to control the production of standard separators, you can:

- Unconditionally suppress production of standard separators
- Direct JES2 to unconditionally produce standard separators
- Allow JES2 to produce any standard separators that are in effect.

JES2 determines whether standard separators are in effect for any particular device by using the initialization statement or the operator command separator options provided by your installation at any given time; “Programming considerations” on page 84 describes these options.

For punch devices, JES2 provides the option of producing start-of-job header cards and trailer cards. For printers, JES2 provides the option of producing start-of-job header pages, continuation-of-job header pages, and trailer pages. Start-of-job header pages are produced at each output data set group (represented by a work JOE) within a job. Continuation-of-job header pages are produced for the continuation of a data set group if printing has been interrupted. Therefore, you are able to control the production of separators on a job-by-job basis and, for printers/punches on a data set group basis. See *z/OS JES2 Initialization and Tuning Guide* for a sample separator page.

Each time your exit routine is called, you can direct JES2:

- To produce only your own separator (unconditionally suppressing production of the standard separator)
- To produce only the standard separator, if it is in effect (without producing your own separator)
- To produce the standard separator unconditionally
- To produce your own separator followed by the standard separator, if the standard separator is in effect (for example, your own start-of-job header page followed by the standard start-of-job header page)
- To produce your own separator and then to produce the standard separator unconditionally
- To produce no separator (by not producing your own separator and by suppressing production of the standard separator)
- To print or suppress the JESNEWS data set, regardless of whether a separator is produced

---

## Environment

### Task

JES2 main task. You must specify ENVIRON=JES2 on the \$MODULE macro.

### AMODE/RMODE requirements

AMODE 31, RMODE ANY

### Restrictions

You cannot use this exit to modify the standard separator routines directly. If you intend to produce a modified version of a standard separator, your exit routine must replace the standard separator routine entirely, and is responsible for producing the standard separator elements that you want to retain and your new or modified separator elements.

### Recovery

\$ESTAE recovery is in effect. If a program check occurs in the exit, JES2 interrupts the output currently processing on the device. The recovery routine does not create a trailing separator and will not call Exit 1 to free allocated resources. JES2 places the interrupted output groups in system hold with an indication that a failure occurred during separator exit processing. As with every exit, you should supply your own recovery within your exit routine.

### Job exit mask

Exit 1 is subject to job exit mask suppression. The installation can implement exit 2 to set the 1st bit in the job exit suppression mask (JCTXMASK) or the installation can indicate the exit is disabled in the JES2 initialization stream.

### Mapping macros normally required

\$BUFFER, \$DCT, \$DSCT, \$HASPEQU, \$HCT, \$JCT, \$JCTX, \$JOE, \$JQE, \$PCE, \$PDDB, \$XPL

---

## Point of processing

JES2 calls Exit 1 during print/punch processing before the check for standard separator pages. The exit is called for job header and job trailer separators.

---

## Programming considerations

1. This exit is available to provide a user-written separator page for local or RJE printers only. There is no separator page for JES2 or user-supplied networking output. If you require separator pages for networking output jobs, the destination node must supply them (through use of this exit) when the output prints.
2. For each device, initialization statements first determine whether standard separators are in effect—that is, whether without an exit routine, JES2 would normally produce or suppress standard separators.  
For a local printer, the SEP=NO parameter of the PRT(nnnn) statement instructs JES2 not to produce separator pages, and the SEP=YES parameter instructs JES2 to produce separator pages. However, even if you specify SEP=YES, if SEPPAGE=(LOCAL=NONE) appears on the PRINTDEF statement, JES2 does not produce separator pages.

For a remote printer, the SEP=NO parameter of the R(nnnn).PR(m) statement instructs JES2 not to produce separator pages, and the SEP=YES parameter instructs JES2 to produce separator pages. However, even if you specify SEP=YES, if SEPPAGE=(REMOTE=NONE) appears on the PRINTDEF statement, JES2 does not produce separator pages.

For a local card punch, the SEP=NO parameter of the PUN(nn) statement instructs JES2 not to produce separator cards, and the SEP=YES parameter instructs JES2 to produce separator cards.

For a remote card punch, the SEP=NO parameter of the R(nnnn).PU(m) statement instructs JES2 not to produce separator cards, and the SEP=YES parameter instructs JES2 to produce separator cards.

After you start JES2, the operator uses the S option of the \$T PRT(nnnn) or \$T PUN(nnn) command to change the status of any printer or card punch. For any device, if the operator issues the \$T command with S=Y, JES2 produces standard separators; with S=N, JES2 does not produce standard separators.

3. Use the *\$PRPUT* macro to produce any new separators your exit routine creates. *\$PRPUT* passes back a return code of 4 in register 15 if the creation of the separator page is suspended or terminated.
4. Use the *\$PBLOCK* macro to create block letters on any new separator page your exit routine creates.
5. If you are using the spooling capabilities of a remote SNA device such as the 3790, use the *\$SEPPDIR* macro to send a peripheral data information record (PDIR) to the device.
6. **Locating Extensions to the JCT Control Block:** You can use the *\$JCTXGET* macro to locate extensions to the job control table (*\$JCT*) control block from Exit 1.
7. **Using Buffers in this Exit Routine:** JES2 provides this exit with a buffer to use for I/O. JES2 page-fixes the buffer, when needed, so the buffer can be used by the *\$PRPUT*, *\$PBLOCK*, and *\$SEPPDIR* macros. The exit routine accesses the buffer by coding a USING statement for label BFPDSECT. The exit routine must not free the supplied buffer.

Although IBM suggests using the buffer that JES2 provides, the installation has the option of obtaining its own buffer. Use the *\$GETBUF* macro if your routine obtains its own buffer and the *\$FREEBUF* macro to free the buffer. Code the following on the *\$GETBUF* macro for any buffers you are using with *\$PBLOCK*, *\$PRPUT*, and *\$SEPPDIR*:

- TYPE=HASP
- FIX=YES for buffers used for local devices
- FIX=NO for buffers used for remote devices.

Although you could page-fix all buffers using the FIX parameter on *\$GETBUF*, this may lead to performance problems.

When using *\$PRPUT* with WAIT=NO, I/O does not occur synchronously. The device does not physically process the buffer until either you issue a *\$PRPUT* macro specifying WAIT=YES or the CCW area fills. Therefore, issue *\$PRPUT* with WAIT=YES before freeing the buffer.

8. If a hardware error or intervention situation interrupts *\$PRPUT* processing, Exit 1 relinquishes control. When this occurs, JES2 can not deallocate any resources your exit routine allocated. You can prevent this situation from occurring by saving the addresses of allocated resources in a PCE field such as PCEUSER0 and checking for the address(es) on entry to the exit routine. Your routine can then reuse previously allocated resources and before returning to JES2, the routine can release the resources and zero the pointer field(s).

## Exit 1

9. Some printers do not reposition to “top of forms” after the trailer page. To avoid feeding blank pages through your printer, include a page eject statement in your exit routine following the trailer separator page.
10. Use SWBTUREQ REQUEST=RETRIEVE to retrieve any parameters a user specifies on the OUTPUT JCL statement you need to build your separator page. See *z/OS MVS Programming: Authorized Assembler Services Guide* for additional information about using the SWBTUREQ macro.
11. You can determine if Exit 1 is being invoked for transaction program by examining field X001DSCT. If it contains an address, Exit 1 was invoked on behalf of a TP. Zeroes in this field indicate Exit 1 was invoked on behalf of a batch job.
12. For a TP, you will need to obtain the owner's userid from the \$JOE instead of the \$JQE. You can continue to obtain the owner's userid from the \$JQE for batch jobs.

---

## Register contents when Exit 1 gets control

The contents of the registers on entry to this exit are:

- 0 Not applicable
- 1 Address of a parameter list with the following structure, mapped by \$XPL:

### Field Name

### Description

#### XPLID

The eyecatcher - \$XPL

#### XPLLEVEL

The version level of \$XPL

#### XPLXITID

The exit ID number - 1

#### XPLIND

Indicator byte. This byte indicates whether the exit was invoked for a job header, a job trailer, or a continuation.

#### X001JHDR

If this bit setting is on, then Exit 1 was invoked for a job header.

#### X001JTLR

If this bit setting is on, then Exit 1 was invoked for a job trailer.

#### X001JCNT

If this bit setting is on, then Exit 1 was invoked for a continuation.

#### X001RESP

Response byte. This response byte will indicate whether JES2 will produce standard separator pages or not, and whether it will produce JESNEWS or not. The response byte on entry can have the following values:

#### X001DFSP

If this bit setting is on, then the production of the standard separator page will be suppressed. Otherwise, the standard separator page will be produced.

**X001JNWS**

If this bit setting is on, then the production of JESNEWS will be suppressed. Otherwise, JESNEWS will be printed.

**X001DCT**

Address of \$DCT

**X001JCT**

Address of \$JCT

**X001DSCT**

Contains the address of the \$DSCT for TPs or zeros for batch jobs.

**X001JQE**

Address of \$JQE

**X001JOA**

Address of the artificial JOE (JOA). The JOA contains both the Work-JOE and the Characteristics-JOE.

**Note:** If the exit must update JOE fields, it should obtain and return an update mode JOA. For more information, see "Checkpoint control blocks for JOEs" on page 415.

**X001PDDB**

Address of the first PDDB in the JOE. This field is zero for job trailers.

**X001SWBT**

Address of the scheduler work block text unit (SWBTU) pointer list for the first PDDB in the JOE. The SWBTU pointer list is mapped by SJTRSBTL DSECT in the IEFSJTRP parameter list. This field is zero if there is no OUTPUT JCL statement associated with the first PDDB. JES2 uses the SWBTU associated with the first PDDB to retrieve the output identification and delivery information for the entire output group. From this information, JES2 builds the detail box in the default standard separator page.

**X001NSWB**

Number of SWBTUs JES2 despoiled. *z/OS MVS Programming: Assembler Services Reference ABE-HSP* contains additional information about SWBTU and the IEFSJTRP parameter list.

**X001HBUF**

Address of a HASP buffer for this exit's use. Mapping macro \$BUFFER maps the buffer and label BUFSTART points to the beginning of the buffer work area. You must have a USING on field BFPDSECT. Field \$BUFSIZE in the \$HCT contains the size of the buffer work area. The exit routine should not update any other fields in the buffer as errors will occur when control returns to JES2.

|      |                  |
|------|------------------|
| 2-10 | Not applicable   |
| 11   | Address of \$HCT |
| 12   | Not applicable   |
| 13   | Address of \$PCE |
| 14   | Return address   |
| 15   | Entry address    |

---

## Register contents when control passes back to JES2:

|      |  |
|------|--|
| 0    | Unchanged  |
| 1    | Pointer to a parameter list mapped by \$XPL:   |
|      | <b>Field Name</b>  |
|      | <b>Description</b>   |
|      | <b>X001RESP</b>  |
|      | This response byte can be set by the exit before returning to JES2 if you want to change the value on entry. Set the response byte as follows: |
|      | <b>X001DFSP</b>  |
|      | Turn this bit setting on to suppress the standard separator page.  |
|      | <b>X001JNWS</b>  |
|      | Turn this bit setting on to suppress production of JESNEWS.  |
| 2-14 | Unchanged  |
| 15   | Return code  |
|      | A return code of:  |
| 0    | Tells JES2 that if any additional exit routines are associated with this exit, call the next consecutive exit routine.                         |
| 4    | Tells JES2 to ignore any additional exit routines associated with this exit.   |

---

## Coded example

Modules HASX01A and HASX01B in SYS1.SHASSAMP contain a sample of Exit 1.



---

## Chapter 15. Exit 2: JOB/JOBGROUP JCL statement scan (JES2 main task)

---

### Function

Exit 2 allows you to process information specified on the JOB/JOBGROUP JCL statement for jobs submitted through card readers, RJE, SNA and BSC NJE, and SPOOL reload. (For jobs/job groups submitted through internal readers or TCP/IP NJE, exit 52 is called for JOB/JOBGROUP JCL statements.) Exit 2 is invoked for the initial JOB/JOBGROUP statement each continuation of the JOB/JOBGROUP card. The initial JOB/JOBGROUP card and all continuations are read before invoking the exit.

Using Exit 2 you can:

- Add, delete, change information specified on the JOB/JOBGROUP statement. If you are adding information, such as accounting information, you can create an additional JOB/JOBGROUP continuation statements.
- Indicate which spool volumes from which a job or transaction program should allocate spool space, if the installation did not implement spool partitioning through the JES2 initialization stream.
- Add JCL statements or JES2 control statements (JECL) to the job.
- Cancel, purge, or continue processing the job/job group.
- Indicate whether additional job-related exits should be invoked for the job/job group.
- Override the value of the user portion of the job correlator.

---

### Recommendations for implementing Exit 2

Exit 2 is called for each card in the job/job group statement (the original card and all continuations). Each time the exit is called, it will pass the current card image and the statement buffer. The statement buffer includes all the operands for the JOB/JOBGROUP statement concatenated in a single buffer. For example:

```
//TEST JOB   (ACCOUNT),'PROGRAMMER',  COMMENT 1
//          CLASS=A,MSGCLASS=A,      COMMENT 2
//          USER=TEST,PASSWORD=TEST COMMENT 3
```

In this case the exit will be called 3 times, once for each card and will pass (on all 3 calls) the following data in the statement buffer (pointed to by X002STMT):

```
(ACCOUNT),'PROGRAMMER',CLASS=A,MSGCLASS=A,USER=TEST,PASSWORD=TEST
```

To alter the processing of the JOB/JOBGROUP card, the exit can:

- Update the card image passed in X002CARD. This change shows up in the listing of the job/job group.
- Update the statement buffer in X002STMT to add or modify the operands. This change does not show up in the listing of the job/job group and is not passed to conversion processing (it only affects keywords input processing scans from the JOB card). If you update the statement buffer (X002STMT) in Exit 2 and change the length of the buffer, you must update the field X002STME to indicate the new end of buffer (one byte past the last meaningful character).
- Add additional card images to the JCL stream.

## Exit 2

You can add card images to the JCL stream by either queuing a single RJC B or a chain of RJC Bs to the XPL, or by placing a card image after the current card into the area pointed to by X002JXWR and setting X002XSNC. In either case, when a card is added, the current card is re-scanned and the statement buffer is re-built. Exit 2 is driven again for the updated statement, with X002SEC set to indicate this card has been presented to the exit previously.

When adding cards using RJC Bs, use the RGETRJCB service (located in HASCSRIP) to obtain a free RJC B; then add it to one of the three RJC B queues in the XPL. Use the \$CALL macro to invoke the RGETRJCB service. Register 1 on entry must be the JRW address. The RJC B address is returned in register 1.

The 80-byte card image to be added is placed into the field RJCBCARD. RJC Bs are chained together using the RJC BRJC B field in the \$RJCB. They are added to the job stream in the order they exist in the chain. To add an element to the chain you would move the current RJC B queue head in the \$XPL into the RJC BRJC B field of the last RJC B you are adding and then set the address of the first RJC B element into the \$XPL queue head. Be aware that multiple exit 2s might be using these queues to ensure that you do not lose existing entries on the queue.

### X002RJCP

Adds the card images before the first card in the current JOB/JOBGROUP statement.

### X002RJCA

Adds the card images after the last card in the current JOB/JOBGROUP statement. In this case, the card(s) are assumed to not be a continuation of the current job/job group statement and the job/job group card is not re-scanned.

### X002RJCC

Adds the card images after the current card. It is the callers' responsibility to ensure that the proper continuation processing will occur.

When processing the last card in a JOB/JOBGROUP statement, the difference between adding a card to the X002RJCA queue and the X002RJCC queue is that the first will not re-scan the job/job group card and the second will. You can also add a single card image after the current job/job group using the X002JXWR field. In this case, the job card will be re-scanned just as if the card was added to the X002RJCC queue. To add information to the job/job group JCL statement:

1. Move a comma into the last byte of the job/job group statement image exit 2 is currently processing. The comma indicates that additional information follows on the job/job group statement.
2. Move the information you want to add to the job/job group statement to the area pointed to by X002JXWR and set the X002XSNC bit in the X002RESP byte to one. Setting X002RESP to X002XSNC indicates that the installation has supplied an additional job/job group statement image.
3. Set register 15 to X'00' or X'04' depending on whether you want to invoke additional installation exits to process the job/job group.

You can also add an additional job level JCL statement to the job as follows:

1. Ensure that the job statement image exit 2 is currently processing is the last. Exit 2 is processing the last job statement image if a comma is not in the last byte of the job statement image.

2. Place the job-level JCL statement in the are pointed to by X002JXWR and set the X002XSNC bit in the X002RESP byte to one. Setting X002RESP to X002XSNC indicates that the installation has supplied an additional job statement image.
3. Set register 15 to X'00' or X'04' depending on whether you want to invoke additional installation exits to process the job.

If you want to issue messages when you cancel or purge the job:

1. Generate the message text in exit 2.
2. Move the message text to area pointed to by X002JXWR and set the X002XSEM bit in X002RESP to one. Setting X002RESP to X002XSEM indicates that the installation exit has supplied an error message that will be added to the JCL listing.
3. Set register 15 to X'08' to indicate JES2 should cancel or purge the job/job group.

The following indicators in the XPL can assist you in adding a card image to the current job/job group statement:

#### **X002LOPR**

Current card has the last operand in the JOB/JOBGROUP statement. There may be additional continued comments after the current card.

#### **X002QUOT**

A quoted string is being continued from the current card to the next card. Pay attention if a card is being added after this card.

#### **X002CCMT**

The current card is a continued comment. Operand added to this card or after this card will not be processed.

#### **X002LAST**

This is the last card image in the job/job group statement.

To assist you in processing the operands on a statement, you can use either of the following services to parse the statement buffer passed in X004STMT:

- Use the \$SCAN facility to parse the operands with the standard \$SCAN rules for statements. This give you the flexibility of \$SCAN, but the parsing rules are not the same as normal JCL. See the \$SCAN and \$SCANTAB macros for additional information.
- Use the RCARDSCN service and \$STMTTAB macro to parse the operands with standard JCL rules. This is the service used by JES2 input processing to parse the statement buffer. However, the RCARDSCN service only parses the operands and calls a processing routine to do all the conversions and storing of data. Conversion of data to binary to store into data areas is the responsibility of the processing routines. See the \$STMTTAB macro for more information.

---

## **Environment**

### **Task**

JES2 main task. You must specify ENVIRON=JES2 on the \$MODULE macro.

### **AMODE/RMODE requirements**

AMODE 31, RMODE ANY

## Supervisor/problem program

JES2 places exit 2 in supervisor state and PSW key 1.

## Restrictions

- See Appendix A, "JES2 exit usage limitations," on page 403 for a listing of specific instances when this exit will be invoked or not invoked.
- Installation Exit 2 is not invoked for jobs such as SYSLOG, \$TRCLOG, or JESMSG.
- Do not use this exit to set fields in the JCT; they will likely be overwritten by future processing.
- Installation Exit 2 is not invoked for jobs submitted through the internal reader or TCP/IP NJE

## Recovery

\$ESTAE is in effect and provides minimal recovery. Input Services will attempt to recover from any program check errors experienced by exit 2. However, you should not depend on JES2 for recovery.

## Job exit mask

Exit 2 and all subsequent job-related installation exits can be suppressed after Exit 2 processes the initial job statement image. You can set the 2nd bit in the job exit suppression mask (JCTXMASK) or you can indicate the exit is disabled in the JES2 initialization stream.

## Storage recommendations

If exit 2 requires work areas or additional storage, you can:

- Use the 80-byte work area, JCTXWRK, in the JCT
- Issue \$GETMAIN to obtain additional storage

## Mapping macros normally required

\$PCE, \$RDRWORK, \$JCT, \$JCTX, \$HCT, \$BUFFER, \$MIT, \$HASPEQU, \$JRW

---

## Point of processing

Installation Exit 2 can be invoked when JES2 encounters either:

- the JOB/JOBGROUP statement, this is called the initial job/job group statement image.
- or a continuation of the JOB/JOBGROUP statement, this is called an additional JOB/JOBGROUP continuation statement image.

Module HASPRDR invokes installation Exit 2 for initial JOB/JOBGROUP statement images. Input service has obtained and initialized the job/job group control table (JCT) and the IOT before calling installation Exit 2. After performing the processing you coded in Exit 2, input services complete scanning the JOB/JOBGROUP statement and allocate spool space for the job/job group.

Module HASPRDR invokes installation Exit 2 for continuation JOB/JOBGROUP statement images.

---

## Extending the JCT control block

1. You can use the \$JCTX macro extension service to add, expand, locate, and delete extensions to the job control table (\$JCT) control block from this exit. For example, you can use these extensions to store job-related information. Extensions that are added can be SPOOLED extensions that are available to all exits that read the JCT or local extension that are available only to input processing exits (2, 3, 4, and 20) and the \$QMOD exit (51). The size of SPOOLED extensions is based on the SPOOL buffer size and is less than 3K. You can have up to 8K of local extension regardless of SPOOL buffer size.
2. If you need to change the scheduling environment, use the JCTSCHEN field in the JCT.

---

## Programming considerations

1. Be aware that when a JOB/JOBGROUP card image is passed to Exit 2, any `/**` comment cards embedded within that statement are also passed to the exit. For example, all of the following are passed:

```

//ABC JOB
/** COMMENT CARD
// CLASS=A

```

If within a `/**` comment you embed valid JOB/JOBGROUP card parameters, there is potential to cause confusion in your scan routine and lead to unpredictable results. Consider the following:

```

/** CHANGED CLASS FROM ORIGINAL CLASS=B

```

2. When this exit adds or modifies cards, whether the change is sent over NJE (including SPOOL offload) depends on the statement type and the setting of option flags in the \$XPL or \$RJCB. Modified JECL cards (original and modified card are both JECL) are not sent over NJE. By default, all other changes are sent over NJE. To limit changes to only the local node, you can set the X002RLOC in the XPL (affects the current card) or set the RJCB3LOC bit in any RJCBs that are added.
3. Updating the statement buffer is only valid for parameters that have \$STMTTABs in HASCSRIP.
4. Updates to the statement buffer are not passed to the converter and will not be seen by Exit 6 or Exit 60.

---

## Register contents on entry to exit 2

### Register

#### Contents

- 0 Pointer to a parameter list with the following structure, mapped by \$XPL:

#### Field Name

#### Description

#### XPLID

Eyecatcher

#### XPLLEVEL

Version level for base XPL

#### XPLXITID

Exit ID number

## Exit 2

|  
| **XPLEXLEV**  
|       Version number for exit  
|  
| **X002IND**  
|       Indicator byte  
|  
|       **X002JOBC**  
|           JOB card detected  
|  
|       **X002JOBG**  
|           JOBGROUP card detected  
|  
| **X002COND**  
|       Condition byte  
|  
|       **X002CONT**  
|           Card is a continuation (not first card of JOB/JOBGROUP  
|           statement)  
|  
|       **X002SEC**  
|           This card has been passed to the exit previously for this  
|           job/job group (set if cards added before this card)  
|  
| **X002ECLT**  
|       Job JECL processing indicator. On input, this field indicates if JES2  
|       will process JECL statements for the current job. On output, the  
|       exit program can change this field to override the JECL processing  
|       for the current job. The following bits are defined for this field:  
|  
|       **X002J2CL**  
|           If this bit is on, JES2 will process the JES2 JECL statements  
|           for the current job according to the rules specified by the  
|           JES2= keyword of the JECLDEF command and  
|           initialization statement.  
|           If this bit is off, JES2 JECL statements for the current job  
|           will be ignored.  
|  
|       **X002J3CL**  
|           If this bit is on, JES2 will process the JES3 JECL statements  
|           for the current job according to the rules specified by the  
|           JES3= keyword of the JECLDEF command and  
|           initialization statement.  
|           If this bit is off, JES3 JECL statements for the current job  
|           will be ignored.  
|  
| **X002RESP**  
|       Response byte  
|  
|       **X002XSNC**  
|           Exit supplied next card in X002JXWR  
|  
|       **X002XSEM**  
|           Exit supplied error message in X002JXWR  
|  
|       **X002JCMT**  
|           Skip processing card  
|  
|       **X002KILL**  
|           Kill current job/job group (queue job to OUTPUT  
|           processing)  
|

|                   **X002PURG**  
|                    Purge current job/job group

|                   **X002RLOC**  
|                    Changed or added cards are not sent through NJE (set  
|                    RJCB3LOC in current RJCB)

|                   **XPLSIZE**  
|                    Size of parameter list, including base section

|                   **X002CARD**  
|                    80-byte card image address

|                   **X002FLGX**  
|                    Pointer to exit flags (same as JRWFLAGX)

|                   **X002JXWR**  
|                    80-byte exit work area address (same as JCTXWRK)

|                   **X002JCT**  
|                    JCT address

|                   **X002JQE**  
|                    JQE address

|                   **X002AREA**  
|                    JRW address

|                   **X002STMT**  
|                    Concatenated statement buffer. This is all the operands on all  
|                    continuations cards for this statement

|                   **X002STME**  
|                    End of statement+1 pointer (in buffer)

|                   **X002STML**  
|                    Statement label (job/job group name)

|                   **X002STMV**  
|                    Statement verb (JOB/JOBGROUP)

|                   **X002RJCP**  
|                    RJCBs to add before this JOB/JOBGROUP statement

|                   **X002RJCA**  
|                    RJCBs to add after this JOB/JOBGROUP statement

|                   **X002RJCC**  
|                    RJCBs to add after the current card

|                   **X002FLG1**  
|                    Statement flag byte

|                    **X002LOPR**  
|                    Last operand is on the current card

|                    **X002QUOT**  
|                    Unfinished quote at end of current card

|                    **X002CCMT**  
|                    Current card is a continued comment

|                    **X002LAST**  
|                    Last card in job/job group statement

## Exit 2

### X002OCLS

Override job class (batch jobs only)

### X002OJNM

Override job name. Specifying a non-zero value in this field will alter the job name that is used when processing the job. The exit must ensure that the provided job name is valid (such as proper characters with blank padded on the right).

**Note:** This does not alter the job name in the JCL that is printed with the output of the job.

### X002UCOR

Override user portion of the job correlator

1 Address of a 3-word parameter list with the following structure:

#### Word 1

(+0) points to the JOB/JOBGROUP statement image buffer

#### Word 2

(+4) points to the exit flag byte, JRWFLAGX, in the \$JRW

#### Word 3

(+8) points to the JCTXWRK field in the \$JCT

2-9 Not applicable

10 Address of the \$JCT

11 Address of the HCT

12 Not applicable

13 Address of the PCE

14 Return address

15 Entry address

---

## Register contents when exit 2 passes control back to JES2

Upon return from this exit, the register contents must be:

0-13 Not applicable

14 Return address

15 Return code

A return code of:

0 Tells JES2 that if any additional exit routines are associated with this exit, call the next consecutive exit routine. If there are no additional exit routines associated with this exit, continue with normal HASPRDR processing.

4 Tells JES2 to ignore any additional exit routines associated with this exit and to continue with normal HASPRDR processing.

8 Tells JES2 to cancel the job/job group; output (the incomplete JCL images listing) is produced.

12 Tells JES2 to purge the job/job group; no output is produced.



| **Note:** If register 10 contains 0 (the JCT is unavailable), JES2 ignores any return  
| code greater than 4.

---

| **Coded example**

| Module HASX02A in SYS1.SHASSAMP contains a sample of exit 2.



---

## Chapter 16. Exit 3: JOB/JOBGROUP statement accounting field scan (JES2 main task)

---

### Function

This exit allows you to provide an exit routine for scanning the JOB/JOBGROUP statement accounting field and for setting the corresponding fields in the appropriate JES2 control blocks. Exit 3 get control for jobs/job groups submitted through card readers, RJE, SNA and BSC NJE and SPOOL reload. For job/job group submitted through internal readers or TCP/IP NJE exit 53 is called to JOB/JOBGROUP statement accounting field.

You can use your exit routine to interpret the variables in the accounting field and, based on this interpretation, decide whether to cancel the job/job group.

Use this exit to record alterations to the accounting field; they will not appear on the user's output but are reflected in the JCT and when the SMF type 6 record is written.

This exit is associated with the existing HASPRSCN accounting field scan subroutine. You can write your exit routine as a replacement for HASPRSCN or you can use a return code to input processing to call HASPRSCN after your exit routine has executed. In either case, when this exit is implemented and enabled, JES2 treats your exit routine as the functional equivalent of HASPRSCN. The specification of the ACCTFLD parameter on the JOBDEF initialization statement, which normally determines whether JES2 is to call HASPRSCN, becomes an additional factor in determining whether your exit routine is to be called. The exit is taken only if the ACCTFLD= parameter on the JOBDEF initialization statement is specified as either REQUIRED or OPTIONAL. The exit is not taken if ACCTFLD=IGNORE is specified. When it is called, your exit routine, rather than the ACCTFLD parameter, determines whether HASPRSCN is to be executed as an additional scan of the accounting field. For a complete explanation of how the ACCTFLD parameter is specified, see *z/OS JES2 Initialization and Tuning Reference*. The relationship of HASPRSCN to this exit is described in greater detail in the "Other Programming Considerations" below.

You can use this exit for input processing - Accounting field.

---

### Related exits

Use Exit 2 to alter the accounting information and supply new accounting information at the time the entire JOB/JOBGROUP statement is first scanned.

---

### Environment

#### Task

JES2 main task. You must specify ENVIRON=JES2 on the \$MODULE macro.

#### AMODE/RMODE requirements

AMODE 31, RMODE ANY

## Supervisor/problem program

JES2 places Exit 3 in supervisor state and PSW key 1.

## Restrictions

See Appendix A, "JES2 exit usage limitations," on page 403 for a listing of specific instances when this exit will be invoked or not invoked.

## Recovery

\$ESTAE recovery is in effect. Input processing recovery routine will attempt to recover from program check errors, including program check errors in the exit routine. However, as with every exit, your exit routine for this exit *should not* depend on JES2 for recovery. JES2 cannot anticipate the exact purpose of your exit routine. Therefore, it can provide no more than minimal recovery. You should provide your own recovery within your exit routine.

## Job exit mask

Exit 3 is subject to suppression. You can suppress Exit 3 by either implementing exit 2 to set the 3rd bit in the job exit suppression mask (JCTXMASK) or by indicating the exit is disabled in the JES2 initialization stream.

## Mapping macros normally required

\$PCE, \$RDRWORK, \$JCT, \$JCTX, \$HCT, \$MIT, \$BUFFER, \$HASPEQU, \$JRW

---

## Point of processing

This exit is taken from the JES2 main task, from the JOB/JOBGROUP statement processing routine of HASPRDR. The exit occurs after JES2 has scanned the entire JOB/JOBGROUP statement, but before the execution of the HASPRSCN accounting field scan subroutine, if HASPRSCN is to be called. The JCT has been initialized with the JES2 and installation defaults; in addition, those fields of the JCT that correspond to JOB/JOBGROUP statement parameters other than accounting field parameters have been set. The accounting field image is passed in X003ACCT and the length in X003ACTL.

Table 5 lists some of the fields in the JCT that you can modify.

Table 5. Selected JES2 Job Control Table Fields

| Field Name in JCT | Length (Bytes) | Field     | Bit | Meaning                                  | Notes |
|-------------------|----------------|-----------|-----|--|-------|
| JCTSMFLG          | 1              | SMF Flags | 0–1 | These bits are not part of the interface | –     |
|                   |                |           | 2   | If set, IEFUSO exit not taken            | 1,2   |
|                   |                |           | 3–4 | These bits are not part of the interface | –     |
|                   |                |           | 5   | If set, no type 6 SMF records produced   | 1,2   |
|                   |                |           | 6   | If set, IEFUJP exit not taken            | 1,2   |
|                   |                |           | 7   | If set, no type 26 SMF record produced   | 1,2   |
| JCTJOBFL          | 1              | Job Flags | 0   | Background job                           | –     |
|                   |                |           | 1   | TSO/E (foreground) job                   | –     |
|                   |                |           | 2   | Started task                             | –     |
|                   |                |           | 3   | No job/job group journaling              | 1,2   |

Table 5. Selected JES2 Job Control Table Fields (continued)

| Field Name in JCT | Length (Bytes) | Field  | Bit | Meaning  | Notes   |
|-------------------|----------------|--|-----|--|---------|
|                   |                |  | 4   | No output  | 1,2     |
|                   |                |  | 5   | TYPRUN=SCAN  | 1,2,3   |
|                   |                |  | 6   | TYPRUN=COPY  | 2,3     |
|                   |                |  | 7   | Job restartable  | 1,2,8   |
| JCTJBOPT          | 1              | Job Options                                    | 0   | /*PRIORITY card was read and value is in priority field (JCTIPRIO) | –       |
|                   |                |  | 1   | /*SETUP card was read  | –       |
|                   |                |  | 2   | TYPRUN=HOLD was specified  | 1,2,4   |
|                   |                |  | 3   | No job/job group log for this job                                  | 1,2,6,8 |
|                   |                |  | 4   | Execution batch job  | 1,2     |
|                   |                |  | 5   | The job/job group was read through an internal reader              | –       |
|                   |                |  | 6   | The job was rerun  | –       |
|                   |                |  | 7   | This bit is not part of the interface                              | –       |
| JCTJOBID          | 8              | JES2 JOB/JOBGROUP identifier                   |     |  | –       |
| JCTJNAME          | 8              | job/job group name                             |     |  | 3       |
| JCTPNAME          | 20             | Programmer name                                |     |  | 3       |
| JCTMCLAS          | 1              | Message class                                  |     |  | 1,4     |
| JCTJCLAS          | 1              | Job class                                      |     |  | 1,4     |
| JCTIPRIO          | 1              | Priority                                       |     |  | 1,5     |
| JCTROUTE          | 4              | Route code of input device (binary)            |     |  | –       |
| JCTINDEV          | 8              | Input device name                              |     |  | –       |
| JCTACCTN          | 4              | Account number                                 |     |  | 1,6     |
| JCTROOMN          | 4              | Room number                                    |     |  | 1,6,8   |
| JCTETIME          | 4              | Estimated real-time job will run               |     |  | 1,6,8   |
| JCTESTLN          | 4              | Estimated count of output lines (in thousands) |     |  | 1,6,8   |
| JCTESTPU          | 4              | Estimated number of output cards punched       |     |  | 1,6,8   |
| JCTESTBY          | 4              | Estimated number of SYSOUT bytes               |     |  | 8       |
| JCTESTPG          | 4              | Estimated number of output pages               |     |  | 8       |
| JCTFORMS          | 8              | Job Forms                                      |     |  | 1,6,8   |
| JCTCPYCT          | 1              | Job copy count (binary)                        |     |  | 1,6,8   |
| JCTLINCT          | 1              | Lines per page (binary)                        |     |  | 1,6,8   |
| JCTPROUT          | 4              | Default print routing (binary)                 |     |  | 1,7     |

## Exit 3

Table 5. Selected JES2 Job Control Table Fields (continued)

| Field Name in JCT | Length (Bytes) | Field                          | Bit | Meaning | Notes |
|-------------------|----------------|--------------------------------|-----|---------|-------|
| JCTPUOUT          | 4              | Default punch routing (binary) |     |         | 1,7   |
| JCTPROCN          | 8              | Procedure DD name              |     |         | 1,2,8 |

### Note:

1. Can be modified by installation routine.
2. Preset from JOBCLASS(v) initialization statement according to job class. Job class is not relevant to job groups, only jobs running within the scope of a job group.
3. Preset from JOB/JOBGROUP statement
4. From JOB statement, if specified; otherwise according to input device as established at JES2 initialization (for example, in RDR(nn)).
5. Exit 3 can use field JCTIPRIO to force a priority for a job subject to the limitations of the input device's priority increment and priority limit values. When exit 3 receives control, a value of C\*' in JCTIPRIO indicates a priority has not been forced by an exit routine. If you want to force a priority in exit 3, set JCTIPRIO to a value between 0 and 15 in the low-order four bits on the field.

**Note:** Whether you may set field JCTIPRIO and the allowable values depend on the specific exit.

6. Set by the routine (HASPRSCN) used by JES2 to scan the account field of the JOB/JOBGROUP statement. Exit 3 can specify that JES2 cannot call HASPRSCN.
7. Preset according to an input device initialization parameter (for example RDR(nn) ). If not set at initialization the parameter defaults to the job input source value (LOCAL or RMT(nnnn)). Can be modified by a /\*ROUTE statement after the scan exit.
8. Can be modified by a /\*JOBPARM statement after the scan exit.

---

## Extending the JCT control block

You can use the \$JCTX macro extension service to add, expand, locate, and delete extensions to the job control table (\$JCT) control block from this exit. For example, you can use these extensions to store job/job group-related information. Extensions that are added can be SPOOLed extensions that are available to all exits that read the JCT or local extension that are available only to input processing exits (2, 3, 4, and 20) and the \$QMOD exit (51). The size of SPOOLed extensions is based on the SPOOL buffer size and is less than 3K. You can have up to 8K of local extension (regardless of SPOOL buffer size).

---

## Programming considerations

1. The accounting field resides in a 144-byte work area pointed to by X003ACCT in the XPL passed to the exit in register 0.
2. If you need to verify the existence of a JOB/JOBGROUP rather than a started task (STC) or TSO/E logon, this can be done by comparing the JCTJOBID field to a "J". The presence of a "J" indicates the existence of a JOB and a presence of a "G" indicates JOB GROUP.

3. If you need to change the scheduling environment, use the JCTSCHEN field in the JCT.
4. The ACCTFLD parameter on the JOBDEF statement indicates whether JES2 should scan the accounting field of a JOB/JOBGROUP statement. For further details concerning the use of the ACCTFLD parameter, see *z/OS JES2 Initialization and Tuning Reference*.  
 If the ACCTFLD parameter indicates that the scan is to be performed, and if this exit is implemented and enabled, input processing will call your exit routine to perform the scan. If your exit routine passes a return code of 0 or 4 to JES2, input processing will call the existing HASPRSCN accounting field scan subroutine after your routine has executed. Note that if both routines are to be called, your routine should not duplicate HASPRSCN processing. For example, your routine should not set the fields in the JCT that are set by HASPRSCN. However, if your routine passes a return code of 8 or 12 to JES2, JES2 suppresses execution of HASPRSCN. If the ACCTFLD parameter indicates that the scan is to be performed but the exit is disabled, JES2 calls only HASPRSCN; your exit routine is not called and is not given the opportunity to allow or suppress HASPRSCN execution. If the ACCTFLD parameter indicates that a scan is not to be performed, your exit routine is not called, even if this exit is enabled, and execution of HASPRSCN is also suppressed.
5. The ACCTFLD parameter on the JOBDEF statement indicates whether JES2 will cancel a job/job group if the accounting field on the JOB/JOBGROUP statement is invalid or if a JCL syntax error has been detected during input processing. Note that your exit routine can affect this termination processing. For example, ACCTFLD=REQUIRED indicates that JES2 should scan the accounting field, that the job/job group should be canceled if the accounting field is invalid, and that the job/job group should be canceled if a JCL syntax error has been found. If you pass a return code of 8 to JES2, HASPRSCN is not called, therefore cannot terminate a job/job group with an invalid accounting field, even though ACCTFLD=REQUIRED. Also note that HASPRSCN scans the accounting field passed in X003ACCT. Therefore, if your routine alters this field, you affect HASPRSCN processing.
6. The specification of the ACCTFLD parameter is stored in the HCT, in field \$RJBOPT. If your exit routine is meant to completely replace HASPRSCN, you may want to access this field for use by your algorithm.
7. Typically, use this exit, rather than Exit 2, to alter the JCT directly. If you use Exit 2 to alter the JCT, later processing might override your changes. The job exit mask and the spool partitioning mask are exceptions. See note 2 of Exit 2 for more information.
8. An 80-byte work area pointed to by X003JXWR in the XPL is available for use by your routine. If your routine requires additional work space, use the \$GETMAIN macro to obtain storage (and the \$FREEMAIN macro to return it to the system when your routine has completed).
9. When passing a return code of 12, your exit routine can pass an installation-defined error message to JES2 to be added to the JCL data set rather than the standard error message. To send an error message, generate the message text in your exit routine, move it to area pointed to by X003JXWR, and set the X003XSEM bit in X003RESP to one.

**Note:** The standard error message, \$HASP110, still appears in SYSLOG on this path, in addition to the installation-defined message. However, only the installation message will be placed in the JCL data set and no WTO will be issued for the installation-defined message unless Exit 3 issues the WTO itself.

## Exit 3

10. If there is no accounting field on a JOB/JOBGROUP statement, the length passed by JES2 to the exit routine in X003ACTL is zero. Your exit routine should take this possibility into account.
11. If you intend to use this exit to process nonstandard accounting field parameters, you should either suppress later execution of HASPRSCN or code your exit routine to delete nonstandard parameters before passing control to HASPRSCN. If you do neither, that is, if you allow HASPRSCN to receive the nonstandard parameters, it might cancel the job because of an illegal accounting field (depending on how the ACCTFLD parameter on the JOBDEF statement is specified).
- If you change the length of the accounting field, you must reload the length into field JRWACCTL.
12. There are three job class fields (JCTJCLAS, JCTCLASS, and JCTAXCLS) in the JCT. JCTJCLAS is the initial job execution class as set during input processing and used when building the JQE during that processing. JCTCLASS is the actual execution class. After input processing it contains the same value as JCTJCLAS, but it might be updated when the job executes if a \$T command was used to update the job's class before execution. Therefore, JCTJCLAS and JCTCLASS could be different. JCTAXCLS is a copy of the actual execution class (JCTCLASS) that is propagated into the network JOB trailer. Do not use any exit routine to set the JCTAXCLS field.
- If you intend to use an exit 3 routine to change the execution class of a job, you should set the X003JCLS field in the \$XPL passed in register 0.

---

### Register contents when Exit 3 gets control

|   |   |
|---|---|
| 0 | Pointer to a parameter list with the following structure, mapped by \$XPL:  |
|   | <b>Field Name</b>   |
|   | <b>Description</b>  |
|   | <b>XPLID</b>  |
|   | Eyecatcher  |
|   | <b>XPLLEVEL</b>   |
|   | Version level for base XPL  |
|   | <b>XPLXITID</b>   |
|   | Exit ID number  |
|   | <b>XPLEXLEV</b>   |
|   | Version number for exit   |
|   | <b>X003IND</b>  |
|   | Indicator byte  |
|   | <b>X003COND</b>   |
|   | Condition byte  |
|   | <b>X003ECLT</b>   |
|   | Job JECL processing indicator. On input, this field indicates if JES2 will process JECL statements for the current job. On output, the exit program can change this field to override the JECL processing for the current job. The following bits are defined for this field: |
|   | <b>X003J2CL</b>   |
|   | If this bit is on, JES2 will process the JES2 JECL statements   |



for the current job according to the rules specified by the JES2= keyword of the JECLDEF command and initialization statement.

If this bit is off, JES2 JECL statements for the current job will be ignored.

**X003J3CL**

If this bit is on, JES2 will process the JES3 JECL statements for the current job according to the rules specified by the JES3= keyword of the JECLDEF command and initialization statement.

If this bit is off, JES3 JECL statements for the current job will be ignored.

**X003RESP**

Response byte

**X003XSEM**

Exit supplied error message in X003JXWR

**X003SKIP**

Skip default accounting field

**X003KILL**

Kill current job/job group (queue job/job group to OUTPUT processing)

**X003JCLS**

The current job class for the job. This can be updated by the exit to set a new job class for the job.

**XPLSIZE**

Size of parameter list, including base section

**X003ACCT**

Address of accounting field

**X003FLGX**

Pointer to exit flags (same as JRWFLAGX)

**X003JXWR**

80-byte exit work area address (same as JCTXWRK)

**X003JCT**

JCT address

**X003JQE**

JQE address

**X003AREA**

JRW address

**X003JCLS**

The current job class for the job. This can be updated by the exit to set a new job class for the job.

**1** Address of a 3-fullword parameter list

**Word 1 (+0)**

points to the accounting field (JCTWORK in the JCT)

**Word 2 (+4)**

points to the exit flag byte, JRWFLAGX in the JRW

## Exit 3

|  |             |  |
|--|-------------|--|
|  |             | <b>Word 3 (+8)</b>                     |
|  |             | points to the JCTXWRK field in the JCT |
|  | <b>2-10</b> | Not applicable                         |
|  | <b>10</b>   | Address of the JCT                     |
|  | <b>11</b>   | Address of the HCT                     |
|  | <b>12</b>   | Not applicable                         |
|  | <b>13</b>   | Address of the HASPRDR PCE             |
|  | <b>14</b>   | Return address                         |
|  | <b>15</b>   | Entry address                          |

---

### Register contents when Exit 3 passes control back to JES2

|  |             |                |
|--|-------------|----------------|
|  | <b>0-13</b> | Not applicable |
|  | <b>14</b>   | Return address |
|  | <b>15</b>   | Return code    |

A return code of:

|  |           |  |
|--|-----------|--|
|  | <b>0</b>  | Tells JES2 that if any additional exit routines are associated with this exit, call the next consecutive exit routine. If there are no additional exit routines associated with this exit, use the current setting of the ACCTFLD parameter on the JOBDEF statement to determine whether to execute the HASPRSCN subroutine. |
|  | <b>4</b>  | Tells JES2 to ignore any other exit routines associated with this exit and to use the current setting of the ACCTFLD parameter on the JOBDEF statement to determine whether to execute HASPRSCN.   |
|  | <b>8</b>  | Tells JES2 to suppress execution of HASPRSCN and to complete job/job group card processing.  |
|  | <b>12</b> | Tells JES2 to cancel the job because an illegal accounting field has been detected. Tells JES2 to suppress execution of HASPRSCN and to queue the job for output; output (the incomplete JCL images listing) is produced.  |

---

### Coded example

Module HASX03A in SYS1.SHASSAMP contains a sample of Exit 3.

---

## Chapter 17. Exit 4: JCL and JES2 control statement scan (JES2 main task)

---

### Function

This exit allows you to provide an exit routine for scanning JCL and JES2 control statements for jobs submitted through card readers, RJE, SNA and BSC NJE, and SPOOL reload. For jobs/job groups submitted through internal readers or TCP/IP NJE, exit 54 is called to process JCL and JES2 control statements (JECL). If this exit is implemented and enabled, it is taken whenever JES2 encounters a JCL or JES2 control statement. (Note: JOB/JOBGROUP statements are not included in the scan).

For JCL statements, your exit routine can interpret JCL parameters and, based on this interpretation, decide whether JES2 should cancel the job/job group, purge the job/job group, or allow the job/job group to continue normally. Your routine can also alter JCL parameters and supply additional JCL parameters. If necessary, in supplying expanded JCL data, your routine can pass a JCL continuation statement back to JES2 or add statements before or after the current JCL statement.

For JES2 control statements, your routine can interpret the JES2 control parameters and sub-parameters and, based on this interpretation, decide whether JES2 should cancel the job/job group, purge the job/job group, or allow the job/job group to continue normally. For any JES2 control statement, you can write your exit routine as a replacement for the standard JES2 control statement processing, suppressing execution of the standard JES2 scan, or you can perform your own (partial) processing and then allow JES2 to execute the standard control statement routine processing. Also, your routine can alter a JES2 control statement and then pass the modified statement back to JES2 for standard processing, or your routine can pass an entirely new JES2 control statement back to JES2, to be read (and processed) before or after the current control statement.

This exit also allows you to process your own installation-specific JES2 control statements or to implement new, installation-specific sub-parameters for existing JES2 control statements.

This exit gets control when JES2 detects a JES2 control statement or JCL statement within a job. JES2 also gives control to your exit routine when JES2 detects a JES2 control statement or JCL statement outside a job. JES2 also gives control to your exit routine when it detects a JCL continuation statement.

This exit allows you to input processing - JCL/JECL.

---

### Environment

#### Task

JES2 main task. You must specify ENVIRON=JES2 on the \$MODULE macro.

#### AMODE/RMODE requirements

RMODE ANY, AMODE 31

## Supervisor/problem program

JES2 places Exit 4 in supervisor state and PSW key 1.

## Restrictions

JES2 does not invoke this exit for JCL from cataloged procedures. See Appendix A, "JES2 exit usage limitations," on page 403 for other specific instances when this exit is invoked or not invoked.

## Recovery

\$ESTAE recovery is in effect. The recovery routine established by JES2 attempts to recover from program check errors, including program check errors in the exit routine itself. However, as with every exit, your exit routine *should not* depend on JES2 for recovery. JES2 cannot anticipate the exact purpose of your exit routine. Therefore, it can provide no more than minimal recovery. Provide your own recovery within your exit routine.

## Job exit mask

Exit 4 is subject to suppression. You can suppress exit 4 by either implementing exit 2 to set the 4th bit in the job exit suppression mask (JCTXMASK) or disabling the exit in the JES2 initialization stream.

## Mapping macros normally required

\$HCT, \$JCT, \$JCTX, \$MIT, \$PCE, \$RDRWORK, \$BUFFER, \$HASPEQU, \$JRW

---

## Point of processing

This exit is taken from HASPRDR in the JES2 main task. The exit occurs in the main processing loop of HASPRDR, after HASPRDR has read an entire JES2 control statement or JCL statement (including JCL continuations) but before it has processed any keywords on the statement. The statement may be outside a valid job/job group (that is, when there is no current job structure active on the reader).

This exit is invoked for jobs/job groups submitted through card readers, RJE, SNA and BSC NJE, and SPOOL reload. It is not invoked for jobs/job groups submitted through the internal reader or TCP/IP NJE

---

## Programming considerations

1. This exit is taken once for each control statement (except for JOB/JOBGROUP statements) encountered by JES2. X004IND indicates whether the current statement is a JCL statement or a JES2 control statement. Your exit routine gets control for /\* comment, /\* (generated), and /\* PRIORITY JES2 control statements.
2. During input processing, JES2 writes the JCL records to a JCL data set. If an error occurs during input processing, it is the JCL data set that is printed when the job goes through output processing. If the job is successfully processed by input processing, the JCL data set is the input for the converter. The converter produces a JCL images data set that is printed when the job goes to output processing after being successfully processed by input processing.
3. Exit 4 is called for each card in a JCL statement (the original card and all continuations) and for each JES2 control statement. Each time the exit is called, it is passed the current card image and the statement buffer. The

statement buffer is all the operands for the JCL statement or JES2 control statement concatenated in a single buffer. For example:

```
//OUTSET DD SYSOUT=H,OUTPUT=*.OUT1, COMMENT1
// DCB=(LRECL=8000,RECFM=FB,BLKSIZE=8000) COMMENT2
```

In this case the exit will be called 2 times, once for each card and will be passed (on both calls) the following data in the statement buffer (pointed to by X004STMT):

```
SYSOUT=H,OUTPUT=*.OUT1,DCB=(LRECL=8000,RECFM=FB,BLKSIZE=8000)
```

To alter the processing of the JCL statement or JES2 control card, the exit can:

- Update the card image passed in X004CARD. This change shows up in the listing of the job
- Update the statement buffer in X004STMT to add or modify the operands. This change does not show up in the listing of the job and is not passed to conversion processing (it only affects keywords input processing scans from the JOB card). If you update the statement buffer (X004STMT) in Exit 4 and change the length of the buffer, you must update the field X004STME to indicate the new end of buffer (one byte past the last meaningful character).
- Add additional card images to the JCL stream

You can add card images to the JCL stream by either queuing a single RJCBC or a chain of RJCBCs to the XPL, or by placing a card image to be placed after the current card into the area pointed to by X004JXWR and setting X004XSNC. In either case, when a card is added, the current card is re-scanned and the statement buffer is re-built. Exit 4 is driven again for the updated statement, with X004SEC set to indicate this card has been presented to the exit previously.

When adding cards using RJCBCs, use the RGETRJCB service (located in HASCSRIP) to obtain a free RJCBC; then add it to one of the three RJCBC queues in the XPL. Use the \$CALL macro to invoke the RGETRJCB service. Register 1 on entry must be the JRW address. The RJCBC address is returned in register 1.

The 80-byte card image to be added is placed into the field RJCBCARD. RJCBCs are chained together using the RJCBCRJCBC field in the \$RJCBC. They are added to the job stream in the order they exist in the chain. To add an element to the chain you would move the current RJCBC queue head in the \$XPL into the RJCBCRJCBC field of the last RJCBC you are adding, and then set the address of the first RJCBC element into the \$XPL queue head. Be aware that multiple exit 4s might be using these queues, so ensure that you do not lose existing entries on the queue.

#### **X004RJCP**

Adds the card images before the first card in the current JCL statement or before the JES2 control card.

#### **X004RJCA**

Adds the card images after the last card in the current JCL statement. In this case, the card(s) are assumed to not be a continuation of the current JCL statement and the JCL cards are not re-scanned.

#### **X004RJCC**

Adds the card images after the current card. It is the callers' responsibility to ensure that the proper continuation processing will occur.

## Exit 4

When processing the last card in a JCL statement or when processing a JES2 control statement, the difference between adding a card to the X004RJCA queue and the X004RJCC queue is that the first will not rescan the current statement and the second will.

Add the card images after the current card. It is the callers' responsibility to ensure that the proper continuation processing will occur.

- a. Move a comma into the last byte of the operand on the JCL card image (X004CARD) that exit 4 is currently processing. The comma indicates additional information follows this JCL statement.
- b. Move the information you want to add to the JCL statement to the area pointed to by X004JXWR and set the X004XSNC bit in the X004RESP byte to one. Setting X004RESP to X004XSNC indicates that the installation has supplied an additional JCL statement image.
- c. Set register 15 to X'00' or X'04' depending on whether you want to invoke additional installation exits to process the statement.

You can also add an additional JCL statement to the job as follows:

- a. Ensure that the JCL card image that exit 4 is currently processing is the last for the current statement (X004LOPR is on). Exit 4 is processing the last JCL statement image if a comma is not in the last byte of the JCL operand on the card image.
- b. Place the JCL statement in the area pointed to by X004JXWR and set the X004XSNC bit in the X004RESP byte to one. Setting X004RESP to X004XSNC indicates that the installation has supplied an additional JCL statement image.
- c. Set register 15 to X'00' or X'04' depending on whether you want to invoke additional installation exits to process the JCL or JECL card.

For JECL statements, because there are no formal rules for the format of the statement, the statement buffer will contain all the text after the VERB on the JECL statement. The following is an example of a JOBPARM JECL statement and the associated statement buffer:

```
/*JOBPARM SYSAFF=(IBM1),COPIES=2 This is a comment
```

The statement buffer for this statement would contain:

```
SYSAFF=(IBM1),COPIES=2 This is a comment
```

The statement buffer contains the comment in this case (and any trailing blanks) because there is no formal rule stating where a JECL statement ends.

4. Updating the statement buffer is only valid for parameters that have \$STMTTABs in HASCSRIP.
5. Updates to the statement buffer are not passed to the converter and will not be seen by Exit 6 or Exit 60.
6. The following indicators in the XPL can assist you in adding a card image to the current JCL statement:

### **X004LOPR**

Current card has the last operand in the JCL statement. There can be additional continued comments after the current card.

### **X004QUOT**

A quoted string is being continued from the current card to the next card. Pay attention if a card is being added after this card.

**X004CCMT**

The current card is a continued comment. Operand added to this card or after this card will not be processed.

**X004LAST**

This is the last card image in the JCL or JECL statement.

7. To assist you in processing the operands on a statement, you can use either of the following services to parse the statement buffer passed in X004STMT:
  - Use the \$SCAN facility to parse the operands with the standard \$SCAN rules for statements. This give you the flexibility of \$SCAN but the parsing rules are not the same as normal JCL. See the \$SCAN and \$SCANTAB macros for additional information.
  - Use the RCARDSCN service and \$STMTTAB macro to parse the operands with standard JCL rules. This is the service used by JES2 input processing to parse the statement buffer. However, the RCARDSCN service only parses the operands and calls a processing routine to do all the conversions and storing of data. Conversion of data to binary to store into data areas is the responsibility of the processing routines. See the \$STMTTAB macro for more information.
8. To entirely replace standard JES2 control card processing (HASPRCCS) for a particular JES2 control statement, write your routine as a replacement version of the standard HASPRCCS routine; then pass a return code of 8 back to JES2 to suppress standard processing. Note that your routine becomes responsible for duplicating any HASPRCCS function you want to retain. If you merely want to supplement standard HASPRCCS processing, you can write your exit routine to perform the additional function and then, by passing a return code of 0 or 4, direct JES2 to execute the standard HASPRCCS routine.
9. To nullify a JES2 control statement, pass a return code of 8 to JES2 without using your exit routine to perform the function requested by the statement. Note that, based on what appears in the JCL images output data set, the user is not informed that the statement was nullified.
10. To modify a JES2 control statement, also use return code 8. Place the altered statement in the area pointed to by X004JXWR and set X004XSNC to one. If input processing is successful, the user will see in the output of the JCL images file the original statement, and the altered statement. Note, that if you modify a JES2 control statement and then pass a return code of 0 or 4, JES2 carries out normal input (HASPRCCS) processing, and the modified version of the statement will appear on the user's output in the JCL images file, but the original statement will not appear unless you go directly to output phase (bypassing the converter); then, the user will see the original statement when the JCL data set is printed.
11. Also use return code 8 in processing your own installation-specific JES2 control statements. Write your exit routine to perform the function requested by the statement and then pass return code 8 to JES2 to suppress standard processing and thereby prevent JES2 from detecting the statement as "illegal."
12. **Extending the JCT Control Block**  
 You can use the \$JCTX macro extension service to add, expand, locate, and delete extensions to the job control table (\$JCT) control block from this exit. For example, you can use these extensions to store job/job group-related information. Extensions that are added can be SPOOLed extensions that are available to all exits that read the JCT or local extension that are available only to input processing exits (2, 3, 4, and 20) and the \$QMOD exit (51). The size of SPOOLed extensions is based on the SPOOL buffer size and is less than 3k. You can have up to 8K of local extension regardless of SPOOL buffer size.

## Exit 4

13. To process your own installation-specific JES2 control statement subparameters, you should generally write your exit routine to replace standard HASPRCCS processing entirely. That is, write your exit routine to perform the function(s) requested by the standard parameters and subparameters and those requested by any unique installation-defined subparameters on a statement. Then, from your exit pass a return code of 8 back to JES2. Typically, because the parameters and subparameters on a JES2 control statement are interdependent, you will be limited to this method. However, if you have defined an installation-specific subparameter which can be processed independently of the rest of the control statement on which it appears, you can write your exit routine to process this subparameter alone, delete it, and pass a return code of 0 or 4 to JES2. JES2 can then process the remainder of the statement as a standard JES2 control statement.
14. When passing a return code of 12 or 16, it is also possible for your exit routine to pass an error message to JES2 for display at the operator's console. To send an error message, generate the message text in your exit routine, move it to the area pointed to by X004JXWR, and set the X004XSEM bit in X004RESP to one.
15. If you intend to use this exit to affect the JCT, your exit routine must ensure the existence of the JCT on receiving control. If the JCT has not been created when your exit routine receives control, the pointer to X004JXWR is zero. For example, when your exit routine receives control for a /\*PRIORITY statement, the JCT doesn't exist yet. In this case, your routine must store any data to be placed in the JCT until JES2 creates the JCT.
16. Your exit routine does not have access to the previous control card image. You should take this into account when devising your algorithm.
17. An 80-byte work area, pointed to by X004JXWR, is available for use by your exit routine. If your routine requires additional work space, use the \$GETMAIN macro to obtain storage (and the \$FREMAIN macro to return it to the system when your routine has completed).
18. Exit 4 can use field JCTIPRIO to force a priority for a job subject to the limitations of the input device's priority increment and priority limit values. When exit 4 receives control, a value of C\*' in JCTIPRIO indicates a priority has not been forced by an exit routine. If you want to force a priority in exit 4, set JCTIPRIO to a value between 0 and 15 in the low-order four bits on the field.

**Note:** Whether you may set field JCTIPRIO and the allowable values depend on the specific exit.

19. When this exit adds or modifies cards, whether the change is sent over NJE (including SPOOL offload) depends on the statement type and the setting of option flags in the \$XPL or \$RJCB. Modified JECL cards (original and modified card are both JECL) are not sent over NJE. By default, all other changes are sent over NJE. To limit changes to only the local node, you can set the X004RLOC in the XPL (affects the current card) or set the RJCB3LOC bit in any RJCBs that are added.

---

## Register contents when Exit 4 gets control

The contents of the registers on entry to this exit are:

| Register | Contents |
|----------|----------|
|----------|----------|

- |   |  |
|---|--|
| 0 | Pointer to a parameter list with the following structure, mapped by \$XPL: |
|---|--|



| <b>Field Name</b> | <b>Description</b>   |
|-------------------|--|
| <b>XPLID</b>      | Eyecatcher   |
| <b>XPLLEVEL</b>   | Version level for base XPL   |
| <b>XPLXITID</b>   | Exit ID number   |
| <b>XPLEXLEV</b>   | Version number for exit  |
| <b>X004IND</b>    | Indicator byte   |
| <b>00</b>         | JCL card detected  |
| <b>04</b>         | JECL card detected   |
| <b>X004COND</b>   | Condition byte   |
| <b>X004CONT</b>   | Card is a continuation (not first card of statement)   |
| <b>X004JOBP</b>   | /*JOBPARM card detected  |
| <b>X004CMND</b>   | /*\$ command card detected   |
| <b>X004SEC</b>    | This card has been passed to the exit previously for this job<br>(set if cards added before this card) |
| <b>X004PREJ</b>   | Card encountered outside a job structure   |
| <b>X004RESP</b>   | Response byte  |
| <b>X004XSNC</b>   | Exit supplied next card in X004JXWR  |
| <b>X004XSEM</b>   | Exit supplied error message in X004JXWR  |
| <b>X004JCMT</b>   | Skip processing card   |
| <b>X004KILL</b>   | Kill current job/job group (queue job/job group to<br>OUTPUT processing)                               |
| <b>X004PURG</b>   | Purge current job/job group  |
| <b>X004RLOC</b>   | Changed or added cards are not sent through NJE (set<br>RJCB3LOC in current RJCB)                      |
| <b>XPLSIZE</b>    | Size of parameter list, including base section   |

## Exit 4

- X004CARD**  
80-byte card image address
  - X004FLGX**  
Pointer to exit flags (same as JRWFLAGX)
  - X004JXWR**  
80-byte exit work area address (same as JCTXWRK)
  - X004JCT**  
JCT address
  - X004JQE**  
JQE address
  - X004AREA**  
JRW address
  - X004STMT**  
Concatenated statement buffer. This is all the operands on all continuations cards for this statement
  - X004STME**  
End of statement+1 pointer (in buffer)
  - X004STML**  
Statement label
  - X004STMV**  
Statement verb
  - X004RJCP**  
RJCBs to add before the current JCL/JECL statement
  - X004RJCA**  
RJCBs to add after the current JCL/JECL statement
  - X004RJCC**  
RJCBs to add after the current card
  - X004FLG1**  
Statement flag byte
  - X004LOPR**  
Last operand is on the current card
  - X004QUOT**  
Unfinished quote at end of current card
  - X004CCMT**  
Current card is a continued comment
  - X004LAST**  
Last card in JCL or JECL statement
- 1** Pointer to a 3-word parameter list with the following structure:
- Word 1**  
(+0) address of the control statement image buffer
  - Word 2**  
(+4) address of the exit flag byte, JRWFLAGX, in the \$JRW
  - Word 3**  
(+8) address of the JCTXWRK field in the \$JCT
- 2-10** Not applicable

|    |                    |
|----|--------------------|
| 11 | Address of the HCT |
| 12 | Not applicable     |
| 13 | Address of the PCE |
| 14 | Return address     |
| 15 | Entry address      |

---

## Register contents when Exit 4 passes control back to JES2

Upon return from this exit, the register contents must be:

| Register | Contents       |
|----------|----------------|
| 0-13     | Not applicable |
| 14       | Return address |
| 15       | Return code    |

A return code of:

|    |   |
|----|---|
| 0  | Tells JES2 that if any additional exit routines are associated with this exit, call the next consecutive exit routine. If there are no additional exit routines associated with this exit, perform standard input processing. |
| 4  | Tells JES2 to ignore any other exit routines associated with this exit and to perform standard input processing.  |
| 8  | For JES2 control statements and JCL statements, tells JES2 not to perform standard processing and just write the statement to the JCL data set.   |
| 12 | Tells JES2 to cancel the job/job group because an illegal control statement has been detected; output (the incomplete JCL images listing) is produced.  |
| 16 | Tells JES2 to purge the job/job group because an illegal control statement has been detected; no output is produced.  |

**Note:** For all JES2 control statements preceding the JOB/JOBGROUP card (X004PREJ on), a return code higher than 4 is ignored.

---

## Coded example

Module HASX04A in SYS1.SHASSAMP contains a sample of Exit 4.



---

## Chapter 18. Exit 5: JES2 command preprocessor

---

### Function

This exit allows you to preprocess most JES2 commands. If this exit is implemented and enabled, all but the following commands are available for preprocessing.

- \$Mnn
- \$Nnnnn
- \$P JES2,ABEND,FORCE
- \$T CKPTDEF,RECONFIG=YES
- Monitor commands –
  - \$JD DETAILS
  - \$JD HISTORY
  - \$JD JES
  - \$JD MONITOR
  - \$JD STATUS
  - \$J STOP

You can use your exit routine to perform your own command validation and, based on the checking performed by your validation algorithm, decide whether JES2 should terminate processing for the command or allow normal JES2 command processing to continue. If you use your exit routine to terminate processing for a command, the command subprocessor is bypassed and the requested action is not taken.

This exit also permits you to implement your own installation-specific JES2 command operands and suboperands, and nonstandard JES2 commands unique to your installation. Your exit routine must process nonstandard, installation-specific operands, suboperands, and commands itself, and then suppress standard JES2 command processing. Nonstandard command processing is considered in greater detail in the “Other Programming Considerations” below.

When suppressing standard JES2 command processing, you have the option of directing JES2 to send the standard “OK” return message to the operator, sending your own exit-generated message to the operator, or of suppressing standard JES2 command processing without operator notification.

Macro \$CFSEL can help you process command operand strings.

### **The JES2 command translator migration aid:**

JES2 provided a compatibility and migration aid in the form of an automatically invoked Exit 5 routine in OS/390 Version 2 Release 4 and up. However, this exit 5 command translation routine is no longer automatically loaded and enabled as of z/OS V1R2. The command translation module, HASX05C, is shipped (unchanged) in SYS1.SHASSAMP as of z/OS V1R2.

## Exit 5

IBM suggests that you use the most current command syntax. However, if this is not possible, install the JES2 command translation exit (member HASX05C in SYS1.SHASSAMP). On the next JES2 restart, supply the following initialization statements:

```
LOAD(HASX05C)
EXIT(5) ROUTINES=(HASX5CTR)
```

If additional EXIT(5) statements are found in the initialization stream, they will override this default. To include the translation function in this case, HASX5CTR should be added to the list of routines on the EXIT(5) statement.

The following table lists those commands translated by the exit routine:

*Table 6. Old/New Comparison of JES2 Commands*

| Pre-HJE6604 Format   | Translated Command   |
|--|--|
| \$D'name',...  | \$DJOBQ'name',CMDAUTH=*,...                                  |
| \$T'name',...  | \$TJOBQ'name',...  |
| NOTE: Similar for \$A, \$C, \$E, \$H, \$L, \$O, \$P, \$T, \$TO |  |
| \$DJ1,2,...  | \$DJ(1, 2),...   |
| NOTE: J can be J, JOB, S, STC, T, TSU.                         |  |
| NOTE: Similar for \$a, \$C, \$E, \$H, \$L, \$O, \$P, \$TO      |  |
| \$DJ1-2, J3-4,...  | \$DJ(1-2, 3-4)...  |
| NOTE: Similar for \$A, \$C, \$E, \$H, \$L, \$O, \$P, \$TO      |  |
| \$LJnnn,ALL  | \$DOJnnn   |
| \$LJnnn,H  | \$DOJnnn,HELD  |
| \$LJnnn,READY  | \$DOJnnn,READY   |
| \$LJnnn,OUTGRP=xxx   | \$DOJnnn,OUTGRP=xxx  |
| \$CJnnn,OUTGRP=xxx   | \$COJnnn,OUTGRP=xxx  |
| \$PJnnn,OUTGRP=xxx   | \$POJnnn,OUTGRP=xxx  |
| \$PJnnn,Q=x  | \$POJnnn,Q=x Unless Q= is a valid job queue (XEQ, PPU, etc.) |
| \$vJnnnn,A=   DAYS=   Hours=                                   | \$vJnnnn,A>   Days>   Hours>                                 |
| \$TJnnnn,S=sid1,sid2,...                                       | \$TJnnnn,S=(sid1, sid2,...)                                  |
| \$DSPL,JOBS=nn   | \$DJOBQ,SPOOL=(PERCENT>=nn)                                  |
| \$DSPL,V=xxxxxx, JOBS=nn                                       | \$DJOBQ,SPOOL=(PERCENT>=nn, VOLUME=xxxxxx)                   |
| \$SSPL,V=xxxxxx,...  | \$SSPL(xxxxxx),...   |
| \$vIxx   | \$vI(xx)   |
| \$TIxx,class-list  | \$TI(xx),C=class-list  |
| \$HQ,ALL   | \$TJOBCLASS(*),QHELD=Y                                       |
| \$HQ,C=xyz   | \$TJOBCLASS(x,y,z),QHELD=Y                                   |
| \$AQ,ALL   | \$TJOBCLASS(*),QHELD=N                                       |
| \$AQ,C=xyz   | \$TJOBCLASS(x,y,z),QHELD=N                                   |
| \$PQ,ALL,...   | \$POJOBQ,READY,...   |
| \$PQ,Q=xyz,...   | \$POJOBQ,READY,Q=XYZ,...                                     |

Table 6. Old/New Comparison of JES2 Commands (continued)

| Pre-HJE6604 Format  | Translated Command                 |
|---|------------------------------------|
| \$OQ,ALL,...  | \$OJOBQ,/R=LOCAL.* ,...            |
| \$OQ,Q=xyz,...  | \$OJOBQ,/R=LOCAL.*,/Q=xyz,...      |
| \$TALL,sid1,sid2,...  | \$TJOBQ(*),/S=(sid1),S=(sid2,....) |
| \$LSYS  | \$DMEMBER                          |
| \$ESYS,sid  | \$EMEMBER(sid)                     |
| \$ESYS,RESET=sid  | \$ECKPTLOCK,HELDBY=sid             |
| \$TSYS,IND=Y/N  | \$TMEMBER(local),IND=Y/N           |
| Note: For ease of coding, some commands which work without translation may be translated to an equivalent form. For example, RDJ1 is translated to \$DJ(1). |                                    |

For further information about this pre-R4 to post-R4 migration aid, see the Exit 5 documentation in the *z/OS V2R2 Migration* document for the release that you are migrating from.

---

## Environment

### Task

JES2 main task. You must specify ENVIRON=JES2 on the \$MODULE macro.

### AMODE/RMODE requirements

RMODE ANY, AMODE 31

### Supervisor/problem program

JES2 places Exit 5 in supervisor state and PSW key 1.

### Recovery

\$ESTAE recovery is *not* in effect while an exit routine associated with this exit is being processed. However, you can implement \$ESTAE recovery within your routine. As with all exits, you are responsible for your own recovery within your exit routine, whether you choose to implement \$ESTAE recovery or other recovery procedures.

### Job exit mask

This exit is not subject to job exit mask suppression.

### Mapping macros normally required

\$HASPEQU, \$HCT, \$MIT, \$PCE, \$COMWORK

---

## Point of processing

This exit is taken from the JES2 main task, from the HASPCOME command edit routine of HASPCOMM. The exit point occurs after the command has been edited but before lookup in the command selection tables (COMFASTR and COMTAB), before console authority checking, and before the call to the command subprocessor.

If your exit routine processes the command, the exit routine is responsible for performing any necessary security validation or auditing. Also, if your exit routine sets a return code of 8 or greater, auditing will not occur. If you want to audit commands that your exit routine would fail, you must call SAF in your exit routine to perform the auditing.

---

### Programming considerations

1. For a multiple command, this exit is taken once for each command verb.
2. The same command can be presented to Exit 5 on multiple members of the MAS. If the command is operating on a job executing on a different member than where the command originated, JES2 will send the command to the target system where it will be reissued. Therefore, to distinguish between the original command and a reissued command your exit must check the contents of the COMFLAG3 field of the PCE pointed to by register 13. If the CMB3INTC bit is on, the command is a reissued command.

It is recommended that one member be chosen to process the command, and ignore the command on the other members.

3. To preprocess a standard JES2 command, a typical exit routine would perform some type of validation checking. This validation checking would determine whether JES2 should terminate command processing or allow standard command processing to continue. You can base a validation algorithm on various factors. The fields of the command processor work area of the PCE contain extensive command-related information that can be used in validation checking. Note, however, that even if your exit routine validates a command, it is still possible for JES2 to reject the command based on its standard validation checking.
4. In processing your own installation-specific JES2 commands, your exit routine should perform its own validation checking to replace the functions normally performed by HASPCOME. Your routine should validate the command verb, contained in the COMVERB field of the PCE's command processor work area, with the equivalent of the command table lookup performed by HASPCOME. This check should determine whether the command has a valid installation-specific command verb and what action your exit routine should take based on the verb. Your routine should also perform console authority checking by testing the COMAUTH field, of the PCE's command processor work area, which contains the command's restriction bits. COMAUTH has the following structure:

#### **COMS**

(X'01') when on indicates that the command should be rejected unless authorized for the system.

#### **COMD**

(X'02') when on indicates that the command should be rejected unless authorized for the device.

**COMJ** (X'04') when on indicates that the command should be rejected unless authorized for the job.

#### **COMR**

(X'08') when on indicates that the command should be rejected if it was entered from a remote work station.

If your routine validates the command, it can then perform the requested function, serving as the equivalent to a standard command subprocessor. If, however, your routine determines that the command is not valid, it must terminate processing for the command internally before returning control to



JES2. Then, it should pass a return code (of 8, 12, or 16) to terminate standard HASPCOMM processing, with or without an accompanying message to the operator.

5. When issuing job-related messages, IBM suggests that you have a \$CWTO for a control line if you also specify a console area (L=area). Issue job-related messages independently from any other messages in your exit; do not include JOB= or LAST=. Because JES2 inserts the message identifier and a time stamp, your message should not exceed 16 characters.

There is only one control line for a multi-line WTO, and the remaining lines (referred to as data lines) cannot exceed 70 characters in length.

When you have issued any job-related messages, you can then issue all remaining messages. Structure your logic to reduce dependencies on whether a console area is specified. Use the following guidelines:

- Assume JES2 issues each single-line and multi-line message independently, that is, as if no console area was specified.
  - Code LAST=YES on a \$CWTO for a single-line message. Keep in mind the message isn't really a single line if a console area was specified and JES2 ignores LAST=YES.
  - Code LAST=NO on the first and middle lines and LAST=YES on the last line of multi-line messages.
- If you code JOB=YES on a multi-line message, code it for each line of that message. For a single or multi-line message with JOB=YES, place the 8-character JOBID followed by a blank in the first nine characters of the message text of the first or only message line. If a console area wasn't specified, JES2 removes the JOBID from the message text, shifts the remaining text to the left, and issues a WTO with the specified JOBID. If you are issuing a multi-line message, place nine blanks at the beginning of the text of all subsequent lines.
- Observe the following line length restrictions to reduce dependencies on whether an area was specified:
  - Place only the JOBID and job name on the first line of a job-related, multi-line message and not more than 25 characters on the first line of a non-job-related, multi-line message.
  - If JOB=YES, limit the length of subsequent message lines to 61 characters.
  - If JOB=NO, limit the length of subsequent message lines to 70 characters.

See *z/OS JES2 Macros* for more information about the use of the \$CWTO macro.

6. Typically, to process nonstandard operands and suboperands, you must write your exit routine to replace standard JES2 processing entirely. That is, your exit routine must process both the nonstandard operands or suboperands and the standard portion of the command, by performing the function of the standard command subprocessor. This is typically because the command verb and the accompanying operands and suboperands are interdependent; the operands and suboperands modify the action of the command verb and cannot be processed independently.
7. When passing a return code of 16 and issuing an exit-generated message to the operator, move the text of the message to the COMMAND field of the command processor work area in the PCE. Place the length of the message in R0. Also, be certain to issue the \$STORE (R0) macro after loading the message length in R0 but before issuing the \$RETURN macro because \$RETURN macro destroys the contents on register 0. (When passing a return code of 12, to cause JES2 to issue the standard "OK" return message, you do not have to supply the message length in R0.)

## Exit 5

8. Use the \$CWTO macro instruction in this exit to communicate to the operator. If you use the \$CWTO macro, you must do all the processing required by the specified command within your exit routine and provide a return code indicating that JES2 should bypass any further processing of the specified command.

If the command being processed is a reissued command (the CMB3INTC bit in the COMFLAG3 field of the PCE pointed to by register 13 is on) the message issued by \$CWTO will be displayed in the system log only.

See *z/OS JES2 Macros* for more information about the use of the \$CWTO macro.

9. When this exit routine operates in a networking environment, your exit must check the contents of the COMGFLG1 flag byte of the PCE pointed to by register 13. If the COMG1SSI bit is on, the current command is in subsystem independent format, and registers 5, 6, and 7 do not contain pertinent information. (**Note:** These subsystem-independent commands are also known as formatted commands and can be issued through \$G commands.) The structure of the subsystem-independent commands is located at COSICMDA in the mapping macro \$COMWORK.

---

### Register contents when Exit 5 gets control

The contents of the registers on entry to this exit are:

| Register | Contents                                       |
|----------|--|
| 0-4      | N/A  |
| 5        | Pointer to the address of the current operand* |
| 6        | Increment value of 4*                          |
| 7        | Pointer to the address of the last operand*    |
| 8-10     | N/A  |
| 11       | Address of the HCT                             |
| 12       | N/A  |
| 13       | Address of the HASPCOMM PCE                    |
| 14       | Return address                                 |
| 15       | Entry address                                  |

**Note:** \*See "Programming Considerations" for use of these registers in a networking environment.

---

### Register contents when Exit 5 passes control back to JES2

Upon return from this exit, the register contents must be:

| Register | Contents   |
|----------|--|
| 0        | If an exit-generated message is to be passed, this register contains the length of the message; otherwise, it is not applicable. |
| 1 - 13   | N/A  |
| 14       | Return address   |
| 15       | Return code  |

A return code:

- 0 Tells JES2 that if any additional exit routines are associated with this exit, execute the next consecutive exit routine. If there are no other exit routines associated with this exit, continue with normal command processing.
- 4 Tells JES2 to ignore any other exit routines associated with this exit point and to continue with normal command processing.
- 8 Tells JES2 to terminate standard processing for the command and to issue the \$CRET macro to return control to the main command processor; the command subprocessors are bypassed.
- 12 Tells JES2 to terminate standard processing for the command and to issue the \$CRET macro, specifying the standard \$HASP000 "OK" message, to return control to the main command processor. The "OK" message is issued and the command subprocessors are bypassed.
- 16 Tells JES2 to terminate standard processing for the command and to issue the \$CRET macro, specifying a message generated by your exit routine, to return control to the main command processor. The exit-generated message is issued and the command subprocessors are bypassed.

---

## Coded example

Modules HASX05A and HASX05C in SYS1.SHASSAMP contain examples of Exit 5.



---

## Chapter 19. Exit 6: JES2 converter exit (subtask)

---

### Function

This exit gets control when conversion processing occurs in the JES2 address space. It allows you to provide an exit routine for scanning resolved Converter/Interpreter (C/I) text. If this exit is implemented and enabled, it is taken after the converter has converted each JCL statement into C/I text and once after all of the JCL for a particular job has been converted to C/I text. If you are running conversion in the JES2CI address space (because JOBDEF INTERPRET=JES is set), then exit 60 is taken at the same point in processing as this exit.

You can use your exit routine to:

- Interpret C/I text and, based on this interpretation, decide whether JES2 should either cancel the job at the end of conversion processing or allow it to continue with normal execution.
- Pass messages to the converter that it will write to the JCLMSG data set for the job.
- Modify the C/I text.

After the converter has processed the entire job, this exit again allows you to direct JES2 either to cancel the job or to allow it to continue with normal execution.

C/I text is represented by 'keys' that identify the various JCL parameters. These keys are documented in the JES2 assembly, HASPDOC, which calls macros IEFVKEYS and IEFTXTFT, which are distributed in SYS1.MODGEN. Specifying KEYS on \$MODULE causes IEFVKEYS to be expanded; specifying TEXT on \$MODULE causes IEFTXTFT to be expanded. IEFVKEYS contains the definition of the values for each key, and IEFTXTFT contains the definition of the format of the Converter/Interpreter text. For more information about C/I text, see *z/OS MVS Installation Exits*.

---

### Related exits

Exit 6 only gets control when the converter is called in the JES2 address space. If conversion is being run with the interpreter in the JES2CI address space, use exit 60 to perform the equivalent exit 6 function.

Use exit 44 if you need to alter any fields in the job queue element (\$JQE). Altering fields in the \$JQE in Exit 6 will not be successful because you are in the subtask environment.

---

### Recommendations for implementing Exit 6

It is important to remember that Exit 6 is invoked because either:

- The converter just completed converting a JCL statement to C/I text
- The converter completed processing the entire job.

You could implement Exit 6 to keep certain counters—for instance, the number of DD cards received. Then, when the JCL for the entire job has been processed, the second part of your routine, the part that receives control when the code in R0 is 4

## Exit 6

(or X006IND is set to X006CEND), can determine whether to allow the job to continue based on the contents of these counters.

You should use extreme caution when modifying C/I text. If any of your changes cause a job to fail (because of an interpreter error), there will be no correlation of the error with the resulting abend on the user's output. To modify or examine the C/I text:

- Ensure register 0 contains a X'00' (or X006IND is set to X006TEXT) to indicate the invocation of Exit 6 is to process a converted JCL statement.
- Use any information from the C/I text for any installation-written control blocks.
- Make any necessary modifications to the C/I text. *z/OS MVS Installation Exits* describes the rules for changing C/I text to ensure the changes you make will not cause the other problems in your installation, such as loss of data, loss of integrity and performance.

### Note:

- You can issue messages to the JCLMSG data set to track the changes that you make to the C/I text, because none of your changes will be reflected in the job output. However, the changes you make will be reflected in the job's SWA control blocks.
- The current job class for a job is passed to the exit in XPL field X006JCLS. You can modify this field to alter the job class for the job. Alternately, you can use the JCTJCLAS and JCXJCLA8 fields in the JCT. When conversion and all Exit 6 processing is completed for a job, JES2 uses these fields to update the corresponding JQE fields JQEJCLAS and JQXJCLAS. JES2 also ensures that these changes are checkpointed. Ensure that the specified job class exists to avoid a resulting job failure.
- If you need to change the job priority, use the JCTIPRIO fields in the JCT. When conversion and all Exit 6 processing is completed for a job, JES2 will use this field to update the corresponding JQE field JQEPRIO. JES2 also ensures that these changes are checkpointed.
- The current scheduling environment for a job is passed to the exit in the XPL field X006SCHE. You can modify this field to alter the scheduling environment for the job. Alternatively, you can supply a scheduling environment directly in the JCTSCHEN field in the JCT, which overrides any value that is specified on the job card.

The converter validates the scheduling environment after Exit 6 receives control. If the scheduling environment is not valid, JES2 fails the job with a JCL error. Alternatively, you can update the internal text for the job card to specify a new scheduling environment.

The current hold state of the job is passed to the exit in bit X006HOLD of the XPL. You can modify this bit to alter the current hold status of the job. Alternatively, you can set bit JCTTHOLD in the JCT.

- Set the appropriate return code in register 15 or perform additional processing.

If you decide to fail the job, you should issue error messages to the operator and to the user. You can fail the job in Exit 6 by either:

- Setting flag CNMBFJOB in byte CNMBOPTS of the CNMB. See *z/OS MVS Installation Exits* for information about obtaining and initializing the CNMB. If you set this flag, the converter continues to convert the job's JCL and will fail the job after it has completely processed the job. You can only fail the job in this manner when register 0 contains a X'00'.
- Setting a return code of 8 in register 15 before returning to JES2.

If you want to issue messages to the:

- JCLMSG data set, you must obtain a CNMB and initialize it with the message text. You can not issue any messages to the JCLMSG data set, if this is the last invocation of the exit (register 0 contains a 4). See *z/OS MVS Installation Exits* for additional information about how to initialize the CNMB.
- Operator or user, issue a \$WTO macro.

---

## Environment

The following environment requirements apply to Exit 6.

### Task

JES2 subtask. You must specify ENVIRON=SUBTASK on the \$MODULE or \$ENVIRON macro.

### Restrictions

- Do not attempt to modify checkpointed data from this exit.
- See Appendix A, “JES2 exit usage limitations,” on page 403 for a listing of specific instances when this exit will be invoked or not invoked.
- Exit 6 must be MVS reentrant. See “Reentrant Code Considerations” in Chapter 2 for more information.
- Do not alter any fields in the \$JQE. The changes will not be successful because you are in the subtask environment.
- Do not attempt to control the processing of the MVS converter by changing the C/I text at Exit 6. The converter does not examine the C/I text returned from the exit to determine what changes have been made. For example, you cannot use this exit to execute a procedure other than the one initially named on the EXEC statement, nor can you use this exit to control the printing of JCL statement images by altering the MSGLEVEL parameter on the JOB statement.

### AMODE/RMODE requirements

RMODE ANY, AMODE 31

### Supervisor/problem program

JES2 places Exit 6 in supervisor state and PSW key 1.

### Recovery

ESTAE recovery is in effect. However, no exit routine should depend on JES2 for recovery, because JES2 cannot identify the exact purpose of your exit routine and can therefore provide only minimal recovery. Your exit routine must provide its own recovery; if JES2 recovery is entered, the current job is failed.

### Job exit mask

Exit 6 is subject to suppression. The installation can implement exit 2 to set the 6th bit in the job exit suppression mask (JCTXMASK) or the installation can indicate the exit is disabled in the JES2 initialization stream.

### Storage recommendations

- Private subpool that resides below 16-megabytes
- Word 1 in register 1 (or X006WORK) contains the address of a 16-byte work area

## Mapping macros typically required

\$CIWORK, \$CIPARM, \$DTE, \$DTECNV, \$HASPEQU, \$HCT, \$JCT, \$JCTX, \$MIT, \$XIT, CNMB, KEYS, TEXT

---

## Point of processing

This exit is taken from HOSCNVT, the JCL conversion processor subtask, from within HASCCNVS at the following two times:

1. JES2 first gives your exit control after the converter has successfully converted a complete JCL job into its equivalent C/I text. The exit receives control once for each complete JCL statement unless the converter determines that any JCL statement for this job is in error. A complete JCL statement is considered to be a single JCL statement with all of its continuations. When Exit 6 is invoked, the user's JCL has been merged with the expanded JCL from PROCLIB, and all substitutions for symbolic parameters have been made. Therefore, all of the standard modifications that JES2 will make to the C/I text are complete when the exit receives control.
2. JES2 also gives your exit control after all of the JCL for a particular job has been converted to C/I text even if the converter did detect a JCL statement that was in error. It occurs at the return from the link to the converter, before JES2 creates the scheduler work area (SWA) control blocks. JES2 will not create the scheduler work area (SWA) control blocks until all the JCL for a particular job has been converted to C/I text.

---

## Programming considerations

1. If you suspect that an exit routine associated with this exit is causing a problem, the most expedient method of debugging is to disable the exit to determine whether the problem still occurs when your exit routine is not executed. Then, if the problem seems to be within your exit routine, you can test the routine by turning on the tracing facility.

The trace record serves as a valuable debugging aid because it contains two copies of each C/I text, one before the call to your exit routine and one after the call to your exit routine. However, **do not** turn on tracing in your normal production environment or you will seriously degrade the performance of your system.

2. **Extending the JCT Control Block**

You can use the \$JCTX macro extension service to add, expand, locate, and delete extensions to the job control table (\$JCT) control block from this exit. For example, you can use these extensions to store job-related information.

3. If you need to change the scheduling environment, use the JCTSCHEN field in the JCT.
4. Be sure to take into account when you manage any resources for the exit that the final call to the exit cannot be made if the converter task abends.

---

## Register contents when Exit 6 gets control

The interface to this exit is the same as the interface to exit 60, with the exception of the contents of register 11. The contents of the registers on entry to this exit are:

### Register

#### Contents

- |   |   |
|---|---|
| 0 | A code indicating the status of conversion processing |
|---|---|



- 0 Indicates that a JCL statement has been converted to C/I text.
- 4 Indicates that the converter has completed converting the job to C/I text. This is the final invocation of Exit 6 for the job.
- 1 Address of a 6-word parameter list
- Word 1 (+0)**  
Address of a 16-byte work area available to the installation.
- Word 2 (+4)**  
If the code passed in R0 is:
- 0, this word points to the address of a 8192 (2000 hex) byte buffer that contains the C/I text of the converted JCL statement.
  - 4, this word contains the address of the converter's return code.
- Word 3 (+8)**  
Address of the \$DTE
- Word 4 (+12)**  
Address of the \$JCT
- Word 5 (+16)**  
JES2 sets this to 0 before it passes control to the exit routine.
- Word 6 (+20)**  
Address of the \$CIWORK are for this subtask
- 2 Parameter list address mapped by \$XPL. Register 1 points into this area for compatibility with existing exits that do not understand the \$XPL data structure. The parameter list has the following structure:
- XPLID**  
Eyecatcher ('\$XPL')
- XPLLEVEL**  
Indicates the version number of Exit 6
- XPLXITID**  
Exit identifier - 6
- XPLEXLEV**  
Version level of the exit
- X006IND**  
Indicator byte:
- X006TEXT**  
Internal text exit
- X006CEND**  
End of conversion
- X006COND**  
Condition byte:
- X006TSU**  
Converting a TSO user
- X006STC**  
Converting a started task
- X006JOB**  
Converting a batch job

## Exit 6

### X006RESP

Response byte:

### X006HOLD

Batch job hold indicator. Set on input as the current hold state and can be modified by the exit.

### X006PLUS

Exit 06 parameter list (register 1 points here)

### X006WORK

16 byte work area address

### X006ITXT

Internal text image address (when X006IND = X006TEXT)

### X006CRET

Address of Converter RC (when X006IND = X006CEND)

### X006CNVW

JES2 DTE work area address

### X006JCT

JCT address

### X006CNMB

Address of message buffer

### X006CIW

CIWORK data area address

### X006JCLS

Current job class that is associated with the job. For batch jobs, the exit can update this field to alter the job class that is associated with the job.

### X006SCHE

Current scheduling environment (SCHENV) that is associated with the job. For batch jobs, the exit can update this field to alter the scheduling environment that is associated with the job.

|      |  |
|------|--|
| 3-10 | Not applicable                           |
| 11   | Address of the \$HCT                     |
| 12   | N/A                                      |
| 13   | Address of an 18-word OS-style save area |
| 14   | Return address                           |
| 15   | Entry address                            |

---

## Register contents when Exit 6 passes control back to JES2

Upon return from this exit, the register contents must be:

### Register

#### Contents

|   |                                    |
|---|------------------------------------|
| 0 | Not applicable on return           |
| 1 | Address of a 6-word parameter list |

#### Word 5 (+16)

Address of a CNMB to be processed by the converter. If you want

to pass a message(s) that the C/I will include in the JCLMSG data set for the job, this must contain the address of the CNMB (see *z/OS MVS Data Areas* for information about the IEFCNMB macro).

- 2-13 Not applicable
- 14 Return address
- 15 Return code

A return code of:

- 0 Tells JES2 that if any additional exit routines are associated with this exit, execute the next consecutive exit routine. If there are no more exit routines associated with this exit point, continue with normal JES2 processing. If the exit routine was called when register 0 contains a X'00', normal processing is the conversion of the next JCL statement. If the exit routine was called when register 0 contains a X'04', normal processing is to queue the job for execution.
- 4 Tells JES2 to ignore any additional exit routines associated with this exit for this C/I text and continue with normal processing. If the exit routine was called when register 0 contains a X'00' normal JES2 processing is the conversion of the next JCL statement. If the exit routine was called when register 0 contained a X'04', normal JES2 processing is to queue the job for execution.
- 8 Tells JES2 to bypass execution and cancel the job; the job is queued for output rather than for execution. Conversion will continue until all JCL has been converted.

---

## Coded example

- Module HASX06A contains a sample of Exit 6.
- Module HASX60B contains the same sample exit 60 but also includes two samples of exit 6 that call the common sample of Exit 60:
  1. Routine HASX06B is a sample exit 6 that switches to the user assembly environment and calls the single sample exit 60 routine.
  2. Routine HASX06R is a sample exit 6 that switches to the user assembly environment that uses the \$EXIT facility to invoke all exit 60 routines.
-

## Exit 6

---

## Chapter 20. Exit 7: Control block I/O (JES2)

---

### Function

This exit allows you to provide an exit routine to:

- Receive control whenever control block I/O is performed by the JES2 main task.
- Perform I/O for any installation-specific control blocks you may have created.

This exit uses JES2 main task control block I/O.

---

### Related exits

Whenever control block I/O is performed by a JES2 subtask or by a routine running in the user environment, Exit 8 provides the same function. In the HASPFSSM address space, Exit 25 provides this function.

---

### Recommendations for implementing Exit 7

If you are performing I/O for a \$JCT, then you can use this exit to determine the queue on which a job resides at any point of processing at which JCT I/O is performed for the JES2 main task.

To determine which queue the job is currently on:

1. Ensure the control block is the \$JCT by comparing the value in X007CBID with the characters 'JCT'.
2. Take the offset in the JCTJQE field of the JCT and add the offset to \$JOBQPTR to locate the JQE.
3. Access the JQE and locate the JQETYPE field. JQETYPE can then be tested to determine on which queue, out of ten general queues, the current job resides. The following table lists the ten possible queues along with their corresponding hexadecimal representations in JQETYPE:

**\$XEQ** X'40'

**\$INPUT**  
X'20'

**\$XMIT**  
X'10'

**\$RECEIVE**  
X'04'

**\$OUTPUT**  
X'02'

**\$HARDCOPY**  
X'01'

**\$PURGE**  
X'00'

**\$FREE** X'FF'

**\$SPIN** X'80'

## Exit 7

**Note:** The \$XEQ queue is actually two general queues, the conversion queue (which is X'40') and the execution queues. The class of each execution queue is indicated by the low-order 6 bits. For example, execution class "A" is X'41'. The scheme is similar to the EBCDIC character conversion chart in the *MVS Reference Summary*

---

## Programming considerations

The following are processing considerations for Exit 7:

- Use the PCEID field to determine which processor is reading or writing the JCT; this avoids unnecessary processing.
- You can determine if Exit 7 is being invoked for a transaction program or a batch job by either:
  - Determining if a \$DSCT is contained in the \$IOT.
  - Determining if byte JCTFLAG3 is set to JCT3TPI to indicate the job is a transaction program.
- Bit X007CBIN in the parameter list indicates that the control block contains either an incorrect eyecatcher or job key. When this bit is on, the exit should not rely on the contents of the control block. After the exit returns, JES2 will issue a disastrous error.
- **Extending the JCT Control Block**

If field X007CBID contains the 4-character string 'JCT ' (note the trailing blank), you can add, expand, locate, and remove extensions to the job control table (\$JCT) control block from this exit using the \$JCTX macro extension service for all control block WRITES.

For control block READs you should neither add nor expand extensions, because JES2 might not write any modifications from control block READs to spool. For more information about using the \$JCTX macro extension service, see *z/OS JES2 Macros*.

---

## Point of processing

Exit 7 is taken from the JES2 main task in the HASPNUC module, just after the control block is read from or just before the control block is written out to spool.

---

## Environment

### Task

JES2 main task. You must specify ENVIRON=JES2 on the \$MODULE macro.

### AMODE/RMODE requirements

AMODE 31, RMODE ANY

### Supervisor/problem program

JES2 places Exit 7 in supervisor state and PSW key 1.

### Recovery

No recovery is in effect when this exit is taken. As with every exit, you should provide your own recovery within your exit routine.

## Job exit mask

Exit 7 is subject to suppression. The installation can suppress the exit by either implementing exit 2 to set the 7th bit in the job exit suppression mask (JCTXMASK) or by indicating the exit is disabled in the JES2 initialization stream.

## Mapping macros normally required

\$HASPEQU, \$HCT, \$MIT, \$PCE, \$XPL

---

## Register contents on entry to Exit 7

| Register   | Contents  |            |                                |          |                            |          |                            |          |             |         |                |         |   |  |  |          |                                |          |                            |          |                            |  |   |  |                                     |  |   |
|------------|---|------------|--------------------------------|----------|----------------------------|----------|----------------------------|----------|-------------|---------|----------------|---------|---|--|--|----------|--------------------------------|----------|----------------------------|----------|----------------------------|--|---|--|-------------------------------------|--|---|
| 0          | A pointer to a parameter list with the following structure, mapped by \$XPL:  |            |                                |          |                            |          |                            |          |             |         |                |         |   |  |  |          |                                |          |                            |          |                            |  |   |  |                                     |  |   |
|            | <table> <thead> <tr> <th>Field Name</th> <th>Description</th> </tr> </thead> <tbody> <tr> <td>XPLID</td> <td>The eyecatcher</td> </tr> <tr> <td>XPLLEVEL</td> <td>Maintenance level</td> </tr> <tr> <td>XPLXITID</td> <td>Exit number</td> </tr> <tr> <td>XPLXLEV</td> <td>Version number</td> </tr> <tr> <td>XPLCOND</td> <td>Condition byte JES2 sets the condition byte with one of the following bit settings:</td> </tr> <tr> <td></td> <td> <table> <tbody> <tr> <td>X007CBWR</td> <td>Control block is to be written</td> </tr> <tr> <td>X007CBUN</td> <td>Unknown control block read</td> </tr> <tr> <td>X007CBIN</td> <td>Invalid control block read</td> </tr> </tbody> </table> </td> </tr> <tr> <td></td> <td>X007RESP<br/>Not applicable on entry to Exit 7</td> </tr> <tr> <td></td> <td>XPLSIZE<br/>Length of parameter list</td> </tr> <tr> <td></td> <td>X007CBID<br/>The 4-character EBCDIC control block identifier</td> </tr> </tbody> </table> | Field Name | Description                    | XPLID    | The eyecatcher             | XPLLEVEL | Maintenance level          | XPLXITID | Exit number | XPLXLEV | Version number | XPLCOND | Condition byte JES2 sets the condition byte with one of the following bit settings: |  | <table> <tbody> <tr> <td>X007CBWR</td> <td>Control block is to be written</td> </tr> <tr> <td>X007CBUN</td> <td>Unknown control block read</td> </tr> <tr> <td>X007CBIN</td> <td>Invalid control block read</td> </tr> </tbody> </table> | X007CBWR | Control block is to be written | X007CBUN | Unknown control block read | X007CBIN | Invalid control block read |  | X007RESP<br>Not applicable on entry to Exit 7 |  | XPLSIZE<br>Length of parameter list |  | X007CBID<br>The 4-character EBCDIC control block identifier |
| Field Name | Description   |            |                                |          |                            |          |                            |          |             |         |                |         |   |  |  |          |                                |          |                            |          |                            |  |   |  |                                     |  |   |
| XPLID      | The eyecatcher  |            |                                |          |                            |          |                            |          |             |         |                |         |   |  |  |          |                                |          |                            |          |                            |  |   |  |                                     |  |   |
| XPLLEVEL   | Maintenance level   |            |                                |          |                            |          |                            |          |             |         |                |         |   |  |  |          |                                |          |                            |          |                            |  |   |  |                                     |  |   |
| XPLXITID   | Exit number   |            |                                |          |                            |          |                            |          |             |         |                |         |   |  |  |          |                                |          |                            |          |                            |  |   |  |                                     |  |   |
| XPLXLEV    | Version number  |            |                                |          |                            |          |                            |          |             |         |                |         |   |  |  |          |                                |          |                            |          |                            |  |   |  |                                     |  |   |
| XPLCOND    | Condition byte JES2 sets the condition byte with one of the following bit settings:   |            |                                |          |                            |          |                            |          |             |         |                |         |   |  |  |          |                                |          |                            |          |                            |  |   |  |                                     |  |   |
|            | <table> <tbody> <tr> <td>X007CBWR</td> <td>Control block is to be written</td> </tr> <tr> <td>X007CBUN</td> <td>Unknown control block read</td> </tr> <tr> <td>X007CBIN</td> <td>Invalid control block read</td> </tr> </tbody> </table>  | X007CBWR   | Control block is to be written | X007CBUN | Unknown control block read | X007CBIN | Invalid control block read |          |             |         |                |         |   |  |  |          |                                |          |                            |          |                            |  |   |  |                                     |  |   |
| X007CBWR   | Control block is to be written  |            |                                |          |                            |          |                            |          |             |         |                |         |   |  |  |          |                                |          |                            |          |                            |  |   |  |                                     |  |   |
| X007CBUN   | Unknown control block read  |            |                                |          |                            |          |                            |          |             |         |                |         |   |  |  |          |                                |          |                            |          |                            |  |   |  |                                     |  |   |
| X007CBIN   | Invalid control block read  |            |                                |          |                            |          |                            |          |             |         |                |         |   |  |  |          |                                |          |                            |          |                            |  |   |  |                                     |  |   |
|            | X007RESP<br>Not applicable on entry to Exit 7   |            |                                |          |                            |          |                            |          |             |         |                |         |   |  |  |          |                                |          |                            |          |                            |  |   |  |                                     |  |   |
|            | XPLSIZE<br>Length of parameter list   |            |                                |          |                            |          |                            |          |             |         |                |         |   |  |  |          |                                |          |                            |          |                            |  |   |  |                                     |  |   |
|            | X007CBID<br>The 4-character EBCDIC control block identifier   |            |                                |          |                            |          |                            |          |             |         |                |         |   |  |  |          |                                |          |                            |          |                            |  |   |  |                                     |  |   |
| 1          | Address of the buffer that contains the control block   |            |                                |          |                            |          |                            |          |             |         |                |         |   |  |  |          |                                |          |                            |          |                            |  |   |  |                                     |  |   |
| 2-10       | N/A   |            |                                |          |                            |          |                            |          |             |         |                |         |   |  |  |          |                                |          |                            |          |                            |  |   |  |                                     |  |   |
| 11         | Address of \$HCT  |            |                                |          |                            |          |                            |          |             |         |                |         |   |  |  |          |                                |          |                            |          |                            |  |   |  |                                     |  |   |
| 12         | N/A   |            |                                |          |                            |          |                            |          |             |         |                |         |   |  |  |          |                                |          |                            |          |                            |  |   |  |                                     |  |   |
| 13         | Address of \$PCE  |            |                                |          |                            |          |                            |          |             |         |                |         |   |  |  |          |                                |          |                            |          |                            |  |   |  |                                     |  |   |
| 14         | The return address  |            |                                |          |                            |          |                            |          |             |         |                |         |   |  |  |          |                                |          |                            |          |                            |  |   |  |                                     |  |   |

## Exit 7

15 The entry address

---

### Register contents when Exit 7 passes control back to JES2

#### Register

#### Contents

0 A pointer to a parameter list, mapped by \$XPL:

#### Field Name

#### Description

#### XPLRESP

Response byte. Turn the **X007IOER** bit setting on in the response byte if an I/O error occurred. Upon return to JES2, JES2 will issue message \$HASP096. If there are any other exits associated with this exit, they are ignored, and normal processing continues.

1-13 Unchanged

14 Return address

15 Return code

A return code of:

- 0 Tells JES2 that if any additional exit routines are associated with this exit, call the next consecutive exit routine. If there are no other exit routines associated with this exit, continue with normal processing, which is determined by the particular exit point from which the exit was called.
- 4 Tells JES2 that even if additional exit routines are associated with this exit, ignore them; continue with normal processing, which is determined by the particular exit point from which the exit routine was called.
- 8 Tells JES2 that an I/O error was encountered. Message \$HASP096 is issued. If there are any other exit routines associated with this exit, ignore them; continue with normal processing, which is determined by the particular exit point from which the exit routine was called.

---

### Coded example

Module HASX07A in SYS1.SHASSAMP contains a sample of Exit 7.



---

## Chapter 21. Exit 8: Control block read/write (user, subtask, and FSS)

---

### Function

This exit allows you to provide an exit routine to receive control whenever a JES2 subtask, FSS printer, or a routine running in the user environment performs control block I/O.

You can use this exit to perform I/O for any installation-specific control blocks you may have created.

This exit uses Non-JES2 main task control block I/O.

---

### Related exits

Whenever control block I/O is performed by the JES2 main task, Exit 7 serves the purpose of this exit.

If you intend on updating information for a transaction program, you should consider implementing Exit 31.

---

### Programming considerations

The following are programming considerations for Exit 8:

- You can determine if Exit 8 is being invoked to process a transaction program by either:
    - Determining if a \$DSCT is contained in the \$IOT
    - Determining if byte JCTFLAG3 is set to JCT3TPI
  - If you need to alter information for a transaction program, you should make changes in the \$DSCT rather than the \$JCT. If you update the \$JCT for a transaction program, the updates you make may not be applicable. You should consider implementing exit 31 if you will be updating the \$DSCT for a transaction program.
  - **Extending the JCT Control Block**

If field X008CBID contains the 4-character string 'JCT ' (note the trailing blank), you can locate extensions to the job control table (\$JCT) control block from this exit using the \$JCTXGET macro. For more information about using this service, see *z/OS JES2 Macros*.
- 

### Point of processing

This exit is taken from the user address space (HASCSRDS).

JES2 gives control to your exit routine:

- Before it writes a control block and it writes the \$CHK, \$JCT, \$IOT, \$OCT, or \$SWBIT into storage.
- After it reads a control block and it reads the \$CHK, \$JCT, \$IOT, \$OCT or \$SWBIT into storage.

---

## Environment

### Task

- User address space
- JES2 subtask
- FSS address space using \$CBIO.

You must specify ENVIRON=SUBTASK or ENVIRON=USER on the \$MODULE macro.

### AMODE/RMODE requirements

AMODE 31, RMODE ANY

### Restrictions

Exit 8 must be in common storage

### Recovery

No recovery is in effect when this exit is taken. As with every exit, you should provide your own recovery within your exit routine.

### Job exit mask

Exit 8 is subject to job exit mask suppression unless \$JCT unavailable.

### Mapping macros normally required

\$HASPEQU, \$HCCT, \$JCT, \$JCTX, \$MIT, \$XPL

---

## Register contents on entry to Exit 8

The registers contain the following on entry to Exit 8:

### Register

|            | Contents   |            |             |       |                |          |                   |          |             |         |                |         |   |          |                                |
|------------|--|------------|-------------|-------|----------------|----------|-------------------|----------|-------------|---------|----------------|---------|---|----------|--------------------------------|
| 0          | A pointer to a parameter list with the following structure, mapped by \$XPL:   |            |             |       |                |          |                   |          |             |         |                |         |   |          |                                |
|            | <table> <thead> <tr> <th>Field Name</th> <th>Description</th> </tr> </thead> <tbody> <tr> <td>XPLID</td> <td>The eyecatcher</td> </tr> <tr> <td>XPLLEVEL</td> <td>Maintenance level</td> </tr> <tr> <td>XPLXITID</td> <td>Exit number</td> </tr> <tr> <td>XPLXLEV</td> <td>Version Number</td> </tr> <tr> <td>XPLCOND</td> <td>Condition byte JES2 sets the condition byte with one of the following bit settings:</td> </tr> <tr> <td>X008CBWR</td> <td>Control block is to be written</td> </tr> </tbody> </table> | Field Name | Description | XPLID | The eyecatcher | XPLLEVEL | Maintenance level | XPLXITID | Exit number | XPLXLEV | Version Number | XPLCOND | Condition byte JES2 sets the condition byte with one of the following bit settings: | X008CBWR | Control block is to be written |
| Field Name | Description  |            |             |       |                |          |                   |          |             |         |                |         |   |          |                                |
| XPLID      | The eyecatcher   |            |             |       |                |          |                   |          |             |         |                |         |   |          |                                |
| XPLLEVEL   | Maintenance level  |            |             |       |                |          |                   |          |             |         |                |         |   |          |                                |
| XPLXITID   | Exit number  |            |             |       |                |          |                   |          |             |         |                |         |   |          |                                |
| XPLXLEV    | Version Number   |            |             |       |                |          |                   |          |             |         |                |         |   |          |                                |
| XPLCOND    | Condition byte JES2 sets the condition byte with one of the following bit settings:  |            |             |       |                |          |                   |          |             |         |                |         |   |          |                                |
| X008CBWR   | Control block is to be written   |            |             |       |                |          |                   |          |             |         |                |         |   |          |                                |

|      |                 |   |
|------|-----------------|---|
|      | <b>X008CBUN</b> | Unknown control block read                      |
|      | <b>X008CBIN</b> | Invalid control block read                      |
|      | <b>X008FSSM</b> | CBIO performed by FSSM                          |
|      | <b>XPLRESP</b>  | Response byte                                   |
|      | <b>XPLSIZE</b>  | Length of parameter list                        |
|      | <b>X008CBID</b> | The 4-character EBCDIC control block identifier |
| 1    |                 | Address of the control block                    |
| 2-10 |                 | N/A   |
| 11   |                 | Address of the \$HCCT                           |
| 12   |                 | N/A   |
| 13   |                 | Address of an OS-style save area                |
| 14   |                 | Return address                                  |
| 15   |                 | Entry address                                   |

---

## Register contents on return to JES2

Upon return to JES2, the contents of the registers must be:

### Register

#### Contents

0 A pointer to a parameter list, mapped by \$XPL

#### Field Name

#### Description

#### XPLCOND

Condition byte.

#### X008RESP

Response byte. Turn the **X008IOER** bit setting on in the response byte if an I/O error occurred. After returning to JES2, JES2 issues message \$HASP370. If there are any other exits associated with this exit, they are ignored, and normal processing continues.

1-14 Unchanged

15 Return code

A return code of:

0 Tells JES2 that if any additional exit routines are associated with this exit, call the next consecutive exit routine. If there are no other exit routines associated with this exit, continue with normal processing, which is determined by the particular exit point from which the exit was called.

4 Tells JES2 that even if additional exit routines are associated with

## Exit 8

this exit, ignore them; continue with normal processing, which is determined by the particular exit point from which the exit routine was called.

- 8 Tells JES2 that an I/O error was encountered. Message \$HASP370 is issued. If there are any other exit routines associated with this exit, ignore them; continue with normal processing, which is determined by the particular exit point from which the exit routine was called.

---

### Coded example

Module HASX08A in SYS1.SHASSAMP contains a sample of Exit 8.

---

## Chapter 22. Exit 9: Output excession options

---

### Function

This exit allows you to choose how JES2 will process jobs or transaction programs that have exceeded the estimates for either:

- Output records
- Lines of SYSOUT data
- Pages of SYSOUT data
- Bytes of SYSOUT data

A user submitting a job can specify the estimates on either the JES2 /\*JOBPARM JECL statement or the JOB JCL statement. If a job submitter does not specify the estimates, JES2 obtains the estimates from the ESTLNCT, ESTPUN, ESTPAGE, or ESTBYTE JES2 initialization statements.

Transaction programs obtain the output limits for SYSOUT data sets from TP profiles.

---

### Related exits

JES2 will not invoke Exit 9 for jobs that exceed the OUTLIM specification. You should implement SMF exit IEFUSO - SYSOUT Limit Excession to process any jobs that exceed the OUTLIM specification. See *z/OS MVS Installation Exits* for additional information on SMF exit IEFUSO.

Exit 9 is invoked for a transaction program if your installation has implemented exit 43 to set the excession limits for SYSOUT data set created by a transaction program.

---

### Environment

#### Task

USER task:

- User's address space
- JES2 address space - converter subtask

You must specify ENVIRON=USER on the \$MODULE macro.

#### AMODE/RMODE requirements

RMODE ANY, AMODE 31

#### Supervisor/problem program

JES2 places Exit 9 in supervisor state and PSW key 0.

#### Restrictions

Exit 9 should be in either common storage (CSA) or in the link pack area (LPA).

## Recovery

\$ESTAE is in effect and provides minimal recovery. JES2 will attempt to recover from any program check errors experienced by Exit 9. However, you should not depend on JES2 for recovery and should implement a recovery procedure

## Job exit mask

Exit 9 is subject to suppression.

## Mapping macros normally required

\$HASPEQU, \$HCCT, \$JCT, \$JCTX, \$MIT, \$XPL

---

## Point of processing

From the user's address space, JES2 invokes Exit 9 if the output limits have been exceeded while writing records to a SYSOUT data set. The output limits for a job are specified either in the:

- JES2 initialization stream
- job's JCL or JECL.

---

## Programming considerations

The following are programming considerations for Exit 9:

- You can determine if JES2 invoked Exit 9 to process a transaction program by determining if byte JCTFLAG3 is set to JCT3TPI.
- If exit 9 is processing a multi-transaction program, Exit 9 is invoked for every transaction submitted under the multi-transaction program.
- If Exit 9 is invoked from the JES2 address space, you cannot change the output excession limits for any of the following JES2 system data sets:
  - JES2 job log
  - JES2 messages
  - JES2 images file

JES2 ignores any action taken in Exit 9 for the data sets.

- **Extending the JCT Control Block**

You can add, expand, locate, and remove extensions to the job control table (\$JCT) control block through the \$JCTX macro extension service.

- Exit 9 is entered for each PUT if the limit(s) have been exceeded. Ensure that any increment provided takes this into account.
- Exit 9 is serialized and can be entered as part of WTO processing; therefore, you should ensure any WTO invocation within the exit itself does not use routecode 11 or \$WTO with ROUTE=\$PGINFO.

---

## Register contents on entry to Exit 9

The contents of the registers on entry to this exit are:

### Register

#### Contents

- |   |   |
|---|---|
| 0 | Not used  |
| 1 | Pointer to a 12-byte parameter list with the following structure: |

| Field Name      | Description  |
|-----------------|--|
| <b>XPLID</b>    | Eyecatcher - \$XPL   |
| <b>XPLLEVEL</b> | Version level of \$XPL   |
| <b>XPLXITID</b> | Exit identifier number - 9   |
| <b>XPLEXLEV</b> | Version level of the exit  |
| <b>X009IND</b>  | Indicates the environment from which Exit 9 was invoked. A value of: <ul style="list-style-type: none"> <li>• <b>X009USER</b> indicates which address space invoked Exit 9. See Programming Considerations for additional information.</li> <li>• <b>X009CNCL</b> indicates CANCEL was specified on the job's JOB statement.</li> <li>• <b>X009DUMP</b> indicates DUMP was specified on the job's JOB JCL statement.</li> <li>• <b>X009WARN</b> indicates WARNING was specified on the job's JOB JCL statement.</li> </ul> |
| <b>X009COND</b> | Indicates which SYSOUT limit was exceeded. A value of: <ul style="list-style-type: none"> <li>• <b>X009CEXC</b> indicates the SYSOUT data set exceeded the cards limit.</li> <li>• <b>X009LEXC</b> indicates the SYSOUT data set exceeded the lines limit.</li> <li>• <b>X009PEXC</b> indicates the SYSOUT data set exceeded the pages limit.</li> <li>• <b>X009BEXC</b> indicates the SYSOUT data set exceeded the bytes limit.</li> </ul>  |
| <b>X009RESP</b> | Response byte  |
| <b>X009JCT</b>  | Address of the \$JCT.  |
| <b>X009LVAL</b> | Number of lines specified for the job's output limit.  |
| <b>X009PVAL</b> | Number of pages specified for the job's output limit.  |
| <b>X009BVAL</b> | Number of bytes specified for the jobs output limit.   |
| <b>X009DLIN</b> | The print/punch record count (in packed decimal format) for the job.   |
| <b>X009DPAG</b> | The page count (in packed decimal format) for the job.   |

## Exit 9

### X009DBYT

The byte count (in packed decimal format) for the job.

### XPLSIZE

Length of \$XPL including base section

|      |                        |
|------|------------------------|
| 2-10 | Not applicable         |
| 11   | Address of the \$HCCT  |
| 12   | Not applicable         |
| 13   | Address of a save area |
| 14   | Return address         |
| 15   | Entry address          |

---

## Register contents when Exit 9 passes control back to JES2

Upon return from this exit, the register contents must be:

### Register

#### Contents

|   |                      |
|---|----------------------|
| 0 | Unchanged from entry |
| 1 | Address of \$XPL     |

#### Field Name

#### Description

### XPLID

Eyecatcher - \$XPL

### XPLLEVEL

Version level of \$XPL

### XPLXITID

Exit identifier number - 9

### XPLEXLEV

Version level of the exit

### X009RESP

Indicates processing options for the job. To indicate Exit 9 changed the processing options you must set X009USRB and if you want to:

- Suppress error messages indicating the job has exceeded its specified output limits, you should set X009RESP to X009SDEM.
- Change how JES2 processes a job when a SYSOUT data set created by a job exceeds its output limits. If you want to:
  - Abend the job and produce a dump, set X009RESP to X009XOVR and X009722D.
  - Cancel the job, set X009RESP to X009XOVR and X009722N.
  - Issue a warning message, set X009RESP to X009XOVR.
- Specify new increments for the output limits by setting X009OLIR and increases in one or more of the following:
  - X009RINC
  - X009PINC
  - X009BIN



**XPLSIZE**  
Length of \$XPL including base section

**X009RINC**  
Exit 9's increase for records

**X009PINC**  
Exit 9's increase for pages

**X009BINC**  
Exit 9's increase for bytes

**2-14** Unchanged from entry registers

**15** Return code

A return code of:

**0** Indicates JES2 should continue processing with the next exit routine if one exists.

**4** Indicates JES2 should continue processing but ignore any additional exit routines.

---

## Coded example

Module HASX09B in SYS1.SHASSAMP contains a sample of Exit 9.



---

## Chapter 23. Exit 10: \$WTO screen

---

### Function

This exit allows you to provide an exit routine to receive control every time that JES2 is ready to queue a \$WTO message for transmission. If this exit is implemented and enabled, it receives control for all messages destined for remote stations and for other systems, as well as for all messages with a destination of local.

However, this exit does **not** receive control for messages generated by the subsystem interface or functional subsystem modules.

You can use your exit routine to interrogate the message's console message buffer (CMB) and, based on this interrogation, direct JES2 either to cancel the message or to queue it for normal transmission. You can also use your exit routine to change the text of the message or to alter its console routing.

---

### Environment

#### Task

JES2 main task. You must specify ENVIRON=JES2 on the \$MODULE macro.

#### AMODE/RMODE requirements

RMODE ANY, AMODE 31

#### Supervisor/problem program

JES2 places exit 10 in supervisor state and PSW key 1.

#### Recovery

No recovery is in effect when this exit is taken. As with every exit, you should provide your own recovery within your exit routine.

#### Job exit mask

This exit is not subject to job exit mask suppression.

#### Mapping macros normally required

\$CMB, \$HASPEQU, \$HCT, \$MIT, \$PCE

---

### Point of processing

This exit is taken from the JES2 main task, from the HASPWQUE (special purpose CMB queuing) routine of the HASPCON (console support services) module, for all JES2 main task \$WTO messages. The exit occurs at the beginning of HASPWQUE, after the \$WTOR routine has processed the \$WTO macro and before HASPWQUE queues the CMB containing the message for transmission. If, by passing a return code of 0 or 4, your routine allows the message to continue, control returns to HASPWQUE, which then queues the message for transmission. If, however, your exit routine cancels the message by passing a return code of 8, the transmission

queuing performed by HASPWQUE is bypassed and JES2 gives control to \$FRECMBR, the \$FRECMB service routine.

---

### Programming considerations:

1. This exit is taken only for \$WTOs issued from the JES2 main task.
2. To cancel a message, pass a return code of 8 to JES2. This return code directs JES2 to bypass the HASPWQUE routine, which normally queues the CMB for the console service processor, and to give control directly to the \$FRECMBR routine, which then discards the message by freeing its CMB.
3. To change the text of a message, your routine must access either the CMBTEXT field or the CMBJOB field. If the message does not contain the job's name and number, the message text starts in CMBJOB. The length of the message is always in the CMBML field. Your routine can either retrieve the existing message text and modify it or else generate a completely new message and then write the new or modified message over the original message. **If the new or modified message is longer or shorter than the original message, your routine should alter the CMBML field accordingly.** After altering the text of the message, pass a return code of 0 or 4 to direct JES2 to queue the CMB for transmission. JES2 will then send the new or modified message.

#### CAUTION:

**Altering or deleting an end-line of a multi-line WTO can put JES2 command processing in a Wait State and no more responses to commands will be received.**

4. To alter a message's console routing, your routine should first test the flag byte CMBFLAG to determine whether the CMBFLAGW, CMBFLAGT, and CMBFLAGU flags are off. If these three flags are off, the CMBROUT field contains the MVS console routings. After altering CMBROUT, pass a return code of 0 or 4 to direct JES2 to queue the CMB for transmission. JES2 will base its console routing on the new contents of CMBROUT.
5. If register 0 contains a value of 4 when this exit is invoked, do not take any action that will result in a wait. For example, do not issue a \$WAIT or do not invoke another service, such as \$QSUSE, that might issue a \$WAIT. A \$WAIT can cause problems such as line time-outs or cause JES2 to terminate.

---

### Register contents when Exit 10 gets control

The contents of the registers on entry to this exit are:

| Register | Contents   |
|----------|--|
| 0        | Indicates whether JES2 can tolerate a \$WAIT: <ul style="list-style-type: none"><li>• If register 0 contains a value of 0, JES2 can tolerate a \$WAIT.</li><li>• If register 0 contains a value of 4, JES2 cannot tolerate a \$WAIT.</li></ul> |
| 1        | Address of the \$CMB   |
| 2-10     | N/A  |
| 11       | Address of the \$HCT   |
| 12       | N/A  |
| 13       | Address of the \$PCE   |
| 14       | Return address   |
| 15       | Entry address  |

---

## Register contents when Exit 10 passes control back to JES2

Upon return from this exit, the register contents must be:

| Register | Contents             |
|----------|----------------------|
| 0        | N/A                  |
| 1        | Address of the \$CMB |
| 2-14     | Unchanged            |
| 15       | A return code        |

A return code of:

- |   |  |
|---|--|
| 0 | Tells JES2 that if any more exit routines are associated with this exit, execute the next consecutive exit routine. If there are no more exit routines associated with this exit, continue with normal processing by queuing the CMB for transmission. |
| 4 | Tells JES2 to ignore any additional exit routines associated with this exit and to continue with normal processing by queuing the CMB for transmission.  |
| 8 | Tells JES2 to discard the message by freeing the CMB; the message is not queued for transmission.  |

---

## Coded example

Module HASX10A in SYS1.SHASSAMP contains a sample of exit 10.



---

## Chapter 24. Exit 11: Spool partitioning allocation (\$TRACK)

---

### Function

This exit allows you to provide an exit routine from the JES2 main task that selects the spool volumes from which a job should allocate additional spool space when JES2 determines that additional spool volumes should be added to the available volumes for the job.

Before implementing this exit, you must determine if your installation uses spool partitioning. Your installation uses spool partitioning if FENCE=ACTIVE=YES is specified on the SPOOLDEF initialization statement.

---

### Related exits

If you implement spool partitioning in Exit 11, you must also implement its companion, Exit 12.

The following table identifies the similarities and differences between Exit 11 and Exit 12.

*Table 7. Comparison of Exit 11 and Exit 12*

|                         | Exit 11  | Exit 12  |
|-------------------------|--|--|
| Spool Partitioning Mask | <ul style="list-style-type: none"><li>Initializes and resets bits in the mask.</li><li>Can be used to define spool partitioning for the job.</li></ul> | Can only reset bits in the mask to allow spool space to be allocated from additional spool volumes.        |
| Invoked To              | Allocate spool space for the first time for the job.   | Allocate additional spool space when JES2 determines the spool-allowed mask of the job should be expanded. |

---

### Recommendations for implementing Exit 11

To allow a job or transaction program to allocate spool space from another spool volume:

1. Modifying a 32-byte work area passed in register 1. Each bit in the IOTSAMSK corresponds to a spool volume defined to your installation and represents an entry in the direct access spool data set DSECT (\$DAS). When a bit in the work area is set to:

0 It indicates the spool volume is not currently available to the job and is a candidate for use by Exit 11.

1 It indicates the spool volume is already allocated to the job.

You **must** implement Exit 11 so that it sets at least one additional bit in the work area to allow the job to allocate spool space from at least one additional spool volume. If Exit 11 does not make at least one spool volume available, JES2 will allocate spool space by either:

- Resetting all the bits to ones to allow the job to obtain spool space from any spool volume defined to the system.

## Exit 11

- Resetting a single bit as indicated by the FENCE=ACTIVE=YES parameter on the SPOOLDEF initialization statement.
2. Place a X'08' in register 15 and return to JES2.  
If your routine passes a return code of 8 to JES2 but hasn't actually expanded the mask through the new mask returned in the spool mask work area, JES2 sets the spool partitioning mask as indicated by the FENCE= parameter on the SPOOLDEF initialization statement and to reissue the \$TRACK request.

---

## Environment

### Task

JES2 main task. You must specify ENVIRON=JES2 on the \$MODULE macro.

### AMODE/RMODE requirements

AMODE 31, RMODE ANY

### Supervisor/problem program

Exit 11 is placed in supervisor state and PSW key 1.

### Restrictions

You should **not** change the definition of the spool space from which a multi-transaction program allocates spool space. If you alter the volumes from which the multi-transaction program can allocate spool space, you may experience unpredictable results.

### Recovery

Because Exit 11 is called from every stage in JES2 processing, there are significant variations the recovery environments JES2 provides for Exit 11. For example, when \$TRACK is called from HASPRDR, an error in your exit routine may cause only the current job to fail; however, when \$TRACK is called from HASPNET, an error in your exit routine may cause JES2 itself to fail. As with every exit, your exit routine *should not* depend on JES2 for recovery. JES2 cannot anticipate the exact purpose of your exit routine, and therefore any standard JES2 recovery that happens to be in effect is, typically, minimal. You should provide your own recovery within your exit routine.

### Job exit mask

Exit 11 is subject to suppression. Exit 11 can be suppressed by either implementing exit 2 to set the 11th bit in the exit suppression mask (JCTXMASK) or by disabling the exit in the JES2 initialization stream.

### Mapping macros normally required

\$BUFFER, \$DAS, \$HASPEQU, \$HCCT, \$HCT, \$IOT, \$JCT, \$JCTX, \$MIT, \$PCE, \$SCAT, \$TAB, \$XECB, RPL

---

## Point of processing

This exit is taken from the JES2 main task, from the \$TRACK subroutine in HASPTRAK, when JES2 determines that the spools allowed mask for the job (IOTSAMSK) needs to be updated. The spools allowed mask will be updated in two different situations:



- The job is using the maximum number of volumes (\$FNCCNT in HCT) and there is no space available for allocation (that is, the volume is full, the volume is not available for allocation or the volume does not have affinity for the system) on the spool volumes from which the job is permitted to allocate space.
- The job is not yet using the maximum number of spool volumes (SPOOLDEF FENCE=VOLUMES=nnnn) regardless of whether there is space available on the spool volumes from which the job is permitted to allocate space.

Exit 11 is not invoked if any of the following are true:

- The job is permitted to allocate space from any spool volume, that is, the spool partitioning mask (IOTSAMSK/JCTSAMSK) for the job is set to all ones (X'FF').
- Spool partitioning is in effect, the job is using the maximum number of spool volumes and space is available on those spool volumes.

Initially when a job or transaction program is started, JES2:

1. Sets the JCTSAMSK to all zeros to prohibit the job from allocating space from any spool volume
2. Determines if you have implemented spool partitioning. If you have not implemented Exit 2, Exit 11, or Exit 12 and have specified the FENCE=ACTIVE=NO parameter on the SPOOLDEF initialization statement, JES2 automatically sets JCTSAMSK to all ones so that the job can allocate spool space from any spool volume.

---

## Programming considerations

The following are programming considerations for Exit 11:

- If you intend to base your allocation algorithm on values contained in fields of the \$JCT, you must consider that the \$JCT is sometimes unavailable and write a section of your exit routine to take control in these instances.
- **Locating JCT Control Block Extensions**  
You can locate extensions to the job control table (\$JCT) control block from this exit using the \$JCTXGET macro.
- You can determine if a job or transaction program is requesting additional spool space by either:
  - Determining if a \$DSCT is contained in the \$IOT
  - Determining if byte JCTFLAG3 is set to JCT3TPI.
- Determining whether a job is at its fencing limit or not
  - Spool partitioning is active if \$MVFENCE is on.
  - The field \$FNCCNT contains the fencing limit (SPOOLDEF FENCE=VOLUMES=nnnn).
  - CCTSPLAF contains the mask of spool volumes with affinity for this member.
  - Only count the volumes that have affinity for this member and are in the IOT spools allowed mask when checking to see if the job has reached the fencing limit. To do this, 'and' CCTSPLAF with IOTSAMSK and then use the \$CNTBIT macro to obtain the number of volumes to compare with \$FNCCNT. The number of bits on in IOTSAMSK may be equal to or exceed \$FNCCNT and another volume should still be added if the job obtained some of its spool space on another member which has affinity to different spool volumes.

## Exit 11

- CCTVBLOB is the mask of spool volumes with space in the BLOB. Adding a spool volume that is not in CCTVBLOB will do no good since there is no space for it in the BLOB and therefore the job will not be able to allocate space on the volume.

---

### Register contents when Exit 11 gets control

| Register | Contents  |
|----------|---|
| 0        | Not applicable  |
| 1        | Address of the 3-word parameter list, having the following structure:<br><b>word 1 (+0)</b><br>Address of \$IOT.<br><b>word 2 (+4)</b><br>Address of \$JCT (if available); otherwise 0. For example, the \$JCT is unavailable when JES2 is acquiring: <ul style="list-style-type: none"><li>• Space for the spooled remote messages or multi-access spool messages.</li><li>• A record for the \$IOT for the JESNEWS data set.</li></ul> <b>word 3 (+8)</b><br>Address of a 32-byte spool partitioning mask work area which is copied from the IOTSAMSK field in the \$IOT. |
| 2-10     | Not applicable  |
| 11       | Address of \$HCT  |
| 12       | N/A   |
| 13       | Address of \$PCE  |
| 14       | Return address  |
| 15       | Entry address   |

---

### Register contents when Exit 11 passes control back to JES2

Before returning to JES2, the contents of the registers must be:

| Registers | Contents       |
|-----------|----------------|
| 0-13      | Unchanged      |
| 14        | Return address |
| 15        | Return code    |

A return code of:

- |   |   |
|---|---|
| 0 | Tells JES2 that if any additional exit routines are associated with this exit, execute the next consecutive exit routine. If there are no additional exit routines associated with this exit point, this return code tells JES2 to set the spool partitioning mask as indicated by the FENCE parameter on the SPOOLDEF initialization statement setting and to reissue the \$TRACK request. |
| 4 | Tells JES2 that even if additional exit routines are associated with this exit,   |

ignore them; instead, set the spool partitioning mask as indicated by the FENCE parameter on the SPOOLDEF initialization statement setting and reissue the \$TRACK request.

- 8 Tells JES2 that an updated version of the spool partitioning mask—with at least one additional bit turned on—has been passed to JES2 in the spool mask work area and will now determine later spool allocation. It also tells JES2 to reissue the \$TRACK request.

---

## Coded example

None provided.



---

## Chapter 25. Exit 12: Spool partitioning allocation (\$STRAK)

---

### Function

This exit allows you to provide an exit routine from a users address space or JES2 subtask that selects the spool volumes that a job or transaction program should allocate additional spool space from when JES2 determines that additional spool volumes should be added to the available volumes for the job.

Before implementing this exit, you must determine if your installation uses spool partitioning. Your installation uses spool partitioning if FENCE=ACTIVE=YES is specified on the SPOOLDEF initialization statement.

---

### Related exits

If you implement spool partitioning in Exit 12, you must also implement its companion, Exit 11.

The following table identifies the similarities and differences between Exit 12 and Exit 11.

*Table 8. Comparison of Exit 12 and Exit 11*

|                         | Exit 12  | Exit 11  |
|-------------------------|--|--|
| Spool Partitioning Mask | Can only reset bits in the mask to allow spool space to be allocated from additional spool volumes.        | <ul style="list-style-type: none"><li>• Initializes and resets bits in the mask.</li><li>• Can be used to define spool partitioning for the job.</li></ul> |
| Invoked To              | Allocate additional spool space when JES2 determines the spool-allowed mask of the job should be expanded. | Allocate spool space for the first time for the job.   |

---

### Recommendations for implementing Exit 12

To allow a job or transaction program to allocate spool space from another spool volume:

1. Modifying a 32-byte work area passed in register 1. The first \$SPOLNUM bits in the IOTSAMSK correspond to the number of spool volumes defined to your installation. Each bit represents an entry in the direct access spool data set dsect (\$DAS). When a bit in the work area is set to:

**0** It indicates the spool volume is not currently available to the job and is a candidate for use by Exit 12.

**1** It indicates the spool volume is already allocated to the job.

You **must** implement Exit 12 so that it sets at least one bit in the work area to allow the job to allocate spool space from at least one additional spool volume. If Exit 12 does not make at least one spool volume available, JES2 will allocate spool space by either:

- Resetting all the bits to ones to allow the job to obtain spool space from any spool volume defined to the system.

## Exit 12

- Resetting a single bit as indicated by the FENCE=ACTIVE=YES parameter on the SPOOLDEF initialization statement.
2. Place a X'08' in register 15 and return to JES2.  
If your routine passes a return code of 8 to JES2 but hasn't actually expanded the mask through the new mask returned in the spool mask work area, JES2 sets the spool partitioning mask as indicated by the FENCE= parameter on the SPOOLDEF initialization statement and to reissue the \$STRAK request.

---

## Environment

### Task

USER task:

- Users address space
- JES2 subtask

You must specify ENVIRON=USER on the \$MODULE macro.

### AMODE/RMODE requirements

AMODE 31, RMODE ANY

### Supervisor/problem program

JES2 places Exit 12 in supervisor state and PSW key:

**Environment**

**Key**

User 0

**Subtask**

1

### Restrictions

You should **not** change the definition of the spool space from which a multi-transaction program allocates spool space. If you alter the volumes from which the multi-transaction program can allocate spool space, you may experience unpredictable results.

### Recovery

Because Exit 12 is called from every stage in JES2 processing, there are significant variations the recovery environments JES2 provides for Exit 12. For example, when \$STRAK is called from HASPRDR, an error in your exit routine may cause only the current job to fail; however, when \$STRAK is called from HASPNET, an error in your exit routine may cause JES2 itself to fail. As with every exit, your exit routine *should not* depend on JES2 for recovery. JES2 cannot anticipate the exact purpose of your exit routine, and therefore any standard JES2 recovery that happens to be in effect is, typically, minimal. You should provide your own recovery within your exit routine.

### Job exit mask

Exit 12 is subject to suppression. You can suppress Exit 12 by either implementing exit 2 to turn off the 12th bit in the job exit suppression mask (JCTXMASK) or you can disable the exit suppressed.

## Mapping macros normally required

\$BUFFER, \$DAS, \$HASPEQU, \$HCCT, \$HCT, \$IOT, \$JCT, \$JCTX, \$MIT, \$PCE, \$SCAT, \$TAB, \$XECB, RPL

---

### Point of processing

This exit is taken from the \$STRAK subroutine when JES2 determines that the spools allowed mask for the job (IOTSAMSK) needs to be updated. The spools allowed mask will be updated in two different situations:

- The job is using the maximum number of volumes (CCTFNCNT in HCCT) and there is no space available for allocation (that is, the volume is full, the volume is not available for allocation or the volume does not have affinity for the system) on the spool volumes from which the job is permitted to allocate space.
- The job is not yet using the maximum number of spool volumes (SPOOLDEF FENCE=VOLUMES=nnnn) regardless of whether there is space available on the spool volumes from which the job is permitted to allocate space.

This exit will not be invoked if any of the following are true:

- The job is permitted to allocate space from any spool volume, that is, the spool partitioning mask (IOTSAMSK) for the job is set to all ones (X'FF').
- Spool partitioning is in effect, the job is using the maximum number of spool volumes and space is available on those spool volumes.

---

### Programming considerations

The following are programming considerations for Exit 12:

- If you intend to base your allocation algorithm on values contained in fields of the \$JCT, you must consider that the \$JCT is sometimes unavailable and write a section of your exit routine to take control in these instances.
- **Locating JCT Control Block Extensions**  
You can locate extensions to the job control table (\$JCT) control block from this exit using the \$JCTXGET macro.
- You can determine if a job or transaction program is requesting additional spool space by either:
  - Determining if a \$DSCT is contained in the \$IOT
  - Determining if byte JCTFLAG3 is set to JCT3TPI
- Determining whether a job is at its fencing limit.
  - Spool partitioning is active if CCTSMVFN is on.
  - The field CCTFNCNT contains the fencing limit (SPOOLDEF FENCE=VOLUMES=nnnn).
  - CCTSPLAF contains the mask of spool volumes with affinity for this member.
  - Only count the volumes that have affinity for this member and are in the IOT spools allowed mask when checking to see if the job has reached the fencing limit. To do this, 'and' CCTSPLAF with IOTSAMSK and then use the \$CNTBIT macro to obtain the number of volumes to compare with CCTFNCNT. The number of bits on in IOTSAMSK may be equal or exceed CCTFNCNT and another volume should still be added if the job obtained some of its spool space on another member which has affinity to different spool volumes.

## Exit 12

- CCTVBLOB is the mask of spool volumes with space in the BLOB. Adding a spool volume that is not in CCTVBLOB will do no good since there is no space for it in the BLOB and therefore the job will not be able to allocate space on the volume.

---

### Register contents when Exit 12 gets control

| Register | Contents   |
|----------|--|
| 0        | Return Code:<br><b>RC = 0</b><br>Invoked from user address space.<br><b>RC = 1</b><br>Invoked by jes2 converter subtask.<br><b>RC = 2</b><br>Invoked by JES2 subtask.  |
| 1        | Address of the 3-word parameter list, having the following structure:<br><b>word 1 (+0)</b><br>Address of \$IOT<br><b>word 2 (+4)</b><br>Address of \$JCT (if available); otherwise 0 For example, the \$JCT is unavailable when JES2 is acquiring: <ul style="list-style-type: none"><li>• Space for the spooled remote messages or multi-access spool messages</li><li>• A record for the \$IOT for the JESNEWS data set.</li></ul> <b>word 3 (+8)</b><br>Address of a 32-byte spool partitioning mask work area which is copied from the IOTSAMSK field in the \$IOT. |
| 2-9      | Not applicable   |
| 10       | Address of SJB/SJIOB.  |
| 11       | Address of \$HCCT.   |
| 12       | N/A  |
| 13       | Address of \$PCE   |
| 14       | Return address   |
| 15       | Entry address  |

---

### Register contents when Exit 12 passes control back to JES2

Before returning to JES2, the contents of the registers must be:

| Registers | Contents       |
|-----------|----------------|
| 0-13      | Unchanged      |
| 14        | Return address |
| 15        | Return code    |

A return code of:



- 0 Tells JES2 that if any additional exit routines are associated with this exit, execute the next consecutive exit routine. If there are no additional exit routines associated with this exit point, this return code tells JES2 to set the spool partitioning mask as indicated by the FENCE parameter on the SPOOLDEF initialization statement setting and to reissue the \$STRAK request.
- 4 Tells JES2 that even if additional exit routines are associated with this exit, ignore them; instead, set the spool partitioning mask as indicated by the FENCE parameter on the SPOOLDEF initialization statement setting and reissue the \$STRAK request.
- 8 Tells JES2 that an updated version of the spool partitioning mask—with at least one additional bit turned on—has been passed to JES2 in the spool mask work area and will now determine later spool allocation. It also tells JES2 to reissue the \$STRAK request.

---

**Coded example**

None provided.



---

## Chapter 26. Exit 14: Job queue work select – \$QGET

---

### Function

This exit allows you to provide an exit routine that incorporates your own search algorithms for finding work on the job queue. You use your exit routine to search for an appropriate JQE on the job queue and to indicate when normal JES2 JQE processing should resume.

#### Note:

This exit is **not** called for workload management (WLM) initiator work selection; rather, you must use Exit 49 for that purpose. Also, you will find it easier to implement because it does not require that you copy JES2 decision-making algorithms into your exit routine. See Chapter 61, “Exit 49: Job queue work select - QGOT,” on page 319.

---

### Environment

#### Task

JES2 main task. You must specify ENVIRON=JES2 on the \$MODULE macro.

This exit is associated with the \$QGET routine, in HASPJQS, which is entered to acquire control of a job queue element (JQE).

The \$QGET routine scans the appropriate queue for an element that:

- is not held
- is not already acquired by a previous request to the job queue service routines
- has affinity to the selecting JES2 member
- has independent mode set in agreement with the current mode of the selecting member.

#### AMODE/RMODE requirements

RMODE ANY, AMODE 31

#### Supervisor/problem program

JES2 places Exit 14 in supervisor state and PSW key 1.

#### Recovery

No recovery is in effect when this exit is taken. As with every exit, you should provide your own recovery within your exit routine.

#### Job exit mask

This exit is not subject to job exit mask suppression.

#### Mapping macros normally required

\$HASPEQU, \$HCT, \$JQE, \$MIT, \$PCE

## Point of processing

This exit is taken from the JES2 main task, from the \$QGET routine of HASPJQS, after \$QGET first obtains control of the shared queues and verifies that the member is not draining but before it selects a JQE from the appropriate queue.

## Programming considerations

You must adhere to the following programming considerations:

- The \$QSUSE control of the checkpoint record is not maintained if your exit routine issues a \$WAIT or invokes a service that issues a \$WAIT. You should ensure in your exit routine that you retain control of the checkpoint record before returning to JES2.
- You must ensure that the spool volumes, where this job allocated space, are online. Also, the JQE cannot be busy, held, or on an inappropriate queue (such as the hardcopy queue).

```
LH R15,$JQEMSKL      Get JQE spool
EX R15,EXJQEMVC      Get spools used by this job
NC $SPMSKWA,$SPLSLCT 'AND' with qualifying spools
EX R15,EXJQECLC      If all spool volumes are not
BNE NEXTJQE          available, get next job
```

- Ensure the job affinity will allow the routine to run on this member.

```
$SETAFF REQUEST=TEST,      Test for our affinity
        AFFIELD=JQESAF,      in the JQE to
        AFTOKEN=$AFFINTY,     see if we can run it.
        REGAREA=$GENWORK,
        FAIL=NEXTJOB          No, go find next job
```

- Ensure the job's independent mode status matches the member status. If the member is in independent mode then the job must be in independent mode.

```
TM $STATUS,$INDMODE      Is this member in independent mode?
BO EXIND                  Yes, make sure job is too
TM JQEFLAG2,JQE2IND      Is job in independent mode?
BO NEXTJQE                Yes, get next job
B EXAFF                   No, check affinity
```

```
EXIND TM JQEFLAG2,JQE2IND Is job in independent mode?
BZ NEXTJQE                No, get next job
```

- Ensure that if the job has a scheduling environment, that it is available on this member.

```
TM JQASCHE,FF-C' '       Scheduling environment?
JZ EXSCHE                 No, select the job
$SETAFF REQUEST=TEST,      Test for availability
        AFFIELD=JQASCHAF,      in the JQE to
        AFTOKEN=$AFFINTY,     see if we can run it.
        FAIL=NEXTJQE          No, get next job
```

- Ensure that the JQE1ARMH flag is not on. If JQE1ARMH is on, the job has ended execution and is awaiting a possible restart by the automatic restart manager; the job cannot be selected.

```
TM JQETYPE,$XEQ          If job is on execution
BNO QGTCONTA              queue and is held for
TM JQEFLAG7,JQE7SPIN      spin processing in CSA
BO QNEXT                  bypass the job
TM JQEFLAG1,JQE1ARMH      Job held for ARM restart?
BO QNEXT                  Yes, get next JQE
```

- The address returned in the QGET parameter list must be the address of a JQA in update mode. That is, it must have been retrieved through \$DOGJQE

ACTION=(FETCH,UPDATE), \$DOGJQE ACTION=(FETCHNEXT,UPDATE), or at some point changed from read mode to update mode through \$DOGJQE ACTION=(SETACCESS,UPDATE).

- If you use Exit 14 to replace the normal JES2 job selection for execution or conversion and intend to use SECLABEL by system, then your exit routine must take into account the new SECLABEL affinity field in selecting an eligible job to run. If the RACF<sup>®</sup> SETROPT option for SECLABEL by system is active, then JES2 honors any SECLABEL system affinity restrictions when selecting a job. A new field, JQASCLAF, contains an affinity mask of JES2 MAS members where the SECLABEL is available. SECLABEL affinity applies only to selection of job for conversion and execution.

```

TM   JQEFLAG3,JQE3JOB   JQE a TSU or STC?
JM   EXSLBL             Yes, bypass SECLABEL aff
L    R14,CVTPTR(,0)     Get CVT address
ICM  R14,B'1111',CVTRAC-CVT(R14) Get RACF CVT addr
JZ   EXSLBL             None, skip next
TM   RCVTML2F-RCVT(R14),RCVTSBYS SECLABEL by sys?
JNO  EXSLBL             No, skip SECLABEL aff
SPACE 1
$SETAFF REQUEST=TEST,      Test if SECLABEL
        AFFIELD=JQASCLAF,  is active on
        AFTOKEN=$AFFINTY,  this member?
        FAIL=NEXTJQE       No, get next job

```

- Exit 14 can perform duplicate job name check and instruct JES2 to bypass the normal duplicate job checks it would perform. You can also use the exit to allow a duplicate jobname to execute under certain situations. Setting QGTFNDUP causes JES2 checking for selected job to be bypassed.
- In Exit 14, JES2 sets the QGTFNOPT bit to NO by default and the exit-specified selection criteria is used. If you want to use the class optimization as your selection criteria, turn off the QGTFNOPT bit.
- JES2 is designed to prohibit the execution of multiple JOBS with the same name, with the exception of TSUs and STCs. A callable routine can be used to determine if the name of a candidate job is a duplicate of an executing job.

Exit 14 programming should be sensitive to duplicate jobnames. You can use any of the following three methods to meet this requirement. Each method assumes that the exit routine uses \$QGET mapping to access the parameter list provided to the exit:

- \$CALL XDUPTEST,PARM=jqe/jqa address

This method uses XDUPTEST return codes to indicate whether the specified jobname is a duplicate of an executing jobname. RC=0 indicates it is not a duplicate; RC=4 indicates it is a duplicate.

If the job is a duplicate, the exit routine can reject the job and then resume the search for a suitable job.

If the job is not a duplicate, Exit 14 can select the job and set flag QGTFNDUP in byte QGTFRESP to indicate to JES2 processing that duplicate jobname processing has completed and found no duplicates.

The following example code runs this method:

```

$CALL  XDUPTEST,PARM=JQE,      See if duplicate jobname C
        ERRET=BADJOB
        OI  QGTFRESP,QGTFNDUP  Tell JES2 duplicate test done
        J   GOODJOB            Finished, return
BADJOB DS  0H                  Job is no good, select new C job

```

## Exit 14

Use this method as the final process in determining a job's eligibility to avoid the following occurrence; if a job is rejected after calling XDUPTEST, XDUPTEST processing must then be countered by running \$CALL NQRELSE,PARM=jqe/jqa.

- Do not perform any duplicate jobname processing – by not calling XDUPTEST, and by not setting the flag QGTFNDUP in byte QGTFRESP.

Using this method, JES2 performs the duplicate jobname processing. If the jobname is a duplicate, the JQA is returned (\$DOJQE ACTION=RETURN), the job is rejected and Exit 14 is called again.

When Exit 14 is called again, it must examine field QGTJQE. If the field is nonzero, scanning for a job must resume with the JQE that is next in the queue.

If Exit 14 returns a JQE that fails duplicate jobname processing because the same job was returned by the previous Exit 14 call (the prior call during the same QGET), \$ERROR QG3 is returned.

- Do not perform any duplicate jobname processing – by not calling XDUPTEST, but by setting the flag QGTFNDUP in byte QGTFRESP.

Using this method, no duplicate jobname processing is performed by JES2. The job will be selected with no further checks.

---

## Register contents when Exit 14 gets control

The contents of the registers on entry to this exit are:

### Register

#### Contents

|      |  |
|------|--|
| 0    | Not applicable   |
| 1    | Pointer to a QGET parameter list having the following structure: <ul style="list-style-type: none"><li><b>+0 (word 1)</b><br/>Address of the node table</li><li><b>+4 (word 2)</b><br/>Address of control block<ul style="list-style-type: none"><li>• PIT – if INWS</li><li>• DCT – if OJTWS or OJTWSC</li></ul></li><li><b>+8 (word 3)</b><br/>Address of class list (if applicable)</li><li><b>+12 (word 4)</b><br/>Address of the JQE</li><li><b>+16 (word 5)</b><br/>each byte is set as follows:<ul style="list-style-type: none"><li><b>+16</b> Length of the class list</li><li><b>+17</b> Queue type (see the \$QGET macro description for a list of these) This byte is set to '00' for queue types INWS, OJTWSC, and OJTWS. Byte 18 (the type flag) is used to differentiate between these three queue types.</li><li><b>+18</b> Work selection type flag</li><li><b>+19</b> This byte is not part of the interface</li></ul></li></ul> |
| 2-10 | Not applicable   |

|    |                    |
|----|--------------------|
| 11 | Address of the HCT |
| 12 | Not applicable     |
| 13 | Address of the PCE |
| 14 | The return address |
| 15 | The entry address  |

---

## Register contents when Exit 14 passes control back to JES2

Upon return from this exit, the register contents must be:

### Register

#### Contents

|              |   |
|--------------|---|
| 0            | Not applicable  |
| 1            | Address of a QGET parameter list having the following structure:  |
| +0 (word 1)  | Address of the node table   |
| +4 (word 2)  | Address of the control block  |
| +8           | Address of the class list   |
| +12 (word 4) | Address of the JQE  |
| +16 (word 5) | each byte is set as follows:  |
| +16          | Length of the class list  |
| +17          | Queue type (see the \$QGET macro description for a list of these) This byte is set to '00' for queue types INWS, OJTWSC, and OJTWS. Byte 18 (the type flag) is used to differentiate between these three queue types. |
| +18          | Work selection type flag  |
| +19          | Response byte flags: X'80' - Initiator class list optimization not allowed  |
| 2-14         | Not applicable  |
| 15           | A return code   |

A return code of:

|    |  |
|----|--|
| 0  | Tells JES2 that if any additional exit routines are associated with this exit, call the next consecutive exit routine. If there are no additional exit routines associated with this exit continue normal queue scan processing.                         |
| 4  | Tells JES2 to ignore any other exit routines associated with this exit and to continue normal queue scan processing.   |
| 8  | Tells JES2 to bypass normal queue scan processing because a JQE was found by the exit routine. The address of the JQE the exit routine found is provided in the fourth word of the QGET parameter list (the address of which is returned in register 1). |
| 12 | Tells JES2 to bypass normal processing because a JQE was not found.  |

---

**Coded example**

None provided.



---

## Chapter 27. Exit 15: Output data set/copy select

---

### Function

JES2 calls Exit 15 twice to allow you to instruct JES2 to:

- **First:** Change the number of copies of the output data set or bypass processing the current data set when JES2 first selects that data set for output processing
- **Second:** Print (or not print) a data set separator page for each copy of the output data set.

The data set separator page exit point allows the exit routine to place a separator page between data sets. This is similar to the function provided by Exit 1, the separator page exit. See *z/OS JES2 Initialization and Tuning Guide* for a sample standard separator page. If your security policy requires it, use this exit to create headers that include the security label for each output data set for JES2 managed printers.

You could also use your exit routine to reset the addresses of the PRTRANS table and the CCW translate tables. The parameter list passed to your exit routine contains the default addresses for both the PRTRANS table and the CCW translate tables. Change the defaults by changing the parameter list to point to your own PRTRANS table and to point to your own CCW command code translate tables.

When translation is to occur for a local 1403 or a remote printer, the PRTRANS table translates user data and changes each line to be printed. The default PRTRANS table changes lowercase letters to uppercase and any characters that are invalid on a specific universal character set (UCS) to blanks. To determine if translation will occur, see item 9 on page 170

The CCW table translates user-specified channel commands into installation-defined channel commands.

#### CAUTION:

**Translation of initialization, diagnostic, or control CCWs may cause unpredictable results.**

---

### Programming considerations

1. Change the following information by changing the values in the parameter list:
  - a. Copies to be printed (255 maximum)
  - b. Pointer to translate table
  - c. CCW translate table
2. Do not produce separator pages if JES2 called this exit for data set select, because printer setup processing has not occurred yet.
3. To determine if Exit 15 is to produce a data set separator, test bit X015SEPP in condition byte X015COND of the \$XPL. If X015SEPP is on, create a separator. If X015SEPP is off, do not create a separator.

The SEPDS= parameter on the PRT(nnnn), PUN(nnnn), R(nnnn).PR(m), or R(nnnn).PU(m) initialization statements indicates whether the installation

wants data set separators created. The operator has the option to change the SEPDS= value by issuing the command \$T *device* with the SEPDS= parameter specified. Before invoking Exit 15, JES2 sets bit X015SEPP to correspond to the current value of the SEPDS= parameter:

- If SEPDS=YES, JES2 turns on bit X015SEPP.
  - If SEPDS=NO, JES2 turns off X015SEPP.
4. The data set copy count and copy group count cannot be changed on the separator page call to Exit 15 because setup processing has already occurred. Make these changes during the data set select call to Exit 15.
  5. The data set copy group count affects separator pages this exit produces. JES2 sends the copy to the AFP printer before the calling Exit 15. The printer repeats all pages, including separator pages, on the basis of the copy group count.
  6. If Exit 15 returns a copy count or a copy group count greater than 255, JES2 writes a symptom record to the LOGREC data set to a job log and reset(s) the field(s) in error to 1.
  7. If the spooling capabilities of a remote SNA device (such as the 3790) are operating, use the \$SEPPDIR macro to send a peripheral data information record (PDIR) to the device. Use the \$GETBUF macro to supply this routine with HASP-type buffers and the \$FREEBUF macro to release the buffers after your routine creates the separator.
  8. Use SWBTUREQ REQUEST=RETRIEVE to retrieve any parameters a user specifies on the OUTPUT JCL statement you need to build your separator page. See *z/OS MVS Programming: Assembler Services Reference ABE-HSP* for more details about using the scheduler JCL facility and the SWBTUREQ macro.
  9. For local printers running in JES mode or for remote printers, the TRANS= parameter on the printer's initialization statement (statement PRT(nnnn) for a local printer, and statement R(nnnn).PR(m) for a remote printer) affects data translation for that printer:
    - If the initialization statement specifies TRANS=YES, JES2 translates each line of output sent to the device regardless of the device type or the setting of the PRINTDEF TRANS= parameter.
    - If the initialization statement specifies TRANS=NO, JES2 does not translate output sent to the device regardless of the device type or the setting of the PRINTDEF TRANS= parameter.
    - If the initialization statement specifies TRANS=DEFAULT or omits TRANS=, and the PRINTDEF statement specifies TRANS=YES, and the device is either a remote printer or a local printer other than an IBM 3211, IBM 3800, or IBM 3203 printer, JES2 translates each line of output sent to the device. Otherwise, JES2 does not translate output sent to the device.
  10. You can determine whether JES2 invoked Exit 15 to process SYSOUT created by a transaction program by:
    - Determining if field X015DSCT contains the address of a \$DSCT
    - Determining if byte JCTFLAG3 is set to JCT3TPI
  11. **Locating JCT Control Block Extensions**

You can locate extensions to the job control table (\$JCT) control block from this exit using the \$JCTXGET macro. For example, you can use these extensions to store job-related information. For more information, see *z/OS JES2 Macros*.

---

## Environment

### Task

JES2 main task. You must specify ENVIRON=JES2 on the \$MODULE macro.

### AMODE/RMODE requirements

AMODE 31, RMODE ANY

### Recovery

\$ESTAE recovery is in effect. If a program check occurs in the exit, JES2 interrupts the output currently processing on the device. The recovery routine will not call Exit 15 to free allocated resources. JES2 places the interrupted output groups in system hold with an indication that a failure occurred during separator exit processing. As with every exit, you should supply your own recovery within your exit routine.

### Job exit mask

Exit 15 is subject to job exit mask suppression.

### Mapping macros normally required

\$DCT, \$HASPEQU, \$HCT, \$JCT, \$JCTX, \$JOE, \$JQE, \$PCE, \$PDDB, \$XPL

---

## Point of processing

This exit is taken from the JES2 main task in HASPPRPU. The exit is taken once for each output data set where the \$PDDB matches the job output element (\$JOE) and once for each copy of the data set.

---

## Contents of registers on entry to Exit 15

| Register   | Contents   |            |             |       |   |          |                            |          |                    |         |   |  |  |          |             |  |   |
|------------|--|------------|-------------|-------|---|----------|----------------------------|----------|--------------------|---------|---|--|--|----------|-------------|--|---|
| 0          | Not applicable   |            |             |       |   |          |                            |          |                    |         |   |  |  |          |             |  |   |
| 1          | Pointer to a parameter list with the following structure, mapped by \$XPL:   |            |             |       |   |          |                            |          |                    |         |   |  |  |          |             |  |   |
|            | <table> <thead> <tr> <th>Field Name</th> <th>Description</th> </tr> </thead> <tbody> <tr> <td>XPLID</td> <td>The eyecatcher</td> </tr> <tr> <td>XPLLEVEL</td> <td>The version level of \$XPL</td> </tr> <tr> <td>XPLXITID</td> <td>The exit ID number</td> </tr> <tr> <td>X015IND</td> <td>Indicator byte. This byte indicates data set selection or data set separator processing as follows:</td> </tr> <tr> <td></td> <td> <table> <thead> <tr> <th>X015DSEL</th> <th>Description</th> </tr> </thead> <tbody> <tr> <td></td> <td>Bypass processing the current data set, or change the number of copies of the data set to be produced. (These functions are only available at data set selection time.)</td> </tr> </tbody> </table> </td> </tr> </tbody> </table> | Field Name | Description | XPLID | The eyecatcher  | XPLLEVEL | The version level of \$XPL | XPLXITID | The exit ID number | X015IND | Indicator byte. This byte indicates data set selection or data set separator processing as follows: |  | <table> <thead> <tr> <th>X015DSEL</th> <th>Description</th> </tr> </thead> <tbody> <tr> <td></td> <td>Bypass processing the current data set, or change the number of copies of the data set to be produced. (These functions are only available at data set selection time.)</td> </tr> </tbody> </table> | X015DSEL | Description |  | Bypass processing the current data set, or change the number of copies of the data set to be produced. (These functions are only available at data set selection time.) |
| Field Name | Description  |            |             |       |   |          |                            |          |                    |         |   |  |  |          |             |  |   |
| XPLID      | The eyecatcher   |            |             |       |   |          |                            |          |                    |         |   |  |  |          |             |  |   |
| XPLLEVEL   | The version level of \$XPL   |            |             |       |   |          |                            |          |                    |         |   |  |  |          |             |  |   |
| XPLXITID   | The exit ID number   |            |             |       |   |          |                            |          |                    |         |   |  |  |          |             |  |   |
| X015IND    | Indicator byte. This byte indicates data set selection or data set separator processing as follows:  |            |             |       |   |          |                            |          |                    |         |   |  |  |          |             |  |   |
|            | <table> <thead> <tr> <th>X015DSEL</th> <th>Description</th> </tr> </thead> <tbody> <tr> <td></td> <td>Bypass processing the current data set, or change the number of copies of the data set to be produced. (These functions are only available at data set selection time.)</td> </tr> </tbody> </table>   | X015DSEL   | Description |       | Bypass processing the current data set, or change the number of copies of the data set to be produced. (These functions are only available at data set selection time.) |          |                            |          |                    |         |   |  |  |          |             |  |   |
| X015DSEL   | Description  |            |             |       |   |          |                            |          |                    |         |   |  |  |          |             |  |   |
|            | Bypass processing the current data set, or change the number of copies of the data set to be produced. (These functions are only available at data set selection time.)  |            |             |       |   |          |                            |          |                    |         |   |  |  |          |             |  |   |

**X015DSEP**

Produce a data set separator, change the print translate table, and change the CCW translate table. (These functions are only available at data set copy time.)

**X015COND**

Condition byte.

**X015RFSW**

Identifies whether the current PDDB has output characteristics identical to characteristics pointed to by X015SWBT.

**X015SEPP**

If X015SEPP is on, SEPDS=YES was specified for the device and a separator is to be created. Otherwise, SEPDS=NO was specified and no separator is to be created.

**X015RESP**

Response byte. If the X015BYPS bit setting is on in the response byte, then the current PDDB will be bypassed. Otherwise, the current PDDB will be processed.

**X015DCT**

Address of \$DCT

**X015JCT**

Address of \$JCT

**X015DSCT**

Address of \$DSCT or zeros for a batch job

**X015JQE**

Address of the JQE

**X015JOA**

Address of the artificial JOE (JOA). The JOA contains both the Work-JOE and the Characteristics-JOE.

**Note:** If the exit must update JOE fields, it should obtain and return an update mode JOA. For more information, see "Checkpoint control blocks for JOEs" on page 415.

**X015PDDB**

Address of the PDDB

**X015SWBT**

Address of the SWBTU pointer list mapped by the SJTRSBTL DSECT in the IEFSJTRP parameter list for the first PDDB in the JOE. This field is zero if there is no OUTPUT JCL statement associated with the first PDDB. JES2 uses the SWBTU associated with the first PDDB to retrieve the output identification and delivery information for the entire output group.

**X015NSWB**

Number of SWBTUs JES2 despoiled. *z/OS MVS Programming: Assembler Services Reference IAR-XCT* contains additional information about SWBTU, and the IEFSJTRP parameter list.

**X015PRTR**

Address of the print translate table

|             |                 |  |
|-------------|-----------------|--|
|             | <b>X015CCWT</b> | Address of the CCW translate table                         |
|             | <b>X015NCOP</b> | The number of copies of this data set originally requested |
|             | <b>X015CPRT</b> | The number of copies currently printed                     |
|             | <b>X015CPGP</b> | Address of the current copy group                          |
|             | <b>X015CGCT</b> | Current copy group count                                   |
| <b>2-10</b> |                 | Not applicable   |
| <b>11</b>   |                 | Address of \$HCT   |
| <b>12</b>   |                 | Not applicable   |
| <b>13</b>   |                 | Address of \$PCE   |
| <b>14</b>   |                 | Return address   |
| <b>15</b>   |                 | Entry address  |

---

## Contents of register when Exit 15 returns to JES2

### Register

|             | Contents  |
|-------------|---|
| <b>0</b>    | Unchanged   |
| <b>1</b>    | Address of a parameter list mapped by \$XPL:<br><b>XPLRESP</b><br>This response byte must be set by the exit before returning to JES2. Set the response byte to X015BYPS to bypass processing of the current PDDB. If this byte is equal to some other value, the current PDDB will be processed. |
| <b>2-14</b> | Unchanged   |
| <b>15</b>   | Return code   |
|             | A return code of:   |
| <b>0</b>    | Tells JES2 that if any additional exit routines are associated with this exit, call the next consecutive exit routine.  |
| <b>4</b>    | Tells JES2 to ignore any other exit routines associated with this exit.   |

---

## Coded example

Module HASX15A in SYS1.SHASSAMP contains a sample of Exit 15.



---

## Chapter 28. Exit 16: Notify

---

### Function

This exit allows you to change notify message routing and to examine and modify \$WTO messages before they are sent to the TSO/E user.

Use your exit routine and the CMB to access the intended message, change it in place, or replace it with a new message.

---

### Environment

#### Task

JES2 main task. You must specify ENVIRON=JES2 on the \$MODULE macro.

#### AMODE/RMODE requirements

RMODE ANY, AMODE 31

#### Supervisor/problem program

JES2 places Exit 16 in supervisor state and PSW key 1.

#### Recovery

No recovery is in effect when this exit is taken. As with every exit, you should provide your own recovery within your exit routine.

#### Job exit mask

Exit 16 is subject to suppression. If the installation sets the 16th bit in the job exit suppression mask, it should be done only once. All transactions submitted under this initiator will not invoke Exit 16.

---

### Mapping macros normally required

\$CMB, \$JCT, \$JCTX, \$HASPEQU, \$HCT, \$MIT, \$PCE

---

### Point of processing

This exit is taken from the output processor in HASPHOPE before sending the \$WTO notify message.

---

### Programming considerations

1. The CMB maps the \$WTO parameter list. You map the parameter list by performing a USING on CMBWTOPL.
2. CMBML in the \$WTO parameter list is the length of the message that is intended to be sent. Whether your exit routine changes the messages in place or replaces it, you must update CMBML with the length of the new message. The intended message can be changed in place for up to a length of 86 bytes.
3. To change the node where the notify message is to be sent, move correct node number NITNUM (of the NIT) to CMBTONOD.

## Exit 16

4. To change the TSO/E user that the notify message is to go to store the TSO/E user id (7-character id) in CMB user.
5. On return from the exit, JES2 uses the address of the message in the first word of the parameter list.
6. For a return of 8 from your exit routine, JES2 resumes processing at OPNOTX in HASPPRPU.

### 7. Locating JCT Control Block Extensions

You can locate extensions to the job control table (\$JCT) control block from this exit using the \$JCTXGET macro. For example, you can use these extensions to store job-related information. For more information, see *z/OS JES2 Macros*.

---

## Register contents when Exit 16 gets control

The contents of the registers on entry to this exit are:

### Register

#### Contents

- |  |  |
|--|--|
| 0  | A code indicating if this is the first or succeeding \$HASP165 (JOB nnnnn ENDED – reason text) message |
| 0  | Indicates that this is the first (and possibly only) message indicating the end of the job             |
| 4  | Indicates that this is not the first message for this job going through the output processor           |
| <br><b>Note:</b> There is now only one HASP165 notify message for the job. The indicator is always set to 0 for compatibility. |  |
| 1  | Address of a 3-word parameter list with the following structure:                                       |
| <b>Word 1 (+0)</b>   | address of the message that is to be sent  |
| <b>Word 2 (+4)</b>   | address of the \$WTO parameter list  |
| <b>Word 3 (+8)</b>   | address of the \$JCT   |
| 2-10   | Not applicable   |
| 11   | Address of the \$HCT   |
| 12   | Not applicable   |
| 13   | Address of the output processor \$PCE  |
| 14   | Return address   |
| 15   | Entry address  |

---

## Register contents when Exit 16 passes control back to JES2

Upon return from this exit, the register contents must be:

### Register

#### Contents

- |   |                                      |
|---|--------------------------------------|
| 0 | Not applicable                       |
| 1 | Address of the 3-word parameter list |



- 2-13 Not applicable
- 14 Return address
- 15 A return code

A return code of:

- 0 Tells JES2 that if any additional exit routines are associated with this exit, call the next consecutive exit routine. If there are no additional exit routines associated with exit continue normal notify processing.
- 4 Tells JES2 to ignore any other exit routines associated with this exit and to continue normal notify processing.
- 8 Tells JES2 not to issue the notify \$WTO.

---

## Coded example

None provided.



---

## Chapter 29. Exit 17: BSC RJE SIGNON/SIGNOFF

---

### Function

This exit allows you to exercise more control over your BSC RJE remote devices. With this exit you can implement exit routines to:

- Selectively perform additional security checks beyond the standard password processing of the signon card image.
- Selectively limit both the number and types of remote devices that can be on the system at any one time.
- Selectively bypass security checks.
- Implement installation-defined scanning of signon card images.
- Collect statistics concerning RJE operations on the BSC line and report the results of the activity.

See Appendix B, "Sample code for Exit 17 and Exit 18," on page 405 for a sample code for Exit 17.

---

### Environment

#### Task

JES2 main task. You must specify ENVIRON=JES2 on the \$MODULE macro.

#### AMODE/RMODE requirements

RMODE ANY, AMODE 31

#### Supervisor/problem program

JES2 places exit 17 in supervisor state and PSW key 1.

#### Recovery

No recovery is in effect when this exit is taken. As with every exit, you should provide your own recovery within your exit routine.

#### Job exit mask

This exit is not subject to job exit mask suppression.

#### Storage recommendations

#### Mapping macros normally required

\$DCT, \$HASPEQU, \$HCT, \$MIT, \$PCE, \$RAT

---

### Point of processing

This exit is taken from the JES2 main task, during BSC RJE signon and signoff processing of HASPBSC. Three exit points are defined; two signon exit points for performing additional security or checks and one signoff exit point for gathering statistics about terminal usage.

## Exit 17

The exit gets control during signon in the MSIGNON routines of HASPBSC, and after signon and password processing.

The exit is given control before signon and password processing, allowing your exit routine to scan the incoming signon card. Your exit routine may also bypass both the JES2 syntax checking of the signon and the remote and line password parameters on the signon card or just bypass only the signon syntax checking. JES2 also gives the exit control after signon and password processing, allowing your exit routine to provide additional setup of the remote terminal environment.

JES2 also gives the exit control at sign off, after writing the disconnect message at label MDSWTO.

---

## Programming considerations

1. For exit point MSOXITA (R0=0) your exit routine has the option to return a return code that allows the user to specify that the signon should be rejected. A return code of 12 or 16 indicates that normal HASPBSC signon processing can be bypassed. In this case your installation exit routine is responsible for performing all the necessary syntax processing that HASPBSC does and for returning a valid RAT entry pointer in R0.
2. For the signoff exit point your exit routine should return a return code of 0 or 4 so that normal processing can continue.
3. To define and implement an installation-defined remote name, change the remote name to a standard JES2 remote name on the signon card and return with a return code of 0, or supply a valid RAT pointer (valid for the installation-defined remote name) and return with or return code of 12 or 16.
4. Your installation exit routine should not issue a \$WAIT or invoke a service routine that issues a \$WAIT.
5. For the syntax of the signon card, see *z/OS JES2 Initialization and Tuning Guide*.
6. The \$RETURN macro destroys the contents of register 0. Therefore, if you return the RAT address in R0, be certain to have provided a \$STORE R0 instruction before the \$RETURN to place the contents of R0 in the current save area before return to JES2.

---

## Register contents when Exit 17 gets control

The contents of the registers on entry to this exit are:

| Register | Contents  |
|----------|---|
| 0        | Indicates whether signon or signoff processing is in effect. The following values apply: <ul style="list-style-type: none"><li>0 indicates a signon before signon parameters are processed.</li><li>4 indicates a signon after the signon parameters have been processed.</li><li>8 indicates signoff processing.</li></ul> |
| 1        | Address of a 5-word parameter list, having the following structure: <ul style="list-style-type: none"><li><b>Word 1 (+0)</b><ul style="list-style-type: none"><li>address of the remote attribute table (RAT) (for R0=0 only)</li><li>address of the RAT entry (for R0=4 or 8)</li></ul></li></ul>                          |

- Word 2 (+4)**  
address of the line DCT
- Word 3 (+8)**  
zero (reserved for SNA)
- Word 4 (+12)**  
address of the card image (for R0=0 only)  
Otherwise not applicable
- Word 5 (+16)**  
length of the card image for R0=0 only)  
  
Otherwise not applicable  
  
(The length is always 80.)

- 2-10 N/A
- 11 Address of the HCT
- 12 N/A
- 13 Address of the line manager or remote reader PCE
- 14 Return address
- 15 Entry address

---

## Register contents when Exit 17 passes control back to JES2

Upon return from this exit, the register contents must be:

### Register

#### Contents

- 0 Address of the remote's RAT entry when the return code in R15 is 12 or 16 and the signon indication in R0 is "0"  
Otherwise not applicable
- 1 N/A
- 15 A return code

A return code of:

- 0 Tells JES2 that if any additional exit routines are associated with this exit, call the next consecutive exit routine. If there are no additional exit routines associated with this exit continue normal signon/signoff processing continues.
- 4 Tells JES2 to ignore any other exit routines associated with this exit and to continue normal signon/signoff processing.
- 8 Tells JES2 to terminate normal signon processing. No audit record is produced in this case. If you require an audit of this failure, your exit routine must issue a call to SAF to perform the audit.
- 12 Tells JES2 to call SAF with the remote id set in this exit and the password received on the /\*SIGNON statement.
- 16 Tells JES2 to call SAF with the remote id from the /\*SIGNON statement but do not verify the password.

## Exit 17

**Note:** RC 8, 12, and 16 are only valid for the exit when called from label MSOXITA (that is, the first call to the exit, R0=0).

---

### **Coded example**

See Appendix B, "Sample code for Exit 17 and Exit 18," on page 405.

---

## Chapter 30. Exit 18: SNA RJE LOGON/LOGOFF

---

### Function

This exit allows you to exercise more control over your SNA RJE remote devices. With this exit you can implement exit routines to:

- Selectively perform additional security checks beyond the standard password processing of the signon card image.
- Selectively limit both the number and types of remote devices that can be on the system at any one time.
- Selectively bypass security checks.
- Implement installation-defined scanning of signon card images.
- Collect statistics concerning RJE operations on the SNA line and report the results of the activity.

For a sample code of Exit 18, see Appendix B, “Sample code for Exit 17 and Exit 18,” on page 405.

---

### Environment

#### Task

JES2 main task. You must specify ENVIRON=JES2 on the \$MODULE macro.

#### AMODE/RMODE requirements

RMODE ANY, AMODE 31

#### Supervisor/problem program

JES2 places exit 18 in supervisor state and PSW key 1.

#### Recovery

No recovery is in effect when this exit is taken. As with every exit, you should provide your own recovery within your exit routine.

#### Job exit mask

This exit is not subject to job exit mask suppression.

#### Mapping macros normally required

\$DCT, \$HASPEQU, \$HCT, \$ICE, \$MIT, \$PCE, \$RAT

---

### Point of processing

This exit is taken from the JES2 main task during the SNA RJE logon and logoff processing of HASPSNA. Three exit points are defined for logon processing:

- At exit point MSNALXIT for a normal logon during REQ END processing after label MSNALPAR, your exit routine can be invoked to:
  - continue normal logon processing.
  - terminate normal logon processing.
  - perform password checking but not syntax checking.

## Exit 18

- bypass syntax and password checking.

When using multiple logical units, JES2 invokes Exit 18 from MSNALXIT for each logical unit on the remote when the logical unit logs on.

- At exit point MSNALXT2 your exit can get control when the remote terminal is logged on.
- Just before checkpointing the remote autologon at exit point MALGXIT, your exit can control autologon for the remote terminal.

One exit point (MICEXIT) is defined for logoff processing. This exit point is after label MICEDMSG in the session control subroutines of HASPSNA before the remote logoff message is issued. You can use this exit point for gathering statistics and reporting remote device activity.

---

## Programming considerations

1. In logoff processing, JES2 does not expect a return code from your exit routine. Normal logoff processing proceeds.
2. Your installation exit routine should not issue a \$WAIT or use a service routine that issues a \$WAIT.
3. To define and implement an installation-defined remote name, change the remote name to a standard JES2 remote name on the remote logon card and return with a return code of 0, or supply a valid RAT pointer (valid for the installation-defined remote name) and return with a return code of 12 or 16.

---

## Register contents when Exit 18 gets control

The contents of the registers on entry to this exit are:

### Register

#### Contents

- |   |   |
|---|---|
| 0 | A logon or logoff indication having the following meanings: <ul style="list-style-type: none"><li>0 indicates syntax processing for a normal logon</li><li>4 indicates logon processing for a normal logon after logon parameters have been processed</li><li>8 indicates logoff processing</li><li>12 indicates autologon processing</li></ul>   |
| 1 | Address of a 5-word parameter list having the following structure: <ul style="list-style-type: none"><li><b>Word 1 (+0)</b><br/>address of the remote attribute table (RAT) when R0 indicates a normal logon process of "0"<br/>address of a RAT entry when R0 indicates other than a normal logon process (that is, R0 contains a value of 4, 8, or 12).</li><li><b>Word 2 (+4)</b><ul style="list-style-type: none"><li>• 0 during syntax processing (that is, R0=0)</li><li>• address of the line DCT after logon is complete (that is, R0≠0)</li></ul></li><li><b>Word 3 (+8)</b><br/>address of the ICE</li><li><b>Word 4 (+12)</b><br/>address of the bind user data when R0 indicates normal logon</li></ul> |



processing (that is, R0=0). The format of the bind user data is determined by installation VTAM® application programs that define the bind user data.

**Word 5 (+16)**

length of the bind user data when R0 indicates normal logon processing (that is, R0=0).

|      |                                 |
|------|---------------------------------|
| 2-10 | N/A                             |
| 11   | Address of the HCT              |
| 12   | N/A                             |
| 13   | Address of the line manager PCE |
| 14   | Return address                  |
| 15   | Entry address                   |

---

## Register contents when Exit 18 passes control back to JES2

Upon return from this exit, the register contents must be:

**Register****Contents**

|    |   |
|----|---|
| 0  | Address of the RAT entry when R15 contains a return code of 12 or 16 and the logon indication in R0 is 0.<br>Otherwise register 0 is ignored. |
| 1  | N/A   |
| 15 | A return code   |

A return code:

|    |  |
|----|--|
| 0  | Tells JES2 that if any additional exit routines are associated with this exit, call the next consecutive exit routine. If there are no additional exit routines associated with this exit continue normal logon/logoff processing. |
| 4  | Tells JES2 to ignore any other exit routines associated with this exit and to continue normal logon/logoff processing.   |
| 8  | Tells JES2 to terminate normal logon processing (R0=0 or 12 only). No audit record is produced in this case. If you require an audit of this failure, your exit routine must issue a call to SAF to perform the audit.             |
| 12 | Tells JES2 to call SAF with the remote id set in this exit and the password received during logon processing (R0=0 only).  |
| 16 | Tells JES2 to call SAF with the remote id received during logon processing but do not verify the password (R0=0 only).   |

---

## Coded example

See Appendix B, "Sample code for Exit 17 and Exit 18," on page 405.



---

## Chapter 31. Exit 19: Initialization statement

---

### Function

This exit allows you to process each JES2 initialization statement before JES2 processes the statement. You can use your exit routine to do any of the following functions:

- check or analyze each initialization statement.
- alter values supplied on an initialization statement.
- implement your own initialization statements.
- modify, replace, delete, or insert statements in the initialization statement stream.
- terminate JES2 initialization.
- tailor the initialization statement stream to provide for specific requirements of this start of JES2 (e.g., add or delete parameters based on the period within administrative cycles or the operator shift).

---

### Environment

#### Task

JES2 main task (Initialization) – JES2 dispatcher disabled. You must specify ENVIRON=JES2 on the \$MODULE macro.

#### AMODE/RMODE requirements

RMODE ANY, AMODE 31

#### Supervisor/problem program

JES2 places exit 19 in supervisor state and PSW key 1.

#### Recovery

No recovery is in effect when this exit is taken. As with every exit, you should provide your own recovery within your exit routine.

#### Job exit mask

Exit 19 is not subject to suppression.

#### Mapping macros normally required

\$CIRWORK, \$HASPEQU, \$HCT, \$MIT, \$PCE

---

### Point of processing

This exit is taken during JES2 initialization from the initialization routine (IR) that processes parameter input (IRPL) in HASPIRPL. IRPL is called out of the initialization routine processing loop (IRLOOP) in HASPIRA before most other IRs have been called. Previously executed IRs have processed the initialization options, analyzed the SSI status, and allocated a series of temporary and permanent control blocks. Exit 0 routines, called during initialization options processing, may have allocated installation control blocks that may be used now by Exit 19 routines.

HASPIRPL opens the initialization parameter data set (HASPPARM) and then begins a loop; get an initialization statement from HASPPARM or the operator console or a previous insertion by Exit 19, pass it to Exit 19, log the statement, process the statement using the \$SCAN facility if Exit 19 has not indicated it should be deleted. When all input is exhausted, IRPL closes the parameter and log data sets.

---

### Programming considerations

1. Your EXIT(nnn) and LOADmod(jxxxxxx) initialization statements for this exit must be placed in the initialization deck ahead of those initialization statements that your exit routine is to scan. The EXIT(nnn) statement must enable (STATUS=ENABLED) the exit; the \$T EXIT(nnn) command cannot be used to enable (STATUS=ENABLED) the exit at a later time since the point of processing for Exit 19 is before the time at which the command processor is made functional.
2. Tracing for this exit is disabled because of its sequence in the initialization process.
3. JES2 does not have a recovery environment established at the processing point for Exit 19 (the JES2 ESTAE will process termination, but not recover).
4. Because Exit 19 is called early in JES2 initialization, some main task services may not be functional and some control blocks and interfaces may not be established. The JES2 dispatcher is not yet functional, so MVS protocol should be used in Exit 19 routines (WAIT rather than \$WAIT, ESTAE rather than \$ESTAE, and so forth).
5. The CONSOLE statement simulated after all other parameter input is exhausted if the CONSOLE initialization option was specified is not presented to Exit 19 exit routines.
6. Exit 19 routines may change the initialization statement passed or replace it by changing the address and length in the exit parameter list. They may also indicate, through a return code, that JES2 should bypass processing of the statement (perhaps because the routine has processed the statement already). Note that JES2 writes the statement (and any later diagnostics) to the log data set and hardcopy console only after return from the exit. Therefore the exit routines may want to log the statement passed from JES2, for diagnostic purposes, before changing or replacing it. The \$STMTLOG macro and service routine is provided to perform the logging function.
7. Independent of the actions of the exit routine that effect the status of the statement passed, a new initialization statement may be inserted into the parameter stream by the exit routine by returning a statement address and length in the exit parameter list. The inserted statement will be processed when the current statement is completely processed. Note that the current statement is not completely processed until either it is bypassed by exit 19, successfully scanned and processed by JES2, or found to be in error by JES2 and the resultant operator interaction by JES2 is complete. Since the operator interaction may involve input of multiple new initialization statements from the operator, the inserted statement may not be processed until after later calls to Exit 19. Also, when there are multiple exit 19 routines, only one routine can perform a statement insertion. For that reason, Exit 19 routines should verify that the insertion statement address and length in the exit parameter list are zero before using those fields to insert a statement.
8. The processing that JES2 does for each statement after calling Exit 19 is performed using the JES2 \$SCAN facility and a collection of tables. The tables define the parameter input allowed and how to process it. The scan may

involve multiple levels of scanning, that is, parameters which have sub-parameters, and so on. At each level, a new table is used. Each table is actually composed of two tables, an installation-defined table followed by a JES2-defined table.

By specifying installation-defined tables, an installation can implement its own initialization parameters on existing JES2 statements, or replace the JES2 definition for existing statements or parameters. Thus this function can be accomplished without implementing Exit 19, or with an implementation of Exit 19. Also, the \$SCAN facility itself can be used from an Exit 19 routine to process initialization statements.

---

## Register contents when Exit 19 gets control

The contents of the registers on entry to this exit are:

### Register

#### Contents

|      |   |
|------|---|
| 0    | An indication of how the initialization input was supplied. The following values in R0 are possible: <ul style="list-style-type: none"> <li>0 input came from the HASPARM parameter library file</li> <li>4 input came from the console</li> <li>8 input came from a previous insertion by an Exit 19 routine.</li> </ul>   |
| 1    | A 4-word parameter list having the following structure: <ul style="list-style-type: none"> <li><b>Word 1 (+0)</b><br/>address of the initialization statement about to be processed. You can modify the statement or replace the statement by altering this field.</li> <li><b>Word 2 (+4)</b><br/>length of the complete initialization statement passed. If you alter the passed statement or replace it, you should reset this field to the correct new statement length.</li> <li><b>Word 3 (+8)</b><br/>a word that can be used by Exit 19 to specify the address of an initialization statement you want to insert at the next possible statement insertion point. JES2 will log an information diagnostic indicating the statement was inserted by Exit 19.</li> <li><b>Word 4 (+12)</b><br/>length of the initialization statement pointed to by word 3.</li> </ul> |
| 2-10 | N/A   |
| 11   | Address of the HCT  |
| 12   | N/A   |
| 13   | Address of initialization PCE – the PCE work area for this PCE is the common initialization routine work area, mapped by the \$CIRWORK macro  |
| 14   | Return address  |
| 15   | Entry address   |

---

## Register contents when Exit 19 passes control back to JES2

Upon return from this exit, the register contents must be:

### Register

#### Contents

- 0-13    Unchanged
- 14     Return address
- 15     Return code

A return code of:

- 0       Tells JES2 that if any additional exit routines are associated with this exit, call the next consecutive exit routine. If no additional exit routines are associated with this exit, continue normal initialization statement processing. The exit routines might have changed or replaced the initialization statement passed.
- 4       Tells JES2 that if any additional exit routines are associated with this exit, call the next consecutive exit routine. If no additional exit routines are associated with this exit, continue normal initialization statement processing. The exit routines might have changed or replaced the initialization statement passed. However, JES2 should ignore any other exit routines associated with this exit.
- 8       Tells JES2 to bypass this initialization statement and continue with the next statement. JES2 will log the statement and a diagnostic information message indicating it was bypassed by Exit 19.
- 12      Tells JES2 to terminate all initialization processing and exit the system. HASPIRPL issues message \$HASP864 and returns to the IRLOOP with return code 8.
- 16      Tells JES2 that if any additional exit routines are associated with this exit, call the next consecutive exit routine. If no additional exit routines are associated with this exit, continue normal initialization statement processing. The exit routines might have changed or replaced the initialization statement passed. However, the system is not to substitute text for system symbols that are specified in the initialization statement.

---

## Coded example

None provided.

---

## Chapter 32. Exit 20: End of input

---

### Function

This exit allows you to do the following:

- Selectively assign a job's/job group's priority, affinity, execution node, SCHENV, and job class, and influence next phase of job processing based on an installation's unique requirements and processing workload. Priority, execution node, and job class are ignored for job groups.
- Based on installation-defined criteria, terminate a job's/job group's normal processing and selectively print or not print its output.
- Exit 20 allows input processing - end of input.
- Override the value of the user portion of the job correlator.

**Note:** See Appendix A, "JES2 exit usage limitations," on page 403 for a listing of specific instances when this exit will be invoked or not invoked.

---

### Environment

#### Task

JES2 main task. You must specify ENVIRON=JES2 on the \$MODULE macro.

#### AMODE/RMODE requirements

RMODE ANY, AMODE 31

#### Supervisor/problem program

JES2 places Exit 20 in supervisor state and PSW key 1.

#### Recovery

\$ESTAE recovery is in effect. However, as with every exit, your exit routine *should not* depend on JES2 for recovery. JES2 cannot anticipate the exact purpose of your exit routine and can therefore provide no more than minimal recovery. You should provide your own recovery within your exit routine.

#### Job exit mask

Exit 20 is subject to suppression. You can suppress Exit 20 by either setting the 20th bit in the job exit suppression mask (JCTXMASK) or by indicating the exit is disabled in the initialization stream.

#### Mapping macros normally required

\$JCT, \$JCTX, \$HCT, \$PCE, \$HASPEQU, \$MIT, \$JRW, \$HCCT, \$BUFFER, RPL, \$DCT

---

### Point of processing

This exit is taken in the subroutine CJOBEND or in the subroutine CJOBKILL of HASCSRIP in the JES2 main task.

## Programming considerations

1. To change affinity, set the X020SAF field in the \$XPL work area using the \$SETAFF macro.

To allow the job/job group to run on any member:

```
$SETAFF REQUEST=ANY,AFFIELD=X020SAF
```

To allow the job/job group to run on only this member:

```
$SETAFF REQUEST=CLEAR,AFFIELD=X020SAF
```

```
$SETAFF REQUEST=ADD,AFFIELD=X020SAF
AFTOKEN=$AFFINTY
```

2. If MVS submits a job through an internal reader, it can force a job's affinity to the local member. This can occur when the automatic restart manager restarts a job. The automatic restart manager expects the job to execute on a specific member, and will change the job's affinity so the job can run on that specific member, if necessary. If the automatic restart manager has changed the job's affinity, the X0201ARM flag in the XPL is on. You can test this flag and determine whether the affinity was changed. With that information, you can then decide whether to avoid changing the affinity.
3. To set independent mode for a job, the installation must turn on the bit X0201IND in X020FLG1.

To put jobs that start with the characters 'IND' into independent mode:

|        |          |                    |                            |
|--------|----------|--------------------|----------------------------|
| EXIT20 | \$ENTRY  | BASE=R12,SAVE=YES  | Set entry point            |
|        | LTR      | R10,R10            | If JCT not present         |
|        | BZ       | RRET               | can't check jobname        |
|        | CLC      | =C'IND',JCTJNAME   | Job want independent mode? |
|        | BNE      | RRET               | No, leave flags alone      |
|        | OI       | X020FLG1, X0201IND | Set independent mode       |
| RRET   | \$RETURN | RC=0               | Return to caller           |

**Note:** An attempt to set independent mode for the logging job representing a job group is ignored.

4. To change the job priority, set X020PRIO in the XPL. The priority is contained in the 4 high-order bits of X020PRIO. For example, a value of 'C0' indicates priority 12. (See *z/OS JES2 Initialization and Tuning Reference* for further details on setting and changing job priority.)
  - To change the execution node, update X020XNOD with the half word binary value of the node. Use the \$DEST macro to convert an EBCDIC node name to the internal binary representation of the node number
  - To change the job class, place the new job class in X020JCLS. This is honored only if the job is a batch job, not if it is an STC or TSU job.
  - The exit can influence the next phase of the job/job group in most circumstances. Place the next phase value in X020NEXT. X020NEXT is primed with the phase that JES2 believes is the correct next phase when the exit is called. The exit can place one of these values in X020NEXT:

### \$OUTPUT

Places the job/job group in the OUTPUT queue unless JES2 has already determined that the job/job group should be purged. In that case, X020NEXT is ignored.

### \$PURGE

Places the job/job group in the PURGE queue.



**Any other phase**

JES2 honors the request unless it has already determined that the job/job group should be placed in the OUTPUT or PURGE phase.

The next phase can also be set through the return code in R15. If one or both of the specifications specify PURGE; then PURGE will be the next phase. If neither specify PURGE, but one or both specify OUTPUT; then the next phase will be OUTPUT.

**5. Extending the JCT Control Block**

You can add, expand, locate, and remove extensions to the job control table (\$JCT) control block from this exit using the \$JCTX macro extension service. For example, you can use these extensions to store job/job group-related information. For more information, see *z/OS JES2 Macros*.

**6. This exit will not be taken under the following circumstances:**

- The JES2 input service processor fails the job because JES2 does not identify a JOB/JOBGROUP card within the input stream.
7. If you need to change the scheduling environment, use the X020SENV field in the XPL.
  8. Setting the X020AVF response bit does NOT influence the next phase of the job/job group. To influence the next phase of the job/job group, you must use the documented methods.

---

## Register contents when Exit 20 gets control

The contents of the registers on entry to this exit are:

**Register****Contents**

- |           |  |
|-----------|--|
| <b>0</b>  | A code indicating:   |
| <b>0</b>  | Normal end of input.   |
| <b>4</b>  | Job/job group has a JES2 control statement error.                          |
| <b>8</b>  | Job/job group has an SAF (security) failure.                               |
| <b>12</b> | Job failed work selection criteria (OFFLOADER only)                        |
| <b>1</b>  | Pointer to a parameter list with the following structure, mapped by \$XPL: |

**Field Name****Description****XPLID**

The eyecatcher.

**XPLLEVEL**

Version level for base XPL.

**XPLXITID**

The exit ID number.

**XPLEXLEV**

Version number for exit

**X020IND**

Indicator byte.

**X020COND**

Condition byte.

**X020GJOB**

Condition bit that specifies a normal job.

**X020JECL**

Condition bit that specifies a JECL error.

**X020BSAF**

Condition bit that specifies an SAF failure.

**X020WSEL**

Condition bit that specifies the job failed to meet work selection criteria.

**X020JOBG**

Condition bit that specifies a normal job group.

**X020RESP**

Response byte.

**X020NORM**

Response bit that specifies to do normal process.

**X020OUTP**

Response bit that specifies to terminate with output.

**X020PURG**

Response bit that specifies to terminate job/job group without printing the output.

**X020AVF**

Response bit that indicates the exit's job/job group verification failed.

**XPLSIZE**

Size of parm list, including base section.

**X020JCT**

Address of the JCT.

**X020JQE**

Address of update mode JQA.

**X020DCT**

Address of the DCT.

**X020AREA**

Address of the JRW

**X020PRIO**

Job priority (Input/Output field)

**X020FLG1**

Flags

**X020XNOD**

Execution Node (Input/Output field)

**X020SAF**

Full system affinity mask (Input/Output)

**X020SENV**

Scheduling Environment (Input/Output field)

**X020JCLS**

Job class (Input/Output field)

**X020NEXT**

Next job phase (Input/Output field)

**X020UCOR**

Override user portion of the job correlator

|     |                             |
|-----|-----------------------------|
| 2-9 | Not applicable              |
| 10  | Address of the JCT.         |
| 11  | Address of the HCT.         |
| 12  | Not applicable              |
| 13  | Address of the HASPRDR PCE. |
| 14  | Return address.             |
| 15  | Entry address               |

---

## Register contents when Exit 20 passes control back to JES2

Upon return from this exit, the register contents must be:

**Register****Contents**

|   |  |
|---|--|
| 0 | N/A  |
| 1 | Address of a parameter list mapped by \$XPL: |

**X020RESP**

Response byte that may be set by the exit before returning to JES2.

|    |              |
|----|--------------|
| 15 | Return code. |
|----|--------------|

A return code of:

|    |   |
|----|---|
| 0  | Tells JES2 that if additional exit routines are associated with this exit, call the next consecutive exit routine. If no additional exit routines are associated with this exit continue normal processing. |
| 4  | Tells JES2 to ignore any other exit routines associated with this exit and to continue normal processing.   |
| 8  | Tells JES2 to terminate normal processing and print the output.   |
| 12 | Tells JES2 to terminate normal processing without printing the output.  |

---

## Coded example

Module HASX20A in SYS1.SHASSAMP contains a sample of Exit 20.



---

## Chapter 33. Exit 21: SMF record

---

### Function

This exit allows you to do the following:

- Selectively queue or not queue the SMF record of JES2 control blocks for processing by SMF.
- Obtain and create SMF control blocks before queuing.
- Alter content and length of SMF control block before queuing.

---

### Environment

#### Task

JES2 main task. You must specify ENVIRON=JES2 on the \$MODULE macro.

#### AMODE/RMODE requirements

RMODE ANY, AMODE 31

#### Supervisor/problem program

JES2 places exit 21 in supervisor state and PSW key 1.

#### Recovery

No recovery is in effect when this exit is taken. As with every exit, you should provide your own recovery within your exit routine.

#### Job exit mask

This exit is not subject to job exit mask suppression.

#### Mapping macros normally required

\$HASPEQU, \$HCT, \$MIT, \$PCE, \$SMF

---

### Point of processing

This exit is taken in HASPNUC whenever a JES2 processor queues an SMF record for eventual processing by the JES2-SMF subtask. The \$QUESMFB routine in HASPNUC places a JES2-SMF buffer on the queue of busy JES2-SMF buffers. (The \$SMFBUSY cell in the HCT points to the busy queue.)

---

### Programming considerations

1. When modifying the SMF record, your exit routine can increase the size of the SMF record up to a length of SMFLNG (bytes).
2. You can issue \$GETSMFB and \$QUESMFB in your exit routine.
3. The SMF record type is detected by examining the SMFHDRTY field, **not** the SMFTYPE field of the SMF DSECT.

For more information about SMF, see *z/OS MVS System Management Facilities (SMF)*.

## Exit 21

4. You can determine if JES2 invoked exit 21 to record information for a transaction program by determining if byte JCTFLAG3 is set to JCT3TPI.

---

### Register contents when Exit 21 gets control

The contents of the registers on entry to this exit are:

| Register | Contents |
|----------|----------|
|----------|----------|

|   |          |
|---|----------|
| 0 | Zero (0) |
|---|----------|

|   |                     |
|---|---------------------|
| 1 | SMF buffer address. |
|---|---------------------|

This buffer will contain either an SMF record or a job management record (JMR) based on the value of field SMFTYPE.

| Field Value | Record Type |
|-------------|-------------|
|-------------|-------------|

|       |            |
|-------|------------|
| X'00' | SMF record |
|-------|------------|

|       |                   |
|-------|-------------------|
| X'40' | Large SMF record. |
|-------|-------------------|

|       |             |
|-------|-------------|
| X'80' | JMR record. |
|-------|-------------|

|     |     |
|-----|-----|
| 2-9 | N/A |
|-----|-----|

|    |                         |
|----|-------------------------|
| 10 | Address of the JCT or 0 |
|----|-------------------------|

|    |                    |
|----|--------------------|
| 11 | Address of the HCT |
|----|--------------------|

|    |     |
|----|-----|
| 12 | N/A |
|----|-----|

|    |                             |
|----|-----------------------------|
| 13 | Address of the caller's PCE |
|----|-----------------------------|

|    |                |
|----|----------------|
| 14 | Return address |
|----|----------------|

|    |               |
|----|---------------|
| 15 | Entry address |
|----|---------------|

---

### Register contents when Exit 21 passes control back to JES2

Upon return from this exit, the register contents must be:

| Register | Contents |
|----------|----------|
|----------|----------|

|      |                |
|------|----------------|
| 0-13 | Not applicable |
|------|----------------|

|    |                |
|----|----------------|
| 14 | Return address |
|----|----------------|

|    |             |
|----|-------------|
| 15 | Return code |
|----|-------------|

A return code of:

|   |   |
|---|---|
| 0 | Tells JES2 that if any additional exit routines are associated with this exit, call the next consecutive exit routine. If no additional exit routines are associated with this exit continue normal SMF queue processing. |
|---|---|

|   |   |
|---|---|
| 4 | Tells JES2 to ignore any other exit routines associated with this exit and to continue normal SMF queue processing. |
|---|---|

|   |  |
|---|--|
| 8 | Tells JES2 to terminate normal SMF queue processing. |
|---|--|

---

### Coded example

None provided.

---

## Chapter 34. Exit 22: Cancel/status

---

### Function

This exit allows your installation to implement its own algorithms for job queue searching and for TSO/E CANCEL/STATUS. Your exit routine can perform its own search for a requested job or transaction program and indicate whether it has found the job, or it can let JES2 perform the standard search.

---

### Environment

#### Task

JES2 main task. You must specify ENVIRON=JES2 on the \$MODULE macro.

#### AMODE/RMODE requirements

RMODE ANY, AMODE 31

#### Supervisor/problem program

JES2 places exit 22 in supervisor state and PSW key 1.

#### Recovery

No recovery is in effect when this exit is taken. As with every exit, you should provide your own recovery within your exit routine.

#### Job exit mask

This exit is not subject to job exit mask suppression.

#### Mapping macros normally required

\$HASPEQU, \$HCT, \$MIT, \$PCE, \$STAC, \$XPL

---

### Point of processing

This exit is taken just before searching the JES2 job queue for a “status” or “cancel” request in HASPSTAC of the JES2 main task. The exit is given control twice in HASPSTAC where HASPSTAC performs the cancel and status functions for the TSO/E user (STCSTART).

The cancel and status functions execute when a Status/Cancel block (STAC) is queued to the CCTCSHED FIFO queue in the HCCT. The cancel/status support routine performs this queuing. JES2 then issues a WAIT (against SJBSECBS) to wait for the completion of the cancel/status processing.

---

### Programming considerations

1. The return code from your exit routine will cause HASPSTAC to pass back the proper return code to JES2. JES2 propagates that return code to TSO/E to issue the appropriate message.

## Exit 22

- For multiple cancel status requests, (your exit routine returned a return code of 12), HASPSTAC returns a 0 return code in the subsystem job block (SSJB). JES2 propagates that return code to TSO/E in SSOBRETN.
- To end a multiple status request your exit routine must return a "0" JQE address in R1 and issue a return code of 12.
- The \$JCAN macro can be used in your exit routine.
- Message IKJ56216I can be misleading. The second level message tells the user that the job queues were searched for job names consisting of the userid plus one character. You can code your exit so that the job queue is searched for all of the user's jobs.
- First level messages such as IKJ56190I, IKJ56192I, IJK56197I, and IJK56211I can also be misleading if the exit returned a JQE address in R1 and a return code of 12. The jobname in these messages is constructed by TSO/E using the TSO/E user's userid and the last character of the job name in the JQE that was selected by this exit. Depending on the job(s) selected by the exit, the jobname(s) taken from the JQE may not begin with the userid; however, the jobid in the message(s) is correct for the job processed.
- You can determine if JES2 invoked exit 22 to process a transaction program by determining if flag SJBFLGA is set to SJBATP. Otherwise, JES2 invoked exit 22 to process a batch job.

---

## Register contents when Exit 22 gets control

The contents of the registers on entry to this exit are:

### Register

#### Control

- 0 Not applicable.
- 1 Pointer to a parameter list with the following structure, mapped by \$XPL:

#### XPLID

Eyecatcher

#### XPLLEVEL

Maintenance Level

#### XPLXITID

Exit Number

#### XPLEXLEV

Version Number

#### XPLIND

Indicator byte

JES2 sets the indicator byte to one of the following bit settings:

#### X022FRST

**First call to exit** Indicates a single cancel request or the first status request determined by examining the function bit (SACTFUNC) in the STAC.

#### X022MURE

**Multiple recall** Indicates a multiple status recall request.

#### X022MUST

**Multiple status overflow** Indicates a multiple status overflow condition. The buffer that holds the status information is too small.



**XPLCOND**

Condition byte

**XPLRESP**

Response byte

**XPLSIZE**

Size of parameter list

The STAC, mapped by the \$STAC macro, is in a data space. Perform \$ARMODE ON before accessing the data and \$ARMODE OFF after finishing the access.

**X022STAC**

Address of STAC

**X022STAA**

ALET of stack

|      |                                  |
|------|----------------------------------|
| 2-10 | N/A                              |
| 11   | Address of the HCT               |
| 12   | N/A                              |
| 13   | Address of the STATUS/CANCEL PCE |
| 14   | Return address                   |
| 15   | Entry address                    |

---

## Register contents when Exit 22 passes control back to JES2

Upon return from this exit, the register contents must be:

**Register****Contents**

|      |   |
|------|---|
| 0    | Not applicable  |
| 1    | Address of the JQE for return codes of 8 and 12; otherwise not applicable |
| 2-13 | Not applicable  |
| 14   | Return address  |
| 15   | A return code   |

A return code of:

|    |  |
|----|--|
| 0  | Tells JES2 that if any additional exit routines are associated with this exit, call the next consecutive exit routine. If no additional exit routines are associated with this exit, continue normal processing. |
| 4  | Tells JES2 to ignore any other exit routines associated with this exit and to continue normal processing.  |
| 8  | Tells JES2 to process a single request.  |
| 12 | Tells JES2 to process a multiple request.  |
| 16 | Tells JES2 that the exit routine has done all the processing requested. HASPSTAC returns a code of 0.  |
| 20 | Tells JES2 that the job is not found. HASPSTAC returns a code of 4.  |
| 24 | Tells JES2 that an invalid combination was requested. HASPSTAC returns a code of 8.  |

## Exit 22

- 28 Tells JES2 that jobs with the same job name were found. HASPSTAC returns a code of 12.
- 32 Tells JES2 that the status buffer is too small to hold all the data requested. HASPSTAC returns a code of 16.
- 36 Tells JES2 that the job was not queuing because it is on the output queue. HASPSTAC returns a code of 20.
- 40 Tells JES2 that an invalid cancel request was made. HASPSTAC returns a code of 28.

**Note:** RC 12 – 40 are only valid for this exit when called from label STCZEXIT (that is, R0=0 or 4 only).

- 44 Tells JES2 that the request should be failed for security reasons and SSCSAUTH should be returned to the SSI caller.

The returned code causes the correct message to be presented to the TSO/E interface. For multiple status requests (RC=12), register R1 must be returned with a zero to end the processing and cause the messages to be issued.

---

### Coded example

None provided.

---

## Chapter 35. Exit 23: FSS job separator page (JSPA) processing

---

### Function

This exit allows you to modify the user-dependent section of the job separator page data area (JSPA). When JES2 assigns an output group to a functional subsystem application (FSA), it also creates a JSPA to provide job- and data set-level information for that data set. The FSA uses this information to generate the job header, job trailer, and data set header for an output group.

The JSPA contains three sections. HASPFSSM fills in two of these sections, the JES-dependent section and common section, after this exit returns control to JES2. Therefore, HASPFSSM overwrites any modifications you make to these sections at that time. Use this exit to modify the user-dependent fields (JSPAUSR1 and JSPAUSR2) in the third section, only.

---

### Recommendations for implementing Exit 23

You can use Exit 23 to suppress the assignment of a JESNEWS data set by:

1. Turning off the flag bit in the JOE information block (JIB) that indicates JESNEWS printing.
2. Setting a return code of 8 in register 15. This suppresses both the JESNEWS data set and the separator pages.

---

### Environment

#### Task

Functional subsystem (HASPFSM). You must specify ENVIRON=FSS on the \$MODULE macro.

#### AMODE/RMODE requirements

RMODE ANY, AMODE 31

#### Supervisor/problem program

JES2 places Exit 23 in supervisor state and PSW key 1.

#### Recovery

No recovery is in effect when this exit is taken. As with every exit, you should provide your own recovery within your exit routine.

#### Job exit mask

Exit 23 is subject to suppression. You can suppress Exit 23 by either setting the 23rd bit in the job exit suppression mask (JCTXMASK) or by indicating the exit is disabled in the initialization stream.

## Restrictions

You should ensure that your exit routine does not violate your installations security policy by:

- Overlaying the PSF-defined security label area
- Suppressing required separator pages.

## Mapping macros normally required

\$FSACB, \$FSSCB, \$HASPEQU, \$HFCT, \$JIB, JSPA, ETD, FSIP

## Point of processing

This exit is invoked through the exit effector during GETDS processing. Whenever a new JIB is initialized during GETDS processing, Exit 23 is invoked in HASPFSSM. At this time, the associated \$JCT, \$IOT, and checkpoint records are read and the JSPA is built.

See "Programming Considerations" below for further coding requirements associated with this exit.

## Programming considerations

1. A save-area type control block is obtained for use as the parameter list loaded into register 1 when control is passed to the exit routine.
2. The assignment of the JESNEWS data set can be checked in the \$JOE information block (\$JIB). The JIBFNEWS bit can be set or reset by the exit routine; however, if a return code of 8 is returned, the JESNEWS is not assigned; this is independent of the JIBFNEWS bit setting.
3. IAZFSIP maps the GETDS parameter list.
4. IAZJSPA maps the JSPA parameter list. Flag bit JSPA1UND, when on, indicates that the userid in field JSPCEUID is an undefined user.
5. Exit 23 routines should issue \$SAVE after the \$ENTRY macro and return to the exit effector using \$RETURN. These routines also can call subroutines of their own which also use \$SAVE/\$RETURN logic.
6. This exit must be in common storage. **Do not linkedit this exit to HASPFSSM.**
7. **Locating JCT Control Block Extensions**

If the \$JCT address is contained in field JIBJCT, you can locate extensions to the job control table (\$JCT) control block from this exit using the \$JCTXGET macro. For example, you can use these extensions to store job-related information. For more information, see *z/OS JES2 Macros*.

## Register contents when Exit 23 gets control

The contents of the register on entry to this exit are:

| Register | Contents   |
|----------|--|
| 0        | Not applicable   |
| 1        | Address of a 5-word parameter list, having the following structure: <ul style="list-style-type: none"> <li><b>word1 (+0)</b><br/>JSPA address</li> </ul> |

|      |                    |   |
|------|--------------------|---|
|      | <b>word2 (+4)</b>  | JIB address   |
|      | <b>word3 (+8)</b>  | FSACB address   |
|      | <b>word4 (+12)</b> | FSSCB address   |
|      | <b>word5 (+16)</b> | GETDS parameter list address (IAZFSIP)  |
| 2-10 |                    | Not applicable  |
| 11   |                    | Address of the \$HFCT   |
| 12   |                    | Not applicable  |
| 13   |                    | The address of an 18-word save area where the exit routine stores the exit effector's registers |
| 14   |                    | Return address  |
| 15   |                    | Entry address   |

---

## Register contents when Exit 23 passes control back to JES2

Upon return from this exit, the register contents must be:

| Register | Contents       |
|----------|----------------|
| 0-1      | Not applicable |
| 2-14     | Unchanged      |
| 15       | A return code  |

A return code of:

|    |  |
|----|--|
| 0  | Tells JES2, if additional exit routines are associated with this exit, to call the next consecutive exit routine. If no additional exit routines are associated with this exit a zero return code tells the FSA to produce any separator that has been defined by the installation based on the information contained in the JSPA. |
| 4  | Tells JES2 to ignore any additional exit routines associated with this exit. However, all other processing noted for return code 0 is accomplished.  |
| 8  | Tells JES2 to unconditionally suppress production of the job separator page. The JESNEWS data set is not assigned.   |
| 12 | Tells JES2 to <b>unconditionally</b> (that is, even if the printer has been set to S=N) produce any job separator page.  |

---

## Coded example

Module HASX23A in SYS1.SHASSAMP contains a sample of Exit 23.



---

## Chapter 36. Exit 24: Post–initialization

---

### Function

This exit allows you to make modifications to JES2 control blocks before JES2 initialization ends and to create and initialize control blocks that your installation defines for its own special purposes.

---

### Environment

#### Task

JES2 Main Task (Initialization) – JES2 dispatcher disabled

The following JES2 initialization steps have been performed before your exit routine gets control. Essentially all JES2 initialization is done, but the JES2 warm start processor has not been dispatched yet to perform its initialization-like processing.

You must specify ENVIRON=JES2 on the \$MODULE macro.

1. The JES2 initialization options are obtained from the operator or the PARM parameter on the EXEC statement and converted into status bits.
2. The JES2 initialization statement data set is read and processed.
3. The direct-access devices are scanned, and eligible spooling volumes are identified and allocated to JES2.
4. The spooling and checkpoint data sets are examined and initialized for JES2 processing.
5. The subsystem interface control blocks are constructed and initialized.
6. The unit-record devices, remote job entry lines, and network job entry lines are scanned; eligible and specified devices are located and allocated.
7. JES2 subtasks are attached, and exit routines are located.
8. SMF processing is started by generating a type 43 SMF record.
9. The JES2 control blocks, such as the HASP communications table (HCT), the device control tables (DCT), the data control blocks (DCB), the processor control elements (PCE), the data extent blocks (DEB), and the buffers (IOB), are constructed and initialized.

#### AMODE/RMODE requirements

RMODE ANY, AMODE 31

#### Supervisor/problem program

JES2 places exit 24 in supervisor state and PSW key 1.

#### Recovery

JES2 does not have a recovery environment established at the processing point for Exit 24 (the JES2 ESTAE will process termination, but not recover).

#### Job exit mask

This exit is not subject to job exit mask suppression.

## Mapping macros normally required

\$CIRWORK, \$HASPEQU, \$HCT, \$PCE

---

### Point of processing

When Exit 24 is called, HASPIRA has called each JES2 initialization routine (IR) in turn to perform JES2 initialization. After all the IRs have successfully completed, HASPIRA calls the Exit 24 routine(s) before tracing the JES2 initialization and returning control to the HASJES20 load module (HASPNUC). On return from HASPINIT, HASPNUC deletes the HASPINIT load module (if not part of HASJES20) and passes control to the asynchronous input/output processor, \$ASYNC, resulting in the dispatching of JES2 processors.

---

### Creating an information string through Exit 24

This information string gives the installation the option of providing its own information to applications that request subsystem version information (through SSI code 54), and to override the information passed by JES2.

Information about defining keywords and values for information strings is provided in *z/OS MVS Using the Subsystem Interface* (in the discussion of SSI code 54).

Use the following steps to create an information string during JES2 initialization. (JES2 does not pass an information build area to Exit 24 during a hot start.)

1. Check the condition byte in field XPLCOND to ensure that the JES2 is warm starting, quick starting, cold starting, or restarting through a \$E MEMBER RESTART command.
2. Check the information build area length in field X024SSWL to ensure that the area is large enough to accommodate the installation string. If the area is too small, ensure that Exit 24 bypasses the installation code that builds the string.
3. Obtain the pointer to the information build area from field X024SSIA, then move the installation string into the build area.
4. Initialize field X024SSIL with the length of the string.
5. Set flag X024RSSI in the XPL response byte to indicate that Exit 24 is supplying an information string before returning to JES2 initialization.

When JES2 processing validates the variable information string, the HASPIRA module obtains storage in ECSA. Then JES2 moves the variable information string from the build area pointed to by X024SSIA to extended common storage.

---

### Programming considerations

1. The EXIT(nnn) statement for Exit 24 must specify STATUS=ENABLED for the exit; the \$T EXIT(nnn) command cannot be used to enable (STATUS=ENABLED) the exit at a later time since the point of processing for Exit 24 is before the time at which the command processor is made functional.
2. Because Exit 24 is called from JES2 initialization, the JES2 dispatcher is not yet functional; so MVS protocol should be used in Exit 24 routines (for example, WAIT rather than \$WAIT and ESTAE rather than \$ESTAE).
3. If Exit 24 returns a return code of 8, HASPIRA issues message \$HASP864 INITIALIZATION TERMINATED BY INSTALLATION EXIT 24. The \$HASP428 message will also be issued before final termination.



4. Your exit routine can access JES2 control blocks through the HCT. Your exit routine can then access DCTs, PCEs, buffers, the UCT, and so on. for making modifications.
5. Your exit routine is responsible for establishing addressability to your own special control blocks. The HCT points to the optional user-defined UCT and other areas are provided in the HCT for various installation uses, identified by labels \$USER1 through \$USER5.

---

## Register contents when Exit 24 gets control

The contents of the registers on entry to this exit are:

### Register

#### Contents

- 0 Not applicable
- 1 Pointer to a parameter list with the following structure, mapped by \$XPL:

#### Field Name

#### Description

#### XPLID

Parameter list eyecatcher

#### XPLLEVEL

Version level of \$XPL parameter list

#### XPLXITID

Exit ID number

#### X024IND

Indicator byte: not applicable.

#### X024COND

Condition byte indicating the type of JES2 start in progress.

#### X024WARM

Indicates single-system warm start.

#### X024HOT

Indicates hot start.

#### X024QCK

Indicates quick start.

#### X024ALLS

Indicates all-systems warm start.

#### X024ESYS

Indicates \$E MEMBER restart.

#### X024COLD

Indicates cold start.

#### X024IPL

Indicates system has been IPLed.

#### X024COFM

Indicates cold start with format in progress.

#### X024RESP

Response byte

## Exit 24

### X024SSIA

Address of the information build area where the exit builds the SSI information string. The caller of EXIT 24 provides this area (set to zero during a JES2 hot start).

### X024SSWL

Length of the information build area (the area pointed to by X024SSIA). The caller of Exit 24 provides this value.

|      |  |
|------|--|
| 2-10 | Not applicable   |
| 11   | Address of \$HCT   |
| 12   | Not applicable   |
| 13   | Address of \$PCE: the PCE work area is the common initialization routine work area, mapped by the \$CIRWORK macro. |
| 14   | Return address   |
| 15   | Entry address  |

---

## Register contents when Exit 24 passes control back to JES2

Upon return from this exit, the register contents must be:

### Register

#### Contents

|      |  |
|------|--|
| 0    | N/A  |
| 1    | Pointer to a parameter list with the following structure, mapped by \$XPL:<br><b>XPLRESP</b><br>Response byte that indicates actions taken by the exit.<br><b>X024RSSI</b><br>Indicates that the exit is providing a string of SSI information.<br><b>X024SSIL</b><br>Length of the string built by the exit. EXIT 24 provides this value. |
| 2-13 | N/A  |
| 14   | Return Address   |
| 15   | Return code  |

A return code of:

|   |   |
|---|---|
| 0 | Tells JES2 that if any additional exit routines are associated with this exit, call the next consecutive exit routine. If no additional exit routines are associated with this exit continue the normal initialization process. |
| 4 | Tells JES2 to ignore any other exit routines associated with this exit and to continue normal initialization processing.  |
| 8 | Tells JES2 to terminate normal initialization. This results in the \$HASP864 error message to the operator.   |

---

## Coded example

Module HASX24A in SYS1.SHASSAMP contains a sample of Exit 24 .

---

## Chapter 37. Exit 25: JCT read

---

### Function

This exit allows you to provide an exit routine to receive control whenever a JES2 functional subsystem address space (HASPFSM) performs JCT I/O. That is, your routine receives control just after the JCT is read into storage by the HASPFSM module which executes as part of the FSS address space.

You can use this exit to perform I/O for any installation-specific control blocks you may have created.

---

### Related exits

Whenever JCT I/O is performed by the JES2 main task, Exit 7 serves the purpose of this exit, and Exit 8 is used whenever a JES2 subtask or a routine running in the user environment performs JCT I/O.

---

### Environment

#### Task

Functional subsystem (HASPFSM). You must specify ENVIRON=FSS on the \$MODULE macro.

#### AMODE/RMODE requirements

RMODE ANY, AMODE 31

#### Supervisor/problem program

JES2 places Exit 25 in supervisor state and PSW key 1.

#### Recovery

No recovery is in effect when this exit is taken. As with every exit, you should provide your own recovery within your exit routine. The \$ESTAE facility is inoperative within the FSS execution environment, rather the MVS ESTAE facility must be used to provide recovery. Also note that the FSS may have recovery routines in effect and that these depend on the FSS implementation.

#### Job exit mask

Exit 25 is subject to suppression. You can suppress Exit 25 by implementing exit 2 to set the 25th bit in the job exit suppression mask (JCTXMASK) or by indicating the exit is disabled in the JES2 initialization stream.

#### Mapping macros normally required

\$HASPEQU, \$HFCT, \$JCT, \$JCTX, ETP, FSIP

---

### Point of processing

This exit is taken from the functional subsystem address space (HASPFSM).

## Exit 25

JES2 gives control to your exit routine after the \$JCT has been read into storage, during \$JIB initialization processing in the FSMGETDS routine of HASPFSSM if the \$JCT read was successful and before initialization of the job separator page area (IAZJSPA) with fields from the \$JCT. The \$JCT read belongs to the job owning the JOE from which data set(s) will be selected for assignment to the FSA through the functional subsystem interface (FSI) GETDS function.

JES2 can also give control to your exit routine just after the FSMGETDS routine in HASPFSSM reads the JCT for the job owning the \$JOE from which a data set will be selected (except if queuing on a setup request) for assignment to a functional subsystem application (FSA).

---

### Programming considerations

1. Be sure your exit routines be in common storage. **Do not linkedit this exit with HASPFSSM.**
2. The \$SAVE and \$RETURN services are available in the FSS environment.
3. The service routines provided in the HASPFSSM module may be used within your exit routine. The cell pool services, \$GETBLK and \$RETBLK can be used to acquire save areas and other predefined storage cells dynamically. You are responsible for returning all storage cells explicitly acquired.
4. **Locating JCT Control Block Extensions**  
You can locate extensions to the job control table (\$JCT) control block from this exit using the \$JCTXGET macro. For example, you can use these extensions to store job-related information. For more information, see *z/OS JES2 Macros*.

---

### Register contents when Exit 25 gets control

The contents of the registers on entry to this exit are:

| Register | Contents  |
|----------|---|
| 0        | A code passed to your routine by JES2             |
| 0        | Indicates that the \$JCT has been read from spool |
| 4        | Indicates that the \$JCT will be written to spool |
| 1        | Address of the \$JCT                              |
| 2-10     | N/A   |
| 11       | Address of the \$HFCT                             |
| 12       | N/A   |
| 13       | Address of an OS-style save area                  |
| 14       | Return address                                    |
| 15       | Entry address                                     |

---

### Register contents when Exit 25 passes control back to JES2

Upon return from this exit, the register contents must be:

| Register | Contents |
|----------|----------|
| 0-13     | N/A      |

- 14 Return address
- 15 Return code

A return code of:

- 0 Tells JES2 that if any additional exit routines are associated with this exit, call the next consecutive exit routine. If no other exit routines are associated with this exit, continue with normal processing, which is determined by the particular exit point from which the exit routine was called.
- 4 Tells JES2 that even if there are additional exit routines associated with this exit, ignore them; continue with normal processing, which is determined by the particular exit point from which the exit routine was called.

---

### Coded example

None provided.



---

## Chapter 38. Exit 26: Termination/resource release

---

### Function

This exit allows you to free resources obtained during previous installation exit routine processing at any JES2 termination. At a JES2 termination (that is, \$P JES2 command, JES2 initialization termination, or an abend), Exit 26 receives control to free whatever resources your exit routines continues to hold. To control the release of resources, this exit permits access to the termination recovery communication area (TRCA) and the HASP communications table (HCT). With such access available, your installation is provided sufficient flexibility to withdraw or free all services and resources you may have previously acquired. This exit can also be used to permit your installation to modify the termination options and edit operator responses to those options.

---

### Environment

#### Task

JES2 main task (Termination) – JES2 dispatcher disabled. You must specify ENVIRON=JES2 on the \$MODULE macro.

#### AMODE/RMODE requirements

RMODE ANY, AMODE 31

#### Supervisor/problem program

JES2 places exit 26 in supervisor state and PSW key 1.

#### Recovery

Exit 26 **is protected** by an ESTAE routine. If an error occurs during Exit 26 processing in your code, the ESTAE issues message \$HASP082 INSTALLATION EXIT 26 ABEND to the operator. The ESTAE provides an SDUMP (if possible), returns control to JES2 termination processing (\$HEXIT), and proceeds with normal termination. If this ESTAE does receive control, JES2 does not permit Exit 26 to receive control again.

#### Job exit mask

This exit point is not subject to job exit mask suppression.

#### Mapping macros normally required

\$ERA, \$HASPEQU, \$HCCT, \$HCT, \$MIT, \$PCE, \$TRCA

---

### Point of processing

This exit is taken from HASPTERM during JES2 termination processing (\$HEXIT).

At JES2 termination, the operator receives the message \$HASP098 ENTER TERMINATION OPTION. Following the operator response but before response processing, this exit gains control. At this time the exit has the option to change the

operator's reply to \$HASP098. Exit processing completes, and on return from the exit, processing continues with the scanning of the operator response to the \$HASP098 message.

---

## Programming considerations

1. Be careful not to free private area storage (for example, the UCT) that might be needed by JES2 termination services after exit 26 processing. PCE tables and DTE tables, and so forth, may see UCT fields and might be needed later by HASPTERM.
2. The \$CADDR (JES2 common storage address table) might not be available when Exit 26 is invoked.

---

## Register contents when Exit 26 gets control

The contents of the registers on entry to this exit are:

| <b>Register</b> | <b>Contents</b>   |
|-----------------|---|
| 0               | A code passed to your routine by JES2                           |
| 0               | Indicates that Exit 26 is invoked for the first time            |
| 4               | Indicates that Exit 26 is invoked for other than the first time |
| 1               | Address of the JES2 main task \$TRCA                            |
| 2-10            | Not applicable  |
| 11              | Address of the \$HCT  |
| 12              | N/A   |
| 13              | Address of the HASPTERM \$PCE                                   |
| 14              | Return address  |
| 15              | Entry address   |

---

## Register contents when Exit 26 passes control back to JES2

Upon return from this exit, the register contents must be:

| <b>Register</b> | <b>Contents</b>  |
|-----------------|--|
| 0               | A code passed to your routine by JES2                                      |
| 0               | Indicates that Exit 26 is invoked for the first time                       |
| 4               | Indicates that Exit 26 is invoked for other than the first time            |
| 1               | Address of the JES2 main task TRCA   |
| 2-10            | Not applicable   |
| 11              | Address of the \$HCT   |
| 12              | Not applicable   |
| 13              | Address of the HASPTERM \$PCE – (this is a special PCE located n HASPTERM) |
| 14              | Return address   |
| 15              | Return code  |



A return code:

- 0 Tells JES2 that if additional exit routines are associated with this exit, call the next consecutive exit routine. If no other exit routines are associated with this exit, continue with normal processing, which is determined by the particular exit point from which the exit routine was called.
- 4 Tells JES2 that even if there are additional exit routines associated with this exit, ignore them; continue with normal processing, which is determined by the particular exit point from which the exit routine was called.

---

## **Coded example**

None provided.



---

## Chapter 39. Exit 27: PCE attach/detach

---

### Function

This exit allows resources to be allocated and deallocated. The exit also allows you to deny a PCE attach.

---

### Environment

#### Task

JES2 main task. You must specify this task on the ENVIRON specification of the \$MODULE macro.

#### AMODE/RMODE requirements

RMODE ANY, AMODE 31

#### Supervisor/problem program

JES2 places exit 27 in supervisor state and PSW key 1.

#### Recovery

\$ESTAE recovery is in effect. However, as with every exit, your exit routine *should not* depend on JES2 for recovery. JES2 cannot anticipate the exact purpose of your exit routine and can therefore provide no more than minimal recovery. Your exit routine should provide its own recovery.

#### Job exit mask

This exit point is not subject to job exit mask suppression.

#### Mapping macros normally required

\$HASPEQU, \$HCT, \$MIT, \$PCE

---

### Point of processing

This exit is taken from HASPDYN either immediately after a PCE has been attached or immediately before a PCE is detached.

---

### Programming considerations

None.

---

### Register contents when Exit 27 gets control

The contents of the registers on entry to this exit are:

#### Register

#### Contents

|   |  |
|---|--|
| 0 | A code passed to your routine by JES2                |
| 0 | Indicates that Exit 27 is invoked after a PCE attach |

## Exit 27

|      |  |
|------|--|
| 4    | Indicates that Exit 27 is invoked before a PCE is detached                               |
| 1    | Pointer to a 1-word parameter list that contains the address of the PCE to be processed. |
| 2-10 | N/A  |
| 11   | Address of the HCT   |
| 12   | N/A  |
| 13   | Address of the PCE currently in control  |
| 14   | The return address   |
| 15   | The entry address  |

---

### Register contents when Exit 27 passes control back to JES2

Upon return from this exit, the register contents must be:

#### Register

#### Contents

|      |                |
|------|----------------|
| 0-13 | Unchanged      |
| 14   | Return address |
| 15   | Return code    |

A return code of:

|   |   |
|---|---|
| 0 | Tells JES2 that if there are additional exit routines associated with this exit, call the next consecutive exit routine. If there are no other exit routines associated with this exit, continue with normal processing, which is determined by the particular exit point from which the exit routine was called. |
| 4 | Tells JES2 that even if there are additional exit routines associated with this exit, ignore them; continue with normal processing, which is determined by the particular exit point from which the exit routine was called.  |
| 8 | Tells JES2 to detach the PCE that was attached immediately before invoking this exit.   |

---

### Coded example

Module HASX27A in SYS1.SHASSAMP contains a sample of Exit 27.

---

## Chapter 40. Exit 28: subsystem interface (SSI) job termination

---

### Function

This exit allows you to free resources (for example, storage for installation control blocks) that were obtained during Exit 32 (SSI Job Selection) processing. You can also use this exit (by changing the response byte) to either suppress the JES2 job termination-related message or replace them with your own installation-defined messages.

---

### Environment

#### Task

User address space. You must specify ENVIRON=USER on the \$MODULE macro.

#### AMODE/RMODE requirements

RMODE ANY, AMODE 31

#### Supervisor/problem program

JES2 places Exit 28 in supervisor state and PSW key 0.

#### Recovery

ESTAE recovery is in effect. However, as with every exit, your exit routine *should not* depend on JES2 for recovery. JES2 cannot anticipate the exact purpose of your exit routine and can therefore provide no more than minimal recovery. Your exit routine should provide its own recovery.

#### Job exit mask

Exit 28 is subject to suppression. You can suppress Exit 28 by either implementing exit 2 to set the 28th bit in the job exit suppression mask (JCTXMASK) or by indicating the exit is disabled in the JES2 initialization stream.

#### Mapping macros normally required

\$HASPEQU, \$HCCT, \$JCT, \$JCTX, \$MIT, \$SJB

---

### Point of processing

This exit is taken from HASCJBST before the freeing of job-related control blocks and the issuing of related messages.

---

### Programming considerations

Changes of security information in the \$JCT could cause a later security validation to fail. These changes could also be a violation of your installation's security policy.

---

## Expanding the JCT control block

You can add, expand, locate, and remove extensions to the job control table (\$JCT) control block from this exit using the \$JCTX macro extension service. For example, you can use these extensions to store job-related information. For more information, see *z/OS JES2 Macros*.

---

## Register contents when Exit 28 gets control

The contents of the registers on entry to this exit are:

### Register

#### Contents

0 0

1 Pointer to a 12-byte parameter list with the following structure:

#### Byte 1 (+0)

A type-of-processing caller indicator, as follows:

0 job termination (JOB, STC, TSU, or XBM)

4 SYSLOG termination (return ID)

8 joblet termination

12 unsuccessful job selection (JOB, STC, TSU unable to obtain resources)

16 unsuccessful request ID JOB (request ID unable to obtain resources)

20 unsuccessful joblet selection (unable to obtain resources)

24 unsuccessful job restart (JOB RENQ unable to obtain resources)

#### Byte 2 (+1)

This byte is not part of the interface

#### Byte 3 (+2)

Response byte

#### Bits 0-6

These bits are not part of the interface

**Bit 7** 0 – indicates that JES2 will issue job termination message (default)

1 – indicates that JES2 will suppress job termination message

#### Byte 4 (+3)

This byte is not part of the interface

#### Byte 5 (+4)

Address of SJB or 0

#### Byte 9 (+8)

Address of JCT or 0

2-10 Not applicable

11 Address of the \$HCCT

|    |                                   |
|----|-----------------------------------|
| 12 | Not applicable                    |
| 13 | Address of an available save area |
| 14 | Return address                    |
| 15 | Entry address                     |

---

## Register contents when Exit 28 passes control back to JES2

Upon return from this exit, the register contents must be:

| Register | Contents       |
|----------|----------------|
| 0-13     | Unchanged      |
| 14       | Return address |
| 15       | Return code    |

A return code of:

- |   |   |
|---|---|
| 0 | Tells JES2 that if there are additional exit routines associated with this exit, call the next consecutive exit routine. If there are no other exit routines associated with this exit, continue with normal processing, which is determined by the particular exit point from which the exit routine was called. |
| 4 | Tells JES2 that even if there are additional exit routines associated with this exit, ignore them; continue with normal processing, which is determined by the particular exit point from which the exit routine was called.  |

---

## Coded example

Module HASXJEA in SYS1.SHASSAMP contains a sample of Exit 28.





---

## Chapter 41. Exit 29: Subsystem interface (SSI) end-of-memory

---

### Function

This exit allows you to free resources in common storage (for example, installation control blocks that were obtained during Exit 32, SSI Job Selection, processing).

You can also use this exit to free resources on an address space level. Because this exit executes in the master scheduler address space, it can only process CSA-resident items.

---

### Environment

#### Task

User address space. You must specify ENVIRON=USER on the \$MODULE macro.

#### AMODE/RMODE requirements

RMODE ANY, AMODE 31

#### Supervisor/problem program

JES2 places exit 29 in supervisor state and PSW key 0.

#### Recovery

ESTAE recovery is in effect. However, as with every exit, your exit routine *should not* depend on JES2 for recovery. JES2 cannot anticipate the exact purpose of your exit routine and can therefore provide no more than minimal recovery. Your exit routine should provide its own recovery.

#### Job exit mask

This exit point is not subject to job exit mask suppression.

#### Mapping macros normally required

\$HASB, \$HASPEQU, \$HCCT, \$MIT, \$SJB

---

### Point of processing

This exit is taken from HASCJBTR before the freeing of CSA job-related control blocks.

---

### Programming considerations

None.

---

### Register contents when Exit 29 gets control

The contents of the registers on entry to this exit are:

| Register | Contents |
|----------|----------|
|----------|----------|

## Exit 29

- 0 Not applicable
- 1 Pointer to an 8-byte parameter list with the following structure:
  - Byte 1 (+0)**  
This byte is not part of the interface
  - Byte 2 (+1)**  
Condition byte
    - Bits 0-6**  
These bits are not part of the interface
    - Bit 7** 0 – normal end-of-memory  
1 – abnormal end-of-memory
  - Byte 3 (+2)**  
This byte is not part of the interface
  - Byte 4 (+3)**  
This byte is not part of the interface
  - Byte 5 (+4)**  
This byte is not part of the interface
  - Byte 6 (+5)**  
This byte is not part of the interface
  - Byte 7 (+6)**  
Address space ID
- 2-10 Not applicable
- 11 Address of \$HCCT
- 12 Not applicable
- 13 Address of an available save area
- 14 Return address
- 15 Entry address

---

## Register contents when Exit 29 passes control back to JES2

| Register | Contents       |
|----------|----------------|
| 0-13     | Unchanged      |
| 14       | Return address |
| 15       | Return code    |

A return code of:

- 0 Tells JES2 that if additional exit routines are associated with this exit, call the next consecutive exit routine. If no other exit routines are associated with this exit, continue with normal processing, which is determined by the particular exit point from which the exit routine was called.
- 4 Tells JES2 that even if additional exit routines are associated with this exit, ignore them; continue with normal processing, which is determined by the particular exit point from which the exit routine was called.

---

## Coded example

Module HASX29A in SYS1.SHASSAMP contains a sample of Exit 29.



---

## Chapter 42. Exit 30: Subsystem interface (SSI) data set OPEN and RESTART

---

### Function

This exit allows you to get control during OPEN and RESTART processing of subsystem interface data sets. An indicator (passed to the exit in register 0) indicates either OPEN or RESTART processing; therefore, this exit can be used for either situation. Further, an indicator (passed in the parameter list pointed to by register 1) indicates the type of data set (SYSIN, SYSOUT, process SYSOUT, SPOOL BROWSE, or an internal reader type).

You can examine the data set characteristics and check them for validity, proper authority, or alter them.

---

### Environment

#### Task

User address space. You must specify ENVIRON=USER on the \$MODULE macro.

#### AMODE/RMODE requirements

RMODE ANY, AMODE 31

#### Supervisor/problem program

JES2 places Exit 30 in supervisor state and PSW key 0.

#### Recovery

ESTAE recovery is in effect.

However, as with every exit, your exit routine *should not* depend on JES2 for recovery. JES2 cannot anticipate the exact purpose of your exit routine and can therefore provide no more than minimal recovery. Your exit routine should provide its own recovery.

#### Job exit mask

Exit 30 is subject to suppression. You can suppress Exit 30 either by implementing exit 2 to set the 30th bit in the job exit suppression mask (JCTXMASK) or by including a statement in the initialization stream that disables Exit 30.

#### Mapping macros normally required

\$HASPEQU, \$HCCT, \$IOT, \$MIT, \$PDDB, \$SJB, DEB, JFCB

---

### Point of processing

This exit is taken from HASCDSOC after the data set has been either OPENed or RESTARTed.

---

## Programming considerations

### Expanding the JCT Control Block

If the address of the \$JCT is contained in field SJB, you can add, expand, locate, or remove extensions to the job control table (\$JCT) control block from this exit using the \$JCTX macro extension service. For example, you can use these extensions to store job-related information. For more information, see *z/OS JES2 Macros*.

---

## Register contents when Exit 30 gets control

The contents of the registers on entry to this exit are:

### Register

#### Contents

- |             |   |
|-------------|---|
| 0           | Type of call indication   |
| 0           | OPEN  |
| 4           | RESTART   |
| 1           | Pointer to an 28-byte parameter list with the following structure:  |
| Byte 1 (+0) | Type of data set being processed  |
| 0           | JOB internal reader   |
| 4           | STC internal reader   |
| 8           | TSU internal reader   |
| 12          | SYSIN data set  |
| 16          | SYSOUT data set   |
| 20          | PROCESS SYSOUT or SYSOUT application program interface (SAPI) data set  |
| 24          | SPOOL BROWSE data set   |
| 28          | Unknown data set type   |
| Byte 2 (+1) | Condition byte  |
| Bits 0-4    | These bits are not part of the interface.   |
| Bit 5       | 0 – user authorization successful<br>1 – user authorization failed  |
| Bit 6       | 0 – no error encountered<br>1 – error encountered   |
| Bit 7       | (applicable to data set OPEN for STC and TSU internal readers only)<br>0 – \$P JES2 not in progress<br>1 – \$P JES2 in progress |
| Byte 3 (+2) | Response byte   |

**bits 0-5**

These bits are not part of the interface.

**bit 6** 0 – open/restart the data set or reader. Default is 0 unless the data set type is unknown or if an error occurred while attempting to open the data set.

1 – fail the OPEN/RESTART processing

**bit 7** 0 – suppress unknown data set message (\$HASP352). Zero is the default for this bit unless the type of data set is unknown.

1 – issue the unknown data set message (\$HASP352)

**Byte 4 (+3)**

This byte is not part of the interface.

**Byte 5 (+4)**

Address of IRWD if internal reader data set (type 0, 4, 8 in byte 1 of parameter list)

Address of SDB if SYSIN, SYSOUT, PROCESS SYSOUT, or SPOOL BROWSE data set (type 12, 16, 20, or 24 in byte 1 of parameter list)

0 if unknown data set file (type 28 in byte 1 of parameter list)

**Byte 9 (+8)**

Address of SJB or 0

**Byte 13 (+12)**

Address of JFCB

**Byte 17 (+16)**

Address of DEB

**Byte 21 (+20)**

0 if internal reader data set (type 0, 4, 8 in byte 1 of parameter list) or if bits 6 and 7 of byte 2 (condition byte) are not 0

Address of PDDB if SYSIN, SYSOUT, PROCESS SYSOUT, or SPOOL BROWSE data set (type 12, 16, 20, or 24 in byte 1 of parameter list)

**Byte 25 (+24)**

0 if internal reader data set (type 0, 4, 8 in byte 1 of parameter list) or if bits 6 and 7 of byte 2 (condition byte) are not 0

Address of IOT if SYSIN, SYSOUT, PROCESS SYSOUT, or SPOOL BROWSE data set (type 12, 16, 20, or 24 in byte 1 of parameter list)

|             |                                   |
|-------------|-----------------------------------|
| <b>2-10</b> | Not applicable                    |
| <b>11</b>   | Address of HCCT                   |
| <b>12</b>   | Not applicable                    |
| <b>13</b>   | Address of an available save area |
| <b>14</b>   | Return address                    |
| <b>15</b>   | Entry address                     |

---

## Register contents when Exit 30 passes control back to JES2

Upon return from this exit, the register contents must be:

## Exit 30

### Register

#### Contents

- |      |                |
|------|----------------|
| 0-13 | Unchanged      |
| 14   | Return address |
| 15   | Return code    |

A return code of:

- |   |   |
|---|---|
| 0 | Tells JES2 that if additional exit routines are associated with this exit, call the next consecutive exit routine. If no other exit routines are associated with this exit, continue with normal processing, which is determined by the particular exit point from which the exit routine was called. |
| 4 | Tells JES2 that even if additional exit routines are associated with this exit, ignore them; continue with normal processing, which is determined by the particular exit point from which the exit routine was called.  |

---

## Coded example

Module HASXOCA in SYS1.SHASSAMP contains a sample of Exit 30.



---

## Chapter 43. Exit 31: Subsystem interface (SSI) allocation

---

### Function

This exit allows you to receive control during allocation of subsystem interface data sets and internal readers. During allocation processing, JES2 can affect subsystem data set characteristics. This exit allows an installation to control how JES2 will process installation-specified statements and parameters during this processing phase.

---

### Environment

#### Task

User address space. You must specify ENVIRON=USER on the \$MODULE macro.

#### AMODE/RMODE requirements

RMODE ANY, AMODE 31

#### Supervisor/problem program

JES2 places exit 31 in supervisor state and PSW key 0.

#### Recovery

ESTAE recovery is in effect. However, as with every exit, your exit routine *should not* depend on JES2 for recovery. JES2 cannot anticipate the exact purpose of your exit routine and can therefore provide no more than minimal recovery.

#### Job exit mask

Exit 31 is subject to suppression. You can suppress Exit 31 either by implementing exit 2 to set the 31st bit in the job exit suppression mask (JCTXMASK) or by indicating Exit 31 is disabled in the initialization stream.

#### Mapping macros normally required

\$HASPEQU, \$HCCT, \$IOT, \$MIT, \$PDDB, \$SJB, JFCB

---

### Point of processing

This exit is taken from HASCDSAL after allocation processing but before return to the SSI caller.

---

### Programming considerations

The following are programming considerations for Exit 31.

1. You can determine whether Exit 31 was invoked on behalf of a transaction program or batch job by either:
  - Determining if flag SJBFLGA is set to SJBATP
  - Determining if the IOT contains a DSCT
2. Expanding the JCT Control Block:

## Exit 31

If the address of the \$JCT is contained in field SBJCT, you can add, expand, locate, or remove extensions to the job control table (\$JCT) control block from this exit using the \$JCTX macro extension service. For example, you can use these extensions to store job-related information. For more information, see *z/OS JES2 Macros*.

---

### Register contents when Exit 31 gets control

The contents of the registers on entry to this exit are:

#### Register

##### Contents

0 Pointer to a parameter list with the following structure, mapped by \$XPL:

##### Field Name

##### Description

##### XPLID

Eyecatcher

##### XPLLEVEL

Version level of the base XPL

##### XPLXLEV

Version number for the exit

##### XPLXITID

Exit ID number

##### X031ID

Indicator byte

##### X031COND

Condition byte

##### X031ERR

Allocation error

##### X031RESP

Response byte

##### X031FAIL

Fail the allocation request

##### X031DSTY

Type of the data set being processed

##### X031INTR

Internal reader

##### X031JSNW

JESNEWS data set

##### X031SYIN

SYSIN data set

##### X031SYSO

SYSOUT data set

##### X031PSPI

Process SYSOUT (PSO) or SYSOUT application program interface (SAPI) data set

**X031SDSB**

SPOOL browse data set

**X031UNK**

Unknown data set type

**X031SDB**

- Address of SDB - if data set type is X031JSNW, X031SYIN, X031SYSO, X031PSPI, or X031SDSB
- Address of IRWD - if data set type is internal reader data set (X031INTR)
- 0 - if data set type is unknown data set type (X031UNK)

**X031SJB**

Address of SJB or 0. The value is 0 in the following conditions:

- There is an error in obtaining SJB address.
- The data set is a started task or the TSO/E internal reader.
- The automatic restart manager allocates an internal reader.

**X031JFCB**

Address of JFCB

**X031PDDB**

Address of PDDB or zero

**X031IOT**

Address of IOT or zero

|      |  |
|------|--|
| 1    | Pointer to type of data set being processed (X031DSTY) |
| 2-10 | N/A  |
| 11   | Address of HCCT  |
| 12   | N/A  |
| 13   | Address of an available save area                      |
| 14   | The return address                                     |
| 15   | The entry address                                      |

---

## Register contents when Exit 31 passes control back to JES2

Upon return from this exit, the register contents must be:

**Register****Contents**

|      |                |
|------|----------------|
| 0-13 | Unchanged      |
| 14   | Return address |
| 15   | Return code    |

A return code of:

|   |   |
|---|---|
| 0 | Tells JES2 that if additional exit routines are associated with this exit, call the next consecutive exit routine. If no other exit routines are associated with this exit, continue with normal processing, which is determined by the particular exit point from which the exit routine was called. |
| 4 | Tells JES2 that even if additional exit routines are associated with this exit,   |

## Exit 31

ignore them; continue with normal processing, which is determined by the particular exit point from which the exit routine was called.

---

### **Coded example**

Module HASX31A in SYS1.SHASSAMP contains a sample Exit 31.

---

## Chapter 44. Exit 32: Subsystem interface (SSI) job selection

---

### Function

This exit allows you to receive control during job selection processing. You can perform job-related processing such as allocating resources and I/O for installation-defined control blocks. Also, this exit can be used to suppress job selection related messages and replace them with installation-defined messages. Such messages can indicate, for example, that a job is “not to be selected for execution” and “the initiators were terminated”.

---

### Related exits

Use Exit 28 (SSI Job Termination) and Exit 29 (SSI End-of-Memory) with Exit 32 to perform job termination processing.

---

### Environment

#### Task

User address space. You must specify ENVIRON=USER on the \$MODULE macro.

#### AMODE/RMODE requirements

AMODE 31, RMODE ANY

#### Supervisor/problem program

JES2 places Exit 32 in supervisor state and PSW key 0.

#### Recovery

ESTAE recovery is in effect. However, as with every exit, your exit routine *should not* depend on JES2 for recovery. JES2 cannot anticipate the exact purpose of your exit routine and can therefore provide no more than minimal recovery. Your exit routine should provide its own recovery.

#### Job exit mask

Exit 32 is subject to suppression. You can suppress Exit 32 by either implementing exit 2 to set the 32nd bit in the job exit suppression mask (JCTXMASK) or by indicating the exit is disabled in the JES2 initialization stream.

#### Mapping macros normally required

\$HASPEQU, \$HCCT, \$JCT, \$JCTX, \$MIT, \$SJB

---

### Point of processing

This exit is taken from HASCJBST following job selection but before the issuing of the \$HASP373 JOBID \$HASP373 jobname STARTED message.

---

## Programming considerations

### Expanding the JCT Control Block

You can add, expand, locate, or remove extensions to the job control table (\$JCT) control block from this exit using the \$JCTX macro extension service. For example, you can use these extensions to store job-related information. For more information, see *z/OS JES2 Macros*.

---

## Register contents when Exit 32 gets control

|  |   |  |
|--|---|--|
|  | 0 | The address of a parameter list, mapped by the \$XPL:        |
|  |   | <b>Field Name</b>  |
|  |   | <b>Description</b>   |
|  |   | <b>XPLID</b>   |
|  |   | Eyecatcher   |
|  |   | <b>XPLLEVEL</b>  |
|  |   | Indicates the version number of Exit 32                      |
|  |   | <b>XPLXITID</b>  |
|  |   | Exit identifier - 32   |
|  |   | <b>XPLEXLEV</b>  |
|  |   | Version level of the exit                                    |
|  |   | <b>X032PLUS</b>  |
|  |   | Exit 32 parameter list (register 1 points here)              |
|  |   | <b>X032IND</b>   |
|  |   | Indicator byte   |
|  |   | <b>X032IRJI</b>  |
|  |   | Request Job Id   |
|  |   | <b>X032IRCL</b>  |
|  |   | Request Job by class   |
|  |   | <b>X032ITSU</b>  |
|  |   | TSU  |
|  |   | <b>X032ISTC</b>  |
|  |   | STC  |
|  |   | <b>X032IWLM</b>  |
|  |   | Work Load Manager (not demand select)                        |
|  |   | <b>X032IWLD</b>  |
|  |   | Work Load Manager (demand select)                            |
|  |   | <b>X032COND</b>  |
|  |   | Condition byte   |
|  |   | <b>X032CIOE</b>  |
|  |   | I/O error during job select (will be terminated or requeued) |
|  |   | <b>X032RESP</b>  |
|  |   | Response byte  |
|  |   | <b>X032RHLD</b>  |
|  |   | Hold job (Bit ignored if X032RBEG and X032RVIC off)          |

**X032RBEG**

Restart job from first step. Bit is ignored when X032RTJB is off or X032CIOE is on. A job restarted from the first step is no longer able to restart at an eviction point.

**X032RVIC**

Restart job from its eviction point, if any. Bit is ignored when X032RTJB is off or X032CIOE is on. If X032RBEG is also on, X032RVIC is ignored.

If there is no eviction point, the job is restarted from the first step.

Eviction point is the point that an executing job was interrupted either because of a checkpoint/restart scenario or a \$EJnnn,STEP command.

**X032RTIN**

Terminate initiator

This bit is ignored unless the X032IND byte is X032IRCL, (for example, initiator can't be terminated unless it is selecting work by class). The initiator will stop after the job currently being processed has executed or been terminated and queued for restart. If both bit X032RTIN and X032RTID are on, X032RTID will be honored.

**X032RTID**

Terminate and drain initiator

The initiator will not be automatically restarted. This bit is ignored unless the X032IND byte is X032IRCL (for example, initiator cannot be terminated unless it is selecting work by class). The initiator will stop after the job currently being processed has executed or been terminated and queued for restart. If both bit X032RTIN and X32RTID are on, X032RTID will be honored.

**X032RTJB**

Do not select job indicator.

This bit is ignored if X032CIOE bit is on in X032COND (for example, job cannot be selected if there is an error).

**X032RNMG**

Suppress job select message

This bit is ignored if X032CIOE bit is on in X032COND (for example, job select message will not be issued if there is an error). This bit will also be ignored if the caller is request-job-id, X032IRJI in X032IND. There is no job log for a request-job-id caller.

**X032SJB**

Address of SJB

**X032JCT**

Address of JCT or 0

- 1 Points into this area for compatibility with existing exits that do not understand the structure. Pointer to an 12-byte parameter list with the following structure:

**Byte 1 (+0)**

Type of processing indicator

0 Reserved

## Exit 32

- 4 Request for job by SYSLOG ID
- 8 Request for job by class
- 12 TSU
- 16 STC
- 20 WLM batch job
- 24 WLM batch job (via \$S J)

### Byte 2 (+1)

Condition byte

#### bits 0-6

These bits are not part of the interface

- bit 7 0 – no error occurred during processing (job selectable for execution)

)

1 – error occurred during job select processing (job is to be restarted or terminated)

### Byte 3 (+2)

Response byte

- bit 0 These bits is not part of the interface

- bit 1 0 – Do not hold job

1 – Hold job

This bit is valid only if bit 2 or bit 3 is on.

**Note:** Bit is ignored if Bit 6 is off

- bit 2 0 – Do not restart job from first step

1 – Restart job from first step

**Note:** Bit is ignored if Bit 6 is off

**Note:** Job no longer able to restart from eviction point if bit is on.

**Note:** If both bits 2 and 3 are on, bit 3 is ignored.

- bit 3 0 – Do not restart job from eviction point

1 – Restart job from eviction point. If there is no eviction point, the job is restarted from the first step.

Eviction point is the point that an executing job was interrupted either because of a checkpoint/restart scenario or a \$EJnnn,STEP command.

**Note:** Bit is ignored if Bit 6 is off

**Note:** Job no longer able to restart from eviction point if bit is on.

**Note:** If both bits 2 and 3 are on, bit 3 is ignored.



- bit 4** 0 – initiator is not abnormally ended (default)  
1 – initiator is abnormally ended, then restarted automatically.
- bit 5** 0 – initiator is not abnormally ended (default)  
1 – initiator is abnormally ended

**Note:**

1. If you specify both bits 4 and 5, the initiator is not automatically ended and drained.
2. The initiator will stop after the job currently being processed has been terminated/queued for RESTART.
3. This bit is ignored unless the type of processing is a job request by class (R1, byte 1 = 8)

- bit 6** 0 – select this job (default)  
1 – terminate this job

**Note:** This bit is ignored if the condition byte (byte 2) is nonzero

- bit 7** 0 – issue the JES2 job selection (\$HASP373) message  
1 – suppress the JES2 job selection (\$HASP373) message

**Note:** This bit is ignored if the condition byte (byte 2) is nonzero

**Byte 4 (+3)**

This byte is not part of the interface

**Byte 5 (+4)**

Address of SJB

**Byte 9 (+8)**

Address of JCT or 0

|      |                                   |
|------|-----------------------------------|
| 2-10 | N/A                               |
| 11   | Address of HCCT                   |
| 12   | N/A                               |
| 13   | Address of an available save area |
| 14   | Return address                    |
| 15   | Entry address                     |

---

## Register contents when Exit 32 passes control back to JES2

|      |                |
|------|----------------|
| 0-13 | Unchanged      |
| 14   | Return address |
| 15   | Return code    |

A return code of:

- 0** Tells JES2 that if additional exit routines are associated with this exit, call the next consecutive exit routine. If no other exit routines are associated

## Exit 32

with this exit, continue with normal processing, which is determined by the particular exit point from which the exit routine was called.

- 4 Tells JES2 that even if additional exit routines are associated with this exit, ignore them; continue with normal processing, which is determined by the particular exit point from which the exit routine was called.

---

## Coded example

Module HASX32A in SYS1.SHASSAMP contains a sample of Exit 32.

---

## Chapter 45. Exit 33: Subsystem interface (SSI) data set CLOSE

---

### Function

This exit allows you to receive control during subsystem data set CLOSE processing. You can examine the data set characteristics and check them for validity, authority, or alter the characteristics. An indicator, passed to this exit in the parameter list pointed to by register 1, indicates the type of data set.

---

### Related exits

Use Exit 30 (SSI Data Set OPEN and RESTART) in conjunction with Exit 33 to perform required data set OPEN and RESTART processing.

---

### Environment

#### Task

User address space. You must specify ENVIRON=USER on the \$MODULE macro.

#### AMODE/RMODE requirements

RMODE ANY, AMODE 31

#### Supervisor/problem program

JES2 places Exit 33 in supervisor state and PSW key 0.

#### Recovery

ESTAE recovery is in effect. However, as with every exit, your exit routine *should not* depend on JES2 for recovery. JES2 cannot anticipate the exact purpose of your exit routine and can therefore provide no more than minimal recovery. Your exit routine should provide its own recovery.

#### Job exit mask

Exit 33 is subject to suppression. You can suppress Exit 33 by setting the 33rd bit in the job exit suppression mask (JCTXMASK) or by indicating Exit 33 is disabled in the initialization stream.

#### Mapping macros normally required

\$DCT, \$HASPEQU, \$HCCT, \$IOT, \$MIT, \$PDDB, \$SDB, \$SJB, DEB, JFCB

---

### Point of processing

This exit is taken from HASCDSOC before the CLOSE of the subsystem data set.

---

## Programming considerations

### Expanding the JCT Control Block

If the address of the \$JCT is contained in field SBJCT, you can add, expand, locate, or remove extensions to the job control table (\$JCT) control block from this exit using the \$JCTX macro extension service. For example, you can use these extensions to store job-related information. For more information, see *z/OS JES2 Macros*.

---

## Register contents when Exit 33 gets control

The contents of the registers on entry to this exit are:

### Register

#### Contents

0 N/A

1 Pointer to a 25-byte parameter list with the following structure:

#### Byte 1 (+0)

Type of data set indicator

0 JOB internal reader

4 STC internal reader

8 TSU internal reader

12 SYSIN data set

16 SYSOUT data set

20 PROCESS SYSOUT data set

24 SPOOL BROWSE data set

28 Unknown data set type

#### Byte 2 (+1)

Condition byte

#### bits 0-6

These bits are not part of the interface

**bit 7** 0 – no error occurred during CLOSE processing

1 – error occurred during CLOSE processing

#### Byte 3 (+2)

Response byte

#### bits 0-5

These bits are not part of the interface

**bit 6** 0 – CLOSE the data set or internal reader (default, unless data set type unknown, byte 1 = 28)

1 – fail CLOSE processing

**bit 7** 0 – suppress the JES2 unknown data set type (\$HASP3) message (default, unless data set type unknown, byte 1 = 28)

1 – issue the JES2 unknown data set type (\$HASP3) message

**Byte 4 (+3)**

This byte is not part of the interface

**Byte 5 (+4)**

- Address of IRWD - if data set type is internal reader (byte 1 = 0, 4, or 8)
- Address of SDB - if data set type is SYSIN, SYSOUT, PROCESS SYSOUT, SPOOL BROWSE, unknown data set (byte 1 = 12, 16, 20, 24, or 28) or 0

**Byte 9 (+8)**

Address of SJB or 0

**Byte 13 (+12)**

Address of JFCB

**Byte 17 (+16)**

Address of DEB

**Byte 21 (+20)**

0 if data set type is internal reader (byte 1 = 0, 4, or 8) or if byte 2 is nonzero

Address of PDDb if data set type is SYSIN, SYSOUT, PROCESS SYSOUT, SPOOL BROWSE data set, or unknown (byte 1 = 12, 16, 20, 24, or 28)

**Byte 25 (+24)**

0 if data set type is internal reader (byte 1 = 0, 4, or 8) or if bit 7 of byte 2 is nonzero

Address of IOT if data set type is SYSIN, SYSOUT, PROCESS SYSOUT, SPOOL BROWSE data set, or unknown (byte 1 = 12, 16, 20, 24, 28)

|      |                                   |
|------|-----------------------------------|
| 2-10 | N/A                               |
| 11   | Address of HCCT                   |
| 12   | N/A                               |
| 13   | Address of an available save area |
| 14   | The return address                |
| 15   | The entry address                 |

---

## Register contents when Exit 33 passes back control to JES2

Upon return from this exit, the register contents must be:

| Register | Contents       |
|----------|----------------|
| 0-13     | Unchanged      |
| 14       | Return address |
| 15       | Return code    |

A return code of:

|   |   |
|---|---|
| 0 | Tells JES2 that if additional exit routines are associated with this exit, call the next consecutive exit routine. If no other exit routines are associated |
|---|---|

## Exit 33

with this exit, continue with normal processing, which is determined by the particular exit point from which the exit routine was called.

- 4 Tells JES2 that even if additional exit routines are associated with this exit, ignore them; continue with normal processing, which is determined by the particular exit point from which the exit routine was called.

---

## Coded example

Module HASXOCA in SYS1.SHASSAMP contains a sample of Exit 33.

---

## Chapter 46. Exit 34: Subsystem interface (SSI) data set unallocation

---

### Function

This exit allows you to receive control during unallocation processing of subsystem interface data sets and internal readers.

---

### Related exits

Use Exit 34 in conjunction with Exit 31 (SSI Data Set Allocation) to perform required data set unallocation processing.

---

### Environment

#### Task

User address space. You must specify ENVIRON=USER on the \$MODULE macro.

#### AMODE/RMODE requirements

RMODE ANY, AMODE 31

#### Supervisor/problem program

JES2 places Exit 34 in supervisor state and PSW key 0.

#### Recovery

ESTAE recovery is in effect. However, as with every exit, your exit routine *should not* depend on JES2 for recovery. JES2 cannot anticipate the exact purpose of your exit routine and can therefore provide no more than minimal recovery. Your exit routine should provide its own recovery.

#### Job exit mask

Exit 34 is subject to suppression. You can suppress Exit 34 by either implementing exit 2 to set the 34th bit in the job exit suppression mask (JCTXMASK) or by indicating the exit is disabled in the JES2 initialization stream.

#### Mapping macros normally required

\$DCT, \$HASPEQU, \$HCCT, \$IOT, \$MIT, \$PDDB, \$SDB, \$SJB, JFCB

---

### Point of processing

This exit is taken from HASCDSAL before the processing to unallocate the data set.

---

### Programming considerations

When this exit routine returns control to JES2, JES2 updates certain characteristics of the data set being allocated with information in the SSOB extension, eliminating any changes you might have made to the PDDB in this exit. To have a permanent effect, you should make any changes to the data set characteristics in the SSOB extensions.

## Expanding the JCT Control Block

If the address of the \$JCT is contained in field SBJCT, you can add, expand, locate, or remove extensions to the job control table (\$JCT) control block from this exit using the \$JCTX macro extension service. For example, you can use these extensions to store job-related information. For more information, see *z/OS JES2 Macros*.

---

## Register contents when Exit 34 gets control

The contents of the registers on entry to this exit are:

### Register

#### Contents

0 0

1 Pointer to a 24-byte parameter list with the following structure:

#### Byte 1 (+0)

Type of data set indicator

0 Internal reader

4 JESNEWS data set

8 SYSIN data set

12 SYSOUT data set

16 PROCESS SYSOUT or SYSOUT application program interface (SAPI) data set

20 SPOOL BROWSE data set

24 Unknown data set type

#### Byte 2 (+1)

Condition byte

#### bits 0-5

These bits are not part of the interface

**bit 6** 0 – no error occurred during allocation processing

1 – error occurred during allocation processing

**bit 7** 0 – no error occurred during unallocation processing

1 – error occurred during unallocation processing

#### Byte 3 (+2)

This byte is not part of the interface

#### Byte 4 (+3)

This byte is not part of the interface

#### Byte 5 (+4)

This byte is

- Address of IRWD - if data set type is internal reader (byte 1 = 0)
- Address of SDB - if data set type is SYSIN, SYSOUT, PROCESS SYSOUT, or SPOOL BROWSE data set (byte 1 = 8, 12, 16, or 20)
- 0- if unknown data set type (byte 1 = 24)

#### Byte 9 (+8)

Address of SJB or 0. This value is 0:



- If error in obtaining SJB address,
- If data set is a started task or TSO/E internal reader, or
- When the automatic restart manager unallocates an internal reader.

**Byte 13 (+12)**

Address of JFCB

**Byte 17 (+16)**

Address of PDDB

0 – if data set type is a regular internal reader, an unknown data set type (byte 1 = 0 or 24), or if the PSO unallocation was performed after the JOB-step TCB ended.

**Byte 21 (+20)**

Address of IOT

0 – if data set type is a regular internal reader or unknown data set type (byte 1 = 0 or 24)

|      |                                   |
|------|-----------------------------------|
| 2-10 | N/A                               |
| 11   | Address of HCCT                   |
| 12   | N/A                               |
| 13   | Address of an available save area |
| 14   | The return address                |
| 15   | The entry address                 |

---

## Register contents when Exit 34 passes control back to JES2

Upon return from this exit, the register contents must be:

**Register****Contents**

|      |                |
|------|----------------|
| 0-13 | Unchanged      |
| 14   | Return address |
| 15   | Return code    |

A return code of:

|   |   |
|---|---|
| 0 | Tells JES2 that if additional exit routines are associated with this exit, call the next consecutive exit routine. If no other exit routines are associated with this exit, continue with normal processing, which is determined by the particular exit point from which the exit routine was called. |
| 4 | Tells JES2 that even if additional exit routines are associated with this exit, ignore them; continue with normal processing, which is determined by the particular exit point from which the exit routine was called.  |

---

## Coded example

Module HASX34A in SYS1.SHASSAMP contains a sample of Exit 34.



---

## Chapter 47. Exit 35: Subsystem interface (SSI) end-of-task

---

### Function

This exit allows you to free resources at the task level during end-of-task processing.

---

### Environment

#### Task

User address space. You must specify ENVIRON=USER on the \$MODULE macro.

#### AMODE/RMODE requirements

RMODE ANY, AMODE 31

#### Supervisor/problem program

JES2 places Exit 35 in supervisor state and PSW key 0.

#### Recovery

ESTAE recovery is in effect. However, as with every exit, your exit routine *should not* depend on JES2 for recovery. JES2 cannot anticipate the exact purpose of your exit routine and can therefore provide no more than minimal recovery. Your exit routine should provide its own recovery.

#### Job exit mask

This exit point is not subject to job exit mask suppression.

#### Mapping macros normally required

\$HASB, \$HASPEQU, \$HCCT, \$MIT, \$SJB

---

### Point of processing

This exit is taken from HASCJBTR after JES2 has located and locked the SJB (subsystem job block).

---

### Programming considerations

#### Expanding the JCT Control Block

If the address of the \$JCT is contained in field SBJCT, you can add, expand, locate, or remove extensions to the job control table (\$JCT) control block from this exit using the \$JCTX macro extension service. For example, you can use these extensions to store job-related information. For more information, see *z/OS JES2 Macros*.

---

### Register contents when Exit 35 gets control

The contents of the registers on entry to this exit are:

## Exit 35

| Register | Contents   |
|----------|--|
| 0        | 0  |
| 1        | Pointer to a 20-byte parameter list with the following structure:<br><b>Byte 1 (+0)</b><br>This byte is not part of the interface<br><b>Byte 2 (+1)</b><br>Condition byte<br><b>bits 0-6</b><br>These bits are not part of the interface<br><b>bit 7</b> 0 – task ended normally<br>1 – task ended abnormally<br><b>Byte 3 (+2)</b><br>This byte is not part of the interface<br><b>Byte 4 (+3)</b><br>This byte is not part of the interface<br><b>Byte 5 (+4)</b><br>This byte is not part of the interface<br><b>Byte 6 (+5)</b><br>This byte is not part of the interface<br><b>Byte 7 (+6)</b><br>Address space ID<br><b>Byte 11 (+8)</b><br>Address of SJB<br><b>Byte 13 (+12)</b><br>Address of primary IOT or 0<br><b>Byte 17 (+16)</b><br>Address of JCT or 0 |
| 2-10     | N/A  |
| 11       | Address of HCCT  |
| 12       | N/A  |
| 13       | Address of an available save area  |
| 14       | The return address   |
| 15       | The entry address  |

---

### Register contents when Exit 35 passes control back to JES2

Upon return from this exit, the register contents must be:

| Register | Contents       |
|----------|----------------|
| 0-13     | Unchanged      |
| 14       | Return address |
| 15       | Return code    |

A return code:

- 0 Tells JES2 that if additional exit routines are associated with this exit, call the next consecutive exit routine. If no other exit routines are associated with this exit, continue with normal processing, which is determined by the particular exit point from which the exit routine was called.
- 4 Tells JES2 that even if additional exit routines are associated with this exit, ignore them; continue with normal processing, which is determined by the particular exit point from which the exit routine was called.

---

## **Coded example**

Module HASXJEA in SYS1.SHASSAMP contains a sample of Exit 35.



---

## Chapter 48. Exit 36: Pre-security authorization call

---

### Function

This exit allows you to modify information passed to the security authorization facility (SAF) of MVS. \$SEAS invokes this exit just before passing control to SAF. You can:

- Bypass the default SAF call and perform your own security checking.
- Do additional security checking besides what SAF provides.
- Pass your own return and reason code to the invoker in place of the standard SAF return code.
- Pass information from JES2 to the security subsystem.
- Disable specific SAF security checking.

---

### Environment

#### Task

USER environment. You must specify ENVIRON=USER on the \$MODULE macro.

#### AMODE/RMODE requirements

RMODE ANY, AMODE 31

#### Supervisor/problem program

JES2 places Exit 36 in supervisor state and PSW key 0.

#### Recovery

Recovery for this exit depends on the environment that invokes the exit:

##### Main task

If general purpose subtasks are attached then the subtask ESTAE is in effect. If no general purpose subtasks are attached and you specified UNCOND=YES, then the \$SUBIT \$ESTAE is in effect.

**FSS** ESTAE recovery is in effect.

**USER** JES2 fails the request and SSI \$ESTAE recovery is in effect.

However, as with every exit, your exit routine *should not* depend on JES2 for recovery. JES2 cannot anticipate the exact purpose of your exit routine and can therefore provide no more than minimal recovery. Your exit routine should provide its own recovery.

#### Job exit mask

Table 9 on page 256 shows which function codes are subject to job mask suppression. (See the register one byte that is mapped by X036IND in "Register Contents when Exit 36 Gets Control".)

#### Mapping macros normally required

\$HASPEQU, \$HCCT, \$WAVE, \$XPL

## Point of processing

JES2 takes this exit before issuing the SAF call.

## Programming considerations

- Use care when changing or restricting the functions that build, obtain, or extract information for tokens because you could cause later SAF calls to fail.
- If you need a finer level of control you will have to build more specific entity names in this exit. For example, if you want only certain operators to change the routing of a printer:
  - Define a more specific profile to RACF. For example, if you wanted to keep operators from changing the routing of jobs on JESC, you would define a profile named:
 

```
JESC.MODIFY.JOBOUT.ROUTE
```

with only the operators you want to issue the command on the list of userids authorized to the command.
  - Intercept the command authorization call in Exit 36.
  - In Exit 36, scan the command and build the required profile name. The address of the command and the profile JES2 is requesting authorization for is in the \$WAVE.
  - Replace the entity name (profile name) pointed to by the \$WAVE with the more specific entity name.
  - If you code Exit 36 or Exit 37, you can pass a RACF request type to the exit. JES2 can request a branch entry extract to extract information from SECLABEL profiles (WAVREQST field set to WAVRXTRB). In addition, JES2 also uses the RACF extract (non-branch entry) to extract SECLABELs from various other profiles (WAVREQST field set to WAVRXTRT). New function codes (38 and 39) are defined for all these requests; see Table 9.
- **Locating Extensions to the JCT Control Block:** You can use the \$JCTXGET macro to locate extensions to the job control table (\$JCT) control block from this exit.
- If you need to pass information from JES2 to the security subsystem, move the JCT pointer from the \$SAFINFO parameter list (SFIJCT) to the SAF parameter list (ICHSAFP) in field SAFPUSRW to access the SAF router exit.
- If you include code (such as a branch table) based on the security function codes presented in Table 9 be certain you also see the source of these function codes contained in macro \$HASPEQU for their current and complete listing.

Table 9. Security Function Codes

| Function Code |               |   |                        |             |
|---------------|---------------|---|------------------------|-------------|
| Decimal Value | Symbolic Name | Meaning   | Related Control Block* | Job Masking |
| 0             | \$SEANJES     | Reserved for user code                            |                        | No          |
| 1             | \$SEAINIT     | Initialize security environment                   | SFI                    | Yes         |
| 2             | \$SEAVERC     | Security environment create                       | JCT                    | Yes         |
| 3             | \$SEAVERD     | Security environment delete                       | JCT                    | Yes         |
| 4             | \$SEAXTRT     | Extract security information for this environment | SJB                    | **          |



Table 9. Security Function Codes (continued)

| Function Code |               |  |                        |             |
|---------------|---------------|--|------------------------|-------------|
| Decimal Value | Symbolic Name | Meaning  | Related Control Block* | Job Masking |
| 5             | \$SEASIC      | SYSIN data set create  | IOT                    | Yes         |
| 6             | \$SEASOC      | SYSOUT data set create   | IOT                    | Yes         |
| 7             | \$SEASIP      | SYSIN data set open  | SDB                    | Yes         |
| 8             | \$SEASOP      | SYSOUT data set open   | SDB                    | Yes         |
| 9             | \$SEAPSO      | Process SYSOUT data set open   | SDB                    | Yes         |
| 10            | \$SEAPSS      | Process SYSOUT data set select   | PSO                    | No          |
| 11            | \$SEATCAN     | TSO/E cancel   | JCT                    | No          |
| 12            | \$SEACMD      | Command authorization  | None                   | No          |
| 13            | \$SEAPRT      | Printer data set select  | PDDDB                  | Yes         |
| 14            | \$SEADEL      | Data set purge   | IOT                    | **          |
| 15            | \$SEANUSE     | Notify user token extract  | None                   | No          |
| 16            | \$SEATBLD     | Token build  | SFI                    | Yes         |
| 17            | \$SEARJES     | RJE signon, NJE source for command authorization                                 | SWEL                   | No          |
| 18            | \$SEADEVA     | Device authorization   | PCE                    | **          |
| 19            | \$SEANJEA     | NJE SYSOUT data set create   | SFI                    | Yes         |
| 20            | \$SEAREXT     | Re-verify token extract  | JCT                    | Yes         |
| 21            | ---           | Reserved   | None                   |             |
| 22            | \$SEANEWS     | Update of JESNEWS  | SJB                    | No          |
| 23            | \$SEANWBL     | Build JESNEWS token  | IOT                    | No          |
| 24            | \$SEAVERS     | Subtask to create access control environment element (ACEE) for general subtasks | None                   | No          |
| 25            | \$SEAAUD      | Audit for job in error   | None                   | No          |
| 26            | \$SEADCHK     | Authorization for \$DESTCHK  | DCW                    | No          |
| 27            | \$SEATSOC     | SYSOUT data set create for trace   | IOT                    | No          |
| 28            | \$SEASSOC     | SYSOUT data set create for system job data sets (for example, JOBLG)             | SFI                    | Yes         |
| 29            | \$SEANSOC     | SYSOUT data set create for JESNEWS   | IOT                    | Yes         |
| 30            | \$SEASOX      | Transmit or offload of SYSOUT  | PCE                    | Yes         |
| 31            | \$SEANJEV     | VERIFYX for receive or reload of SYSOUT  | SFI                    | Yes         |
| 32            | \$SEAJOX      | Transmit or offload of job   | PCE                    | Yes         |
| 33            | ---           | Reserved   | None                   |             |
| 34            | \$SEASPBO     | Spool browse data set open   | SDB                    | Yes         |
| 35            | \$SEASFSS     | Scheduler service, TOKNXTR   | SSW                    | No          |
| 36            | \$SEASSWM     | SWM modify ALTER AUTH  | None                   | No          |
| 37            | \$SEASAPI     | SYSOUT application programming interface   | None                   | No          |

## Exit 36

Table 9. Security Function Codes (continued)

| Function Code |               |  |                        |             |
|---------------|---------------|--|------------------------|-------------|
| Decimal Value | Symbolic Name | Meaning  | Related Control Block* | Job Masking |
| 38            | \$SEASCLA     | SECLABEL affinity extract                            | JQE                    | No          |
| 39            | \$SEASCLE     | DCT SECLABEL extract                                 | DCT or NIT             | No          |
| 40            | \$SEANSON     | Secure NJE signon SAF profiles for secure NJE signon | None                   | No          |
| 41            | \$SEADIRA     | SECLABEL dominance                                   | None                   | No          |
| 42            | \$SEASPLR     | SPOOL I/O AUTH check                                 | None                   | No          |
| 43-255        | ---           | Not currently in use                                 | Not in use             |             |

### Note:

- \* Your exit routine should always check for the presence of the control block before using fields in the control block. Currently, the control block is not present when the \$SEAXTRT function occurs during an open of TSU or STC internal readers.
- \*\* Job exit mask suppression not in effect during selected processing.

---

## Register contents when Exit 36 gets control

The contents of the registers on entry to this exit are:

### Register

#### Contents

0 N/A

1 Pointer to a parameter list with the following structure, mapped by \$XPL:

#### Field Name

#### Description

#### XPLID

The eyecatcher

#### XPLLEVEL

The version level of \$XPL

#### XPLXITID

The exit ID number

#### X036IND

Indicator byte that contains the function code (value of FUNCODE=) passed by \$SEAS. See Table 9 on page 256 for these function codes and their meanings.

#### X036COND

Condition byte showing the type of code that invoked the exit.

#### X036JES2

IBM-supplied code (CODER=JES2 on \$SEAS).

#### X036USER

Customer-written code (CODER=USER on \$SEAS).

**X036RESP**

Response byte you set to have the following meanings:

**X036NORC**

Setting this bit on in the response byte indicates that the exit-specified return and reason codes will be used. Otherwise, the SAF return code and reason code will be used.

**Note:** If you set this bit to a 1, you must make sure SAF will recognize any changes you make.

**X036BYP**

If this bit is turned on, the call to SAF is bypassed. Otherwise, the authorization request is passed to SAF.

**X036PARM**

Address of the parameter list, in the Work Access Verification Element (\$WAVE), to pass to SAF. This address allows you to alter any parameters contained in the parameter list. However, do not change the address in this fullword field as SAF will not get the expected parameters.

**X036WAVE**

Address of the \$WAVE. This address allows you to alter any information contained in the \$WAVE. However, do not change the address in this fullword field because you might not point to a valid \$WAVE.

**X036RCBN**

4-character identifier of related control block.

**X036RCBA**

Address of related control block. If a control block is not related with this request, the address is zero.

**X036RETC**

Fullword return code from exit routine. The exit passes the return code you set here to the caller in place of the SAF return code if X036NORC is a 1.

**X036RSNC**

Fullword reason code from exit routine. The exit passes the reason code you set here to the caller in place of the SAF reason code if X036NORC is a 1.

**X036SIZE**

Size of parameter list for Exit 36

|             |                                    |
|-------------|------------------------------------|
| <b>2-10</b> | N/A                                |
| <b>11</b>   | Address of HCCT                    |
| <b>12</b>   | N/A                                |
| <b>13</b>   | Address of an available save area. |
| <b>14</b>   | Return address                     |
| <b>15</b>   | Entry address                      |

---

## Register contents when Exit 36 passes control back to JES2

Upon return from this exit, the register contents must be:

| Register | Contents       |
|----------|----------------|
| 0-13     | N/A            |
| 14       | Return address |
| 15       | Return code    |

A return code of:

- 0 Tells JES2 that if additional exit routines are associated with this exit, call the next consecutive exit routine. If no other exit routines are associated with this exit, continue with normal processing, which is determined by the particular exit point from which the exit routine was called.
- 4 Tells JES2 that even if additional exit routines are associated with this exit, ignore them; continue with normal processing, which is determined by the particular exit point from which the exit routine was called.

---

## Coded example

Module HASX36A in SYS1.SHASSAMP contains a sample of Exit 36.

---

## Chapter 49. Exit 37: Post-security authorization call

---

### Function

This exit allows you to examine or modify return codes from the security authorization facility (SAF) of MVS. JES2 invokes this exit just before returning control to \$SEAS. You can also perform additional security checking or other action based on the return code received. For example, you can:

- Notify the operator of the status of a request.
- Request confirmation of a request from the operator before continuing.
- Further restrict the criteria used to allow (or disallow) access.
- Call \$SEAS again with new information.

---

### Environment

#### Task

USER environment. You must specify ENVIRON=USER on the \$MODULE macro.

#### AMODE/RMODE requirements

RMODE ANY, AMODE 31

#### Supervisor/problem program

JES2 places Exit 37 in supervisor state and PSW key 0.

#### Recovery

Recovery for this exit depends on the environment that invokes the exit:

##### Main task

If general purpose subtasks are attached then the subtask ESTAE is in effect. If no general purpose subtasks are attached and you specified UNCOND=YES, then the \$SUBIT \$ESTAE is in effect.

**FSS** ESTAE recovery is in effect.

**USER** JES2 fails the request and SSI \$ESTAE recovery is in effect.

However, as with every exit, your exit routine *should not* depend on JES2 for recovery. JES2 cannot anticipate the exact purpose of your exit routine and can therefore provide no more than minimal recovery. Your exit routine should provide its own recovery.

#### Job exit mask

Exit 37 is subject to job exit mask suppression for function codes 5, 6, 7, 8, 9, 14, and 19. Table 10 on page 263 shows which function codes are subject to job mask suppression. (See Byte 8 of 1 in “Register Contents when Exit 37 Gets Control”).

#### Mapping macros normally required

\$HASPEQU, \$HCCT, \$WAVE, \$XPL

---

## Point of processing

This exit is taken from HASCSRIC after returning from the SAF call.

---

## Programming considerations

- Use care when changing or restricting the functions that build, obtain, or extract information for tokens because you could cause later SAF calls to fail.
  - **Locating Extensions to the JCT Control Block:** You can use the \$JCTXGET macro to locate extensions to the job control table (\$JCT) control block from this exit.
  - If you include code (such as a branch table) based on the security function codes presented in Table 9 on page 256 be certain you also see the source of these function codes contained in macro \$HASPEQU for their current and complete listing.
  - If you code Exit 36 or Exit 37, you can pass a RACF request type to the exit. JES2 can request a branch entry extract to extract information from SECLABEL profiles (WAVREQST field set to WAVRXTRB). In addition, JES2 also uses the RACF extract (non-branch entry) to extract SECLABELs from various other profiles (WAVREQST field set to WAVRXTRT). Function codes 38 and 39 are defined for all these requests; see Table 9 on page 256.
- 

## Register contents when Exit 37 gets control

The contents of the registers on entry to this exit are:

### Register

|            | Contents   |            |             |       |                |          |                            |          |                    |         |  |          |  |          |   |          |   |          |  |
|------------|--|------------|-------------|-------|----------------|----------|----------------------------|----------|--------------------|---------|--|----------|--|----------|---|----------|---|----------|--|
| 0          | N/A  |            |             |       |                |          |                            |          |                    |         |  |          |  |          |   |          |   |          |  |
| 1          | Pointer to a parameter list with the following structure, mapped by \$XPL:   |            |             |       |                |          |                            |          |                    |         |  |          |  |          |   |          |   |          |  |
|            | <table> <thead> <tr> <th>Field Name</th> <th>Description</th> </tr> </thead> <tbody> <tr> <td>XPLID</td> <td>The eyecatcher</td> </tr> <tr> <td>XPLLEVEL</td> <td>The version level of \$XPL</td> </tr> <tr> <td>XPLXITID</td> <td>The exit ID number</td> </tr> <tr> <td>X037IND</td> <td>Indicator byte that contains the function code (value of FUNCODE=) passed by \$SEAS. See Table 10 on page 263 for these function codes and their meanings.</td> </tr> <tr> <td>X037COND</td> <td>Condition byte showing the type of code that invoked the exit.</td> </tr> <tr> <td>X037JES2</td> <td>IBM-supplied code (CODER=JES2 on \$SEAS).</td> </tr> <tr> <td>X037USER</td> <td>Customer-written code (CODER=USER on \$SEAS).</td> </tr> <tr> <td>X037RESP</td> <td>Response byte you set to have the following meaning:</td> </tr> </tbody> </table> | Field Name | Description | XPLID | The eyecatcher | XPLLEVEL | The version level of \$XPL | XPLXITID | The exit ID number | X037IND | Indicator byte that contains the function code (value of FUNCODE=) passed by \$SEAS. See Table 10 on page 263 for these function codes and their meanings. | X037COND | Condition byte showing the type of code that invoked the exit. | X037JES2 | IBM-supplied code (CODER=JES2 on \$SEAS). | X037USER | Customer-written code (CODER=USER on \$SEAS). | X037RESP | Response byte you set to have the following meaning: |
| Field Name | Description  |            |             |       |                |          |                            |          |                    |         |  |          |  |          |   |          |   |          |  |
| XPLID      | The eyecatcher   |            |             |       |                |          |                            |          |                    |         |  |          |  |          |   |          |   |          |  |
| XPLLEVEL   | The version level of \$XPL   |            |             |       |                |          |                            |          |                    |         |  |          |  |          |   |          |   |          |  |
| XPLXITID   | The exit ID number   |            |             |       |                |          |                            |          |                    |         |  |          |  |          |   |          |   |          |  |
| X037IND    | Indicator byte that contains the function code (value of FUNCODE=) passed by \$SEAS. See Table 10 on page 263 for these function codes and their meanings.   |            |             |       |                |          |                            |          |                    |         |  |          |  |          |   |          |   |          |  |
| X037COND   | Condition byte showing the type of code that invoked the exit.   |            |             |       |                |          |                            |          |                    |         |  |          |  |          |   |          |   |          |  |
| X037JES2   | IBM-supplied code (CODER=JES2 on \$SEAS).  |            |             |       |                |          |                            |          |                    |         |  |          |  |          |   |          |   |          |  |
| X037USER   | Customer-written code (CODER=USER on \$SEAS).  |            |             |       |                |          |                            |          |                    |         |  |          |  |          |   |          |   |          |  |
| X037RESP   | Response byte you set to have the following meaning:   |            |             |       |                |          |                            |          |                    |         |  |          |  |          |   |          |   |          |  |

**X037NORC**

Setting this bit on in the response byte indicates that the exit-specified return and reason codes will be used. Otherwise, the SAF return code and reason code will be used.

**X037PLUS**

Exit 37 parameter list

**X037PARM**

Address of the parameter list, in the Work Access Verification Element (\$WAVE), to pass to SAF. This address allows you to alter any parameters contained in the parameter list. However, do not change the address in this fullword field as SAF will not get the expected parameters.

**X037WAVE**

Address of the \$WAVE. This address allows you to alter any information contained in the \$WAVE. However, do not change the address in this fullword field because you might not point to a valid \$WAVE.

**X037RCBN**

4-character identifier of related control block.

**X037RCBA**

Address of related control block. If a control block is not related with this request, the address is zero.

**X037RETC**

Fullword return code from exit routine. The exit passes the return code you set here to the caller in place of the SAF return code if bit 6 of byte 10 is a 1.

**X037RSNC**

Fullword reason code from exit routine. The exit passes this reason code you set here to the caller in place of the SAF reason code if bit 6 of byte 10 is a 1.

**X037SIZE**

Size of parameter list for Exit 37

|             |                                    |
|-------------|------------------------------------|
| <b>2-10</b> | N/A                                |
| <b>11</b>   | Address of HCCT                    |
| <b>12</b>   | N/A                                |
| <b>13</b>   | Address of an available save area. |
| <b>14</b>   | Return address                     |
| <b>15</b>   | Entry address                      |

Table 10. Security Function Codes

| Function Code |               |                                 |                        |             |
|---------------|---------------|---------------------------------|------------------------|-------------|
| Decimal Value | Symbolic Name | Meaning                         | Related Control Block* | Job Masking |
| 0             | \$SEANJES     | Reserved for user code          |                        | No          |
| 1             | \$SEAINIT     | Initialize security environment | SFI                    | Yes         |

## Exit 37

Table 10. Security Function Codes (continued)

| Function Code |               |  |                        |             |
|---------------|---------------|--|------------------------|-------------|
| Decimal Value | Symbolic Name | Meaning  | Related Control Block* | Job Masking |
| 2             | \$SEAVERC     | Security environment create  | JCT                    | Yes         |
| 3             | \$SEAVERD     | Security environment delete  | JCT                    | Yes         |
| 4             | \$SEAXTRT     | Extract security information for this environment                                | SJB                    | **          |
| 5             | \$SEASIC      | SYSIN data set create  | IOT                    | Yes         |
| 6             | \$SEASOC      | SYSOUT data set create   | IOT                    | Yes         |
| 7             | \$SEASIP      | SYSIN data set open  | SDB                    | Yes         |
| 8             | \$SEASOP      | SYSOUT data set open   | SDB                    | Yes         |
| 9             | \$SEAPSO      | Process SYSOUT data set open   | SDB                    | Yes         |
| 10            | \$SEAPSS      | Process SYSOUT data set select   | PSO                    | No          |
| 11            | \$SEATCAN     | TSO/E cancel   | JCT                    | No          |
| 12            | \$SEACMD      | Command authorization  | None                   | No          |
| 13            | \$SEAPRT      | Printer data set select  | PDDDB                  | Yes         |
| 14            | \$SEADEL      | Data set purge   | IOT                    | **          |
| 15            | \$SEANUSE     | Notify user token extract  | None                   | No          |
| 16            | \$SEATBLD     | Token build  | SFI                    | Yes         |
| 17            | \$SEARJES     | RJE signon, NJE source for command authorization                                 | SWEL                   | No          |
| 18            | \$SEADEVA     | Device authorization   | PCE                    | **          |
| 19            | \$SEANJEA     | NJE SYSOUT data set create   | SFI                    | Yes         |
| 20            | \$SEAREXT     | Re-verify token extract  | JCT                    | Yes         |
| 21            | ---           | Reserved   | None                   |             |
| 22            | \$SEANEWS     | Update of JESNEWS  | SJB                    | No          |
| 23            | \$SEANWBL     | Build JESNEWS token  | IOT                    | No          |
| 24            | \$SEAVERS     | Subtask to create access control environment element (ACEE) for general subtasks | None                   | No          |
| 25            | \$SEAAUD      | Audit for job in error   | None                   | No          |
| 26            | \$SEADCHK     | Authorization for \$DESTCHK  | DCW                    | No          |
| 27            | \$SEATSOC     | SYSOUT data set create for trace   | IOT                    | No          |
| 28            | \$SEASSOC     | SYSOUT data set create for system job data sets (for example, JOBLG)             | SFI                    | Yes         |
| 29            | \$SEANSOC     | SYSOUT data set create for JESNEWS   | IOT                    | Yes         |
| 30            | \$SEASOX      | Transmit or offload of SYSOUT  | PCE                    | Yes         |
| 31            | \$SEANJEV     | VERIFYX for receive or reload of SYSOUT  | SFI                    | Yes         |
| 32            | \$SEAJOX      | Transmit or offload of job   | PCE                    | Yes         |
| 33            | ---           | Reserved   | None                   |             |
| 34            | \$SEASPBO     | Spool browse data set open   | SDB                    | Yes         |



Table 10. Security Function Codes (continued)

| Function Code |               |  |                        |             |
|---------------|---------------|--|------------------------|-------------|
| Decimal Value | Symbolic Name | Meaning  | Related Control Block* | Job Masking |
| 35            | \$SEASFS      | Scheduler service, TOKNXTR                           | SSW                    | No          |
| 36            | \$SEASSWM     | SWM modify ALTER AUTH                                | None                   | No          |
| 37            | \$SEASAPI     | SYSOUT application programming interface             | None                   | No          |
| 38-39         | ---           | Not currently in use                                 | Not in use             |             |
| 40            | \$SEANSON     | Secure NJE signon SAF profiles for secure NJE signon | None                   | No          |
| 41            | \$SEADIRA     | Seclabel dominance                                   | None                   | No          |
| 42            | \$SEASPLR     | SPOOL I/O AUTH check                                 | None                   | No          |
| 43-255        | ---           | Not currently in use                                 | Not in use             |             |

**Note:**

- \* Your exit routine should always check for the presence of the control block before using fields in the control block. Currently, the control block is not present when the \$SEAXTRT function occurs during an open of TSU or STC internal readers.
- \*\* Job exit mask suppression not in effect during selected processing.

---

## Register contents when Exit 37 passes control back to JES2

Upon return from this exit, the register contents must be:

### Register Contents

- 0-13 N/A  
 14 Return address  
 15 Return code

A return code:

- 0 Tells JES2 that if additional exit routines are associated with this exit, call the next consecutive exit routine. If no other exit routines are associated with this exit, continue with normal processing, which is determined by the particular exit point from which the exit routine was called.
- 4 Tells JES2 that even if additional exit routines are associated with this exit, ignore them; continue with normal processing, which is determined by the particular exit point from which the exit routine was called.

---

## Coded example

Module HASX37A in SYS1.SHASSAMP contains a sample of Exit 37.



---

## Chapter 50. Exit 38: TSO/E receive data set disposition

---

### Function

During processing of a TSO/E RECEIVE command, SAF determines a user's authority to receive a data set based on the SECLABELs listed in the user's profile. Default actions JES2 takes when SAF returns control are:

- If the user can receive the data set with the current SECLABEL (the SECLABEL the user logged on with), RECEIVE processing continues normally and JES2 selects the data set.
- If the user cannot receive the data set with the current SECLABEL, but the user profile contains a SECLABEL that will allow the user to receive the data set, JES2 does not select the data set at this time. Use exit 37 to override this processing.
- If the user cannot receive the data set with the current SECLABEL or any of the SECLABELs in the user profile, JES2 deletes the data set. Use this exit to change this processing.

In this exit you set a response byte to have JES2:

- Continue normal processing, which deletes the data set.
- Bypass the data set. Bypassing the data set causes the data set to remain on spool. This could cause an undesirable accumulation of data on spool.

You can also supply extra information to the user about the final disposition of the data set. For more information about SECLABELs, see *z/OS Security Server RACF Security Administrator's Guide*.

---

### Environment

#### Task

JES2 address space. You must specify ENVIRON=JES2 on the \$MODULE macro.

#### AMODE/RMODE requirements

RMODE ANY, AMODE 31

#### Supervisor/problem program

JES2 places exit 38 in supervisor state and PSW key 1.

#### Recovery

ESTAE recovery is in effect. However, as with every exit, your exit routine *should not* depend on JES2 for recovery. JES2 cannot anticipate the exact purpose of your exit routine and can therefore provide no more than minimal recovery. Your exit routine should provide its own recovery. If an abend does occur within the exit routine, JES2 assumes a response byte than indicates normal processing (delete the data set) should occur.

#### Job exit mask

This exit point is not subject to job exit mask suppression.

## Mapping macros normally required

\$HASPEQU, \$HCT, \$PSO, \$XPL

### Point of processing

This exit is taken from HASPPSO. JES2 passes control to this exit after obtaining a response from SAF for authorization to a data set during TSO/E RECEIVE processing.

### Programming considerations

None.

### Register contents when Exit 38 gets control

The contents of the registers on entry to this exit are:

#### Register

|            | Contents   |            |             |       |                |          |                            |          |                    |          |               |         |  |         |                |          |                |         |                                     |
|------------|--|------------|-------------|-------|----------------|----------|----------------------------|----------|--------------------|----------|---------------|---------|--|---------|----------------|----------|----------------|---------|-------------------------------------|
| 0          | N/A  |            |             |       |                |          |                            |          |                    |          |               |         |  |         |                |          |                |         |                                     |
| 1          | Pointer to a parameter list with the following structure, mapped by \$XPL:   |            |             |       |                |          |                            |          |                    |          |               |         |  |         |                |          |                |         |                                     |
|            | <table> <thead> <tr> <th>Field Name</th> <th>Description</th> </tr> </thead> <tbody> <tr> <td>XPLID</td> <td>The eyecatcher</td> </tr> <tr> <td>XPLLEVEL</td> <td>The version level of \$XPL</td> </tr> <tr> <td>XPLXITID</td> <td>The exit ID number</td> </tr> <tr> <td>X038RESP</td> <td>Response byte</td> </tr> <tr> <td>X038PSO</td> <td>Address of the Process SYSOUT Work Area (PSO) mapped by \$PSO. Field name PSOPGMN of this work area contains the userid of the <b>intended</b> receiver.</td> </tr> <tr> <td>X038IND</td> <td>Indicator byte</td> </tr> <tr> <td>X038COND</td> <td>Condition byte</td> </tr> <tr> <td>X038JOA</td> <td>Address of the artificial JOE (JOA)</td> </tr> </tbody> </table> | Field Name | Description | XPLID | The eyecatcher | XPLLEVEL | The version level of \$XPL | XPLXITID | The exit ID number | X038RESP | Response byte | X038PSO | Address of the Process SYSOUT Work Area (PSO) mapped by \$PSO. Field name PSOPGMN of this work area contains the userid of the <b>intended</b> receiver. | X038IND | Indicator byte | X038COND | Condition byte | X038JOA | Address of the artificial JOE (JOA) |
| Field Name | Description  |            |             |       |                |          |                            |          |                    |          |               |         |  |         |                |          |                |         |                                     |
| XPLID      | The eyecatcher   |            |             |       |                |          |                            |          |                    |          |               |         |  |         |                |          |                |         |                                     |
| XPLLEVEL   | The version level of \$XPL   |            |             |       |                |          |                            |          |                    |          |               |         |  |         |                |          |                |         |                                     |
| XPLXITID   | The exit ID number   |            |             |       |                |          |                            |          |                    |          |               |         |  |         |                |          |                |         |                                     |
| X038RESP   | Response byte  |            |             |       |                |          |                            |          |                    |          |               |         |  |         |                |          |                |         |                                     |
| X038PSO    | Address of the Process SYSOUT Work Area (PSO) mapped by \$PSO. Field name PSOPGMN of this work area contains the userid of the <b>intended</b> receiver.   |            |             |       |                |          |                            |          |                    |          |               |         |  |         |                |          |                |         |                                     |
| X038IND    | Indicator byte   |            |             |       |                |          |                            |          |                    |          |               |         |  |         |                |          |                |         |                                     |
| X038COND   | Condition byte   |            |             |       |                |          |                            |          |                    |          |               |         |  |         |                |          |                |         |                                     |
| X038JOA    | Address of the artificial JOE (JOA)  |            |             |       |                |          |                            |          |                    |          |               |         |  |         |                |          |                |         |                                     |
|            | <p><b>Note:</b> If the exit must update JOE fields, it should obtain and return an update mode JOA. For more information, see the "Checkpoint control blocks for JOEs" on page 415.</p>  |            |             |       |                |          |                            |          |                    |          |               |         |  |         |                |          |                |         |                                     |
| 2-10       | N/A  |            |             |       |                |          |                            |          |                    |          |               |         |  |         |                |          |                |         |                                     |
| 11         | Address of the HCT   |            |             |       |                |          |                            |          |                    |          |               |         |  |         |                |          |                |         |                                     |
| 12         | N/A  |            |             |       |                |          |                            |          |                    |          |               |         |  |         |                |          |                |         |                                     |

|    |                |
|----|----------------|
| 13 | N/A            |
| 14 | Return address |
| 15 | Entry address  |

---

## Register contents when Exit 38 passes control back to JES2

Upon return from this exit, the register contents must be:

### Register

#### Contents

|   |  |
|---|--|
| 0 | N/A  |
| 1 | Pointer to a parameter list with the following structure, mapped by \$XPL: |

#### Field Name

#### Description

#### X038IND

Indicator byte

#### X038COND

Condition byte

#### X038RESP

Response byte. Set by the exit before returning to JES2:

#### X038KEEP

If you set this bit on, JES2 will bypass data set selection and will keep the JOE. Otherwise, normal processing will continue and the data set will be deleted.

|      |                    |
|------|--------------------|
| 2-10 | N/A                |
| 11   | Address of the HCT |
| 12   | N/A                |
| 13   | N/A                |
| 14   | Return address     |
| 15   | Return Code        |

A return code of:

|   |   |
|---|---|
| 0 | Tells JES2 that if additional exit routines are associated with this exit, call the next consecutive exit routine. If no other exit routines are associated with this exit, continue with normal processing, which is determined by the particular exit point from which the exit routine was called. |
| 4 | Tells JES2 that even if additional exit routines are associated with this exit, ignore them; continue with normal processing, which is determined by the particular exit point from which the exit routine was called.  |

---

## Coded example

Module HASX38A in SYS1.SHASSAMP contains a sample of exit 38.



---

## Chapter 51. Exit 39: NJE SYSOUT reception data set disposition

---

### Function

This exit allows an installation to change the default processing (delete) for a data set that failed RACF verification upon entering this node for SNA and BSC NJE lines.

In this exit, you can:

- Continue default processing and delete the data set
- Accept the data set

---

### Environment

#### Task

JES2 address space. You must specify ENVIRON=JES2 on the \$MODULE macro.

#### AMODE/RMODE requirements

RMODE ANY, AMODE 31

#### Supervisor/problem program

JES2 places Exit 39 in supervisor state and PSW key 1.

#### Recovery

No recovery is in effect when this exit is taken. Your exit routine must provide its own recovery.

#### Job exit mask

This exit is not subject to job exit mask suppression.

#### Mapping macros normally required

\$HASPEQU, \$HCT, \$JCT, \$JCTX, \$NHD, \$PDDB, \$XPL

---

### Point of processing

This exit is taken from HASPNET. JES2 passes control to this exit when RACF fails the verification for a SYSOUT data set received from another node.

---

### Programming considerations

1. When rerouting the data set, your exit routine should ensure the data set has the proper authority for the target node.
2. If your routine accepts SYSOUT already rejected by RACF, there will not be an audit record for the subsequent data set create. The owner of the data set is the userid of the job that created the SYSOUT, even if that userid could not own

## Exit 39

the data on your system and RACF does not validate the assigned userid. If you are using security labels, RACF assigns a SECLABEL of SYSLOW to the data set created.

### 3. Expanding the JCT Control Block:

You can add, expand, locate, or remove extensions to the job control table (\$JCT) control block from this exit using the \$JCTX macro extension service. For example, you can use these extensions to store job-related information. For more information, see *z/OS JES2 Macros*.

**Note:** If you code Exit 39, it may also be necessary for you to code a parallel Exit 55 to provide the same function for TCP/IP lines.

---

## Register contents when Exit 39 gets control

The contents of the registers on entry to this exit are:

### Register

|      | Contents   |
|------|--|
| 0    | N/A  |
| 1    | Pointer to a parameter list with the following structure, mapped by \$XPL: |
|      | <b>Field Name</b>  |
|      | <b>Description</b>   |
|      | <b>XPLID</b><br>The eyecatcher   |
|      | <b>XPLLEVEL</b><br>The version level of \$XPL                              |
|      | <b>XPLXITID</b><br>The exit ID number                                      |
|      | <b>X039IND</b><br>Indicator byte   |
|      | <b>X039COND</b><br>Condition byte  |
|      | <b>X039RESP</b><br>Response byte.  |
|      | <b>X039PDDB</b><br>PDDB address  |
|      | <b>X039JCT</b><br>JCT address  |
|      | <b>X039NDH</b><br>Data set header address                                  |
|      | <b>X039AREA</b><br>SRW address   |
| 2-10 | N/A  |
| 11   | Address of the HCT   |
| 12   | N/A  |
| 13   | N/A  |
| 14   | Return address   |



15      Entry address

---

## Register contents when Exit 39 passes control back to JES2

Upon return from this exit, the register contents must be:

**Register**

|                   | <b>Contents</b>   |                   |                    |                |                |                 |                |                 |  |                 |  |
|-------------------|---|-------------------|--------------------|----------------|----------------|-----------------|----------------|-----------------|--|-----------------|--|
| 0                 | N/A   |                   |                    |                |                |                 |                |                 |  |                 |  |
| 1                 | Pointer to a parameter list with the following structure, mapped by \$XPL:  |                   |                    |                |                |                 |                |                 |  |                 |  |
|                   | <table> <thead> <tr> <th><b>Field Name</b></th> <th><b>Description</b></th> </tr> </thead> <tbody> <tr> <td><b>X039IND</b></td> <td>Indicator byte</td> </tr> <tr> <td><b>X039COND</b></td> <td>Condition byte</td> </tr> <tr> <td><b>X039RESP</b></td> <td>Response byte. Set by exit before returning to JES2:</td> </tr> <tr> <td><b>X039RECV</b></td> <td>Setting this bit on will allow JES2 to receive the data set. Otherwise, processing will continue and the data set will be deleted.</td> </tr> </tbody> </table> | <b>Field Name</b> | <b>Description</b> | <b>X039IND</b> | Indicator byte | <b>X039COND</b> | Condition byte | <b>X039RESP</b> | Response byte. Set by exit before returning to JES2: | <b>X039RECV</b> | Setting this bit on will allow JES2 to receive the data set. Otherwise, processing will continue and the data set will be deleted. |
| <b>Field Name</b> | <b>Description</b>  |                   |                    |                |                |                 |                |                 |  |                 |  |
| <b>X039IND</b>    | Indicator byte  |                   |                    |                |                |                 |                |                 |  |                 |  |
| <b>X039COND</b>   | Condition byte  |                   |                    |                |                |                 |                |                 |  |                 |  |
| <b>X039RESP</b>   | Response byte. Set by exit before returning to JES2:  |                   |                    |                |                |                 |                |                 |  |                 |  |
| <b>X039RECV</b>   | Setting this bit on will allow JES2 to receive the data set. Otherwise, processing will continue and the data set will be deleted.  |                   |                    |                |                |                 |                |                 |  |                 |  |
| 2-13              | N/A   |                   |                    |                |                |                 |                |                 |  |                 |  |
| 14                | Return address  |                   |                    |                |                |                 |                |                 |  |                 |  |
| 15                | Return Code   |                   |                    |                |                |                 |                |                 |  |                 |  |

A return code of:

- |   |   |
|---|---|
| 0 | Tells JES2 that if additional exit routines are associated with this exit, call the next consecutive exit routine. If no other exit routines are associated with this exit, continue with normal processing, which is determined by the particular exit point from which the exit routine was called. |
| 4 | Tells JES2 that even if additional exit routines are associated with this exit, ignore them; continue with normal processing, which is determined by the particular exit point from which the exit routine was called.  |

---

## Coded example

Module HASX39A in SYS1.SHASSAMP contains a sample of Exit 39.



---

## Chapter 52. Exit 40: Modifying SYSOUT characteristics

---

### Function

Use Exit 40 to change the characteristics of a SYSOUT data set before JES2 gathers the attributes of the data set into an output group (\$JOE). For example, you can change class, routing, or forms attributes of the data set. You can also affect the grouping of the PDDBs, or delete the data set by setting the PDB1NSOT bit in PDBFLAG1. Any logical attributes of the data can be changed with this exit. You can also use Exit 40 to influence the issuance of the \$HASP549 notify messages.

---

### Environment

#### Task

JES2 main task. You must specify ENVIRON=JES2 on the \$MODULE macro.

#### AMODE/RMODE requirements

AMODE 31, RMODE ANY

#### Supervisor/problem program

JES2 places Exit 40 in supervisor state and PSW key 1.

#### Recovery

No recovery is in effect. Your exit routine should provide its own recovery.

#### Job exit mask

This exit is not subject to suppression.

#### Mapping macros normally required

\$HASPEQU, \$HCT, \$DSCT, \$JCT, \$JCTX, \$JQE, \$PDDB, \$PCE, \$XPL

---

### Point of processing

JES2 passes control to this exit just before it creates JOEs for the job. This exit can be taken:

- During spin processing, called from HASPSPIN before a JOE is created for a spin PDDB.
- During unspun processing, called from HASPSPIN before a JOE is created for a spin PDDB.
- During regular processing, called from HASPHOPE before the JOEs are created from the non-spin PDDBs.

JES2 gathers the non-spin data sets into groups after leaving this exit and the groups will reflect the changes your routine makes.

---

### Programming considerations

- You can determine whether JES2 invoked Exit 40 for a transaction program by determining whether a \$DSCT is available in field X040DSCT of the \$XPL.

## Exit 40

- You can **not** change the characteristics of SYSOUT data sets defined as OUTPUT=DUMMY; they are not passed to Exit 40. However, SYSOUT data sets defined as OUTDISP=PURGE are passed and available to this exit.
- Expanding the JCT Control Block:  
You can add, expand, locate, and remove extensions to the job control table (\$JCT) control block from this exit using the \$JCTX macro expansion service. For example, you can use these extensions to store job-related information. For more information, see *z/OS JES2 Macros*.

Note that only the \$JCTXGET macro can be used from this exit if any of the following indicator bytes (for non-spin and unspun PDDBs) have been marked on in the parameter list:

- X040NSPN
- X040UNSP

If these bytes are set on, JES2 will not write modifications of the extensions to spool.

---

## Contents of registers when Exit 40 gets control

The contents of the registers on entry to this exit are:

### Register

#### Contents

- |   |  |
|---|--|
| 0 | Not applicable   |
| 1 | Pointer to a parameter list with the following structure, mapped by \$XPL: |

#### Field Name

#### Description

#### XPLID

The eyecatcher

#### XPLLEVEL

The version level of \$XPL

#### XPLXITID

The exit ID number

#### X040IND

Indicator byte.

#### X040SPIN

If this bit setting is on, it is a spin PDDB.

#### X040NSPN

If this bit setting is on, it is a non-spin PDDB.

#### X040UNSP

If this bit setting is on, it is an unspun PDDB.

#### X040COND

Condition byte

#### X040RESP

Response byte

#### X040PDDB

Address of \$PDDB

|      |                  |  |
|------|------------------|--|
|      | <b>X040JQE</b>   | Address of \$JQE   |
|      | <b>X040JCT</b>   | Address of \$JCT or 0. JES2 is unable to supply the address of a \$JCT when processing spin PDDBs.   |
|      | <b>X040DSCT</b>  | Address of \$DSCT or 0. JES2 only supplies the address of a \$DSCT when processing a SYSOUT data set produced by a transaction program.  |
|      | <b>X040VTEXT</b> | A 20-byte EBCDIC field containing variable text to be placed in the \$HASP548 message is in place of "INVALID USERID" for NETMAIL output, if the PDB1NSOT flag is turned on by the exit. |
| 2-10 |                  | Not applicable   |
| 11   |                  | Address of \$HCT   |
| 12   |                  | Not applicable   |
| 13   |                  | Address of \$PCE   |
| 14   |                  | Return address   |
| 15   |                  | Entry address  |

---

## Register contents when Exit 40 passes control back to JES2

| Register | Contents  |
|----------|---|
| 0        | Unchanged   |
| 1        | Pointer to a parameter list with the following structure: |
|          | <b>Field Name</b>   |
|          | <b>Description</b>  |
|          | <b>XPLID</b>  |
|          | The eyecatcher  |
|          | <b>XPLLEVEL</b>   |
|          | The version level of \$XPL                                |
|          | <b>XPLXITID</b>   |
|          | The exit ID number  |
|          | <b>X040IND</b>  |
|          | Indicator byte  |
|          | <b>X040SPIN</b>   |
|          | If this bit setting is on, it is a spin PDDB.             |
|          | <b>X040NSPN</b>   |
|          | If this bit setting is on, it is a non-spin PDDB.         |
|          | <b>X040UNSP</b>   |
|          | If this bit setting is on, it is an unspun PDDB.          |
|          | <b>X040COND</b>   |
|          | Condition byte  |

## Exit 40

### X040RESP

Response byte

### X040RFNT

Enables JES2 to issue the \$HASP549 notification message to the intended receiver of the transmitted file, if the PDB9ONOT flag of the PDBFLAG9 byte is set. If this return code is set, JES2 ignores the NJEDEF MAILMSG= parameter.

#### Note:

1. If the exit turns on the PDB1NSOT bit in the PDBFLAG1 byte of the \$PDDB, JES2 ignores this return code and suppress the \$HASP549 message.
2. If the exit routine alters the PDBUSER field of the \$PDDB, JES2 routes the \$HASP549 message to the user that the contents of PDBUSER indicate. So the sender's intended receiver does not receive this notification message.

### X040RNNT

Disables JES2 to issue the \$HASP549 notification message to the intended receiver of the transmitted file. If this return code is set, JES2 ignores the NJEDEF MAILMSG= parameter.

### X040PDDB

Address of \$PDDB

### X040JQE

Address of \$JQE

### X040JCT

Address of \$JCT, or 0. JES2 is unable to supply the address of a \$JCT when processing spin PDDBs.

### X040DSCT

Address of \$DSCT or 0. JES2 only supplies the address of a DSCT when processing a SYSOUT data set produced by a transaction program.

### X040VTXT

A 20-byte EBCDIC field containing variable text to be placed in the \$HASP548 message is in place of "INVALID USERID" for NETMAIL output, if the PDB1NSOT flag is turned on by the exit.

2-14 Unchanged

15 Return Code

A return code of:

- 0 Tells JES2 that if additional exit routines are associated with this exit, call the next consecutive exit routine.
- 4 Tells JES2 that even if additional exit routines are associated with this exit, ignore them.

---

## Coded example

Module HASX40A in SYS1.SHASSAMP contains a sample of Exit 40.

---

## Chapter 53. Exit 41: Modifying output grouping key selection

---

### Function

Use exit 41 to affect which OUTPUT JCL keywords JES2 uses for generic grouping.

JES2 passes this exit a table that contains the SJF keys for the default generic grouping keywords. There is a one-to-one correspondence between the SJF keys and the OUTPUT JCL keywords. You can use this exit to add keys to or delete keys from this table. You can add up to 24 additional keys at the end of the table. Delete keys by compressing the table.

Generic grouping cannot perform special processing for keywords (such as handling defaults or overrides). A keyword should not be grouped generically if it has any of the following attributes:

- The keyword can be overridden by another source. CLASS, DEST, and WRITER can be overridden on the DD statement. The network SYSOUT receiver uses the group id in a data set header; the group id might have been generated by the execution node and thus not be present on the OUTPUT statement.
- The keyword can be specified at dynamic unallocation (for example, CLASS).
- The keyword has a default value that JES2 must provide. DEST, OUTDISP, and PRMODE, for example, have default values.
- The keyword can be specified in an alternate way (for example, HOLD=YES on the DD statement is equivalent to OUTDISP=HOLD).

Keywords that require special processing should be managed by the PDDB and be grouped upon by the output processor.

JES2 passes this exit the name of the JCL definition vector table (JDVT) that defines these keys. The table of OUTPUT grouping keys applies to all OUTPUT statements processed using this JDVT.

---

### Environment

#### Task

User environment. You must specify ENVIRON=USER on the \$MODULE macro.

#### AMODE/RMODE requirements

AMODE 31, RMODE ANY

#### Supervisor/problem program

JES2 places exit 41 in supervisor state and PSW key 0 or 1.

#### Recovery

No recovery is in effect. Your exit routine must provide its own recovery.

#### Job exit mask

This exit is not subject to job exit mask suppression.

## Mapping macros normally required

\$HASPEQU, \$HCCT, \$XPL, SJTRP.

### Point of processing

This exit is taken from HASC GGKY during JES2 initialization after the default OUTPUT grouping keywords have been selected, but before any grouping is done based on this JDVT name. The table of grouping keys, as modified by the exit, is used for all subsequent grouping for that JDVT name.

### Programming considerations

None

### Register contents when Exit 41 gets control

The contents of the registers on entry to this exit are:

#### Register

|            | Contents   |            |             |       |                |          |                            |          |                    |         |                |          |                |          |               |          |  |          |   |          |   |          |   |
|------------|--|------------|-------------|-------|----------------|----------|----------------------------|----------|--------------------|---------|----------------|----------|----------------|----------|---------------|----------|--|----------|---|----------|---|----------|---|
| 0          | Zero   |            |             |       |                |          |                            |          |                    |         |                |          |                |          |               |          |  |          |   |          |   |          |   |
| 1          | Pointer to a parameter list with the following structure, mapped by \$XPL:   |            |             |       |                |          |                            |          |                    |         |                |          |                |          |               |          |  |          |   |          |   |          |   |
|            | <table> <thead> <tr> <th>Field Name</th> <th>Description</th> </tr> </thead> <tbody> <tr> <td>XPLID</td> <td>The eyecatcher</td> </tr> <tr> <td>XPLLEVEL</td> <td>The version level of \$XPL</td> </tr> <tr> <td>XPLXITID</td> <td>The exit ID number</td> </tr> <tr> <td>X041IND</td> <td>Indicator byte</td> </tr> <tr> <td>X041COND</td> <td>Condition byte</td> </tr> <tr> <td>X041RESP</td> <td>Response byte</td> </tr> <tr> <td>X041GGKT</td> <td>Address of the grouping keys table. The table is mapped by the SJTRKEYL DSECT in the IEFSJTRP parameter list. See <i>z/OS MVS Programming: Assembler Services Reference ABE-HSP</i> for more information about IEFSJTRP.</td> </tr> <tr> <td>X041DEFN</td> <td>Number of defined entries in the grouping keys table. If the exit changes the number of defined entries, it must update this field.</td> </tr> <tr> <td>X041TOTN</td> <td>Total number of entries in the grouping keys table, including defined entries and entries reserved for additional keys.</td> </tr> <tr> <td>X041RSVN</td> <td>Number of entries reserved for additional keys.</td> </tr> </tbody> </table> | Field Name | Description | XPLID | The eyecatcher | XPLLEVEL | The version level of \$XPL | XPLXITID | The exit ID number | X041IND | Indicator byte | X041COND | Condition byte | X041RESP | Response byte | X041GGKT | Address of the grouping keys table. The table is mapped by the SJTRKEYL DSECT in the IEFSJTRP parameter list. See <i>z/OS MVS Programming: Assembler Services Reference ABE-HSP</i> for more information about IEFSJTRP. | X041DEFN | Number of defined entries in the grouping keys table. If the exit changes the number of defined entries, it must update this field. | X041TOTN | Total number of entries in the grouping keys table, including defined entries and entries reserved for additional keys. | X041RSVN | Number of entries reserved for additional keys. |
| Field Name | Description  |            |             |       |                |          |                            |          |                    |         |                |          |                |          |               |          |  |          |   |          |   |          |   |
| XPLID      | The eyecatcher   |            |             |       |                |          |                            |          |                    |         |                |          |                |          |               |          |  |          |   |          |   |          |   |
| XPLLEVEL   | The version level of \$XPL   |            |             |       |                |          |                            |          |                    |         |                |          |                |          |               |          |  |          |   |          |   |          |   |
| XPLXITID   | The exit ID number   |            |             |       |                |          |                            |          |                    |         |                |          |                |          |               |          |  |          |   |          |   |          |   |
| X041IND    | Indicator byte   |            |             |       |                |          |                            |          |                    |         |                |          |                |          |               |          |  |          |   |          |   |          |   |
| X041COND   | Condition byte   |            |             |       |                |          |                            |          |                    |         |                |          |                |          |               |          |  |          |   |          |   |          |   |
| X041RESP   | Response byte  |            |             |       |                |          |                            |          |                    |         |                |          |                |          |               |          |  |          |   |          |   |          |   |
| X041GGKT   | Address of the grouping keys table. The table is mapped by the SJTRKEYL DSECT in the IEFSJTRP parameter list. See <i>z/OS MVS Programming: Assembler Services Reference ABE-HSP</i> for more information about IEFSJTRP.   |            |             |       |                |          |                            |          |                    |         |                |          |                |          |               |          |  |          |   |          |   |          |   |
| X041DEFN   | Number of defined entries in the grouping keys table. If the exit changes the number of defined entries, it must update this field.  |            |             |       |                |          |                            |          |                    |         |                |          |                |          |               |          |  |          |   |          |   |          |   |
| X041TOTN   | Total number of entries in the grouping keys table, including defined entries and entries reserved for additional keys.  |            |             |       |                |          |                            |          |                    |         |                |          |                |          |               |          |  |          |   |          |   |          |   |
| X041RSVN   | Number of entries reserved for additional keys.  |            |             |       |                |          |                            |          |                    |         |                |          |                |          |               |          |  |          |   |          |   |          |   |



|             | <b>X041JDVT</b>                   |
|-------------|-----------------------------------|
|             | JDVT name                         |
| <b>2-10</b> | N/A                               |
| <b>11</b>   | Address of the \$HCCT             |
| <b>12</b>   | N/A                               |
| <b>13</b>   | Address of an available save area |
| <b>14</b>   | Return address                    |
| <b>15</b>   | Entry address                     |

---

## Register contents when Exit 41 passes control back to JES2

Upon return from this exit, the register contents must be:

### Register

#### Contents

|             |                |
|-------------|----------------|
| <b>0-13</b> | Unchanged      |
| <b>14</b>   | Return Address |
| <b>15</b>   | Return Code    |

A return code of:

- 0** Tells JES2 that if additional exit routines are associated with this exit, call the next consecutive exit routine. Otherwise, continue with normal processing, which is determined by the particular exit point from which the exit routine was called.
- 4** Tells JES2 that even if additional exit routines are associated with this exit, ignore them; continue with normal processing, which is determined by the particular exit point from which the exit routine was called.

---

## Coded example

Module HASX41A in SYS1.SHASSAMP contains a sample of exit 41.



---

## Chapter 54. Exit 42: Modifying a notify user message

---

### Function

This exit allows you to affect how a notify user message will be handled. When a notify user message is to be issued, the notify user message SSI service routine is invoked. The routine validates the input and then invokes this installation exit, before the notify user message is built and issued. Use Exit 42 to:

- Cancel the message.
- Change the destination of the message. You can change the userid, node, or both to which the message is to be routed.
- Change the message text.
- Continue processing without changing the message or destination.

---

### Environment

#### Task

User address space. You must specify ENVIRON=USER on the \$MODULE macro.

#### AMODE/RMODE requirements

RMODE ANY, AMODE 31

#### Supervisor/problem program

JES2 places exit 42 in supervisor state and PSW key 0 or 1.

#### Recovery

\$ESTAE recovery is in effect, under the \$ESTAE established when the SSI was invoked. However, your exit routine should provide its own recovery, as with every exit.

#### Job exit mask

This exit is not subject to job exit mask suppression.

#### Mapping macros normally required

\$HCCT, \$XPL, SSNU, SSOB

---

### Point of processing

JES2 takes this exit after the input for a message has been validated and authorization checking has been done for the receiving userid and node. If the exit routine changes the destination, it must provide its own authority and validity checks. Exit 42 will return to the SSI service for the message processing to be completed.

---

## Programming considerations

1. Before this exit is invoked, the system does validity and authorization checking of the node and userid that is to receive the message. Therefore, if the exit changes the node or userid to which the message will be sent, the installation must check the validity and the authority of the new destination.
2. If errors were detected by the SSI service, the bit setting X042CANC will be on in the response byte, indicating that the notify message is to be canceled. If your exit routine corrects the error and turns X042CANC off, to issue the message, it should also zero out the exit-supplied reason and return codes in fields X042REAS and X042RC of the parameter list.
3. As the notify user SSI caller can be unauthorized, you must take special consideration if the SSNU extension is directly referenced in the exit routine. The SSI caller's key is provided so that the exit can reference SSNU data appropriately. Additionally, the \$XPL contains fields so that the exit can update the userid, message text, and message length.

**Note:** IBM suggests updating information in the XPL instead of the SSNU. When using the XPL fields, JES2 ensures the changes are appropriately handled. However, when changing the SSNU directly, the exit must understand how JES2 uses the SSNU fields in subsequent logic.

---

## Register contents when Exit 42 gets control

The contents of the registers on entry to this exit are:

### Register

| Register | Contents   |
|----------|--|
| 0        | N/A  |
| 1        | Pointer to a parameter list with the following structure, mapped by \$XPL: |

#### Field Name

#### Description

#### XPLID

The eyecatcher

#### XPLLEVEL

The version level number of \$XPL

#### XPLXITID

The exit ID number

#### X042IND

Indicator byte

#### X042COND

Condition byte. This byte might contain the following bit settings on entry, if an error exists:

#### X042EMSG

Error in message specification

#### X042NOXT

No extension exists

#### X042EXTE

Extension error

**X042NOAU**  
No authorization

**X042UERR**  
Userid not specified

**X042DERR**  
Destination error

**X042RESP**  
Response byte.

**X042SNUA**  
Address of the SSNU extension for the SSOB

**X042NEWN**  
Current node identifier, in binary form

**X042NEWR**  
Current remote identifier, in binary form

**X042NWML**  
Current message length

**X042REAS**  
Exit-supplied reason code

**X042RC**  
Exit-supplied return code

**X042NEWU**  
Current userid

**X042NEWM**  
Pointer to current message

**X042CKEY**  
SSI caller's key

**X042MEMB**  
The member number that the message should be routed to if the  
userid is not logged on and OUTDEF BRODCAST=NO.

|      |                     |
|------|---------------------|
| 2-10 | N/A                 |
| 11   | Address of the HCCT |
| 12   | N/A                 |
| 13   | N/A                 |
| 14   | Return address      |
| 15   | Entry address       |

---

## Register contents when Exit 42 passes control back to JES2

Upon return from this exit, the register contents must be:

| Register | Contents                                     |
|----------|--|
| 0        | N/A  |
| 1        | Pointer to a parameter list mapped by \$XPL: |

**Field Name**

**Description**

**XPLRESP**

This response byte must be set by the exit before returning to JES2. Set the response byte as follows:

**X042CANC**

This bit setting turned on in the response byte indicates that the notify message is to be canceled. Otherwise, the notify message is to be issued. This bit will be turned off on entry if no errors exist before the installation exit gets control, but will be turned on entry if errors are found before the installation exit gets control. If the exit corrects the errors detected, this bit setting should be reset to be off.

**X042SETR**

This bit setting turned on in the response byte indicates that both a return code and a reason code were specified in the parameter list. If this bit setting is not on, neither reason code nor return code are present.

**X042NOCH**

This bit setting turned on in the response byte indicates that the node has been changed. If this bit setting is not turned on, there has been no change to the destination node.

**X042RMCH**

This bit setting turned on in the response byte indicates that the remote has been changed. If this bit setting is not turned on, there has been no change to the destination remote.

**X042USCH**

This bit setting turned on in the response byte indicates that the userid has been changed. If this bit setting is not turned on, there has been no change to the userid.

**X042MSGC**

This bit setting turned on in the response byte indicates that the message text and length have been changed. If this bit setting is not turned on, there has been no change to the message text and length.

**X042MEMC**

This bit setting turned on in the response byte indicates that the member number in X042MEMB was changed by the exit.

**X042MAIN**

This bit setting turned on in the response byte indicates that the notify request should be unconditionally queued to the JES2 main task for processing. This allows the message to be seen by \$EXIT 10.

**X042NEWN**

New node identifier, in binary form, to be returned from exit, if there was a change in the node.

**X042NEW**

New remote identifier, in binary form, to be returned from exit, if there was a change in the remote.

**X042NEWU**

New userid to be returned from the exit, if there was a change in the userid.

**X042NEWM**

New message text pointer. Note that if the text is updated, the message length in X042NWML must be updated.

**X042NWML**

New message text length to be returned, if there was a change to the message text.

**X042REAS**

Exit-supplied reason code

**X042RC**

Exit-supplied return code

2-14 N/A  
15 Return Code

A return code:

- 0 Tells JES2 that if additional exit routines are associated with this exit, call the next consecutive exit routine.
- 4 Tells JES2 that even if additional exit routines are associated with this exit, ignore them.

---

## Coded example

Module HASX42A in SYS1.SHASSAMP contains a sample of exit 42.





---

## Chapter 55. Exit 43: APPC/MVS TP selection/change/termination

---

### Function

When the system processes an APPC/MVS transaction program (TP) or a z/OS UNIX application, this exit allows you to receive control during:

- TP selection processing, which means the TP initiator selected a TP to run.
- TP termination processing, which means the TP initiator completed processing a TP.
- TP change processing, which means the TP initiator was processing a multi-transaction TP. The APPC/MVS transaction initiator or z/OS UNIX BPXAS initiator started another TP as a result of completing another TP.

While JES2 is processing a TP selection request, you could implement Exit 43 to:

- Create installation-specific control blocks to be used by subsequent installation exits that are invoked for the TP after Exit 43.
- Modify the output limits maintained in the \$SJB.
- Issue messages to the TP's message log.

While processing a multi-transaction TP, if JES2 is invoked for a change request, you could implement Exit 43 to:

- Reset the output limit counts associated with the TP's SYSOUT data set
- Issue messages to the TP's message log.

During TP termination processing, you could implement Exit 43 to:

- Release any control blocks Exit 43 previously obtained for the TP.
- Issue messages to the TP's message log.

---

### Related exits

IBM suggests that you use exit IEFUJI to terminate a TP instead of Exit 43. See *z/OS MVS Installation Exits* for additional information about exit IEFUJI.

If a SYSOUT data set created by a TP exceeded the output limits specified in Exit 43 or in the initialization stream, JES2 invokes Exit 9.

---

### Recommendations for implementing Exit 43

It might be necessary for you to create control blocks that your installation will use while APPC/MVS is processing the transaction program. To create installation-specific control blocks:

1. Create a DSECT for your installation's control block
2. In Exit 43:
  - a. Include all the control blocks necessary for the exit. Mapping macros normally required in the Environment section identifies all the control blocks IBM suggests should be included. Be sure to include any installation-specific control blocks you have created for TPs.
  - b. Issue a \$GETMAIN macro to obtain storage for the control block.

## Exit 43

- c. Initialize the control block with the required information.
- d. Use the information as required while JES2 processes the transaction program.

Your installation might want to issue installation-defined messages to the TP message log when either JES2 selects or terminates a transaction program. Code the following macro to issue a message in Exit 43:

```
$WTO ROUTE=$LOG
```

---

## Environment

### Task

User (APPC/MVS transaction initiator). You must specify ENVIRON=USER on the \$MODULE macro.

### AMODE/RMODE requirements

RMODE ANY, AMODE 31

### Supervisor/problem program

JES2 places Exit 43 in supervisor state and PSW key 0

### Locks held before entry

\$SJB

### Restrictions

- Exit 43 should not perform **any I/O**. If I/O is performed in Exit 43, your installation might experience a degradation in its performance.

### Recovery

\$ESTAE is in effect and provides minimal recovery. JES2 will attempt to recover from any errors experienced by Exit 43. However, you should not depend on JES2 for recovery.

### Job exit mask

Exit 43 is subject to suppression. You can suppress exit 43 by either implementing Exit 2 to set the 43rd bit in the job exit suppression mask (JCTXMASK) or by indicating the exit is disabled in the JES2 initialization stream. All TPs submitted under the APPC/MVS transaction initiator will not invoke Exit 43.

### Storage recommendations

Subpool 230

### Mapping macros normally required

\$HASPEQU, \$SJB, \$JCT, \$JCTX, \$XPL

---

## Point of processing

JES2 invokes Exit 43 during TP selection, change, or termination processing.

---

## Programming considerations

You should consider the following when implementing installation exit 43:

- Any code implemented in this installation exit will be invoked for every transaction program submitted under this initiator.
- The output limits are found in the \$SJB and the \$SJXB.
- Expanding the JCT Control Block:

You can add, expand, locate, or remove extensions to the job control table (\$JCT) control block from this exit using the \$JCTX macro extension service. For example, you can use these extensions to store job-related information. For more information, see *z/OS JES2 Macros*.

---

## Register contents when Exit 43 gets control

The contents of the registers on entry to this exit are:

### Register

#### Contents

- |   |   |
|---|---|
| 0 | Not applicable  |
| 1 | Address to a parameter list with the following structure: |

#### Field Name

##### XPLID

Eyecatcher - \$XPL

##### XPLLEVEL

Version level of \$XPL

##### XPLXITID

Exit identifier number - 43

##### XPLEXLEV

Version level of the exit

##### X043IND

Indicator byte

##### X043TPS

Indicates Exit 43 was invoked for TP select processing.

##### X043TPT

Indicates Exit 43 was invoked for TP terminate processing.

##### X043CHG

Indicates Exit 43 was invoked for TP change processing.

##### X043COND

Not applicable to Exit 43

##### X043RESP

Not applicable to Exit 43

##### X043SJB

Pointer to the \$SJB

##### X043JCT

Pointer to the \$JCT

##### X043SIZE

Length of \$XPL for Exit 43

## Exit 43

|      |                        |
|------|------------------------|
| 2-10 | Not applicable         |
| 11   | Address of the \$HCCT  |
| 12   | Not applicable         |
| 13   | Address of a save area |
| 14   | Return address         |
| 15   | Entry address          |

---

### Register contents when Exit 43 passes control back to JES2

Upon return from this exit, the register contents must be:

#### Register

#### Contents

|      |                                |
|------|--------------------------------|
| 0-14 | Unchanged from entry registers |
| 15   | Return code                    |

A return code of:

|   |  |
|---|--|
| 0 | Indicates JES2 should continue processing the TP.  |
| 4 | Indicates JES2 should continue processing the TP but ignore any additional exits associated with the TP. |

---

### Coded example

Module HASX43A in SYS1.SHASSAMP contains a sample of Exit 43.

---

## Chapter 56. Exit 44: JES2 converter exit (JES2 main)

This information describes JES2 installation exit 44.

---

### Function

This exit allows you to modify job-related control blocks after the converter running as a subtask in the JES2 address space has converted the job's JCL into C/I text. After the system has converted the job's JCL, your installation might want to:

- Change fields in the job's job queue element (\$JQE), such as:
  - Change the priority of the job
  - Release the job from hold
  - Route the job to print on a device other than what was specified on the job's JCL
  - Reassign the system where the job should execute or print
- Perform spool I/O for installation-defined control blocks. You can supply a scheduling environment to the JQASCHE field in the JQE. This will override any scheduling environment from the JOBCLASS(n) for this job. JES2 does not validate the scheduling environment; therefore, be careful to supply a valid scheduling environment or the system will not schedule the job for execution. If needed, use Exit 6 or Exit 60 to provide scheduling environment validation.
- Exit 44 can be used to reject duplicate TSO logons.

---

### Related exits

Exit 6 (JES2 address space) or exit 60 (JES2CI address space) is invoked while the converter subtask is processing the job. Exit 6 or exit 60 is called earlier than Exit 44 during converter processing. Any changes that are required for your job control table (\$JCT) can also be done in exit 6 or exit 60.

---

### Recommendations for implementing Exit 44

If you use exit 6 or exit 60 to extract information from the job's JCL and created installation-specific control blocks, you can implement Exit 44 to write those installation-specific control blocks to spool by:

1. Issuing a \$GETBUF macro to obtain a buffer. The information contained in the installation-specific control block should be moved into the buffer.
2. Issuing a \$CBIO macro to write the buffer to spool.
3. Updating a user field in the \$JCT with the address of the spool installation-specific control block.
4. If you intend to update the JQE passed in your exit, \$DOGJQE should be used to obtain an update mode JQE and to return it when the updates are complete. You do not need to write the \$JCT to spool since JES2 will write the \$JCT to spool after returning from Exit 44.

---

### Environment

#### Task

JES2 main task. You must specify ENVIRON=JES2 on the \$MODULE macro.

## AMODE/RMODE requirements

RMODE ANY, AMODE 31

## Supervisor/problem program

JES2 places Exit 44 in supervisor state and PSW key 1

## Recovery

\$ESTAE is in effect and HASPCNVT provides minimal recovery. JES2 attempts to recover from any abends experienced by the converter main task. However, you should not depend on JES2 for recovery.

## Job exit mask

Exit 44 is subject to suppression. You can suppress Exit 44 by either implementing exit 2 to set the 44th bit in the job exit suppression mask (JCTXMASK) or by disabling the exit through the JES2 initialization stream.

## Mapping macros normally required

\$HASPEQU, \$JQE, \$JCT, \$JCTX, \$XPL

---

## Point of processing

Exit 44 is invoked from the JES2 main task after the converter subtask has converted the job's JCL. It is invoked before JES2 writes job-related control blocks to spool.

After Exit 44 returns to JES2, JES2 examines the response byte in the \$XPL. If an error was encountered and Exit 44 set the response byte in Exit 44 to indicate the job should be placed on the:

- Purge queue or output queue, JES2 places the job on the specified queue.
- Purge queue and output queue, JES2 places the job on the purge queue.

If Exit 44 did not set the response byte, JES2 places the job on the execution queue.

---

## Programming considerations

The following are programming considerations for Exit 44:

1. If Exit 44 sets an indicator in the response byte (XPLRESP) before returning to JES2, JES2 honors the setting over any specifications made in the job's JCL.
2. **Locating the JCT Control Block Extensions**  
You can locate extensions to the job control table (\$JCT) control block from this exit using the \$JCTGET macro. For more information, see *z/OS JES2 Macros*.
3. If you need to change the scheduling environment, SCHENV, for a batch job, use the X044SCHE field in the XPL passed to the exit.
4. If you need to change the job class for the batch job, use the X044JCLS field in the XPL passed to the exit.

---

## Register contents when Exit 44 gets control

The contents of the registers on entry to this exit are:

| Register | Contents |
|----------|----------|
|----------|----------|

0 Not applicable to Exit 44

1 Address of a parameter list with the following structure:

**Field Name**

**XPLID**

Eyecatcher - \$XPL

**XPLLEVEL**

Version level of \$XPL

**XPLXITID**

Exit identifier number - 44

**XPLEXLEV**

Version level of the exit

**X044IND**

Indicates the type of error, if any, while converting the job's JCL

- **X044JCLO** indicates the converter successfully converted the job's JCL
- **X044JCLE** indicates the converter encountered an error while converting the job's JCL
- **X044CPER** indicates a system error occurred while the converter was converting the job's JCL. See X044COND for additional information.

**X044COND**

Indicates additional information about the type of error that was encountered.

- **X044DLGN** a user is already logged onto the system with the same TSU user id.
- **X044FKOF** JES2 was unable to open the system data sets for the converter.
- **X044CNWT** JES2 could not convert the job because the job's JCLLIB data set was not available.

**X044RESP**

Response byte

**X044CNVQ**

JES2 requeues the job to conversion

**X044JCT**

Address of the \$JCT

**X044JQE**

Address of the \$JQE

**X044JCLS**

The current job class for the batch job. This can be updated by the exit to set a new job class for the job.

**X044SCHE**

The current scheduling environment (SCHENV) for the batch job. This can be updated by the exit to set a new scheduling environment for the job.

**X044SIZE**

Length of \$XPL for Exit 44

|  
|  
|  
|  
|  
|  
|

## Exit 44

|      |                           |
|------|---------------------------|
| 2-10 | Not applicable to Exit 44 |
| 11   | Address of the \$HCT      |
| 12   | Not applicable            |
| 13   | Address of the \$PCE      |
| 14   | Return address            |
| 15   | Entry address             |

---

### Register contents when Exit 44 passes control back to JES2

Upon return from this exit, the register contents must be:

#### Register

##### Contents

|      |  |
|------|--|
| 0    | Not applicable   |
| 1    | Address of a parameter list with the following structure:<br><b>Field Name</b><br><b>X044IND</b><br>Indicator byte<br><b>X044COND</b><br>Condition byte<br><b>X044RESP</b><br>Response byte<br><b>X044OUTQ</b><br>Indicates JES2 should place the job on the output queue<br><b>X044PURQ</b><br>Indicates JES2 should place the job on the purge queue<br><b>X044JCT</b><br>Address of the \$JCT<br><b>X044JQE</b><br>Address of the \$JQE<br><b>X044JCLS</b><br>The override job class for a batch job. The job will be assigned this job class, provided the class exists and is valid for a batch job. Note that this job class is only used for scheduling purposes. Default job attributes, such as a default scheduling environment, are based on the job class assigned at the start of conversion.<br><b>X044SCHE</b><br>The override scheduling environment (SCHENV) for the batch job. The job will be assigned this scheduling environment provided it exists. If set to blanks, there will be no scheduling environment assigned to the job (the default scheduling environment for the job class will not be assigned). |
| 2-10 | Not applicable   |
| 11   | Address of the \$HCT   |
| 12   | Not applicable   |
| 13   | Address of the \$PCE   |



14      Return address

15      Return code

A return code of:

0      Indicates JES2 should continue processing the job.

4      Indicates JES2 should continue processing the job but ignore any additional exits associated with the job.

---

## **Coded example**

Module HASX44A in SYS1.SHASSAMP contains two samples of Exit 44.



---

## Chapter 57. Exit 45: Pre-SJF service request

---

### Function

This exit allows you to process requests for the scheduler JCL facility prior to JES2's processing of the request. A function code of 70 on a subsystem IEFSSREQ call with SSSFSWBM in field SSSFREQF invokes the exit. Exit 45 allows the installation to:

- Examine the request to determine if the system should continue to process the request for SJF services
- Redirect error messages for a request.

---

### Environment

#### Task

User task. You must specify ENVIRON=USER on the \$MODULE macro.

#### AMODE/RMODE requirements

RMODE ANY, AMODE 31

#### Supervisor/problem program

JES2 places exit 45 in supervisor state and PSW key 1

#### Recovery

A \$ESTAE recovery is in effect for exit 45. However, as with every exit, your exit routine should not depend on JES2 for recovery. JES2 cannot anticipate the exact purpose of your exit routine and can therefore provide minimal recovery. You should provide recovery for errors that might be encountered by exit 45's processing.

#### Job exit mask

Exit 45 is subject to suppression. The installation can suppress the exit either by implementing exit 2 to set bit 45 in the job exit suppression mask (JCTXMASK) or by indicating the exit is disabled in the JES2 initialization stream.

#### Storage recommendations

Subpool 241 or 231

#### Mapping macros normally required

\$HASPEQU, \$HCT, \$XPL, \$SFRB, IAZSSSF

---

### Point of processing

Exit 45 is invoked by a subsystem issuing an IEFSSREQ macro with a function code of 70 and SSSFSWBM in field SSSFREQF. This is a request for scheduler JCL facility (SJF) SWB modify services. The request is routed through the subsystem interface and JES2, module HASCSJFS, receives control. HASCSJFS performs the following functions:

## Exit 45

1. Establish a recovery environment.
2. Validate the SSOB and its extension SSSF.
3. Issue a \$SEAS request to obtain UTOKEN of the requester.

---

### Programming considerations

Because the SJF Services SSI caller (SSI 70) can be unauthorized, the SSSF extension can be located in an unauthorized storage key. Therefore, you must take special consideration if the SSSF extension is directly referenced in the exit routine. The SSI caller's key is provided so that the exit can reference SSSF data appropriately. However, many fields in the SSSF extension are located in the \$XPL, so no key considerations are necessary when using these fields. IBM suggests that the exit reference fields in the \$XPL rather than the corresponding fields in the SSSF.

---

### Register contents when Exit 45 gets control

The contents of the registers on entry to this exit are:

#### Register

#### Contents

- |   |  |
|---|--|
| 0 | Not applicable to exit 45  |
| 1 | Address of the \$XPL parameter list, which has the following structure:<br><b>XPLID</b><br>Eye-catcher for the \$XPL - \$XPL<br><b>X045VERN</b><br>Indicates the version number of exit 45<br><b>XPLXITID</b><br>Exit identifier - 45<br><b>XPLEXLEV</b><br>Version level of the exit<br><b>X045SIZE</b><br>Indicates the length of the \$XPL parameter list for exit 45.<br><b>X045IND</b><br>Indicator byte<br><b>X045COND</b><br>If set, indicates the reason why JES2 is unable to process the SJF request. If XPLCOND is set to: <ul style="list-style-type: none"><li>• <b>X045PCED</b>, indicates the JES2 SJF PCE is not able to process the request because it is disabled.</li><li>• <b>X045JESD</b>, indicates JES2 is currently not active.</li><li>• <b>X045NOXT</b>, indicates that JES2 could not locate the SSSF extension of the SSOB.</li><li>• <b>X045EXTE</b>, indicates the SSSF extension was not valid.</li><li>• <b>X045NOAU</b>, indicates that JES2 could not validate the request because it could not obtain the security token for the request.</li><li>• <b>X045INVF</b>, indicates JES2 could not process the SJF request because the requester did not indicate an request the correct function.</li><li>• <b>X045INVI</b> indicates JES2 could not process the SJF request because the input to the request was in error.</li></ul> |

**Note:** If XPLCOND is set, JES2 has preset XPLRESP to X045CANC to cancel the request for SJF services.

**X045RESP**

Response byte

**X045SSSA**

Contains the address of IAZSSSF.

**X045SFRB**

Contains the address of the JES2 scheduler facilities request block (SFRB) to be given to the JES2 SJF PCE.

**X045CKEY**

Contains the SSI caller's key

**X045FLG1**

Indicates the intended type of security authorization checking to be done in order to ensure that the user has access to the target sysout dataset. A value of:

**X045DEST**

Indicates that a DEST (ISFAUTH) security check will be done.

**X045SECL**

Indicates that a SECLABEL dominance security check will be done.

**X045JSSP**

Indicates that a security check against the JESSPOOL resource class will be done.

**X045JBNM**

Contains the job name of the target sysout dataset.

**X045JBID**

Contains the job ID of the target sysout dataset.

**X045GRPN**

Contains the group name of the target sysout dataset.

**X045GRP1**

Contains the first group identifier of the target sysout dataset.

**X045GRP2**

Contains the second group identifier of the target sysout dataset.

**X045CART**

Contains the command and response token for WTO responses.

**X045CNID**

Contains the console ID for WTO responses.

**X045MDAD**

Contains the address of the output descriptor modify list in SWBTU format.

**X045ERAD**

Contains the address of the output descriptor erase list in TU format.

**X045MDLN**

Contains the length of the modify list (SWBTU).

## Exit 45

|       |                 |   |
|-------|-----------------|---|
|       | <b>X045ERLN</b> | Contains the length of the erase list (TU). |
| 2-10  |                 | Not applicable to exit 45                   |
| 11    |                 | Address of the \$HCCT                       |
| 12-13 |                 | Not applicable to exit 45                   |
| 14    |                 | Return address                              |
| 15    |                 | Entry point address of exit 45              |

---

## Register contents when Exit 45 passes control back to JES2

Upon return from this exit, the register contents must be:

### Register

|   | Contents   |
|---|--|
| 0 | Not applicable to exit 45  |
| 1 | Address of the \$XPL parameter list which has the following structure:<br><b>X045IND</b><br>Indicator byte<br><b>X045COND</b><br>Condition byte<br><b>X045RESP</b><br>Indicates the processing or return codes the installation exit should return to the application program that requested the SJF service. A value of: <ul style="list-style-type: none"><li>• <b>X045CANC</b> indicates JES2 should not process the request.</li><li>• <b>X045SETR</b> indicates exit 45 returned its own return and reason code to the application program that issued the request for SJF services. The return and reason codes are located in X045REAS and X045RC.</li></ul> <b>X045REAS</b><br>Is the installation-specified reason code that will be returned to the application program that issued the request for SJF services.<br><b>X045RC</b><br>Is the installation-specified return code that will be returned to the application program that issued the request for SJF services.<br><b>X045FLG1</b><br>Indicates the installation-specified type of security checking that will be performed. A value of:<br><b>X045DEST</b><br>Indicates that a DEST (ISFAUTH) security check will be done.<br><b>X045SECL</b><br>Indicates that a SECLABEL dominance security check will be done. Note that if the exit is entered as a result of an unauthorized SSI 70 call, this value will not be honored, and the default will be X045JSSP. |

**X045JSSP**

Indicates that a security check against the JESSPOOL resource class will be done.

- 2-13 Not applicable to exit 45
- 14 Return address
- 15 Exit effector return code

A return code of:

- 0 Indicates JES2 should continue processing the job.
- 4 Indicates JES2 should continue processing the job, but ignore any additional exits associated with the job.

---

**Coded example**

Module HASX45A in SYS1.SHASSAMP contains a sample of exit 45.





---

## Chapter 58. Exit 46: Modifying an NJE data area before its transmission

---

### Function

This exit allows you to change an NJE data area before transmitting a job to another node through SNA or BSC NJE, or while offloading jobs to spool. (See *Network Job Entry (NJE) Formats and Protocols* for more information about the various NJE data areas that can be transmitted across a network.) Before transmitting the NJE job, your installation might need to add, remove or change information to one or more of the following NJE data areas:

- NJE job header
- NJE data set header
- NJE RCCS (Record Characteristics Change Section) header
- NJE job trailer

Your installation might want to:

- Remove any installation-defined sections your installation added to the NJE job when exit 47 was processing the NJE job. However, it might not be necessary to remove any installation-defined sections because installation-defined sections are ignored when they are received at other nodes.
- Add or change information, such as accounting, security or scheduling information, needed by another node in the network.
- Extract information from user fields in JES2 defined control blocks or installation defined control blocks and transfer them to the NJE data areas.
- Remove, modify, or add an RCCS header before sending the job stream into the network.

---

### Related exits

Consider using:

- Exit 40 if you want to change the output characteristics associated with a SYSOUT data set before it prints at your node.
- Exit 2 or exit 47 to modify NJE job headers for jobs that are received for processing at your installation.
- Exit 46 to receive control for spool offload, and BSC and SNA NJE lines.
- Exit 56 to receive control for TCP/IP lines.

---

### Recommendations for implementing Exit 46

If you want to remove an installation-defined section from the NJE data area passed to Exit 46, you should:

1. Use XPLIND to determine the type of NJE data area that JES2 passed to Exit 46 for processing.
2. Issue a \$NDHREM macro to remove the installation-defined section from the NJE data area

---

## Environment

### Task

JES2 main task. You must specify ENVIRON=JES2 on the \$MODULE macro.

### AMODE/RMODE requirements

RMODE ANY, AMODE 31

### Supervisor/problem program

JES2 places Exit 46 in supervisor state and PSW key 0.

### Recovery

Because different types of recovery are provided by the networking or spool offload PCE, your installation should provide its own recovery routine.

### Job exit mask

Exit 46 is subject to suppression. Your installation can either implement exit 2 to set the 46th bit in the job exit suppression mask (JCTXMASK) or disable the exit in the JES2 initialization stream.

### Mapping macros normally required

\$HASPEQU, \$PDDB, \$SCR, \$XPL, \$HCT, \$NHD, \$HCCT, \$DCT, \$JQE, \$JCT, \$JCTX, \$JOE, \$PCE, \$NJEWORK, \$JTW, \$STW

---

## Point of processing

JES2 invokes Exit 46 before transmitting a job while performing spool offload processing or while transmitting an SNA or BSC NJE job across the network. Before invoking Exit 46, JES2:

1. Builds the NJE data area in a 32K buffer
2. Removes any JES2-specific sections from the NJE data area if JES2 is transmitting the NJE data area to another node in the network. The following NJE data areas contain a JES2 section:

- Job Header
- Job Trailer

For spool offload processing, the transmission routine does not alter the NJE data area.

3. Initializes the \$XPL parameter and invokes Exit 46.

After returning from Exit 46, JES2 examines the response byte (XPLRESP) in the \$XPL parameter list. If in Exit 46 you set XPLRESP to:

- **X046TERM**, it indicates an error occurred, JES2 terminates the transmission of the NJE data area, and places the job in hold.
- **X046BYP**, JES2 continues processing the remainder of the NJE job because Exit 46 transmitted the buffer that contained the NJE data area.

If XPLRESP has not been set, JES2 transmits the NJE data area.

---

## Programming considerations

The following are programming considerations for Exit 46:

- If your installation needs to process NJE data areas differently for spool offload processing and NJE processing, use field DCTDEVTP in the \$DCT to determine the type of job JES2 is processing.
- **Locating the JCT Control Block Extensions**  
You can locate extensions to the job control table (\$JCT) control block from this exit using the \$JCTXGET macro. For example, you can use these extensions to retrieve job-related information from the \$JCTX control block to ship across the network in \$NHD macro sections. For more information, see *z/OS JES2 Macros*.

---

## Register contents when Exit 46 gets control

The contents of the registers on entry to this exit are:

### Register

#### Contents

- |   |   |
|---|---|
| 0 | Not applicable to Exit 46   |
| 1 | Address of the \$XPL parameter list, which has the following structure:   |
|   | <b>XPLID</b><br>Eye-catcher for the \$XPL - XPL   |
|   | <b>X046VERN</b><br>Indicates the version number of Exit 46  |
|   | <b>XPLXITID</b><br>Exit identifier - 46   |
|   | <b>XPLEXLEV</b><br>Version level of the exit  |
|   | <b>X046IND</b><br>Indicates the type of NJE data area JES2 passed to Exit 46 for processing. A value of: <ul style="list-style-type: none"> <li>• <b>X046HDR</b> indicates an NJE job header was passed to Exit 46 for processing.</li> <li>• <b>X046TRL</b> indicates an NJE job trailer was passed to Exit 46 for processing.</li> <li>• <b>X046DSH</b> indicates an NJE data set header was passed to Exit 46 for processing.</li> <li>• <b>X046RCCS</b> indicates an NJE RCCS header was passed to Exit 46 for processing.</li> </ul> |
|   | <b>X046COND</b><br>Condition byte <ul style="list-style-type: none"> <li>• <b>X046R1ST</b> indicates that this RCCS header precedes the first data record.</li> </ul>   |
|   | <b>X046RESP</b><br>Response byte<br><br>On input, the response bit X046BYP may be set to indicate that default JES2 processing would suppress the sending of the header. This is the case when a SYSIN data set is being sent and JES2 decided not to send an RCCS header.  |
|   | <b>X046HADR</b><br>Contains the address of the NJE data area  |

## Exit 46

### X046DCT

Contains the address of the \$DCT

### X046JQE

Contains the address of the \$JQE

### X046JCT

Contains the address of the \$JCT

### X046PDDB

Contains the address of the \$PDDB if Exit 46 is processing an NJE data set header. If Exit 46 is processing an NJE job header or trailer, a 0 is passed as the address.

### X046JOA

Contains the address of the artificial JOE (JOA) if Exit 46 is processing an NJE data set header. If Exit 46 is processing an NJE job header or trailer, a value of zero is passed as the address.

**Note:** If the exit must update JOE fields, it should obtain and return an update mode JOA. For more information, see "Checkpoint control blocks for JOEs" on page 415.

### X046AREA

Contains the address of the NJEWORK area (JTW or STW) for the transmitter device sending the header.

### X046SIZE

Indicates the length of the \$XPL parameter list for Exit 46.

|      |  |
|------|--|
| 2-10 | Not applicable to Exit 46                        |
| 11   | Address of the \$HCT                             |
| 12   | Not applicable to Exit 46                        |
| 13   | Address of the spool offload or networking \$PCE |
| 14   | Return address                                   |
| 15   | Entry point address of Exit 46                   |

---

## Register contents when Exit 46 passes control back to JES2

Upon return from this exit, the register contents must be:

### Register

#### Contents

|   |   |
|---|---|
| 0 | Not applicable to Exit 46   |
| 1 | Address of the \$XPL parameter list, which has the following structure: |

#### XPLID

Eye-catcher for the \$XPL - \$XPL

#### X046VERN

Indicates the version number of Exit 46

#### XPLXITID

Exit identifier - 46

#### XPLEXLEV

Version level of the exit

**X046IND**

Indicator byte

**X046COND**

Condition byte

**X046RESP**

Indicates the processing Exit 46 determined JES2 should perform after processing the NJE data area. A value of:

- **X046TERM** indicates Exit 46 determined the NJE data area should not be transmitted. JES2 will discard the remainder of the NJE job.
- **X046BYP** indicates JES2 should not transmit the NJE data area. JES2 will continue to process the remainder of the NJE job.

**X046SIZE**

Indicates the length of the \$XPL parameter list for Exit 46.

2-13 Not applicable to Exit 46

14 Return address

15 Exit effector return code

A return code of:

0 Indicates JES2 should continue processing the job.

4 Indicates JES2 should continue processing the job, but ignore any additional exits associated with Exit 46.

---

## Coded example

Module HASX46A in SYS1.SHASSAMP contains a sample of Exit 46. Module HASXJECL in SYS1.SHASSAMP also contains an example.



---

## Chapter 59. Exit 47: Modifying an NJE data area before receiving the rest of the NJE job

---

### Function

This exit allows you to:

- Examine and change an NJE data area before receiving the rest of the NJE job from another node through SNA or BSC NJE or before receiving jobs from spool.
- Add, expand, locate, or remove an extension to the \$JCT control block where accounting information can be stored.

Before receiving an NJE job, your installation might need to add, remove or change information to one or more of the NJE data areas below. (See *Network Job Entry (NJE) Formats and Protocols* for more information about the various NJE data areas that can be transmitted across a network.)

- NJE job header
- NJE data set header
- NJE RCCS (Record Characteristics Change Section) header
- NJE job trailer

Your installation might want to:

- Remove any installation-defined sections your installation added to the NJE job when exit 46 was processing the NJE job.
- Add or change information, such as accounting or security information, needed by another node in the network.
- Extract information from the NJE data areas and transfer them to user fields in JES2 defined control blocks or installation defined control blocks.

---

### Related exits

If you want to change the output characteristics associated with a SYSOUT data set, consider using exit 40. Exit 47 can be used to receive control for spool offload and SNA and BSC NJE. If you code exit 47, you also need Exit 57 to handle jobs received on TCP/IP lines.

---

### Environment

#### Task

JES2 main task. You must specify ENVIRON=JES2 on the \$MODULE macro.

#### AMODE/RMODE requirements

RMODE ANY, AMODE 31

#### Supervisor/problem program

JES2 places Exit 47 in supervisor state and PSW key 1.

## Recovery

Because different types of recovery are provided by the networking or spool offload PCE, your installation should provide its own recovery routine.

## Job exit mask

Exit 47 is subject to suppression. The installation can suppress the exit either by implementing exit 2 to set the 47th bit in the job exit suppression mask (JCTXMASK) or by indicating the exit is disabled in the JES2 initialization stream.

## Mapping macros normally required

\$HASPEQU, \$PDDB, \$SCR, \$XPL, \$HCT, \$NHD, \$HCCT, \$DCT, \$JQE, \$JCT, \$JCTX, \$JOE, \$PCE, \$NJEWORK, \$JRW, \$SRW

## Point of processing

JES2 invokes Exit 47 before receiving a job while performing spool offload processing or while transmitting an NJE job across the network. Before invoking Exit 47 JES2:

1. Allocates a dummy \$JCT and \$JQE. JES2 initializes these data areas with minimal information.
2. Receives the NJE data area and invokes Exit 47 to perform installation-specific processing.

After returning from Exit 47, JES2 determines if exit 47 indicated whether the NJE data area should be received. If exit 47 indicated the NJE data area should not be received, JES2 places the NJE job in hold on the transmitting node. Otherwise, JES2 continues to process the NJE job. You cannot use this exit to update IBM-defined JCT or JQE fields in the dummy JCT and dummy JQE, respectively. You can, however, update user-defined fields (such as JCTUSERx) or any \$JCTX extensions you have created. JES2 propagates changes to 'user' fields to the \$JCT and \$JQE.

## Programming considerations

The following are programming considerations for Exit 47:

- If your installation needs to process NJE data areas differently for spool offload processing and NJE processing, use field DCTDEVTP in the \$DCT to determine the type of job JES2 is processing.
- If exit is being invoked for a job header, then the JQE address passed points to a dummy JQE (as indicated by X047BJQE). This JQE is not valid as input to \$DOJQE. For other header types, use \$DOJQE to access the JQE passed. See "Checkpoint control blocks" on page 413 for more information.
- Expanding the JCT Control Block:  
You can add, expand, locate, or remove extensions to the job control table (\$JCT) control block from this exit using the \$JCTX macro extension service. For example, you can use these extensions to store job-related information. For more information, see *z/OS JES2 Macros*.

## Register contents when Exit 47 gets control

The contents of the registers on entry to this exit are:

| Register | Contents |
|----------|----------|
|----------|----------|



0 Not applicable to Exit 47

1 Address of the \$XPL parameter list which has the following structure:

**XPLID**

Eye-catcher for the \$XPL - XPL

**X047VERN**

Indicates the version number of Exit 47

**XPLXITID**

Exit identifier - 47

**XPLEXLEV**

Version level of the exit

**X047IND**

Indicates the type of NJE data area JES2 passed to Exit 47 for processing. A value of:

- **X047HDR** indicates an NJE job header was passed to Exit 47 for processing.
- **X047TRL** indicates an NJE job trailer was passed to Exit 47 for processing.
- **X047DSH** indicates an NJE data set header was passed to Exit 47 for processing.
- **X047RCCS** indicates an NJE RCCS header was passed to Exit 47 for processing.
- **X047BJQE** indicates that the JQE address in field X047JQE points to a working copy of the JQE that has not yet been added to the job queue. The working copy should not be used in services that expect the address of a real JQE. For example, this JQE address should not be used as input to \$DOGJQE.

**X047COND**

Condition byte

**X047RESP**

Response byte

**X047HADR**

Contains the address of the NJE data area

**X047DCT**

Contains the address of the \$DCT

**X047JQE**

Contains the address of either a working copy of the \$JQE or the address of a real \$JQE. See the X047BJQE bit to determine the type of \$JQE that this address points to.

**X047JCT**

Contains the address of the \$JCT

**X047PDDB**

Contains the address of the \$PDDB if Exit 47 is processing an NJE data set header. If Exit 47 is processing an NJE job header or trailer, a 0 is passed as the address.

**X047AREA**

Contains the address of the NJEWORK area (JRW or SRW) for the receiver.

## Exit 47

|      |                 |   |
|------|-----------------|---|
|      | <b>X047SIZE</b> | Indicates the length of the \$XPL parameter list for Exit 47. |
| 2-10 |                 | Not applicable to Exit 47                                     |
| 11   |                 | Address of the \$HCT  |
| 12   |                 | Not applicable to Exit 47                                     |
| 13   |                 | Address of the spool offload or networking \$PCE              |
| 14   |                 | Return address  |
| 15   |                 | Entry point address of Exit 47                                |

---

## Register contents when Exit 47 passes control back to JES2

Upon return from this exit, the register contents must be:

### Register

|      | Contents   |
|------|--|
| 0    | Not applicable to Exit 47  |
| 1    | Address of the \$XPL parameter list which has the following structure:<br><b>X047IND</b><br>Condition byte<br><b>X047COND</b><br>Response byte<br><b>X047RESP</b><br>Indicates the processing Exit 47 determined JES2 should perform after processing the NJE data area. A value of: <ul style="list-style-type: none"><li>• <b>X047TERM</b> indicates Exit 47 determined the NJE data area should not be received. JES2 will stop processing the rest of the NJE job.</li></ul> |
| 2-13 | Not applicable to Exit 47  |
| 14   | Return address   |
| 15   | Exit effector return code  |

A return code of:

|   |   |
|---|---|
| 0 | Indicates JES2 should continue processing the job.  |
| 4 | Indicates JES2 should continue processing the job, but ignore any additional exits associated with this exit. |

---

## Coded example

Module HASX47A in SYS1.SHASSAMP contains a sample of Exit 47. Module HASXJECL in SYS1.SHASSAMP also contains an example.

---

## Chapter 60. Exit 48: Subsystem interface (SSI) SYSOUT data set unallocation

---

### Function

This exit gives control to installation exit routines during unallocation of sysout data sets. This exit is taken later in processing than exit 34. When this exit is taken, all the characteristics have been merged from the SSOB into the PDDB. Through this exit, an installation can control whether JES2 will spin the SYSOUT data set.

Unlike installation exit 34, which is taken once for an unallocation, installation Exit 48 is taken once for each PDDB associated with an unallocation.

---

### Environment

#### Task

User address space. You must specify USER on the ENVIRON= parameter of the \$MODULE macro.

#### AMODE/RMODE requirements

RMODE ANY, AMODE 31

#### Supervisor/problem program

Exit 48 receives control in supervisor state with a PSW key 0.

#### Recovery

ESTAE recovery is in effect. However, as with every exit, your exit routine *should not* depend on JES2 for recovery. JES2 cannot anticipate the exact purpose of your exit routine and can therefore provide no more than minimal recovery. Your exit routine should provide its own recovery.

#### Job exit mask

Exit 48 is subject to suppression. You can suppress Exit 48 by either implementing exit 2 to set the 48th bit in the job exit suppression mask (JCTXMASK) or by indicating the exit is disabled in the JES2 initialization stream.

#### Mapping macros normally required

\$HASPEQU, \$HCCT, \$IOT, \$MIT, \$PDDB, \$SDB, \$SJB, \$JCT, \$JCTX, JFCB

---

### Point of processing

This exit is taken from HASCDSAL after JES2 has merged the characteristics from the SSOB into the PDDB.

---

### Programming considerations

1. Job mask suppression is in effect for this exit.
2. Bit 7 of the response byte is set based on the setting of SSALSPIN in the SSOB: If SSALSPIN is on, bit 7 is set on. If SSALSPIN is off, bit 7 is set off.

3. By examining the setting of bit 7 in the response byte and the setting of IOT1SPIN in IOTFLG1, you can determine if the data set was originally allocated as spin and how it was unallocated:

| Bit 7 | IOT1SPIN | JES2                       | DATA SET  |
|-------|----------|----------------------------|---|
| on    | on       | Spins the data set         | The application allocated the data set as spin.   |
| on    | off      | Spins the data set         | The application allocated the data set as non-spin (either DALCLOSE was not set in dynamic allocation or FREE=CLOSE was not specified on the DD statement). The application used dynamic allocation to unallocate the data set. |
| off   | on       | Does not spin the data set | The application allocated the data as spin but the task terminated before closing the data set.   |
| off   | off      | Does not spin the data set | The application allocated the data set as non-spin and the data set remains non-spin.   |

4. Expanding the JCT Control Block:

If the \$JCT address is contained in field SBJCT, you can add, expand, locate, or remove extensions to the job control table (\$JCT) control block from this exit using the \$JCTX macro extension service. For example, you can use these extensions to store job-related information. For more information, see *z/OS JES2 Macros*

---

## Register contents when Exit 48 gets control

The contents of the registers on entry to this exit are:

### Register

#### Contents

0 0

1 Pointer to a 24-byte parameter list with the following structure:

#### Byte 1 (+0)

Type of data set indicator

12 SYSOUT data set

#### Byte 2 (+1)

This byte is not part of the programming interface.

#### Byte 3 (+2)

Response byte

#### bits 0-6

These bits are not part of the programming interface

**bit 7** 0 – Do not spin the data set.

1 – Spin the data set. For more information, see “Programming considerations” on page 315

#### Byte 4 (+3)

This byte is not part of the programming interface

#### Byte 5 (+4)

SDB address.

|      |                                   |                |
|------|-----------------------------------|----------------|
|      | <b>Byte 9 (+8)</b>                | SJB address.   |
|      | <b>Byte 13 (+12)</b>              | JFCB address.  |
|      | <b>Byte 17 (+16)</b>              | PDDDB address. |
|      | <b>Byte 21 (+20)</b>              | IOT address    |
| 2-10 | N/A                               |                |
| 11   | Address of HCCT                   |                |
| 12   | N/A                               |                |
| 13   | Address of the register save area |                |
| 14   | The return address                |                |
| 15   | The entry point address           |                |

---

## Register contents when Exit 48 passes control back to JES2

Upon return from this exit, the register contents must be:

| Register | Contents    |
|----------|-------------|
| 0-14     | Unchanged   |
| 15       | Return code |

A return code of:

- 0 Tells JES2 that if additional exit routines are associated with this exit, call the next consecutive exit routine. If no other exit routines are associated with this exit, continue with normal processing, which is determined by the particular exit point from which the exit routine was called.
- 4 Tells JES2 that even if additional exit routines are associated with this exit, ignore them; continue with normal processing, which is determined by the particular exit point from which the exit routine was called.

---

## Coded example

Module HASX48A in SYS1.SHASSAMP contains a sample of Exit 48.



---

## Chapter 61. Exit 49: Job queue work select - QGOT

---

### Function

This exit allows you to gain control whenever JES2 work selection processing has located a pre-execution job for a device. This includes work selected for JES2 and workload management (WLM) initiators. Exit 49 also gets control when the start job (\$S J) command is used to start a batch job.

Exit 14, Job Queue Work Select - \$QGET is **not** called for workload management (WLM) initiator work selection. Use this exit to instruct JES2 to accept or not accept such work. Exit 49 is generally easier to implement because it does not require that you copy JES2 decision-making algorithms into your exit routine.

Your exit routine is called by the \$QGET routine in HASPJQS, which JES2 uses to acquire control of a job queue element (JQE). This JQE is actually a JQA (an artificial JQE) in update mode; you do not need to verify its update-mode status for calls to \$DOGJQE. This JQA represents a job that is "BERT locked" by the PCE calling Exit 49. You can update this JQA without using any \$DOGxxx services and therefore avoid disallowed \$WAITs for this exit.

The \$QGET routine scans the appropriate queue for an element that:

- is not held
- is not already acquired by a previous request to the job queue service routines
- has affinity to the selecting JES2 member
- has independent mode set in agreement with the current mode of the selecting member.

If this exit rejects the selected job, the JES2 job queue search routine (\$QGET) will continue to search for another job (JQE), which if found will cause this exit to again receive control.

**Note:** Exit 49 is **not** called if:

- JES2 does not find a job
- Exit 14 already selected a job.

---

### Environment

#### Task

JES2 main task. You must specify ENVIRON=JES2 on the \$MODULE macro.

#### AMODE/RMODE requirements

RMODE ANY, AMODE 31

#### Supervisor/problem program

JES2 places Exit 49 in supervisor state and PSW key 1.

## Recovery

The recovery that is in effect when \$QGET is called is the same environment your exit will assume. As with every exit, you should provide your own recovery within the exit routine.

## Job exit mask

This exit is not subject to job exit mask suppression.

## Mapping macros normally required

\$HASPEQU, \$HCT, \$JQE, \$MIT, \$PCE, \$XPL

## Point of processing

HASPJQS calls your exit routine with the address of the JQE that represents the job selected by the \$QGET routine. Your exit routine has opportunity to examine this JQE and return to JES2 with the indication to select it for further processing or reject it.

HASPXEQ also calls exit 49 when processing the \$S Job command. The exit is called once when the command is issued, under the HASPCOMM PCE while processing the \$S Job command. If a job is rejected at this point, a message will be returned to the operator that the job cannot be processed. The second point the exit gets control is when the job is selected for execution under the execution PCE on the member where the job will execute. If a job is rejected at this point, a message is issued to the console that the requested job is not found.

## Programming considerations

1. \$WAIT is not allowed in EXIT49.
2. Exit 49 can perform duplicate job name check and instruct JES2 to bypass the normal duplicate job checks it would perform. You can also use the exit to allow a duplicate jobname to execute under certain situations. Setting X049NDUP causes JES2 checking for selected job to be bypassed.

## Register contents when Exit 49 gets control

The contents of the registers on entry to this exit are:

### Register

|   | Contents   |
|---|--|
| 0 | Not applicable   |
| 1 | Parameter List Address having the following structure: |
|   | <b>Field Name</b>                                      |
|   | <b>XPLID</b>   |
|   | Eyecatcher ('\$XPL')                                   |
|   | <b>XPLLEVEL</b>  |
|   | Maintenance Level                                      |
|   | <b>XPLXITID</b>  |
|   | Version Number   |



**X049VERN**  
Parameter list version

**X049XID**  
Exit 49 ID

**X049IND**  
Indicator byte flag bits:

**X049NORM**  
Normal job selection

**X049SJOB**  
\$S job command issued

**X049SJSE**  
\$S job selection

**X049COND**  
Condition byte:

**X049RESP**  
Response byte

**X049SKIP**  
Do not select this JQE

**X049NDUP**  
Bypass duplicate job name check for this job

**X049NOPT**  
Disallow initiator job selection optimization

**Attention:** Turning on this flag may cause performance degradation.

**X049SIZE**  
Length of parameter list

**X049JQE**  
Address of the JQE

**X049QGT**  
Address of the QGET parameter list or zero if the is \$S JOB processing. The QGET parameter list has the following structure:

**+0 (word 1)**  
Address of the node table

**+4 (word 2)**  
Address of control block

- PIT – if INWS
- DCT – if OJTWS or OJTWSC

**+8 (word 3)**  
Address of class list (if applicable)

**+12 (word 4)**  
Address of the JQE

**+16 (word 5)**  
each byte is set as follows:

**+16** Length of the class list

## Exit 49

|      |     |   |
|------|-----|---|
|      | +17 | Queue type (see the \$QGET macro description for a list of these) This byte is set to '00' for queue types INWS, OJTWSC, and OJTWS. Byte 18 (the type flag) is used to differentiate between these three queue types. |
|      | +18 | Work selection type flag  |
|      | +19 | This byte is not part of the interface  |
| 2-10 |     | Not applicable  |
| 11   |     | Address of the HCT  |
| 12   |     | Not applicable  |
| 13   |     | Current PCE address   |
| 14   |     | The return address  |
| 15   |     | The entry address   |

---

### Register contents when Exit 49 passes control back to JES2

Upon return from this exit, the register contents must be:

#### Register

#### Contents

|        |               |
|--------|---------------|
| 0 - 14 | Unchanged     |
| 15     | A return code |

A return code of:

|   |   |
|---|---|
| 0 | Tells JES2 that if additional exit routines are associated with the exit, call the next consecutive exit routine. If no other exit routines are associated with this exit, continue with normal processing. |
| 4 | Tells JES2 that even if additional exit routines are associated with the exit, ignore them; continue with normal processing. Set bit X049SKIP in the response byte to cause JES2 to select another job.     |

---

### Coded example

Modules HASX49A and HASX49B in SYS1.SHASSAMP contains samples of Exit 49.

---

## Chapter 62. Exit 50: End of input

---

### Function

This exit allows you to do the following:

- Selectively assign a job's/job group's priority, affinity, execution node, SCHENV, and job class, and influence next phase of job processing based on an installation's unique requirements and processing workload. Priority, execution node and job class are ignored for job groups.
- Based on installation-defined criteria, terminate a job's/job group's normal processing and selectively print or not print its output.
- Exit 50 allows input processing - end of input.
- Override the value of the user portion of the job correlator.

**Note:** See Appendix A, "JES2 exit usage limitations," on page 403 for a listing of specific instances when this exit will be invoked or not invoked.

---

### Recommendations for implementing Exit 50

To access the submitting information for a job/job group on the internal reader, you can use the following code segment:

```
USING JRW,R2           Est JRW addressability
USING RIDCWKAR,JRW     Est IRWD addressability
USING SJB,R3           Est SJB addressability
SPACE 1
L   R2,X05xAREA       Get JRW address
L   R3,RIDSJB         Get submitters SJB address
L   R4,SJBJCT         Get submitters JCT address
```

For STC and TSU INTRDRs, RIDSJB is zero because there is no submitting job in these situations.

---

### Environment

Do not attempt to access anything in the JES2 address space in this exit. The JQE provided is always a JQA. The real JQE address is not available. It is not valid and is not necessary to perform a \$DOGJQE.

#### Task

JES2 user environment task. You must specify ENVIRON=USER on the \$MODULE macro.

#### AMODE/RMODE requirements

RMODE ANY, AMODE 31

#### Supervisor/problem program

JES2 places Exit 50 in supervisor state and PSW key 1.

#### Recovery

\$ESTAE recovery is in effect. However, as with every exit, your exit routine should not depend on JES2 for recovery. JES2 cannot anticipate the exact purpose of your

exit routine, therefore, it can provide no more than minimal recovery. You should provide your own recovery within your exit routine.

## Job exit mask

Exit 50 is subject to suppression. You can suppress Exit 50 by either setting the 50th bit in the job exit suppression mask (JCTXMASK) or by indicating the exit is disabled in the initialization stream.

## Mapping macros normally required

\$JCT, \$JCTX, \$PCE, \$HASPEQU, \$MIT, \$JRW, \$HCCT, \$BUFFER, \$DCT

---

## Point of processing

This exit is taken in the subroutine CJOBEND or in the subroutine CJOBKILL of HASCSRIP in the User environment..

---

## Programming considerations

1. To change affinity, set the X050SAF field in the \$XPL work area using the \$SETAFF macro.

To allow the job/job group to run on any member:

```
$SETAFF REQUEST=ANY,AFFIELD=X050SAF
```

To allow the job/job group to run on only this member:

```
$SETAFF REQUEST=CLEAR,AFFIELD=X050SAF
```

```
$SETAFF REQUEST=ADD,AFFIELD=X050SAF,
ID=CCTTOQUL
```

2. If MVS submits a job through an internal reader, it can force a job's affinity to the local member. This can occur when the automatic restart manager restarts a job. The automatic restart manager expects the job to execute on a specific member, and will change the job's affinity so the job can run on that specific member, if necessary. If the automatic restart manager has changed the job's affinity, the X0501ARM flag in the XPL is on. You can test this flag and determine whether the affinity was changed. With that information, you can then decide whether to avoid changing the affinity.
3. To set independent mode for a job, the installation must turn on the bit X0501IND in X050FLG1.

To put jobs that start with the characters 'IND' into independent mode:

```
EXIT50 $ENTRY BASE=R12,SAVE=YES      Set entry point

      LTR   R10,R10                    If JCT not present
      BZ   RRET                        can't check jobname

      CLC  ='IND',JCTJNAME             Job want independent mode?
      BNE  RRET                        No, leave flags alone
      OI   X050FLG1, X0501IND         Set independent mode

RRET   $RETURN RC=0                    Return to caller
```

4. To change the priority set X050PRIO in the XPL. The priority is contained in the 4 high-order bits of X050PRIO. For example, a value of 'C0' would be a priority 12. (See *z/OS JES2 Initialization and Tuning Reference* for further details on setting and changing job priority.)
  - To change the execution node, update X050XNOD with the half word binary value of the node. Use the \$DEST macro to convert an EBCDIC node name to the internal binary representation of the node number

- To change the job class, place the new job class in X050JCLS. This is honored only if the job is a batch job, not if it is an STC or TSU job.
- The exit can influence the next phase of the job/job group in most circumstances. Place the next phase value in X050NEXT. X050NEXT is primed with the phase that JES2 believes is the correct next phase when the exit is called. The exit can place one of these values in X050NEXT:

#### **\$OUTPUT**

Job/job group will be placed in the OUTPUT queue unless JES2 has already determined that the job should be purged. In that case, X050NEXT is ignored.

#### **\$PURGE**

Job/job group will be placed in the PURGE queue.

#### **Any other phase**

JES2 will honor the request unless it has already determined that the job/job group should be placed in the OUTPUT or PURGE phase.

The next phase can also be set through the return code in R15. If one or both of the specifications specify PURGE; then PURGE will be the next phase. If neither specify PURGE, but one or both specify OUTPUT; then the next phase will be OUTPUT.

5. **Extending the JCT Control Block:** You can use the \$JCTX macro extension service to add, expand, locate, and delete extensions to the job control table (\$JCT) control block from this exit. For example, you can use these extensions to store job/job group-related information. Extensions that are added can be SPOOLED extensions that are available to all exits that read the JCT or local extension that are available only to input processing exits (52, 53, 54, and 50) and the \$QMOD exit (51). The size of SPOOLED extensions is based on the SPOOL buffer size and is less than 3k. You can have up to 8K of local extension regardless of SPOOL buffer size. For more information, see *z/OS JES2 Macros*.
6. This exit will not be taken under the following circumstances:
  - The JES2 input service processor fails the job/job group because JES2 does not identify a JOB/JOBGROUP card within the input stream.
7. If you need to change the scheduling environment, use the X050SENV field in the XPL.
8. Setting the X050AVF response bit does NOT influence the next phase of the job/job group. To influence the next phase of the job/job group, you must use the documented methods.
9. **Accessing \$NITs**

The \$NIT macro defines the characteristics of NJE nodes. The \$NITs are arranged in a table that is indexed by the node number. The table of \$NITs is in JES2 private storage and shadowed in a data space for use outside the JES2 address space. Installation exits can use three fields in the \$NJEWORk work area to access the \$NIT table. Installation exits can use these fields to access a \$NIT without regard for what address space they are in.

Because these fields are in the \$NJEWORk data area, you can address them using the 'NJE' prefix or the prefix for the device dependent work area in which the \$NJEWORk is embedded. Therefore, you can address NJENITAD as JRWNITAD in the \$JRW.

The following code accesses the origin node's NIT in an NJE JOB receiver exit:

## Exit 50

```
USING NIT,R1           Est NIT addressability
SPACE 1
$ARMODE ON,SYSSTATE=SET,INIT=CCTZEROS Enter AR mode
SPACE 1
LLGH R1,JRWRDNOD      Get origin node number
MH   R1,CCTNITSZ      Get NIT offset
AL   R1,JRWNITBL      Get NIT address
LAM  AR1,AR1,JRWNITAL Get NIT ALET
```

10. **Determining the device type:** Most exits need to determine the type of device that they are being called under. The \$NJEWORK area has copies of \$DCT fields that can help identify the device. Which method you use depends on the condition that you are testing for.

The field NJEDEVTP (that corresponds to DCTDEVTP) is a one byte flag that can be used to test for classes of devices. A test of the DCTNET bit in NJEDEVTP indicates that the exit is being called under a networking device. A compare of the byte to DCTINR indicates that the exit is being called under an internal reader. See the \$DCT for the meaning of the bits in DCTDEVTP.

NJEDEVID corresponds to DCTDEVID. This is a 3 byte value that can uniquely identify a device. This is more often used when knowing what specific device you are running under. See the \$DCT for the meaning of the fields.

11. Do not issue a \$GETMAIN storage request for subpool 0 (the default for \$GETMAIN), or for subpool 240 or 250, which are translated to subpool 0 for authorized callers. Doing so would establish subpool 0 with an assigned key of 0, which can cause problems for a job step application that shares subpool 0 and requests subpool 0 storage, thereby obtaining the storage in key 0. To avoid this issue the exit should issue a \$GETMAIN request for subpool 229 or 230, which are high private subpools intended for use by authorized functions, whereas subpools 0-127 are in low private subpools and are part of the user region.

---

## Register contents when Exit 50 gets control

The contents of the registers on entry to this exit are:

### Register

#### Contents

- 0 A code indicating:
- 0 Normal end of input.
  - 4 Job/job group has a JES2 control statement error.
  - 8 Job/job group has an SAF (security) failure.
  - 12 Job failed work selection criteria (OFFLOADER only)
- 1 Pointer to a parameter list with the following structure, mapped by \$XPL:
- | Field Name | Description                 |
|------------|-----------------------------|
| XPLID      | The eyecatcher.             |
| XPLLEVEL   | Version level for base XPL. |
| XPLXITID   | The exit ID number.         |

**XPLEXLEV**

Version number for exit

**X050IND**

Indicator byte.

**X050COND**

Condition byte.

**X050GJOB**

Condition bit that specifies a normal job.

**X050JECL**

Condition bit that specifies a JECL error.

**X050BSAF**

Condition bit that specifies an SAF failure.

**X050WSEL**

Condition bit that specifies the job failed to meet work selection criteria.

**X050JOBG**

Condition bit that specifies a job group.

**X050RESP**

Response byte.

**X050NORM**

Response bit that specifies to do normal process.

**X050OUTP**

Response bit that specifies to terminate with output.

**X050PURG**

Response bit that specifies to terminate job/job group without printing the output.

**X050AVF**

Response bit that indicates the exit's job/job group verification failed.

**XPLSIZE**

Size of parm list, including base section.

**X050JCT**

Address of the JCT.

**X050JQE**

Address of update mode JQA.

**X050DCT**

Always zero. This field exists so that the XPL for exit 50 will be compatible with the XPL passed in exit 20. Most DCT fields can be accessed using corresponding fields in the JRW (pointed to by X050AREA). For example, DCTDEVTP can be accessed using field JRWDEVTP.

**X050AREA**

Address of the JRW

**X050PRIO**

Job priority (Input/Output field)

## Exit 50

|     |   |
|-----|---|
|     | <b>X050FLG1</b>                               |
|     | Flags   |
|     | <b>X050XNOD</b>                               |
|     | Execution Node (Input/Output field)           |
|     | <b>X050SAF</b>                                |
|     | Full system affinity mask (Input/Output)      |
|     | <b>X050SENV</b>                               |
|     | Scheduling Environment (Input/Output field)   |
|     | <b>X050JCLS</b>                               |
|     | Job class (Input/Output field)                |
|     | <b>X050NEXT</b>                               |
|     | Next job/job group phase (Input/Output field) |
|     | <b>X050UCOR</b>                               |
|     | Override user portion of the job correlator   |
| 2-9 | Not applicable                                |
| 10  | Address of the JCT.                           |
| 11  | Address of the HCCT.                          |
| 12  | Not applicable                                |
| 13  | Address of a save area                        |
| 14  | Return address.                               |
| 15  | Entry address                                 |

---

### Register contents when Exit 50 passes control back to JES2

Upon return from this exit, the register contents must be:

#### Register

|    | Contents  |
|----|---|
| 0  | Not applicable  |
| 1  | Address of a parameter list mapped by \$XPL:                        |
|    | <b>X050RESP</b>   |
|    | Response byte that may be set by the exit before returning to JES2. |
| 15 | A return code   |

A return code of:

|    |   |
|----|---|
| 0  | Tells JES2 that if additional exit routines are associated with this exit, call the next consecutive exit routine. If no additional exit routines are associated with this exit continue normal processing. |
| 4  | Tells JES2 to ignore any other exit routines associated with this exit and to continue normal processing.   |
| 8  | Tells JES2 to terminate normal processing and print the output.   |
| 12 | Tells JES2 to terminate normal processing without printing the output.  |

---

### Coded example

Modules HASX50A and HASX50B in SYS1.SHASSAMP contain samples of Exit 50.



---

## Chapter 63. Exit 51: Job phase change exit (\$QMOD)

---

### Function

Exit 51 gets control when a job is moving from one phase to another or when a job completes execution phase and is being re-queued for execution. It is called from \$QMOD processing when the new phase for the job is not the same as the current phase, while from \$QPUT when a job has completed execution and is being re-queued to execute again.

The exit can alter the new queue for the job, prevent or cause the job to re-execute, or change the job class, scheduling environment, or affinity of the job. It can also be used as a point of control to track jobs as they move through the various phases of JES2 processing.

The exit will not get control when attributes of the job (such as the class, scheduling environment or service class) change even if those changes cause \$QMOD to re-queue the job to a new job queue.

---

### Environment

#### Task

JES2 main task. You must specify ENVIRON=JES2 on the \$MODULE macro.

#### AMODE/RMODE requirements

AMODE 31, RMODE ANY

#### Supervisor/problem program

JES2 places Exit 51 in supervisor state and PSW key 1.

#### Restrictions

See Appendix A, "JES2 exit usage limitations," on page 403 for a listing of specific instances when this exit will be invoked or not invoked.

#### Recovery

No specific recovery is in place for this exit; however, most callers of \$QMOD have a general recovery routine in place to deal with ABENDs. Your exit routine for this exit should not depend on JES2 for recovery. JES2 cannot anticipate the exact purpose of your exit routine, therefore, it can provide no more than minimal recovery. Provide your own recovery within your exit routine.

#### Job exit mask

Exit 51 is subject to suppression if a JCT is available at the time the exit is taken. You can suppress Exit 51 by setting the 51st bit in the job exit suppression mask (JCTXMASK) or by indicating the exit is disabled in the JES2 initialization stream.

#### Mapping macros normally required

\$PCE, \$JCT, \$JCTX, \$HCT, \$JQE

---

## Point of processing

Exit 51 is called by \$QMOD or \$QPUT while the JQE is still on the original job queue. A update mode JQA has been obtained and the BERT lock is held. If the job is not being occupied by the call, the JQA passed to the exit has been updated. However, the busy bits (and device ID) of the real JQE have not been updated at the time of the call.

---

## Programming considerations

1. Exit 51 can be used to alter the new phase for the job. However, the new phase must be a later phase than the current one. If the new phase is not later, the change will be ignored.
2. If a JCT address is passed to the exit, the job has completed the current phase of processing including writing out the JCT. After the exit completes, the JCT will not be written by JES2. Installations should avoid updating the JCT in exit 51. Instead, earlier exits (such as exits 20 and 50) should be used to alter the JCT.
3. JCT extensions can be used to pass information from earlier exits to exit 51. Input processing can create both local and SPOOLED JCT extension. These can be used to pass information from user environment exits (such as 52, 53, and 54) to process in the JES2 main task. Local extensions are also supported in exits 2, 3, 4, and 20 so that a common set of services can be used for all job input processing.
4. Code in exit 51 must check the X051NOCH bit in X051COND and not attempt to change the phase of the job if this bit is on. In addition, if the X051RBLD bit is on in X051COND, the job is on the rebuild queue (an error queue) and will be deleted when it is no longer busy. Jobs on the rebuild queue should not be processed, because errors have already been detected in the checkpointed data structures. They are passed to exit 51 to allow complete tracking of the job.
5. Internal reader and NJE over TCP/IP processing occurs outside the JES2 address space. However, the code must reach across into the JES2 address space to perform some key functions (like build JQEs and queue them to the next phase). This processing is accomplished using a new service call \$JQESERV. There is also a set of PCEs (the JQE Request Processors) in the main task that handle these requests (10 of them in all). It is under these PCEs that the \$QMOD is done and that exit 51 is called. The code is careful not to \$WAIT for any extended length of time so that the JQE Request Processors can process as many requests as possible. Adding a \$CBIO to write the JCT in exit 51 will limit the number of jobs that can be processed by a given JQE Request Processor to one per \$JCT write. The design point for internal readers was a single reader submitting hundreds of jobs at once and completing input processing as fast as possible. If this is the environment you are in, the extra I/O will impact performance. If jobs are arriving at a more leisurely rate, you can wait for a \$CBIO.
6. Do not issue a \$GETMAIN storage request for subpool 0 (the default for \$GETMAIN), or for subpool 240 or 250, which are translated to subpool 0 for authorized callers. Doing so would establish subpool 0 with an assigned key of 0, which can cause problems for a job step application that shares subpool 0 and requests subpool 0 storage, thereby obtaining the storage in key 0. To avoid this issue the exit should issue a \$GETMAIN request for subpool 229 or 230, which are high private subpools intended for use by authorized functions, whereas subpools 0-127 are in low private subpools and are part of the user region.

## Register contents when Exit 51 gets control

The contents of the registers on entry to this exit are:

### Register

#### Contents

- 0 Not applicable
- 1 Pointer to a parameter list with the following structure, mapped by \$XPL:

#### Field Name

#### Description

#### XPLID

Eyecatcher

#### XPLLEVEL

Version level for base XPL

#### XPLXITID

Exit ID number

#### XPLEXLEV

Version number for exit

#### X051IND

Indicator byte

#### X051COND

Condition byte

#### X051RBLD

Job is on the re-build queue and will be purged when no longer busy.

#### X051NOCH

Phase change is not allowed (X051RXEQ and X051RQUE ignored).

#### X051RESP

Response byte

#### X051RXEQ

Job is being/should be requeued for execution (only valid if X051OLDQ is X051QXEQ). This bit is set by JES2 if the job is being requeued for execution. Exit 51 can alter the setting of this bit to cause the job to be requeued or not.

#### X051RQUE

X051NEWQ has been updated with new phase (X051NEWT no longer matches X051NEWQ) To change the next phase of the job, set X051RQUE on and set the next phase in X051NEWQ. You cannot change phase if X051NOCH is on. The new phase must be a later phase than the current phase (X051OLDQ).

#### XPLSIZE

Size of parameter list, including base section.

#### X051JCT

Address of JCT (or zero). If a JCT is passed, it will not be written after this call. If updated, the exit must write the JCT and wait for the I/O to complete.

- X051JQA**  
Address of JQA
- X051OLDQ**  
Current queue job is in. See below for valid values.
- X051OLDT**  
Current JQE type. See JQETYPE field in the JQE for valid values.
- X051NEWQ**  
New queue job is moving to. See below for valid values
- X051NEWT**  
Proposed new JQE type. See JQETYPE field in the JQE for valid values.
- X051JOBC**  
JOB class of the job
- X051SENV**  
SCHENV value
- X051SAF**  
Full sysaff mask
- X051FLG1**  
Flags
- X0511IND**  
Independent system affinity.

**Notes:**

1. X051JOBC, X051SENV, X051SAF, X0511IND are only meaningful if NEWQ is X051QCNV, X051QSET, X051QXEQ.
2. An attempt to set independent mode for the logging job representing a job group is ignored.

Queue values for X051OLDQ and X051NEWQ (not same as JQETYPE field in JQE).

- X051QINP**  
Input queue
- X051QCNV**  
Conversion queue
- X051QSET**  
Setup queue
- X051QXEQ**  
Execution queue
- X051QSPN**  
Spin queue
- X051QXMT**  
XMIT queue
- X051QRCV**  
X051QRCV
- X051QOUT**  
X051QOUT

**X051QHRD**  
Hardcopy queue

**X051QPUR**  
Purge queue

- 2-10 Not applicable
- 11 Address of the HCT
- 12 Not applicable
- 13 Address of the current PCE
- 14 Return address
- 15 Entry address

---

## Register contents when Exit 51 passes control back to JES2

Upon return from this exit, the register contents must be:

**Register**  
**Contents**

- 0 - 14 Unchanged
- 15 A return code

A return code of:

- 0 Tells JES2 that if additional exit routines are associated with the exit, call the next consecutive exit routine. If no other exit routines are associated with this exit, continue with normal processing.
- 4 Tells JES2 that even if additional exit routines are associated with the exit, ignore them; continue with normal processing.

---

## Coded example

Modules HASX51A and HASX51B in SYS1.SHASSAMP contains samples of Exit 51.



---

## Chapter 64. Exit 52: JOB/JOBGROUP JCL statement scan (JES2 user environment)

---

### Function

Exit 52 allows you to process information specified on the JOB/JOBGROUP JCL statement for jobs/job groups submitted through internal readers or TCP/IP NJE. (For jobs/job groups submitted through card readers, RJE, SNA and BSC NJE, and SPOOL reload, exit 2 is called for JOB/JOBGROUP JCL statements.) Exit 52 is invoked for the initial JOB/JOBGROUP statement and each continuation of the JOB/JOBGROUP card. The initial JOB/JOBGROUP card and all continuations are read before invoking the exit.

Using Exit 52 you can:

- Add, delete, change information specified on the JOB/JOBGROUP statement. If you are adding information, such as accounting information, you can create an additional JOB/JOBGROUP continuation statements.
- Indicate which spool volumes from which a job/job group or transaction program should allocate spool space, if the installation did not implement spool partitioning through the JES2 initialization stream.
- Add JCL statements or JES2 control statements (JECL) to the job/job group.
- Cancel, purge, or continue processing the job/job group.
- Indicate whether additional job-related exits should be invoked for the job/job group.
- Override the value of the user portion of the job correlator.

---

### Recommendations for implementing Exit 52

Exit 52 is called for each card in the job/job group statement (the original card and all continuations). Each time the exit is called, it will pass the current card image and the statement buffer. The statement buffer includes all the operands for the JOB/JOBGROUP statement concatenated in a single buffer. For example:

```
//TEST JOB   (ACCOUNT),'PROGRAMMER',  COMMENT 1
//          CLASS=A,MSGCLASS=A,      COMMENT 2
//          USER=TEST,PASSWORD=TEST COMMENT 3
```

In this case the exit will be called 3 times, once for each card and will pass (on all 3 calls) the following data in the statement buffer (pointed to by X052STMT):

```
(ACCOUNT),'PROGRAMMER',CLASS=A,MSGCLASS=A,USER=TEST,PASSWORD=TEST
```

To alter the processing of the JOB/JOBGROUP card, the exit can:

- Update the card image passed in X052CARD. This change shows up in the listing of the job/job group.
- Update the statement buffer in X052STMT to add or modify the operands. This change does not show up in the listing of the job/job group and is not passed to conversion processing (it only affects keywords input processing scans from the JOB/JOBGROUP card). If you update the statement buffer (X052STMT) in exit 52 and change the length of the buffer, you must update the field X052STME to indicate the new end of buffer (one byte past the last meaningful character).
- Add additional card images to the JCL stream.

You can add card images to the JCL stream by either queuing a single RJC B or a chain of RJC Bs to the XPL, or by placing a card image after the current card into the area pointed to by X052JXWR and setting X052XSNC. In either case, when a card is added, the current card is re-scanned and the statement buffer is re-built. Exit 52 is driven again for the updated statement, with X052SEC set to indicate this card has been presented to the exit previously.

When adding cards using RJC Bs, use the RGETRJCB service (located in HASCSRIP) to obtain a free RJC B; then add it to one of the three RJC B queues in the XPL. Use the \$CALL macro to invoke the RGETRJCB service. Register 1 on entry must be the JRW address. The RJC B address is returned in register 1.

The 80-byte card image to be added is placed into the field RJCBCARD. RJC Bs are chained together using the RJC BRJC B field in the \$RJCB. They are added to the job stream in the order they exist in the chain. To add an element to the chain you would move the current RJC B queue head in the \$XPL into the RJC BRJC B field of the last RJC B you are adding and then set the address of the first RJC B element into the \$XPL queue head. Be aware that multiple exit 4s might be using these queues so ensure that you do not lose existing entries on the queue.

#### **X052RJCP**

Adds the card images before the first card in the current JOB/JOBGROUP statement.

#### **X052RJCA**

Adds the card images after the last card in the current JOB/JOBGROUP statement. In this case, the card(s) are assumed to not be a continuation of the current job/job group statement and the job/job group card is not re-scanned.

#### **X052RJCC**

Adds the card images after the current card. It is the callers' responsibility to ensure that the proper continuation processing will occur.

When processing the last card in a JOB/JOBGROUP statement, the difference between adding a card to the X052RJCA queue and the X052RJCC queue is that the first will not re-scan the job/job group card and the second will. You can also add a single card image after the current card using the X052JXWR field. In this case, the job/job group card will be re-scanned just as if the card was added to the X052RJCC queue. To add information to the job/job group JCL statement:

1. Move a comma into the last byte of the job/job group statement image exit 52 is currently processing. The comma indicates that additional information follows on the job/job group statement.
2. Move the information you want to add to the job/job group statement to the area pointed to by X052JXWR and set the X052XSNC bit in the X052RESP byte to one. Setting X052RESP to X052XSNC indicates that the installation has supplied an additional job/job group statement image.
3. Set register 15 to X'00' or X'04' depending on whether you want to invoke additional installation exits to process the job/job group.

You can also add an additional job level JCL statement to the job/job group as follows:

1. Ensure that the job/job group statement image that exit 52 is currently processing is the last. exit 52 is processing the last job/job group statement image if a comma is not in the last byte of the job/job group statement image.



2. Place the job/job group-level JCL statement in the are pointed to by X052JXWR and set the X052XSNC bit in the X052RESP byte to one. Setting X052RESP to X052XSNC indicates that the installation has supplied an additional job/job group statement image.
3. Set register 15 to X'00' or X'04' depending on whether you want to invoke additional installation exits to process the job/job group.

If you want to issue messages when you cancel or purge the job/job group:

1. Generate the message text in exit 52.
2. Move the message text to area pointed to by X052JXWR and set the X052XSEM bit in X052RESP to one. Setting X052RESP to X052XSEM indicates that the installation exit has supplied an error message that will be added to the JCL listing.
3. Set register 15 to X'08' to indicate JES2 should cancel or purge the job/job group.

The following indicators in the XPL can assist you in adding a card image to the current job/job group statement:

#### **X052LOPR**

Current card has the last operand in the job/job group statement. There may be additional continued comments after the current card.

#### **X052QUOT**

A quoted sting is being continued from the current card to the next card. Pay attention if a card is being added after this card.

#### **X052CCMT**

The current card is a continued comment. Operand added to this card or after this card will not be processed.

#### **X052LAST**

This is the last card image in the JOB/JOBGROUP statement.

To assist you in processing the operands on a statement, you can use either of the following services to parse the statement buffer passed in X004STMT:

- Use the \$SCAN facility to parse the operands with the standard \$SCAN rules for statements. This give you the flexibility of \$SCAN, but the parsing rules are not the same as normal JCL. See the \$SCAN and \$SCANTAB macros for additional information.
- Use the RCARDSCN service and \$STMTTAB macro to parse the operands with standard JCL rules. This is the service used by JES2 input processing to parse the statement buffer. However, the RCARDSCN service only parses the operands and calls a processing routine to do all the conversions and storing of data. Conversion of data to binary to store into data areas is the responsibility of the processing routines. See the \$STMTTAB macro for more information.

To access the submitting information for a job/job group on the internal reader, you can use the following code segment:

```

USING JRW,R2           Est JRW addressability
USING RIDCWKAR,JRW    Est IRWD addressability
USING SJB,R3           Est SJB addressability
SPACE 1
L   R2,X05xAREA        Get JRW address
L   R3,RIDSJB          Get submitters SJB address
L   R4,SJBJCT          Get submitters JCT address

```

## Exit 52

For STC and TSU INTRDRs, RIDSJB is zero because there is no submitting job in these situations.

---

## Environment

### Task

JES2 user environment. You must specify ENVIRON=USER on the \$MODULE macro.

### AMODE/RMODE requirements

AMODE 31, RMODE ANY

### Supervisor/problem program

JES2 places exit 52 in supervisor state and PSW key 0.

### Restrictions

- See Appendix A, “JES2 exit usage limitations,” on page 403 for a listing of specific instances when this exit will be invoked or not invoked.
- Installation Exit 52 is not invoked for jobs such as SYSLOG, \$TRCLOG, or JESMSG.
- Do not use this exit to set fields in the JCT; they will likely be overwritten by future processing.
- Installation Exit 52 is not invoked for jobs submitted through card readers, RJE, SAN and BSC NJE and SPOOL reload.

### Recovery

\$ESTAE is in effect and provides minimal recovery. Input Services will attempt to recover from any program check errors experienced by exit 52. However, you should not depend on JES2 for recovery.

### Job exit mask

Exit 52 and all subsequent job-related installation exits can be suppressed after Exit 2 processes the initial job/job group statement image. You can set the 52nd bit in the job exit suppression mask (JCTXMASK) or you can indicate the exit is disabled in the JES2 initialization stream.

### Storage recommendations

If exit 52 requires work areas or additional storage, you can:

- Use the 80-byte work area, JCTXWRK, in the JCT
- Issue \$GETMAIN to obtain additional storage

### Mapping macros normally required

\$JCT, \$JCTX, \$HCCT, \$BUFFER, \$MIT, \$HASPEQU, \$JRW

---

## Point of processing

Installation Exit 52 can be invoked when JES2 encounters either:

- the JOB/JOBGROUP statement, this is called the initial job statement image.

- or a continuation of the JOB/JOBGROUP statement, this is called an additional JOB/JOBGROUP continuation statement image.

Module HASPINJR invokes installation Exit 52 for initial JOB/JOBGROUP statement images. Input service has obtained and initialized the job control table (JCT) and the IOT before calling installation Exit 52. After performing the processing you coded in Exit 52, input services complete scanning the JOB/JOBGROUP statement and allocate spool space for the job/job group.

Module HASPINJR invokes installation Exit 52 for continuation JOB/JOBGROUP statement images.

---

## Extending the JCT control block

1. You can use the \$JCTX macro extension service to add, expand, locate, and delete extensions to the job control table (\$JCT) control block from this exit. For example, you can use these extensions to store job-related information. Extensions that are added can be SPOOLED extensions that are available to all exits that read the JCT or local extension that are available only to input processing exits (52, 53, 54, and 50) and the \$QMOD exit (51). The size of SPOOLED extensions is based on the SPOOL buffer size and is less than 3K. You can have up to 8K of local extension regardless of SPOOL buffer size.
2. If you need to change the scheduling environment, use the JCTSCHEN field in the JCT.

---

## Programming considerations

1. Be aware that when a JOB/JOBGROUP card image is passed to Exit 52, any `/**` comment cards embedded within that statement are also passed to the exit. For example, all of the following are passed:

```

//ABC JOB
/** COMMENT CARD
// CLASS=A

```

If within a `/**` comment you embed valid JOB/JOBGROUP card parameters, there is potential to cause confusion in your scan routine and lead to unpredictable results. Consider the following:

```

/** CHANGED CLASS FROM ORIGINAL CLASS=B

```

2. When this exit adds or modifies cards, whether the change is sent over NJE (including SPOOL offload) depends on the statement type and the setting of option flags in the \$XPL or \$RJCB. Modified JECL cards (original and modified card are both JECL) are not sent over NJE. By default, all other changes are sent over NJE. To limit changes to only the local node, you can set the X052RLOC in the XPL (affects the current card) or set the RJCB3LOC bit in any RJCBs that are added.
3. Updating the statement buffer is only valid for parameters that have \$STMTTABs in HASCS RIP.
4. Updates to the statement buffer are not passed to the converter and will not be seen by Exit 6 or Exit 60.
5. **Accessing \$NITs**

The \$NIT macro defines the characteristics of NJE nodes. The \$NITs are arranged in a table that is indexed by the node number. The table of \$NITs is in JES2 private storage and shadowed in a data space for use outside the JES2 address space. Installation exits can use three fields in the \$NJEWORK work

area to access the \$NIT table. Installation exits can use these fields to access a \$NIT without regard for what address space they are in.

Because these fields are in the \$NJEWORK data area, you can address them using the 'NJE' prefix or the prefix for the device dependent work area in which the \$NJEWORK is embedded. Therefore, you can address NJENITAD as JRWNITAD in the \$JRW.

The following code accesses the origin node's NIT in an NJE JOB receiver exit:

```

USING NIT,R1           Est NIT addressability
SPACE 1
$ARMODE ON,SYSSTATE=SET,INIT=CCTZEROS Enter AR mode
SPACE 1
LLGH R1,JRWRDNOD      Get origin node number
MH   R1,CCTNITSZ      Get NIT offset
AL   R1,JRWNITBL      Get NIT address
LAM  AR1,AR1,JRWNITAL Get NIT ALET

```

#### 6. Determining the device type

Most exits need to determine the type of device that they are being called under. The \$NJEWORK area has copies of \$DCT fields that can help identify the device. Which method you use depends on the condition that you are testing for.

The field NJEDEVTP (that corresponds to DCTDEVTP) is a one byte flag that can be used to test for classes of devices. A test of the DCTNET bit in NJEDEVTP indicates that the exit is being called under a networking device. A compare of the byte to DCTINR indicates that the exit is being called under an internal reader. See the \$DCT for the meaning of the bits in DCTDEVTP.

NJEDEVID corresponds to DCTDEVID. This is a 3 byte value that can uniquely identify a device. This is more often used when knowing what specific device you are running under. See the \$DCT for the meaning of the fields.

7. Do not issue a \$GETMAIN storage request for subpool 0 (the default for \$GETMAIN), or for subpool 240 or 250, which are translated to subpool 0 for authorized callers. Doing so would establish subpool 0 with an assigned key of 0, which can cause problems for a job step application that shares subpool 0 and requests subpool 0 storage, thereby obtaining the storage in key 0. To avoid this issue the exit should issue a \$GETMAIN request for subpool 229 or 230, which are high private subpools intended for use by authorized functions, whereas subpools 0-127 are in low private subpools and are part of the user region.

---

## Register contents on entry to Exit 52

The contents of the registers on entry to this exit are:

### Register

#### Contents

- 0 Pointer to a parameter list with the following structure, mapped by \$XPL:

#### Field Name

#### Description

#### XPLID

Eyecatcher

#### XPLLEVEL

Version level for base XPL

#### XPLXITID

Exit ID number

**XPLEXLEV**  
 Version number for exit

**X052IND**  
 Indicator byte

**X052JOBC**  
 JOB card detected

**X052JOBG**  
 JOBGROUP card detected

**X052COND**  
 Condition byte

**X052CONT**  
 Card is a continuation (not first card of JOB/JOBGROUP statement)

**X052SEC**  
 This card has been passed to the exit previously for this job (set if cards added physically before this card)

**X052ECLT**  
 Job JECL processing indicator. On input, this field indicates if JES2 will process JECL statements for the current job. On output, the exit program can change this field to override the JECL processing for the current job. The following bits are defined for this field:

**X052J2CL**  
 If this bit is on, JES2 will process the JES2 JECL statements for the current job according to the rules specified by the JES2= keyword of the JECLDEF command and initialization statement.  
 If this bit is off, JES2 JECL statements for the current job will be ignored.

**X052J3CL**  
 If this bit is on, JES2 will process the JES3 JECL statements for the current job according to the rules specified by the JES3= keyword of the JECLDEF command and initialization statement.  
 If this bit is off, JES3 JECL statements for the current job will be ignored.

**X052RESP**  
 Response byte

**X052XSNC**  
 Exit supplied next card in X052JXWR

**X052XSEM**  
 Exit supplied error message in X052JXWR

**X052JCMT**  
 Skip processing card

**X052KILL**  
 Kill current job/job group (queue job/job group to OUTPUT processing)

## Exit 52

|                   **X052PURG**  
|                   Purge current job/job group

|                   **X052RLOC**  
|                   Changed or added cards are not sent through NJE (set  
|                   RJCB3LOC in current RJCB)

|                   **XPLSIZE**  
|                   Size of parameter list, including base section

|                   **X052CARD**  
|                   80-byte card image address

|                   **X052FLGX**  
|                   Pointer to exit flags (same as JRWFLAGX)

|                   **X052JXWR**  
|                   80-byte exit work area address (same as JCTXWRK)

|                   **X052JCT**  
|                   JCT address

|                   **X052JQE**  
|                   Update mode JQA address

|                   **X052AREA**  
|                   JRW address

|                   **X052STMT**  
|                   Concatenated statement buffer. This is all the operands on all  
|                   continuations cards for this statement

|                   **X052STME**  
|                   End of statement+1 pointer (in buffer)

|                   **X052STML**  
|                   Statement label (job/job group name)

|                   **X052STMV**  
|                   Statement verb (JOB/JOBGROUP)

|                   **X052RJCP**  
|                   RJCBs to add before this JOB/JOBGROUP statement

|                   **X052RJCA**  
|                   RJCBs to add after this JOB/JOBGROUP statement

|                   **X052RJCC**  
|                   RJCBs to add after the current card

|                   **X052FLG1**  
|                   Statement flag byte

|                   **X052LOPR**  
|                   Last operand is on the current card

|                   **X052QUOT**  
|                   Unfinished quote at end of current card

|                   **X052CCMT**  
|                   Current card is a continued comment

|                   **X052LAST**  
|                   Last card in job/job group statement

**X052OCLS**

Override job class (batch jobs only)

**X052OJNM**

Override job/job group name. Specifying a non-zero value in this field will alter the job/job group name that is used when processing the job/job group. The exit must ensure that the provided job/job group name is valid (such as proper characters with blank padded on the right).

**Note:** This does not alter the job/job group name in the JCL that is printed with the output of the job/job group.

**X052UCOR**

Override user portion of the job correlator

**1** Address of a 3-word parameter list with the following structure:

**Word 1**

(+0) points to the JOB/JOBGROUP statement image buffer

**Word 2**

(+4) points to the exit flag byte, JRWFLAGX, in the \$JRW

**Word 3**

(+8) points to the JCTXWRK field in the \$JCT

**2-9** Not applicable

**10** Address of the \$JCT

**11** Address of the HCCT

**12** Not applicable

**13** Address of an available save area

**14** Return address

**15** Entry address

---

## Register contents when Exit 52 passes control back to JES2

Upon return from this exit, the register contents must be:

**Register****Contents**

**0 - 13** Not applicable

**14** Return address

**15** Return code

A return code of:

**0** Tells JES2 that if any additional exit routines are associated with this exit, call the next consecutive exit routine. If there are no additional exit routines associated with this exit, continue with normal HASPINJR processing.

**4** Tells JES2 to ignore any additional exit routines associated with this exit and to continue with normal HASPINJR processing.

**8** Tells JES2 to cancel the job/job group; output (the incomplete JCL images listing) is produced.

## Exit 52

|                   12       Tells JES2 to purge the job/job group; no output is produced.

|                   **Note:** If register 10 contains 0 (the JCT is unavailable), JES2 ignores any return  
|                   code greater than 4.

---

### | **Coded example**

|                   Module HASX52A in SYS1.SHASSAMP contains a sample of exit 52.



---

## Chapter 65. Exit 53: JOB/JOBGROUP statement accounting field scan (JES2 user environment)

---

### Function

This exit allows you to provide an exit routine for scanning the JOB/JOBGROUP statement accounting field and for setting the corresponding fields in the appropriate JES2 control blocks. Exit 53 gets control for job/job group submitted through internal readers or TCP/IP NJE. For job/job group submitted through card readers, RJE, SNA and BSC NJE, and SPOOL reload, exit 3 is called to process the JOB/JOBGROUP statement accounting field.

You can use your exit routine to interpret the variables in the accounting field and, based on this interpretation, decide whether to cancel the job/job group.

Use this exit to record alterations to the accounting field; they will not appear on the user's output but are reflected in the JCT and the SMF type 6 record is written.

This exit is associated with the existing HASPRSCN accounting field scan sub-routine. You can write your exit routine as a replacement for HASPRSCN. Or, you can use a return code to direct input processing to call HASPRSCN after your exit routine has executed. In either case, when this exit is implemented and enabled, JES2 treats your exit routine as the functional equivalent of HASPRSCN. The specification of the ACCTFLD parameter on the JOBDEF initialization statement, which normally determines whether JES2 is to call HASPRSCN, becomes an additional factor in determining whether your exit routine is to be called. The exit is taken only if the ACCTFLD= parameter on the JOBDEF initialization statement is specified as either REQUIRED or OPTIONAL. The exit is not taken if ACCTFLD=IGNORE is specified. When it is called, your exit routine, rather than the ACCTFLD parameter, determines whether HASPRSCN is to be executed as an additional scan of the accounting field. For a complete explanation on how the ACCTFLD parameter is specified, see *z/OS JES2 Initialization and Tuning Reference*. The relationship of HASPRSCN to this exit is described in more detail in the "Other Programming Considerations" below.

---

### Related exits

Use Exit 52 to alter the accounting information and supply new accounting information at the time the entire JOB/JOBGROUP statement is first scanned.

---

### Recommendations for implementing Exit 53

To access the submitting information for a job on the internal reader, you can use the following code segment:

```
USING JRW,R2           Est JRW addressability
USING RIDCWKAR,JRW     Est IRWD addressability
USING SJB,R3           Est SJB addressability
SPACE 1
L   R2,X05xAREA        Get JRW address
L   R3,RIDSJB          Get submitters SJB address
L   R4,SJBJCT          Get submitters JCT address
```

## Exit 53

For STC and TSU INTRDRs, RIDSJB is zero because there is no submitting job/job group in these situations.

---

### Environment

#### Task

JES2 user environment. You must specify ENVIRON=USER on the \$MODULE macro.

#### AMODE/RMODE requirements

AMODE 31, RMODE ANY

#### Supervisor/problem program

JES2 places Exit 53 in supervisor state and PSW key 0.

#### Restrictions

See Appendix A, "JES2 exit usage limitations," on page 403 for a listing of specific instances when this exit will be invoked or not invoked.

#### Recovery

\$ESTAE recovery is in effect. Input processing recovery will attempt to recover from program check errors, including program check errors in the exit routine. However, as with every exit, your exit routine for this exit *should not* depend on JES2 for recovery. JES2 cannot anticipate the exact purpose of your exit routine. Therefore, it can provide no more than minimal recovery. You should provide your own recovery within your exit routine.

#### Job exit mask

Exit 53 is subject to suppression. You can suppress Exit 53 by either implementing exit 52 to set the 53rd bit in the job exit suppression mask (JCTXMASK) or by indicating the exit is disabled in the JES2 initialization stream.

#### Mapping macros normally required

\$JCT, \$JCTX, \$HCCT, \$BUFFER, \$HASPEQU, \$JRW

---

### Point of processing

This exit is taken from the JES2 user environment, the JOB/JOBGROUP statement processing routine of HASCINJR. , If HASPRSCN is to be called, the exit occurs after JES2 has scanned the entire JOB/JOBGROUP statement, but before the execution of the HASPRSCN accounting field scan subroutine. The JCT has been initialized with the JES2 and installation defaults; in addition, those fields of the JCT that correspond to JOB/JOBGROUP statement parameters other than accounting field parameters have been set. The accounting field image is passed in X053ACCT and the length in X053ACTL.

Table 11 on page 347 lists some of the fields in the JCT that you can modify.

Table 11. Selected JES2 Job Control Table Fields

| Field Name in JCT | Length (Bytes)              | Field                        | Bit      | Meaning  | Notes  |       |
|-------------------|-----------------------------|------------------------------|----------|--|--|-------|
| JCTSMFLG          | 1                           | SMF Flags                    | 0–1      | These bits are not part of the interface                           | –  |       |
|                   |                             |                              | 2        | If set, IEFUSO exit not taken                                      | 1,2  |       |
|                   |                             |                              | 3–4      | These bits are not part of the interface                           | –  |       |
|                   |                             |                              | 5        | If set, no type 6 SMF records produced                             | 1,2  |       |
|                   |                             |                              | 6        | If set, IEFUJP exit not taken                                      | 1,2  |       |
|                   |                             |                              | 7        | If set, no type 26 SMF record produced                             | 1,2  |       |
|                   |                             |                              | JCTJOBFL | 1  | Job Flags                                      | 0     |
| 1                 | TSO/E (foreground) job      | –                            |          |  |  |       |
| 2                 | Started task                | –                            |          |  |  |       |
| 3                 | No job/job group journaling | 1,2                          |          |  |  |       |
| 4                 | No output                   | 1,2                          |          |  |  |       |
| 5                 | TYPRUN=SCAN                 | 1,2,3                        |          |  |  |       |
| 6                 | TYPRUN=COPY                 | 2,3                          |          |  |  |       |
| 7                 | Job restartable             | 1,2,8                        |          |  |  |       |
| JCTJBOPT          | 1                           | Job Options                  | 0        | /*PRIORITY card was read and value is in priority field (JCTIPRIO) | –  |       |
|                   |                             |                              | 1        | /*SETUP card was read  | –  |       |
|                   |                             |                              | 2        | TYPRUN=HOLD was specified  | 1,2,4  |       |
|                   |                             |                              | 3        | No job log for this job  | 1,2,6,8  |       |
|                   |                             |                              | 4        | Execution batch job/job group                                      | 1,2  |       |
|                   |                             |                              | 5        | The job/job group was read through an internal reader              | –  |       |
|                   |                             |                              | 6        | The job was rerun  | –  |       |
| JCTJOBID          | 8                           | JES2 JOB/JOBGROUP identifier | 7        | This bit is not part of the interface                              | –  |       |
|                   |                             |                              | JCTJNAME | 8  | Job/Job Group name                             | 3     |
|                   |                             |                              | JCTPNAME | 20   | Programmer name                                | 3     |
|                   |                             |                              | JCTMCLAS | 1  | Message class                                  | 1,4   |
|                   |                             |                              | JCTJCLAS | 1  | Job class                                      | 1,4   |
|                   |                             |                              | JCTIPRIO | 1  | Priority                                       | 1,5   |
|                   |                             |                              | JCTROUTE | 4  | Route code of input device (binary)            | –     |
|                   |                             |                              | JCTINDEV | 8  | Input device name                              | –     |
|                   |                             |                              | JCTACCTN | 4  | Account number                                 | 1,6   |
|                   |                             |                              | JCTROOMN | 4  | Room number                                    | 1,6,8 |
|                   |                             |                              | JCTETIME | 4  | Estimated real-time job will run               | 1,6,8 |
|                   |                             |                              | JCTESTLN | 4  | Estimated count of output lines (in thousands) | 1,6,8 |

## Exit 53

Table 11. Selected JES2 Job Control Table Fields (continued)

| Field Name in JCT | Length (Bytes) | Field                                    | Bit | Meaning | Notes |
|-------------------|----------------|--|-----|---------|-------|
| JCTESTPU          | 4              | Estimated number of output cards punched |     |         | 1,6,8 |
| JCTESTBY          | 4              | Estimated number of SYSOUT bytes         |     |         | 8     |
| JCTESTPG          | 4              | Estimated number of output pages         |     |         | 8     |
| JCTFORMS          | 8              | Job Forms                                |     |         | 1,6,8 |
| JCTCPYCT          | 1              | Job copy count (binary)                  |     |         | 1,6,8 |
| JCTLINCT          | 1              | Lines per page (binary)                  |     |         | 1,6,8 |
| JCTPROUT          | 4              | Default print routing (binary)           |     |         | 1,7   |
| JCTPUOUT          | 4              | Default punch routing (binary)           |     |         | 1,7   |
| JCTPROCN          | 8              | Procedure DD name                        |     |         | 1,2,8 |

### Note:

1. Can be modified by installation routine.
2. Preset from JOBCLASS(v) initialization statement according to job class. Job class is not relevant to job groups, only jobs running within the scope of a job group.
3. Preset from JOB/JOBGROUP statement
4. From JOB/JOBGROUP statement, if specified; otherwise according to input device as established at JES2 initialization (for example, in RDR(nn)).
5. Exit 53 can use field JCTIPRIO to force a priority for a job subject to the limitations of the input device's priority increment and priority limit values. When exit 53 receives control, a value of C\*' in JCTIPRIO indicates a priority has not been forced by an exit routine. If you want to force a priority in exit 53, set JCTIPRIO to a value between 0 and 15 in the low-order four bits on the field.

**Note:** Whether you may set field JCTIPRIO and the allowable values depend on the specific exit.

6. Set by the routine (HASPRSCN) used by JES2 to scan the account field of the JOB/JOBGROUP statement. Exit 3 can specify that JES2 cannot call HASPRSCN.
7. Preset according to an input device initialization parameter (for example, RDR(nn) ). If not set at initialization, the parameter defaults to the job input source value (LOCAL or RMT(nnnn)). Can be modified by a /\*ROUTE statement after the scan exit.
8. Can be modified by a /\*JOBPARM statement after the scan exit.

---

## Extending the JCT control block

You can use the \$JCTX macro extension service to add, expand, locate, and delete extensions to the job control table (\$JCT) control block from this exit. For example, you can use these extensions to store job/job group-related information. Extensions that are added can be SPOOLED extensions that are available to all exits that read

the JCT or local extension that are available only to input processing exits (52, 53, 54, and 50) and the \$QMOD exit (51). The size of SPOOLed extensions is based on the SPOOL buffer size and is less than 3K. You can have up to 8K of local extension regardless of SPOOL buffer size.

---

## Programming considerations

1. The accounting field resides in a 144-byte work area pointed to by X053ACCT in the XPL passed to the exit in register 0.
2. If you need to verify the existence of a JOB/JOBGROUP rather than a started task (STC) or TSO/E logon, this can be done by comparing the JCTJOBID field to a "J". The presence of a "J" indicates the existence of a JOB and a presence of a "G" indicates JOB GROUP.
3. If you need to change the scheduling environment, use the JCTSCHEN field in the JCT.
4. The ACCTFLD parameter on the JOBDEF statement indicates whether JES2 should scan the accounting field of a JOB statement. For further details concerning the use of the ACCTFLD parameter, see *z/OS JES2 Initialization and Tuning Reference*.  
 If the ACCTFLD parameter indicates that the scan should be performed, and if this exit is implemented and enabled, input processing will call your exit routine to perform the scan. If your exit routine passes a return code of 0 or 4 to JES2, input processing will call the existing HASPRSCN accounting field scan subroutine after your routine has executed. Note that if both routines are to be called, your routine should not duplicate HASPRSCN processing. For example, your routine should not set the fields in the JCT that are set by HASPRSCN. However, if your routine passes a return code of 8 or 12 to JES2, it causes JES2 to suppress execution of HASPRSCN. If the ACCTFLD parameter indicates that the scan should be performed but this exit is disabled, only HASPRSCN will be called; your exit routine is not called and is not given the opportunity to allow or suppress HASPRSCN execution. If the ACCTFLD parameter indicates that a scan should not be performed, your exit routine will not be called, even if this exit is enabled, and execution of HASPRSCN is also suppressed.
5. The ACCTFLD parameter on the JOBDEF statement indicates whether JES2 should cancel a job/job group if the accounting field on the JOB/JOBGROUP statement is invalid or if a JCL syntax error has been detected during input processing. Note that your exit routine can affect this termination processing. For example, ACCTFLD=REQUIRED indicates that JES2 should scan the accounting field, the job/job group should be canceled if the accounting field is invalid, and the job/job group should be canceled if a JCL syntax error has been found. If you pass a return code of 8 to JES2, HASPRSCN is not called. Therefore, it cannot terminate a job/job group with an invalid accounting field, even though ACCTFLD=REQUIRED. Also note that HASPRSCN scans the accounting field passed in X053ACCT. Therefore, if your routine alters this field, you affect HASPRSCN processing.
6. The specification of the ACCTFLD parameter is stored in the HCCT, in field CCTJOPTS. If your exit routine is meant to completely replace HASPRSCN, you may want to access this field for use by your algorithm.
7. Typically, use this exit, rather than Exit 52, to alter the JCT directly. If you use Exit 52 to alter the JCT, later processing might override your changes. The job exit mask and the spool partitioning mask are exceptions. See note 2 of Exit 52 for more information.

8. An 80-byte work area pointed to by X053JXWR in the XPL is available for use by your routine. If your routine requires additional work space, use the \$GETMAIN macro to obtain storage, and the \$FREMAIN macro to return it to the system when your routine has completed.
9. When passing a return code of 12, your exit routine can pass an installation-defined error message to JES2 to be added to the JCL data set rather than the standard error message. To send an error message, generate the message text in your exit routine, move it to area pointed to by X053JXWR, and set the X053XSEM bit in X053RESP to one.

**Note:** The standard error message, \$HASP110, still appears in SYSLOG on this path, in addition to the installation-defined message. However, only the installation message will be placed in the JCL data set and no WTO will be issued for the installation-defined message unless Exit 53 issues the WTO itself.

10. If there is no accounting field on a JOB/JOBGROUP statement, the length passed by JES2 to the exit routine in R0 is zero. Your exit routine should take this possibility into account.
11. If you intend to use this exit to process nonstandard accounting field parameters, you should either suppress later execution of HASPRSCN or you should code your exit routine to delete nonstandard parameters before passing control to HASPRSCN. If you do neither, that is, if you allow HASPRSCN to receive the nonstandard parameters, it might cancel the job because of an illegal accounting field depending on how the ACCTFLD parameter on the JOBDEF statement is specified.  
If you change the length of the accounting field, you must reload the length into field JRWACCTL.
12. There are three job class fields (JCTJCLAS, JCTCLASS, and JCTAXCLS) in the JCT. JCTJCLAS is the initial job execution class as set during input processing and used when building the JQE during that processing. JCTCLASS is the actual execution class. After input processing it contains the same value as JCTJCLAS, but it might be updated when the job executes if a \$T command was used to update the job's class before execution. Therefore, JCTJCLAS and JCTCLASS could be different. JCTAXCLS is a copy of the actual execution class (JCTCLASS) that is propagated into the network JOB trailer. Do not use any exit routine to set the JCTAXCLS field.

If you intend to use an exit 53 routine to change the execution class of a job, you should set the X053JCLS field in the \$XPL passed in register 0., you should set the X053JCLS field in the \$XPL passed in register 0.

### 13. Accessing \$NITs

The \$NIT macro defines the characteristics of NJE nodes. The \$NITs are arranged in a table that is indexed by the node number. The table of \$NITs is in JES2 private storage and shadowed in a data space for use outside the JES2 address space. Installation exits can use three fields in the \$NJEWORk work area to access the \$NIT table. Installation exits can use these fields to access a \$NIT without regard for what address space they are in.

Because these fields are in the \$NJEWORk data area, you can address them using the 'NJE' prefix or the prefix for the device dependent work area in which the \$NJEWORk is embedded. Therefore, you can address NJENITAD as JRWNITAD in the \$JRW.

The following code accesses the origin node's NIT in an NJE JOB receiver exit:

```

        USING NIT,R1           Est NIT addressability
        SPACE 1
        $ARMODE ON,SYSSTATE=SET,INIT=CCTZEROS Enter AR mode

```

```

SPACE 1
LLGH R1,JRWRDNOD      Get origin node number
MH   R1,CCTNITSZ     Get NIT offset
AL   R1,JRWNITBL     Get NIT address
LAM  AR1,AR1,JRWNITAL Get NIT ALET

```

#### 14. Determining the device type

Most exits need to determine the type of device that they are being called under. The \$NJEWORk area has copies of \$DCT fields that can help identify the device. Which method you use depends on the condition that you are testing for.

The field NJEDEVTP (that corresponds to DCTDEVTP) is a one byte flag that can be used to test for classes of devices. A test of the DCTNET bit in NJEDEVTP indicates that the exit is being called under a networking device. A compare of the byte to DCTINR indicates that the exit is being called under an internal reader. See the \$DCT for the meaning of the bits in DCTDEVTP.

NJEDEVID corresponds to DCTDEVID. This is a 3 byte value that can uniquely identify a device. This is more often used when knowing what specific device you are running under. See the \$DCT for the meaning of the fields.

15. Do not issue a \$GETMAIN storage request for subpool 0 (the default for \$GETMAIN), or for subpool 240 or 250, which are translated to subpool 0 for authorized callers. Doing so would establish subpool 0 with an assigned key of 0, which can cause problems for a job step application that shares subpool 0 and requests subpool 0 storage, thereby obtaining the storage in key 0. To avoid this issue the exit should issue a \$GETMAIN request for subpool 229 or 230, which are high private subpools intended for use by authorized functions, whereas subpools 0-127 are in low private subpools and are part of the user region.
16. Do not use subpool 240 or 250 when obtaining storage for this exit. Do not use 0-127, because this will determine the key of the subpool for the duration of the job step. Using these subpools might result in errors when the exit receives control for address spaces that are created with the KEEPRGN attribute.

---

### Register contents when Exit 53 gets control

| Field Name | Description  |
|------------|--|
| 0          | Pointer to a parameter list with the following structure, mapped by \$XPL: |
|            | <b>XPLID</b>   |
|            | Eyecatcher   |
|            | <b>XPLLEVEL</b>  |
|            | Version level for base XPL   |
|            | <b>XPLXITID</b>  |
|            | Exit ID number   |
|            | <b>XPLEXLEV</b>  |
|            | Version number for exit  |
|            | <b>X053IND</b>   |
|            | Indicator byte   |
|            | <b>X053COND</b>  |
|            | Condition byte   |

| X053ECLT

| Job JECL processing indicator. On input, this field indicates if JES2  
| will process JECL statements for the current job. On output, the  
| exit program can change this field to override the JECL processing  
| for the current job. The following bits are defined for this field:

| X053J2CL

| If this bit is on, JES2 will process the JES2 JECL statements  
| for the current job according to the rules specified by the  
| JES2= keyword of the JECLDEF command and  
| initialization statement.

| If this bit is off, JES2 JECL statements for the current job  
| will be ignored.

| X053J3CL

| If this bit is on, JES2 will process the JES3 JECL statements  
| for the current job according to the rules specified by the  
| JES3= keyword of the JECLDEF command and  
| initialization statement.

| If this bit is off, JES3 JECL statements for the current job  
| will be ignored.

| X053RESP

| Response byte

| X053XSEM

| Exit supplied error message in X052JXWR

| X053SKIP

| Skip default accounting field scan

| X053KILL

| Kill current job/job group (queue job to OUTPUT  
| processing)

| XPLSIZE

| Size of parameter list, including base section

| X053ACCT

| Address of accounting field

| X053FLGX

| Pointer to exit flags (same as JRWFLAGX)

| X053JXWR

| 80-byte exit work area address (same as JCTXWRK)

| X053JCT

| JCT address

| X053JQE

| Update mode JQA address

| X053AREA

| JRW address

| X053JCLS

| The current job class for the job. This can be updated by the exit to  
| set a new job class for the job.

| 1 Address of a 3-fullword parameter list



**Word 1 (+0)**

points to the accounting field (JCTWORK in the JCT)

**Word 2 (+4)**

points to the exit flag byte, JRWFLAGX in the JRW

**Word 3 (+8)**

points to the JCTXWRK field in the JCT

|      |                             |
|------|-----------------------------|
| 2-10 | Not applicable              |
| 11   | Address of the HCCT         |
| 12   | Not applicable              |
| 13   | Available save area address |
| 14   | Return address              |
| 15   | Entry address               |

---

## Register contents when Exit 53 passes control back to JES2

|      |                |
|------|----------------|
| 0-13 | N/A            |
| 14   | Return address |
| 15   | Return code    |

A return code of:

|    |  |
|----|--|
| 0  | Tells JES2 that if any additional exit routines are associated with this exit, call the next consecutive exit routine. If there are no additional exit routines associated with this exit, use the current setting of the ACCTFLD parameter on the JOBDEF statement to determine whether to execute the HASPRSCN subroutine. |
| 4  | Tells JES2 to ignore any other exit routines associated with this exit and to use the current setting of the ACCTFLD parameter on the JOBDEF statement to determine whether to execute HASPRSCN.   |
| 8  | Tells JES2 to suppress execution of HASPRSCN and to complete job/job group card processing.  |
| 12 | Tells JES2 to cancel the job/job group because an illegal accounting field has been detected. Tells JES2 to suppress execution of HASPRSCN and to queue the job for output; output (the incomplete JCL images listing) is produced.  |

---

## Coded example

Module HASX53A in SYS1.SHASSAMP contains a sample of Exit 53.



---

## Chapter 66. Exit 54: JCL and JES2 control statement scan (JES2 user environment)

---

### Function

This exit allows you to provide an exit routine for scanning JCL and JES2 control statements for jobs/job groups submitted through internal readers (including TSO SUBMIT command) or TCP/IP NJE. For jobs submitted through card readers, RJE, SNA and BSC NJE, and SPOOL reload, exit 4 is called to process JCL and JES2 control statements (JECL). If this exit is implemented and enabled, it is taken whenever JES2 encounters a JCL or JES2 control statement.

**Note:** JOB/JOBGROUP statements are not included in the scan.

For JCL statements, your exit routine can interpret JCL parameters and, based on this interpretation, decide whether JES2 should cancel the job/job group, purge the job/job group, or allow the job/job group to continue normally. Your routine can also alter JCL parameters and supply additional JCL parameters. If necessary, in supplying expanded JCL data, your routine can pass a JCL continuation statement back to JES2 or add statements before or after the current JCL statement.

For JES2 control statements, your routine can interpret the JES2 control parameters and subparameters and, based on this interpretation, decide whether JES2 should cancel the job, purge the job, or allow the job to continue normally. For any JES2 control statement, you can write your exit routine as a replacement for the standard JES2 control statement processing, suppressing execution of the standard JES2 scan, or you can perform your own (partial) processing and then allow JES2 to execute the standard control statement processing. Also, your routine can alter a JES2 control statement and then pass the modified statement back to JES2 for standard processing, or your routine can pass an entirely new JES2 control statement back to JES2, to be read (and processed) before or after the current control statement.

This exit also allows you to process your own installation-specific JES2 control statements or to implement new, installation-specific subparameters for existing JES2 control statements.

This exit gets control when JES2 detects a JES2 control statement or JCL statement within a job/job group. JES2 also gives control to your exit routine when JES2 detects a JES2 control statement or JCL statement outside a job/job group. JES2 also gives control to your exit routine when it detects a JCL continuation statement.

---

### Recommendations for implementing Exit 54

To access the submitting information for a job/job group on the internal reader, you can use the following code segment:

```
USING JRW,R2           Est JRW addressability
USING RIDCWKAR,JRW    Est IRWD addressability
USING SJB,R3           Est SJB addressability
SPACE 1
L   R2,X05xAREA        Get JRW address
L   R3,RIDSJB          Get submitters SJB address
L   R4,SJBJCT          Get submitters JCT address
```

## Exit 54

For STC and TSU INTRDRs, RIDSJB is zero because there is no submitting job/job group in these situations.

---

## Environment

### Task

JES2 user environment. You must specify ENVIRON=USER on the \$MODULE macro.

### AMODE/RMODE requirements

RMODE ANY, AMODE 31

### Supervisor/problem program

JES2 places Exit 54 in supervisor state and PSW key 0.

### Restriction

JES2 does not invoke this exit for JCL from cataloged procedures. See Appendix A, JES2 exit usage limitations for other specific instances when this exit will be invoked or not invoked.

### Recovery

\$ESTAE recovery is in effect. The recovery routine established by JES2 attempts to recover from program check errors, including program check errors in the exit routine itself. However, as with every exit, your exit routine should not depend on JES2 for recovery. JES2 cannot anticipate the exact purpose of your exit routine. Therefore, it can provide no more than minimal recovery. You should provide your own recovery within your exit routine.

### Job exit mask

Exit 54 is subject to suppression. You can suppress Exit 54 by either implementing exit 52 to set the 54th bit in the job exit suppression mask (JCTXMASK) or disabling the exit in the JES2 initialization stream.

### Mapping macros normally required

\$HCCT, \$JCT, \$JCTX, \$BUFFER, \$HASPEQU, \$JRW

---

## Point of processing

This exit is taken from HASCINJR in the user environment. The exit occurs in input processing's main processing loop, after the entire JES2 control statement or JCL statement (including JCL continuations) has been read but before it has processed any keywords on the statement. The statement may be outside a valid job/job group (that is, when there is no current job structure active on the reader).

This exit is invoked for job/job group submitted through the internal reader or TCP/IP NJE. It is not invoked for jobs/job groups submitted through card readers, RJE, SNA and BSC NJE, and SPOOL reload.

## Programming considerations

1. This exit is taken once for each control statement (except for JOB/JOBGROUP statements) encountered by JES2. X054IND indicates whether the current statement is a JCL statement or a JES2 control statement. Your exit routine gets control for `/*` comment, `/*` (generated), and `/* PRIORITY` JES2 control statements.
2. During input processing, JES2 writes the JCL records to a JCL data set. If an error occurs during input processing, it is the JCL data set that is printed when the job/job group goes through output processing. If the job/job group is successfully processed by input processing, the JCL data set is the input for the converter. The converter produces a JCL images data set that is printed when the job/job group goes to output processing after being successfully processed by input processing.
3. Exit 54 is called for each card in a JCL statement (the original card and all continuations) and for each JES2 control statement. Each time the exit is called, it is passed the current card image and the statement buffer. The statement buffer is all the operands for the JCL statement or JES2 control statement concatenated in a single buffer. For example:

```
//OUTSET DD SYSOUT=H,OUTPUT=*.OUT1, COMMENT1
// DCB=(LRECL=8000,RECFM=FB,BLKSIZE=8000) COMMENT2
```

In this case the exit will be called 2 times, once for each card and will be passed (on both calls) the following data in the statement buffer (pointed to by X054STMT):

```
SYSOUT=H,OUTPUT=*.OUT1,DCB=(LRECL=8000,RECFM=FB,BLKSIZE=8000)
```

To alter the processing of the JCL statement or JES2 control card, the exit can either:

- Update the card image passed in X054CARD. This change will show up in the listing of the job/job group.
- Update the statement buffer in X054STMT to add or modify the operands. This change does not show up in the listing of the job and is not passed to conversion processing (it only affects keywords input processing scans from the JCL/JECL card). If you update the statement buffer (X054STMT) in Exit 54 and change the length of the buffer, you must update the field X054STME to indicate the new end of buffer (one byte past the last meaningful character).
- Add additional card images to the JCL stream.

Adding card images to the JCL stream can be accomplished by either queuing a single RJC B or a chain of RJC Bs to the XPL or by placing a card image to be placed after the current card into the area pointed to by X054JXWR and setting X054XSNC. In either case, when a card is added, the current card is re-scanned and the statement buffer is re-built. Exit 54 will be driven again for the updated statement, with X054SEC set to indicate this card has been presented to the exit previously.

When adding cards using RJC Bs, use the RGETRJCB service (located in HASCSRIP) to obtain a free RJC B; then add it to one of the three RJC B queues in the XPL. Use the \$CALL macro to invoke the RGETRJCB service. Register 1 on entry must be the JRW address. The RJC B address is returned in register 1. The 80-byte card image to be added is placed into the field RJC BCARD. RJC Bs are chained together using the RJC BRJC B field in the \$RJC B. They are added to the job/job group stream in the order they exist in the chain. To add an element to the chain you would move the current RJC B queue head in the \$XPL into the RJC BRJC B field of the last RJC B you are adding and then set

the address of the first RJCB element into the \$XPL queue head. Be aware that multiple exit 4s might be using these queues so ensure that you do not lose existing entries on the queue.

**X054RJCP**

Adds the card images before the first card in the current JCL statement or before the JES2 control card.

**X054RJCA**

Adds the card images after the last card in the current JCL statement. In this case, the cards are assumed not to be a continuation of the current JCL statement, and the JCL cards are not re-scanned.

**X054RJCC**

Adds the card images after the current card. It is the callers' responsibility to ensure that the proper continuation processing will occur.

When processing the last card in a JCL statement or when processing a JES2 control statement, the difference between adding a card to the X054RJCA queue and the X054RJCC queue is that the first will not rescan the current statement and the second will do.

You can also add a single card image after the current card using the X054JXWR field. In this case, the JCL statement will be re-scanned just as if the card was added to the X054RJCC queue. To add information to a JCL statement:

- a. Move a comma into the last byte of the operand on the JCL card image (X054CARD) that exit 54 is currently processing. The comma indicates additional information follows this JCL statement.
- b. Move the information you want to add to the JCL statement to the area pointed to by X054JXWR and set the X054XSNC bit in the X054RESP byte to one. Setting X054RESP to X054XSNC indicates that the installation has supplied an additional JCL statement image.
- c. Set register 15 to X'00' or X'04' depending on whether you want to invoke additional installation exits to process the statement.

You can also add an additional JCL statement to the job/job group by:

- a. Ensuring that the JCL card image that exit 54 is currently processing is the last for the current statement (X054LOPR is on). Exit 54 is processing the last JCL statement image if a comma is not in the last byte of the JCL operand on the card image.
- b. Placing the JCL statement in the area pointed to by X054JXWR and set the X054XSNC bit in the X054RESP byte to one. Setting X054RESP to X054XSNC indicates that the installation has supplied an additional JCL statement image.
- c. Setting register 15 to X'00' or X'04' depending on whether you want to invoke additional installation exits to process the JCL or JECL card.

For JECL statements, because there are no formal rules for the format of the statement, the statement buffer will contain all the text after the VERB on the JECL statement. The following is an example of a JOBPARM JECL statement and the associated statement buffer:

```
/*JOBPARM SYSAFF=(IBM1),COPIES=2 This is a comment
```

The statement buffer for this statement would contain:

```
SYSAFF=(IBM1),COPIES=2 This is a comment
```

The statement buffer contains the comment in this case (and any trailing blanks) because there is no formal rule stating where a JECL statement ends.

4. Updating the statement buffer is only valid for parameters that have \$STMTTABs in HASCSRIP.
5. Updates to the statement buffer are not passed to the converter and will not be seen by Exit 6 or Exit 60.
6. The following indicators in the XPL can assist you in adding a card image to the current JCL statement:

**X054LOPR**

Current card has the last operand in the JCL statement. There can be additional continued comments after the current card.

**X054QUOT**

A quoted string is being continued from the current card to the next card. Pay attention if a card is being added after this card.

**X054CCMT**

The current card is a continued comment. Operand added to this card or after this card will not be processed.

**X054LAST**

This is the last card image in the JCL or JECL statement.

7. To assist you in processing the operands on a statement, you can use either of these services to parse the statement buffer passed in X054STMT:
  - The \$SCAN facility can be used to parse the operands using the standard \$SCAN rules for statements. This gives you the flexibility of \$SCAN but the parsing rules are not the same as normal JCL. See the \$SCAN and \$SCANTAB macros for additional information.
  - The RCARDSCN service and \$STMTTAB macro can be used to parse the operands using standard JCL rules. This is the service used by JES2 input processing to parse the statement buffer. However, the RCARDSCN service only parses the operands and calls a processing routine to do all the conversions and storing of data. Conversion of data to binary to store into data areas is the responsibility of the processing routines. See the \$STMTTAB macro for more information.
8. To entirely replace standard JES2 control card processing (HASPRCCS) for a particular JES2 control statement, write your routine as a replacement version of the standard HASPRCCS routine and then pass a return code of 8 back to JES2 to suppress standard processing. Note that your routine becomes responsible for duplicating any HASPRCCS function you want to retain. If you merely want to supplement standard HASPRCCS processing, you can write your exit routine to perform the additional function and then, by passing a return code of 0 or 4, direct JES2 to execute the standard HASPRCCS routine.
9. To nullify a JES2 control statement, pass a return code of 8 to JES2 without using your exit routine to perform the function requested by the statement. Note that, based on what appears in the JCL images output data set, the user is not informed that the statement was nullified.
10. To modify a JES2 control statement, also use return code 8. Place the altered statement in the area pointed to by X054JXWR and set X054XSNC to one. If input processing is successful, the user will see the original statement in the output of the JCL images file, and the altered statement. Note that if you modify a JES2 control statement; then pass a return code of 0 or 4, JES2 carries out normal input (HASPRCCS) processing. The modified version of the statement will appear on the user's output in the JCL images file, but the

original statement will not appear unless you go directly to output phase (bypassing the converter); then, the user will see the original statement when the JCL data set is printed.

11. You also use return code 8 in processing your own installation-specific JES2 control statements. Write your exit routine to perform the function requested by the statement and then pass return code 8 to JES2 to suppress standard processing and thereby prevent JES2 from detecting the statement as "illegal."
12. Extend the JCT Control Block. You can use the \$JCTX macro extension service to add, expand, locate, and delete extensions to the job control table (\$JCT) control block from this exit. For example, you can use these extensions to store job/job group-related information. Extensions that are added can be SPOOLed extensions that are available to all exits that read the JCT or local extension that are available only to input processing exits (52, 53, 54, and 50) and the \$QMOD exit (51). The size of SPOOLed extensions is based on the SPOOL buffer size and is less than 3K. You can have up to 8K of local extension regardless of SPOOL buffer size.
13. To process your own installation-specific JES2 control statement subparameters, you should generally write your exit routine to replace standard HASPRCCS processing entirely. That is, write your exit routine to perform the functions requested by the standard parameters and subparameters, and those requested by any unique installation-defined subparameters on a statement. Then, from your exit, pass a return code of 8 back to JES2. Typically, because the parameters and subparameters on a JES2 control statement are interdependent, you will be limited to this method. However, if you have defined an installation-specific subparameter which can be processed independently of the rest of the control statement on which it appears, you can write your exit routine to process this subparameter alone, delete it, and pass a return code of 0 or 4 to JES2. JES2 can then process the remainder of the statement as a standard JES2 control statement.
14. When passing a return code of 12 or 16, it is also possible for your exit routine to pass an error message to JES2 for display at the operator's console. To send an error message, generate the message text in your exit routine, move it to the area pointed to by X054JXWR, and set the X054XSEM bit in X054RESP to one.
15. If you intend to use this exit to affect the JCT, your exit routine must ensure the existence of the JCT on receiving control. If the JCT has not been created when your exit routine receives control, the pointer to X054JXWR is zero. For example, when your exit routine receives control for a /\*PRIORITY statement, the JCT doesn't exist yet. In this case, your routine must store any data to be placed in the JCT until JES2 creates the JCT.
16. Your exit routine does not have access to the previous control card image. You should take this into account when devising your algorithm.
17. An 80-byte work area, pointed to by X054JXWR, is available for use by your exit routine. If your routine requires additional work space, use the \$GETMAIN macro to obtain storage (and the \$FREMAIN macro to return it to the system when your routine has completed).
18. Exit 54 can use field JCTIPRIO to force a priority for a job subject to the limitations of the input device's priority increment and priority limit values. When exit 54 receives control, a value of C\*' in JCTIPRIO indicates a priority has not been forced by an exit routine. If you want to force a priority in exit 54, set JCTIPRIO to a value between 0 and 15 in the low-order four bits on the field.



**Note:** Whether you can set field JCTIPRIO and the allowable values depend on the specific exit.

19. When this exit adds or modifies cards, whether the change is sent over NJE (including SPOOL offload) depends on the statement type and the setting of option flags in the \$XPL or \$RJCB. Modified JECL cards (original and modified card are both JECL) are not sent over NJE. By default, all other changes are sent over NJE. To limit changes to only the local node, you can set the X054RLOC in the XPL (affects the current card) or set the RJCB3LOC bit in any RJCBs that are added.

#### 20. Accessing \$NITs

The \$NIT macro defines the characteristics of NJE nodes. The \$NITs are arranged in a table that is indexed by the node number. The table of \$NITs is in JES2 private storage and shadowed in a data space for use outside the JES2 address space. Installation exits can use three fields in the \$NJEWORk work area to access the \$NIT table. Installation exits can use these fields to access a \$NIT without regard for what address space they are in.

Because these fields are in the \$NJEWORk data area, you can address them using the 'NJE' prefix or the prefix for the device dependent work area in which the \$NJEWORk is embedded. Therefore, you can address NJENITAD as JRWNITAD in the \$JRW.

The following code accesses the origin node's NIT in an NJE JOB receiver exit:

```

USING NIT,R1           Est NIT addressability
SPACE 1
$ARMODE ON,SYSSTATE=SET,INIT=CCTZEROS Enter AR mode
SPACE 1
LLGH R1,JRWRDNOD      Get origin node number
MH   R1,CCTNITSZ      Get NIT offset
AL   R1,JRWNTBL       Get NIT address
LAM  AR1,AR1,JRWNTAL  Get NIT ALET

```

#### 21. Determining the device type

Most exits need to determine the type of device that they are being called under. The \$NJEWORk area has copies of \$DCT fields that can help identify the device. Which method you use depends on the condition that you are testing for.

The field NJEDEVTP (that corresponds to DCTDEVTP) is a one byte flag that can be used to test for classes of devices. A test of the DCTNET bit in NJEDEVTP indicates that the exit is being called under a networking device. A compare of the byte to DCTINR indicates that the exit is being called under an internal reader. See the \$DCT for the meaning of the bits in DCTDEVTP.

NJEDEVID corresponds to DCTDEVID. This is a 3 byte value that can uniquely identify a device. This is more often used when knowing what specific device you are running under. See the \$DCT for the meaning of the fields.

22. Do not issue a \$GETMAIN storage request for subpool 0 (the default for \$GETMAIN), or for subpool 240 or 250, which are translated to subpool 0 for authorized callers. Doing so would establish subpool 0 with an assigned key of 0, which can cause problems for a job step application that shares subpool 0 and requests subpool 0 storage, thereby obtaining the storage in key 0. To avoid this issue the exit should issue a \$GETMAIN request for subpool 229 or 230, which are high private subpools intended for use by authorized functions, whereas subpools 0-127 are in low private subpools and are part of the user region.

---

## Register contents when Exit 54 gets control

The contents of the registers on entry to this exit are:

### Register

#### Contents

0 Pointer to a parameter list with the following structure, mapped by \$XPL:

#### Field Name

#### Description

#### XPLID

Eyecatcher

#### XPLLEVEL

Version level for base XPL

#### XPLXITID

Exit ID number

#### XPLEXLEV

Version number for exit

#### X054IND

Indicator byte

00 JCL card detected

04 JECL card detected

#### X054COND

Condition byte

#### X054CONT

Card is a continuation (not the first card of the JCL or JECL statement)

#### X054JOBP

/\*JOBPARM card detected

#### X054CMND

/\*\$ command card detected

#### X054SEC

This card has been passed to the exit previously for this job/job group (set if cards added before this card)

#### X054RESP

Response byte

#### X054XSNC

Exit supplied next card in X054JXWR

#### X054XSEM

Exit supplied error message in X054JXWR

#### X054JCMT

Skip processing card

#### X054KILL

Kill current job/job group (queue job to OUTPUT processing)

#### X054PURG

Purge current job/job group

**X054RLOC**

Changed or added cards are not sent through NJE (set RJC3LOC in current RJC)

**XPLSIZE**

Size of parameter list, including base section

**X054CARD**

80-byte card image address

**X054FLGX**

Pointer to exit flags (same as JRWFLAGX)

**X054JXWR**

80-byte exit work area address (same as JCTXWRK)

**X054JCT**

JCT address

**X054JQE**

Update mode JQA address

**X054AREA**

JRW address

**X054STMT**

Concatenated statement buffer. This is all the operands on all continuations cards for this statement

**X054STME**

End of statement+1 pointer (in buffer)

**X054STML**

Statement label

**X054STMV**

Statement verb

**X054RJCP**

RJCBs to add before the current JCL/JECL statement

**X054RJCA**

RJCBs to add after the current JCL/JECL statement

**X054RJCC**

RJCBs to add after the current card

**X054FLG1**

Statement flag byte

**X054LOPR**

Last operand is on the current card

**X054QUOT**

Unfinished quote at end of current card

**X054CCMT**

Current card is a continued comment

**X054LAST**

Last card in JCL or JECL statement

**1** Address of a 3-word parameter list with the following structure:

**Word 1**

(+0) address of the control statement image buffer

## Exit 54

### Word 2

(+4) points to the exit flag byte, JRWFLAGX, in the \$JRW

### Word 3

(+8) points to the JCTXWRK field in the \$JCT

|      |                          |
|------|--------------------------|
| 2-10 | Not applicable           |
| 11   | Address of the HCCT      |
| 12   | Not applicable           |
| 13   | Address of the save area |
| 14   | Return address           |
| 15   | Entry address            |

---

## Register contents when Exit 54 passes control back to JES2

Upon return from this exit, the register contents must be:

### Register

#### Contents

|        |                |
|--------|----------------|
| 0 - 13 | Unchanged      |
| 14     | Return address |
| 15     | Return code    |

A return code of:

|    |   |
|----|---|
| 0  | Tells JES2 that if any additional exit routines are associated with this exit, call the next consecutive exit routine. If there are no additional exit routines associated with this exit, perform standard input processing. |
| 4  | Tells JES2 to ignore any other exit routines associated with this exit and to perform standard input processing.  |
| 8  | For JES2 control statements and JCL statements, tells JES2 not to perform standard processing and just write the statement to the JCL data set.   |
| 12 | Tells JES2 to cancel the job because an illegal control statement has been detected; output (the incomplete JCL images listing) is produced.  |
| 16 | Tells JES2 to purge the job because an illegal control statement has been detected; no output is produced.  |

**Note:** For all JES2 control statements preceding the JOB card (X054PREJ on), a return code higher than 4 is ignored.

---

## Coded example

Modules HASX54A, HASX54B, and HASX54C in SYS1.SHASSAMP contains a samples of Exit 54.

---

## Chapter 67. Exit 55: NJE SYSOUT reception data set disposition

---

### Function

This exit allows an installation to change the default processing (delete) for a data set which failed RACF verification upon entering this node on a TCP/IP line. In this exit, you can:

- Continue default processing and delete the data set
- Accept the data set

---

### Environment

#### Task

General purpose subtask in NETSRV address space. You must specify ENVIRON=USER on the \$MODULE macro.

#### AMODE/RMODE requirements

RMODE ANY, AMODE 31

#### Supervisor/problem program

JES2 places Exit 55 in supervisor state and PSW key 0.

#### Recovery

Your exit routine should provide its own recovery.

#### Job exit mask

This exit is not subject to job exit mask suppression.

#### Mapping macros normally required

\$HASPEQU, \$HCCT, \$JCT, \$JCTX, \$NHD, \$PDDB, \$XPL, \$NJEWORK, \$SRW

---

### Point of processing

This exit is taken from HASCNJSR. JES2 passes control to this exit when RACF fails the verification for a SYSOUT data set received from another node on a TCP/IP line.

---

### Programming considerations

When rerouting the data set, your exit routine should ensure the data set has the proper authority for the target node. If your routine accepts SYSOUT already rejected by RACF, there will not be an audit record for the subsequent data set create. The owner of the data set is the userid of the job that created the SYSOUT, even if that userid could not own the data on your system and RACF does not validate the assigned userid. If you are using security labels, RACF assigns a SECLABEL of SYSLOW to the data set created.

## Expanding the JCT Control Block

You can add, expand, locate, or remove extensions to the job control table (\$JCT) control block from this exit using the \$JCTX macro extension service. For example, you can use these extensions to store job-related information. For more information, see *z/OS JES2 Macros*

## Related Exits

If you code Exit 55, it may also be necessary for you to code a parallel Exit 39 to provide the same function for SNA and BSC lines.

---

## Register contents when Exit 55 gets control

The contents of the registers on entry to this exit are:

### Register

#### Contents

|      |  |
|------|--|
| 0    | Not applicable   |
| 1    | Pointer to a parameter list with the following structure, mapped by \$XPL: |
|      | <b>Field Name</b>  |
|      | <b>XPLID</b><br>Eyecatcher ('\$XPL')                                       |
|      | <b>XPLLEVEL</b><br>The version level of \$XPL                              |
|      | <b>XPLXITID</b><br>The exit ID number                                      |
|      | <b>X055IND</b><br>Indicator byte   |
|      | <b>X055COND</b><br>Condition byte  |
|      | <b>X055RESP</b><br>Response byte   |
|      | <b>X055PDDB</b><br>PDDB address  |
|      | <b>X055JCT</b><br>JCT address  |
|      | <b>X055NDH</b><br>Data set header address                                  |
|      | <b>X055AREA</b><br>SRW address   |
| 2-10 | Not applicable   |
| 11   | Address of the HCCT  |
| 12   | Not applicable   |
| 13   | Address of the save area   |
| 14   | The return address   |

15 The entry address

---

## Register contents when Exit 55 passes control back to JES2

Upon return from this exit, the register contents must be:

### Register

#### Contents

- 0 Not applicable
- 1 Pointer to a parameter list with the following structure, mapped by \$XPL:

#### Field Name

#### Description

#### X055IND

Indicator byte.

#### X055COND

Condition byte.

#### X055RESP

Response byte. Set by exit before returning to JES2

#### X055RECV

If you set this bit on, JES2 can receive the data set.  
Otherwise, processing continues and the data set is deleted.

- 2-13 Not applicable.
- 14 Return address.
- 15 A return code.

A return code of:

- 0 Tells JES2 that if additional exit routines are associated with this exit, call the next consecutive exit routine. If no other exit routines are associated with this exit, continue with normal processing, which is determined by the particular exit point from which the exit routine was called.
- 4 Tells JES2 that even if additional exit routines are associated with this exit, ignore them; continue with normal processing, which is determined by the particular exit point from which the exit routine was called.

---

## Coded example

Module HASX55A in SYS1.SHASSAMP contains a sample of Exit 55.





---

## Chapter 68. Exit 56: Modifying an NJE data area before its transmission

---

### Function

This exit allows you to change an NJE data area before transmitting a job to another node through TCP/IP NJE. (See *Network Job Entry (NJE) Formats and Protocols* for more information about the various NJE data areas that can be transmitted across a network.) Before transmitting the NJE job, your installation might need to add, remove or change information to one or more of the following NJE data areas:

- NJE job header
- NJE data set header
- NJE RCCS (Record Characteristics Change Section) header
- NJE job trailer

Your installation might want to:

- Remove any installation-defined sections your installation added to the NJE job when exit 56 was processing the NJE job. However, it might not be necessary to remove any installation-defined sections because installation-defined sections are ignored when they are received at other nodes.
- Add or change information, such as accounting, security or scheduling information, needed by another node in the network.
- Extract information from user fields in JES2 defined control blocks or installation defined control blocks and transfer them to the NJE data areas.

---

### Related exits

Consider using:

- Exit 40 if you want to change the output characteristics associated with a SYSOUT data set before it prints at your node.
- Exits 2, 52, 47, or 57 to modify NJE job headers for jobs that are received for processing at your installation.
- Exit 56 to receive control for spool TCP/IP NJE lines.
- Exit 46 to receive control for SNA or BSC lines or spool offload.

---

### Recommendations for implementing Exit 56

If you want to remove an installation-defined section from the NJE data area passed to Exit 56, you should:

- Use XPLIND to determine the type of NJE data area that JES2 passed to Exit 56 for processing.
- Issue a \$NDHREM macro to remove the installation section.

---

### Environment

#### Task

JES2 General purpose subtask in NETSRV address space. You must specify ENVIRON=USER on the \$MODULE macro.

## AMODE/RMODE requirements

RMODE ANY, AMODE 31

## Supervisor/problem program

JES2 places Exit 56 in supervisor state and PSW key 0.

## Recovery

Your installation should provide its own recovery routine.

## Job exit mask

Exit 56 is subject to suppression. Your installation can either implement Exit 2 or Exit 52 to set the 56th bit in the job exit suppression mask (JCTXMASK) or disable the exit in the JES2 initialization stream.

## Mapping macros normally required

\$HASPEQU, \$PDDB, \$SCR, \$XPL, \$NHD, \$HCCT, \$JQE, \$JCT, \$JCTX, \$JOE, \$NJEWORK, \$JTW, \$STW

---

## Point of processing

JES2 invokes Exit 56 before transmitting a job while transmitting an NJE job across a TCP/IP line. Before invoking Exit 56, JES2:

- Builds the NJE data area in a 32K buffer
- Removes any JES2-specific sections from the NJE data area if JES2 is transmitting the NJE data area to another node in the network. The following NJE data areas contain a JES2 section:
  - Job Header
  - Job Trailer
- Initializes the \$XPL parameter and invokes Exit 56.
- After returning from Exit 56, JES2 examines the response byte (XPLRESP) in the \$XPL parameter list. If in Exit 56 you set XPLRESP to:
  - X056TERM, it indicates an error occurred. JES2 terminates the transmission of the NJE data area, and places the job in hold.
  - X056BYP, JES2 continues processing the remainder of the NJE job because Exit 56 transmitted the buffer that contained the NJE data area.

If XPLRESP has not been set, JES2 transmits the NJE data area.

---

## Programming considerations

The following are programming considerations for Exit 56:

- **Locating the JCT Control Block Extensions**

You can locate extensions to the job control table (\$JCT) control block from this exit using the \$JCTXGET macro. For example, you can use these extensions to retrieve job-related information from the \$JCTX control block to ship across the network in \$NHD macro sections. For more information, see *z/OS JES2 Macros*.
- **Accessing \$NITs**

The \$NIT macro defines the characteristics of NJE nodes. The \$NITs are arranged in a table that is indexed by the node number. The table of \$NITs is in JES2 private storage and shadowed in a data space for use outside the JES2 address space. Installation exits can use three fields in the \$NJEWORK work

area to access the \$NIT table. Installation exits can use these fields to access a \$NIT without regard for what address space they are in.

Because these fields are in the \$NJEWORK data area, you can address them using the 'NJE' prefix or the prefix for the device dependent work area in which the \$NJEWORK is embedded. Therefore, you can address NJENITAD as JRWNITAD in the \$JRW, JTWNITAD in the \$NJT, SRWNITAD in the \$SRW, and STWNITAD in the \$STW.

The following code accesses the origin node's NIT in an NJE JOB receiver exit:

```

USING NIT,R1           Est NIT addressability
SPACE 1
$ARMODE ON,SYSSTATE=SET,INIT=CCTZEROS Enter AR mode
SPACE 1
LLGH R1,JRWRDNOD      Get origin node number
MH   R1,CCTNITSZ      Get NIT offset
AL   R1,JRWNITBL      Get NIT address
LAM  AR1,AR1,JRWNITAL Get NIT ALET

```

- **Determining the device type**

Most exits need to determine the type of device that they are being called under. The \$NJEWORK area has copies of \$DCT fields that can help identify the device. Which method you use depends on the condition that you are testing for.

The field NJEDEVTP (that corresponds to DCTDEVTP) is a one byte flag that can be used to test for classes of devices. A test of the DCTNET bit in NJEDEVTP indicates that the exit is being called under a networking device. A compare of the byte to DCTINR indicates that the exit is being called under an internal reader. See the \$DCT for the meaning of the bits in DCTDEVTP.

NJEDEVID corresponds to DCTDEVID. This is a 3 byte value that can uniquely identify a device. This is more often used when knowing what specific device you are running under. See the \$DCT for the meaning of the fields.

## Register contents when Exit 56 gets control

The contents of the registers on entry to this exit are:

### Register

#### Contents

- 0 Not applicable
- 1 Parameter List Address having the following structure:

#### Field Name

#### XPLID

Eyecatcher ('\$XPL')

#### X056VERN

Parameter list version

#### XPLXITID

Exit identifier

#### XPLEXLEV

Version level of the exit

#### X056IND

Indicates the type of NJE data area JES2 passed to Exit 56 for processing. A value of:

## Exit 56

### X056HDR

Indicates an NJE job header was passed to Exit 56 for processing.

### X056TRL

Indicates an NJE job trailer was passed to Exit 56 for processing.

### X056DSH

Indicates an NJE data set header was passed to Exit 56 for processing.

### X056RCCS

Indicates an NJE RCCS header was passed to Exit 56 for processing.

### X056COND

Condition byte

### X056R1ST

Indicates that this RCCS header precedes the first data record.

### X056RESP

Response byte.

### X056HADR

Contains the address of the NJE data area.

### (Reserved field)

This field is reserved for Exit 56 to keep the same offsets of the XPL mapping as Exit 46. This value is always zero for Exit 56.

### X056JQE

Address of read mode JQA.

### X056JCT

Contains the address of the \$JCT.

### X056PDDB

Contains the address of the \$PDDB if Exit 56 is processing an NJE data set header. If Exit 56 is processing an NJE job header or trailer, a 0 is passed as the address.

### X056JOA

Contains the address of the artificial JOE (JOA) if Exit 56 is processing an NJE data set header. If Exit 56 is processing an NJE job header or trailer, a 0 is passed as the address.

**Note:** If the exit must update JOE fields, it should obtain and return an update mode JOA. For more information, see "Checkpoint control blocks for JOEs" on page 415.

### X056AREA

Contains the address of the NJEWORK area (JTW or STW) for the transmitter device sending the header.

### X056SIZE

Indicates the length of the \$XPL parameter list for Exit 56.

2-10 Not applicable

11 Address of the HCCT

|    |                                |
|----|--------------------------------|
| 12 | Not applicable                 |
| 13 | Address of the save area       |
| 14 | The return address             |
| 15 | Entry point address of Exit 56 |

---

## Register contents when Exit 56 passes control back to JES2

Upon return from this exit, the register contents must be:

### Register

|      | Contents  |
|------|---|
| 0    | Not applicable  |
| 1    | Address of the \$XPL parameter list, which has the following structure: <ul style="list-style-type: none"> <li><b>XPLID</b><br/>Eye-catcher for the \$XPL</li> <li><b>X056VERN</b><br/>Indicates the version number of Exit 56</li> <li><b>XPLXITID</b><br/>Exit identifier</li> <li><b>XPLEXLEV</b><br/>Version level of the exit</li> <li><b>X056IND</b><br/>Indicator byte</li> <li><b>X056COND</b><br/>Condition byte</li> <li><b>X056RESP</b><br/>Indicates the processing Exit 56 determined JES2 should perform after processing the NJE data area. A value of:               <ul style="list-style-type: none"> <li><b>X056TERM</b><br/>Indicates Exit 56 determined the NJE data area should not be transmitted. JES2 will discard the remainder of the NJE job.</li> <li><b>X056BYP</b><br/>Indicates JES2 should not transmit the NJE data area. JES2 will continue to process the remainder of the NJE job.</li> </ul> </li> <li><b>X056SIZE</b><br/>Indicates the length of the \$XPL parameter list for Exit 56.</li> </ul> |
| 2-13 | Not applicable to Exit 56   |
| 14   | Return address  |
| 15   | Exit effector return code   |

A return code of:

|   |   |
|---|---|
| 0 | Indicates JES2 should continue processing the job.  |
| 4 | Indicates JES2 should continue processing the job, but ignore any additional exits associated with Exit 56. |

## Coded example

Module HASX56A in SYS1.SHASSAMP contains a sample of Exit 56. Module HASXJECL in SYS1.SHASSAMP also contains an example.

---

## Chapter 69. Exit 57: Modifying an NJE data area before receiving the rest of the NJE job

---

### Function

This exit allows you to:

- Examine and change an NJE data area before receiving the rest of the NJE job from another node through TCP/IP NJE.
- Add, expand, locate, or remove an extension to the \$JCT control block where accounting information can be stored.

Before receiving an NJE job, your installation might need to add, remove or change information to one or more of the NJE data areas below. See *Network Job Entry (NJE) Formats and Protocols* for more information about the various NJE data areas that can be transmitted across a network.

- NJE job header
- NJE data set header
- NJE RCCS (Record Characteristics Change Section) header
- NJE job trailer

Your installation might want to:

- Remove any installation-defined sections your installation added to the NJE job when exit 56 was processing the NJE job.
- Add or change information, such as accounting or security information, needed by another node in the network.
- Extract information from the NJE data areas and transfer them to user fields in JES2 defined control blocks or installation defined control blocks.

---

### Related exits

If you want to change the output characteristics associated with a SYSOUT data set, consider using exit 40. Exit 57 only receives control for TCP/IP NJE. If you code exit 57, you may also need a Exit 47 to handle jobs received on SNA or BSC lines or through spool offload.

---

### Environment

#### Task

General purpose subtask in NETSRV address space. You must specify ENVIRON=USER on the \$MODULE macro.

#### AMODE/RMODE requirements

RMODE ANY, AMODE 31

#### Supervisor/problem program

JES2 places Exit 57 in supervisor state and PSW key 0.

#### Recovery

Your installation should provide its own recovery routine.

## Job exit mask

Exit 57 is subject to suppression. The installation can suppress the exit either by implementing exit 2 to set the 57th bit in the job exit suppression mask (JCTXMASK) or by indicating the exit is disabled in the JES2 initialization stream.

## Mapping macros normally required

\$HASPEQU, \$PDDB, \$SCR, \$XPL, \$NHD, \$HCCT, \$JQE, \$JCT, \$JCTX, \$JOE, \$NJEWORK, \$JRW, \$SRW

---

## Point of processing

JES2 invokes Exit 57 before receiving a job while performing receiving an NJE job across a TCP/IP line. Before invoking Exit 57 JES2:

- Allocates a dummy \$JCT and \$JQE. JES2 initializes these data areas with minimal information.
- Receives the NJE data area and invokes Exit 57 to perform installation-specific processing.
- After returning from Exit 57, JES2 determines if exit 57 indicated whether the NJE data area should be received. If exit 57 indicated the NJE data area should not be received, JES2 places the NJE job in hold on the transmitting node. Otherwise, JES2 continues to process the NJE job. You cannot use this exit to update IBM-defined JCT or JQE fields in the dummy JCT and dummy JQE, respectively. You can, however, update user-defined fields (such as JCTUSERx) or any \$JCTX extensions you have created. JES2 propagates changes to 'user' fields to the \$JCT and \$JQE.

---

## Programming considerations

The following are programming considerations for Exit 57:

- If the exit is being invoked for a job header, the JQE address passed points to a dummy JQE (as indicated by X057BJQE). See "Checkpoint control blocks" on page 413 for more information.
- **Extending the JCT Control Block**  
You can add, expand, locate, or remove extensions to the job control table (\$JCT) control block from this exit using the \$JCTX macro extension service. For example, you can use these extensions to store job-related information. For more information, see *z/OS JES2 Macros*.
- **Accessing \$NITs**  
The \$NIT macro defines the characteristics of NJE nodes. The \$NITs are arranged in a table that is indexed by the node number. The table of \$NITs is in JES2 private storage and shadowed in a data space for use outside the JES2 address space. Installation exits can use three fields in the \$NJEWORK work area to access the \$NIT table. Installation exits can use these fields to access a \$NIT without regard for what address space they are in.  
Because these fields are in the \$NJEWORK data area, you can address them using the 'NJE' prefix or the prefix for the device dependent work area in which the \$NJEWORK is embedded. Therefore, you can address NJENITAD as JRWNITAD in the \$JRW, JTNITAD in the \$NJT, SRWNITAD in the \$SRW, and STWNITAD in the \$STW.

The following code accesses the origin node's NIT in an NJE JOB receiver exit:



```

USING NIT,R1          Est NIT addressability
SPACE 1
$ARMODE ON,SYSSTATE=SET,INIT=CCTZEROS Enter AR mode
SPACE 1
LLGH R1,JRWRDNOD     Get origin node number
MH   R1,CCTNITSZ     Get NIT offset
AL   R1,JRWNITBL    Get NIT address
LAM  ARI,ARI,JRWNITAL Get NIT ALET

```

- **Determining the device type**

Most exits need to determine the type of device that they are being called under. The \$NJEWORK area has copies of \$DCT fields that can help identify the device. Which method you use depends on the condition that you are testing for.

The field NJEDEVTP (that corresponds to DCTDEVTP) is a one byte flag that can be used to test for classes of devices. A test of the DCTNET bit in NJEDEVTP indicates that the exit is being called under a networking device. A compare of the byte to DCTINR indicates that the exit is being called under an internal reader. See the \$DCT for the meaning of the bits in DCTDEVTP.

NJEDEVID corresponds to DCTDEVID. This is a 3 byte value that can uniquely identify a device. This is more often used when knowing what specific device you are running under. See the \$DCT for the meaning of the fields.

---

## Register contents when Exit 57 gets control

The contents of the registers on entry to this exit are:

### Register

#### Contents

- 0 Not applicable to Exit 57
- 1 Parameter List Address having the following structure:

#### Field Name

#### XPLID

Eyecatcher ('\$XPL')

#### X057VERN

Indicates the version number of Exit 57

#### XPLXITID

Exit identifier - 57

#### XPLEXLEV

Version level of the exit

#### X057IND

Indicates the type of NJE data area JES2 passed to Exit 57 for processing. A value of:

#### X057HDR

Indicates an NJE job header was passed to Exit 57 for processing.

#### X057TRL

Indicates an NJE job trailer was passed to Exit 57 for processing.

#### X057DSH

Indicates an NJE data set header was passed to Exit 57 for processing

## Exit 57

### X057RCCS

Indicates an NJE RCCS header was passed to Exit 57 for processing.

### X057BJQE

Indicates that the JQE address in field X057JQE points to a working copy of the JQE that has not yet been added to the job queue. The working copy should not be used in services that expect the address of a real JQE.

### X057COND

Condition byte.

### X057RESP

Response byte.

### X057HADR

Contains the address of the NJE data area.

### (Reserved field)

This field is reserved for Exit 57 to keep the same offsets of the XPL mapping as Exit 47. This value is always zero for Exit 57.

### X057JQE

Contains the address of an update mode JQA.

### X057JCT

Contains the address of the \$JCT.

### X057PDDB

Contains the address of the \$PDDB if Exit 57 is processing an NJE data set header. If Exit 57 is processing an NJE job header or trailer, a 0 is passed as the address.

### X057AREA

Contains the address of the NJEWORK area (JRW or SRW) for the receiver.

### X057SIZE

Indicates the length of the \$XPL parameter list for Exit 57.

|      |                                |
|------|--------------------------------|
| 2-10 | Not applicable                 |
| 11   | Address of the HCCT            |
| 12   | Not applicable                 |
| 13   | Address of the save area       |
| 14   | The return address             |
| 15   | Entry point address of Exit 57 |

---

## Register contents when Exit 57 passes control back to JES2

Upon return from this exit, the register contents must be:

### Register

#### Contents

|   |  |
|---|--|
| 0 | Not applicable to Exit 57  |
| 1 | Address of the \$XPL parameter list which has the following structure: |

### X057IND

Condition byte

**X057COND**

Response byte

**X057RESP**

Indicates the processing Exit 57 determined JES2 should perform after processing the NJE data area. A value of:

**X057TERM**

Indicates Exit 57 determined the NJE data area should not be received. JES2 will stop processing the rest of the NJE job.

2-13 Not applicable to Exit 57

14 Return address

15 Exit effector return code

A return code of:

0 Indicates JES2 should continue processing the job.

4 Indicates JES2 should continue processing the job, but ignore any additional exits associated with this exit.

---

**Coded example**

Module HASX57A in SYS1.SHASSAMP contains a sample of Exit 57. Module HASXJECL in SYS1.SHASSAMP also contains an example.



---

## Chapter 70. Exit 58: Subsystem interface (SSI) end-of-step

---

### Function

This exit gains control once a job step completes. This exit controls the return code for the step and whether or not the job will continue.

---

### Environment

#### Task

User address space. You must specify ENVIRON=USER on the \$MODULE macro.

#### AMODE/RMODE requirements

RMODE ANY, AMODE 31

#### Supervisor/problem program

JES2 places Exit 58 in supervisor state and PSW key 0.

#### Recovery

ESTAE recovery is in effect. However, as with every exit, your exit routine *should not* depend on JES2 for recovery. JES2 cannot anticipate the exact purpose of your exit routine and can therefore provide no more than minimal recovery. Your exit routine should provide its own recovery.

#### Job exit mask

This exit point is not subject to job exit mask suppression.

#### Mapping macros normally required

\$HASB, \$HASPEQU, \$HCCT, \$MIT, \$SJB

---

### Point of processing

This exit is taken from HASCJBTR after JES2 has located the SJB (subsystem job block).

---

### Programming considerations

#### Expanding the JCT Control Block

If the address of the \$JCT is contained in field SBJCT, you can add, expand, locate, or remove extensions to the job control table (\$JCT) control block from this exit using the \$JCTX macro extension service. For example, you can use these extensions to store job-related information. For more information, see *z/OS JES2 Macros*.

---

### Register contents when Exit 58 gets control

The contents of the registers on entry to this exit are:

## Exit 58

### Register

#### Contents

|      |   |
|------|---|
| 0    | Not applicable to Exit 58   |
| 1    | Parameter list address with the following structure:<br><b>XPLID</b><br>Eyecatcher ('\$XPL')<br><b>XPLLEVEL</b><br>Indicates the version number of Exit 58<br><b>XPLXITID</b><br>Exit identifier - 58<br><b>XPLEXLEV</b><br>Version level of the exit<br><b>X058IND</b><br>Indicates byte (not used)<br><b>X058COND</b><br>Condition byte (condition when the step ended):<br><b>X058STAB</b><br>Step ABENDed (X058STPA set)<br><b>X058RESP</b><br>Response byte - action to take after exit returns (may be pre-set):<br><b>X058SRST</b><br>Restart job after this step<br><b>X058SRSH</b><br>Hold job after restart<br><b>XPLSIZE</b><br>Size of exit 58 parameter list, including base section<br><b>X058SJB</b><br>\$SJB address<br><b>X058JCT</b><br>\$JCT address<br><b>X058PSN</b><br>Name on EXEC PGM= JCL card<br><b>X058PSS</b><br>Name on EXEC PROC= JCL card<br><b>X058STPC</b><br>Step completion code<br><b>X058STPA</b><br>Step ABEND code |
| 2-10 | Not applicable  |
| 11   | Address of HCCT   |
| 12   | Not applicable  |
| 13   | Address of an available save area   |
| 14   | The return address  |

15 The entry address

---

## Register contents when Exit 58 passes control back to JES2

Upon return from this exit, the register contents must be:

### Register

#### Contents

- |      |  |
|------|--|
| 0    | Not applicable to Exit 58  |
| 1    | Address of the \$XPL parameter list which was passed in possibly altering the following: |
|      | <b>Field Name</b>  |
|      | <b>X058RESP</b><br>Response byte – action to take after exit returns:                    |
|      | <b>X058SRST</b><br>Restart job after this step   |
|      | <b>X058SRSH</b><br>Hold job after restart  |
|      | <b>X058STPC</b><br>Step completion code  |
|      | <b>X058STPA</b><br>Step ABEND code   |
| 2-13 | Not applicable to Exit 58  |
| 14   | Return address   |
| 15   | Exit effector return code  |

A return code:

- |   |   |
|---|---|
| 0 | Indicates JES2 should continue processing the job.  |
| 4 | Indicates JES2 should continue processing the job, but ignore any additional exits associated with this exit. |

## Exit 58



---

## Chapter 71. Exit 59: JES2 converter exit (subtask)

This information describes JES2 installation exit 59.

---

### Function

This exit gets control when the z/OS interpreter is called after the z/OS converter is called in the JES2CI address space. This function is activated by specifying INTERPRET=JES on the JOBDEF initialization statement. When given control, the job's SWA blocks have been built in memory but have not yet been written to spool. The exit can examine the SWA blocks to extract information that is required to process the job.

---

### Related exits

This exit gets control after the final call to Exit 6 or Exit 60. After this exit returns, processing writes out the SWA blocks for the job, conversion phase processing in the JES2 main task is posted and exit 44 is called. Use exit 44 if you choose to alter any fields in the job queue element (\$JQE). Altering fields in the \$JQE in Exit 59 will not be successful because you are in the user environment.

---

### Recommendations for implementing Exit 59

Exit 59 is similar to Exit 60 because it is also run in the JES2CI address space. In this environment, this exit does not have access to JES2 private storage data areas such as the HCT and the converter PCE.

One function of this exit is to enforce installation standards. If the exit fails a job, it should set a return code of 8 in register 15 before returning to JES2.

If you decide to fail the job, issue error messages to inform the operator and the user of the reason for the failure. Any WTO issued by this exit is placed into the system message data set for the job.

---

### Environment

The following environment requirements apply to Exit 59.

#### Task

JES2 user (JES2CI address space). You must specify ENVIRON=USER on the \$MODULE or \$ENVIRON macro.

#### Restrictions

- Exit 59 runs in the JES2CI address space and cannot access any JES2 private address space data areas, such as the HCT.
- Do not attempt to modify checkpointed data from this exit.
- See Appendix A, "JES2 exit usage limitations," on page 403 for a listing of specific instances when this exit will be invoked or not invoked.
- Exit 59 must be MVS reentrant. See "Reentrant Code Considerations" in Chapter 2 for more information.

- Do not alter any fields in the \$JQE. The changes will not be successful because you are in the subtask environment.
- Do not attempt to control the processing of the MVS converter by changing the C/I text at Exit 59. The converter does not examine the C/I text returned from the exit to determine what changes have been made. For example, you cannot use this exit to execute a procedure other than the one initially named on the EXEC statement, nor can you use this exit to control the printing of JCL statement images by altering the MSGLEVEL parameter on the JOB statement.

## **AMODE/RMODE requirements**

RMODE ANY, AMODE 31

## **Supervisor/problem program**

JES2 places Exit 59 in supervisor state and PSW key 0.

## **Recovery**

ESTAE recovery is in effect. However, no exit routine should depend on JES2 for recovery. Because JES2 cannot identify the exact purpose of your exit routine, it can provide only minimal recovery. Your exit routine should provide its own recovery.

If JES2's recovery is entered, the current job will be failed.

## **Job exit mask**

Exit 59 is subject to suppression. The installation can implement exit 2 to set the 59th bit in the job exit suppression mask (JCTXMASK) or the installation can indicate the exit is disabled in the JES2 initialization stream.

## **Storage recommendations**

- Private subpool that resides below 16-megabytes
- Word 1 in register 1 contains the address of a 16-byte work area

## **Mapping macros typically required**

\$CIWORK, \$CIPARM, \$DTE, \$DTECNV, \$HASPEQU, \$HCT, \$JCT, \$JCTX, \$MIT, \$XIT

---

## **Point of processing**

This exit is taken from HASCCNVS after the interpreter has been called for the job and after processing any OUTPUT statements that apply to JES managed data sets (JESDS data set). At this point, the SWA blocks for the job are in memory and available to the exit for inspection. After calling the exit, the SWA blocks are written to spool and the converter PCE is posted to complete conversion processing for the job (including calling Exit 44).

---

## **Programming considerations**

### **Expanding the JCT Control Block**

If the address of the \$JCT is contained in field SBJCT, you can add, expand, locate, or remove extensions to the job control table (\$JCT) control block from this exit using the \$JCTX macro extension service. For example, you can use these

extensions to store job-related information. For more information, refer to *z/OS JES2 Macros*.

---

## Register contents when Exit 59 gets control

The contents of the registers on entry to this exit are:

| Register | Contents  |
|----------|---|
| 0        | Not applicable to Exit 59.  |
| 1        | Parameter list address with the following structure: <ul style="list-style-type: none"> <li><b>XPLID</b><br/>Eyecatcher ('\$XPL')</li> <li><b>XPLLEVEL</b><br/>Indicates the version number of Exit 59</li> <li><b>XPLXITID</b><br/>Exit identifier - 59</li> <li><b>XPLEXLEV</b><br/>Version level of the exit</li> <li><b>X059IND</b><br/>Indicator byte (not used)</li> <li><b>X059COND</b><br/>Condition byte               <ul style="list-style-type: none"> <li><b>X059FAIL</b><br/>Interpreter failed</li> </ul> </li> <li><b>X059RESP</b><br/>Response byte (not used)</li> <li><b>X059WORK</b><br/>16 byte work area address</li> <li><b>X059IRET</b><br/>Address of Interpreter RC</li> <li><b>X059CNVW</b><br/>JES2 DTE work area address</li> <li><b>X059JCT</b><br/>JCT address</li> <li><b>X059CIW</b><br/>CIWORK data area address</li> </ul> |
| 2-10     | Not applicable  |
| 11       | Address of the \$HCT  |
| 12       | Not applicable  |
| 13       | Address of an available save area   |
| 14       | Return address  |
| 15       | Entry address   |

---

## Register contents when Exit 59 passes control back to JES2

Upon return from this exit, the register contents must be:

### Register

#### Contents

- |      |  |
|------|--|
| 0    | Not applicable to Exit 59                                |
| 1    | Address of the \$XPL parameter list which was passed in. |
| 2-13 | Not applicable to Exit 59.                               |
| 14   | Return address   |
| 15   | Return code  |

A return code of:

- |   |   |
|---|---|
| 0 | Tells JES2 that if any additional exit routines are associated with this exit, execute the next consecutive exit routine. If there are no more exit routines associated with this exit point, continue with normal JES2 processing. Normal processing is to queue the job for execution if conversion and interpretation processing was successful. |
| 4 | Tells JES2 to ignore any additional exit routines associated with this exit and continue with normal processing. Normal processing is to queue the job for execution if conversion and interpretation processing was successful.  |
| 8 | Tells JES2 to bypass execution and cancel the job; the job is queued for output rather than for execution.  |

---

## Chapter 72. Exit 60: JES2 converter exit (subtask)

This information describes JES2 installation exit 60.

---

### Function

This exit gets control when conversion processing occurs in the JES2CI address space. It allows you to provide an exit routine for scanning resolved Converter/Interpreter (C/I) text. If this exit is implemented and enabled, it is taken after the converter has converted each JCL statement into C/I text and once after all of the JCL for a particular job has been converted to C/I text.

If you are running conversion in the JES2 address space, then exit 6 is taken at the same point in processing as this exit.

You can use your exit routine to:

- Interpret C/I text and, based on this interpretation, decide whether JES2 should either cancel the job at the end of conversion processing or allow it to continue with normal execution.
- Pass messages to the converter that it will write to the JCLMSG data set for the job.
- Modify the C/I text.

After the converter has processed the entire job, this exit again allows you to direct JES2 either to cancel the job or to allow it to continue with normal execution.

C/I text is represented by 'keys' that identify the various JCL parameters. These keys are documented in the JES2 assembly, HASPDOG, which calls macros IEFVKEYS and IEFTXTFT, which are distributed in SYS1.MODGEN. Specifying KEYS on \$MODULE causes IEFVKEYS to be expanded; specifying TEXT on \$MODULE causes IEFTXTFT to be expanded. IEFVKEYS contains the definition of the values for each key, and IEFTXTFT contains the definition of the format of the Converter/Interpreter text. For more information about C/I text, see *z/OS MVS Installation Exits*.

---

### Related exits

Exit 60 only gets control when the converter is called in the JES2CI address space (when JOBDEF INTERPRET=JES). If conversion is being in the JES2 address space, use exit 6 to perform the equivalent exit 60 function.

Use exit 44 if you need to alter any fields in the job queue element (\$JQE). Altering fields in the \$JQE in Exit 6 will not be successful because you are in the subtask environment.

---

### Recommendations for implementing Exit 60

Unlike exit 6, exit 60 is run in the JES2CI address space. In this environment, the exit does not have access to JES2 private storage data areas such as the HCT and the converter PCE.

It is important to remember that Exit 60 is invoked because either:

## Exit 60

- The converter just completed converting a JCL statement to C/I text
- The converter completed processing the entire job.

You could implement Exit 60 to keep certain counters—for instance, the number of DD cards received. Then, when the JCL for the entire job has been processed, the second part of your routine, the part that receives control when the code in R0 is 4 (or X060IND is set to X060CEND), can determine whether to allow the job to continue based on the contents of these counters.

You should use extreme caution when modifying C/I text. If any of your changes cause a job to fail (because of an interpreter error), there will be no correlation of the error with the resulting abend on the user's output. To modify or examine the C/I text:

- Ensure register 0 contains a X'00' (or X060IND is set to X060TEXT) to indicate the invocation of Exit 60 is to process a converted JCL statement.
- Use any information from the C/I text for any installation-written control blocks.
- Make any necessary modifications to the C/I text. *z/OS MVS Installation Exits* describes the rules for changing C/I text to ensure the changes you make will not cause the other problems in your installation, such as loss of data, loss of integrity and performance.

### Note:

- You may want to issue messages to the JCLMSG data set to track the changes you make to the C/I text since none of the changes you make will be reflected in the job's output. However, the changes you make will be reflected in the jobs SWA control blocks.
- If you need to change the job class or the job priority, use the JCTJCLAS or JCTIPRIO fields in the JCT. When conversion and all Exit 60 processing is completed for a job, JES2 will use these fields to update the corresponding JQE fields, JQEJCLAS and JQEPRIO. JES2 also ensures that these changes are checkpointed.
- If you need to change the scheduling environment you should update the internal text for the job card. The converter validates the scheduling environment after Exit 6 receives control. If the scheduling environment is not valid, JES2 fails the job with a JCL error.

Alternatively, you can supply a scheduling environment directly in the JCTSCHEN field in the JCT. You should delete any scheduling environment text unit in the internal text to prevent the converter from validating it. You must supply a valid scheduling environment in JCTSCHEN or the system cannot schedule the job for execution.

- Set the appropriate return code in register 15 or perform additional processing.

If you decide to fail the job, you should issue error messages to the operator and to the user. You can fail the job in Exit 60 by either:

- Setting flag CNMBFJOB in byte CNMBOPTS of the CNMB. See *z/OS MVS Installation Exits* for information about obtaining and initializing the CNMB. If you set this flag, the converter continues to convert the job's JCL and will fail the job after it has completely processed the job. You can only fail the job in this manner when register 0 contains a X'00'.
- Setting a return code of 8 in register 15 before returning to JES2.

If you want to issue messages to the:

- JCLMSG data set, you must obtain a CNMB and initialize it with the message text. You can not issue any messages to the JCLMSG data set, if this is the last invocation of the exit (register 0 contains a 4). See *z/OS MVS Installation Exits* for additional information about how to initialize the CNMB.
- Operator or user, issue a \$WTO macro.

---

## Environment

The following environment requirements apply to Exit 60.

### Task

JES2 user. You must specify ENVIRON=USER on the \$MODULE or \$ENVIRON macro.

### Restrictions

- Exit 60 runs in the JES2CI address space and cannot access any JES2 private address space data areas, such as the HCT.
- Do not attempt to modify checkpointed data from this exit.
- See Appendix A, “JES2 exit usage limitations,” on page 403 for a listing of specific instances when this exit will be invoked or not invoked.
- Exit 60 must be MVS reentrant. See “Reentrant Code Considerations” in Chapter 2 for more information.
- Do not alter any fields in the \$JQE. The changes will not be successful because you are in the subtask environment.
- Do not attempt to control the processing of the MVS converter by changing the C/I text at Exit 60. The converter does not examine the C/I text returned from the exit to determine what changes have been made. For example, you cannot use this exit to execute a procedure other than the one initially named on the EXEC statement, nor can you use this exit to control the printing of JCL statement images by altering the MSGLEVEL parameter on the JOB statement.

### AMODE/RMODE requirements

RMODE ANY, AMODE 31

### Supervisor/problem program

JES2 places Exit 60 in supervisor state and PSW key 1.

### Recovery

No recovery is in effect when this exit is taken. As with every exit, you should provide your own recovery within your exit routine.

### Job exit mask

Exit 60 is subject to suppression. The installation can implement exit 2 to set the 60th bit in the job exit suppression mask (JCTXMASK) or the installation can indicate the exit is disabled in the JES2 initialization stream.

### Storage recommendations

- Private subpool that resides below 16-megabytes
- Word 1 in register 1 contains the address of a 16-byte work area

## Mapping macros normally required

\$DTE, \$DTECNV, \$HASPEQU, \$HCT, \$JCT, \$JCTX, \$MIT, \$XIT, CNMB, KEYS, TEXT

---

### Point of processing

This exit is taken from the JCL conversion processor subtask in the JES2CI address space, from within module HASCCNVS at the following two times:

1. JES2 first gives your exit control after the converter has successfully converted a complete JCL job into its equivalent C/I text. The exit receives control once for each complete JCL statement unless the converter determines that any JCL statement for this job is in error. A complete JCL statement is considered to be a single JCL statement with all of its continuations. When Exit 60 is invoked, the user's JCL has been merged with the expanded JCL from PROCLIB, and all substitutions for symbolic parameters have been made. Therefore, all of the standard modifications that JES2 will make to the C/I text are complete when the exit receives control.
2. JES2 also gives your exit control after all of the JCL for a particular job has been converted to C/I text even if the converter did detect a JCL statement that was in error. It occurs at the return from the link to the converter, before JES2 creates the scheduler work area (SWA) control blocks. JES2 will not create the scheduler work area (SWA) control blocks until all the JCL for a particular job has been converted to C/I text.

---

### Programming considerations

1. If you suspect that an exit routine associated with this exit is causing a problem, the most expedient method of debugging is to disable the exit to determine whether the problem still occurs when your exit routine is not executed. Then, if the problem seems to be within your exit routine, you can test the routine by turning on the tracing facility.

The trace record serves as a valuable debugging aid because it contains two copies of each C/I text, one before the call to your exit routine and one after the call to your exit routine. However, **do not** turn on tracing in your normal production environment or you will seriously degrade the performance of your system.

2. **Extending the JCT Control Block**

You can use the \$JCTX macro extension service to add, expand, locate, and delete extensions to the job control table (\$JCT) control block from this exit. For example, you can use these extensions to store job-related information.

3. If you need to change the scheduling environment, use the JCTSCHEN field in the JCT.
4. Be sure to take into account when you manage any resources for the exit that the final call to the exit cannot be made if the converter task abends.

---

### Register contents when Exit 60 gets control

The contents of the registers on entry to this exit are:

#### Register

#### Contents

- |   |  |
|---|--|
| 0 | A code indicating the status of conversion processing          |
| 0 | Indicates that a JCL statement has been converted to C/I text. |



- 4 Indicates that the converter has completed converting the job to C/I text. This is the final invocation of Exit 60 for the job.
- 1 Address of a 6-word parameter list
- Word 1 (+0)**  
Address of a 16-byte work area available to the installation.
- Word 2 (+4)**  
If the code passed in R0 is:
- 0, this word points to the address of a 8192 (2000 hex) byte buffer that contains the C/I text of the converted JCL statement.
  - 4, this word contains the address of the converter's return code.
- Word 3 (+8)**  
Address of the \$DTE
- Word 4 (+12)**  
Address of the \$JCT
- Word 5 (+16)**  
JES2 sets this to 0 before it passes control to the exit routine.
- Word 6 (+20)**  
Address of the \$CIWORK are for this subtask.
- 2 Parameter list address mapped by \$XPL. Register 1 points into this area for compatibility with existing exits that do not understand the \$XPL data structure. The parameter list has the following structure:
- XPLID**  
Eyecatcher ('\$XPL')
- XPLLEVEL**  
Indicates the version number of Exit 60
- XPLXITID**  
Exit identifier - 60
- XPLEXLEV**  
Version level of the exit
- X060IND**  
Indicator byte
- X060TEXT**  
Internal text exit
- X060CEND**  
End of conversion
- X060COND**  
Condition byte (not used)
- X060RESP**  
Response byte (not used)
- X060PLUS**  
Exit 60 parameter list (register 1 points here)
- X060WORK**  
16 byte work area address
- X060ITXT**  
Internal text image address (when X060IND = X060TEXT)

## Exit 60

### X060CRET

Address of Converter RC (when X060IND = X060CEND)

### X060CNVW

JES2 DTE work area address

### X060JCT

JCT address

### X060CNMB

Address of message buffer

### X060CIW

CIWORK data area address

- 3-10 Not applicable
- 11 Address of the \$HCT
- 12 N/A
- 13 Address of an 18-word OS-style save area
- 14 Return address
- 15 Entry address

---

## Register contents when Exit 60 passes control back to JES2

Upon return from this exit, the register contents must be:

### Register

#### Contents

- 0 Not applicable on return
- 1 Address of a 6-word parameter list

#### Word 5 (+16)

Address of a CNMB to be processed by the converter. If you want to pass a message(s) that the C/I will include in the JCLMSG data set for the job, this must contain the address of the CNMB (see *z/OS MVS Data Areas* in *z/OS Internet Library* for information about the IEFCNMB macro).

- 2-13 Not applicable
- 14 Return address
- 15 Return code

A return code of:

- 0 Tells JES2 that if any additional exit routines are associated with this exit, execute the next consecutive exit routine. If there are no more exit routines associated with this exit point, continue with normal JES2 processing. If the exit routine was called when register 0 contains a X'00', normal processing is the conversion of the next JCL statement. If the exit routine was called when register 0 contains a X'04', normal processing is to queue the job for execution.
- 4 Tells JES2 to ignore any additional exit routines associated with this exit for this C/I text and continue with normal processing. If the exit routine was called when register 0 contains a X'00' normal JES2 processing is the

conversion of the next JCL statement. If the exit routine was called when register 0 contained a X'04', normal JES2 processing is to queue the job for execution.

- 8 Tells JES2 to bypass execution and cancel the job; the job is queued for output rather than for execution. Conversion will continue until all JCL has been converted.

---

## **Coded example**

Module HASX06A contains a sample of Exit 60.

Module HASX60B contains the same sample exit 60 but also includes two samples of exit 6 that call the common sample of Exit 60.



---

## Chapter 73. JES2 exit migration considerations

This chapter provides more details on a subset of the migration actions required for JES2. For a complete list of the migration actions from one JES2 release to another JES2 release, see *z/OS V2R2 Migration*. The migration details in this chapter are presented in the order in which they were introduced into a z/OS release. See *z/OS V2R2 Migration* for more information about when the migration actions are required.

---

### JES2 z/OS V1R11 migration details

A new checkpoint activation level, which is called z11, is available for JES2 release V1R11. The current checkpoint level is z2. JES2 needs certain conditions to activate to the z11 checkpoint level: refer to “JES2 z/OS V1R11 checkpoint activation.”

Before activating to JES2 release V1R11, you should meet certain conditions if your installation is using the following JES2 exits or macros: refer to “JES2 z/OS V1R11 exits and macros.”

#### JES2 z/OS V1R11 checkpoint activation

Use the \$ACTIVATE command to activate to the z11 checkpoint level. The \$ACTIVATE, LEVEL=Z11 command expands the JES2 checkpoint to support functions that are enabled with the z11 checkpoint level. JES2 will reject the \$ACTIVATE command if certain conditions are not met. For information about a complete list of new functions that are enabled by z11 activation, see \$ACTIVATE command in *z/OS JES2 Commands*.

The \$D ACTIVATE command provides an exhaustive list of reasons that block checkpoint activation to the z11 checkpoint level. It is suggested that you use the \$D ACTIVATE command before attempting an activation to the z11 checkpoint level.

#### JES2 z/OS V1R11 exits and macros

Before activating to JES2 release V1R11, you should meet certain conditions if your installation is using the following JES2 exits or macros:

- If you reference JOE fields in any of your exits, check the \$DOGJOE macro. This macro enables creation of read and update mode artificial JOEs that are called JOAs. For information about \$DOGJOE macro, see *z/OS JES2 Macros*. For a description of JOAs, see “Checkpoint control blocks” on page 413.
- If you use JES2 Exit 1, Exit 15, Exit 38, Exit 46 or Exit 56, your code might need to be updated. Before JES2 release V1R11, real work JOE and characteristics JOE were passed to these various exits. Starting with JES2 release V1R11, an artificial JOE will be passed to each of these exits. For more information about these exits, see Chapter 12, “IBM-defined exits,” on page 65.
- If you use JES2 macros \$#ADD, \$#ALCHK, \$#BLD and \$#BUSY, your code might need to be updated. In many cases the interface has changed to require that a JOA be passed into the macro versus a work JOE or work/characteristics JOE combination. In the case of \$#BUSY and \$#ALCHK, additional rules must be followed. For information about the requirements of the macros, see *z/OS JES2 Macros*.

- The size of the JQX is changed. If you use the \$DOGJOE service, the code should not be impacted.
- JQEs, JOEs and BERTs have new size limits:
  - JQEs = 400,000.
  - JOEs = 1,000,000
  - BERTs = 1,000,000
- The \$#JOE macro returns a real JOE or a read mode JOA. Before JES2 release V1R11, this macro only returned a real JOE. The default for \$#JOE are changed to return a read mode JOA. If read mode JOA is used and an early exit is made from \$#JOE processing loop, make sure that JOA is properly released by a call to \$DOGJOE service ACTION=RETURN.
- Before JES2 V1R11, exit 7 could determine which record was being read by using the field CBMTTR. Starting with JES2 release V1R11, CBIO uses MQTR to address a record on spool. If you have exit routines that examine field CBMTTR, change them to examine field CBMQTR.
- JES2 is now an exploiter of 64 bit common storage to store information for devices and jobs.

---

## JES2 z/OS V2R1 migration details

In z/OS 2.1, JES2 provides improved JCL error handling, which can be used to enhance your installation exits.

### JES2 z/OS 2.1 input phase processing

Prior to z/OS 2.1, error messages that were generated during the JES2 input phase were placed in the JESJCLIN data set, which was the only data set that was created. This earlier method of reporting input phase error messages differed significantly from conversion phase error reporting. For example, the following JCL uses this pre-2.1 method:

```
//IBMUSERA JOB (,2D07),MSGLEVEL=(1,1),CLASS=ABC,SYSAFF=(BAD)
/*JOBPARM PROC=PROC99
//*
//STEP1 EXEC PGM=IEBDG,REGON=0M
//SYSPRINT DD SYSOUT=*
//DATASET1 DD SYSOUT=*
//SYSIN DD DATA,DLM=$$$$
```

There are a number of errors that JES2 would detect during input phase.

The result is a series of messages in the JESJCLIN data set that looks like this:

```
//IBMUSERA JOB (,2D07),MSGLEVEL=(1,1),CLASS=ABC,SYSAFF=(BAD) JOB00767
***** ILLEGAL JOB CARD - VALUE OF CLASS= EXCEEDS 1 CHARACTER *****
/*JOBPARM PROC=PROC99
***** NON-VALID JOBPARM STMT - UNEXPECTED KEYWORD DETECTED - PROC *****
//*
//STEP1 EXEC PGM=IEBDG,REGON=0M
//SYSPRINT DD SYSOUT=*
//DATASET1 DD SYSOUT=*
//SYSIN DD DATA,DLM=$$$$
***** NON-VALID DD STMT - VALUE FOR DLM KEYWORD NOT VALID *****
$HASP106 JOB DELETED BY JES2 OR CANCELLED BY OPERATOR BEFORE EXECUTION
----- JES2 JOB STATISTICS -----
          17 CARDS READ
           7 SYSOUT PRINT RECORDS
           0 SYSOUT PUNCH RECORDS
           0 SYSOUT SPOOL KBYTES
          0.00 MINUTES EXECUTION TIME
```

In the example output from z/OS 1.13, error messages are intermixed with the JCL for the job in a single output data set. And because the job never advanced past the input phase, subsequent JCL errors went undetected.

By contrast, z/OS 2.1 produces the following output for this same job:

```
12.43.45 JOB00042  IEFC452I  IBMUSERA - JOB NOT RUN - JCL ERROR  533
----- JES2 JOB STATISTICS -----
      17 CARDS READ
      24 SYSOUT PRINT RECORDS
       0 SYSOUT PUNCH RECORDS
       1 SYSOUT SPOOL KBYTES
    0.00 MINUTES EXECUTION TIME
  1 //IBMUSERA JOB  (,2D07),MSGLEVEL=(1,1),CLASS=ABC,SYSAFF=(BAD)
  2 /*JOBPARM PROC=PROC99
    /*
  3 //STEP1      EXEC  PGM=IEBDG,REGON=0M
  4 //SYSPRINT  DD  SYSOUT=*
  5 //DATASET1  DD  SYSOUT=*
  6 //SYSIN     DD  DATA,DLM=$$$$
STMT NO. MESSAGE
  1 HASP110 value of CLASS= parameter is not valid
  1 HASP112 value of SYSAFF= parameter is not valid
  2 HASP107 UNEXPECTED KEYWORD DETECTED - PROC
  3 IEFC630I UNIDENTIFIED KEYWORD REGON
  6 HASP107 value for DLM keyword not valid
```

In the example output from z/OS 2.1, JES2 detects the errors during input processing but still queues the job for conversion. Conversion phase processing adds the messages to the normal system messages data set, with references back to the statements in error.

In z/OS 2.1, JECL statements (which begin with /\*) are also assigned line numbers in the output. Messages continue to be placed in the JESJCLIN data set, but they are tagged with meta data which identifies them as messages and not JCL. For example, the following JESJCLIN data set is the data set for this job:

```
//IBMUSERA JOB  (,2D07),MSGLEVEL=(1,1),CLASS=ABC,SYSAFF=(BAD)          JOB00010
HASP110 value of CLASS= parameter is not valid
HASP112 value of SYSAFF= parameter is not valid
/*JOBPARM PROC=PROC99
HASP107 UNEXPECTED KEYWORD DETECTED - PROC
/*
//STEP1      EXEC  PGM=IEBDG,REGON=0M
//SYSPRINT  DD  SYSOUT=*
//DATASET1  DD  SYSOUT=*
//SYSIN     DD  DATA,DLM=$$$$
HASP107 value for DLM keyword not valid
```

In z/OS 2.1, warning messages are also supported during the input phase, instead of error messages only. This capability extends to the input phase for JES2 Exits 2, 4, 52, and 54, which can use the \$RMSGQUE with MSG=WARNING to issue a warning message and still allow the job to execute.

## JES2 z/OS 2.1 conversion phase processing

In z/OS 2.1, conversion phase processing has been enhanced to allow the interpreter to be called during the conversion phase, immediately after the converter. This is typically done when the job is selected for execution.

Invoking the interpreter prior to job execution provides the following benefits:

- Errors that are typically found by the interpreter can be detected without the job entering the execution phase. This provides more complete error detection when

using TYPRUN=SCAN. However, data set locate processing is still not done until job execution, so missing data sets remain undetected during the conversion phase.

- OUTPUT cards that specify the JESDS or MERGE parameters can be processed even if the job does not execute. This processing is done after the interpreter is called.

## JES2 z/OS 2.1 data structure processing

If the interpreter is being called after the converter, processing for both the converter and the interpreter is done in a separate address space to accommodate data isolation and storage space requirements. In z/OS 2.1, multiple data structures are altered to support running the subtasked portion of the conversion phase in a separate address space. The data area changes are consistent (from an exits perspective) across the JES2 address space and the new JES2CI address space.

The conversion PCE exits in both environments (JES2 and JES2CI private) and remains essentially unchanged. A conversion DTE in both environments represents the subtask. However, most of the data areas that were in the DTE prior to z/OS 2.1 have been moved to two new local work areas, the CIWORK and CIWORKB data areas, which are both contained in the \$CIWORK macro. These areas are 31 and 24-bit JES2 or JES2CI private storage work areas for the conversion subtasks.

Prior to z/OS 2.1, the DTE also passed information about the job being converted from the PCE that selected the job to the DTE that was converting the job. In z/OS 2.1, this is no longer possible because the DTE could exist in a separate address space. The CIPARM data area in the \$CIPARM macro is now used to communicate this information. The CIPARM data area is located in the PSO data space and is pointed to by both the PCE (pointer JPCECIP and ALET \$PSOTOK) and the DTE (pointer DCNVCIP and ALET DCNVCIPL).

## JES2 z/OS 2.1 Exit 6 considerations

Exit 6 gets control of a job for every converter/interpreter text record that is created, and it also gets control of a job at the end of conversion processing to perform any final processing. Because Exit 6 is called directly out of the subtask, it is running in the JES2 SUBTASK execution environment. This environment is similar to the USER environment, except that register 11 is the HCT address in the SUBTASK environment.

In z/OS 2.1, this same processing cannot be run in the JES2CI address space. This processing will not run in the SUBTASK environment because it cannot access the HCT in private storage. When this processing is done in the JES2CI address space, it must be run in the USER environment where register 11 points to the HCT.

In z/OS 2.1, Exit 6 cannot be called when processing is done in the JES2CI address space. USER environment Exit 60 is called instead, at the same point in job processing that Exit 6 is called in the JES2 address space.

If your exit 6 routine only involves passing data areas on to the interface, your exit 6 does not require changes for z/OS 2.1. However, if your exit 6 accesses fields in the converter DTE that have been moved to the CIWORK data area, you must change your references to these fields. All fields names have been updated consistently. The address of the CIWORK data area is passed to Exits 6 and 60.

If you use Exit 6 to create an Exit 60, you must update your Exit 60 routine to reference fields in the JES2CI address space instead of in JES2 private storage. If



your data areas are locally-defined, they might also require being relocated to common storage (31 or 64 bit) or to a data space. If they are data areas that are owned by JES2, check to see if they have already been copied to an accessible data area that you can use.

In z/OS 2.1, both Exit 6 and Exit 60 include a new XPL data area, which is passed to the exit in register 2. This standardizes the method for accessing fields that are passed to these exits by using field names instead of hardcoded offsets. This also allows you to determine if your routine is being called as an Exit 6 or an Exit 60.

The sample Exit 60 (HASX60B) that is provided in z/OS 2.1 is an example of how to use a single USER environment routine for both Exit 6 and Exit 60. It includes one example Exit 6 that switches to the USER environment and calls a specific Exit 60 routine. A second example Exit 6 switches to the USER environment and uses the \$EXIT facility to invoke all the Exit 60 routines that are defined. Both example exits provide a single routine which performs both Exit 6 and Exit 60 functions.

## **JES2 z/OS 2.1 Exit 7 and Exit 8 considerations**

Exits 7 and 8 are the CBIO exits in the main task and user environments. Because conversion subtask processing can occur in the JES2CI address space in z/OS 2.1, the process of reading in the IOTs for a job and later writing out the IOTs has been relocated from the conversion PCE to the subtask. This change implies that read and write operations are detected by Exit 8 instead of by Exit 7. Therefore, you must relocate any processing that involves reading or writing IOTs during the conversion phase from Exit 7 to Exit 8.

Because job processing can occur in a separate address space in z/OS 2.1, Exit 8 code cannot access JES2 private storage.

It is uncommon for any JES2 exit to read or write IOTs during conversion processing. However, JES2 exits are called at this point in processing to accommodate any case where general processing is done for IOTs while they are read and written.

## **JES2 z/OS 2.1 Exit 36 and Exit 37 considerations**

Exits 36 and 37 get control of a job whenever a RACF call is made. JES2 makes RACF calls during conversion processing to create the security environment for the job. These exits use FUNCODEs of \$SEAVERC and \$SEAVERD for the VERIFY CREATE and VERIFY DELETE RACROUTE calls. There is also a call to audit the creation of in-stream data sets, which is performed using a FUNCODE of \$SEASIC. In z/OS 2.1, all of these functions can be called in the JES2CI address space, and potentially no longer have access to data areas in the JES2 private address space.

## **JES2 z/OS 2.1 Exit 44 considerations**

Exit 44 gets control of a job at the end of conversion phase processing, in the JES2 main task. The processing for Exit 44 exit is unchanged in z/OS 2.1. However, because the IOTs are written and freed in the JES2CI address space, they are no longer available when Exit 44 gets control of a job. If your exit examines the IOTs, move this processing to the final Exit 6 call, after conversion has completed.

## **JES2 z/OS 2.1 Exit 59 considerations**

If the interpreter is called, then Exit 59 is called after a job is interpreted and after any OUTPUT cards are processed, but before SWA blocks that are created by the interpreter are written to spool. In z/OS 2.1, Exit 59 performs any verification of

the data in the SWA blocks (for example, LOCATE processing for any data sets that are specified in the JCL). Exit 59 can request that the job being processed is failed and does not execute.

## Appendix A. JES2 exit usage limitations

The following table notes those instances when reader and converter exits (Exits 2, 3, 4, 6, 20, and 60) are invoked or not invoked. Be certain to consider this information when attempting to implement these exits.

Table 12. Reader and converter exits usage

| Exits taken for                                  | Input services |                    |       |       | Converter |
|--|----------------|--------------------|-------|-------|-----------|
|  | 2/52           | 3/53               | 4/54  | 20/50 |           |
| Source of Job                                    | 2/52           | 3/53               | 4/54  | 20/50 | 6/60      |
| Job from local reader                            | Y(2)           | Y(3) <sup>1</sup>  | Y(4)  | Y(20) | Y         |
| Job from remote reader                           | Y(2)           | Y(3) <sup>1</sup>  | Y(4)  | Y(20) | Y         |
| TSO session logon (TSU)                          | Y(52)          | Y(53) <sup>1</sup> | Y(54) | Y(50) | Y         |
| TSO submitted job                                | Y(52)          | Y(53) <sup>1</sup> | Y(54) | Y(50) | Y         |
| Started task                                     | Y(52)          | Y(53) <sup>1</sup> | Y(54) | Y(50) | Y         |
| Job with /*ROUTE XEQ - INTRDR, NJE/TCP           | Y(52)          | Y(53) <sup>1</sup> | Y(54) | Y(50) | N         |
| Job with /*ROUTE XEQ - Other sources             | Y(2)           | Y(3) <sup>1</sup>  | Y(4)  | Y(20) | N         |
| Job following /*XMIT JECL or //XMIT JCL          | N              | N                  | N     | N     | N         |
| Job from NJE job receiver:                       |                |                    |       |       |           |
| Job for this node - TCP/IP                       | Y(52)          | Y(53) <sup>1</sup> | Y(54) | Y(50) | Y         |
| Job for this node - SNA, BSC                     | N(2)           | Y(3) <sup>1</sup>  | N(4)  | Y(20) | Y         |
| Store and forward - TCP/IP                       | N              | N                  | N     | Y(50) | N         |
| Store and forward - BSC, SNA                     | N              | N                  | N     | Y(20) | N         |
| Job from NJE SYSOUT receiver:                    |                |                    |       |       |           |
| Job for this node - BSC, SNA, TCP/IP             | N              | N                  | N     | N     | N         |
| Store and forward - BSC, SNA, TCP/IP             | N              | N                  | N     | N     | N         |
| Job internally generated by JES2 (SYSLOG-RMTMSG) | N              | N                  | N     | N     | N         |
| Spool offload job receiver <sup>2</sup>          | Y(2)           | Y(3) <sup>1</sup>  | Y(4)  | Y(20) | Y         |
| Spool offload SYSOUT receiver                    | N              | N                  | N     | N     | N         |
| XBM invocation - INTRDR, NJE/TCP                 | Y(52)          | Y(53) <sup>1</sup> | Y(54) | Y(50) | Y         |
| XBM invocation - other sources                   | Y(2)           | Y(3) <sup>1</sup>  | Y(4)  | Y(20) | Y         |
| Special Case JCL and JECL                        |                |                    |       |       |           |
| JCL from cataloged procedure                     | N/A            | N/A                | N     | N/A   | Y         |
| //*COMMENT cards - INTRDR, NJE/TCP               | Y(52)          | N/A                | Y(54) | N/A   | N/A       |
| //*COMMENT cards - other sources                 | Y(2)           | N/A                | Y(4)  | N/A   | N/A       |
| /*PRIORITY statements- INTRDR, NJE/TCP           | N/A            | N/A                | Y(54) | N/A   | N/A       |
| /*PRIORITY statements - other sources            | N/A            | N/A                | Y(4)  | N/A   | N/A       |

Table 12. Reader and converter exits usage (continued)

| Exits taken for   | Input services |     |       |       | Converter |
|---|----------------|-----|-------|-------|-----------|
| /*\$command statements - INTRDR, NJE/TCP <sup>3</sup>   | N/A            | N/A | Y(54) | N/A   | N/A       |
| /*\$command statements - other sources <sup>3</sup>   | N/A            | N/A | Y(4)  | N/A   | N/A       |
| /*end of SYSIN data   | N/A            | N/A | N     | N/A   | N/A       |
| //null statements   | N/A            | N/A | N     | N/A   | N/A       |
| Generated DD*statement - INTRDR, NJE/TCP  | N/A            | N/A | Y(54) | N/A   | N/A       |
| Generated DD*statement - other sources  | N/A            | N/A | Y(4)  | N/A   | N/A       |
| /*with invalid verb - INTRDR, NJE/TCP   | N/A            | N/A | Y(54) | Y(50) | N/A       |
| /*with invalid verb - other sources   | N/A            | N/A | Y(4)  | Y(20) | N/A       |
| //with invalid verb - INTRDR, NJE/TCP   | N/A            | N/A | Y(54) | Y(50) | N/A       |
| //with invalid verb - other sources   | N/A            | N/A | Y(4)  | Y(20) | N/A       |
| /*EOF internal reader   | N/A            | N/A | N     | N/A   | N/A       |
| /*DEL internal reader - INTRDR, NJE/TCP   | N/A            | N/A | N     | Y(50) | N         |
| /*DEL internal reader - other sources   | N/A            | N/A | N     | Y(20) | N         |
| /*PURGE internal reader - INTRDR, NJE/TCP   | N/A            | N/A | N     | Y(50) | N         |
| /*PURGE internal reader - other sources   | N/A            | N/A | N     | Y(20) | N         |
| /*SCAN internal reader  | N/A            | N/A | N     | N/A   | N         |
| Where Y(n) = Exit is invoked and number, N = Exit is not invoked, and N/A = Not applicable  |                |     |       |       |           |
| <b>Note:</b>  |                |     |       |       |           |
| 1. Exit 3/53 is taken only if ACCTFLD=REQUIRED or OPTIONAL is specified on the JOBDEF initialization statement. Exit 3/53 will be taken even if there is no accounting information provided on the JOB statement. |                |     |       |       |           |
| 2. This might be the second (or higher) pass through these exits for this job.  |                |     |       |       |           |
| 3. Commands must be outside of a job; they will invoke Exit 4/54 but will not have a JCT (R10=0).   |                |     |       |       |           |

## Appendix B. Sample code for Exit 17 and Exit 18

The following is code that your installation can include in installation Exit 17 and Exit 18 to remove blanks from the remote workstation identifier on the RJE signon cards.

```

                                                                    Col 72
                                                                    |
                                                                    v
X1718  $MODULE ENVIRON=JES2,TITLE='JES2 EXIT 017 - $MODULE',      X
        $CADDR,           JES2 Common Address Table              X
        $HASPEQU,         JES2 Equates                           X
        $HCCT,            JES2 Common Communications Table       X
        $HCT,             JES2 Control Table                     X
        $HFAME,           JES2 File Allocation Map Entry         X
        $MIT,             JES2 Module Information Table          X
        $MITETBL,         JES2 MIT Entry Table                   X
        $PADDR,           JES2 Private Routine Address Table     X
        $PARMLST,         JES2 Parameter list                    X
        $PCE,             JES2 Processor Control Element         X
        $PSV,             JES2 Prefix Save Area                  X
        $SCAT,            JES2 Sysout Class Attribute Table      X
        $USERCBS,         User Control Blocks                     X
        $XECB             JES2 Extended ECB                       X
X17DBLNK $ENTRY CSECT=YES,BASE=R12  Establish entry point
        SPACE 1
        $SAVE             Save caller's registers
        LR   R12,R15      Save base address
        SLR  R6,R6        Preset return code
        LTR  R0,R0        Is this the first call for signon?
        BNZ  X17RET       No, return now
        EJECT
*****
*
*   The card image passed to this routine by JES2 will
*   always have a blank after the characters '/*SIGNON'.
*
*****
        SPACE 1
        L    R2,12(,R1)   Point to the signon card
        LA   R2,15(,R2)   Point to remote number portion
        SPACE 1

```

```

*****
*
*       Now get past the 'RMT ' or 'R '.
*
*****
SPACE 1
SLR   R7,R7           Zero number of blanks found
LA    R5,L'X17FIELD   Get max length of remote field
LA    R4,L'X17REMOT   Assume that it is 'REMOTE'
CLC   X17REMOT,0(R2)  Does it start with 'REMOTE'?
BE    X17FNUM         Yes, go process the number
LA    R4,L'X17RMT     Assume that it is 'RMT'
CLC   X17RMT,0(R2)   Does it start with 'RMT'?
BE    X17FNUM         Yes, go process the number
LA    R4,L'X17RM      Assume that it is 'RMT'
CLC   X17RM,0(R2)    Does it start with 'RM'?
BNE   X17RET         No, can't do anything with it
X17FNUM LA R2,0(R4,R2) Point to character after remote
SR    R5,R4          Get count of numbers in field
LR    R4,R5          Save number of numbers
LR    R3,R2          Save start of number portion
X17LOOP CLI 0(R2),C' ' Is the next char a blank?
BNE   X17SKWSH      No, all done
LA    R7,1(,R7)      Increment number of blanks found
LA    R2,1(,R2)      Point to next character
BCT   R5,X17LOOP    And continue de-blanking
B     X17RET         No numbers, all blanks
EJECT

```

```

*****
*
*       Move the characters over and then fill the rest of the
*       remote number portion of the field with blanks.
*
*****
          SPACE 1
X17SKWSH LTR   R7,R7           Were any blanks found?
          BZ   X17RET         No, line is OK
          SR   R4,R7           Get number of numbers
          BCTR R4,0            Less one for execute
          EX   R4,X17MOVE1     Move the characters over
          LA   R3,1(R4,R3)     Point past numbers
          BCTR R7,0            Less one for execute
          EX   R7,X17MOVE2     Blank out remaining characters
          SPACE 1
X17RET  $RETURN RC=(R6)       Return to the caller
          EJECT
*****
*
*       Executed statements and storage areas
*
*****
          SPACE 1
X17MOVE1 MVC  0(*-*,R3),0(R2) Squish out those blanks
X17MOVE2 MVC  0(*-*,R3),X17BLANK Squish out those blanks
          SPACE 1
X17BLANK DC   CL9' '
X17FIELD DC   C'REMOTE999'
X17REMOT DC   C'REMOTE'
X17RMT   DC   C'RMT'
X17RM    DC   C'RM'
*****
*
*       LITERAL POOL
*
*****
          SPACE 1
          LTORG ,
          SPACE 1
          $MODEND ,
          END

```





---

## Appendix C. Job-related exit scenarios

This appendix identifies the JES2 job-related exits. It also describes the relationship between the JES2 \$JCT and MVS/SP JMR blocks and provides an overview of the security access service.

Examples of exits that are not job-related are exits such as those taken during JES2 initialization, JES2 termination, RJE signon, JES2 command processing, and other functions not necessarily related to individual jobs <sup>1</sup>.

Job-related exits fall into two categories: specific purpose and general purpose. A specific purpose job-related exit is one that provides a specific function. Although, it may be used for other purposes such as a compromise to avoid in-line modifications.

Examples of specific-purpose job-related exits are job output overflow (Exit 9) and spool partitioning exits (Exits 11 and 12). These exits are used in controlling output limits and spool allocation (fencing) for a particular job. Because these exits do not occur at predictable intervals during the life of a job, using them for a general purpose is not appropriate.

General-purpose job-related exits are exits such as the job statement scan exit (Exit 2), converter internal text scan exit (Exit 6), and the control block read/write exits (Exits 7 and 8). These exits are typically considered when there is a user requirement to control installation standards, job resources, security, output processing, and other job-related functions.

Often the use of more than one exit is required and sometimes combinations of JES2 and other exits such as Systems Management Facilities (SMF) exits must be used. Table 13 on page 410 lists the exits that are discussed. They are not all of the job-related exits but possibly enough to make a decision as to which exits to choose to control certain processes or functions during the life of a job.

---

### Exit sequence

There are two major considerations when selecting an exit to satisfy a user requirement:

1. The environment of the exit -  
The address space, TCB (task), storage key, data areas that are addressable, and facilities are available at the time the exit is taken.
2. The sequence of the exits -  
Which exits precede and which exits follow each other? What processing has preceded and what processing follows the exit?

---

1. A job, in JES2 terminology, is anything represented by a Job Queue Element (\$JQE). The name "job" is also used to describe job output rather than the more specific term - spool data set. It is common for operators to say that a "job" is on the printer or a "job" is printing. It would be awkward, but more accurate, to say that the data set or output group is printing.

## Selected exits

To provide a user-required function, two or more exits may be needed. In that case, understanding the sequence of exits is important.

Table 13 lists the selected exits that are included here for further discussion.

*Table 13. Job-Related Exits*

| Exit | Exit Title   | Comment   |
|------|--|---|
| 1    | Print/Punch Separator                                  | Taken when a job's data sets have been selected for printing or punching, before the check for the standard separator page.   |
| 2    | JOB Statement Scan                                     | The first exit taken for a job and before the statement is processed.   |
| 3    | Job Statement Accounting Field Scan                    | Taken after JOB statement has been processed. Normally used to replace or supplement JES2's accounting field scanning routine (HASPRSCN), but also used as a post job card exit.  |
| 4    | JCL and JECL control statement scan                    | Taken for each JCL and JECL statement submitted but not for PROCLIB JCL statements.   |
| 6    | Converter/Interpreter internal text scan               | An efficient exit for scanning JCL because of structured text and single record for each statement (no continuation). This exit is used when conversion is done in the JES2 address space. Use exit 60 for conversion that is done in the JES2CI address space. |
| 7    | Control Block Read/Write (JES2 environment)            | Taken from the JES2 main task each time a spool resident control block (\$JCT, \$IOT, \$SWBIT, \$OCR) is read from or written to spool.   |
| 8    | Control Block Read/Write (User or Subtask environment) | Taken from the user address space or a JES2 subtask each time a spool resident control block (\$JCT, \$IOT, \$SWBIT, \$OCR) is read from or written to spool.   |
| 15   | Output Data Set/Copy Select                            | Taken once for each data set where the data set's \$PDDB matches the selected Job Output Element (\$JOE) and once for each copy of these data sets.   |
| 20   | End of Job Input                                       | Taken at the end of input processing and before \$JCT is written. This is typically a good place to make final alterations to the job before conversion.  |
| 28   | SSI Job Termination                                    | Taken at the end of job execution before the \$JCT is written to spool.   |
| 30   | SSI Data Set Open/Restart                              | Taken for SYSIN, SYSOUT, or internal reader Open or Restart processing.   |
| 31   | SSI Allocation   | Taken for SYSIN, SYSOUT, or internal reader Allocation processing.  |
| 32   | SSI Job Selection                                      | Taken after all job selection processing is complete.   |
| 33   | SSI Data Set Close                                     | Taken for SYSIN, SYSOUT, or internal reader Close processing.   |

Table 13. Job-Related Exits (continued)

| Exit | Exit Title                          | Comment   |
|------|-------------------------------------|---|
| 34   | SSI Data Set Unallocate - Early     | Taken for SYSIN, SYSOUT, or internal reader Unallocate processing. This exit is taken early in Unallocation. You may want to consider Exit 48 (late unallocation) when modifying SYSOUT characteristics.  |
| 35   | SSI End-of-Task                     | Taken at end of each task during job execution.   |
| 36   | Pre-SAF                             | Taken just before JES2 call to SAF.   |
| 37   | Post-SAF                            | Taken just after the return from the JES2 call to SAF   |
| 40   | Modifying SYSOUT characteristics    | Taken during OUTPUT processing (HASPHOPE or HASPSPIN) for each SYSOUT data set before JES2 gathers data sets with like attributes into a \$JOE.   |
| 44   | Post Conversion - Maintask          | Taken in maintask environment after job conversion processing and before the \$JCT and \$JQE are checkpointed   |
| 46   | NJE Transmission                    | Taken for NJE header, trailer, and data set header during NJE job transmissions.  |
| 47   | NJE Reception                       | Taken for NJE header, trailer, and data set header during NJE job reception.  |
| 48   | SYSOUT Unallocation - Late          | This exit can be used as an alternative to Exit 34 (early allocation). It is more suitable when modifying SYSOUT characteristics or affecting SPIN processing. When modifying SYSOUT characteristics in Exit 34, subsequent JES2 processing can override changes made to the \$PDDDB in the exit. If processing is required earlier, use Exit 34. |
| 49   | Job Queue Work Select - QGOT        | This exit allows you to gain control whenever JES2 work selection processing has located a pre-execution job for a device. This includes work selected for JES2 and workload management (WLM) initiators.   |
| 50   | End of Job Input                    | Taken at the end of input processing and before \$JCT is written. This is typically a good place to make final alterations to the job before conversion.  |
| 51   | Job Phase Change                    | Taken when a job moves from one phase to the next.  |
| 52   | JOB Statement Scan                  | The first exit taken for a job and before the statement is processed.   |
| 53   | Job Statement Accounting Field Scan | Taken after JOB statement has been processed. Normally used to replace or supplement JES2's accounting field scanning routine (HASPRSCN), but also used as a post job card exit.  |
| 54   | JCL and JECL control statement scan | Taken for each JCL and JECL statement submitted but not for PROCLIB JCL statements.   |
| 56   | NJE Transmission                    | Taken for NJE header, trailer, and data set header during NJE job transmissions.  |
| 57   | NJE Reception                       | Taken for NJE header, trailer, and data set header during NJE job reception.  |

Table 13. Job-Related Exits (continued)

| Exit     | Exit Title                               | Comment  |
|----------|--|--|
| 58       | End of Step                              | Taken at the end of each step in a job.  |
| 59       | Post Interpretation                      | A efficient place to examine SWA blocks (using SJF services) prior to a job going into execution.  |
| 60       | Converter/Interpreter internal text scan | An efficient exit for scanning JCL because of structured text and single record for each statement (no continuation). This exit is used when conversion is done in the JES2CI address space. Use exit 6 for conversion done in the JES2 address space. |
| IEFUJV   | SMF Job Validation                       | Receives control for each JCL statement and at the conversion end from the converter subtask. IEFUJV receives control from the user's address space after all JCL is interpreted.  |
| IEFUJI   | SMF Job Initiation                       | Taken at job initiation after the \$JCT has been checkpointed and before SMF exit IEFUSI.  |
| IEFUJP   | SMF Purge                                | Taken from subtask in JES2 address space after job is purged.  |
| IEFUSI   | SMF Step Initiation                      | Taken just after SMF exit IEFUJI for the first step of a job. Also taken again at the beginning of each subsequent step.   |
| IEFACTRT | SMF Termination                          | Receives control at job and step termination and for the creation of SMF type 5 and 35 records.  |

## SPOOL control blocks

It's important to understand the status of any control block to be referenced or altered in a user exit. Control blocks associated with a job may not always be in storage. However, all job-related control blocks are written to either the checkpoint data set or a spool data set. This is done to:

- Allow warm starts after JES2 termination.
- Make control blocks accessible to all sharing members of a multi-access spool complex.
- Provide recovery in case of a system failure.

Sometimes job-related control blocks are just read and not written (if they are not altered) but are always written after they are created and after they have been altered. The job-related control blocks on spool are:

- \$JCT - Job Control Table
- \$IOT - I/O Table (contains spool track allocation and spool data set information)
- \$OCT - Output Control Table (contains Output Control Records (OCRs) which are used for /\*OUTPUT JECL parameters)
- \$SWBIT - SWB Information Table (contains Scheduler Work Blocks used by // OUTPUT JCL)
- \$CHK - Checkpoint record for local, RJE and FSS printers.

## Checkpoint control blocks

If you write code for JES2 exits that access and update checkpoint control blocks, you need to review this section and apply this information along with those specific "Programming Considerations" described for the JES2 exit that you are implementing.

### Checkpoint control blocks for JQEs

JES2 provides different types of JQEs or JQAs to your exit and processes them in differing ways. The types are:

- Real JQE. Your exit receives a read or update mode JQE or JQA.
- Read-mode JQA. Your exit receives an artificial JQE that is a temporary block of storage. This storage contains:
  - Almost the same information as the real JQE.
  - Information from the JQX (new in Version 2 Release 4).
  - Information from BERTs (another checkpointed area).
- Update-mode JQA. Your exit receives an artificial JQE that is a temporary block of storage. This storage is similar to the read-mode JQA. JES2 ensures the integrity of this JQA and manages the storage that each JQA occupies.
- Work area that contains a prototype JQE. In certain circumstances, your exit may be passed the address of a work area that contains a working copy of a JQE. See Exit 47 for more information.

Exits normally use JQEs in read mode (data is extracted or pointed to when calling service routines) or in write mode (data in the JQE is modified). JES2 exit writers need to take the following actions when they use a particular JQE or JQA as the JQE= keyword value on the \$DOGJQE macro:

- If the JQE is needed only to access data and that data is within the bounds of the original real JQE, only the address of the real JQE is needed. Regardless of what IBM has provided as the JQE address, use the following action to get the address of the real JQE:

```
$DOGJQE ACTION=GETJQEADDR,CBADDR=jqe
```

- If the JQE is needed only to access data and that data is beyond the bounds of the original real JQE (that is, it is stored in fields where the first three characters of the field name are other than JQE), a read mode JQA is needed. Regardless of what IBM has provided as the JQE address, use the following action to get the address of a read mode JQA. The address of the read mode is returned in R0.

```
$DOGJQE ACTION=(FETCH,READ),JQE=jqe
```

After you finish, use the following action to free the memory that is used for the JQA (x is the address that is returned from the first \$DOGJQE call):

```
$DOGJQE ACTION=RETURN,CBADDR=x
```

- If the JQE is needed in write mode (the fields to be changed are either within the bounds or not within the bounds of the original JQE), use the following action to get the address of an update mode JQE, regardless of what IBM has provided as the JQE address. The address of the JQA is returned in R0. Make all changes to fields in the update mode JQA.

```
$DOGJQE ACTION=(FETCH,UPDATE),JQE=jqe
```

After you finish, use the following action to free the memory that is used for JQA (x is the address from the first \$DOGJQE call) and to ensure that the changes in the JQA get propagated to the real JQE, the JQX, and the BERT area.

```
$DOGJQE ACTION=RETURN,CBADDR=x
```

**Update-mode JQA considerations:** If an exit requires an update-mode JQA, use the following logic path:

1. Perform the action:

```
$DOGJQE ACTION=(FETCH,UPDATE),JQE=jqe, WAIT=NO
```

where *jqe* is the address of the JQE that the IBM code gives to the exit.

2. If JES2 returns a return code indicating that the JQA could not be created, you must manage the situation of lock not available.
3. If RC=0, perform rest of logic by using the JQA.
4. Perform the action:

```
$DOGJQE ACTION=RETURN,CBADDR=jqa
```

where *jqa* is the address that is returned in R0 from FETCH in the first step.

**Note:** It is not necessary or desirable to perform the following action before you attempt to get an update-mode JQA.

```
$DOGJQE ACTION=(QUERYLOCK,OBTAINABLE)
```

This is valid because the non-zero return code (that is, the failure RC) returned by QUERYLOCK indicates that the lock is not available for a new user. This condition is different from requesting an update-mode JQA for the current caller.

#### **Other processing considerations:**

**JQE or JQA processing considerations:** When your exit returns a JQE or JQA to the JES2 systems through these actions, certain errors can occur if JES2 determines that what your exit has returned is not consistent with what JES2 knows to exist. JES2 uses the \$ERROR macro and issues the following errors:

- DJ1– Non-IBM code returned an IBM JQE or JQA that violates the consistency checks of JES2.
- DJ2– IBM code returned a non-IBM JQE or JQA that violates the consistency checks of JES2.

#### **Note:**

1. You are encouraged to disregard the kind of JQE or JQA that is passed to your exit and always to do the following actions:
  - To obtain the address of the real JQE (for example, your exit needs to compute the offset of the JQE), perform the action:  

```
$DOGJQE ACTION=GETJQEADDR
```
  - To obtain the address of a read-mode JQE or JQA (for example, your exit needs to examine the MAXCC field), perform the action:  

```
$DOGJQE ACTION=(FETCH,READ)
```
  - To obtain the address of an update-mode JQE or JQA (for example, your exit needs to change the SYSAFF or PRIORITY or MAXCC), perform the action:  

```
$DOGJQE ACTION=(FETCH,UPDATE)
```
2. If you are writing Exit 47, do not use \$DOGJQE to access a JQE or a JQA.
3. If you are writing user environment exits, such as Exit 50, Exit 52, Exit 53, Exit 54, or Exit 57, do not use \$DOGJQE to obtain an update mode JQA. These exits, when passed a JQE, will always be passed an update-mode JQA. Exit 56 will always be passed a read-mode JQA.
4. If you are writing JES2 exits that are in the following situations:
  - Run outside the JES2 main task

- Need to access or update checkpoint control blocks

you need to follow the specific coding recommendations in “Checkpoint control blocks” on page 413 and those specific "Programming Considerations" listed for the JES2 exit that you are implementing.

### Checkpoint control blocks for JOEs

JES2 provides different types of artificial JOEs (that is, JOAs) to your exit and processes them in differing ways. The types are:

- Read-mode JOA. Your exit receives an artificial JOE that is a temporary block of storage. This storage contains:
  - Information about the Work JOE
  - Information about the Characteristics JOE
  - Information about the JOE Extension (JOX)
  - Information about BERTs (another checkpointed area). BERT data that is owned by JOEs is new for JES2 release V1R11 code running in z11 checkpoint activation mode. For more information about JES2 z11 activation see the \$ACTIVATE and \$DACTIVATE commands in *z/OS JES2 Commands*.
- Update-mode JOA. Your exit receives an artificial JOE that is a temporary block of storage. This storage is similar to the read-mode JOA. JES2 ensures the integrity of this JOA and manages the storage that each JOA occupies.
- Work area that contains a prototype JOA. In certain circumstances, your exit may be passed the address of a work area that contains a working copy of a JOA. For example, a prototype JOA is embedded in the JOE Information Block (\$JIB). See Exit 23 for more information.

Exits normally use JOAs in read mode (data in the JOA is used but not modified) or in write mode (data in the JOA is modified). The exit should always obtain either a READ or an UPDATE mode JOA. The use of the real JOE should be avoided if possible. JES2 exit writers need to take the following actions:

- If a JOA is needed only to access data, a local read mode JOA should be obtained. Regardless of what IBM has provided as the JOA address, use the following action to obtain the address of a read mode JOA. The address of the local read mode JOA is returned in R0.

```
$DOGJOE ACTION=(FETCH,READ), JOE=joa
```

where *joa* is the address of the JOA that IBM code provides to the exit.

After you finish, use the following action to free the memory that is used for the local read mode JOA:

```
$DOGJOE ACTION=RETURN, CBADDR=joa
```

where *joa* is the JOA address that is returned from the first \$DOGJOE call.

- If the exit must modify JOA fields, a local update mode JOA should be obtained. Regardless of what IBM has provided as the JOA address, use the following action to obtain the address of an update mode JOA. The address of the local update mode JOA is returned in R0. Make all changes to fields in the local update mode JOA.

```
$DOGJOE ACTION=(FETCH,UPDATE), JOE=joa
```

where *joa* is the address of the JOA provided to the exit by IBM code.

After you finish, use the following action to free the memory that is used for the local update mode JOA and to ensure that any changes that are made in the JOA are propagated to the real work JOE, the real characteristics JOE, the JOX, and the BERT area.

```
$DOGJOE ACTION=RETURN, CBADDR=joa
```

where *joa* is the JOA address returned from the first \$DOGJOE call.

**Update mode JOA considerations for wait conditions:** If an exit requires an update-mode JOA, but cannot wait for a possible conflict to be resolved, use the following logic path:

1. Perform the action:

```
$DOGJOE ACTION=(FETCH,UPDATE), JOE=joa, WAIT=NO
```

where *joa* is the address of the JOA that IBM code provides to the exit.

2. If JES2 returns a return code indicating that the update mode JOA could not be created, you must manage the situation of lock not available.
3. If RC=0, perform rest of the exit logic by using the update mode JOA.
4. Perform the action:

```
$DOGJOE ACTION=RETURN, CBADDR=joa
```

where *joa* is the address that is returned in R0 from FETCH in the first step.

#### **Other processing considerations:**

**JOA processing considerations:** When your exit returns a JOA to the JES2 systems through these actions, certain errors can occur if JES2 determines that what your exit has returned is not consistent with what JES2 knows to exist. JES2 uses the \$ERROR macro and issues the following errors:

- D01– Non-IBM code returned an IBM JOE or JOA that violates the consistency checks of JES2.
- D02– IBM code returned a non-IBM JOE or JOA that violates the consistency checks of JES2.

#### **Note:**

1. You are encouraged to disregard the kind of JOA that is passed to your exit and always to do the following actions:
  - To obtain the address of a read-mode JOA (for example, your exit needs to examine but not change the JOEFORM field), perform the action:  

```
$DOGJOE ACTION=(FETCH,READ)
```
  - To obtain the address of an update-mode JOA (for example, your exit needs to change the JOEHSRSN field), perform the action:  

```
$DOGJOE ACTION=(FETCH,UPDATE)
```
2. If you are writing JES2 exits that are in the following situations:
  - Run outside the JES2 main task
  - Need to access or update checkpoint control blocks

you need to follow the specific coding recommendations in "Checkpoint control blocks" on page 413 and those specific "Programming Considerations" listed for the JES2 exit that you are implementing.



## \$JCT/JMR relationship

The MVS Job Management Record (JMR) is initialized as part of the JES2 \$JCT when the \$JCT is built by HASPRDR.

Additionally, the following information should help in the understanding of the \$JCT and JMR relationship:

- SMF documentation references to the Common Exit Parameter Area (CEPA) which is actually the MVS JMR.
- During the Conversion, Execution, and Purge phases of JES2, the JMR is built by copying the JMR section of the JES2 \$JCT into the MVS JMR and constructing the JMR extension.
- At the end of the Conversion and Execution phases of JES2, the MVS JMR is copied back into the \$JCT. Any alterations to the JMR is therefore checkpointed along the JES2 \$JCT.
- The CEPA User-Communication field (defined as JMRUCOM in the JMR) could be used to provide addressability to the JES2 \$JCT for SMF exits.
- There is a MVS Job Control Table (JCT). It's built by MVS and used during execution by MVS. and has nothing to do with the JES2 JCT.

The following table, Table 14, displays a side-by-side label comparison of the JMR (CEPA) and the JES2 \$JCT/JMR areas.

Table 14. \$JCT/JMR Definitions

| \$JCT Label            | JMR Label        | Length        | Field Description  |
|------------------------|------------------|---------------|--|
| JCTJMRJN               | JMRJOB           | 8 characters  | 8-character job name from JOB JCL statement                                    |
| JCTRDRON               | JMRENTRY         | 4 bytes       | Time, in hundreds of second, on Input processor                                |
| JCTRDTON               | JMREDATE         | 4 bytes       | Date on Input processor in form of 00YYDDDDF                                   |
| JCTCPUID               | JMRCPUID         | 4 bytes       | SMF SYSID  |
| JCTUSEID               | JMRUSEID         | 8 characters  | Initialized to blanks by JES2  |
| JCTSTEP                | JMRSTEP          | 1 byte        | Current step number  |
| JCTINDC                | JMRINDC          | 1 byte        | SMF options  |
| JCTJTCC                | JMRFLAG          | 1 byte        | Job status indicator   |
| JCTCLASS               | JMRCLASS         | 1 byte        | First byte of execution job class  |
| JCTUCOM                | JMRUCOM          | 4 bytes       | User communication area - initialized to zeros by JES2                         |
| JCTUJVP                | JMRUTLP          | 4 bytes       | User time limit exit routine   |
| JCTRDRDROF<br>JCTRDTDF | JMRDRSTP         | 8 bytes       | First word is time off input process and second word is date off input process |
| JCTJOBIN               | JMRJOBIN         | 4 bytes       | Job's SYSIN count  |
| JCTRDR                 | JMRRDR           | 2 bytes       | Reader device type and class   |
| JCTJMOPT               | JMROPT           | 1 byte        | SMF option switches  |
| (none)                 | (none)           | 1 byte        | Reserved   |
| JCXJCLA8               | JMRCLASS         | 8 characters  | 8 character jobclass   |
| (none)                 | JMRJOBCORRELATOR | 64 characters | JES job correlator for inclusion in SMF records                                |

---

## Input phase

The JES2 input service exits provide the functions needed to receive all pre-execution batch jobs, started tasks, and time sharing sessions into the system. There are special cases, as outlined in "Job input sources," where some (non-batch) jobs bypass input service.

Many installations use input service exits to control installation standards, tailor accounting information, and provide additional security controls.

## Job input sources

Figure 11 shows the possible sources of jobs entered into JES2. Each of the input sources (known internally as devices) is represented by a Processor Control Element (\$PCE) and a Device Control Table (\$DCT). The \$PCE is the dispatchable element used by the JES2 dispatcher and the \$DCT contains the device (input source) information.

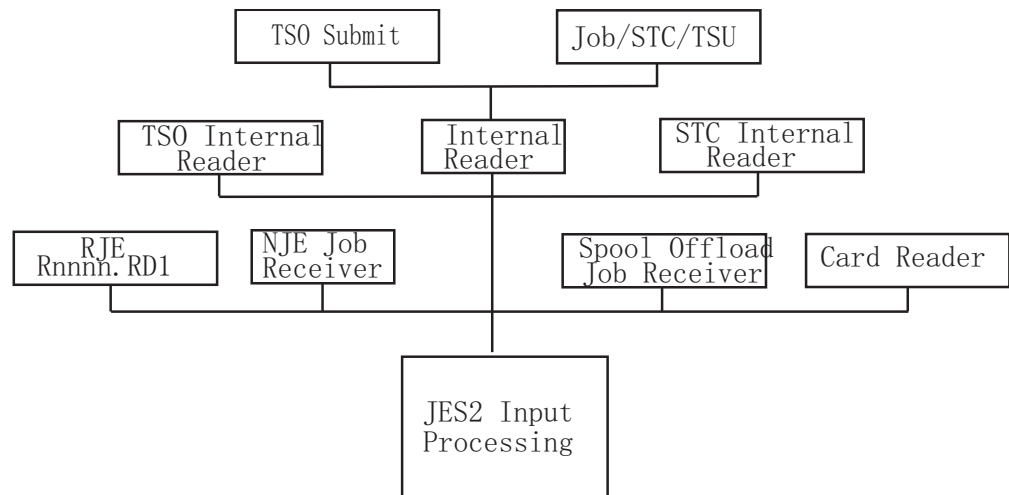

Figure 11. Job input sources

When designing input service exits, be aware that jobs can be entered from a number of input sources. Consider whether the source of a job could affect the exit processing. For example, in the case of a spool offload job receiver, an individual job could be submitted more than once. This could be an important consideration if the purpose of the exit is to add a JCL or JECL statement. A test for a spool offload device (\$DCT) may be in order to see if the additional statement already exists. Also, some exit-provided functions may not apply to all job sources. For example, you might want to bypass started tasks or time sharing sessions when enforcing installation standards. When using spool offload to selectively reload jobs, Exits 2-3-4 will be taken even for jobs that are not selected. This is because the work selection takes place after the JCL has been received.

There are jobs (\$JQEs) that do not originate through input service, for example, the system log (\$SYSLOG), the JES2 trace facility (\$TRCLOG), and remote message spooling (\$RMTMSG) that are created internally and do not have JCL associated with them. Additionally, there are jobs created for NJE and spool offload SYSOUT receivers and NJE store-and-forward jobs. These are also specially created jobs that do not go through input service and therefore input service exits are not taken for these special jobs.

## Job input service processing

The following scenarios describe the exits and the sequence of exits for a normal batch job entered through either main task or user environment of JES2 input service.

*Table 15. Job Input Service Exits - Main Task.* This applies to physical card readers, remote readers, spool offload devices, and SNA/BSC NJE devices.

| Step | Processing  | Exit Used            |
|------|---|----------------------|
| 1    | If the job source is a NJE job receiver or a spool offload job receiver (reload), Exit 47, the NJE header exit, is processed before Exit 2. For all other job sources, Exit 2 will be the first exit to be taken.   | 47                   |
| 2    | A job statement is read and the \$JCT is initialized. Exit 2 has control before the actual scanning of the job statement. You can set the job defaults, the spools allowed mask (fencing), and the job exit mask (to prevent certain future exits to be taken). You may also control the message class of a job at this time.<br><br>The job statement has not been processed. To control or override statement parameters, change either the actual parameter in the buffer or, choose a later exit to alter field in the control block after the job statement scan is complete. For each JOB continuation statement, an additional Exit 2 is taken with a value of 4 in general register 0 | 2                    |
| 3    | After the job and job continuation statements have been processed, a spool track is obtained using \$TRACK and Exit 11.   | 11                   |
| 4    | An \$IOT is initialized, and the spool control blocks (\$JCT and \$IOT) are written to spool. Exit 7 is taken.  | 7                    |
| 5    | Exit 3 processes accounting information. The job statement has already been written to the spool JCL data set. Therefore, it is too late to alter the accounting information passed to the MVS Converter. To alter accounting information, use HASPRSCAN.   | 3                    |
| 6    | Exit 4 processes submitted JCL, JCL continuation, and JES control statements (JECL). JCL residing in PROCLIB is not processed. To process all JCL, use SMF exit IEFUJV or Exit 6. Exit 4 processes all JECL (/), with the exception of internal reader control statements (such as /*EOF, /*DEL.).  | 4                    |
| 7    | Exit 2 is taken. After Exit 2, the NJE header validation routine is taken to verify the structure of the network job trailer and indicate the end of the job.   | 2                    |
| 8    | If the input device is an NJE Job Receiver, Exit 47 is taken for the network job trailer. Exit 47 can be used to: <ul style="list-style-type: none"> <li>Reject the job (and hold it at the transmitting node)</li> <li>Accept the job (and add or remove sections of the NJE header).</li> </ul>   | 47                   |
| 9    | After all the submitted JCL and JECL have been processed for a job, SAF calls are made to verify the job. Six additional SAF calls are made to process system generated spool data sets (joblog, job messages, JCL, and so on.). For each SAF call, Exits 36, 37 are taken. The SAF router exit (ICHRTX00) is also taken.   | 36<br>37<br>ICHRTX00 |

Table 15. Job Input Service Exits - Main Task (continued). This applies to physical card readers, remote readers, spool offload devices, and SNA/BSC NJE devices.

| Step | Processing  | Exit Used |
|------|---|-----------|
| 10   | <p>After all of the job's submitted JCL and JECL have been processed, and end of file (EOF) condition causes control to be passed to the end of job processing, Exit 20 is taken. Exit 20 allows final changes to the job without the exposure of further job JCL and JECL alterations. The final write of the \$JCT and \$IOT to spool follows Exit 20.</p> <p>The \$JQE has not been checkpointed so you can make changes affecting the \$JQE. You can make changes to job class and job priority and JES2 will propagate the changes to the \$JQE. To change other fields, such as JQEJNAME which require the alteration of the \$JQE, use the \$DOGJQE service to obtain an update mode JQE. When the updates are complete, use the \$DOGJQE service to return the updated JQE.</p> | 20        |
| 11   | <p>Exit 7 is taken again when the \$JCT and \$IOT are written to spool. Exit 7 could be used to create an installation defined spool-resident control block. The headers are kept in separate SPOOL buffers with their address pointers in the \$JCT.</p> <p>The \$JCTX macro extension service allows you to add, expand, locate, and delete \$JCT extensions. These extensions can be used to store job-related accounting information that can be copied throughout a network.</p>   | 7         |
| 12   | <p>The \$JQE is moved from the input queue to the conversion queue and checkpointed. If an error occurs, the \$JQE is placed on the output queue or purge queue and checkpointed. Exit 51 is taken when the job moves on from one queue to the next.</p>  | 51        |

Table 16. Job Input Service Exits - User Environment. This applies to internal readers (batch, STC, and TSU), and TCP/IP NJE job receivers.

| Step | Processing   | Exit Used |
|------|--|-----------|
| 1    | <p>If the job source is a NJE job receiver or a spool offload job receiver (reload), Exit 57, the NJE header exit, is processed before Exit 52. For all other job sources, Exit 52 will be the first exit to be taken.</p>   | 57        |
| 2    | <p>A job statement is read and the \$JCT is initialized. Exit 52 has control before the actual scanning of the job statement. You can set the job defaults, the spools allowed mask (fencing), and the job exit mask (to prevent certain future exits to be taken). You may also control the message class of a job at this time.</p> <p>The job statement has not been processed. To control or override statement parameters, change either the actual parameter in the buffer or, choose a later exit to alter field in the control block after the job statement scan is complete. For each JOB continuation statement, an additional Exit 52 is taken with a value of 4 in general register 0</p> | 52        |
| 3    | <p>After the job and job continuation statements have been processed, a spool track is obtained using \$TRACK and Exit 12.</p>   | 12        |
| 4    | <p>An \$IOT is initialized, and the spool control blocks (\$JCT and \$IOT) are written to spool. Exit 8 is taken.</p>  | 8         |

Table 16. Job Input Service Exits - User Environment (continued). This applies to internal readers (batch, STC, and TSU), and TCP/IP NJE job receivers.

| Step | Processing   | Exit Used            |
|------|--|----------------------|
| 5    | Exit 53 processes accounting information. The job statement has already been written to the spool JCL data set. Therefore, it is too late to alter the accounting information passed to the MVS Converter. To alter accounting information, use HASPRSCAN.   | 53                   |
| 6    | Exit 54 processes submitted JCL, JCL continuation, and JES control statements (JECL). JCL residing in PROCLIB is not processed. To process all JCL, use SMF exit IEFUJV or Exit 6. Exit 54 processes all JECL (/*), with the exception of internal reader control statements (such as /*EOF, /*DEL.).  | 54                   |
| 7    | Exit 52 is taken. After Exit 52, the NJE header validation routine is taken to verify the structure of the network job trailer and indicate the end of the job.  | 52                   |
| 8    | If the input device is an NJE Job Receiver, Exit 57 is taken for the network job trailer. Exit 57 can be used to: <ul style="list-style-type: none"> <li>Reject the job (and hold it at the transmitting node)</li> <li>Accept the job (and add or remove sections of the NJE header).</li> </ul>  | 57                   |
| 9    | After all the submitted JCL and JECL have been processed for a job, SAF calls are made to verify the job. Six additional SAF calls are made to process system generated spool data sets (joblog, job messages, JCL, and so on.). For each SAF call, Exits 36, 37 are taken. The SAF router exit (ICHRTX00) is also taken.  | 36<br>37<br>ICHRTX00 |
| 10   | After all of the job's submitted JCL and JECL have been processed, and end of file (EOF) condition causes control to be passed to the end of job processing, Exit 50 is taken. Exit 50 allows final changes to the job without the exposure of further job JCL and JECL alterations. The final write of the \$JCT and \$IOT to spool follows Exit 50.  | 50                   |
| 11   | Exit 8 is taken again when the \$JCT and \$IOT are written to spool. Exit 8 could be used to create an installation defined spool-resident control block. The headers are kept in separate SPOOL buffers with their address pointers in the \$JCT.<br><br>The \$JCTX macro extension service allows you to add, expand, locate, and delete \$JCT extensions. These extensions can be used to store job-related accounting information that can be copied throughout a network. | 8                    |
| 12   | The \$JQE is moved from the input queue to the conversion queue and checkpointed. If an error occurs, the \$JQE is placed on the output queue or purge queue and checkpointed. Exit 51 is taken when the job moves on from one queue to the next.  | 51                   |

## Conversion phase

The interpreter converts C/I text to SWA control blocks used by the initiator to run the job. The interpreter can be called as part of the conversion phase of a job or at the start of a job's execution. When the interpreter is run is based on the INTERPRET keyword on JOBDEF. If INTERPRET=JES, the interpreter is called during the conversion phase.

When the interpreter is called during the conversion phase, processing for both the converter and the interpreter is normally run under a subtask in the JES2CI address space. The actual address space name is *jesxCInm*, where *jesx* is the subsystem name and *nm* is a number 1-25. Exits in this environment are called at the same point in processing as they are when running in the JES2 address space. However, because the code is running in a separate address space, the exits cannot access JES2 private storage data areas such as the HCT and the PCE.

Other control block structures are the same regardless of the environment; there is a converter DTE in both environments. The local work areas are the \$CIWORK and \$CIWORKB (31 and 24 bit data areas); both are in private storage in the address space. Communications between the PCE and the subtask is done by the \$CIPARM data area, which is located in the "PSO" data space with an address and ALET in the \$DTE work area.

When considering exit usage, you must consider the environment that the exit will run in. Exit 7 (CBIO for the \$JCT) executes in the maintask environment, Exit 8 (CBIO for the IOT) runs in the user environment, and Exit 6 and the SMF IEFUJV exit execute in the subtask environment when the converter is being called in the JES2 address space. If the converter is being called from the JES2CI environment, then Exit 7 and 8 are running in the same environment, Exit 60 is called in the user environment instead of Exit 6, and the SMF IEFUJV exit is running in the user environment. All user environment exits called from the JES2CI address space cannot access JES2 private storage. If maintask functions are required for a subtask exit, two exits might be required to provide a specific function: for example, Exit 6 or 60 in conjunction with Exit 44.

Another important consideration is that there can be, and typically are, more than one converter processor (and subtask); therefore, any exits taken in the subtask or user environment (Exits 6, 59, 60, and SMF exit IEFUJV) must be MVS reentrant. The following scenario describes the processing that occurs during the conversion processing.

*Table 17. Conversion phase processing*

| Step | Processing   | Exit Used |
|------|--|-----------|
| 1    | A job is selected from the input queue, and the job's \$JCT is read from spool. Exit 7 is invoked with a value of zero in general register zero (R0=0). The Converter Interpreter Parameter area (\$CIPARM) is initialized and the Converter subtask is POSTed (either in the JES2 or JES2CI address space).   | 7         |
| 2    | The JES2 conversion subtask locates the job's \$PDDBs (JES2 Peripheral Data Definition Blocks) and Fake Opens the ACBs (Access Control Blocks) for internal text, job log, system messages, JCL, and JCL images data sets. The Converter subtask LOADs the MVS Converter, if the Converter has not already been loaded. Exit 8 is taken for reading the \$IOTs from spool.           | 8         |
| 3    | The Security Access Service (\$SEAS) macro calls the Security Authorization Facility (SAF) to build the security environment in case the jobstream contains MVS commands which if present, would be issued by the Converter using the Command SVC. The userid associated with the command would be the user's, not JES2. As a result of the \$SEAS call, Exits 36 and 37 are called. | 36<br>37  |

Table 17. Conversion phase processing (continued)

| Step | Processing   | Exit Used          |
|------|--|--------------------|
| 4    | For each JCL image, SMF exit IEFUJV (entry codes 0, 4, 8, and 64) is taken. This includes continuation statements. IEFUJV is called once more with an entry code of 16.  | SMF exit<br>IEFUJV |
| 5    | After the statement and all continuation statements have been converted into C/I text, the Converter exit, XTXTEXIT is called to provide spool data set names for SYSIN and SYSOUT JCL statements. If the statement represents a SYSIN data set, a \$SEAS call is made to audit the creation.  | XTXTEXIT           |
| 6    | At the completion of conversion and after the Converter returns to the JES2 converter processor module Exit 6 (when running in the JES2 address space) or Exit 60 (when running in the JES2CI address space) is taken with R0 set to 4 to allow final conversion processing.   | 6/60               |
| 7    | At the completion of conversion and after the Converter returns to the JES2 converter processor module, a \$SEAS call is issued to delete the security environment. Exit 6 (R0=4) is taken again to allow final processing.  | 6                  |
| 8    | If the interpreter should be called because INTERPRET=JES is set (bit CIPOINTR in CIPARM flag CIPOFLAG is on) and the job is not to be reconverted, then the JCL, JCL images, and internal test ACBs are fake closed. The internal text ACB is fake opened for input and SWA blocks ACB fake opened for output. The environment is set up and the MVS interpreter is called. After calling the interpreter, any JESDS and MERGE=YES OUTPUT statements are processed. Then Exit 59 is called with the SWA blocks still in memory. After exit 59, the SWA blocks are written to spool, and the SWA data areas deleted. | 59                 |
| 9    | A \$SEAS call is issued to delete the security environment and exits 36 and 37 are called as a result.   | 36<br>37           |
| 10   | Exit 8 is taken to write the \$IOTs. The JES2 converter processor module subtask POSTs its maintask and WAITs for the next job.  | 8                  |
| 11   | Exit 44 is taken to allow user modifications that require the maintask environment. Using the \$DOGJQE macro you can access and optionally update fields in the JQE.   | 44                 |
| 12   | The JES2 converter module checkpoints the \$JCT and invokes Exit 7.  | 7                  |
| 13   | The \$JQE is queued to the execution queue and Exit 51 is invoked.   | 51                 |

The conversion phase offers the only chance to have exit control over all of a job's JCL. Although SMF exit, IEFUJV is taken for each JCL and JCL continuation statement, JES2 Exit 6 and Exit 60 offers some advantages.

First, the format of the C/I text is more structured. It is in parsed form and all major syntax errors have been removed. This has all been done by the converter before the exit gets control.

Another advantage of Exit 6 and Exit 60 over IEFUJV is that when JCL statements have been converted into C/I text, there are no continuation statements. That is, the entire JCL statement, along with all continuation statements, are represented by a single C/I text statement.

A SAF security environment exists within the subtask and can be used with the RACF FACILITY class to control the specification of options within JCL. Exit 6 and Exit 60, messages can be returned to the Converter to be issued by the Converter.

---

## Execution phase

This section attempts to merge those functions provided by a section of JES2 code in the JES2 Job Select/Termination module known as “Job Selection” and the pieces of MVS code known in the broad sense as “The Initiator”. The MVS Initiator consists of many modules which perform job selection, allocation, and initiator attach services (and others). JES2 Job Select also includes end-of-job functions.

For the purpose of this discussion, job selection is defined as the period, starting with the initiator's Subsystem Interface (SSI) call for job selection by class and ends with the JES2 message, **\$HASP373 JOB STARTED**. The following scenario describes the processing that occurs during the Execution Phase.

*Table 18. Execution Phase Exits*

| Step | Processing  | Exit Used |
|------|---|-----------|
| 1    | <p>The MVS Job Selection module issues a SSI call specifying function code 5 which identifies the call to JES2 as a request to select a job by class.</p> <p>SSI calls with a function code of 5 are processed by the JES2 Job Select/Termination module. JBSELECT POSTs JES2 execution processing and WAITs for a job to be selected.</p> <p>If a JES2 initiator is selecting work, JES2 calls Exit 14 to allow the your installation to provide its own queue selection routine or to tailor the selection request. Exit 14 is not a job-related exit, that is, JES2 has not selected a job at this time. Exit 14 can select a job or it can tell JES2 to select a job. If a WLM initiator is selecting work, JES2 does not call Exit 14.</p> <p>After JES2 selects a job from the execution queue, it calls Exit 49 which can accept or reject the job. If Exit 49 rejects the job, JES2 searches for another job. JES2 does not call Exit 49 if Exit 14 selects a job.</p> <p>If JES2 execution processing finds a job that matches the Initiator's defined job classes, it POSTs the waiting initiator and provides the job's \$JCT spool address in the \$\$JB. If a job has been found, control is given to the JBFOUND routine.</p> | 14        |



Table 18. Execution Phase Exits (continued)

| Step | Processing   | Exit Used       |
|------|--|-----------------|
| 2    | <p>The JBFOUND routine reads the job's JES2 \$JCT using the spool address passed in the \$SJB. Exit 8 is the first exit taken out of the user's (or job's) address space after a job is selected. This first entry to Exit 8 is taken after the job's \$JCT has been read. The job name, jobID, and all the other information in the \$JCT are available.</p> <p>If later SMF exits for this job need addressability to the JES2 \$JCT, store the JES2 \$JCT address (as contained in Exit 8 parameter list) into the JCTUCOM field that later becomes the JMRUCOM.</p>  | 8               |
| 3    | <p>Exit 8 is again taken to read the primary allocation \$IOT. There may also be additional calls to Exit 8 to read secondary allocation \$IOTs or \$PDDB-only \$IOTs based on the job's JCL. Exit 8 is called for all spool control block reads and writes.</p> <p>JES2 allows installations to create extensions to the \$JCT where job-related accounting data can be stored and transmitted through the network. Using the \$JCTX macro extension service, you can add, expand, locate, and delete these extensions. For more information about using these extensions, see <i>z/OS JES2 Macros</i>.</p>   | 8               |
| 4    | <p>The JBFOUND routine calls the MVS SWA Create Control module to obtain storage for and initialize the Interpreter Entry List. The Interpreter Entry List contains information from JES2, such as user ID and security information and is used for linking to the MVS Interpreter.</p> <p>Both JES2 and MVS have a data area named JCT. The two JCTs are not similar and one is not a copy, or partial copy, of the other. The Interpreter Entry List contains a pointer to the in-storage copy of the beginning of the \$JCT JMR area which is used to create the CEPA/JMR.</p> <p>The MVS Interpreter Initialization routine calls the MVS Interpreter Router routine and after the internal text has been interpreted, the MVS Enqueue routine issues the call to SMF exit IEFUJV (entry code of 32). This is the first SMF exit for a job during the execution phase. The Scheduler Work Area (SWA) job and step tables have been created. The JMR pointer, called the CEPA in SMF documentation, is provided in the exit parameter list.</p> | IEFUJV          |
| 5    | <p>After the Interpreter returns control to the MVS SWA Create Control module, a RACROUTE REQUEST=VERIFY,ENV=CREATE is then issued to create the job's security environment. The SAF Router exit is invoked if it exists and Message ICH70001I is issued by RACF identifying the user. If an error occurred during Job Select processing, for example a JCL error, then the job's security environment is not created.</p>   | SAF Router exit |
| 6    | <p>Exit 32 is called. The \$JCT, all \$IOTs the JMR, and the ACEE have been created and are available.</p> <p>The JBSELECT routine then issues the \$HASP373 JOB STARTED message.</p>  | 32              |

Table 18. Execution Phase Exits (continued)

| Step | Processing   | Exit Used           |
|------|--|---------------------|
| 7    | Before job select processing is complete and control returns to the Initiator, JES2 checkpoints (writes to spool) the \$JCT. Exit 8 is called.   | 8                   |
| 8    | Job initiation calls SMF exit, IEFUJI. MVS job initiation is a series of calls to step initiation based on the number of steps in a job.   | IEFUJI              |
| 9    | MVS step initiation consists of a call to SMF exit, IEFUSI, step allocation for those data sets and devices defined in the job's JCL, and a call to the MVS Initiator Attach routine.  | IEFUSI              |
| 10   | Allocation of JCL defined SYSIN, SYSOUT, and internal readers initiates a call to Exit 31.   | 31                  |
| 11   | The MVS Initiator Attach routine attaches a subtask with an entry point of the program name specified on the EXEC JCL statement for the job step. The job step could dynamically allocate JES2 SYSIN, SYSOUT, or internal readers and therefore Exit 31 can be called.   | 31                  |
| 12   | The OPEN and CLOSE of JES2 data sets and internal readers call Exits 30 and 33.  | 30<br>33            |
| 13   | Dynamic Unallocation of JES2 data sets and internal readers initiate a call to Exit 34. Exit 48 can be used in preference to Exit 34. Exit 34 may be too early to affect some fields in the \$PDDB because unallocation processing takes place after Exit 34. Use Exit 48 when altering fields in the \$PDDB, this exit can also be used to control Spin processing. | 34                  |
| 14   | At End-of-Task (EOT) processing an SSI call is made to JES2 and Exit 35 is called.   | 35                  |
| 15   | Control is passed (return from Attach) to the MVS Initiator Attach routine and subsequently MVS Step Delete calls Step Unallocation which unallocates those data sets and devices defined in the job's JCL on a step basis. Exit 34 is called for JCL defined SYSIN, SYSOUT, and internal readers. Exit 48 is also taken as mentioned previously.                    | 34<br>48            |
| 16   | The MVS Unallocation routine calls the MVS SMF Control routine which calls SMF exit IEFACRT with entry codes 20 and 12. If additional job steps are to be processed, control is passed back to step 8. Otherwise, control is passed to Job Termination at step 17.   | SMF exit<br>IEFACRT |
| 17   | Job Termination (actually this is Step Termination for the last step) again calls SMF exit IEFACRT with entry codes 20 and 16. Control is then passed to MVS Step Delete where a SSI call (12) is made for Job Termination.  | IEFACRT             |
| 18   | End-of-job processing calls Exit 28. This exit can clean up resources obtained over the life of job execution.   | 28                  |
| 19   | Spool control blocks are checkpointed. Exit 8 is taken for writing the JCT.  | 8                   |
| 20   | The \$JQE is placed on the OUTPUT queue waiting output processing, and Exit 51 is invoked.   | 51                  |

---

## Spin phase

Spin processing typically takes place during the execution phase, however because of processing alternatives, which could occur during execution, the spin phase could happen immediately after the execution phase, but always before the output phase. Spin processing consists of processing the unspun queue and building Job Out Elements (\$JOEs) for each unspun spool data set.

The output phase follows the spin phase processing and is sometimes confused with the hardcopy phase. Output phase processing scans the job's \$IOT chains and if there are \$PDDBs representing non-held output, these \$PDDBs will be grouped into \$JOEs. Held output data sets are grouped into \$JOEs which are the elements representing output groups (spool data sets with like characteristics). \$JOEs are queued by class in the Job Output Table (\$JOT) and are ordered FIFO, within priority, by route code.

After all \$PDDBs have been assigned output groups the job's \$JQE is placed on the hardcopy queue to await print, punch, transmission, or canceling of job output. The following describes the Spin Phase processing.

*Table 19. Spin Phase Processing*

| Step | Processing  | Exit Used |
|------|---|-----------|
| 1    | After selecting a job from the \$SPIN queue, the spin processor scans through the \$IOTs which represent unspun data sets. When a unspun \$IOT is found, Exit 40 gains control to allow the installation to change the characteristics of the data set before grouping the data set into an output group (\$JOE). | 40        |
| 2    | A \$#BLD macro is issued to build a \$JOE and a \$#ADD macro is issued to add the \$JOE to the \$JOT.   |           |
| 3    | The \$QMOD macro queues the job (\$JQE) to the OUTPUT queue for processing, and Exit 51 is invoked.   | 51        |

---

## Output phase

The following describes the Output Phase processing.

*Table 20. Output Phase Processing*

| Step | Processing  | Exit Used    |
|------|---|--------------|
| 1    | The \$QGET service searches the job queue to find a candidate for output processing. Exit 14 (\$QGET) is taken before a job is selected so this is not a job-related exit.                    | 14           |
| 2    | Because there can be multiple output processors, the job lock (\$GETLOCK) provides serialization on a job basis. When the lock is obtained, the \$JQE is checkpointed using the \$CKPT macro. | \$CKPT macro |
| 3    | After the job is selected and the job lock obtained, the job's \$JCT is read from spool and Exit 7 is called.   | 7            |
| 4    | If NOTIFY= was coded on the JOB JCL statement, NOTIFY processing calls Exit 16. This exit, is conditionally based on the job's JCL parameter.   | 16           |

Table 20. Output Phase Processing (continued)

| Step | Processing   | Exit Used |
|------|--|-----------|
| 5    | After NOTIFY processing, the job's \$IOTs are read from spool, \$PDDBs are scanned, and the non-HELD \$PDDBs are assigned to \$JOEs. HELD \$PDDBs are also assigned to \$JOEs. \$JOEs represent output groups, an output group can represent one or more spool data sets with like characteristics. Before each data set is grouped, Exit 40 is taken for each data set. Any changes made to the \$PDDB will be used to determine data set grouping. Use Exit 40 to change SYSOUT characteristics. Exit 40 is taken before the data set has been gathered into an output group (\$JOE). After all non-HELD PDDBs are processed, the \$JCT is checkpointed. This is done to update the spool-resident \$JCT with alterations made during output processing. | 40        |
| 6    | After the \$JCT is checkpointed, the job's \$JQE is moved to the hardcopy queue to await printing or other processing of job output. The \$JQE is checkpointed after being moved to the hardcopy queue. Exit 51 is invoked when the job moves to the hardcopy queue.   | 51        |

---

## Hardcopy phase

The hardcopy phase of JES2 processing takes place after output processing. The job's \$JQE is placed on the hardcopy queue where it waits until all output is processed.

To be processed, HELD data sets must be either released, canceled, or transmitted (SPOOL Offload or NJE). All data sets are grouped into \$JOEs. However, held data sets are not eligible for hardcopy processing even though they are represented by \$JOEs. Since \$JOEs are always resident in memory, the performance of held data sets is improved.

A common misconception with JES2 users is that output is assigned to a printer or output device. Output is only assigned to an output class and has other output characteristics. Output devices, printers, punches, external writers, and so forth, select job output from the output queues (\$JOT or Job Output Table) by class and other output characteristics. Output has no affinity to an output device, for example, a printer. Output must be selected by the device based on the output data set characteristics matching the device work selection (WS=) criteria. Route code is the most common characteristic used to match job output with an output device.

This section discusses two types of hardcopy processing, JES2 controlled devices and Print Services Facility™ (PSF) controlled devices. The JES2 Print/Punch Processor module contains the necessary functional routines for controlling and writing to JES2 output devices, both local and remote.

Only line mode printing is supported for JES2 devices. Page mode output data must be processed by PSF. Printing to coax connected printers (printers attached through 3174 and so on.), such as 3270 type printers (3276, ...), is not controlled by JES2. Applications, such as JES/328X, are required to support these types of printers.

The following describes the Hardcopy Phase processing.

Table 21. Hardcopy Phase Processing

| Step | Processing  | Exit Used   |
|------|---|---|
| 1    | HASPPRPU initialization consists of assigning an available output device and initializing control blocks and buffers as a result of a Start command (e.g., \$S PRT(5)).   |   |
| 2    | When an output device (either remote or local) has been started a call is made to scan the output queues \$JOT using the \$#GET macro. This is the work selection service which scans the \$JOT to search for output as specified in the work selection parameter list.<br><br>When an output group (\$JOE) has been selected the job's \$JCT is read from spool and Exit 7 is taken.   | 7   |
| 3    | If the image subtask has not already been attached, it is done now. A call is made for Exit 1 to allow installations to provide their own separator routine. After Exit 1 (and based on Exit 1 if it exists) the standard JES2 supplied separator page may be produced.<br><br>The jobs \$IOTs are read from spool and the \$PDDBs (contained within the \$IOTs) are obtained. Setup is called to check if device and data set characteristics match. Operator intervention may occur here. | 1   |
| 4    | A call is made (\$SEAS) to verify that the data set userid (owner) is allowed to print on this device. Exits 36 and 37 are taken.   | 36<br>37  |
| 5    | Exit 15 (R0=0) is called for data set select. This exit point could be used to control copy count, print translate table, or the CCW translate tables.  | 15  |
| 6    | Exit 15 (R0=4) is again called to allow user produced data set separators. The \$#CHK macro is used to produce a checkpoint at this time. A checkpoint produces a checkpoint \$JOE that allows for recovery in case of a system or device failure.  | 15  |
| 7    | The main print/punch loop is where SPOOL buffers are read, channel programs are constructed for the output device, and \$EXCPs are issued to print or punch lines of output. This process continues until the entire data set is read and written to the output device. The data set is repeated if copy count is greater than one and a return to step 3 is made if there are additional data sets in the output group to be processed.  | There are no exits available during this process. |
| 8    | Exit 1 is called (R0=8) to allow for installation separator routines to replace the JES2 routine. The \$JOE is placed on the free queue. When there are no more output data sets to be processed for the job, the \$JQE is placed on the Purge queue. Exit 51 is invoked when the job moves to the purge queue.   | 1<br>51   |

## NJE hardcopy phase exits

The following describes the NJE Hardcopy Phase processing:

Table 22. NJE Hardcopy Phase Processing

| Step | Processing  | Exit Used                                       |
|------|---|---|
| 1    | The Network SYSOUT Transmitter initializes a SYSOUT Transmitter device (\$DCT) and acquires resources (lines, buffers, and so on.) to prepare for SYSOUT transmissions.<br><br>The \$#GET service routine is used to search the Job Output Table (\$JOT) to find an eligible \$JOE on the network queue. When a candidate is found the \$CBIO macro is used to read the \$JCT, \$IOTs and \$SWBITs from spool. Exit 7 or 8 is taken for each control block read. If the network job header does not exist, the NJE SYSOUT transmitter builds it.  | Exit 7 (JES2 main task),<br>Exit 8 (TCP/IP NJE) |
| 2    | The \$NHD (Network Job Header) is then read from spool. \$NHD Validation Routine (NJEHDVAL) is called to validate the NJE header structure before transmission. After validation, Exit 46 or 56 is taken. This exit allows the viewing, removing, or alteration of sections in the Network Job Header.  | Exit 46 (JES2 main task),<br>Exit 56 (NJE/TCP)  |
| 3    | A \$SEAS (JES2 Security Authorization Service) authorization check is made for each data set to be transmitted. This call to the SAF typically passes, because of the writer check previously done during the execution phase. The reason that this call should not fail is that a SAF call was made to the WRITER class during SYSOUT allocation at job execution time. If the job owner does not have authority to create SYSOUT destined for a particular node the job will fail in execution.<br><br>Another Exit 46 or 56 is taken for each data set header followed by the data itself. | Exit 46, or<br>Exit 56                          |
| 4    | Exit 46 or 56 is taken again for the job trailer. If the NJE job trailer does not exist, the NJE SYSOUT transmitter builds it. In general, the \$#REM macro is used to remove the \$JOE from the \$JOT output queue.  | Exit 46, or<br>Exit 56                          |
| 5    | The data set is purged (\$#PURGE) and if the device is a Spool Offload SYSOUT Transmitter, an SMF24 record is created. When using SPOOL Offload, the \$JOE could remain on the \$JOT and the data set may not be purged if the installation specified an output disposition where the output would not be purged after processing.  |   |

## Purge phase

The purge phase is the final phase of JES2 processing. Jobs are placed on the purge queue after all spool data set have been processed or if the job gets canceled. Spool tracks are returned, the SMF 26 record is written and the \$JQE is placed on the free queue. The following scenario describes the processing that occurs during the Purge Phase.

Table 23. Purge Phase Exits

| Step | Processing   | Exit Used |
|------|--|-----------|
| 1    | A job is selected from the purge queue, the \$JCT is read and Exit 7 is invoked. | 7         |

Table 23. Purge Phase Exits (continued)

| Step | Processing   | Exit Used |
|------|--|-----------|
| 2    | \$PURGE macro calls the purge service routine for each spool data set. If data set purge verification is active, the \$SEAS macro will be issued for authorization. This invokes Exits 36 and 37 for each purged data set. Spool tracks assigned to the job are returned.  | 36<br>37  |
| 3    | Buffers are gotten to build the SMF type 26 record and the JMR. The SMF 26 record is formatted. \$QUESMFB macro calls the SMB buffer queue routine Exit 21 is called and a \$POSTQ is issued to POST the HASPACCT (SMF Writer) subtask. Because \$QPOST was issued, we do not WAIT on the completion of the SMF write. \$QUESMFB returns to HASVPRG immediately. | 21        |
| 4    | After the HASPACCT subtask is POSTed, SMF exit IEFUJP is called. None of the jobs resources are available. Only the SMF record buffer and the JMR (CEPA) are available. The SMFWTM macro is issued to write the SMF 26 record and HASPACCT WAITs to be POSTed for the next record if there are no others to process.   | IEFUJP    |

Exit 7 could possibly be used as a general purpose exit. Exit 21 and SMF exit IEFUJP are taken after the return of spool tracks. When IEFUJP is invoked, the in-storage buffer containing the \$JCT could be reused and contain another job's \$JCT.





---

## Appendix D. Accessibility

Accessible publications for this product are offered through IBM Knowledge Center (<http://www.ibm.com/support/knowledgecenter/SSLTBW/welcome>).

If you experience difficulty with the accessibility of any z/OS information, send a detailed message to the "Contact us" web page for z/OS (<http://www.ibm.com/systems/z/os/zos/webqs.html>) or use the following mailing address.

IBM Corporation  
Attention: MHVRCFS Reader Comments  
Department H6MA, Building 707  
2455 South Road  
Poughkeepsie, NY 12601-5400  
United States

---

### Accessibility features

Accessibility features help users who have physical disabilities such as restricted mobility or limited vision use software products successfully. The accessibility features in z/OS can help users do the following tasks:

- Run assistive technology such as screen readers and screen magnifier software.
- Operate specific or equivalent features by using the keyboard.
- Customize display attributes such as color, contrast, and font size.

---

### Consult assistive technologies

Assistive technology products such as screen readers function with the user interfaces found in z/OS. Consult the product information for the specific assistive technology product that is used to access z/OS interfaces.

---

### Keyboard navigation of the user interface

You can access z/OS user interfaces with TSO/E or ISPF. The following information describes how to use TSO/E and ISPF, including the use of keyboard shortcuts and function keys (PF keys). Each guide includes the default settings for the PF keys.

- *z/OS TSO/E Primer*
- *z/OS TSO/E User's Guide*
- *z/OS V2R2 ISPF User's Guide Vol I*

---

### Dotted decimal syntax diagrams

Syntax diagrams are provided in dotted decimal format for users who access IBM Knowledge Center with a screen reader. In dotted decimal format, each syntax element is written on a separate line. If two or more syntax elements are always present together (or always absent together), they can appear on the same line because they are considered a single compound syntax element.

Each line starts with a dotted decimal number; for example, 3 or 3.1 or 3.1.1. To hear these numbers correctly, make sure that the screen reader is set to read out

punctuation. All the syntax elements that have the same dotted decimal number (for example, all the syntax elements that have the number 3.1) are mutually exclusive alternatives. If you hear the lines 3.1 USERID and 3.1 SYSTEMID, your syntax can include either USERID or SYSTEMID, but not both.

The dotted decimal numbering level denotes the level of nesting. For example, if a syntax element with dotted decimal number 3 is followed by a series of syntax elements with dotted decimal number 3.1, all the syntax elements numbered 3.1 are subordinate to the syntax element numbered 3.

Certain words and symbols are used next to the dotted decimal numbers to add information about the syntax elements. Occasionally, these words and symbols might occur at the beginning of the element itself. For ease of identification, if the word or symbol is a part of the syntax element, it is preceded by the backslash (\) character. The \* symbol is placed next to a dotted decimal number to indicate that the syntax element repeats. For example, syntax element \*FILE with dotted decimal number 3 is given the format 3 \\* FILE. Format 3\* FILE indicates that syntax element FILE repeats. Format 3\* \\* FILE indicates that syntax element \* FILE repeats.

Characters such as commas, which are used to separate a string of syntax elements, are shown in the syntax just before the items they separate. These characters can appear on the same line as each item, or on a separate line with the same dotted decimal number as the relevant items. The line can also show another symbol to provide information about the syntax elements. For example, the lines 5.1\*, 5.1 LASTRUN, and 5.1 DELETE mean that if you use more than one of the LASTRUN and DELETE syntax elements, the elements must be separated by a comma. If no separator is given, assume that you use a blank to separate each syntax element.

If a syntax element is preceded by the % symbol, it indicates a reference that is defined elsewhere. The string that follows the % symbol is the name of a syntax fragment rather than a literal. For example, the line 2.1 %OP1 means that you must refer to separate syntax fragment OP1.

The following symbols are used next to the dotted decimal numbers.

**? indicates an optional syntax element**

The question mark (?) symbol indicates an optional syntax element. A dotted decimal number followed by the question mark symbol (?) indicates that all the syntax elements with a corresponding dotted decimal number, and any subordinate syntax elements, are optional. If there is only one syntax element with a dotted decimal number, the ? symbol is displayed on the same line as the syntax element, (for example 5? NOTIFY). If there is more than one syntax element with a dotted decimal number, the ? symbol is displayed on a line by itself, followed by the syntax elements that are optional. For example, if you hear the lines 5 ?, 5 NOTIFY, and 5 UPDATE, you know that the syntax elements NOTIFY and UPDATE are optional. That is, you can choose one or none of them. The ? symbol is equivalent to a bypass line in a railroad diagram.

**! indicates a default syntax element**

The exclamation mark (!) symbol indicates a default syntax element. A dotted decimal number followed by the ! symbol and a syntax element indicate that the syntax element is the default option for all syntax elements that share the same dotted decimal number. Only one of the syntax elements that share the dotted decimal number can specify the ! symbol. For example, if you hear the lines 2? FILE, 2.1! (KEEP), and 2.1 (DELETE), you know that (KEEP) is the

default option for the FILE keyword. In the example, if you include the FILE keyword, but do not specify an option, the default option KEEP is applied. A default option also applies to the next higher dotted decimal number. In this example, if the FILE keyword is omitted, the default FILE(KEEP) is used. However, if you hear the lines 2? FILE, 2.1, 2.1.1! (KEEP), and 2.1.1 (DELETE), the default option KEEP applies only to the next higher dotted decimal number, 2.1 (which does not have an associated keyword), and does not apply to 2? FILE. Nothing is used if the keyword FILE is omitted.

**\* indicates an optional syntax element that is repeatable**

The asterisk or glyph (\*) symbol indicates a syntax element that can be repeated zero or more times. A dotted decimal number followed by the \* symbol indicates that this syntax element can be used zero or more times; that is, it is optional and can be repeated. For example, if you hear the line 5.1\* data area, you know that you can include one data area, more than one data area, or no data area. If you hear the lines 3\* , 3 HOST, 3 STATE, you know that you can include HOST, STATE, both together, or nothing.

**Notes:**

1. If a dotted decimal number has an asterisk (\*) next to it and there is only one item with that dotted decimal number, you can repeat that same item more than once.
2. If a dotted decimal number has an asterisk next to it and several items have that dotted decimal number, you can use more than one item from the list, but you cannot use the items more than once each. In the previous example, you can write HOST STATE, but you cannot write HOST HOST.
3. The \* symbol is equivalent to a loopback line in a railroad syntax diagram.

**+ indicates a syntax element that must be included**

The plus (+) symbol indicates a syntax element that must be included at least once. A dotted decimal number followed by the + symbol indicates that the syntax element must be included one or more times. That is, it must be included at least once and can be repeated. For example, if you hear the line 6.1+ data area, you must include at least one data area. If you hear the lines 2+, 2 HOST, and 2 STATE, you know that you must include HOST, STATE, or both. Similar to the \* symbol, the + symbol can repeat a particular item if it is the only item with that dotted decimal number. The + symbol, like the \* symbol, is equivalent to a loopback line in a railroad syntax diagram.



---

## Notices

This information was developed for products and services offered in the U.S.A. or elsewhere.

IBM may not offer the products, services, or features discussed in this document in other countries. Consult your local IBM representative for information on the products and services currently available in your area. Any reference to an IBM product, program, or service is not intended to state or imply that only that IBM product, program, or service may be used. Any functionally equivalent product, program, or service that does not infringe any IBM intellectual property right may be used instead. However, it is the user's responsibility to evaluate and verify the operation of any non-IBM product, program, or service.

IBM may have patents or pending patent applications covering subject matter described in this document. The furnishing of this document does not give you any license to these patents. You can send license inquiries, in writing, to:

IBM Director of Licensing  
IBM Corporation  
North Castle Drive  
Armonk, NY 10504-1785  
U.S.A

For license inquiries regarding double-byte character set (DBCS) information, contact the IBM Intellectual Property Department in your country or send inquiries, in writing, to:

Intellectual Property Licensing  
Legal and Intellectual Property Law  
IBM Japan, Ltd.  
19-21, Nihonbashi-Hakozakicho, Chuo-ku  
Tokyo 103-8510, Japan

The following paragraph does not apply to the United Kingdom or any other country where such provisions are inconsistent with local law: INTERNATIONAL BUSINESS MACHINES CORPORATION PROVIDES THIS PUBLICATION "AS IS" WITHOUT WARRANTY OF ANY KIND, EITHER EXPRESS OR IMPLIED, INCLUDING, BUT NOT LIMITED TO, THE IMPLIED WARRANTIES OF NON-INFRINGEMENT, MERCHANTABILITY OR FITNESS FOR A PARTICULAR PURPOSE. Some states do not allow disclaimer of express or implied warranties in certain transactions, therefore, this statement may not apply to you.

This information could include technical inaccuracies or typographical errors. Changes are periodically made to the information herein; these changes will be incorporated in new editions of the publication. IBM may make improvements and/or changes in the product(s) and/or the program(s) described in this publication at any time without notice.

Any references in this information to non-IBM Web sites are provided for convenience only and do not in any manner serve as an endorsement of those Web sites. The materials at those Web sites are not part of the materials for this IBM product and use of those Web sites is at your own risk.

IBM may use or distribute any of the information you supply in any way it believes appropriate without incurring any obligation to you.

Licensees of this program who wish to have information about it for the purpose of enabling: (i) the exchange of information between independently created programs and other programs (including this one) and (ii) the mutual use of the information which has been exchanged, should contact:

Site Counsel  
IBM Corporation  
2455 South Road  
Poughkeepsie, NY 12601-5400  
USA

Such information may be available, subject to appropriate terms and conditions, including in some cases, payment of a fee.

The licensed program described in this information and all licensed material available for it are provided by IBM under terms of the IBM Customer Agreement, IBM International Program License Agreement, or any equivalent agreement between us.

Information concerning non-IBM products was obtained from the suppliers of those products, their published announcements or other publicly available sources. IBM has not tested those products and cannot confirm the accuracy of performance, compatibility or any other claims related to non-IBM products. Questions on the capabilities of non-IBM products should be addressed to the suppliers of those products.

All statements regarding IBM's future direction or intent are subject to change or withdrawal without notice, and represent goals and objectives only.

If you are viewing this information softcopy, the photographs and color illustrations may not appear.

#### COPYRIGHT LICENSE:

This information might contain sample application programs in source language, which illustrate programming techniques on various operating platforms. You may copy, modify, and distribute these sample programs in any form without payment to IBM, for the purposes of developing, using, marketing or distributing application programs conforming to the application programming interface for the operating platform for which the sample programs are written. These examples have not been thoroughly tested under all conditions. IBM, therefore, cannot guarantee or imply reliability, serviceability, or function of these programs. The sample programs are provided "AS IS", without warranty of any kind. IBM shall not be liable for any damages arising out of your use of the sample programs.

---

## Policy for unsupported hardware

Various z/OS elements, such as DFSMS, HCD, JES2, JES3, and MVS, contain code that supports specific hardware servers or devices. In some cases, this device-related element support remains in the product even after the hardware devices pass their announced End of Service date. z/OS may continue to service element code; however, it will not provide service related to unsupported hardware devices. Software problems related to these devices will not be accepted

for service, and current service activity will cease if a problem is determined to be associated with out-of-support devices. In such cases, fixes will not be issued.

---

## Minimum supported hardware

The minimum supported hardware for z/OS releases identified in z/OS announcements can subsequently change when service for particular servers or devices is withdrawn. Likewise, the levels of other software products supported on a particular release of z/OS are subject to the service support lifecycle of those products. Therefore, z/OS and its product publications (for example, panels, samples, messages, and product documentation) can include references to hardware and software that is no longer supported.

- For information about software support lifecycle, see: IBM Lifecycle Support for z/OS (<http://www.ibm.com/software/support/systemsz/lifecycle/>)
  - For information about currently-supported IBM hardware, contact your IBM representative.
- 

## Programming Interface Information

This publication documents intended Programming Interfaces that allow the customer to write programs to obtain the services of JES2.

---

## Trademarks

IBM, the IBM logo, and [ibm.com](http://www.ibm.com) are trademarks or registered trademarks of International Business Machines Corp., registered in many jurisdictions worldwide. Other product and service names might be trademarks of IBM or other companies. A current list of IBM trademarks is available at Copyright and Trademark information (<http://www.ibm.com/legal/copytrade.shtml>).





# Index

## Special characters

(exit 26) 215  
\$\$WTO macro 20  
\$\$WTOR macro 20  
\$#CHK macro 429  
\$CHK 412  
\$CKPT macro 427  
\$CRET macro 20  
\$CWTO macro 20  
\$D EXIT(nnn) command 55  
\$DCT 418  
\$ENTRY macro 23, 30  
\$ERROR macro 14  
\$ESTAE macro 26  
\$EXIT macro 30, 60  
    MAXRC= operand 14  
\$FREEBUF macro 85  
    \$FREEBUF 85  
    \$GETBUF 85  
\$GETBUF macro 85  
\$GETSMFB usage 197  
\$HASP426 message 79  
\$HASP427 message 79  
\$HASP428 message 80  
\$HASP864 message 82, 208  
\$HASPGBL copying 30  
\$IOT 412  
\$JCAN macro 200  
\$JCT 412  
\$JCT/JMR 417  
\$JCTX extension  
    accounting field 102  
    exit 1 85, 256, 262  
    exit 11 153  
    exit 12 159  
    exit 15 170  
    exit 16 176  
    exit 2 93  
    exit 20 193, 325  
    exit 23 204  
    exit 25 212  
    exit 28 222  
    exit 3 102, 348  
    exit 30 230  
    exit 32 238  
    exit 33 244  
    exit 34 248  
    exit 35 251  
    exit 39 234, 272  
    exit 4 111, 128, 392  
    exit 40 276  
    exit 43 291  
    exit 44 294  
    exit 46 307  
    exit 47 312  
    exit 48 316  
    exit 52 339  
    exit 53 348  
    exit 58 381  
    exit 6 128  
    exit 60 392

\$JCTX extension (*continued*)  
    exit 7 134  
    exit 8 137  
    exit 9 142  
    JCTWORK usage 102  
\$JIB 10  
\$JOE 10  
\$MODEND macro 30  
\$MODULE macro 30  
\$OCT 412  
\$PBLOCK service routine 85  
    \$SEPPDIR usage 85  
\$PCE 418  
\$QUESMFB usage 197  
\$RETURN macro 12, 13  
\$SAVE macro 12  
\$SCAN facility 80, 188  
\$STMTLOG macro 188  
\$STORE macro 13  
\$STRAK (exit 12) 157  
\$SWBIT 412  
\$T EXIT command 188  
\$T EXIT(nnn) command 55  
\$T EXIT(nnn) operator command 26  
\$TRACE macro 26  
\$TRACK (exit 11) 151  
\$USER1 through \$USER5 209  
\$WTO messages, modifying 175  
\$WTO parameter list usage 175  
\$WTO screen exit 147  
&RJOB OPT usage 103

## A

accessibility 433  
    contact IBM 433  
    features 433  
account field scan 75  
accounting field scan exit 97, 344  
across environment exits 8  
addressability of the exit 23  
addressing requirements requirements,  
    addressing  
        \$AMODE  
            AMODE 13  
            31-bit 13  
            residency 13  
        RMODE 13  
affinity  
    system 191, 323  
allocation 151  
    spool partitioning (\$STRAK) 157  
alter console routing 148  
alter SMF control block 197  
altering operating states of exits 5  
analyzing initialization statements 187  
APPC (Advanced Program-to-Program  
    Communication)  
    transaction program (TP) 289  
areas of modification in JES2 1  
assembler language for exits 7

assembly environment  
    \$MODULE macro 8  
assign system affinity 191, 323  
assistive technologies 433  
automatic tracing 26

## B

BSC RJE devices  
    controlling 179  
BSC RJE signon/signoff exit 179  
buffer  
    use in Exit 1 85

## C

calling environment 7  
cancel  
    exit 198  
cancel status exit 198  
CEPA 417, 431  
change notify routing 175  
changing message text (exit 10) 148  
changing output grouping keys 279  
changing SYSOUT characteristics  
    exit 275  
checking initialization statements 187  
checkpoint 429  
checkpoint control blocks 413  
codes 14  
    exit-dependent return codes 14  
    return (greater than 4) 14  
    return codes 14  
coding considerations 11  
    \$ENTRY macro 23  
    addressability of the exit 23  
    control blocks for exits 14  
    exit-dependent return codes 14  
    linkage conventions 11  
    main task exits 11  
    multiple exit routines 12  
    naming the exit 23  
    nonreentrant 11  
    packaging the exit 30, 51  
    received parameters 13  
    recovery for exits 26  
    reentrant 11  
    return codes (greater than 4) 14  
    return codes for exits 14  
    service routine usage 19  
    source module conventions 23  
    subtask exits 11  
    tracing the exit 26  
coding language for exits 7  
COMAUTH structure 120  
command 55  
    \$D EXIT(nnn) 55  
    \$T EXIT 188  
    operator (\$T EXIT(nnn)) 26  
preprocessor exit 117

- communication
  - \$CWTO macro (exit 5) 121
  - exit routine-to-exit point
    - response byte 20
  - exit-to-operator 20
  - JES2-to-operator 2
- condition byte
  - exit point-to-exit routine
    - communication 19
- CONSOLE initialization statement 188
- console message buffer (CMB) 147
  - CMBFLAG usage (exit 10) 148
  - CMBJOB usage (exit 10) 148
  - CMBROUT usage (exit 10) 148
  - CMBTEXT usage (exit 10) 148
  - interrogating (exit 10) 147
  - usage (exit 16) 175
- contact
  - z/OS 433
- control block read/write (JES2) 133
  - JCTJQE usage 133
  - JQETYPE usage 133
  - PCEID usage 134
  - specific description 133
- control block read/write (JES2) exit 133
- control block read/write exit 137
- control blocks for exits 14
- control statement
  - /\*JOBPARM
    - job control field table 102, 348
  - /\*ROUTE
    - job control table field 102, 348
- control statement scan 107
  - HASPRCCS replacement 107
  - recovery 108
  - specific description 107
- control statements
  - /\*SETUP
    - job control table fields 101, 347
- controlling BSC RJE devices 179
- controlling SNA RJE devices 183
- converter
  - exit 44 293
- converter/interpreter text scan 125, 385, 389
  - CNVWORK usage 128, 392
  - recovery 127, 386, 391
  - specific description 125, 385, 389
- converter/interpreter text scan exit 75
- Converter/Interpreter text scan exit 123
- COPY \$HASPGBL 30
- create SMF control block 197
- creation of installation control blocks 207

## D

- data set 188
  - log data set 188
  - separator exit 169
- deleting initialization statements 187
- device 179
  - BSC RJE remote 179
  - SNA RJE remote 183
- disabled exit state 5
- disabling the exit 55
- dual execution environments 8

## E

- enabled exit state 5
- enabling trace (ID 13) for tracing 26
- end of job input exit 191
- environments 7
- environments for exits 7
  - caller's environment 7
  - execution environment 7
  - JES2 main task 7
  - JES2 subtask 7
  - user address space 7
- error 55
  - isolating them 55
- ESTAE 225
  - recovery 225, 229, 233, 237, 243, 247, 251, 255, 261, 381
- execution environment
  - FSS (functional subsystem address space) 7
  - JES2 (main task) 7
  - SUBTASK (subtask) 7
  - USER (user address space) 7
- execution node 191, 323
- exit 1, 210, 323, 329, 335, 355, 365, 369, 375
  - \$WTO screen 147
  - across environments 8
  - addressability 23
  - BSC RJE signon/signoff 179
  - cancel/status 198
  - control block read/write 75
  - control block usage 14
  - Converter/Interpreter text scan 75
  - end of job input 191
  - IBM-defined 3, 65
  - implementation table 75
  - individual purposes 65
  - initialization JCL 41
  - initialization statement scan 187
  - initializing in the system 52
  - installation-defined 3, 59
  - integrating exit routines 51
  - introduction 1
  - JCL/JES2 control statement scan 75
  - JES2 command preprocessor 75
  - job queue work select 163, 319
  - Job Queue Workload Selection (initiator jobs) 75
  - job separator page process 202
  - job statement account field scan 75, 97, 344
  - job statement scan 75
  - job-related 55
  - job-related (defined) 5
  - linkage conventions 11
  - logic 19
  - mask (JOBMASK) 55
  - modifying a notify user message 283
  - modifying SYSOUT
    - characteristics 275
  - multiple exit routines 6
    - linkage conventions 12
  - naming the exit 23
  - NJE SYSOUT reception data set
    - disposition 271
  - notify 175
  - operating environment 7

exit (continued)

- output data set/copy separators 169
- packaging 51
- packaging the code 30
- passing control to them 55
- PCE attach/detach 217
- post initialization 205, 207
- pre-initialization 75
- pre-initialization (exit 0) 79
- pre-security authorization call 255
- print/punch job separator 82
- print/punch separator 75
- received parameters 13
- recovery considerations 26
- reentrant code considerations 11
- return code responsibility 12
- return codes 14
- service routine usage 19
- SMF record 195
- SNA RJE logon/logoff 183
- source module conventions 23
- specific individual uses 65
- specific titles of each 65
- specific uses 65
- spool partitioning allocation
  - (\$STRAK) 157
  - spool partitioning allocation (\$TRACK) 151
- SSI data set allocation 233
- SSI data set CLOSE 243
- SSI data set OPEN and restart 229
- SSI data set unallocation 247
- SSI end-of-memory 223
- SSI end-of-step 381
- SSI end-of-task 251
- SSI job selection 237
- SSI job termination 220
- SSI SYSOUT data set
  - unallocation 315
- status (enabled, disabled) 55
- synchronization 10
- termination 213
- testing exit routines 51
- tracing status 57
- tracing their execution 26
- TSO/E receive data set
  - disposition 267
- using control blocks 14
- writing an exit routine 7

Exit 1

- \$FREEBUF macro 85
- \$GETBUF macro 85
- buffer usage 85

exit 10 147

- CMBFLAG usage 148
- CMBJOB usage 148
- CMBROUT usage 148
- CMBTEXT usage 148

exit 11 151

- \$TRACKX exit point 152
- JCTSAMSK usage 151

exit 12 157

- \$STRAKX exit point 158
- JCTSAMSK usage 157

exit 14 163

- finding job queue work 163

exit 15 169

- exit 15 (*continued*)
  - CCW translate table usage 169
  - PRTRANS table 169
- exit 16 175
  - change notify routing 175
  - CMB usage 175
  - modify \$WTO messages 175
- exit 17 179
- exit 18 183
  - MICEXIT exit point 184
  - MSNALXIT exit point 183
  - MSNALXT2 exit point 184
- exit 19 187
  - \$SCAN facility usage 188
  - \$STMTLOG macro 188
  - \$T EXIT command 188
  - CONSOLE initialization statement 188
  - EXIT(nnn) usage 188
  - LOADmod usage 188
- exit 20 191
  - JCTIPTIO usage 192, 324
  - PCE work area usage 192, 324
- exit 21 197
  - \$GETSMFB usage 197
  - \$QUESMFB usage 197
- exit 22 199
  - \$JCAN macro 200
  - IKJ56216I message 200
- exit 23 203
- exit 24 207
  - \$HASP864 message 208
  - \$T EXIT command usage 208
  - \$USER1 through \$USER5 209
  - EXITnnn statement 208
  - recovery 207
- exit 26 215
- exit 27 219
- exit 28 221
- exit 29 225
- exit 3 99
  - &RJOB OPT use 103
  - exit 3 100
  - HASPRSCN replacement 99
  - JCTJOBID usage 102
  - JCTXWRK usage 103
  - recovery 100, 346
- exit 30 229
- exit 31 233
- exit 32 237
- exit 33 243
- exit 34 247
- exit 35 251
- exit 36 255
- exit 37 261
  - post-security authorization call 261
- exit 38 267
- exit 39 271
- exit 4 107, 108
  - HASPRCCS replacement 107
  - recovery 108
- exit 40 275
- exit 41 279
- exit 42 283
  - recovery 283
- exit 43 289
- exit 44 293

- exit 45 299
- exit 46 305
- exit 47 311
- exit 48 315
- exit 49 319
- exit 5 117, 119
  - \$CWTO macro 121
  - COMAUTH structure 120
  - recovery 119
- exit 50 323
- exit 51 329
- exit 52 335
- exit 53 345
  - exit 53 346
- exit 54 355
- exit 55 365
- exit 56 369
- exit 57 375
- exit 58 381
- exit 59 385, 386
  - recovery 386
- exit 6 125, 127
  - CNVWORK usage 128
  - recovery 127
- exit 60 389, 391
  - CNVWORK usage 392
  - recovery 391
- exit 7 133
  - JCTJQE usage 133
  - JQETYPE usage 133
  - PCEID usage 134
- Exit 9 141
- exit effector 7
  - definition 5
  - tracing 60
- exit facility
  - introduction 1
  - using 3
- exit implementation table 75
- exit migrations 397
- exit module 23
  - security considerations 23
  - source conventions 23
- exit point 3
  - \$STRAKX (Exit 12) 158
  - \$TRACKX (exit 11) 152
  - definition 3
  - identifying them 3
  - logoff 184
  - logon 183
  - MICEXIT (exit 18) 184
  - MSNALXIT (exit 18) 183
  - MSNALXT2 (exit 18) 184
- exit routine 3
  - definition 3
  - integration 51
  - language used 7
  - load module 52
  - loading one 41
  - multiple ones 6, 47
  - passing them control 55
  - placement 54
  - writing one 7
- exit selection table 65

- exit-to-exit communication
  - among exits
    - exit point-to-exit routine condition byte 19
- EXIT(nnn) initialization parameter 26
- exits 395
  - control block read/write 136
  - Converter/Interpreter text scan 123
  - execution phase 424
  - hardcopy phase 428
  - JCL/JES2 control statement scan 107
  - JES2 command preprocessor 115
  - Job Input Service 419
  - job-related 409
  - output phase 427
  - purge phase 430
  - sequence 409
  - spin phase 427
- exits in processing order processing area,
  - exit arrangement processors invoking exits 65
- external names 52

## F

- FSACB 10
- FSS environment 10
- FSSCB 10

## G

- generic grouping
  - modifying selection with an exit 279

## H

- hardcopy
  - console 188
- HASJES20 20, 30
  - location 8
- HASPCOMM 20
- HASPINIT 8, 30
- HASPIRPL 187
- HASPRDR 417

## I

- I/O 1
  - control block 133
- IBM-defined exits 3
  - description 65
- identifying the exit 23
- IEFACTRT 426
- IEFUJI 426
- IKJ56216I message 200
- implementation
  - exit table 75
- implementing initialization statements 187
- initialization 1
  - \$ADD LOADmod(jxxxxx) command 52
  - \$T EXIT(nnn) 53
  - &RJOB OPT use 103
  - EXIT(nnn) parameter 26

- initialization (*continued*)
  - EXIT(nnn) statement 3, 53
  - EXIT(nnn) TRACE= usage 57
  - exits in the system 52
  - JCL 41
  - LOADMOD statement 3
  - LOADMOD(jxxxxxx) initialization statement 52
  - modifying control blocks 207
  - placement of exits 54
  - pre-initialization exit 79
  - processing 1
- initialization statement exit 187
- \$SCAN facility usage 188
- \$STMTLOG macro 188
- \$T EXIT command 188
- checking and analyzing 187
- CONSOLE 188
- CONSOLE initialization statement 188
- EXIT(nnn) 188
- EXIT(nnn) usage 188
- implementing 187
- LOADmod 188
- LOADmod usage 188
- tailoring 187
- initialization statement scan exit 187
- initializing a user defined exit 41
- initializing an exit 41
- initializing the exit in the system 52
- initiator jobs 75
  - work selection exit 319
- input/output 133
- inserting initialization statements 187
- installation 3
  - control blocks 207
  - exits 3
  - work areas 209
- installation-defined exits 59
- integrating the exit routine 51
- interrogate CMB 147
- introduction
  - checkpoint control blocks 413
  - job-related exits
    - exit sequence 409
    - selected exits 410
  - job-related Exits 409
  - spool control blocks 412
- IOT 1
- isolating an exit error 55

## J

- JCL (job control language) 1
  - initializing an exit 41
- JCL/JES2 control statement scan exit 75, 107
- JCT 410
- JCT (job control table) 1
  - JCTIPTIO usage 192, 324
  - JCTJOBID usage 102
  - JCTJQE usage 133
  - JCTSAMSK usage (Exit 11) 151
  - JCTSAMSK usage (exit 12) 157
  - JCTXWRK usage 103
  - job control table 1
  - job exit mask address 55

- JCT (job control table) (*continued*)
  - read/write 133
  - selected fields 100, 346
- JCT read 210
  - exit 25 211
  - recovery 211
- JCT read/write exit 75
- JES 2 Print /Punch processor 428
- JES2 1
  - \$ESTAE macro usage 26
  - \$SCAN facility 80
  - address space 10
  - areas of modification 1
  - dispatching unit (PCE) 11
  - exit 1
  - exit effector 7
  - main task 8
  - modifying 1
  - primary load module (HASJES20) 8
  - processors 11
  - reentrant sense 11
  - source language (assembler) 7
  - subtasks execution 9
  - terminating 199
- JES2 command preprocessor exit 75, 117
- JES2 converter exit (JES2 main) 293
- JES2 data areas 43
- JES2 exits
  - exit 1 429
  - exit 11 409
  - exit 12 409
  - exit 14 427
  - exit 15 429
  - exit 16 427
  - exit 21 431
  - exit 28 426
  - exit 30 426
  - exit 31 426
  - exit 32 425
  - exit 33 426
  - exit 34 426
  - exit 35 426
  - exit 36 429, 431
  - exit 37 429, 431
  - exit 51 426
  - exit 7 427, 429, 430
  - exit 8 425, 426
  - exit 9 409
- JES2 Exits
  - exit 2 409
  - exit 6 409
  - exit 7 409
  - exit 8 409
- JES2 main
  - converter exit 293
- JES2 main task 8
- JES2 reentrancy 8
- JES2 subtask 9
- JES2 termination 199
- JES2-to-operator communication 2
- JMR 1
  - usage 104
- job 2
  - end of input exit 191
  - exit mask (JOBMASK) 55
  - input processing 2
  - priority 191, 323

- job (*continued*)
  - related exits (defined) 5
  - terminating processing 191, 323
- job control language (JCL) 41
- job control table
  - read write (USER) exit 137
- job control table field 102, 348
- job exit mask 56
- job input 191
  - end 191
  - processing 2
- job management record (JMR) 104
- job management record record, job management JMR
  - SMFTYPE field
    - meaning 198
    - values 198
- job output
  - processing 2
- job queue 163
  - finding work (exit 14) 163
  - work select exit 163
- job queue element 133
- job queue initiator jobs 75
- job queue work select exit 163, 319
- job separator page process 202
- job statement account field scan exit 75, 97, 344
- JOB statement accounting field scan 97
  - &RJOB OPT use 103
  - HASPRSCN replacement 99
  - JCTJOBID usage 102
  - JCTXWRK usage 103
  - recovery 100, 346
  - specific description 97, 344
- job statement scan exit 75
  - general description 66
- job termination 191, 323
- job-related exits 55
- JOBMASK parameter 55
- jobs
  - work selection exit 319
- JOE (job output element) 1
- JOT (job output table) 1
- JQE (job queue element) 1
  - acquiring control (exit 14) 163
  - acquiring control (exit 49) 319
  - JQETYPE usage 133

## K

- keyboard
  - navigation 433
  - PF keys 433
  - shortcut keys 433

## L

- linkage conventions 11
- linkage conventions to exits 11
- LMT 80
- LOAD initialization statement 80
- LOAD macro 80
  - \$HASP428 message 80
  - \$HASP864 message 82
  - LOAD macro 80

load module table (LMT) 80  
  usage (exit 0) 80  
loading an exit routine 41  
log data set 188  
logic of an exit 19  
logon/logoff  
  SNA exit 183

## M

Macro 80  
  \$CWTO 121  
  \$JCAN 200  
  \$STMTLOG 188  
  LOAD 80  
main task 5  
  protect key 5  
main task environment 8  
maximum return code 14  
MAXRC= operand (\$EXIT macro) 14  
message 65  
  \$HASP426 65, 79  
  \$HASP427 65, 79  
  \$HASP428 80  
  \$HASP864 82, 208  
  alter console routing 148  
  modify \$WTO messages (exit 16) 175  
methods of packaging the exit 30  
MIT 1  
MITETBL 1  
  illustration 52  
modification 1  
  areas in JES2 1  
modify  
  JES2 control blocks 207  
  modify \$WTO messages 175  
  modifying initialization statements 187  
  modifying output grouping keys 279  
  modifying SYSOUT characteristics  
    exit 275  
multiple exit routines 6, 12, 47  
  linkage conventions 12  
  single module (example) 47  
MVS 11  
  ESTAE macro usage 26  
  LOAD macro 80  
  reentrant sense 11  
  WTO macro 20  
  WTOR macro 20  
MVS WAITS 8

## N

naming the exit 23  
navigation  
  keyboard 433  
NJE data area  
  modifying before its  
    transmission 305  
  modifying before receiving the rest of  
    the NJE job 311  
NJE SYSOUT reception data set  
  disposition exit 271  
nonreentrant considerations for exits 11  
Notices 437  
notify exit 175

notify user message  
  modifying with an exit 283

## O

operating environment for exits 7  
operating states  
  altering (via \$T EXIT(nnn) ) 5  
  disabled 5  
  enabled 5  
operator 2  
  \$CWTO macro (exit 5) 121  
  \$D EXIT(nnn) command usage 57  
  \$T EXIT(nnn) command usage 57  
  command (\$T EXIT(nnn)) 26  
  communicating from the exit 20  
  communication with JES2 2  
operator-to-exit communication 20  
other programming considerations 23  
output  
  data set/copy separator exit 169  
  output data set/copy separators exit 169  
  output grouping keys  
    modifying selection with an exit 279  
  output processing 2

## P

packaging the exit 30, 51  
parameter  
  EXIT(nnn) 26  
  JOBMASK 55  
  received by exits 13  
passing control to exit routines 55  
PCE 1  
  PCEID usage 134  
  work area for HASPRDR 192, 324  
PCE attach/detach exit 217  
PCEs 427  
phases  
  conversion 421  
  execution  
    exits 424  
    overview 424  
  hardcopy  
    exits 428  
    overview 428  
  input  
    exits 419  
    overview 418  
  output  
    exits 427  
    overview 427  
  purge  
    exits 430  
    overview 430  
  spin  
    exits 427  
    overview 427  
placement of exits 54  
post initialization exit 205, 207  
post-security authorization call exit 261  
pre-initialization 79  
  \$HASP426 message 79  
  \$HASP428 message 80  
  \$HASP864 message 82

pre-initialization (*continued*)  
  LOAD macro 80  
  specific description 79  
pre-initialization exit 75  
  \$HASP426 message 65  
  \$HASP427 message 65  
  general description 65  
pre-security authorization call exit 255  
pre-SFJ service request exit 299  
print/punch 82  
  \$SEPPDIR usage 85  
  specific description 82  
print/punch job separator exit 82  
  general description 65  
print/punch separator exit 75  
priority 191, 323  
processing 55  
  disabled exits 55  
  enabled exits 55  
  job-related exits 55  
processor control element 134  
programming considerations 12  
  \$ENTRY macro 23  
  addressability of the exit 23  
  exit initialization 52  
  exit logic 19  
  exit-to-operator communication 20  
  integrating the exit routine 51  
  multiple exit routines 12  
  naming the exit 23  
  other ones for exits 23  
  packaging the exit 30, 51  
  passing control to exit routines 55  
  recovery for exits 26  
  security 23  
  service routine usage 19  
  source module conventions 23  
  testing exit routines 51  
  tracing status of exits 57  
  tracing the exit 26

## Q

queue SMF records 197

## R

received parameters for exits 13  
recovery 219, 221  
Recovery 225  
  exit 29 225  
  exit 30 229  
  exit 31 233  
  exit 32 237  
  exit 33 243  
  exit 34 247  
  exit 35 251  
  exit 36 255  
  exit 37 261  
  exit 38 267  
  exit 42 283  
  exit 58 381  
recovery for exits 26  
reentrant  
  JES2 sense 11  
  MVS sense 11

- reentrant considerations for exits 11
- register
  - linkage information for exits 11
- remote attribute table (RAT) 180
  - usage (exit 17) 180
  - usage (exit 18) 184
- remote job entry (RJE) 2
  - BSC signon/signoff exit 179
  - processing 2
  - SNA logon/logoff exit 183
- replacing initialization statements 187
- response byte
  - exit routine-to-exit point communication 20
- restore caller's registers 12
  - \$RETURN macro 12
- return codes from exits 14
- routine 19
  - \$QGET (exit 14) 163
  - \$QGET (exit 49) 319
  - used by exits 19

**S**

- Sample exit routines 45
- save caller's registers 12
  - \$SAVE macro 12
- scan
  - accounting field 97, 344
  - Converter/Interpreter text (exit 59) 385
  - Converter/Interpreter text (exit 6) 125
  - Converter/Interpreter text (exit 60) 389
  - initialization statement exit 187
  - JCL/JES2 control statements 107
- security 23
- security considerations 23
- selecting an exit 65
- selection of initiator jobs 75
- sending comments to IBM xxi
- separator pages
  - copies 169
  - data sets 169
- service request exit 299
- service routine usage 19
- service routines 19
  - usage 19
- services for synchronizing 10
  - main task
    - \$WAIT macro 10
- shortcut keys 433
- signon/signoff
  - BSC exit 179
- single module for multiple exit routines 47
- SMF 1
  - control block creation/alteration 197
  - queuing records 197
  - record exit 197
- SMF exits 409
- SMF record exit 195
- SMFWTM macro 431
- SNA RJE devices, controlling 183
- SNA RJE logon/logoff exit 183
- source module conventions 23

- specific description 117, 137, 147, 151, 163, 169, 175, 179, 183, 191, 195, 198, 202
  - \$CWTO macro 121
  - \$GETSMFB usage 197
  - \$HASP864 208
  - \$JCAN macro 200
  - \$QUESMFB usage 197
  - \$STRAKX exit point 158
  - \$T EXIT command usage 208
  - \$TRACKX exit point 152
  - \$USER1 through \$USER5 209
  - CCW translate table usage 169
  - change notify routine 175
  - CMB usage 175
  - CMBFLAG usage 148
  - CMBJOB usage 148
  - CMBROUT usage 148
  - CMBTEXT usage 148
  - COMAUTH structure 120
  - EXITnnn statement 208
  - finding job queue work 163
  - IKJ562161 message 200
  - JCTIPTIO usage 192, 324
  - JCTSAMSK usage 151, 157
  - MICEXIT exit point 184
  - modify \$WTO messages 175
  - MSNALXIT exit point 183
  - MSNALXT2 exit point 184
  - PCE work area usage 192, 324
  - PRTRANS table 169
  - recovery 119, 207, 211
  - specific description 205, 207, 210
- specific uses of exits 65
- spool 2
  - partitioning allocation (\$STRAK) 157
  - partitioning allocation (\$STRAK) exit 157
  - partitioning mask (JCTSAMSK) 151
  - processing 2
- spool control blocks 412
- spool partitioning allocation (\$STRAK) exit 157
- spool partitioning allocation exit (\$TRACK) 151
- SSI data set allocation exit 233
- SSI data set CLOSE exit 243
- SSI data set OPEN and restart exit 229
- SSI data set unallocation exit 247
- SSI end-of-memory exit (JES2) 223
- SSI end-of-memory JES2 exit 223
- SSI end-of-step exit 381
- SSI end-of-task exit 251
- SSI job selection exit 237
- SSI job termination exit (JES2) 220
- SSI job termination JES2 exit 220
- SSI SYSOUT data set unallocation exit 315
- status
  - changing exit status 55
  - exit 198
  - exit status 55
  - tracing exit status 57
- subtask 5
  - protect key 5
- subtask environment 9

- summary of changes xxiii
- Summary of changes xxiv
- synchronization services 10
  - for exits 10
- SYSOUT characteristics
  - exit to change 275
- system affinity 191, 323
- system initializing for exits 52
- system management facilities (SMF)
  - record exit 195

## T

- tables 169
  - CCW translate table (exit 15) 169
  - exit implementation table 75
  - exit selection table 65
  - PRTRANS table (exit 15) 169
- tailoring initialization statements 187
- termination exit 213, 215
- termination JES2 exit 213
- testing 26
  - exit routines 51
  - tracing usage 26
  - TYPE=TEST (\$EXIT macro) 59
- TGB 1
- titles of exits 65
- tracing 26
  - \$D EXIT(nnn) command usage 57
  - \$T EXIT(nnn) command usage 57
  - automatic tracing 60
  - automatically 26
  - AUTOTR= (\$EXIT macro) 60
  - disabled (exit 19) 188
  - enabling trace (ID 13) 26, 57
  - exit effectors 60
  - exit status 57
  - exits 26
  - job-related tracing 57
  - necessary conditions 26
  - TRACE= usage on EXIT(nnn) 57
- Tracing status 57
- tracing status of exits 57
- trademarks 439
- transaction program (TP)
  - selection/change/termination exit 289
- TSO/E CANCEL/STATUS (exit 22) 199
- TSO/E receive data set disposition exit 267

## U

- use of exit facility 3
- user address 5
  - protect key 5
- user address space environment 7
- User Control Table 209
  - usage 209
- USER environment 9
- User environment exits
  - storage 25
- user interface
  - ISPF 433
  - TSO/E 433
- using control blocks in exits 14

using service routines in exits 19

## V

verify a job's existence 102

## W

weak external names 52

WLM initiator jobs

work selection exit 319

work

select exit 163

work area 103

\$USER1 through \$USER5) 209

CNVWORK 128, 392

HASPRDR PCE 192, 324

JCTXWRK (exit 3) 103

workload selection 75

writing an exit routine 7

## X

XIT 1

XRT 1









Product Number: 5650-ZOS

Printed in USA

SA32-0995-02

