

z/OS



# Common Information Model User's Guide

*Version 2 Release 1*

**Note**

Before using this information and the product it supports, be sure to read the general information under “Notices” on page 369.

This edition applies to Version 2 Release 1 of z/OS (5650-ZOS) and to all subsequent releases and modifications until otherwise indicated in new editions.

This edition replaces SC34-2671-08.

© **Copyright IBM Corporation 2005,2013.**

US Government Users Restricted Rights – Use, duplication or disclosure restricted by GSA ADP Schedule Contract with IBM Corp.

---

# Contents

<b>Figures</b> . . . . .	<b>vii</b>
--------------------------	------------

<b>Tables</b> . . . . .	<b>ix</b>
-------------------------	-----------

<b>About this publication</b> . . . . .	<b>xi</b>
---	-----------

Who should use this document . . . . .	xi
--	----

<b>How to send your comments to IBM</b>	<b>xiii</b>
---	-------------

If you have a technical problem . . . . .	xiii
---	------

<b>Summary of changes</b> . . . . .	<b>xv</b>
-------------------------------------	-----------

What's new in z/OS V2R1 . . . . .	xv
-----------------------------------	----

Port decommissioning . . . . .	xv
--------------------------------	----

Enhanced MODIFY console command . . . . .	xv
---	----

New and changed z/OS-specific messages . . . . .	xv
--	----

---

## Part 1. Introduction and concepts . . . 1

<b>Chapter 1. Introduction</b> . . . . .	<b>3</b>
--	----------

<b>Chapter 2. CIM indication concept</b> . . . . .	<b>7</b>
--	----------

Indication delivery retry . . . . .	8
-------------------------------------	---

How indications work . . . . .	8
--------------------------------	---

<b>Chapter 3. z/OS CIM security concept</b>	<b>11</b>
---	-----------

---

## Part 2. Installation and setup . . . . 15

<b>Chapter 4. Installation</b> . . . . .	<b>17</b>
--	-----------

Migration from z/OS 1.12 or z/OS 1.13 to z/OS 2.1	18
---	----

Fallback from z/OS 2.1 to z/OS 1.12 or z/OS 1.13	18
--	----

<b>Chapter 5. Quick guide: CIM server setup and verification</b> . . . . .	<b>19</b>
--	-----------

Step 1: Setting up the security for the CIM server	19
--	----

Quick security setup for RACF . . . . .	19
---	----

Security setup for a production environment . . . . .	20
---	----

Step 2: Customizing the file systems and directories	20
--	----

Step 3: Using default TCP/IP ports 5988 and 5989	21
--	----

Step 4: Starting the CIM server . . . . .	21
---	----

Step 5: Customizing the UNIX System Services shell	21
--	----

Step 6: Running the installation verification program (IVP) . . . . .	22
---	----

<b>Chapter 6. CIM server security setup</b>	<b>23</b>
---	-----------

Defining a RACF class and profile for the CIM server . . . . .	24
--	----

Defining a CIM server user ID . . . . .	25
---	----

Configuring the CIM server's resource authorization model . . . . .	25
---	----

Enabling the must-stay-clean feature . . . . .	26
--	----

Setting up program control . . . . .	27
--------------------------------------	----

Granting clients and administrators access to the CIM server . . . . .	28
--	----

Switching identity (surrogate) . . . . .	29
--	----

Configuring the CIM server HTTPS connection using AT-TLS . . . . .	29
--	----

Example: Configuring AT-TLS for secure communication . . . . .	30
--	----

Defining the CFZAPPL profile for the APPL class . . . . .	35
---	----

Defining an encryption key for PassTicket validation . . . . .	35
--	----

Setting up multilevel security (MLS) support . . . . .	35
--	----

Considering Automatic Restart Manager security . . . . .	36
--	----

<b>Chapter 7. CIM provider setup and security</b> . . . . .	<b>37</b>
---	-----------

Setting up the CIM server for RMF monitoring . . . . .	37
--	----

Setting up the CIM server for network providers . . . . .	38
---	----

Setting up the CIM server for Cluster, CoupleDataset, and JES2-JES3Jobs providers . . . . .	38
---	----

PARMLIB updates . . . . .	38
---------------------------	----

RACF setup . . . . .	39
----------------------	----

Sysplex couple dataset formatting . . . . .	39
---	----

Setting up the CIM server for WLM management . . . . .	40
--	----

Setting up the CIM server for storage management . . . . .	41
--	----

Running providers in a designated user context . . . . .	42
--	----

Utilizing the provider based authorization model . . . . .	43
--	----

<b>Chapter 8. Customization</b> . . . . .	<b>45</b>
---	-----------

Configuring the ports for the CIM server . . . . .	45
--	----

Customizing CFZRCUST . . . . .	46
--------------------------------	----

Prerequisites . . . . .	46
-------------------------	----

Option 1: Placing /var/wbem in a separate file system . . . . .	46
---	----

Option 2: Using an existing file system for /var/wbem . . . . .	48
---	----

System specific directories . . . . .	48
---------------------------------------	----

Considerations for customizing CIM Server in a z/OS Sysplex . . . . .	49
---	----

Customizing the CIM server startup . . . . .	50
--	----

Customizing the started task procedure CFZCIM . . . . .	50
---	----

Customizing the UNIX System Services shell . . . . .	51
--	----

Setting the CIM server environment variables . . . . .	51
--	----

Selecting a WLM service class for z/OS CIM priority . . . . .	54
---	----

<b>Chapter 9. CIM server configuration</b> . . . . .	<b>55</b>
--	-----------

<b>Chapter 10. Setup verification</b> . . . . .	<b>61</b>
---	-----------

---

## Part 3. Administration and operation . . . . . 63

<b>Chapter 11. CIM server administration</b>	<b>65</b>
--	-----------

Starting and stopping the CIM server . . . . .	65
--	----

Running the CIM server as started task . . . . .	65
Running the CIM server from the UNIX System Services command prompt . . . . .	66
Running providers in separate address spaces . . . . .	66
Changing current configuration properties . . . . .	67
Changing planned configuration properties . . . . .	67
Tracing . . . . .	68
Logging . . . . .	71
Using the syslog daemon for CIM server logging . . . . .	72
Audit logging with SMF record 86. . . . .	73
Backing up the CIM server configuration . . . . .	74
Automatically restarting the CIM server . . . . .	74
ARM policy considerations . . . . .	75
Backing up the CIM server repository . . . . .	77

## Chapter 12. CIM server command-line utilities and console commands . . . . . 79

cimmo . . . . .	81
Purpose . . . . .	81
Syntax . . . . .	81
Options. . . . .	81
Examples . . . . .	82
cimconfig . . . . .	83
Purpose . . . . .	83
Syntax . . . . .	83
Options. . . . .	83
Examples . . . . .	84
cimprovider . . . . .	85
Purpose . . . . .	85
Syntax . . . . .	85
Options. . . . .	85
Limitations . . . . .	86
Examples . . . . .	86
cimcli . . . . .	88
Purpose . . . . .	88
Syntax . . . . .	88
Options. . . . .	88
cimcli a (associators) . . . . .	89
cimcli an (associatorNames) . . . . .	90
cimcli ci (createInstance) . . . . .	91
cimcli dc (deleteClass) . . . . .	92
cimcli di (deleteInstance) . . . . .	93
cimcli dq (deleteQualifier) . . . . .	94
cimcli ec (enumerateClasses) . . . . .	95
cimcli ei (enumerateInstances) . . . . .	96
cimcli eq (enumerateQualifiers) . . . . .	97
cimcli gc (getClass) . . . . .	98
cimcli gi (getInstance) . . . . .	99
cimcli gq (getQualifier) . . . . .	100
cimcli im (invokeMethod) . . . . .	101
cimcli mi (modifyInstance) . . . . .	102
cimcli nc (enumerateClassNames) . . . . .	103
cimcli ni (enumerateInstanceNames) . . . . .	104
cimcli ns (enumerateNamespaces) . . . . .	105
cimcli r (references) . . . . .	106
cimcli rn (referenceNames) . . . . .	107
cimcli sp (setProperty) . . . . .	108
cimcli ti (testInstance) . . . . .	109
cimcli xq (execQuery) . . . . .	110
cimcli <i>Options</i> . . . . .	111
cimcli <i>Instance name</i> . . . . .	113

cimsub . . . . .	114
Purpose . . . . .	114
Syntax . . . . .	114
Options . . . . .	115
Examples . . . . .	116
MODIFY console command. . . . .	117
Syntax . . . . .	117
Options . . . . .	117
Examples . . . . .	118

## Part 4. Provider reference . . . . . 119

### Chapter 13. Profiles. . . . . 121

SMI-S profiles . . . . .	121
Host Discovered Resources profile . . . . .	121
SB Multipath Management profile . . . . .	122
Storage HBA profile . . . . .	123

### Chapter 14. z/OS Management Instrumentation for CIM . . . . . 125

Supported CIM operations . . . . .	129
OS management Base classes . . . . .	130
CIM_ComputerSystem . . . . .	131
CIM_OperatingSystem . . . . .	131
CIM_OSProcess . . . . .	131
CIM_Process . . . . .	132
CIM_RunningOS . . . . .	132
IBMzOS_ComputerSystem . . . . .	133
IBMzOS_OperatingSystem . . . . .	135
IBMzOS_OSProcess . . . . .	137
IBMzOS_Process . . . . .	138
IBMzOS_RunningOS . . . . .	140
IBMzOS_UnixProcess. . . . .	141
OS management BaseBoard classes . . . . .	143
IBM_BaseBoard. . . . .	144
IBMzOS_BaseBoard . . . . .	145
Association CIM_ComputerSystemPackage . . . . .	146
Association IBMzOS_CSBaseBoard . . . . .	146
OS management Processor classes . . . . .	147
CIM_Processor . . . . .	148
Association CIM_SystemDevice . . . . .	148
IBMzOS_Processor . . . . .	149
OS management Logical Disk classes . . . . .	151
CIM_LogicalDisk . . . . .	152
IBMzOS_LogicalDisk . . . . .	153
OS management File System classes . . . . .	155
CIM_LocalFileSystem. . . . .	156
CIM_RemoteFileSystem . . . . .	156
Association CIM_HostedFileSystem . . . . .	156
IBMzOS_UnixLocalFileSystem. . . . .	157
IBMzOS_NFS . . . . .	159
OS management Network classes. . . . .	160
CIM_EthernetPort . . . . .	162
CIM_IPProtocolEndpoint . . . . .	162
CIM_PortImplementsEndpoint . . . . .	162
Association CIM_SystemDevice . . . . .	162
IBMzOS_EthernetPort . . . . .	163
IBMzOS_IPProtocolEndpoint . . . . .	165
OS management Job classes . . . . .	167
IBMzOS_JES2Job . . . . .	168

IBMzOS_JES3Job . . . . .	179
IBMzOS_JES2SysoutDataset . . . . .	188
IBMzOS_JES3SysoutDataset . . . . .	192
IBMzOS_Job . . . . .	193
IBMzOS_JobsManagementSettings . . . . .	194
IBMzOS_Subsystem . . . . .	195
IBMzOS_SysoutDataset . . . . .	197
Association IBMzOS_SubsystemJES2Jobs . . . . .	198
Association IBMzOS_SubsystemJES3Jobs . . . . .	198
Association IBMzOS_UsesJES2SysoutDatasets . . . . .	198
Association IBMzOS_UsesJES3SysoutDatasets . . . . .	198
OS management Cluster classes . . . . .	200
IBMzOS_CFRMCoupleDataset . . . . .	201
IBMzOS_CFRMPolicy . . . . .	203
IBMzOS_CFStructure . . . . .	205
IBMzOS_CFStructureConnector . . . . .	214
IBMzOS_CoupleDataset . . . . .	217
IBMzOS_CouplingFacility . . . . .	221
IBMzOS_CouplingFunction . . . . .	225
IBMzOS_SFMAAttributes . . . . .	229
IBMzOS_Sysplex . . . . .	230
IBMzOS_SysplexCoupleDataset . . . . .	233
IBMzOS_SysplexNode . . . . .	234
Association IBMzOS_CFStrDependsOn . . . . .	237
Association IBMzOS_CollectionOfCFs . . . . .	237
Association IBMzOS_CollectionOfSysplexNodes . . . . .	237
Association IBMzOS_HostedCFStructure . . . . .	238
Association IBMzOS_HostedCFStrConnector . . . . .	238
Association IBMzOS_UsesCFs . . . . .	239
Association IBMzOS_UsesCFRMCoupleDatasets . . . . .	239
Association IBMzOS_UsesCFRMPolicies . . . . .	240
Association IBMzOS_UsesCouplingFunctions . . . . .	240
Association IBMzOS_UsesSysplexCoupleDatasets . . . . .	240
Storage management classes . . . . .	241
CIM_FCPort . . . . .	241
CIM_FCPortStatistics . . . . .	241
CIM_PortController . . . . .	241
CIM_Product . . . . .	241
CIM_ProtocolEndpoint . . . . .	241
CIM_SoftwareIdentity . . . . .	241
CIM_StorageExtent . . . . .	241
Association CIM_ControlledBy . . . . .	242
Association CIM_DeviceSAPIImplementation . . . . .	242
Association CIM_ElementSoftwareIdentity . . . . .	242
Association CIM_ElementStatisticalData . . . . .	242
Association CIM_HostedAccessPoint . . . . .	242
Association CIM_InitiatorTargetLogicalUnitPath . . . . .	242
Association CIM_InstalledSoftwareIdentity . . . . .	242
Association CIM_ProductElementComponent . . . . .	243
Association CIM_SystemDevice . . . . .	243
IBMzOS_FCCUPort . . . . .	244
IBMzOS_FCPort . . . . .	249
IBMzOS_FCPortStatistics . . . . .	255
IBMzOS_FCSBPort . . . . .	257
IBMzOS_PortController . . . . .	258
IBMzOS_Product . . . . .	260
IBMzOS_SBPProtocolEndpoint . . . . .	261
IBMzOS_SoftwareIdentity . . . . .	263
Association IBMzOS_ControlledBy . . . . .	266
Association IBMzOS_CSFCPort . . . . .	267

Association IBMzOS_CSFCPortController . . . . .	268
Association IBMzOS_ElementSoftwareIdentity . . . . .	269
Association IBMzOS_FCPortStatisticalData . . . . .	270
Association IBMzOS_InstalledSoftwareIdentity . . . . .	271
Association IBMzOS_ProductElementComponent . . . . .	272
Association IBMzOS_SBDeviceSAPIImplementation . . . . .	273
Association IBMzOS_SBHHostedAccessPoint . . . . .	274
Association IBMzOS_SBInitiatorTargetLogicalUnitPath . . . . .	275

## Chapter 15. WLM classes . . . . . 277

IBMzOS_WLM . . . . .	278
Association IBMzOS_WLMOS . . . . .	283

## Part 5. Developer's guide . . . . . 285

### Chapter 16. CMPI provider development for z/OS . . . . . 287

Obtaining the required header files . . . . .	288
Following general aspects of developing a provider . . . . .	289
Preparing provider initialization and function signatures . . . . .	290
Instance provider functions . . . . .	290
Method provider functions . . . . .	291
Association provider functions . . . . .	291
Indication provider functions . . . . .	291
Planning provider security . . . . .	291
Converting data to ASCII, EBCDIC and UTF-8 . . . . .	292
Provider installation . . . . .	292
Installing providers and dependent load modules . . . . .	293
Customizing the CIM server environment for third-party providers . . . . .	293
Registering a provider with the CIM server . . . . .	293
PG_Provider . . . . .	296
PG_ProviderModule . . . . .	297
PG_ProviderCapabilities . . . . .	299
Using the out-of-process support for providers . . . . .	301
Samples . . . . .	301

### Chapter 17. CIM indications . . . . . 303

CIM indication class hierarchy . . . . .	304
CIM_ProcessIndication . . . . .	304
CIM_InstIndication (Lifecycle Event) . . . . .	305
CIM_InstModification . . . . .	305
CIM subscription mechanism . . . . .	305
CIM_IndicationFilter . . . . .	306
CIM_ListenerDestinationCIMXML . . . . .	306
CIM_IndicationSubscription . . . . .	307

## Part 6. Messages . . . . . 309

### Chapter 18. z/OS specific messages 311

CEZ-prefix messages . . . . .	311
CFZ-prefix messages . . . . .	317

**Appendix A. Troubleshooting . . . . . 337**

- Garbage on the screen . . . . . 337
- Typical error scenarios . . . . . 337

**Appendix B. Step-by-step explanation of the CFZSEC job . . . . . 341**

- Step BASICSUP . . . . . 341
- Step CRUSR . . . . . 342
- Step CRWBEM . . . . . 343
- Step PEUSR . . . . . 344
- Step PEAPPL . . . . . 345
- Step SETARM . . . . . 345
- Step ENSTC . . . . . 346
- Step PECEA . . . . . 347
- Step ENCLCDS . . . . . 348
- Step ENSMIS . . . . . 349
- Step ENTCPIP . . . . . 350
- Step ENWLM . . . . . 350
- Step ENRMF . . . . . 351

**Appendix C. CEA reason codes . . . . . 353**

**Related links. . . . . 357**

**Legend for graphics showing class structures . . . . . 359**

**How to read syntax diagrams . . . . . 361**

- Symbols . . . . . 361
- Syntax items. . . . . 361

Syntax examples . . . . . 362

**Accessibility. . . . . 365**

- Using assistive technologies . . . . . 365
- Keyboard navigation of the user interface . . . . . 365

**Dotted decimal syntax diagrams . . . . . 367**

**Notices . . . . . 369**

- Programming Interface Information . . . . . 370
- Trademarks . . . . . 370
- Terms and conditions for downloading and printing publications . . . . . 371

**Index . . . . . 373**

---

## Figures

1. Sample network environment managed with CIM management applications . . . . .	3
2. Exemplary components of the CIM server in a z/OS environment . . . . .	5
3. CIM indication flow and processing. . . . .	8
4. Security components . . . . .	12
5. Host Discovered Resources Instance Diagram	122
6. HBA instance diagram . . . . .	123
7. CIM Base classes extended by z/OS-specific classes (1). . . . .	130
8. OS management BaseBoard Class. . . . .	143
9. OS management Processor classes. . . . .	147
10. CIM Base classes extended by z/OS-specific classes (2). . . . .	152
11. OS management File System classes . . . . .	155
12. OS management Network classes . . . . .	161
13. WLM classes. . . . .	277
14. WLM indications . . . . .	278
15. CMPI provider interfaces . . . . .	287
16. OpenPegasus CVS Repository . . . . .	289
17. CIM classes from the provider registration schema . . . . .	294
18. z/OS CIM indication hierarchy . . . . .	304
19. Indication subscription class diagram	305
20. Indication Handler. . . . .	307





---

## Tables

1. Default SMP/E installation directories for z/OS CIM . . . . .	17	6. Log and syslog levels . . . . .	72
2. Access types required for CIM operations	28	7. UCB control block information. . . . .	154
3. Sample sysplex couple dataset formatting JCL	40	8. Jobs providers' reason codes . . . . .	353
4. Installation directories for z/OS CIM . . . . .	48	9. UML syntax . . . . .	359
5. CIM server configuration properties . . . . .	55	10. Syntax examples . . . . .	362



---

## About this publication

This document describes the implementation of the Common Information Model (CIM) and Web Based Enterprise Management (WBEM) standards for z/OS. It explains how to set up and use the CIM server and CIM resource instrumentation provided together with the z/OS operating system. CIM is a standard data model for describing and accessing systems management data in heterogeneous environments. It allows system administrators and vendors to write applications that monitor and manage system resources in a network with different operating systems and hardware.

The focus of this document is on the z/OS-specific implementation of CIM. For more detailed information about the CIM and WBEM standards please review the information provided by the Distributed Management Task Force (DMTF), which is found in the internet on the *DMTF website*.

This document describes how to set up security using Resource Access Control Facility (RACF<sup>®</sup>) as security product. However, you can use any other suitable security product for this purpose.

Explicit link addresses are listed in "Related links" on page 357.

---

## Who should use this document

This document is intended for all users of the z/OS Common Information Model (CIM). It covers all z/OS specific aspects of CIM including installation, configuration and setup, application development, and problem diagnosis.



---

## How to send your comments to IBM

We appreciate your input on this publication. Feel free to comment on the clarity, accuracy, and completeness of the information or give us any other feedback that you might have.

Use one of the following methods to send us your comments:

1. Send an email to [mhvrcfs@us.ibm.com](mailto:mhvrcfs@us.ibm.com)
2. Visit the Contact z/OS web page at <http://www.ibm.com/systems/z/os/zos/webqs.html>
3. Mail the comments to the following address:  
IBM Corporation  
Attention: MHVRCFS Reader Comments  
Department H6MA, Building 707  
2455 South Road  
Poughkeepsie, NY 12601-5400  
U.S.A.
4. Fax the comments to us as follows:  
From the United States and Canada: 1+845+432-9405  
From all other countries: Your international access code +1+845+432-9405

Include the following information:

- Your name and address
- Your email address
- Your telephone or fax number
- The publication title and order number:  
z/OS V2R1 Common Information Model User's Guide  
SC34-2671-00
- The topic and page number related to your comment
- The text of your comment.

When you send comments to IBM, you grant IBM a nonexclusive right to use or distribute your comments in any way it believes appropriate without incurring any obligation to you.

IBM or any other organizations will only use the personal information that you supply to contact you about the issues that you submit.

---

## If you have a technical problem

Do not use the feedback methods listed above. Instead, do one of the following:

- Contact your IBM service representative
- Call IBM technical support
- Visit the IBM support portal at <http://www.ibm.com/systems/z/support/>



---

## Summary of changes

See the following publications for specific enhancements for z/OS Version 2 Release 1:

- *z/OS Summary of Message and Interface Changes*, SA23-2300
- *z/OS Introduction and Release Guide*, GA32-0887
- *z/OS Planning for Installation*, GA32-0890
- *z/OS Migration*, GA32-0889

---

## What's new in z/OS V2R1

### Port decommissioning

Port decommissioning allows users to safely deactivate (or decommission) a FICON port or a logical control unit port. It assures that any users of those ports are first given the opportunity to cease using them. If a user is unable to stop using a port, this port is not deactivated. This functionality may eliminate outages caused by shutting down ports that are in use.

### Enhanced MODIFY console command

The MODIFY console command has been enhanced to display the values of the environment variables that are currently defined for the CIM server address space.

### New and changed z/OS-specific messages

The following z/OS-specific messages have been added or changed:

1. CEZ03031E
2. CEZ10001E
3. CFZ06213I
4. CFZ06214I
5. CFZ06215E
6. CFZ12531E





---

## **Part 1. Introduction and concepts**



# Chapter 1. Introduction

The Common Information Model (CIM) is a standard data model developed by a consortium of major hardware and software vendors (including IBM®) called the Distributed Management Task Force (DMTF) as part of the Web Based Enterprise Management (WBEM) initiative. WBEM includes a set of standards and technologies that provide management solutions for a distributed network environment. Interoperability is a major focus of WBEM, and using WBEM technologies can help you develop a single set of management applications for a diverse set of resources and systems.

Figure 1 shows a sample environment in which management applications can run that use the DMTF CIM standard data model.

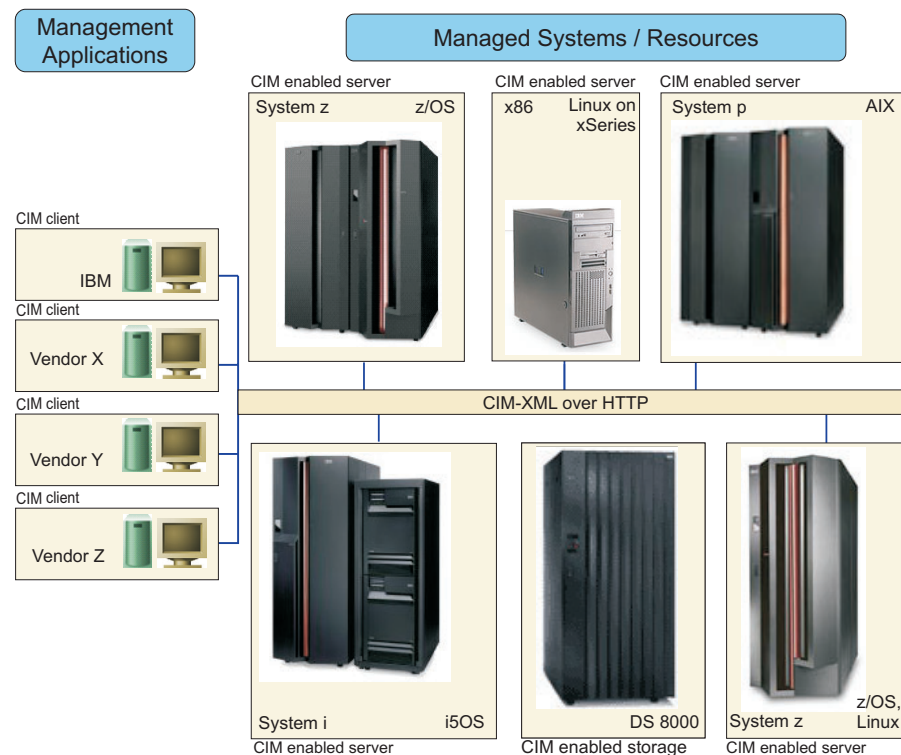

Figure 1. Sample network environment managed with CIM management applications

CIM is a major component of the WBEM initiative, providing a model for describing and accessing data across an enterprise. CIM consists of both a specification and a schema. The specification defines the details for integration with other management models, while the schema provides the actual model descriptions.

CIM supports the concept of indications as described in Chapter 2, “CIM indication concept,” on page 7.

With support for the CIM server on systems running z/OS, users have the ability to access z/OS resources through an extendible industry standard model. This document contains information about how to use the CIM server for z/OS for this

purpose.

CIM for z/OS includes:

### **CIM server**

The open source implementation of the CIM server manages the communication between clients and providers. The CIM server also provides several management functions, including security, and a set of commands that provide configuration and management functions to administrators.

The CIM server implementation on z/OS is based on the OpenPegasus CIM server from The Open Group. See the OpenPegasus website for more information.

### **CIM operations over HTTP**

The "CIM over HTTP" protocol is an implementation of the standardized formats for communication between clients and the CIM server *Representation of CIM in XML (DSP0201)* and *CIM Operations over HTTP (DSP0200)*. The CIM server for z/OS supports most of the CIM operations defined in the CIM Operations over HTTP specification by the DMTF.

For more information about these standards, see the WBEM website.

### **Web Services for Management**

Starting with z/OS 1.13, the CIM server for z/OS supports the WS-Transfer, WS-Enumeration and WS-Eventing operations defined in the WS-CIM Mapping specification. Web Services for Management (DSP0226) is a general SOAP-based protocol for managing systems. The WS-CIM Mapping specification (DSP0230) describes how to use the Web Services for Management (WS-Management) protocol to communicate with resources modeled with CIM and exposed through the XML schema mapping described by the WS-Management CIM Binding Specification (DSP0227).

### **DMTF CIM Schema**

A CIM Schema defines an information model for representing systems management functions. For z/OS 2.1, CIM Schema version 2.25 is supported by the CIM server.

### **Instrumentation for server resources**

Instrumentation for server resources on the system are called **providers**. The providers, which are based on a subset of the standardized CIM classes, gather data on a system. CIM clients can work with this data by accessing the providers through the CIM server. For more information about what is supported in z/OS, refer to Chapter 14, "z/OS Management Instrumentation for CIM," on page 125.

### **CIM client for Java™**

z/OS CIM includes the CIM client for Java library from the SBLIM project. With z/OS 2.1, version 2.1 of the CIM client for Java is included. The CIM client for Java is a programming API that enables z/OS applications written in Java for local and remote access of CIM instrumentation through the CIM over HTTP access protocol. It consists of a Java library and associated online Java documentation.

**Note:** Version 1 of the CIM client for Java (SBLIM CIM client) will be removed in a future release of z/OS.

Figure 2 illustrates how the CIM server works in the z/OS environment: A CIM client application requests the CIM server to return information about z/OS resources, in this case about basic operating system (OS) data as well as monitoring metrics, in this example RMF™ metrics. The CIM server invokes the according CIM providers which retrieve the requested data associated to z/OS system resources. The z/OS RMF monitoring provider invokes the RMF Distributed Data Server (DDS) which in turn collects RMF Monitor III performance data. The CIM server consolidates the data from the providers and returns them back to the calling client through the CIM over HTTP protocol.

Figure 2 shows two types of CIM providers: RMF monitoring providers that use the RMF DDS to access the z/OS system, and z/OS operating system management providers that access the z/OS system data directly.

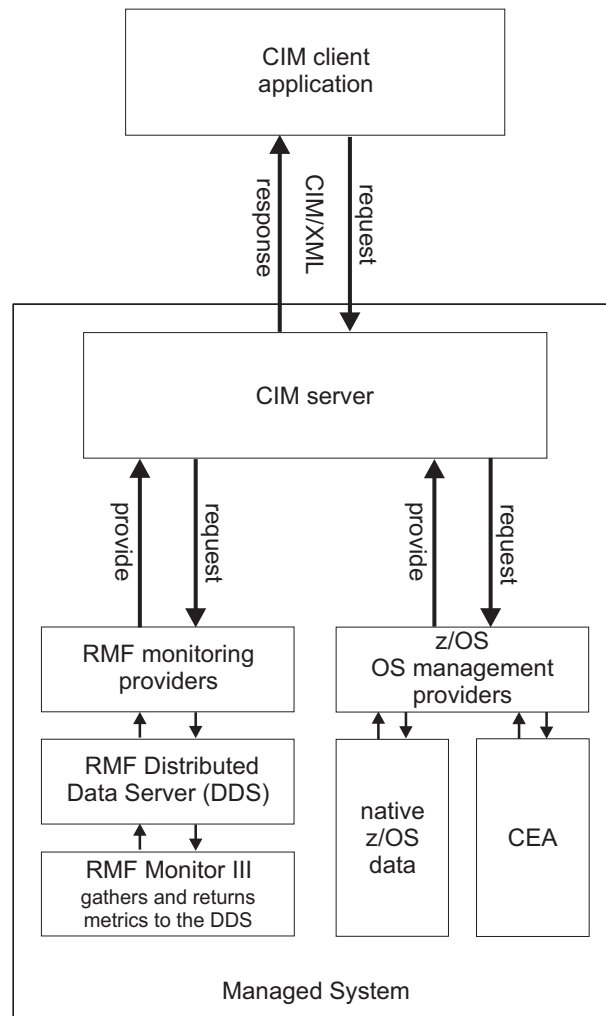

Figure 2. Exemplary components of the CIM server in a z/OS environment

**Important Note:**

Each IBM eServer™ operating system is supporting a specific open source implementation of a CIM server. The "eServer Common Information Model" document contains overall information about how to use CIM for systems management on IBM eServers. Users of CIM for z/OS need to know this information. The present z/OS Common Information Model User's Guide contains the z/OS-specific supplements and deviations from the common eServer CIM and from OpenPegasus.

---

## Chapter 2. CIM indication concept

**Copyright attribution:**

The introduction to CIM indications provided in this section is based on the information in the CIM Event Model White Paper, DSP0107, Document Version 2.1 June 10, 2003, provided by the Distributed Management Task Force (DMTF).

In CIM terminology, an indication is the representation of the occurrence of an event. For example, an event can be the unexpected termination of a program, or the modification of a property value of a CIM instance. There is not necessarily a one-to-one correspondence between events and indications. In particular, multiple indications can be generated for the same underlying event if multiple CIM client applications had subscribed for the event. An event can also occur without causing a related indication to be raised, for example if no subscription was made for the event.

z/OS supports additional indications for the CIM infrastructure. As an example, the Storage Management CIM providers can generate indications for the state change of channel paths, this way enabling CIM clients to support event-based monitoring to avoid polling the CIM server. A CIM client can subscribe for conditions, for example when a channel path goes offline. While the subscription is active, an according CIM indication provider monitors the resource(s) and notifies the CIM client whenever the condition becomes true.

The CIM indication support comprises the following steps:

- Defining an indication filter condition: This describes the event that you might want to be notified about, that is, when to send an indication
- Defining an indication listener: This describes how and where to send an indication
- Activating the subscription by associating a filter with a listener
- Consuming the indication once it is raised: The indication is sent to the indication listener, which decides how to react to the event

The CIM Event Model defines the CIM classes used for indication support. It defines the CIM indication class hierarchy that is used to model various types of events, and the CIM subscription mechanism.

Further readings:

- CIM Event Model White Paper, DSP0107, Document Version 2.1 June 10,2003, provided by the Distributed Management Task Force (DMTF), describes the CIM Event Model.
- Specification for CIM Operations over HTTP describes how the CIM server transmits CIM indications to the CIM listener.
- DMTF Indications Profile DSP1054 1.1 describes the behavior of CIM indication delivery.
- Chapter 17, "CIM indications," on page 303 describes CIM indication classes and the CIM subscription mechanism.

## Indication delivery retry

To improve the reliability of indication delivery, DMTF Indications Profile DSP1054 1.1 introduces *sequence identifiers*. Sequence identifiers flag the order of deliveries. This makes indication delivery more reliable, because the CIM server can retry unsuccessful deliveries, and a CIM listener can detect lost and duplicate deliveries and reorder indications arriving out of order.

Indication delivery is based on a *publish/subscribe event paradigm*, where a CIM server delivers indications to subscribed WBEM listeners.

If the attempt of a WBEM server to deliver an indication to a WBEM listener fails, the service retries the delivery. For this, the number of delivery retry attempts and the minimum delivery retry interval are specified (with the *DeliveryRetryAttempts* and *DeliveryRetryInterval* properties of the appropriate *CIM\_IndicationService* instance associated with the *CIM\_IndicationFilter* or *CIM\_FilterCollection* instance). Each sequence identifier has a *lifetime*, which is the number of delivery retry attempts multiplied by the minimum delivery retry interval multiplied by 10.

The indication is not delivered to the listener, if the number of retry attempts or the lifetime of the sequence identifier is exceeded.

For more information, see DMTF Indications Profile DSP1054 1.1.

## How indications work

Indications are generated and processed as shown in Figure 3 and described in the subsequent list:

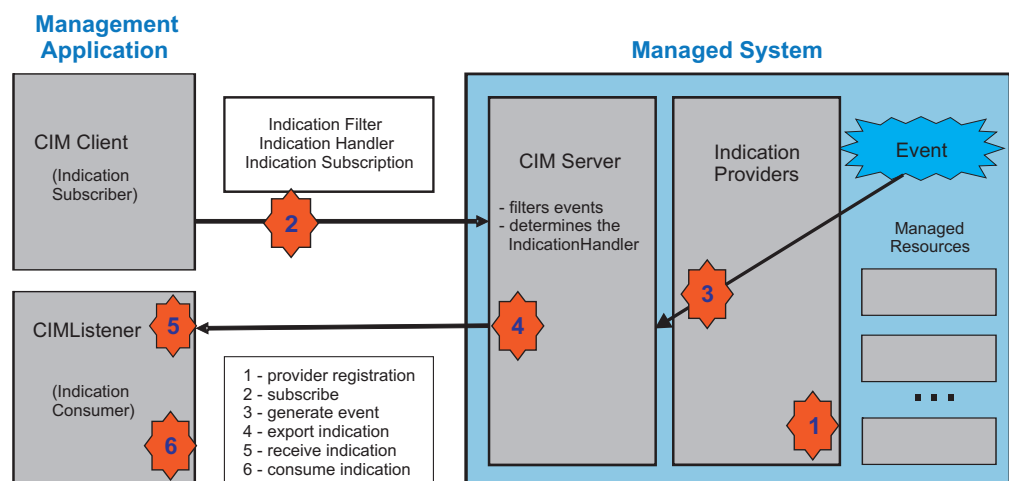

Figure 3. CIM indication flow and processing

### 1. Indication providers are registered:

An indication provider is a CIM provider that recognizes when a particular type of event occurs on the managed system. The indication provider turns that event into a type of *CIM\_Indication* and passes it to the CIM server.

An indication provider is registered with the CIM server just as any other provider is registered using *PG\_ProviderCapabilities* as described in "Registering a provider with the CIM server" on page 293.

### 2. The CIM client creates the three CIM instances mentioned above:



For this, the CIM client uses the *createInstance* CIM operation. The instances must be created in the root/PG\_InterOp namespace of the CIM server.

**a. To request the notification of a specific event, a CIM client defines an indication filter condition:**

The CIM client issues CIM operation requests to the CIM server to create an instance of the CIM\_IndicationFilter class.

The CIM\_IndicationFilter instance defines the event with a query string in a query language like CIM Query Language (CQL) or WBEM query language (WQL).

For details on CQL, see the CIM Query Language Specification.

**b. To specify how to handle and where to send an indication, the CIM client defines an indication listener:**

The CIM client issues CIM operation requests to the CIM server to create an instance of the CIM\_ListenerDestination class.

A CIM\_ListenerDestination is an abstract superclass that specifies how to handle and where to send the indication. It may define a destination and protocol for delivering indications, or a process to be invoked. z/OS supports the subclass CIM\_ListenerDestinationCIMXML as a vehicle to describe the destination URL for indications, which can receive indications in CIMXML format.

**c. The CIM client activates the subscription:**

The CIM client issues CIM operation requests to the CIM server to create an instance of the CIM\_IndicationSubscription class.

A CIM\_IndicationSubscription is an association between a CIM\_IndicationFilter and a CIM\_ListenerDestination (see Figure 19 on page 305).

**3. When an event occurs on the managed system, it is detected by the CIM indication provider:**

The CIM indication provider turns that event into a specific indication. At this stage, the indication is a local representation of an instance of a subclass of class CIM\_Indication. The indication provider delivers that indication to the CIM server for further processing and delivery.

Typically the indication is an instance of a subclass of class CIM\_ProcessIndication or class CIM\_InstIndication.

**4. The CIM server delivers the indications to the CIM listeners:**

**a. The CIM server filters the indications:**

The indications delivered by the indication provider are filtered according to the filter conditions of the active subscriptions.

**b. The CIM server generates a CIM export message to transmit the CIM\_Indication instance to the CIM listener URL according to the matching filter conditions in the format and protocol specified in the CIM\_ListenerDestination instance.**

**5. The CIM listener receives the CIM\_Indication instance:**

The CIM listener or CIM server coordinates the distribution of the indication to one or more registered indication consumers and sends CIM export responses.

**6. The CIM\_Indication is delivered to one or more indication consumers.**



---

## Chapter 3. z/OS CIM security concept

Although the CIM server on z/OS is based on the open source implementation, the security design has been considerably extended and adapted to meet the z/OS security strengths.

The CIM server security consists of two major areas: Protection of resources on the managed system through *authentication* and *authorization*, and protection of communicated information through *network security*.

The AT-TLS feature of z/OS is used to encrypt data using SSL for data security on the network. It is recommended to utilize this support.

To protect resources on the managed system from unauthorized access, first of all users have to be authenticated to ensure the CIM server is really communicating with an identified entity (user). Users can be authenticated by either a user identity (ID) and a password, a user identity and a PassTicket, or a user certificate. In all cases after successful authentication the user who wants to access the system is well known and now authorization checks are performed against that specific user identity.

The CIM server performs three types of authorization checks:

1. For each user, the CIM server checks the authority to access CIM. To get general access to CIM, a user needs at least READ access to profile CIMSERV in System Authorization Facility (SAF) class WBEM.
2. The access to the provider is checked. Access to a provider can be explicitly restricted by defining a provider-specific profile in SAF class WBEM and registering the provider with that security profile. This access restriction is optional and depends on whether a provider was registered with a security profile or not.
3. The last checks of authorization are performed based on the z/OS system resources a user tries to access, what effectively means that users can only access the resources for which they were entitled before.

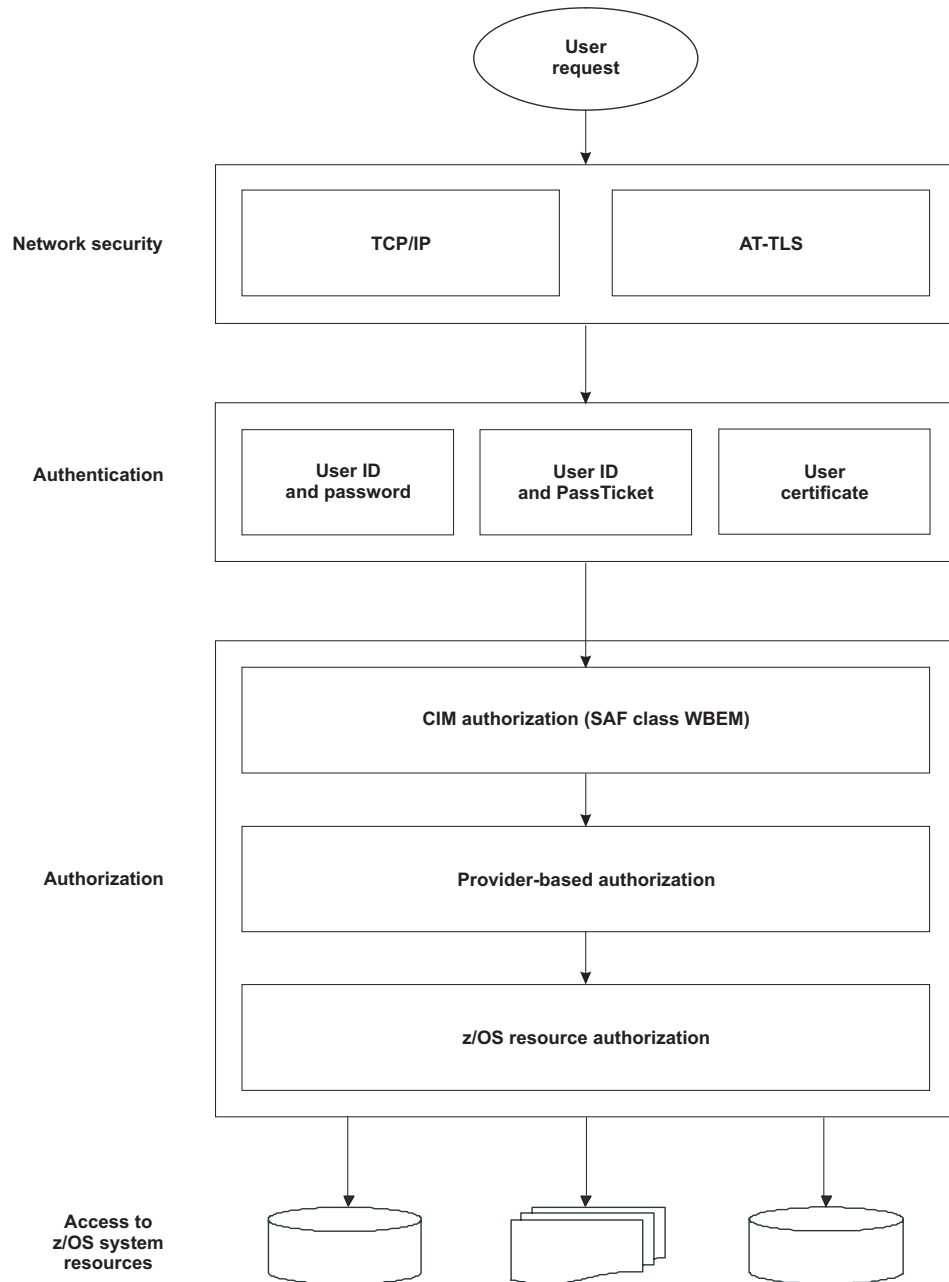

Figure 4. Security components

Figure 4 shows the CIM server runtime environment security:

**Network security**

AT-TLS provides network security. It is recommended to utilize this feature.

**Authentication**

Authentication is always enabled for the CIM server. The CIM server checks whether the requestor is entitled to use the CIM server. A requestor authenticates with a user ID and a password, with a user ID and a PassTicket, or with a user certificate.

## Authorization

### **CIM authorization (RACF class WBEM)**

The CIM server controls whether the user ID is authorized to access the CIM server using the RACF class WBEM. The profile CIMSERV restricts access to the CIM server.

### **Provider based authorization**

Optionally, a provider can be registered with a specific security profile. In this case, the user ID has to be authorized before it can invoke the provider. A provider-specific profile in RACF class WBEM restricts the access to the provider.

These checks are strongly recommended for providers which use a designated user ID.

### **z/OS<sup>®</sup> resource authorization**

The z/OS system resource access authorization is verified against the requesting user ID.

For authorization purposes to specific z/OS system resources, the CIM server processes requests either under the user ID which has generated the request or under a designated user ID which was registered for the provider. To do this, the CIM server uses thread-level security, which is provided by the UNIX System Services.

For that reason certain providers require additional authorization to extra security profiles.

Additionally, the CIM server is enabled for the *Enhanced Security model*. Under the Enhanced Security model, the CIM server does not load any dynamic load library that is not program controlled, in particular it does not load any such provider dynamic load library.



---

## Part 2. Installation and setup





---

## Chapter 4. Installation

This chapter describes how to install the CIM server, how to migrate the CIM server to the current release, and how to fall back to a previous CIM server version.

- **Use SMP/E to install z/OS CIM for the first time or to migrate z/OS CIM as a replacement of a previous z/OS CIM version.**

For details on installing a product using SMP/E, see *z/OS Program Directory*.

After successful installation, the components of z/OS CIM are located in the following hierarchical file system directory.

*Table 1. Default SMP/E installation directories for z/OS CIM*

Directory	Description
/usr/lpp/wbem	Base hierarchical file system directory
/usr/lpp/wbem/bin	CIM server executables
/usr/lpp/wbem/lib	CIM server libraries
/usr/lpp/wbem/install	Sample profile
/usr/lpp/wbem/provider	CIM provider libraries provided with z/OS
/usr/lpp/wbem/provider/schemas	IBM z/OS instrumentation MOF files
/usr/lpp/wbem/msg	CIM message files for NLS
/usr/lpp/wbem/schemas	DMTF CIM schema files (MOF)
/usr/lpp/wbem/repository	CIM schema master repository
/usr/lpp/wbem/jclient	CIM client for Java
/usr/lpp/wbem/IBM	SMP/E target library path

The modules CFZENF09, CFZENF27, and CFZENF33 are located in system image SYS1.LPALIB. These modules are needed by the Common Event Adapter (CEA) for the life cycle indications defined for the storage management instrumentation.

If you migrate to z/OS 2.1, the new master repository is located in */usr/lpp/wbem/repository*. Previous versions of the repository are backed up as */var/wbem/repository/repository\_old\_<timestamp>*, where *<timestamp>* is the current time.

- **If you migrate the CIM server to a new z/OS release, it is recommended that you replace the environment variable file `cimserver.env` located in `/etc/wbem` with the new sample installed in directory:**

*/usr/lpp/wbem*

If you do not intend to replace the environment variable file `cimserver.env` with the new sample, make sure that the following directories are included in the LIBPATH defined in `cimserver.env`:

*/usr/lpp/wbem/lib:/usr/lpp/wbem/provider:/usr/lib*

---

## Migration from z/OS 1.12 or z/OS 1.13 to z/OS 2.1

You can install z/OS 2.1 CIM as described above as a replacement of a previous z/OS CIM version without affecting any external programs interfacing with the CIM server, such as management applications.

During startup, the z/OS 2.1 CIM server will automatically correct eventually missing file tags in its repository. In addition, it will detect if an existing repository is up to date.

If back-level, the CIM server will automatically upgrade the repository in */var/wbem* following these steps:

1. The CIM server backs up the current repository into *repository\_old\_<timestamp>* where *<timestamp>* is the current time.
2. The CIM server copies the master repository from */usr/lpp/wbem/repository* to */var/wbem/repository*.
3. The CIM server migrates the previous repository content to the current repository.

If the CIM server does not find a repository in */var/wbem* at startup, it automatically creates a default repository from the master repository that is shipped under */usr/lpp/wbem*. To recover a damaged repository, you can create a new repository by removing the damaged repository from */var/wbem*. Then the CIM server creates a new copy at the next startup. Please note that all your custom changes for the repository, for example additional provider registrations, will be lost in this case and have to be done again.

The CIM server also checks for syntactical errors in the *cimserver.env* file located in directory */etc/wbem/*. Errors recognized by the CIM server are automatically corrected. The corrected version of *cimserver.env* replaces the old one, but the startup fails. Restart the CIM server.

---

## Fallback from z/OS 2.1 to z/OS 1.12 or z/OS 1.13

The CIM server does not automatically support fallbacks to a previous version. To do so, you must recover the necessary files from repository backups.

To fall back to a previous z/OS CIM server version,

- \_\_\_ 1. Stop the CIM server
- \_\_\_ 2. Delete */var/wbem/repository*
- \_\_\_ 3. Delete */var/wbem/repository\_status*
- \_\_\_ 4. Copy */var/wbem/repository\_old\_<timestamp>* to */usr/lpp/wbem/repository*, where *<timestamp>* is the time when you migrated from the former to the later release

If this file is no longer available and you do not have your own backup, you can find the originally delivered version in the master repository located in */var/wbem/repository*, but all your changes, such as special provider registrations, will be lost.

- \_\_\_ 5. Restart the CIM server

---

## Chapter 5. Quick guide: CIM server setup and verification

This chapter describes the necessary setup steps of the CIM server on a z/OS system. It can be used for a quick setup - to configure CIM without the need to understand the specifics of the CIM server's features and fine-grained authorization model - or as a guide through the setup steps from security setup to customization and finally the setup verification.

To set up the CIM server for the first time, perform the following steps which are described in more detail in the chapters below:

- Step 1. Set up the security for the CIM server (once per security domain/sysplex)
  - For a quick setup, use job CFZSEC from the installation SAMPLIB
- Step 2. Customize the file systems and directories used by the CIM server (once per z/OS system for which you want to configure CIM)
  - Use job CFZRCUST from the installation SAMPLIB
- Step 3. Use the default TCP/IP ports 5988 and 5989
- Step 4. Start the CIM server (once per z/OS system)
  - Copy the CFZCIM started task procedure from the installation PROCLIB
  - START CFZCIM
- Step 5. Customize the UNIX System Services shell
  - Add the content of /usr/lpp/wbem/install/profile.add to /etc/profile or to the user specific profiles residing in the user home path.
- Step 6. Run the installation verification program (IVP) (once per CIM server)
  - Use job CFZIVP from the installation SAMPLIB

---

### Step 1: Setting up the security for the CIM server

The security setup for the CIM server is done once per security domain and works for all systems that share this security domain, for example all systems that use the same shared RACF database.

#### Quick security setup for RACF

If you are using RACF as your security product, the quickest way to set up CIM server security is using the job CFZSEC provided in the installation SAMPLIB.

With little customization, this sample provides a working security setup for CIM, which allows you to start the CIM server and users or applications to connect to the CIM server.

Please note that the CFZSEC job is meant for a quick setup only. It is not recommended to use it as the final configuration without having reviewed the details of the CIM security setup described in Chapter 6, "CIM server security setup," on page 23.

- \_\_\_ 1. Review the CFZSEC job and customize the following steps:

**Required updates:**

- \_\_\_ a. If profile BPX.SERVER in the FACILITY class is active on your system, you should change the UID for CFZSRV to a value other than 0 in step CRUSR. In this case, the default for the UID is 9500. If the profile is not already active on your system, it is recommended to define the CIM server user with a UID of 0 in the initial setup for simplicity reasons.

**Note:** Do not assign a password to the CFZSRV user ID.

- \_\_\_ b. If you are using the z/OS Resource Measurement Facility™ (RMF) optional element, replace #rkeymask with a 16-digit (0-9, A-F) keymask value to set up the connectivity between CIM and RMF via PassTickets. Otherwise, you may remove the step ENRMF from the job.

**Note:** The keymask value is a secret passkey. In a secure environment it is recommended to perform step ENRMF separately to avoid storing the passkey in the job log in readable format.

**Optional changes:**

- \_\_\_ Check that the GIDs (9501-9503) used in step CRUSR are not already in use on your system, otherwise change them.

For details on each step of the CFZSEC job see “Appendix B. Step-by-step explanation of the CFZSEC job” on page 341.

- \_\_\_ 2. Submit CFZSEC

Please note that, because this job provides a solution for each configuration, necessarily the job steps which do not apply to your system will fail. This does not affect the job's functionality.

- \_\_\_ 3. Authorize users to CIM by connecting them to group CFZUSRGP

Be sure to have at least one user authorized for CIM in order to run the Installation Verification Procedure as described in “Step 6: Running the installation verification program (IVP)” on page 22.

## Security setup for a production environment

To set up the security for a production environment, see Chapter 6, “CIM server security setup,” on page 23 and Chapter 7, “CIM provider setup and security,” on page 37.

---

## Step 2: Customizing the file systems and directories

On each z/OS system where you want to start the CIM server, you need to set up the directories in the UNIX file system, where the CIM server stores its configuration and runtime data:

- \_\_\_ 1. If you have installed z/OS CIM for the very first time, customize the CFZRCUST sample job from the SAMPLIB as described in “Customizing CFZRCUST” on page 46.
- \_\_\_ 2. Submit the CFZRCUST sample job from the SAMPLIB  
CFZRCUST sets up the directories */etc/wbem* and */var/wbem* for the CIM server.

- \_\_\_ 3. Change the owner of the */etc/wbem* and */var/wbem* directories to the CIM server user (default CFZSRV). For this, enter the following commands on the UNIX System Services command prompt from a user with superuser privileges:  

```
chown -R CFZSRV:CFZSRVGP /etc/wbem
chown -R CFZSRV:CFZSRVGP /var/wbem
```
- \_\_\_ 4. If you are setting up the CIM server for a production environment, please refer to additional customization steps as described in Chapter 8, “Customization,” on page 45.

---

### Step 3: Using default TCP/IP ports 5988 and 5989

For a successful startup, the CIM server must be able to listen to the configured HTTP or HTTPS ports. Ensure that the CIM server can use the default TCP/IP port 5988 for HTTP or 5989 for HTTPS. Check if another server is listening on one of these ports, your security product is protecting these ports, or the port is blocked by the TCP/IP configuration.

To determine if the port has been reserved,

- \_\_\_ verify that the port specified for the *httpPort* configuration property is not included in the range of reserved ports specified in the BPX parmlib member's INADDRANYPORT and INADDRANYCOUNT parameters.

“Configuring the ports for the CIM server” on page 45 describes how you can check and, if necessary, set up the port configuration.

---

### Step 4: Starting the CIM server

To start the CIM server,

- \_\_\_ 1. Copy the CFZCIM started task procedure from your installation PROCLIB to a data set that is part of your PROCLIB concatenation
- \_\_\_ 2. Start the CIM server from the z/OS system console via the START CFZCIM command

A successful start of the CIM server is indicated (among others) by the following console messages:

```
CFZ10025I: The CIM server is listening on HTTP port 5988.
CFZ10028I: The CIM server is listening on the local connection socket.
CFZ10030I: Started CIM Server version 2.10.0.
CFZ12533I: The CIM server failed to register with ARM using element name CFZ_SRV_SY1
          : return code 0x0C, reason code 0x0160.
```

For a different way to start the CIM server, see

“Customizing the CIM server startup” on page 50 and

“Running the CIM server from the UNIX System Services command prompt” on page 66.

---

### Step 5: Customizing the UNIX System Services shell

To be able to run CIM server commands, the UNIX System Services shell has to be tailored. The file */usr/lpp/wbem/install/profile.add* contains the required environment variables to run CIM server commands.

To prepare the UNIX System Services shell to run CIM server commands,

- add the content of `/usr/lpp/wbem/install/profile.add` to `/etc/profile` or to the user specific profiles residing in the user home path.

For a detailed description, see “Customizing the UNIX System Services shell” on page 51.

---

## Step 6: Running the installation verification program (IVP)

To verify that your CIM installation and customization was completed successfully, you can

- Submit the job CFZIVP contained in your installation SAMPLIB  
This job needs to run under a user that was previously authorized for CIM as described at the end of chapter “Step 1: Setting up the security for the CIM server” on page 19.

A successful CIM setup is indicated by a MAXCC=0 for the CFZIVP job along with a success message at the end of the job output like this:

```
cimivp - All tests completed successfully
```

For a detailed description of the installation verification program, see Chapter 10, “Setup verification,” on page 61.

---

## Chapter 6. CIM server security setup

The z/OS implementation of the CIM server requires each requestor to have a real z/OS user ID. Only users who have been successfully authenticated with the z/OS security product and who have been granted access to the CIM server, will be able to execute requests against the CIM server. This chapter describes the details on how to set up these features.

Setting up security for the CIM server includes the following steps:

- \_\_\_ 1. Define a RACF class and profile for the CIM server  
(see “Defining a RACF class and profile for the CIM server” on page 24).
- \_\_\_ 2. Define a user ID for the CIM server and grant it access to the CIM server's RACF profile  
(see “Defining a CIM server user ID” on page 25)
- \_\_\_ 3. Configure the CIM server's resource authorization model  
(see “Configuring the CIM server's resource authorization model” on page 25)
- \_\_\_ 4. Grant client users and administrators access to the CIM server  
(see “Granting clients and administrators access to the CIM server” on page 28)
- \_\_\_ 5. Allow the CIM server to surrogate for a client ID  
(see “Switching identity (surrogate)” on page 29)
- \_\_\_ 6. Optionally configure secure connections (HTTPS) for the CIM server  
(see “Configuring the CIM server HTTPS connection using AT-TLS” on page 29).
- \_\_\_ 7. If the APPL class for your security product is active, optionally define the CFZAPPL profile  
(see “Defining the CFZAPPL profile for the APPL class” on page 35)
- \_\_\_ 8. For PassTicket usage define an encryption key for the application ID CFZAPPL  
(see “Defining an encryption key for PassTicket validation” on page 35)
- \_\_\_ 9. If multilevel security (MLS) is active on your system and the CIM server UID≠0, grant the CIM server user ID READ access to security resource BPX.POE in the FACILITY class  
(see “Setting up multilevel security (MLS) support” on page 35)
- \_\_\_ 10. If the CIM server is configured to use the Automatic Restart Manager (ARM) in a sysplex, you must ensure that the XCF address space has the proper authorization to perform a restart  
(see “Considering Automatic Restart Manager security” on page 36).
- \_\_\_ 11. If you intend to run providers out-of-process, grant the CIM server user ID READ access to the profile BPX.JOBNAME defined in the FACILITY class  
(see “Running providers in separate address spaces” on page 66)

---

## Defining a RACF class and profile for the CIM server

Access to the CIM server is controlled through RACF class WBEM. Define a new class in RACF through the dynamic CDT feature of the z/OS Security Server as follows:

1. To be able to build the dynamic class WBEM, activate the class descriptor table (CDT) using the following RACF command:

**Example:**

```
SETROPTS CLASSACT(CDT) RACLIST(CDT)
```

2. By adding a profile to the IBM class named CDT, you can create a new class definition. This profile then represents a dynamic class. The segment CDTINFO is used to define the class attributes. You can define the dynamic class WBEM with the following RACF commands:

**Example:**

```
RDEFINE CDT WBEM UACC(NONE) CDTINFO(  
  CASE(UPPER)  
  FIRST(ALPHA)  
  OTHER(ALPHA,NUMERIC)  
  MAXLENGTH(246)  
  MAXLENX(246)  
  KEYQUALIFIERS(0)  
  PROFILEALLOWED(YES)  
  POSIT(200)  
  DEFAULTTRC(8)  
  DEFAULTUACC(NONE)  
  RACLIST(REQUIRED)  
)  
SETROPTS RACLIST(CDT) REFRESH
```

The default values shown above (except POSIT(200)) are expected by the CIM server; do not use different values as this can yield unpredictable results.

You can ignore the warning message which is issued when adding class WBEM.

For a more detailed description of how to create a new class within RACF dynamic CDT, see *z/OS Security Server RACF Security Administrator's Guide*.

3. To activate the new class, issue:

**Example:**

```
SETROPTS CLASSACT(WBEM) RACLIST(WBEM)
```

4. After creating and activating the WBEM class, create the CIMSERV profile within this class. Profile CIMSERV is used to grant users access to the CIM server.

The following example illustrates the RACF commands that are required to define a profile named CIMSERV in this class:



**Example:**

```
RDEFINE WBEM CIMSERV
SETROPTS CLASSACT(WBEM) RACLIST(WBEM) REFRESH
```

---

## Defining a CIM server user ID

To define a CIM server user ID:

1. Either select an existing user ID or create a new CIM server user ID. We recommend to create a CIM server user ID named CFZSRV with UID 9500 and a CIM server group ID named CFZSRVGP with GID 9501.

Depending on the security model under which the CIM server runs, the user ID may need to be privileged (UID=0).

For more information to decide on the privileges for the CIM server user ID, see “Configuring the CIM server's resource authorization model.”

2. Allow the CIM server's user ID CONTROL access to profile CIMSERV in class WBEM.

The following example shows the required RACF commands to achieve this, where the user ID CFZSRV was chosen for the CIM server:

**Example:**

```
PERMIT CIMSERV CL(WBEM) ACCESS(CONTROL) ID(CFZSRV)
SETROPTS CLASSACT(WBEM) RACLIST(WBEM) REFRESH
```

3. If you run the CIM server as started task, it is recommended to define the CIM server user ID as *protected user ID*. Protected user IDs are protected from being used to log on to the system, and from being revoked through incorrect password attempts.

You can define a protected user ID or change an existing user ID into a protected user ID by assigning the NOPASSWORD, NOPHRASE, and NOOIDCARD attributes through the ADDUSER or ALTUSER command.

**Example:**

```
ALTUSER CFZSRV NOPASSWORD NOOIDCARD NOPHRASE
```

For more details about protected user IDs see *z/OS Security Server RACF Security Administrator's Guide*.

For more information on how to associate the CIM server user ID with the started task, see “Customizing the started task procedure CFZCIM” on page 50.

---

## Configuring the CIM server's resource authorization model

The CIM server can be run with two different authorization models, depending on whether the profile BPX.SERVER is defined in the FACILITY class or not. In any case, the CIM server follows a *resource-based authorization model*, which means that user requests are processed in separate threads, for which the security context is switched to the user ID of the requestor or to a designated user ID. So when a CIM provider performs a user request in such a thread, it accesses any z/OS system resource under the requestor's or a designated user ID and thus,

authorization checks occur against this user ID. These checks are performed in addition to the general access check for the CIM server through the CIMSERV profile in class WBEM.

To let the resource based authorization security work properly, set up the CIM server user ID as follows:

\_\_\_ 1. **If the Enhanced Security model is disabled:**

When the Enhanced Security model is disabled, no profile BPX.SERVER is active in the FACILITY class.

- \_\_\_ Set up the user ID running the CIM server as a privileged user (UID=0).

**If the Enhanced Security model is enabled:**

When the Enhanced Security model is enabled, profile BPX.SERVER exists in the FACILITY class, and the FACILITY class is active.

**Note:**

The definition of BPX.SERVER is not specific for the CIM server, but has system wide implications for all programs running on the z/OS system. Refer to Setting up the BPX.\* FACILITY class profiles in *z/OS UNIX System Services Planning* for additional information.

- \_\_\_ a. Set up the user ID running the CIM server with UPDATE access to BPX.SERVER.
- \_\_\_ b. If the CIM server user ID is not privileged (UID ≠ 0), ensure that the directories */etc/wbem* and */var/wbem* are owned by this user ID. The following example shows how to change ownership:

**Example:**

```
chown -R <Server UserID>:<Server GroupID> /etc/wbem
chown -R <Server UserID>:<Server GroupID> /var/wbem
```

If any of these requirements are not met, the CIM server will not start, but issue an according error message in the logs.

- \_\_\_ 2. Consider to enable the *must-stay-clean feature* (see “Enabling the must-stay-clean feature”).
- \_\_\_ 3. If the Enhanced Security model or the must-stay-clean feature is enabled, make sure that the CIM server runs in a clean program controlled environment (see “Setting up program control” on page 27).

## Enabling the must-stay-clean feature

To add additional system integrity to the CIM server, z/OS provides the optional *must-stay-clean* feature. To benefit from the feature, you must enable it explicitly.

**Must-stay-clean provides additional system integrity:**

- Provider libraries are loaded dynamically during runtime by the CIM server. The must-stay-clean feature prevents uncontrolled libraries to be loaded on behalf of a dynamic provider.
- Providers using the out-of-process support can be managed in separate address spaces rather than loading and calling provider libraries directly within the CIM

server process. This converts the CIM server process into a daemon process that starts off several server processes (provider agent processes). Providers are then run in threads by the provider agents.

Must-stay-clean secures the trust base between both address spaces.

**To enable the must-stay-clean feature,**

- define the BPX.DAEMON FACILITY class in your security product  
Defining BPX.DAEMON enforces program control. The following sample shows the according RACF commands:

**Example:**

```
SETOPTS CLASSACT(FACILITY)
SETOPTS RACLIST (FACILITY)
RDEFINE FACILITY BPX.DAEMON UACC(NONE)
SETOPTS RACLIST(FACILITY) REFRESH
```

**Note:** The definition of BPX.DAEMON is not specific for the CIM server, but has system wide implications for all programs running on the z/OS system. Refer to *Setting up the BPX.\* FACILITY class profiles and Setting up security procedures for daemons in z/OS UNIX System Services Planning* for additional information.

## Setting up program control

Program control means that all programs running in the address space have been loaded from a library that is controlled by a security product. A library identified to RACF program control is an example. Refer to *z/OS UNIX System Services Planning* for additional information about program control.

If the CIM server runs with authority to BPX.SERVER or with the must-stay-clean feature, the server must run in a clean program controlled environment.

**To enable program control:**

- 1. Ensure that all libraries are flagged as *program controlled*.  
By default, all libraries shipped with the CIM server are flagged as program controlled. If additional provider libraries are installed, it may be required to set the program control flag manually using the extattr +p <libname> command.
- 2. In addition to the UNIX System Services files, mark several MVS™ libraries as program controlled. The following sample shows the according RACF commands.

**Example:**

```
RALT PROGRAM * ADDMEM('SYS1.SCEERUN'/'*****'/NOPADCHK) +
  UACC(READ)
RALT PROGRAM * ADDMEM('SYS1.SCEERUN2'/'*****'/NOPADCHK) +
  UACC(READ)
RDEFINE PROGRAM BLSUXTID
RALT PROGRAM BLSUXTID ADDMEM('SYS1.MIGLIB'/'*****'/NOPADCHK) +
  UACC(READ)
SETOPTS WHEN(PROGRAM) REFRESH
```

If you are using z/OS Resource Measurement Facility (RMF), then the library SYS1.SERBLINK should also be program controlled.

- \_\_\_ 3. Ensure that the CIM server runtime environment runs in its own address space:
  - \_\_\_ either start the CIM server using the provided started task procedure
  - \_\_\_ or set the environment variable `_BPX_SHAREAS=NO` in your z/OS UNIX System Services shell before starting the CIM server with the `cimserver` command.

---

## Granting clients and administrators access to the CIM server

The CIM server authenticates users with the z/OS Security Server to determine which users can log into it. Authentication is performed for every new connection (local or remote) before a user is granted access to the CIM server.

For the CIM server for z/OS, users log on over HTTP or HTTPS using basic authentication or certificate authentication. When logging on, users are authenticated using their z/OS user ID and password as defined, for example, in RACF.

To access the CIM server, a user must be at least linked to a group with READ access to RACF profile CIMSERV. In order to use any of the administrative command-line tools of the CIM server, as described in Chapter 12, “CIM server command-line utilities and console commands,” on page 79, a group instead requires CONTROL access to the CIMSERV profile.

For detailed information about the required access rights, see the following table.

*Table 2. Access types required for CIM operations*

CIM operation type	CIM operations	RACF access
Basic read	GetClass, EnumerateClasses, EnumerateClassNames, GetInstance, EnumerateInstance, EnumerateInstanceNames, GetProperty, GetQualifier, EnumerateQualifier	READ
Basic write	SetProperty	UPDATE
"Method"	ExecuteMethod	UPDATE
Schema Manipulation	CreateClass, ModifyClass, DeleteClass	CONTROL
Instance Manipulation	CreateInstance, ModifyInstance, DeleteInstance	UPDATE
Indication Subscription	CreateInstance, ModifyInstance, DeleteInstance	UPDATE
Association Traversal	Associators, AssociatorNames, References, ReferenceNames	READ
Query	ExecQuery	READ
Qualifier Declaration	SetQualifier, DeleteQualifier	CONTROL

The following example shows how to define UPDATE access for a client group called CFZUSRGP:

**Example:**

```
PERMIT CIMSERV CL(WBEM) ACCESS(UPDATE) ID(CFZUSRGP)
SETROPTS RACLIST(WBEM) REFRESH
```

In addition, the CIM server user ID must be defined as a surrogate of the client user ID (see “Switching identity (surrogate)”).

To enable a user to use the command line tools, set up the UNIX System Services environment as described in “Customizing the UNIX System Services shell” on page 51.

---

## Switching identity (surrogate)

The CIM server uses services which can be run in client or server security context. For this, the CIM server must be able to switch its user ID to the client user ID. To allow the CIM server for this, define BPX.SRV profiles for the SURROGAT class within your System Authorization Facility (SAF).

The recommended way to do this is:

- Specify a general profile to allow the CIM server user ID to switch to any other z/OS user ID with a UNIX System Services segment defined.

The following sample shows the required RACF commands to create the generic profile, where the CIM server user ID is CFZSRV:

**Example:**

```
SETROPTS CLASSACT(SURROGAT) RACLIST(SURROGAT) GENERIC(SURROGAT)
RDEFINE SURROGAT BPX.SRV.** UACC(NONE)
PERMIT BPX.SRV.** CLASS(SURROGAT) ACCESS(READ) ID(CFZSRV)
SETROPTS GENERIC(SURROGAT) RACLIST(SURROGAT) REFRESH
```

---

## Configuring the CIM server HTTPS connection using AT-TLS

The CIM server runtime environment can profit from the Application Transparent Transport Layer Security (AT-TLS) functionality. The communication between the CIM client and the CIM server can be secured by encryption (SSL). Additionally the CIM client can be authenticated by a certificate and mapped to a local z/OS user ID.

The following task describes how to configure the CIM server HTTPS connection using AT-TLS.

— 1. **Prerequisites**

- Ensure that the basic setup for the Policy Agent is done.  
See *z/OS Communications Server: IP Configuration Guide* about policy-based networking and data protection.
- Ensure that the basic certificates setup is done.  
For handling certificates for secure communications for RACF, see *z/OS Security Server RACF Security Administrator's Guide* about RACF and digital certificates.

— 2. **Configuring the CIM server runtime**

- Set the configuration property *enableHttpsConnection* to true.
- Ensure that the configuration property *httpsPort* is set to 5989. This default should not be changed.
- Ensure that the https port 5989 can be used by the CIM server. For more information, see “Configuring the ports for the CIM server” on page 45.

Based on this configuration, the CIM server opens a second listener for receiving client connections and ensures that these connections are secured by AT-TLS. The level of protection depends on the configuration of AT-TLS. If a connection on this port is not secured by AT-TLS, the connection is closed and an appropriate error message is issued on the operator console.

### — 3. **Configuring the Policy Agent to secure communication for the CIM server**

- Enable the Policy Agent for AT-TLS.  
See *z/OS Communications Server: IP Configuration Guide* about Application Transparent Transport Layer Security data protection.
- Configure the Policy Agent to secure the communication for the CIM server at the configured HTTPS port (configuration property *httpsPort*). For sample Policy Agent polices, see “Example: Configuring AT-TLS for secure communication” to configure either an SSL protection or an SSL protection including a certificate based authentication.
- Optionally you can protect the (outgoing) indication delivery on a specific port range with SSL.

## **Example: Configuring AT-TLS for secure communication**

This sample shows the exemplary setup of the Policy Agent to secure communication for the CIM server.

- SSL protection only (see “Prerequisite: Common certificate setup” and “SSL protection only” on page 31)
- SSL protection including certificate based authentication (see “Prerequisite: Common certificate setup” and “SSL protection including certificate based authentication” on page 31)
- SSL protected indication delivery (see “Prerequisite: Common certificate setup” and “SSL protected indication delivery” on page 33)

For a more detailed explanation about Policy Agent AT-TLS policy see *z/OS Communications Server: IP Configuration Reference* about Policy Agent and policy applications and Application Transparent Transport Layer Security (AT-TLS) policy statements.

### **Prerequisite: Common certificate setup**

To enable AT-TLS to secure the communication, a valid server certificate, the associated server private key, and the certificate of trusted Certificate Authority's (CA) are needed. These examples are using a key ring named *CFZCIMServerRing* to store these credentials. This key ring must be accessible by the CIM server user ID (e.g. *CFZSRV*), and the server certificate must be the default certificate.

For a sample setup with RACF, see *z/OS Security Server RACF Security Administrator's Guide* about RACF and digital certificates, implementation scenario 1 or 2. For handling certificates and key rings, please refer to the documentation of your SAF product.

## SSL protection only

Simple SSL protection means that the communication between the client and the server is encrypted without having established a trust relationship between the client and the server. So the client still needs to send a user ID and a password for authentication.

To set up AT-TLS with simple SSL protection for the CIM server, a policy for the Communications Server Policy Agent has to be created that restricts AT-TLS to the CIM server port 5989 and to inbound TCP/IP communication.

### Sample Policy Agent policy for a simple SSL protection:

```
Example
-----
TTLSRule                CFZCIMServerRuleInbound
{
    Jobname                CFZCIM*
    LocalPortRange        5989
    Direction              Inbound
    TTLSGroupActionRef    grp_StartUp
    TTLSEnvironmentActionRef CFZCIMServerEnvActionInbound
}

TTLSEnvironmentAction CFZCIMServerEnvActionInbound
{
    HandshakeRole          Server
    TTLSEnvironmentAdvancedParams
    {
        ClientAuthType      PassThru
    }
    TTLSKeyRingParams
    {
        Keyring              CFZCIMServerRing
    }
}

# Common StartUp Group that new Rules may use
# Shows how each connection maps to policy
TTLSGroupAction grp_StartUp
{
    TTLSEnabled On
    Trace 0                # Log Errors and Info messages to syslogd
}
```

CIM server specific notes to the AT-TLS Policy parameters:

#### TTLSRule: Jobname

**Jobname** identifies where this rule applies. In the example, it is the started task job name. If you set up the connection this way, the configuration does not influence other parts of the system.

#### TTLSRule: LocalPortRange

This property must match the HTTPS port definition of the CIM server.

## SSL protection including certificate based authentication

Since the CIM server is aware of AT-TLS, you can use SSL secured communications and certificates based authentication between the CIM client and the CIM server. The CIM server queries AT-TLS if the client is identified by a client certificate and mapped to a local user ID.

Authentication based on SSL certificates means:

- the communication between the client and the server is encrypted,
- the trust relationship is established, and
- the client certificate is matched to a local z/OS user ID.

No user ID and password have to be provided by the client. All subsequent authorization checking is done with the mapped user ID.

The CIM client sends an SSL certificate to AT-TLS, AT-TLS sends the certificate to RACF and RACF associates the certificate to the appropriate user ID, which then can access the CIM server. Vice versa, the CIM server returns its responses to client requests using SSL certificates.

This method of authentication provides more security than sending user IDs and passwords between client and server.

If you want to use this enhanced method based on certificates, you must create the inbound/outbound rules as follows:

To set up AT-TLS with authentication based on SSL certificates for the CIM server, a policy for the Communications Server Policy Agent has to be created that restricts AT-TLS to the CIM server port 5989 and to inbound TCP/IP communication. Also the SAF facility has to be set up to match certificate subjects to local z/OS user IDs.

For setting up the SAF facility to map certificates to local user IDs, see *z/OS Security Server RACF Security Administrator's Guide* about RACF and digital certificates, Certificate Name Filtering.

**Sample Policy Agent policy for authentication based on SSL certificates:**

#### Example

```
TTLRule          CFZCIMServerRuleInbound
{
  Jobname          CFZCIM*
  LocalPortRange   5989
  Direction        Inbound
  TTLGroupActionRef grp_StartUp
  TTLEnvironmentActionRef CFZCIMServerEnvActionInbound
}

TTLEnvironmentAction CFZCIMServerEnvActionInbound
{
  HandshakeRole      ServerWithClientAuth
  TTLEnvironmentAdvancedParms
  {
    ClientAuthType    SAFCheck
  }
  TLSKeyRingParms
  {
    Keyring           CFZCIMServerRing
  }
}

# Common StartUp Group that new Rules may use
# Shows how each connection maps to policy
TTLGroupAction grp_StartUp
{
  TTLEnabled On
  Trace 0          # Log Errors and Info messages to syslogd
}
```



CIM server specific notes to the AT-TLS Policy parameters:

**TTLRule: Jobname**

**Jobname** identifies where this rule applies. In this example it is the started task job name. If you set up the connection this way, the configuration does not influence other parts of the system.

**TTLRule: LocalPortRange**

This property must match the HTTPS port definition of the CIM server.

**SSL protected indication delivery**

This sample shows an exemplary setup for the usage of RACF to deliver secured indications with AT-TLS.

Delivering secured indications from the CIM server to an indication listener means that the CIM server establishes an encrypted connection to deliver indications. Whether a trusted relationship is established or not depends on the listener configuration.

In case a trusted relationship is established, the CIM server is a client to the indication listener and therefore an outbound policy has to be specified with AT-TLS. To deliver secured indications, the job name of the CIM server and the port specified in the indication handler destination property must match. An indication is defined by the application programmer so there has to be an agreement between the application programmer and the system programmer that port secured indications are sent from the CIM server to the indication listeners.

## Sample Policy Agent policy for the delivery of secured indications:

### Example

```
TTLRule          CFZCIMServerRuleOutbound
{
  Jobname          CFZCIM*
  RemotePortGroupRef  CFZCIMServerRemotePortGroup
  Direction        Outbound
  TLSGroupActionRef  grp_StartUp
  TTLEnvironmentActionRef CFZCIMServerEnvActionOutbound
}

TTLEnvironmentAction CFZCIMServerEnvActionOutbound
{
  HandshakeRole      Client
  TLSKeyRingParms
  {
    Keyring  CFZCIMServerRing
  }
}

PortGroup      CFZCIMServerRemotePortGroup
{
  PortRange
  {
    Port 5989
  }

  PortRange
  {
    Port 6000-7000
  }
}

# Common StartUp Group that new Rules may use
# Shows how each connection maps to policy
TLSGroupAction grp_StartUp
{
  TTLEnabled On
  Trace 0          # Log Errors and Info messages to syslogd
}
```

CIM server specific notes to the AT-TLS Policy parameters:

#### **TTLRule: Jobname**

**Jobname** identifies where this rule applies. In this example it is the started task job name. If you set up the connection this way, the configuration does not influence other parts of the system.

#### **PortGroup**

All indications which do have a port specified within the indication handler destination property and do match to any PortRange defined within the PortGroup are delivered secure via AT-TLS. If the destination property protocol is specified as https and no other port is specified, port 5989 will be used by the CIM server. So please ensure that always port 5989 is within a PortRange. In this example, all indications with port 5989 and port 6000-7000 are delivered in a secured way.

---

## Defining the CFZAPPL profile for the APPL class

If the APPL class for the security product is active, the CFZAPPL profile can be defined to allow only certain users to log on to the CIM server. You can manage access to the CIM server application by a profile for CFZAPPL in the APPL class with an access list that contains only those users who are allowed to use the CIM server.

In general, you need not define a profile for CFZAPPL unless you have a generic profile (\*) that prevents access to applications without a more specific profile.

---

## Defining an encryption key for PassTicket validation

The CIM server can alternatively validate a user ID and a PassTicket instead of a user ID and a password for authentication.

For more information about PassTickets, see *z/OS Security Server RACF Security Administrator's Guide*.

A PassTicket is validated against an application ID. The application ID for the CIM server is CFZAPPL.

To enable CFZAPPL for the CIM server,

- Define CFZAPPL profile in the PTKTDATA class in RACF.

### Example:

```
SETROPTS CLASSACT (PTKTDATA)
SETROPTS RACLIST (PTKTDATA)
RDEFINE PTKTDATA CFZAPPL -
                SSIGNON(KEYMASKED(<key>))
SETROPTS RACLIST(PTKTDATA) REFRESH
```

where <key> is the 16 digit encryption key.

---

## Setting up multilevel security (MLS) support

In a conventional CIM server setup, all providers are processed in the CIM server's address space. If the CIM server is running in a *multilevel secure (MLS)* z/OS system, providers are executed in several provider agent processes depending on the user's security classification and port of entry, independent of the CIM server configuration.

### Additional setup for an MLS environment:

- If the Enhanced Security model is enabled (that is, the CIM server user ID is not privileged), make sure that the CIM server user ID has READ access to security resource BPX.POE in the FACILITY class.

This allows the CIM server to use the z/OS XL C/C++ Run-Time Library function `__poe()` to retrieve information on the security classification and the port of entry of a user.

**Example for the security product RACF:**

```
RDEFINE FACILITY BPX.POE UACC(NONE)
PERMIT BPX.POE CL(FACILITY) ACCESS(READ) ID(CFZSRV)
SETROPTS CLASSACT(FACILITY) RACLIST(FACILITY) REFRESH
```

where CFZSRV is the CIM server user ID.

For general information on MLS, please refer to *z/OS Planning for Multilevel Security and the Common Criteria*.

If the CIM server is not running in an MLS z/OS system, and you want to run providers in processes separate from the CIM server process for stability reasons or for debugging purposes, use the out-of-process support for providers. For more information, see “Running providers in separate address spaces” on page 66.

---

## Considering Automatic Restart Manager security

The z/OS CIM server is enabled for the Automatic Restart Manager (ARM).

If the CIM server is configured to use ARM in a sysplex, you must ensure that the XCF address space has the proper authorization to perform a restart. ARM must be able to issue operator commands from the XCF address space (XCFAS) to start the CIM server.

The CIM server is not running in supervisor mode. Therefore, the user ID running the CIM server must have proper SAF authorization to be allowed to register to ARM. Therefore the user ID running the CIM server also needs the SAF authorization for UPDATE access to the following FACILITY class resource:

**Example:**

```
IXCARM.DEFAULT.CFZ_SRV_<system_name>
```

Here is an example for entitling the CIM server user ID CFZSRV to register the CIM server for all machines within a sysplex using RACF:

**Example:**

```
SETROPTS CLASSACT(FACILITY) GENERIC(FACILITY)
SETROPTS RACLIST(FACILITY)

RDEFINE FACILITY IXCARM.DEFAULT.CFZ_SRV_* UACC(NONE)

PERMIT IXCARM.DEFAULT.CFZ_SRV_* CLASS(FACILITY) +
      ID(CFZSRV) ACCESS(UPDATE)

SETROPTS RACLIST(FACILITY) REFRESH
```

---

## Chapter 7. CIM provider setup and security

This chapter describes additional security and setup requirements for providers:

- \_\_\_ 1. RMF provider  
(see “Setting up the CIM server for RMF monitoring”)
- \_\_\_ 2. Network providers  
(see “Setting up the CIM server for network providers” on page 38)
- \_\_\_ 3. Job, Cluster, and Monitoring providers  
(see Chapter 14, “z/OS Management Instrumentation for CIM,” on page 125)
- \_\_\_ 4. Cluster, CoupleDataset, and JES2-JES3Jobs providers  
(see “Setting up the CIM server for Cluster, CoupleDataset, and JES2-JES3Jobs providers” on page 38)
- \_\_\_ 5. WLM provider  
(see “Setting up the CIM server for WLM management” on page 40)
- \_\_\_ 6. Storage management providers  
(see “Setting up the CIM server for storage management” on page 41)
- \_\_\_ 7. Optionally, you can run providers in a designated user context  
(see “Running providers in a designated user context” on page 42)
- \_\_\_ 8. Optionally, you can choose the provider based authorization model  
(see “Utilizing the provider based authorization model” on page 43)

---

### Setting up the CIM server for RMF monitoring

If you have installed RMF, you should consider the following setup for the connection of your RMF CIM providers to the RMF Distributed Data Server (DDS).

1. The CIM monitoring providers can automatically locate an active RMF DDS in the sysplex. When the DDS is restarted on different systems through RMF management, or through manual action, the CIM monitoring providers can connect to an active DDS without additional configuration. To enable this option, comment out or omit the `RMF_CIM_HOST` environment variable from your `cimserver.env` file.

For more information on the RMF-managed DDS refer to "Starting the Distributed Data Server" in the *z/OS RMF User's Guide*.

2. The CIM monitoring providers support PassTicket authentication to the DDS. In this case the `HTTP_NOAUTH` option must be disabled. Secure signon through PassTickets needs to be enabled in your security manager.

If you are using z/OS Security Server (RACF), the following commands can be used (for more information about configuring RACF to use PassTicket services, refer to *z/OS Security Server RACF Security Administrator's Guide*):

- Activate the `PTKTDATA` class and the `SETROPTS RACLIST` processing:

**Example for RACF:**

```
SETROPTS CLASSACT(PTKTDATA) RACLIST(PTKTDATA) GENERIC(PTKTDATA)
```

- Define the application `GPMSSERVE` to your security product.

The application is defined through the SAF profile GPMSEVERE in class PTKTDATA. <keymask> is the secret passkey shared with the application.

**Example for RACF:**

```
RDEFINE PTKTDATA GPMSEVERE SSGNON(KEYMASKED(<keymask>))
SETROPTS RACLIST(PTKTDATA) REFRESH
```

- Define an access profile for the PassTicket service.

**Example for RACF:**

```
RDEFINE PTKTDATA IRRPTAUTH.GPMSEVERE.* UACC(NONE)
```

- Grant the CIM server UPDATE access to the generic profile IRRPTAUTH.GPMSEVERE.\* in class PTKTDATA.  
This enables the CIM server user to create PassTickets on behalf of other users for authentication with GPMSEVERE.

**Example for RACF:**

```
PERMIT IRRPTAUTH.GPMSEVERE.* CL(PTKTDATA) ID(CFZSRV) ACCESS(UPDATE)
```

- Activate the changes.

**Example for RACF:**

```
SETROPTS RACLIST(PTKTDATA) REFRESH
```

---

## Setting up the CIM server for network providers

Access to TCP/IP stack data is controlled by a security resource. Such a security resource is required if a user ID, associated with the client of the CIM server, is not defined as a z/OS UNIX superuser. The resource name is **EZB.CIMPROV.sysname.tcpname**. It is defined in the SERVAUTH class. Access is granted if the user ID associated with the client of the CIM server is permitted for READ access to the resource.

---

## Setting up the CIM server for Cluster, CoupleDataset, and JES2-JES3Jobs providers

For using the Job and Cluster providers, some additional setup has to be done.

- \_\_\_ 1. Configure the Common Event Adapter (CEA):
  - \_\_\_ a. Define additional parameters in PARMLIB (see "PARMLIB updates")
  - \_\_\_ b. Prepare RACF for CEA (see "RACF setup" on page 39)
- \_\_\_ 2. When running in a sysplex, format the sysplex couple dataset to allow it to be cluster capable (see "Sysplex couple dataset formatting" on page 39).

### PARMLIB updates

To enable the Job and Cluster providers, define the following PARMLIB parameters:

### MAXCAD limit

This parameter defaults to 50. If the installation sets a lower limit, it may be necessary to increase this setting to accommodate the Common Event Adapter (CEA) Common Area Data Space (CADS).

### APF Authorize SYS1.MIGLIB

To enable the CFRM-related CIM providers, add the following to the installation's PROGxx PARMLIB member:

```
APF ADD DSNAME(SYS1.MIGLIB) VOLUME(*****)
```

### REXX Alternate Library

The Couple Dataset providers require the use of compiled REXX execs provided as part of the z/OS 1.9 SYSREXX support. These execs require the use of the REXX alternate library. The following addition to the installation's PROGxx PARMLIB member is one way to accomplish this:

```
LNKLST ADD,NAME(LNKLST00),DSN(REXX.V1R3M0.SEAGALT),ATTOP
```

## RACF setup

For using the Job and Cluster providers, RACF has to be prepared for CEA:

1. For the necessary RACF setup to permit CEA to use Automatic Restart Manager (ARM), see *z/OS Planning for Installation*, chapter "Customizing for CEA".
2. To configure CEA for the Cluster, Couple Dataset and JES2/JES3 Jobs CIM providers, use job CFZSEC from the installation SAMPLIB as described in Chapter 5, "Quick guide: CIM server setup and verification," on page 19. For details see job steps PECEA and ENCLCDS in "Appendix B. Step-by-step explanation of the CFZSEC job" on page 341.

## Sysplex couple dataset formatting

To format the sysplex couple dataset, use the IXCL1DSU format utility by specifying:

```
ITEM NAME(CLUSTER) NUMBER(1)
```

The following table shows a sample JCL formatting the sysplex couple dataset for enabling cluster functions. The IXCSYSPF member has been updated to indicate the new CLUSTER keyword.

Table 3. Sample sysplex couple dataset formatting JCL

```

IXCSYSPF JOB
*
* SAMPLE JCL TO FORMAT THE PRIMARY AND/OR ALTERNATE COUPLE DATA SETS
* - SYSPLEX COUPLE DATA SETS
*
* 1. SYSPLEX NAME IS REQUIRED AND IS 1-8 CHARACTERS
* 2. SYSPRINT DD IS A REQUIRED DD STATEMENT FOR FORMAT UTILITY
*   MESSAGES
* 3. SYSIN DD IS A REQUIRED DD STATEMENT FOR FORMAT UTILITY CONTROL
*   STATEMENTS
*
//STEP1 EXEC PGM=IXCL1DSU
//STEPLIB DD DSN=SYS1.MIGLIB,DISP=SHR
//SYSPRINT DD SYSOUT=A
//SYSIN DD *
    DEFINEDS SYSPLEX(PLEX1)
            DSN(SYS1.XCF.CDS01) VOLSER(CDSPK1)
            MAXSYSTEM(8)
            CATALOG
    DATA TYPE(SYSPLEX)
            ITEM NAME(GROUP) NUMBER(50)
            ITEM NAME(MEMBER) NUMBER(120)
            ITEM NAME(GRS) NUMBER(1)
            ITEM NAME(CLUSTER) NUMBER(1)
    DEFINEDS SYSPLEX(PLEX1)
            DSN(SYS1.XCF.CDS02) VOLSER(CDSPK1)
            MAXSYSTEM(8)
            CATALOG
    DATA TYPE(SYSPLEX)
            ITEM NAME(GROUP) NUMBER(50)
            ITEM NAME(MEMBER) NUMBER(120)
            ITEM NAME(GRS) NUMBER(1)
            ITEM NAME(CLUSTER) NUMBER(1)
/*

```

## Setting up the CIM server for WLM management

The z/OS Workload Manager (WLM) subsystem is represented in z/OS CIM through class IBMzOS\_WLM.

The provider serving class IBMzOS\_WLM requires UPDATE access to resources which are protected by profile MVSADMIN.WLM.POLICY in class FACILITY.

- Permit access to MVSADMIN.WLM.POLICY by either permitting the requestor's user ID access to the discrete profile MVSADMIN.WLM.POLICY, or to one of the generic umbrella profiles MVSADMIN.WLM.\* or MVSADMIN.\*, depending on your system's current security definitions.
  - Either, grant the requestor's user ID UPDATE access to the discrete RACF profile MVSADMIN.WLM.POLICY in class FACILITY.

### Example:

```

SETROPTS CLASSACT(FACILITY) RAclist(FACILITY)
PERMIT MVSADMIN.WLM.POLICY CLASS(FACILITY) ID(<client-ID>) ACCESS(UPDATE)
SETROPTS RAclist(FACILITY) REFRESH

```

- Or, grant the requestor's user ID UPDATE access to generic RACF profile MVSADMIN.WLM.\* in class FACILITY.



**Example:**

```
SETROPTS CLASSACT(FACILITY) RAclist(FACILITY) GENERIC(FACILITY)
PERMIT MVSADMIN.WLM.* CLASS(FACILITY) ID(<client-ID>) ACCESS(UPDATE)
SETROPTS RAclist(FACILITY) REFRESH
```

- If your system's environment is set up for program control, the load module BLDUXTID in SYS1.MIGLIB needs to be program controlled. The following example shows how you can enable program control for load module BLSUXTID.

**Example:**

```
RDEFINE PROGRAM BLSUXTID
RALT PROGRAM BLSUXTID ADDMEM('SYS1.MIGLIB'/'*****'/NOPADCHK) +
UACC(READ)
SETROPTS WHEN(PROGRAM) REFRESH
```

A complete example for the security setup required by the CIM provider for class IBMzOS\_WLM is provided in the z/OS CIM sample security setup job CFZSEC, step ENWLM.

More information:

Chapter 15, “WLM classes,” on page 277

“Step ENWLM” on page 350

---

## Setting up the CIM server for storage management

- Starting with z/OS 1.13, the IOS services IOSCDR and IOSCHPD have been extended to facilitate the retrieval of the world wide port number (WWPN) for the Initiator (IOSCHPD) and Target (IOSCDR) protocol endpoints of IBMzOS\_SBProtocolEndPoint. The retrieval of the WWPN through IOSCDR is only possible under the following conditions:
  1. The used hardware is at least an IBM System z10™.
  2. The requestor or CIM client has UPDATE access to the IOSCDR profile in the FACILITY class.

**Example:**

```
SETROPTS CLASSACT(FACILITY) RAclist(FACILITY) GENERIC(FACILITY)

RDEFINE FACILITY IOSCDR UACC(NONE)
PERMIT IOSCDR CL(FACILITY) ID(CFZUSRGP) ACCESS(UPDATE)

SETROPTS RAclist(FACILITY) REFRESH
```

- The SMI-S CIM life cycle indications are using the Common Event Adapter (CEA) to be notified for device path changes and insertions or deletions of FICON® channel ports.

The following setup has to be done to grant the CIM server access to CEA for the retrieval of events and IOS information:

1. Ensure that the CEA is running in full function mode.

- Grant the CIM server user ID UPDATE access to the IOSCDR profile in the FACILITY class.

**Example:**

```
SETROPTS CLASSACT(FACILITY) RACLIST(FACILITY) GENERIC(FACILITY)

RDEFINE FACILITY IOSCDR UACC(NONE)
PERMIT IOSCDR CL(FACILITY) ID(CFZSRV) ACCESS(UPDATE)

SETROPTS RACLIST(FACILITY) REFRESH
```

- The SMI-S CIM life cycle indications are using CEA to be notified of device path changes and insertions or deletions of FICON channel ports. Event notification from CEA is protected through the following profiles in the RACF class SERVAUTH:

- CEA.CONNECT
- CEA.SUBSCRIBE.ENF\_0009\*
- CEA.SUBSCRIBE.ENF\_0027\*
- CEA.SUBSCRIBE.ENF\_0033\*

To be permitted to subscribe for event notification by CEA the CIM server user ID requires READ access to these mentioned profiles. To keep your security setup simpler it is recommend to protect the CEA resources using the generic profile CEA.\* instead of defining the several discrete profiles.

Grant the CIM server user ID READ access to the generic profile CEA.\* in RACF class SERVAUTH:

**Example:**

```
SETROPTS CLASSACT(SERVAUTH) RACLIST(SERVAUTH) GENERIC(SERVAUTH)
RDEFINE SERVAUTH CEA.* UACC(NONE)
PERMIT CEA.* CLASS(SERVAUTH) ID(CFZSRV) ACCESS(READ)
SETROPTS RACLIST(SERVAUTH) REFRESH
```

- Starting with z/OS 2.1, the CIM classes IBMzOS\_FCPort and IBMzOS\_FCCUPort are enabled to decommission and recommission ports, and to assign a WWN to a port. To grant the use of this functionality, ensure that:
  - The requestor or CIM client has UPDATE access to the IOSPORTS profile in the FACILITY class.

**Example:**

```
SETROPTS CLASSACT(FACILITY) RACLIST(FACILITY) GENERIC(FACILITY)

RDEFINE FACILITY IOSPORTS UACC(NONE)
PERMIT IOSPORTS CL(FACILITY) ID(CFZUSRGP) ACCESS(UPDATE)

SETROPTS RACLIST(FACILITY) REFRESH
```

---

## Running providers in a designated user context

Generally, the vendor of a provider (implementing a certain CIM class) defines if a provider should run under a designated user context and also supplies the according documentation describing the specific setup steps.

When an invocation is caused by an external CIM operation, by default the provider is processed in the context of the *requestor's user ID*. As the provider runs under the identity of the requestor's user ID, all resource access authorization occurs against this user ID. So the requestor must be authorized for all resources that a provider accesses during a request.

To avoid that a CIM client user ID needs global access to all the resources that a provider uses for gathering data, a provider can be registered with a *designated user ID*. The designated user ID specifies a separate security context which is used to process the provider. The designated user ID must be authorized to access all the resources accessed by the provider. Instead of directly using a requestor's user ID when accessing the resource, the provider code now has to perform custom authorization checks based on the requestor's user ID, to prevent unauthorized access to resources. The security definitions for the designated user ID should be similar to those of regular client users, as described in "Switching identity (surrogate)" on page 29, but it is recommend to make the designated user ID a protected user ID by disabling password, passphrase and oidcard.

**Example:**

```
ALTUSER <designated-user-ID> NOPASSWORD NOOIDCARD NOPHRASE
```

The properties *UserContext* and *DesignatedUserContext* of CIM class *PG\_ProviderModule* specify the provider's processing context. You can specify the values for these properties in the provider registration MOF file for each provider module. By default, it is installed at `/usr/lpp/wbem/provider/schemas/...` For further details, see "PG\_ProviderModule" on page 297.

---

## Utilizing the provider based authorization model

When the provider based authorization model is enabled for a provider, a provider-specific profile in SAF class *WBEM* restricts the access to the provider. In this case, the requesting user ID needs special authorization before it can invoke the provider. These checks are strongly recommended for providers which use a designated user ID.

Each CIM operation needs, depending on its type, a different level of access to the security profile. For example, in order to access CIM operations that change the states of objects, *WRITE* access to the SAF profile defined for a provider is required. Schema manipulation is only available to users with *CONTROL* access to SAF profile *CIMSERV* in class *WBEM*.

You can define provider based authorization by relating a SAF profile in class *WBEM* to a single provider library. The specific SAF requirements of the provider should be documented. Unless instructed to do so, there is no need to take any configuration action for this.

To correlate a provider and a SAF profile, define a security access profile. The *OpenPegasus* CIM class *PG\_Provider* contains a string type attribute named *SecurityAccessProfile*. Providers that register with an instance of class *PG\_Provider* containing the *SecurityAccessProfile* property, must specify their SAF profile with this property in order to define it to the system. In addition, requesting users must have the according level of authorization for the named profile.

If you want to have an existing provider exploit this feature,

1. remove (unregister) the provider using the cimprovider utility
2. add the security profile name in property *SecurityAccessProfile* in the provider registration MOF file
3. register the provider again

The existence of a specified security profile is not checked during provider registration, but during runtime, when a request is received for the according provider.

More information:

- Table 2 on page 28 lists the type of access required for the different types of CIM operations
- “cimprovider” on page 85
- “Registering a provider with the CIM server” on page 293
- “PG\_Provider” on page 296

---

## Chapter 8. Customization

This chapter describes the customization tasks you should consider before you start the CIM server for the first time:

1. Make sure that the CIM server can use the configured HTTP and HTTPS ports (usually, port numbers 5988 and 5989)  
(see “Configuring the ports for the CIM server”).
2. If you have installed z/OS CIM for the very first time, ensure that CFZRCUST has been customized during CIM server setup. If you have not already done so, it is now time to customize CFZRCUST  
(see “Customizing CFZRCUST” on page 46).
3. Ensure that you have run CFZRCUST during CIM server setup. If you have not already done so, it is now time to run CFZRCUST.
4. Customize the CIM server startup  
(see “Customizing the CIM server startup” on page 50).
5. Customize the UNIX System Services shell to be able to run CIM server commands  
(see “Customizing the UNIX System Services shell” on page 51).
6. Customize the environment variables  
(see “Setting the CIM server environment variables” on page 51).
7. Select a WLM service class for z/OS CIM priority  
(see “Selecting a WLM service class for z/OS CIM priority” on page 54).

---

### Configuring the ports for the CIM server

Ensure that the CIM server can use the default port 5988 for HTTP or 5989 for HTTPS. You can change the default values for the ports using the *httpPort* and *httpsPort* CIM server configuration properties.

When the CIM server cannot listen to one of the ports, the CIM server startup will fail. Then check if another server is listening to the ports, your security product is protecting the ports, or the ports are blocked by the TCP/IP configuration.

- To identify your currently configured port for HTTP and HTTPS, see the configuration properties *httpPort* and *httpsPort* as described in Chapter 9, “CIM server configuration,” on page 55.
- To determine if the port has been reserved, verify that the port specified for the *httpPort* configuration property is not included in the range of reserved ports specified in the BPX parmlib member's INADDRANYPORT and INADDRANYCOUNT parameters.
- Use the TCP/IP NETSTAT ALLCONN PORT command to check for servers using the specified ports.

**Example:**

```
TSO NETSTAT ALLCONN (PORT 5988
```

- Your security product may also need to be configured to allow access to the HTTP port. For example, OEM security product ACF2 may require "Stack & Port security authorization" for the CIM server.

Please refer to your security product's documentation for additional information.

- The TCP/IP PORT and PORTRANGE statements in the TCP/IP profile may be used to make the configured HTTP port available for the CIM server's use.

For more information, refer to *z/OS Communications Server: IP Configuration Reference*, chapter "TCP/IP profile (PROFILE.TCPIP) and configuration statements".

---

## Customizing CFZRCUST

The job CFZRCUST installs and migrates the z/OS CIM server configuration and repository on each target machine. A sample of CFZRCUST is shipped with the default SAMPLIB.

If you have installed z/OS CIM for the first time, you need to customize CFZRCUST.

### Prerequisites

- 1. The target system is running with configured UNIX System Services.
- 2. The CIM server is stopped.
- 3. The user running this job
  - must either have UNIX user ID 0
  - or must be able to copy files and set the program control bit on files.
- 4. If you intend to mount the data set on a separate file system - which is recommended - this user must be entitled to allocate a 100 MB zFS data set (if not yet allocated), and must be authorized to mount file systems.

Now you have to adjust the sample job CFZRCUST, which is located in the SAMPLIB, to fit your environment. There are two options you can choose; it depends on whether you want to place the CIM server repository and the log files in a separate file system or not.

### Option 1: Placing /var/wbem in a separate file system

To place the CIM server repository and the log files in a separate file system, perform the following steps. For a better maintainability, it is recommended to mount a separate file system on */var/wbem* for the CIM server's data repository. The recommended size is 100 MB.

- 1. Adjust the job card.
- 2. Adjust STEP 1 of the JCL to create a file system data set. Choose this step to create a data set. You must provide the name in the JCL for further processing the selected sample job.

As an alternative, you can also create the file system outside of this JCL.

**STEP 1** is a sample to allocate a zFS file system dataset:

### JCL - sample STEP 1

```

//*****
//* STEP 1 - Create zFS DataSet for /var/wbem */
//*****
//DEFZFS EXEC PGM=IDCAMS
//SYSPRINT DD SYSOUT=*
//DASD0 DD DISP=(NEW,CATLG),UNIT=unit,VOL=SER=volser
//SYSIN DD *
DEFINE CLUSTER( -
  NAME(%CFZVARWBEMDS%) -
  VOLUMES(volser) -
  STORAGECLASS(OMVS) -
  LINEAR -
  CYLINDER(150 15) -
  SHAREOPTIONS(3) -
)
//FRMZFS EXEC PGM=IOEAGFMT,REGION=0M,
// PARM=(' -aggregate %CFZVARWBEMDS% -compat ')
//SYSPRINT DD SYSOUT=*
//STDOUT DD SYSOUT=*
//SYSPRINT DD SYSOUT=*
//SYSPRINT DD SYSOUT=*

```

- \_\_\_ 3. If you are using an extensible file system, you can suppress the check for enough free space by specifying the parameter `-noSpaceCheck` in the installation/migration utility at STEP 2 of the JCL. The system administrator is responsible to ensure that there is enough free space (60 MB) available for installation or migration, otherwise the job will fail. This will not suppress the check if you use a separate file system data set.

The beginning of STEP 2 will then look like:

### JCL - sample STEP 2

```

//*****
//* STEP 2 - Run customization/migration utility */
//*****
//CFZRCUST EXEC PGM=BPXBATCH,TIME=NOLIMIT,REGION=0M,
// PARM='PGM /usr/lpp/wbem/install/CFZRCUST.sh -noSpaceCheck'
//*

```

- \_\_\_ 4. Replace the place holder `%CFZVARWBEMDS%` in the JCL with the name of the file system data set, for example: `OMVS.VARWBEM.ZFS`.

When you have submitted the job, a return code (MAXACC) 0 or 4 indicates a successful installation or migration. If the return code is 12, look at the job output, correct the error and submit the job again.

- \_\_\_ 5. To mount the file system for the CIM server's data repository, you can add a mount statement in your BPXPRMxx PARMLIB member:

### Mount statement:

```

MOUNT FILESYSTEM(OMVS.VARWBEM.ZFS)
      TYPE(ZFS)
      MOUNTPOINT('/var/wbem')
      MODE(RDWR)

```

**Note:**

Please see also "Considerations for customizing CIM Server in a z/OS Sysplex" on page 49

## Option 2: Using an existing file system for /var/wbem

To use an existing file system for the CIM server repository and the log files, perform the following steps:

- \_\_\_ 1. Adjust the job card.
- \_\_\_ 2. Omit STEP 1 of the sample job and specify the parameter -noDS in the installation/migration utility at STEP 2 of the JCL.-noDS disables the use of a separate file system dataset for /var/wbem.

```

JCL - sample STEP 2
//*****
//* STEP 2 - Run customization/migration utility      */
//*****
//CFZRCUST EXEC PGM=BPXBATCH,TIME=NOLIMIT,REGION=0M,
//          PARM='PGM /usr/lpp/wbem/install/CFZRCUST.sh -noDS'
//*

```

- \_\_\_ 3. If you are using an extensible file system, you can suppress the check for enough free space by specifying the parameter -noSpaceCheck in the installation/migration utility at STEP 2 of the JCL. The system administrator is responsible to ensure that there is enough free space (60 MB) available for installation/migration, otherwise the job will fail. This will not suppress the check if you use a separate file system data set.

When you have submitted the job, a return code (MAXACC) 0 or 4 indicates a successful installation or migration. If the return code is 12, look at the job output, correct the error and submit the job again.

## System specific directories

After successfully running CFZRCUST, the following files are located on your system:

Table 4. Installation directories for z/OS CIM

Directory	Description	Owner	Access
/etc/wbem	This directory is system specific and used by the CIM server to store its configuration files and environment for the started task. It has to be owned and writable by the CIM server user (e.g. CFZSRV)	CIM server user	rwxr-xr-x
/var/wbem	This directory is system specific. The CIM server uses it to store its data repository for CIM classes and instances as well as for various files used at runtime, such as the special file required for connecting to the CIM server through UNIX Domain Sockets (cimxml.socket). This directory has to be owned by the CIM server user and only the CIM server user must have write access to it.	CIM server user	rwxr-xr-x



Table 4. Installation directories for z/OS CIM (continued)

Directory	Description	Owner	Access
/var/wbem/ logs	Used by the CIM server to log the stdout and stderr output when running as a started task. See “Customizing the started task procedure CFZCIM” on page 50 for details.	CIM server user	rwxr-xr-x

If the CIM server user ID is not privileged (UID ≠ 0), ensure that the directories */etc/wbem* and */var/wbem* are owned by this user ID.

The following example shows how to change ownership:

**Example:**

```
chown -R <Server UserID>:<Server GroupID> /etc/wbem
chown -R <Server UserID>:<Server GroupID> /var/wbem
```

## Considerations for customizing CIM Server in a z/OS Sysplex

There are additional considerations when the CIM server is installed on z/OS images in a Parallel Sysplex that utilizes shared HFS for Unix System Services. When installing CIM on a z/OS image in a shared HFS configuration, we recommend that the CFZRCUST configuration job be run on the specific system where CIM is being installed. By running the configuration job on the target system, the new CIM configuration filesystem and the */var/wbem* directory that is created by the configuration job, will automatically inherit the system unique directory for that specific system.

Unix System Services on each z/OS image, in a shared HFS configuration, has its own filesystem for the */var* directory since this directory must be unique per system. In such a configuration, the directory mountpoint for */var/wbem* will have an additional directory for the system name. For a system named SYSA, the mountpoint would resolve to be */SYSA/var/wbem*.

Another consideration is when adding the new filesystem mount to your parmlib member BPXPRMxx. The attribute UNMOUNT is needed to prevent the system owner of the system unique CIM configuration filesystem from being “automoved” to another active system in the sysplex. When a z/OS image is not active in the sysplex, filesystem mounts that are unique to the image should be unmounted and not “automoved” to another active member in the sysplex.

When updating the BPXPRMxx member to add the new filesystem mount, if you have CIM server installed on all your systems in the sysplex and utilize a common BPXPRMxx member, the directory mountpoint for the CIM filesystem would be:

```
MOUNTPOINT(' /&SYSNAME./var/wbem' ) .
```

For additional information on Shared HFS in Unix System Services, please refer to the manual *z/OS UNIX System Services Planning*.

---

## Customizing the CIM server startup

There are two ways to start the CIM server:

- either from the started task procedure CFZCIM (recommended)
- or from a UNIX System Services shell.

**If you want to start the CIM server as started task,**

- Customize the JCL procedure CFZCIM and the according environment variable file `/etc/wbem/cimserver.env`.  
“Customizing the started task procedure CFZCIM” describes how to perform these steps.

**If you want to start the CIM server from a UNIX System Services shell or a remote UNIX session (telnet, SSH),**

- Customize the UNIX System Services shell  
(see “Customizing the UNIX System Services shell” on page 51)
- Set the environment variable `_BPX_JOBNAME` to CFZCIM

## Customizing the started task procedure CFZCIM

You can start the CIM server via started task procedure CFZCIM. A sample of CFZCIM is shipped with the default PROCLIB.

To customize CFZCIM,

- Include CFZCIM in your PROCLIB concatenation.
- When you use the default installation directory `/usr/lpp/wbem`, you need not modify CFZCIM or `cimserver.env`. Else, you need to customize the procedure in the DD statements and also update the `cimserver.env` file installed in `/etc/wbem` to match the correct installation paths for the CIM server.
- The DDNAMEs `STDOUT` and `STDERR` in path `/var/wbem/logs` are used to redirect the output from the console into the UNIX file system files `cimserver.out` and `cimserver.err`. When the started task is ended, job steps two and three copy the console output to the JCL job log.
- The DDNAME `STDENV` points to the hierarchical file system file containing environment variables required to run the CIM server. For running the CIM server as a started task, the environment variables are set in file `cimserver.env` located in the `/etc/wbem` hierarchical file system directory. See “Setting the CIM server environment variables” on page 51 for details on how to set environment variables for the z/OS CIM server.
- To run the CIM server with a user ID for which the security setup has been completed, either set up the `STARTED` class or use the started procedures table (ICHRIN03).

For further details refer to *z/OS Security Server RACF Security Administrator's Guide*, chapter "Assigning RACF User IDs to Started Procedures".

Example of the RACF commands required to set up the CIM server for the `STARTED` class:

**Example:**

```
SETROPTS RACLIST(STARTED)
RDEFINE STARTED CFZCIM.* STDATA(USER(CFZSRV) GROUP(CFZSRVGP))
SETROPTS RACLIST(STARTED) REFRESH
```

---

## Customizing the UNIX System Services shell

You need to customize the UNIX System Services shell, not only if you want to start the CIM server from here.

All commands of the z/OS CIM server are UNIX style programs running in a UNIX System Services shell and executing in the Enhanced ASCII mode. This means that all string data is represented in ASCII rather than in EBCDIC encoding. To be able to execute z/OS CIM server commands, a UNIX System services shell has to be started and the environment has to be set up to enable automated ASCII-EBCDIC translation and to find the necessary libraries and executables.

There are two ways to set up a shell for CIM server commands:

- In the UNIX System Services, or
- Using BPXBATCH in a JCL job

### Setting up a shell in the UNIX System Services:

The file `/usr/lpp/wbem/install/profile.add` contains the basic settings to enable z/OS CIM server commands. You can add the contents of `profile.add` to `/etc/profile` to set up the z/OS CIM server environment for all users of the UNIX System Services shell or to the individual profile in the home path of each user who wants to use the commands.

### Setting up a shell using BPXBATCH in a JCL job:

Use the utility BPXBATCH to run CIM server commands using a JCL job.

#### Example to run the cimivp utility:

```
//STEP1 EXEC PGM=BPXBATCH,TIME=NOLIMIT,REGION=0M,  
//      PARM='PGM /usr/lpp/wbem/bin/cimivp 127.0.0.1'  
//STDENV DD PATH='/etc/wbem/cimserver.env'  
//STDOUT DD SYSOUT=*  
//STDERR DD SYSOUT=*  
//CEEDUMP DD SYSOUT=*  
//SYSPRINT DD SYSOUT=*  
//SYSUDUMP DD SYSOUT=*  
//SYSMDUMP DD SYSOUT=*
```

The file `/etc/wbem/cimserver.env` contains the basic settings for the BPXBATCH environment. You can find an alternative example for the usage of BPXBATCH in job CFZRCUST in `SYS1.SAMPLIB`.

More information:

See “Setting the CIM server environment variables” for details on CIM server specific environment variables.

See *z/OS UNIX System Services User's Guide* for details on the BPXBATCH utility.

---

## Setting the CIM server environment variables

Environment variables are set in file `cimserver.env`, if the CIM server runs as started task. If you use the CIM server from the UNIX System Services command prompt, the environment variables are set in UNIX System Services `.profile` in the home path of the user ID which starts the CIM server.

Setting the trace variables is not required for normal operation.

Note that changes to the environment variables become effective only after a restart of the CIM server.

The environment variable file `cimserver.env` is located in the hierarchical file system at `/etc/wbem/`. After installation, you can still find the originally shipped version in `/usr/lpp/wbem/`. The default environment variable file `profile.add` to customize the shell is located in `/usr/lpp/wbem/install`.

UNIX

**Set the following environment variables contained in this file to start the CIM server:**

#### **\_CEE\_RUNOPTS**

Customized to fit the Language Environment® to the CIM server and tools need. Automatic text conversion for untagged UNIX(R) files system files enabled and automatic tagging activated.

This setting is related to the ASCII-EBCDIC conversion. See “Converting data to ASCII, EBCDIC and UTF-8” on page 292.

It is also adjusted for optimized initial memory and stack settings of the Language Environment. For the proposed default value of this variable, please look at `/usr/lpp/wbem/cimserver.env` or `/usr/lpp/wbem/install/profile.add`. A more detailed description of the values for this environment variable you will find in book *z/OS Language Environment Customization*.

**Note:** The recommended default settings of `_CEE_RUNOPTS` can interfere with other programs.

#### **\_BPX\_SHAREAS**

The default value is NO. It ensures that the CIM server run-time environment runs in a "clean" address space.

#### **\_BPXK\_AUTOCVT**

The default value is ON. Activates automatic text conversion of tagged UNIX(R) file system files.

This setting is related to the ASCII-EBCDIC conversion. See “Converting data to ASCII, EBCDIC and UTF-8” on page 292.

#### **\_TAG\_REDIR\_ERR**

#### **\_TAG\_REDIR\_IN**

#### **\_TAG\_REDIR\_OUT**

The default value is TXT. Enables tagging of tcsh shell's `stdin`, `stdout`, or `stderr` redirection based on the existing file tags.

For additional information refer to the *z/OS UNIX System Services Command Reference* book.

#### **PEGASUS\_HOME**

Must be set to the hierarchical file system directory where the CIM server is installed. By default this is `/usr/lpp/wbem`.

#### **LIBPATH**

Must include the CIM server's lib and provider hierarchical file system directory paths. By default this is set to

`/usr/lpp/wbem/lib:/usr/lpp/wbem/provider:/usr/lib`

**OSBASE\_TRACE**

Defines the trace level for the z/OS OS management CIM instrumentation. Valid values range from 0 through 4, where 4 provides the most details.

**OSBASE\_TRACE\_FILE**

Defines the filename for the z/OS CIM instrumentation traces.

**PATH** Only for running the CIM server or any of the CIM server command-line utilities in UNIX System Services. Must include the CIM server's bin hierarchical file system directory path so that the CIM server's executable programs are automatically found when you enter the according command at the UNIX System Services command prompt. By default this is set to */usr/lpp/wbem/bin*.

The following variables starting with RMF\_ only apply when RMF is installed and you use the RMF monitoring providers:

**RMF\_CIM\_PROVIDER**

Used to control the behavior of the RMF CIM providers when RMF is installed. By default, the RMF CIM provider is enabled. To disable the RMF CIM provider, set the environment variable `RMF_CIM_PROVIDER=DISABLE`.

**RMF\_CIM\_HOST**

Defines the target TCP/IP address or hostname of the z/OS MVS image on which the DDS responsible for this system is running. Beginning with z/OS 1.11 the use of this environment variable is no longer required, but it will be used if defined. If omitted, the CIM monitoring providers can automatically locate an active RMF DDS in the sysplex, provided all systems in the sysplex run z/OS 1.10 or higher.

**RMF\_CIM\_PORT**

Defines the TCP/IP port number of the DDS (default: 8803). Starting with z/OS 1.11 no longer required, but used when defined.

**RMF\_CIM\_TRACE**

Defines the trace level of the RMF CIM provider. Valid values range from 0 through 4, with 0 providing no trace and 4 providing all information possible.

**RMF\_CIM\_TRACE\_FILE**

Defines the file name for storing the trace data for the z/OS RMF CIM instrumentation.

**RMF\_CIM\_BENCH**

Is used for performance benchmarks, for example, to identify the response time of the underlying RMF infrastructure. If this variable is set to 1, the RMF CIM provider will print some benchmarking information about various RMF operations, suitable for RMF development.

The following variables starting with WLM\_ only apply when Workload Manager (WLM) is installed and you use the WLM providers:

**WLM\_CIMPROVIDER\_TRACE\_FILE**

Defines the output file name for z/OS WLM provider traces. The default trace file is */var/wlmprovider.trc*.

**WLM\_CIMPROVIDER\_TRACE\_LEVEL**

Defines the trace level for the z/OS WLM provider. Valid values range from 0 through 5, where 5 provides the most details. The default is 0, meaning that no trace is written.

---

## Selecting a WLM service class for z/OS CIM priority

If you plan to use the z/OS CIM server as part of your monitoring or management infrastructure, it should run at a priority higher than the work to be managed. You should classify the CIM server into a single period service class with a velocity goal at an appropriate importance level.

---

## Chapter 9. CIM server configuration

Configuration properties are used to control the behavior of the CIM server. The default configuration setting for the CIM server works for the majority of environments. Table 5 describes the configuration properties.

You can display or change the configuration settings using

- the `cimconfig` UNIX System Services command
- or the `MODIFY` console command

Column "dynamic Y/N" indicates if a configuration property is dynamic or not.

- Dynamic configuration properties can be changed while the CIM server is running.
- For those properties which you cannot dynamically change, use
  - either the `-p` parameter of the `cimconfig` command,
  - or the `PLANNED` option of the `MODIFY` command.

to indicate your change. Then stop and restart the CIM server.

More information:

“`cimconfig`” on page 83

“`MODIFY` console command” on page 117

“Changing current configuration properties” on page 67

“Changing planned configuration properties” on page 67

Table 5. CIM server configuration properties

Property name	Description	Default value	dynamic Y/N
<code>daemon</code>	The foreground/background process property. Set <code>daemon</code> to 'false' to run the CIM server as foreground process or as a started task.	true  For running the CIM server as a started task, this option is set to 'false'.	N
<code>enableAuditLog</code>	When this option is set to true, the CIM server is writing SMF records 86. For details see “Audit logging with SMF record 86” on page 73.	false	Y
<code>enableHttpConnection</code>	The HTTP connection to the CIM server. Enables and disables connections to the CIM server over HTTP. When turned off only local connections are accepted.	true	N

Table 5. CIM server configuration properties (continued)

Property name	Description	Default value	dynamic Y/N
enableHttpsConnection	The HTTPS connection to the CIM server. Enables and disables secure connections to the CIM server via HTTPS. Note that it is not sufficient to turn on this option, but you must also enable an SSL connection through the AT-TLS feature at the z/OS Communications Server as described in “Configuring the CIM server HTTPS connection using AT-TLS” on page 29. <b>Note:</b> When set to true, ensure that the configured <i>httpsPort</i> can be used by the CIM server.	false	N
enableIndicationService	'true' means the indication service is enabled. 'false' will disable the indication service.	true	Y
enableRemotePrivileged UserAccess	The remote privilege for users. Enables and disables remote access for users with UID 0.	false	N
forceProviderProcesses	When this option is set to 'true', providers will run in one or more separate address spaces. For details see “Running providers in separate address spaces” on page 66.  This option is ignored when MLS support is activated. The out-of-process provider support uses then one address space per security label for full protection of classified documents and information.	false	N
httpPort	The port to listen for HTTP requests. It is recommended not to change this value. <b>Note:</b> Make sure that the configured <i>httpPort</i> can be used by the CIM server.	5988	N
httpsPort	The port to listen for HTTPS requests. AT-TLS should be configured to use this port. It is not recommended to change this value. This value is only active if <i>enableHttpsConnection</i> is set to true. <b>Note:</b> Make sure that the configured <i>httpsPort</i> can be used by the CIM server.	5989	N
idleConnectionTimeout	The timeout value in seconds that the CIM server uses to wait for idle client connections to close.  A client connection is considered as idle when it is not in the process of sending a request and when the CIM server is not processing a request from that connection.  If the value is set to 0, no timeout is used.	0	Y
logLevel	The detail level for logging. Possible values are INFORMATION, WARNING, SEVERE, FATAL, or TRACE (see also “Logging” on page 71).	INFORMATION	Y



Table 5. CIM server configuration properties (continued)

Property name	Description	Default value	dynamic Y/N
maxFailedProviderModuleRestarts	The number of times a failed provider module with indications enabled is restarted automatically before it is moved to the state Degraded.  If this value is zero, the failed provider module is moved to the state Degraded immediately.	3	Y
maxIndicationDelivery RetryAttempts	If set to a positive integer, this value defines the number of times that the indication service will try to deliver an indication to a particular listener destination. This does not effect the original delivery attempt, thus if set to 0, the CIM server will only try to deliver the indication once.	3	Y
maxProviderProcesses	The maximum number of separate address spaces for running providers. Only in effect if <i>forceProviderProcesses</i> is set to TRUE. If the value is set to 0, the number is unlimited.	0	Y
messageDir	The message bundle directory. Do not change the default.	msg	N
minIndicationDelivery RetryInterval	If set to a positive integer, this value defines the minimal time interval in seconds for the indication service to wait before retrying to deliver an indication to a listener destination that previously failed. The CIM server may take longer due to Quality of Service or other processing.	30	Y
providerDir	The name of the directory where the provider libraries reside. You can specify multiple directories here, separated by a colon (:). Provide the full path for all directories when changing the default.  Since the CIM server has its own set of providers, its lib directory always needs to be present in the list of provider directories. When adding new provider directories, it is also recommended to update the LIBPATH environment variable according to the new values of providerDir. This is required, because a provider may need other supplemental dynamic load libraries, which the CIM server is not aware of and therefore would otherwise fail to load.	lib:provider	Y
repositoryDir	The name of the directory for the repository.	/var/wbem/ repository	N
repositoryIs DefaultInstanceProvider	The CIM server repository serves as the default provider for CIM instances when no dynamic provider has been registered for a CIM class.	true	N

Table 5. CIM server configuration properties (continued)

Property name	Description	Default value	dynamic Y/N
shutdownTimeout	The timeout value in seconds that the CIM server uses to wait for the shutdown process to complete. This value includes terminating active providers.	30	Y
slp	The CIM server uses the SLP Protocol to announce itself over the network.	false	N
socketWriteTimeout	The timeout value in seconds that the CIM server uses to wait for a client to receive data from the socket. After the timeout the CIM server will close the socket.	20	Y
traceComponents	This option specifies the component(s) that you want to trace. The value ALL enables tracing for all components.  For more information refer to section "Tracing" on page 68, which also lists the valid components.	All	Y
traceFacility	This option specifies the trace destination.  <b>FILE</b> saves the tracing messages to the file specified in <i>traceFilePath</i>  <b>LOG</b> saves the tracing messages to the logging facility, if <i>logLevel</i> is set to TRACE (see "Logging" on page 71). This alternative combines the tracing message stream with the log messages.  <b>MEMORY</b> saves tracing messages in a wrap around memory buffer. This buffer is included in memory dumps.  Specify the size of the allocated memory with the <i>traceMemoryBufferKbytes</i> property.	Memory	Y
traceFilePath	This property specifies the fully qualified file which saves the trace data.	/tmp/cimserver.trc	Y

Table 5. CIM server configuration properties (continued)

Property name	Description	Default value	dynamic Y/N
traceLevel	<p>Switches tracing on or off, and sets the trace level of detail. Choose one of the following trace levels:</p> <p><b>0</b> Tracing is off</p> <p><b>1</b> Severe errors</p> <p><b>2</b> Warning level error messages</p> <p><b>3</b> Inter-function logic flow, medium data detail</p> <p><b>4</b> High data detail</p> <p><b>5</b> High data detail, method enter and exit</p> <p><b>Note:</b> This does not include tracing for the providers. See also “Tracing” on page 68.</p>	2	Y
traceMemoryBufferKbytes	<p>Specifies the size of the memory area which is reserved for tracing messages in kB (1kB=1024B). The value must be at least 16.</p> <p>This value only becomes valid when <i>traceFacility</i>=MEMORY.</p>	10240	N



---

## Chapter 10. Setup verification

After performing the customization actions, you can start the CIM server as described in “Step 4: Starting the CIM server” on page 21 and run the sample application CIMIVP delivered with the product as an installation verification program.

The client application CIMIVP is delivered as executable with the product in file `/usr/lpp/wbem/bin/cimivp`. It displays some of the information about the z/OS system which is available through CIM.

You invoke this program as job CFZIVP contained in SYS1.SAMPLIB or from the UNIX System Services command line as `cimivp`.

On successful completion, it generates an output similar to the one shown hereafter.

```
cimivp Main started ...
Connecting to local CIM Server ...
... success
> Found Computer System : BOECFZ1.boeblingen.de.ibm.com (CPUID: 1A0B822097,
  VMGuestID: CFZ1)
> Found Operating System : CFZ1 (Version: 02.01.00, Sysplex: CFZ1PLEX,
  FreeMem: 2371188)
> Number of active UNIX System Services processes: 25
> Number of active address spaces: 98
> Number of FC ports: 25
> Number of online processors: CP(1) zAAP(0) zIIP(0)
> Number of configured disk volumes: 10984
cimivp - All tests completed successfully.
```

If the execution of `cimivp` times out, this may be caused by a slow IP hostname resolution or a large amount of managed resources, like for example disks. To override the default timeout, you can set the environment variable `CIM_IVP_TIMEOUT` to the amount of seconds that `cimivp` should wait for a response from the CIM server before it fails with a timeout. When you run `cimivp` by submitting the CIMIVP sample job, you can add the `CIM_IVP_TIMEOUT` variable to file `/etc/wbem/cimserver.env` like this:

```
CIM_IVP_TIMEOUT=300
```

This sets the timeout for `cimivp` to 5 minutes.



---

## **Part 3. Administration and operation**





---

## Chapter 11. CIM server administration

While you must set up the CIM server only once to make it ready to use, you can configure your CIM server environment as often as you want during operation to best meet your requirements. The CIM server provides the ability to set a number of configuration options. Many tasks and operations for the CIM server are performed under z/OS UNIX System Services, ideally within a telnet session.

More information:

- To configure the CIM server, you can use the commands described in Chapter 12, “CIM server command-line utilities and console commands,” on page 79.
- To use the command line tools, be sure that you have set up the UNIX System Services environment as described in “Customizing the UNIX System Services shell” on page 51.
- If you run into problems while setting up or using the CIM server you can find information for problem solving in “Appendix A. Troubleshooting” on page 337.

---

### Starting and stopping the CIM server

Start the CIM server either as a started task or from the UNIX System Services command prompt, as described in the following sections.

#### Running the CIM server as started task

The standard way to start the CIM server on z/OS is through the started task CFZCIM.

##### Before the first start:

- Make sure that you have customized the procedure CFZCIM and `cimserver.env` before you start the CIM server for the first time as described in “Customizing the started task procedure CFZCIM” on page 50 and “Setting the CIM server environment variables” on page 51.

##### Starting the CIM server:

- Enter the following command from the z/OS console:  
S(TART) CFZCIM

##### Verifying a successful start:

- After a successful start of the CIM server, the following message is shown on the console and issued to the syslog:  
CFZ10030I: Started CIM server version 2.11 for z/OS.

##### Stopping the CIM server:

- When the CIM server was started through CFZCIM, you can also stop it from the console by entering  
(STO)P CFZCIM

## Running the CIM server from the UNIX System Services command prompt

### Before the first start:

- Make sure you have completed the configuration steps described in “Customizing the UNIX System Services shell” on page 51.
- Ensure that you have set the environment variable `_BPX_SHAREAS` to `NO` in your z/OS UNIX System Services shell to run the CIM server runtime environment in its own address space.

### Starting the CIM server:

- Type the `cimserver` command at the command prompt of a z/OS UNIX System Services shell.

### Verifying a successful start:

- After a successful start of the CIM server, the following message is shown on the console and issued to the syslog:  
CFZ10030I: Started CIM server version 2.11 for z/OS.

### Stopping the CIM server:

- At the command line, enter: `cimserver -s`

---

## Running providers in separate address spaces

In a conventional CIM server setup, all providers are processed in the CIM server's address space. Only when the CIM server is running in a *multi level secured (MLS)* z/OS system, providers are executed in several provider agent processes depending on the user's security classification and port of entry, independent of the CIM server configuration.

If the CIM server is not running in an MLS system, you may want to run CIM providers in separate processes to protect the CIM server from failing CIM providers or to protect the CIM providers from each other. Rather than loading and calling CIM provider libraries directly within the CIM server process one or more provider agent processes are then started that will run the CIM provider code. In this case you can enable the *out-of-process support (OOP)* for providers. This is an enhanced version of the OpenPegasus out-of-process provider feature

### To turn on out-of-process support,

- Set the configuration property `forceProviderProcesses` to true.  
(See “Changing planned configuration properties” on page 67)

### If the Enhanced Security model is enabled (that is, the CIM server is not privileged),

- Grant the CIM server user ID READ access to the profile `BPX.JOBNAME` defined in the FACILITY class.  
This allows the CIM server to set the job name of the out-of-process agent to `CFZOOFA`.

**Example for the security product RACF:**

```
RDEFINE FACILITY BPX.JOBNAME UACC(NONE)
PERMIT BPX.JOBNAME CL(FACILITY) ACCESS(READ) ID(CFZSRV)
SETROPTS CLASSACT(FACILITY) RACLIST(FACILITY) REFRESH
```

where CFZSRV is the CIM server user ID.

When the out-of-process support is enabled, the z/OS-specific provider property *ShareAS* and the property *ModuleGroupName* for class *PG\_ProviderModule* are used. These properties specify whether a provider should run in its own address space, optionally grouped with other providers, or should be processed in the CIM server address space. They are set during provider registration via the registration MOF file. *ModuleGroupName* can also be set dynamically at runtime using the `-g` option of the `cimprovider` command.

---

## Changing current configuration properties

You can update the current configuration while the CIM server is running for dynamic properties.

Use the `cimconfig` UNIX System Services shell command or the `MODIFY` console command to dynamically change the current configuration properties of the CIM server.

Using the `cimconfig` command without the `-p` option or the `MODIFY` console command without the `PLANNED` option results in a non-permanent change. With a restart of the CIM server these changes are reset to the planned configuration values. For making permanent changes, change the planned configuration values.

More information:

Chapter 9, “CIM server configuration,” on page 55

“`cimconfig`” on page 83

“`MODIFY` console command” on page 117

---

## Changing planned configuration properties

To change the values of the planned configuration properties - these are the permanent values of configuration properties which are used at the CIM server startup - use

- the `cimconfig` UNIX System Services shell command with the `-p` option or
- the `MODIFY` console command with the `PLANNED` option.

The use of the `cimconfig` command is independent of whether the CIM server is running or stopped. If you change the planned configuration properties while the CIM server is running, those changes do not take effect until the CIM server is restarted. Then the planned configuration properties become the current configuration properties.

In order to use the `MODIFY` console command, the CIM server must be running. When you use the `MODIFY` console command with the `PLANNED` option, your changes do not take effect until the CIM server is restarted. Then the planned configuration properties become the current configuration properties.

More information:

Chapter 9, “CIM server configuration,” on page 55

“cimconfig” on page 83

“MODIFY console command” on page 117

---

## Tracing

### To enable or to modify tracing

use the `cimconfig` command or the `MODIFY` console command. You can modify the tracing configuration properties while the CIM server is running.

See also “`cimconfig`” on page 83 and “`MODIFY` console command” on page 117.

### You can modify the following tracing configuration properties:

#### *traceLevel*

turns tracing on and off and specifies the trace level. You can choose among the following trace levels:

0	Tracing is off
1	Severe errors
2	Warning level error messages (default)
3	Inter-function logic flow, medium data detail
4	High data detail
5	High data detail, method enter and exit

#### *traceComponents*

specifies the components that you want to trace.

You can choose one or more of the following components, separated by comma:

Component name	Component name
All	Authentication
Authorization	BinaryMessageHandler
CIMExportRequestDispatcher	CIMOMHandle
CMPIProvider	CMPIProviderInterface
Config	ControlProvider
CQL	DiscardedData
Dispatcher	ExportClient
Http	IndicationFormatter
IndicationGeneration	IndicationHandler
IndicationReceipt	IndicationService
Internal Provider	IPC
L10N	Listener
LogMessages	MessageQueueService
ObjectResolution	OsAbstraction
ProviderAgent	ProviderManager
Repository	Server
Shutdown	SSL
StatisticalData	Thread
UserManager	WsmServer
WQL	Xml

**Component name**  
XmlIO

**Component name**

The following components have a special purpose:

Special purpose trace components	Description
All	Traces all available components
DiscardedData	Issues a trace message when information is discarded or an operation is cancelled
LogMessages	Traces all messages written to the logging facility
StatisticalData	Prints statistical data to the trace at level 4
XmlIO	Prints the complete CIM-XML messages

*traceFacility*

specifies the destination of the trace messages.

**FILE**

saves the trace messages to the file specified in *traceFilePath*.

This file is continuously growing. You can remove it while the CIM server is running. It will be recreated automatically.

**LOG**

saves the trace messages to the logging facility, if the *logLevel* is set to TRACE (see "Logging" on page 71). This alternative combines the log messages and the trace messages to one message stream.

**MEMORY**

saves trace messages in a wrap around memory buffer. This buffer is included in memory dumps. (default).

To find the trace in a memory dump, the top of the allocated memory block is flagged with "PEGASUSMEMTRACE". The last trace message is flagged with the suffix "EOTRACE". The flags are encoded in ASCII.

Specify the size of the memory buffer with the static *traceMemoryBufferKbytes* property.

*traceFilePath*

if *traceFacility*=FILE, this property specifies the file which saves the trace data. The default is /tmp/cimserver.trc.

*traceMemoryBufferKbytes*

specifies the size of the memory area which is reserved for trace messages in kB (1kB=1024B). The default is 10240. The value must be at least 16. *traceMemoryBufferKbytes* is a planned configuration property (see "Changing planned configuration properties" on page 67).

This area is allocated when *traceFacility*=MEMORY.

**Tracing providers running out-of-process:**

When tracing is enabled in the CIM server, it is also enabled in the provider agent processes. For reasons of trace data integrity and regarding performance aspects, a separate trace file is used for each provider agent process.

Each provider agent is uniquely identified by the name of the shared provider agent executable. Each non-shared instance of a provider agent corresponds with a single provider module. This name is used as an extension to the trace file name specified by the *traceFilePath* configuration property. For example, if *traceFilePath* is defined as */tmp/cimserver.trc*, the non-shared provider agent for the *OperatingSystemModule* would direct its trace output to the file */tmp/cimserver.trc.OperatingSystemModule*.

#### Examples:

##### To set the trace level to trace all information with high data detail in the *Thread* and *ProviderManager* components,

type the following commands into the UNIX System Services shell:

```
cimconfig -s traceLevel=4
cimconfig -s traceComponents=Thread,ProviderManager
```

or

```
F CFZCIM,APPL=CONFIG,traceLevel=4
F CFZCIM,APPL=CONFIG,traceComponents='Thread,ProviderManager'
```

on the console.

##### To disable all tracing,

type the following command into the UNIX System Services shell:

```
cimconfig -s traceLevel=0
```

##### To route both trace and log messages to a file:

type the following commands into the UNIX System Services shell:

```
cimconfig -s traceLevel=1
cimconfig -s traceComponents=Thread,ProviderManager,LogMessages
cimconfig -s traceFacility=FILE
cimconfig -s traceFilePath=/tmp/cimserver1.trc
```

The CIM server now saves severe trace messages in the *Thread* and *ProviderManager* components and all log messages to the file */tmp/cimserver1.trc*.

##### To route both trace and log messages to memory:

type the following commands into the UNIX System Services shell:

```
cimconfig -s traceLevel=1
cimconfig -s traceComponents=Thread,ProviderManager,LogMessages
cimconfig -s traceFacility=MEMORY
```

The CIM server now saves severe trace messages in the *Thread* and *ProviderManager* components and all log messages to the default memory space of 10240kB.

##### To route both trace and log messages to the z/OS Communications Server's system logger (syslog) daemon:

1. configure the syslog daemon as described in *z/OS Communications Server: IP Configuration Reference* and *z/OS Communications Server: IP Configuration Guide*
2. type the following commands into the UNIX System Services shell:

```
cimconfig -s logLevel=TRACE
cimconfig -s traceLevel=1
cimconfig -s traceComponents=Thread,ProviderManager
cimconfig -s traceFacility=LOG
```

The CIM server now writes severe trace messages in the *Thread* and *ProviderManager* components and all log messages to the syslog daemon.

See also “Logging.”

---

## Logging

The CIM server sends log messages

- to the z/OS system console,
- to *stderr*,  
if the CIM server is run as a started task. The logs are captured in */var/wbem/logs/cimserver.err*.
- to the z/OS Communications Server’s system logger (*syslog*) daemon,  
if the *syslog* daemon is configured as described in *z/OS Communications Server: IP Configuration Reference* and *z/OS Communications Server: IP Configuration Guide*,
- and to the *trace facility*,  
if *traceComponents* includes the element *LogMessages*, (see also “Tracing” on page 68).

Generally logging for the CIM server is enabled and cannot be turned off. However, you can configure the level of logging.

### To modify the log level

use the *cimconfig* command or the *MODIFY* console command to change the *logLevel* configuration property.

#### Examples

- type the following command into the UNIX System Services shell while the CIM server is running:  

```
cimconfig -s logLevel=INFORMATION
```
- or type the following command into the z/OS system console:  

```
F CFZCIM,APPL=CONFIG,logLevel=INFORMATION
```

See also “*cimconfig*” on page 83 and “*MODIFY* console command” on page 117.

### Log levels

You can choose between five different log levels:

#### INFORMATION (default)

The default setting for *logLevel* is *INFORMATION*. This setting should not be changed unless there is a specific need for a more or less detailed logging.

#### WARNING

returns log messages for warnings, severe and fatal errors

**SEVERE** returns log messages for severe and fatal errors

**FATAL** returns log messages only for fatal errors

**TRACE** returns all log messages and all trace messages

trace messages are only routed to the z/OS Communications Server's system logger (syslog) daemon - never to the system console. Remember to set *traceFacility* to LOG, otherwise no trace message is displayed in the syslog daemon (see "Tracing" on page 68).

## Using the syslog daemon for CIM server logging

The z/OS CIM server will connect to the syslog daemon and send all of its log messages to it, where the filtering according to the *logLevel* configuration property applies as described above. Therefore no messages will be submitted to the syslog daemon which have a higher log level than what's specified in the current value of the *logLevel* configuration property.

Messages that go to the syslog daemon are prepended with an according z/OS message number, which is either one of the generic CFZ00001E, CFZ00002W or CFZ00004I messages followed by a PGSxxxx message number, or one of the directly mapped z/OS specific CFZxxxx message numbers.

Syslog messages from the z/OS CIM server will have an identifier of "CFZCIM" and also contain the CIM server's process ID.

The log levels of the z/OS CIM server are mapped to the following syslog levels:

*Table 6. Log and syslog levels*

Log level	Syslog level
INFORMATION	LOG_INFO
WARNING	LOG_ERR
SEVERE	LOG_WARNING
FATAL	LOG_ERR
TRACE	LOG_DEBUG

The syslog service must be properly configured for CIM, and the syslog daemon must be started as described in *z/OS Communications Server: IP Configuration Reference* and *z/OS Communications Server: IP Configuration Guide*.

Following is a sample syslog configuration file (*/etc/syslog.conf*) entry for the CIM server, which tells the syslog daemon to create log files:

**Example:**

```
...
*.CFZ*.*.debug /var/wbem/logs/cimserver_%Y.%m.%d.syslog
...
```

When configured like this, the CIM server log messages will be displayed in the format shown by the following example:



**Example:**

```
Nov 7 12:48:38 BOECFZ1 CFZCIM[33557318]:
CFZ10025I: The CIM server is listening on HTTP port 5,988.
Nov 7 12:48:38 BOECFZ1 CFZCIM[33557318]:
CFZ10028I: The CIM server is listening on the local connection socket.
Nov 7 12:48:38 BOECFZ1 CFZCIM[33557318]:
CFZ10030I: Started CIM Server version 2.11
Nov 7 12:48:38 BOECFZ1 CFZCIM[33557318]:
CFZ12533I: The CIM server failed to register with ARM using
element name CFZ_SRV_PEG2: return code 0x0C, reason code 0x0168.
Nov 7 12:49:01 BOECFZ1 CFZCIM[33557318]: CFZ10031I: CIM Server stopped.
```

Except for the CIM server's *logLevel* property, all configuration now occurs through the syslog service as described in *z/OS Communications Server: IP Configuration Reference* and *z/OS Communications Server: IP Configuration Guide*.

Configuration of the syslog daemon for specific processes/daemons is done based on the job name of the process writing the logs.

When you run the CIM server as started task,  
the job name is always CFZCIM.

When you have started the CIM server from the UNIX System Services command prompt,

the job name of the CIM server is the user ID that started the CIM server. Be sure that you have set environment variable `_BPX_JOBNAME` to CFZCIM in order to set the job name of the CIM server correctly. Otherwise it will be difficult to create a syslog configuration for the CIM server.

---

## Audit logging with SMF record 86

The CIM server can file audit log records to SMF record 86. These records contain information about authentication, configuration, provider status, and CIM operations. For details of SMF record 86, see *z/OS MVS System Management Facilities (SMF)*.

To enable writing audit SMF record 86, modify the SMF, the CIM server, and the security configuration:

**SMF configuration:**

- Ensure that record 86 is part of your active SMF configuration SMFPRMXX PARMLIB member.

**CIM server configuration:**

- To enable the CIM server to write audit records, set the configuration property `enableAuditLog` to true.

When recording is switched on, the current CIM server configuration and the status of the currently loaded providers is recorded. To disable recording, set the configuration property to false. This property can be changed dynamically during CIM server runtime.

**Security configuration:**

- In order to write SMF records, the CIM server needs at least READ access to the BPX.SMF profile of the FACILITY class at your SAF product.

**Example for RACF:**

```
RDEFINE FACILITY BPX.SMF UACC(NONE)
PERMIT BPX.SMF CL(FACILITY) ACCESS(READ) ID(CFZSRV)
SETROPTS RACLIST(FACILITY) REFRESH
```

If the CIM server audit logging is enabled, but SMF does not collect SMF record 86 or subtypes, or SMF is not enabled at all, no records are written.

---

## Backing up the CIM server configuration

After you have set up and configured the z/OS CIM server, you should back up the following CIM server property configuration files located in */etc/wbem*:

`cimserver_planned.conf`

containing planned values which have been modified but are not yet in effect. They will be picked up at the next CIM server restart.

`cimserver.env`

containing the environment variables for the started task CFZCIM

How to backup the CIM server repository is described in “Backing up the CIM server repository” on page 77.

---

## Automatically restarting the CIM server

Since the CIM server serves as a primary system management interface for a system, it should be continuously available.

To support the CIM server availability, startup and shutdown messages are logged to the z/OS console to be used with a systems management program such as IBM Tivoli® System Automation.

The z/OS CIM server is enabled for the Automatic Restart Manager (ARM). The CIM server needs no additional configuration to use ARM, it always registers itself to ARM. When ARM is active and the CIM server is authorized to register with ARM, then success message CFZ12532I is displayed in the system log. Otherwise, information message CFZ12533I is displayed in the system log to inform you that the CIM server is not registered to ARM.

You can use ARM only for started task procedures or batch jobs. So if you start the CIM server from the UNIX System Services shell, you also get the message CFZ12533I. If you do not plan to use ARM, you can ignore this message, which is issued every time when the CIM server is started.

The CIM server issues the registration and the ready request after a successful bind to the communication socket/s (HTTP, HTTPS, and/or Local). It is deregistered from ARM during its normal shutdown procedure. In all other cases, the CIM server remains registered and is restarted based on the active ARM policy.

In a sysplex, you can start only one CIM server per OS image. Therefore ARM can only be used to restart after an application ABEND and not for cross-system restarts. You must use other facilities to start the CIM server during an IPL.

More information:

## **ARM policy considerations**

The CIM server has the following requirements for exploiting the ARM restart policy:

- The ARM element name used for the CIM server is CFZ\_SRV\_<system\_name>, where <system\_name> is substituted by the value of the system symbol SYSNAME.
- The CIM server can only be restarted on the system where it failed. A cross-system restart within a sysplex is not possible. Therefore the termination type has to be ELEMTERM.
- The restart occurs through starting the CIM server started task procedure CFZCIM.

The sample JCL CFZARMP is installed to the SYS1.SAMPLIB during SMP/E z/OS installation of the CIM component.

```

//CFZARMP JOB MSGCLASS=C,MSGLEVEL=(1,1),USER=XXXXXX,NOTIFY=XXXXXX
//*****
//*
//* PROPRIETARY STATEMENT:
//* Licensed Materials - Property of IBM
//* 5694-A01 Copyright IBM Corp. 2005, 2009
//*
//* STATUS=HPG7760
//*
//* DESCRIPTIVE NAME:
//*
//* SAMPLE JCL TO UPDATE THE ADMINISTRATIVE POLICY DATA FOR CIM
//* SERVER IN THE COUPLE DATA SET FOR ARM (AUTOMATIC RESTART MANAGER)*
//*
//* NOTES:
//*
//* 1. SYSPRINT DD IS A REQUIRED DD STATEMENT FOR THE UTILITY
//* OUTPUT.
//* 2. SYSIN DD IS A REQUIRED DD STATEMENT FOR THE UTILITY
//* CONTROL STATEMENTS.
//* 3. DATA TYPE(ARM) STATEMENT IS REQUIRED TO SPECIFY WHAT TYPE
//* OF COUPLE DATA SET IS TO BE UPDATED.
//* 4. REPORT KEYWORD IS OPTIONAL. WHEN REPORT(YES) IS SPECIFIED,
//* AN ARM ADMINISTRATIVE POLICY REPORT WILL BE GENERATED IN
//* THE OUTPUT. THE DEFAULT VALUE FOR REPORT IS YES.
//* 5. REPLACE KEYWORD IS OPTIONAL. WHEN REPLACE(YES) IS SPECIFIED
//* FOR A POLICY, THE POLICY WILL BE REPLACED IF IT ALREADY
//* EXISTED IN THE COUPLE DATA SET.
//* IF REPLACE(NO) IS SPECIFIED FOR AN EXISTING POLICY,
//* THE UPDATE JOB WILL BE FAILED AND NO CHANGES WILL BE MADE
//* TO THE COUPLE DATA SET.
//* 6. TO DELETE AN EXISTING POLICY IN A COUPLE DATA SET,
//* INCLUDE THE FOLLOWING LINE IN THE SYSIN DD CARD:
//* DELETE POLICY NAME(CFZARMP0)
//* WHERE POLNAME IS THE NAME OF THE POLICY TO BE DELETED.
//*
//*****
//STEP1 EXEC PGM=IXCMIAPU
//STEPLIB DD DSN=SYS1.MIGLIB,DISP=SHR
//SYSPRINT DD SYSOUT=A
//SYSABEND DD SYSOUT=A
//SYSIN DD *

DATA TYPE(ARM)
REPORT(YES)

DEFINE POLICY NAME(CFZARMP0) REPLACE(YES)

RESTART_GROUP(CFZCIMRESGRP)
/* List all systems where the CIM Server can be started */
TARGET_SYSTEM(SYS1)
/* Wait 10 sec before restarting to free resources */
RESTART_PACING(10)

ELEMENT(CFZ_SRV_*)
RESTART_ATTEMPTS(3,300)
RESTART_TIMEOUT(300)
READY_TIMEOUT(300)
/* coss-system restart is not allowed. */
/* No restart after system failure */

TERMTYPE(ELEMTERM)
RESTART_METHOD(ELEMTERM,STC,'S CFZCIM')

/*

```

---

## Backing up the CIM server repository

The CIM server keeps definitions of the data about managed objects and their providers in its repository located in */var/wbem*.

It is important to schedule backups of the repository directories and files. If the repository is deleted or corrupted, backups of the repository files need to be restored. If the repository files cannot be restored from a backup, refer to section “Migration from z/OS 1.12 or z/OS 1.13 to z/OS 2.1” on page 18 for information about how to recover the repository.

As recommended in the *z/OS Program Directory*, the path */var/wbem* should be mounted as a separate data set to simplify backing up. It is also recommended to stop the CIM server during backup to avoid data corruption.

**Note:** If the repository was backed up from a prior z/OS release, it should not be restored onto a system that runs a later version of z/OS. Once a new version of z/OS was installed and the CIM server has been initially started, you should immediately back up the upgraded repository and discard old repository backups.



---

## Chapter 12. CIM server command-line utilities and console commands

The CIM server includes a set of command-line utilities and console commands that you can use to control or change the CIM server environment or to send CIM requests to CIM servers on z/OS or non-z/OS systems. You run most of the command-line utilities from a z/OS UNIX System Services shell.

### Prepare the UNIX System Services shell as follows:

- Be sure that your environment is set up as described in
  - “Step 5: Customizing the UNIX System Services shell” on page 21 or
  - “Customizing the UNIX System Services shell” on page 51
- Grant system administrators using the command-line utilities CONTROL access to profile CIMSERV in class WBEM

### CIM server utilities and commands:

**cimmof** These commands are used to compile provider registrations and to compile CIM class descriptions written in the managed object format (MOF) language. The compiled information is put into the class schema stored in the repository.

The `cimmof` command is described in “`cimmof`” on page 81.

#### **cimconfig**

This command configures the options for the CIM server. Depending on the property being configured, the CIM server may need to be restarted after using this command.

The `cimconfig` command is described in “`cimconfig`” on page 83.

#### **cimprovider**

This command can be used to control the registered providers. The CIM server must be running to use this command.

The `cimprovider` command is described in “`cimprovider`” on page 85.

**cimcli** This command lets you perform CIM client requests/operations against the local or remote CIM servers. It implements most of the DMTF CIM operations.

Each call of `cimcli` invokes a CIM operation with the corresponding parameters equivalent to the CIM operations defined in the *CIM Operations over HTTP* specification. Additionally, the `cimcli` command-line interface implements a number of other specific operations that support testing and querying CIM servers, including operations to query for namespaces and to get all instances in a namespace.

The `cimcli` command is described in “`cimcli`” on page 88.

**cimsub** This command lets you manage CIM indications on the local CIM server. The command can list, enable, disable and remove indication subscriptions, filters and handlers.

The `cimsub` command is described in “`cimsub`” on page 114.

### **MODIFY console command**

Like the `cimconfig` command, the `MODIFY` console command configures the options for the CIM server while the CIM server is running. Depending on the property being configured, the CIM server may need to be restarted after using this command.

The `MODIFY` console command is described in “`MODIFY` console command” on page 117.

**Note:** The `wbemexec` utility is also included with CIM. It is used to directly send CIM-XML requests to a CIM server. However, this tool is not supported, but just supplied on an 'as-is-base'.

You can specify most options provided by the utilities in two ways:

- a short form introduced by a single dash, for example `-f<file>`
- a long form introduced by a double dash, for example `--file=<file>`



## cimmof

### Purpose

These commands are used to compile provider registrations or to compile CIM class descriptions written in the MOF language and store the information in the repository. For `cimmof`, the CIM server must be started before using this command.

The CIM server MOF compiler is a command-line utility that compiles MOF files (using the MOF format defined by the DMTF CIM Specification) into a CIM server repository. It allows compiling from structures of MOF files using the `include #pragma` and can either compile into a CIM server repository or check the syntax of the MOF files. The compiler requires that the input MOF files are in the current directory or that a fully qualified path is given. MOF files that are included using the `include #pragma` must be in the current directory or in a directory specified by a `-I` command-line switch.

For using the `cimmof` command against the CIM server namespaces (`root/PG_Internal`, `root/PG_InterOp`), a user needs to have `CONTROL` access to profile `CIMSERV` in class `WBEM`.

### Syntax

#### Main diagram:

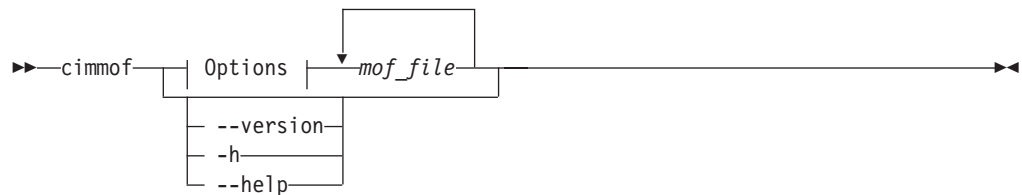

#### Options:

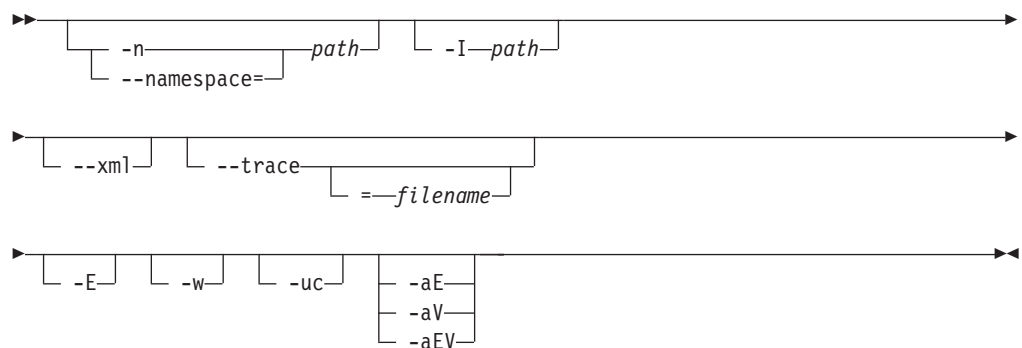

### Options

*mof\_file*  
Specifies the MOF file or MOF files to compile.

**--version**  
Displays the CIM server version.

- h, -help, or no specified option**  
Prints out a usage message with command definitions.
- I path** Specifies a path to the included MOF files.
- n path, --namespace=path**  
Overrides the default CIM repository namespace path. The default is root/cimv2.
- xml** Generates XML to standard output. This option does not update the repository.
- trace, --trace=filename**  
Writes trace information to a file. If *filename* is omitted, the output destination is standard output. Those files are written with ASCII encoding.
- E** Performs a syntax check on the input. This option does not update the repository.
- w** Suppresses warning messages.
- uc** Allows the update of an existing class definition. This option lets you update a leaf class. It does not allow updates of superclasses or classes that have subclasses.
- aE** Allows the addition or modification of classes with the experimental qualifier.
- aV** Updates a class that results in a version change. The version must be specified in a valid format. The format is *m.n.u* where *m* is major version, *n* is minor release and *u* is update. For example, 2.7.0 is a valid format for CIM Schema 2.7.0. If the input class has the same version as the class in the repository, the class is not updated.
- aEV** Allows both Experimental and Version Schema changes.

## Examples

**cimmof -w -I./myDir myDir/CIM\_Schema211.mof**

In this example, the managed object format (MOF) file that is located in directory `myDir` with the name `CIM_Schema211.mof` is compiled into the default namespace `root/cimv2`. `CIM_Schema211.mof` includes `#pragmas` for other MOF files that are also in the `myDir` directory. Therefore an include (`-I`) option is required for the `myDir` directory. The `-w` option suppresses warning messages.

---

## cimconfig

### Purpose

Use the `cimconfig` command to manage CIM server configuration properties. You can get, set, unset, or list these properties. See Chapter 11, “CIM server administration,” on page 65 for more information.

You can use the `cimconfig` command to set the current or planned configuration properties of the CIM server.

#### Current configuration properties:

You can update the current configuration properties only while the CIM server is running. After a restart of the CIM server, these changes will be reset to the planned or default configuration values. For making permanent changes, you must change the planned configuration values.

#### Planned configuration properties:

Planned configuration properties can be modified even if the CIM server is stopped. If the planned configuration properties are changed when the CIM server is running, those changes do not take effect until the CIM server is restarted.

For using the `cimconfig` command, a user needs to have `CONTROL` access to profile `CIMSERV` in class `WBEM`.

### Syntax

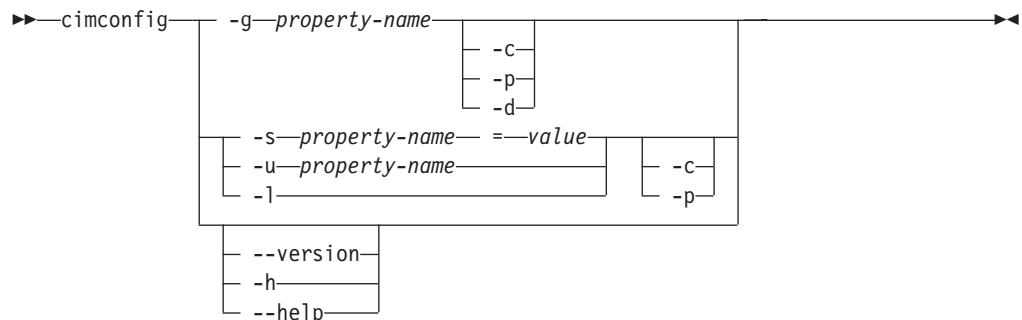

### Options

The `cimconfig` command recognizes the following options:

`-g property-name`, `-g property-name -c`

Gets the current value of the configuration property *property-name*. Returns an error when the CIM server is not running.

`-g property-name -p`

Gets the planned value of the configuration property *property-name*.

`-g property-name -d`

Gets the default value of the configuration property *property-name*. Returns an error when the CIM server is not running.

`-s property-name=value`, `-s property-name=value -c`

Sets the current configuration property *property-name* to the value *value*. Returns an error when the CIM server is not running or the specified property cannot be updated dynamically.

- s *property-name=value -p***  
Sets the planned configuration property *property-name* to the value *value*.
- u *property-name, -u property-name -c***  
Unsets the value of the current configuration property *property-name* to its default value. Returns an error when the CIM server is not running or the specified property cannot be updated dynamically.
- u *property-name -p***  
Unsets the value of the planned configuration property *property-name* to its default value.
- l** Lists the names of all configuration properties. Returns an error when the CIM server is not running.
- l -c** Lists the name and value pairs of all current configuration properties. Returns an error when the CIM server is not running.
- l -p** Lists the name and value pairs of all planned configuration properties.
- version**  
Displays the CIM server version.
- h, --help, no options specified**  
Displays the command help information.

## Examples

**cimconfig -s traceLevel=4**

**cimconfig -s traceComponents=XmlIO,Http**

Sets the trace level to trace all information with high data detail in the *XmlIO* and *Http* components.

**cimconfig -s logLevel=WARNING -p**

Sets the *logLevel* configuration property to the value `WARNING` in the *cimserver\_planned.conf* file.

---

## cimprovider

### Purpose

The `cimprovider` command lets you disable, enable, remove, and list registered CIM providers or CIM provider modules and the according module status. In addition, it allows you to define groups of provider modules to be run in the same provider agent process.

#### disable

When a CIM provider is disabled, the CIM server rejects any requests to the provider. When a provider module is disabled, any new requests to the providers that are contained in the specified provider module are rejected.

#### enable

When a CIM provider is enabled, the CIM server forwards requests to the provider. When a provider module is enabled, the providers that are contained in the provider module are ready to accept a new request.

#### remove

When a CIM provider is removed (unregistered), the CIM server will no longer have any information about the provider. When a CIM provider module is removed (unregistered), the CIM server will no longer have any information about any provider contained in the module. If you want to address requests to a provider after removal, the provider or provider module must be registered again (typically by loading its registration schema using the `cimmof` command).

#### list

You can list all registered provider modules and the according module status or all providers in the specified provider module.

**group** Allows grouping of provider modules in a single provider agent process when running the CIM server in out-of-process mode, that is, configuration property `forceProviderProcesses` is true.

For using the `cimprovider` command, the CIM server must be running, and the user needs to have CONTROL access to profile CIMSERV in class WBEM.

### Syntax

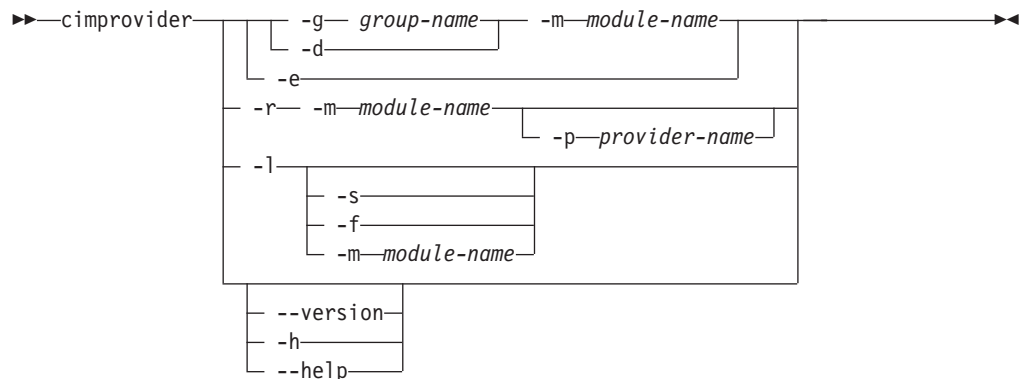

### Options

The `cimprovider` command recognizes the following options:

- d -m *module-name***  
Disables the CIM provider module *module-name*. If the module is already disabled, an error message is returned.
- e -m *module-name***  
Enables the CIM provider module *module-name*. If the module is already enabled or is currently being disabled, an error message is returned.
- g *group-name* -m *module-name***  
Sets the CIM provider module group. To remove a provider module from grouping, specify an empty string. If the provider module is active, it will be disabled before the group is set and then enabled again. All provider modules with the same group name are loaded into a single agent address space. If CIMServer is specified as group name, the provider module is loaded into the CIM server address space. Provider module groups are only in effect when running the CIM server in out-of-process mode.
- r -m *module-name***  
Removes the provider module *module-name* and all of its contained providers.
- r -m *module-name* -p *provider-name***  
Removes the provider *provider-name* in the provider module *module-name* without affecting any other providers in that module.
- l**  
Displays all registered provider modules.  
  
To list all providers in all modules, type a `cimprovider -l` command, followed by `cimprovider -l -m` for each listed module.
- l -s**  
Lists the status of all registered provider modules.
- l -f**  
Lists the full status of all registered provider modules and their module group name.
- l -m *module-name***  
Lists all registered providers in module *module-name*.
- version**  
Displays the CIM server version.
- h, --help, no option specified**  
Displays the command help information.

## Limitations

This command disables, enables, or removes one CIM provider module or CIM provider at a time.

## Examples

**cimprovider -d -m myProviderModule**

Disables provider module `myProviderModule` and all of its contained providers (placing them in a stopped state).

**cimprovider -e -m myProviderModule**

Enables provider module `myProviderModule` and all of its contained providers (placing them in an OK state).

**cimprovider -r -m myProviderModule**

Removes (unregisters) the `myProviderModule` provider module and all of its contained providers.

**cimprovider -r -m myProviderModule -p MyProvider**

Removes (unregisters) the `MyProvider` provider contained in the `myProviderModule` provider module.

- cimprovider -l**  
Lists the registered provider modules.
- cimprovider -l -s**  
Lists the registered provider modules and their status (such as OK, Stopping, Stopped).
- cimprovider -l -m myProviderModule**  
Lists the registered providers, which are in the myProviderModule provider module.
- cimprovider -g myProviderGroup -m myProviderModule**  
Adds provider module myProviderModule to the group myProviderGroup. Module myProviderModule will be processed in the same provider agent process as all other providers in the group myProviderGroup.

---

## cimcli

### Purpose

z/OS provides a command-line interface called `cimcli` through which you can perform CIM client requests/operations. It implements most of the DMTF CIM operations except for the *modifyClass*, *modifyInstance* and *createClass* operations.

Each execution of `cimcli` invokes a CIM operation with the corresponding parameters equivalent to the CIM operations defined in the *CIM Operations over HTTP* specification.

In addition to the basic CIM operations defined in this specification, the `cimcli` command-line interface implements a number of other specific operations that support testing and querying CIM servers, including operations to query for namespaces and to get all instances in a namespace.

The command-line client is invoked from the UNIX System Services shell.

### Syntax

#### Main diagram:



#### Operation:

Defines the operation to be performed. `cimcli` performs all of the DMTF CIM operations (for example, `getClass`) and a set of compound operations (for example, `enumerateNamespaces`).

There are two forms for each operation: a long form which is the full name of the operation (for example, `getClass`), and a short form, typically two characters (for example, `gc` for `getClass`).

### Options

<b>-h</b>	Prints help usage message.
<b>-hc</b>	Prints CIM operation command list.
<b>--help</b>	Prints full help message with commands, options, and examples.
<b>-ho</b>	Prints list of options.
<b>--version</b>	Displays the software version.



## cimcli a (associators)

### Purpose

Enumerates the classes or instances linked (associated) to a CIM class or a CIM instance.

### Operation

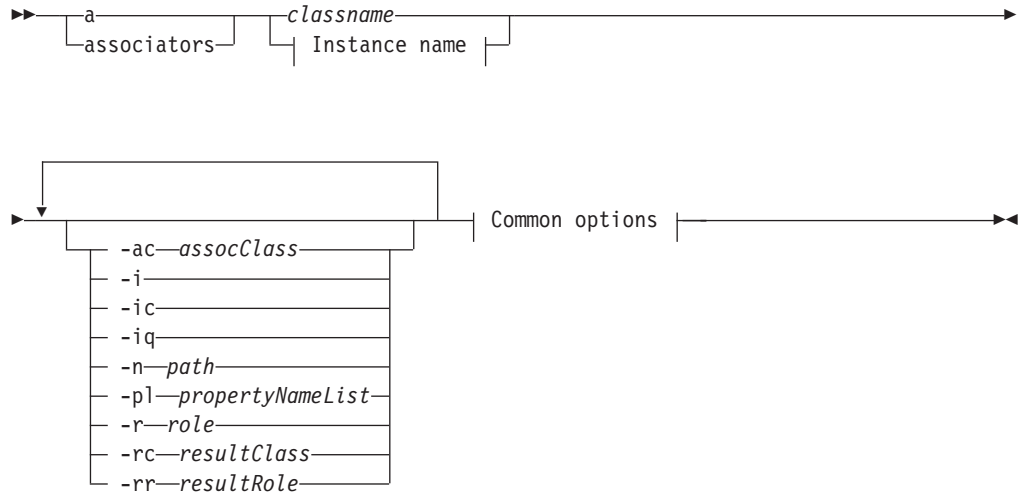

For "Instance name", see "*cimcli Instance name*" on page 113.

### Options

For special options and "Common options", see "*cimcli Options*" on page 111.

### Examples

```
cimcli a IBMzOS_Process
```

### Results

0 Successful execution of the operation

#### all values other than 0

The execution on the operation returned an error.

For a given class, the list of associated classes is returned.

For a given instance name, the list of associated instances is returned.

## cimcli an (associatorNames)

### Purpose

Enumerates the class or instance names linked (associated) to a CIM class or a CIM instance.

### Operation

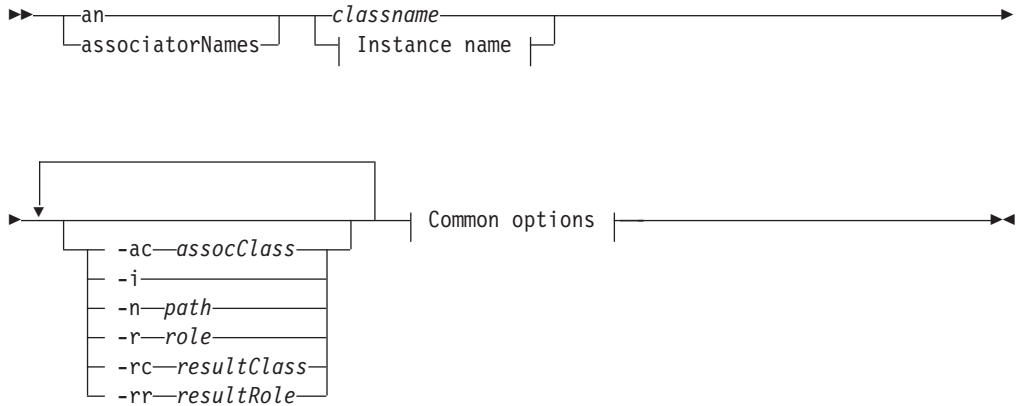

For "Instance name", see "cimcli *Instance name*" on page 113.

### Options

For special options and "Common options", see "cimcli *Options*" on page 111.

### Examples

```
cimcli an IBMzOS_Process
```

### Results

**0** Successful execution of the operation

**all values other than 0**

The execution on the operation returned an error.

For a given class, the list of associated class names is returned.

For a given instance name, the list of associated instance names is returned.

## cimcli ci (createInstance)

### Purpose

Creates one instance of the specified class with the provided properties in the repository.

### Operation

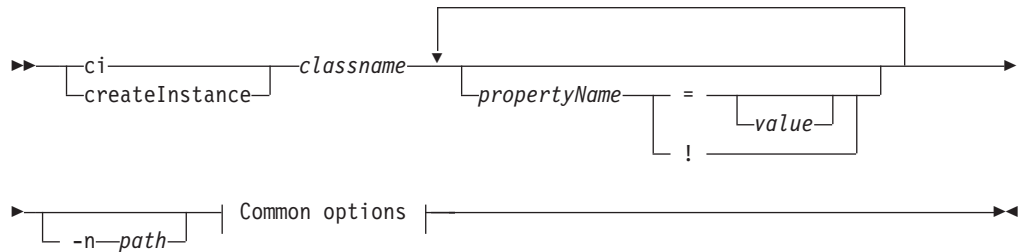

### Usage

The *classname* parameter defines the class for which the instance is to be created. The optional set of parameters defines the properties to be provided (see also “cimcli *Instance name*” on page 113). The command reads the specified class and inserts the properties. The command will be rejected if the class does not exist in the namespace.

Specify a *value* for a property name according to its type. Follow the syntax rules as specified in *Common Information Model Specification, DSP0004, Version 2.3* by the DMTF. Note special syntax rules to define

- the current date and time with the keyword *now* for values of the type *Datetime*
- an empty string with the property name followed by a *!* for values of the type *string*
- an *NULL* string with the property name followed by a *=* for values of the type *string*

### Options

For special options and “Common options”, see “cimcli *Options*” on page 111.

### Examples

```
cimcli ci CIM_Person Name=Michael Title=Engineer
```

Creates an instance of the class *CIM\_Person*.

### Results

The command returns the object path of the created instance if the call to the CIM server was performed. Otherwise it returns the exception received.

0 Successful execution of the operation

#### all values other than 0

The execution on the operation returned an error.

## cimcli dc (deleteClass)

### Purpose

Deletes the CIM class specified by *classname*.

### Operation

```
►► [dc] [deleteClass] classname [ -n path ] | Common options | ◀◀
```

### Options

For special options and "Common options", see "cimcli *Options*" on page 111.

### Examples

```
cimcli dc CIM_Person
```

Deletes the class CIM\_Person and all sub-classes when there are no instances.

### Results

0 Successful execution of the operation

#### all values other than 0

The execution on the operation returned an error.

## cimcli di (deleteInstance)

### Purpose

Deletes the specified instance or interactively one instance from the specified class.

### Operation

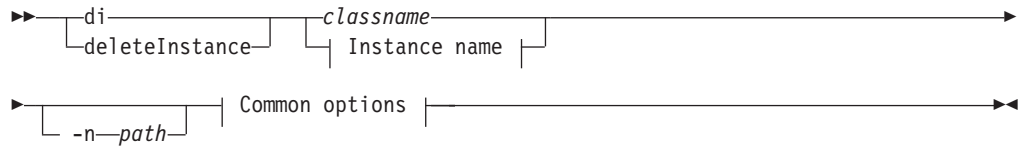

For "Instance name", see "cimcli *Instance name*" on page 113.

### Usage

If the instance name is specified, the operation is performed directly. If a class name is specified, the enumerateInstanceNames command is performed with the class name and the list of returned instance names is presented to the user to select one to delete. cimcli then performs deleteInstance with the selected instance name.

### Options

For special options and "Common options", see "cimcli *Options*" on page 111.

### Examples

```
cimcli di CIM_Person
```

Interactively deletes an instance of class CIM\_Person.

### Results

0 Successful execution of the operation

#### all values other than 0

The execution on the operation returned an error.

There is no response if the instance was successfully deleted, or an exception returned if there were any errors.

## cimcli dq (deleteQualifier)

### Purpose

Deletes the CIM qualifier specified by *qualifiername*.

### Operation

►► `deleteQualifier` *qualifiername* `-n-path` | Common options | ◀◀

### Options

For special options and "Common options", see "cimcli *Options*" on page 111.

### Examples

```
cimcli dq ASSOCIATION
```

Deletes the qualifier Association (generally not recommended).

### Results

**0** Successful execution of the operation

**all values other than 0**

The execution on the operation returned an error.

## cimcli ec (enumerateClasses)

### Purpose

Enumerates the classes starting at the level defined by *classname*.

### Operation

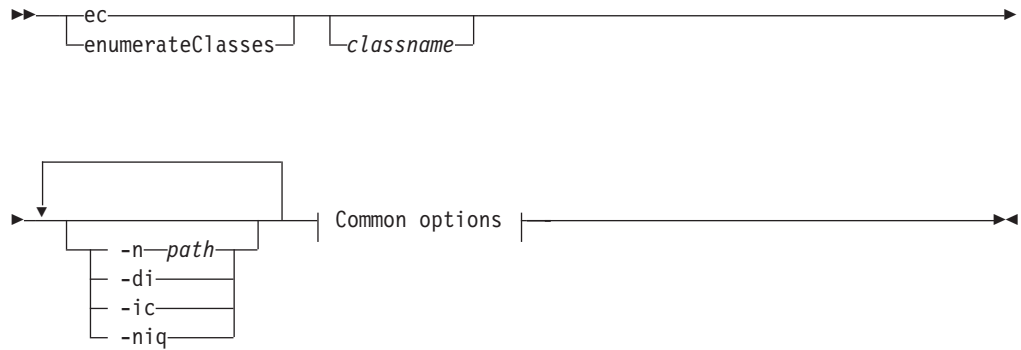

### Usage

If the class name is omitted, cimcli inserts an empty class name.

### Options

**-di** enumerates all inherited classes

If you do not specify this parameter, only the child classes are enumerated.

For all other special options and "Common options", see "cimcli *Options*" on page 111.

### Examples

```
cimcli ec -n root/cimv2 -niq
```

Enumerates classes from the root of the root/cimv2 namespace.

### Results

**0** Successful execution of the operation

**all values other than 0**

The execution on the operation returned an error.

## cimcli ei (enumerateInstances)

### Purpose

Enumerates the instances of the specified CIM class.

### Operation

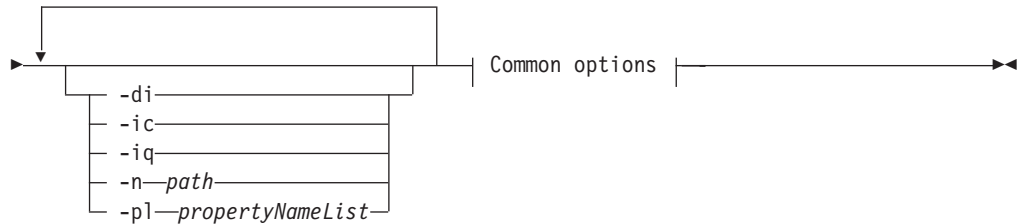

### Options

For special options and "Common options", see "cimcli *Options*" on page 111.

### Examples

```
cimcli ei CIM_ComputerSystem -di
```

Enumerates the instances of class `CIM_Computersystem`, listing properties of inherited classes (`-di`).

### Results

0 Successful execution of the operation

#### all values other than 0

The execution on the operation returned an error.



## cimcli eq (enumerateQualifiers)

### Purpose

Enumerates all qualifiers in the specified or default namespace.

### Operation

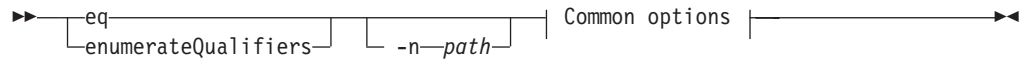

### Options

For special options and "Common options", see "cimcli *Options*" on page 111.

### Examples

```
cimcli eq
```

Enumerates qualifiers in the default root/cimv2 namespace.

### Results

0 Successful execution of the operation

#### all values other than 0

The execution on the operation returned an error.

## cimcli gc (getClass)

### Purpose

Gets the class of *classname*.

### Operation

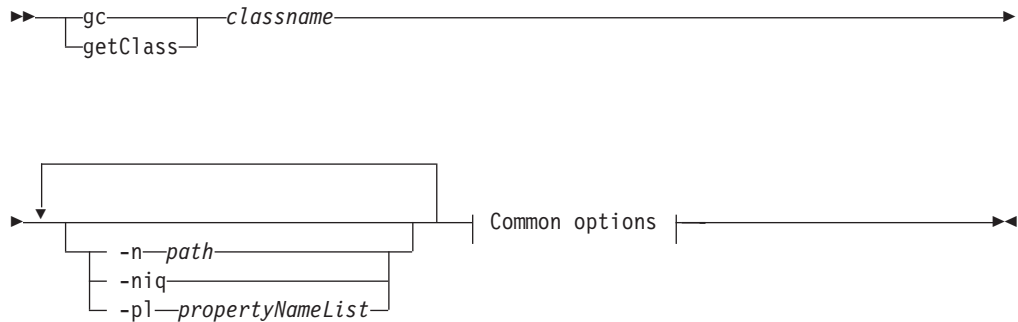

### Options

For special options and "Common options", see "cimcli *Options*" on page 111.

### Examples

```
cimcli gc IBMzOS_Process
```

Gets the definition for class `IBMzOS_Process`.

### Results

**0** Successful execution of the operation

**all values other than 0**

The execution on the operation returned an error.



## cimcli gq (getQualifier)

### Purpose

Gets the CIM qualifier specified by *qualifiername*.

### Operation

```
►► [gq] [getQualifier] [qualifiername] [ -n-path ] | Common options | ◄◄
```

### Options

For special options and "Common options", see "cimcli *Options*" on page 111.

### Examples

```
cimcli gq Association
```

Gets the qualifiers in mof output format

### Results

0 Successful execution of the operation

#### all values other than 0

The execution on the operation returned an error.

## cimcli im (invokeMethod)

### Purpose

Performs the extrinsic method *methodName* on the specified class or instance.

### Operation

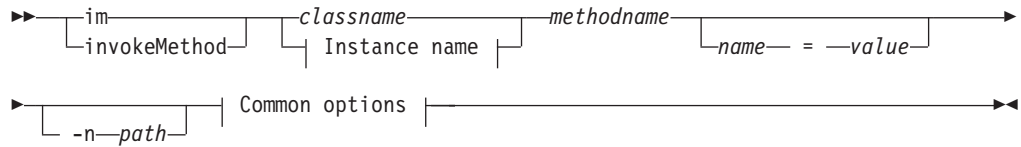

For "Instance name", see "cimcli *Instance name*" on page 113.

### Usage

The parameters are supplied as *name=value* pairs. In the current version, all parameters are treated as strings.

### Options

For special options and "Common options", see "cimcli *Options*" on page 111.

### Examples

```
cimcli im 'IBMzOS_Test.handle="1"' TriggerIndication NumberOfIndications=3
```

### Results

0 Successful execution of the operation

all values other than 0

The execution on the operation returned an error.

## cimcli mi (modifyInstance)

### Purpose

Modifies the specified instance or creates a modified instance of the specified class by building the properties from a combination of the target class and the provided properties.

### Operation

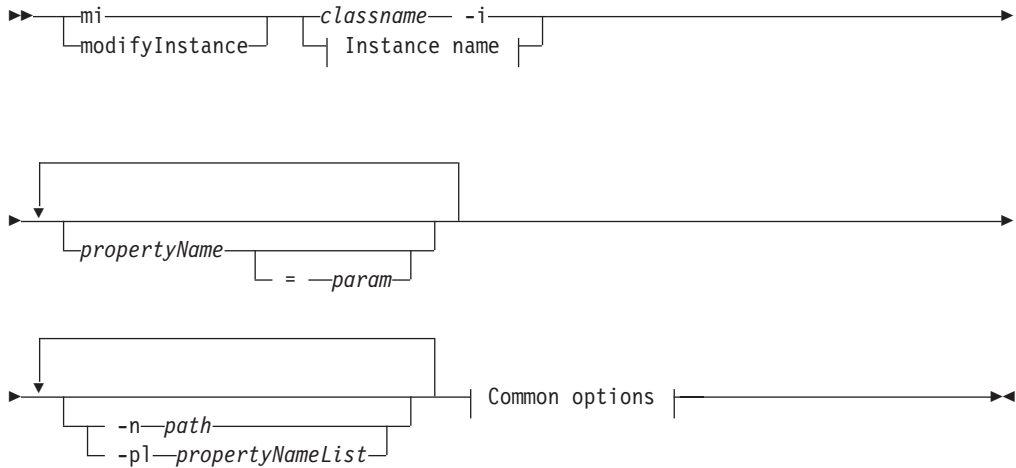

For "Instance name", see "cimcli *Instance name*" on page 113.

### Options

For special options and "Common options", see "cimcli *Options*" on page 111.

### Examples

```
cimcli mi CIM_xxxx name=abc size=zyx
```

### Results

0 Successful execution of the operation

all values other than 0

The execution on the operation returned an error.

## cimcli nc (enumerateClassNames)

### Purpose

Enumerates sub class names of *classname* or all top level class names of a given namespace.

### Operation

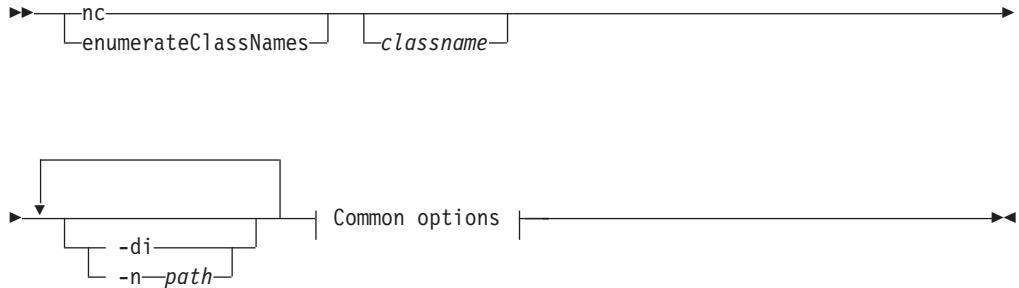

### Usage

Note that on z/OS all class names are returned in lowercase due to a z/OS specific performance optimization. Use the `getClass` operation to receive the exact case of the class name.

### Options

For special options and "Common options", see "cimcli *Options*" on page 111.

### Examples

```
cimcli nc -di
```

Enumerates all class names from the root/cimv2 namespace, including subclasses (-di).

### Results

**0** Successful execution of the operation

**all values other than 0**

The execution on the operation returned an error.

## cimcli ni (enumerateInstanceNames)

### Purpose

Enumerates all instances of the specified class.

### Operation

►► `ni` `classname` `-n path` | Common options | ◀◀

### Options

For special options and "Common options", see "cimcli *Options*" on page 111.

### Examples

```
cimcli ni CIM_Processor -n root/cimv2
```

### Results

0 Successful execution of the operation

#### all values other than 0

The execution on the operation returned an error.



## cimcli ns (enumerateNamespaces)

### Purpose

Requests an enumeration of all the namespaces in the target CIM server. This command uses both the CIM\_Namespace class and if that fails, the \_\_Namespace class to determine the list of namespaces.

### Operation

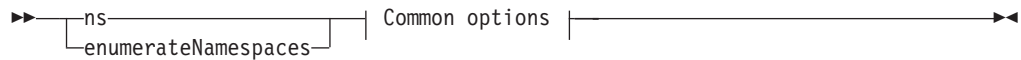

### Options

For "Common options", see "cimcli *Options*" on page 111.

### Examples

```
cimcli ns
```

### Results

0 Successful execution of the operation

#### all values other than 0

The execution on the operation returned an error.

## cimcli r (references)

### Purpose

Enumerates the association classes or association instances linked to the specified CIM class or CIM instance.

### Operation

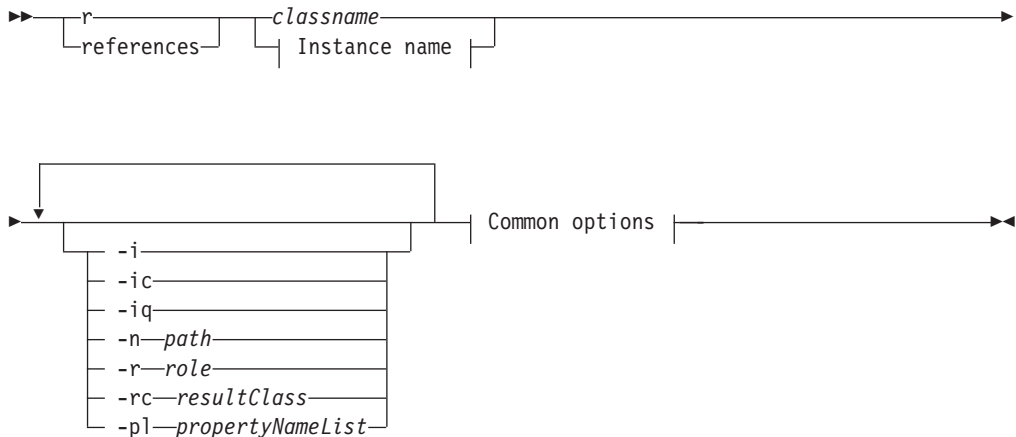

For "Instance name", see "cimcli *Instance name*" on page 113.

### Options

For special options and "Common options", see "cimcli *Options*" on page 111.

### Examples

```
cimcli r 'IBMzOS_ComputerSystem.  
        CreationClassName="IBMzOS_ComputerSystem",  
        Name="sys1" '  
cimcli r IBMzOS_OperatingSystem -rc CIM_OSProcess
```

### Results

0 Successful execution of the operation

#### all values other than 0

The execution on the operation returned an error.

For a given class, the list of linked association classes is returned.

For a given instance name, the list of linked association class instances is returned.

## cimcli rn (referenceNames)

### Purpose

Enumerates the association class or instance names linked to the specified CIM class or CIM instance.

### Operation

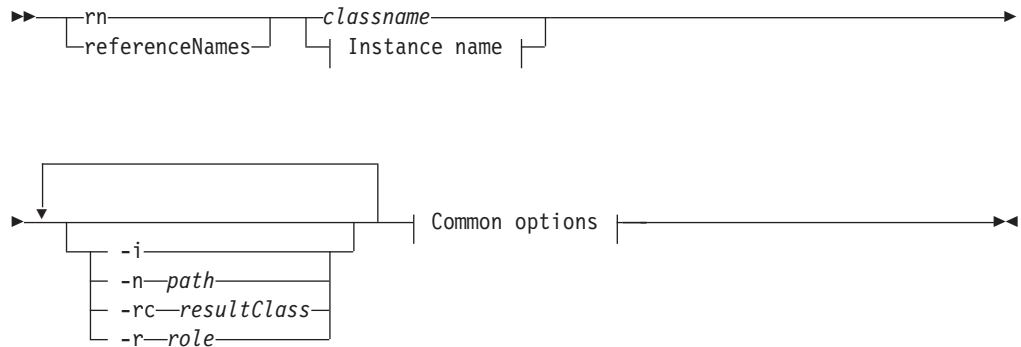

For "Instance name", see "cimcli *Instance name*" on page 113.

### Options

For special options and "Common options", see "cimcli *Options*" on page 111.

### Examples

```
cimcli rn 'IBMzOS_ComputerSystem.  
          CreationClassName="IBMzOS_ComputerSystem",  
          Name="sys1"'
```

```
cimcli rn IBMzOS_OperatingSystem -rc CIM_OSProcess
```

### Results

**0** Successful execution of the operation

#### all values other than 0

The execution on the operation returned an error.

For a given class, the list of linked association class names is returned.

For a given instance name, the list of linked association instance names is returned.

## cimcli sp (setProperty)

### Purpose

Sets a single property on a named instance.

### Operation

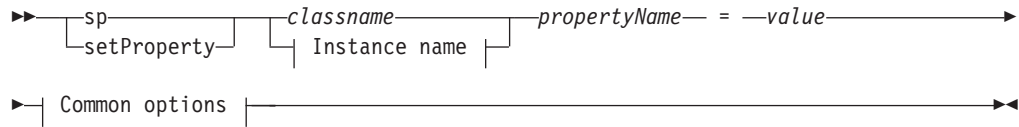

For "Instance name", see "*cimcli Instance name*" on page 113.

### Usage

If the instance name is specified, the operation is performed directly. If a class name is specified, the `enumerateInstanceNames` command is performed with the class name and the list of returned instance names is presented to the user to select one to set. `cimcli` then performs `setProperty` with the selected instance name.

### Options

For special options and "Common options", see "*cimcli Options*" on page 111.

### Examples

```
cimcli sp 'CIM_Person.Name="Michael"' HomePhone=123456789
```

Sets the HomePhone property to 123456789.

### Results

0 Successful execution of the operation

#### all values other than 0

The execution on the operation returned an error.

There is no response at the command prompt when the property has been successfully set.

## cimcli ti (testInstance)

### Purpose

Tests an instance or a class for the equality of the specified properties.

### Operation

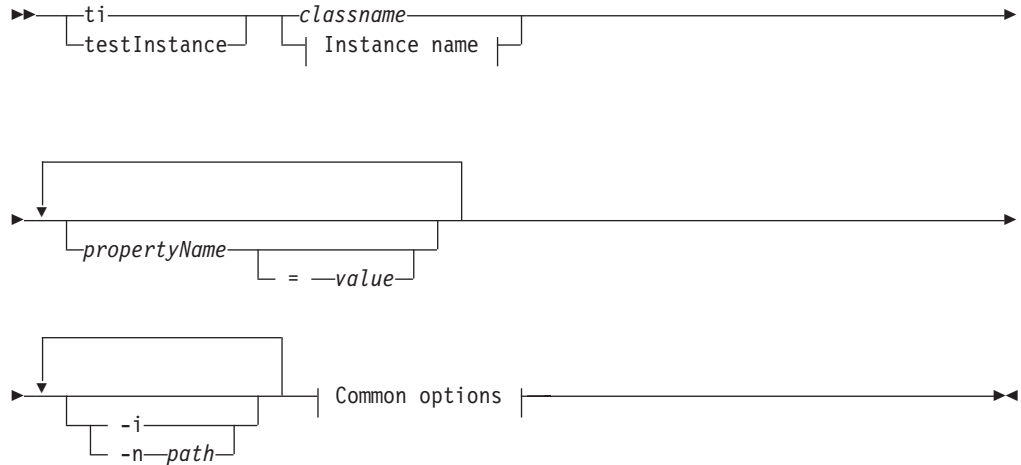

For "Instance name", see "cimcli *Instance name*" on page 113.

### Usage

If the instance name is specified, the operation is performed directly. If a class name is specified, the enumerateInstanceNames command is performed with the class name and the list of returned instance names is presented to the user to select one to test. cimcli then performs testInstance with the selected instance name.

### Options

For special options and "Common options", see "cimcli *Options*" on page 111.

### Examples

```
cimcli ti TST_Person Name=Mike SSN=333 -n test/TestProvider
```

### Results

0 Successful execution of the operation

#### all values other than 0

The execution on the operation returned an error.

Returns an error code if the given properties and values do not match.



## cimcli *Options*

### Purpose

Options are identified on the command line with the '-' or '--' notation. An option that is not used by a particular operation is ignored.

### Common options

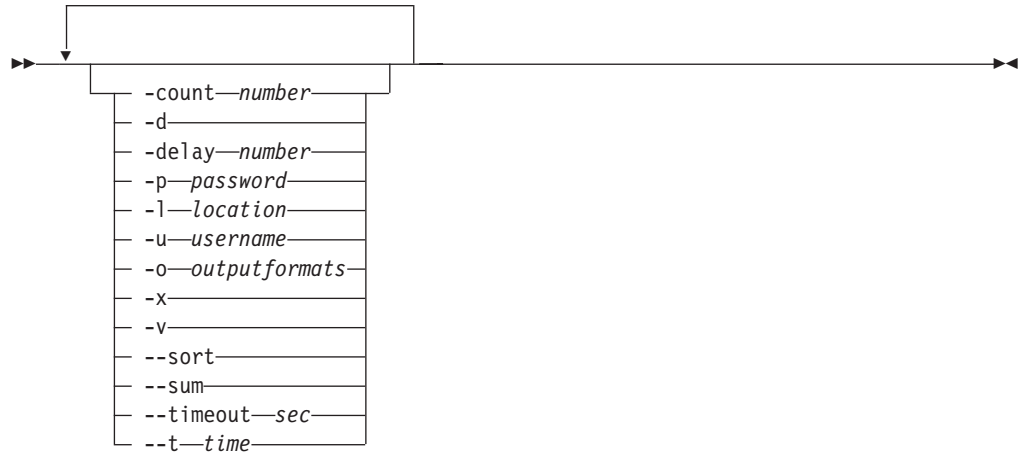

### Usage

The `cimcli` command recognizes the following common options:

- count** *number* Expected number of objects returned, if the **-sum** option is set. Tests this number and displays the difference. Term nonzero is returned if test fails.
- d** Displays more detailed debug messages.
- delay** *number* Delay in seconds between connection and request. Default is 0.
- l** *location* Allows input of the host name for the CIM server and optionally the port (HostName:port). The default is localhost:5988. The port component is optional. The default is 5988.
- n** *path* Specifies the namespace for the operation. The default is root/cimv2.
- o** *outputformats* Specifies the output format. Valid values are: xml, mof, and table. Default is mof.
- p** *password* Allows the input of a password for the command's server authentication. The default is empty.
- r** *repeat* Sets the number of times to repeat the function. Zero means one time. Repeats the operation without disconnecting. Default is 0.
- sort** Sorts the output objects before they are displayed.
- sum** Presents only summary information, not the complete output. Generally this option presents counts of objects returned instead of the names or objects themselves.
- t** *time* Measures the time for operation and presentation of the results upon command completion.
- timeout** *sec* Sets the connection timeout in seconds. Default is 20.
- trace** *traceLevel* Sets the common components trace. Sets the trace level. 0 is off. Default is 0. Valid values are 0 to 5.
- u** *username* Allows the input of a user name for authentication. The default is empty.

- v Displays verbose data (including operation parameters).
- x Output objects in xml instead of mof format.

The cimcli command recognizes the following special options:

- ac *assocClass* Passes the *assocClass* parameter to applicable association operations. Default is to pass no *assocClass* parameter.
- ar *associationRoleName* Defines an association role for associator operations.
- di Specifies the *deepInheritance* parameter for selected commands. The default is 'false'. This option has different meanings for different commands and is used only with the enumerate commands. For further information, refer to the *CIM Operations over HTTP* published by the DMTF.
- i Interactively asks the user to select instances. Used with associator and reference operations.
- ic Sets the CIM operation parameter *classOrigin* in the operation request to true. Only useful with option -o xml.
- iq Sets *includeQualifiers* = true.
- lo Passes *localOnly*=true to applicable operations.
- nlo When set, sets *localOnly* = 'false' on operations. Default is 'false'.  
  
Note that option *localOnly* has been deprecated by the DMTF for some operations and will completely be removed with the next major version of CIM.
- niq Sets *includeQualifiers* = 'false' on operations. Default is 'false'.  
  
Note that option *includeQualifiers* has been deprecated by the DMTF for some operations and will completely be removed with the next major version of CIM.
- pl *propertyNameList* Passes the *propertyNameList* parameter to applicable operations. Format is p1,p2,p3 (without spaces) or "" for an empty list. The default is to pass no *propertyNameList* parameter.
- r *role* Passes the *role* parameter to applicable association operations. Default is to pass no *role* parameter.
- rc *resultClass* Passes the *resultClass* parameter to applicable association operations. Default is to pass no *resultClass* parameter.
- rr *resultRole* Passes the *resultRole* parameter to applicable association operations. Default is to pass no *resultRole* parameter.



## cimcli *Instance name*

### Instance name

Format 1:

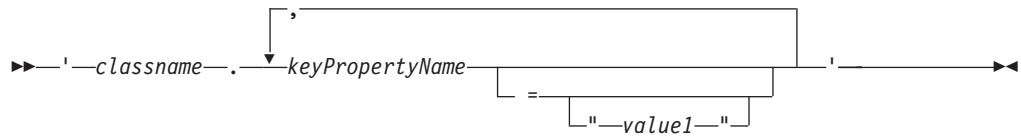

For the getInstance operation, there is also an alternate way to specify an instance name:

Format 2:

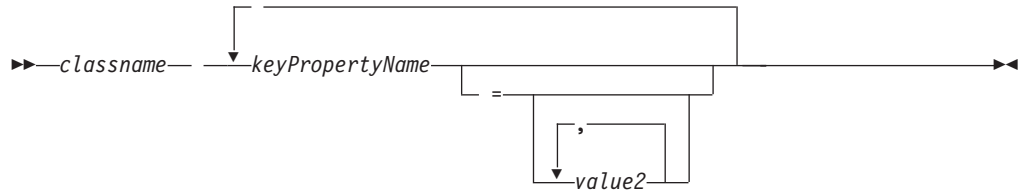

### Usage

*keyPropertyName*

to specify an instance, all key properties of the class have to be listed  
Specifying a key property with a "=", but without a value assigns the NULL value to it.

*value2* Values separated by a ',' are only valid if you specify an array.

The new syntax listing the key properties separated by spaces now allows to specify array values.

### Examples

Format 1: 'CIM\_Person.CreationClassName="",Name="Mike"'

Format 2: CIM\_Person CreationClassName= Name=Mike

# cimsub

## Purpose

The `cimsub` command lets you manage CIM indications on the local CIM server. The command can list, enable, disable and remove indication subscriptions, filters and handlers. However, you cannot modify or create a handler or a filter. The CIM indication must be created or modified by a CIM client program.

**list** Lists all or selected indication subscriptions, filters, and handlers, and displays the requested information about the instance(s).

**enable** Enables a specific subscription. Sets a subscription into the enabled state, and the CIM server starts to process it.

**disable** Disables a specific subscription. Sets a subscription into the disabled state, and it is no longer processed by the CIM server.

**remove** Removes a specific indication subscription, filter, and/or handler from the CIM server. The information is removed within the CIM server and can only be recreated by a client application. The administrator must take care that a filter or handler is not referenced by any other subscription. If this is the case, but the filter or handler is deleted anyway, this subscription will no longer work.

In order to use the `cimsub` command, the CIM server must be running on the local system and a user needs to have `CONTROL` access to profile `CIMSERV` in class `WBEM`.

## Syntax

### Main diagram:



### list:

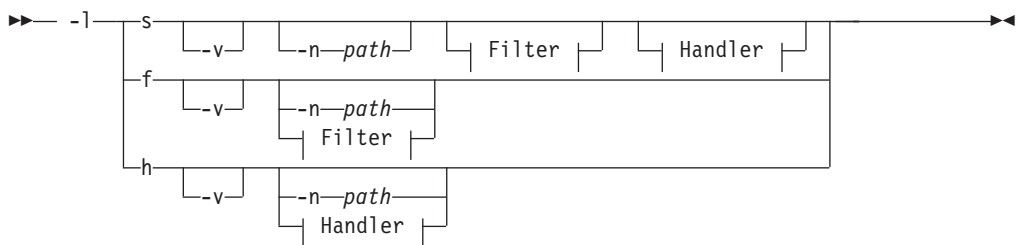

### enable:

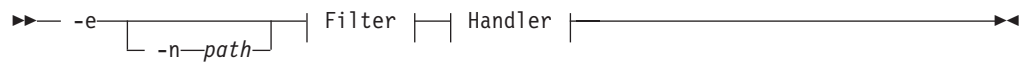

### disable:

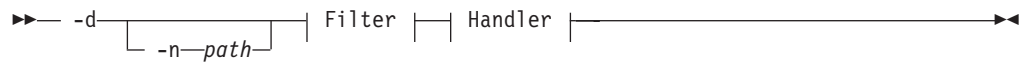

### remove:

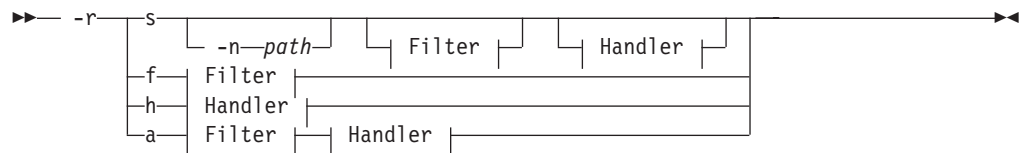

### Filter:



### Handler:

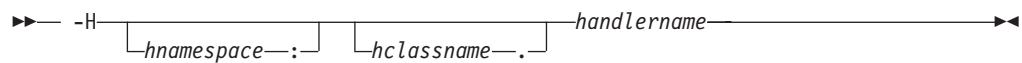

## Options

The `cimsub` command recognizes the following options:

- l** Lists all or selected
  - indication subscriptions ( `-ls` )
  - filters ( `-lf` )
  - handlers ( `-lh` )

Options `-F` and `-H` are superseding the `-n` namespace option, if `-n` is set together with either `-F` or `-H`.

- e** Sets the subscription state to enabled.
- d** Sets the subscription state to disabled.
- r** Removes a specific
  - indication subscription ( `-rs` )
  - filter ( `-rf` )
  - handler ( `-rh` )
  - or all three together ( `-ra` )

Options `-F` and `-H` are superseding the `-n` namespace option, if `-n` is set together with either `-F` or `-H`.

- v Displays verbose information (for example, subscription state, filter query, handler destination) for each listed instance.
  - F [*fnamespace:*]*filtername*  
Specifies the name of the filter instance used for the subscription operation. If the filter namespace [*fnamespace:*] is not specified, the operation is using the namespace of the subscription.
  - H [*hnamespace:*][*hclassname.*]*handlername*  
Specifies the name of the handler instance used for the subscription operation. If the handler namespace [*hnamespace:*] is not specified, the operation is using the namespace of the subscription. If the handler class name [*hclassname.*] is not specified, the operation is using the *CIM\_ListenerDestinationCIMXML* handler class name.
- Note:** Currently the only supported handler is an instance of the *CIM\_ListenerDestinationCIMXML* class or subclass.
- n *path*  
Specifies the namespace for the operation. For the -l option, if no namespace is specified, instances in all namespaces are listed. For all other operations, if no namespace is specified, the *cimsub* command operates on instances of the *root/PG\_InterOp* namespace.
- Note:** It is recommended not to use any other namespace for indications than *root/PG\_InterOp*.
- help Displays the command help information.
  - version Displays the CIM server version.

## Examples

The following example lists all subscriptions in the namespace *root/PG\_InterOp* in verbose mode:

```
cimsub -ls -v  
Output:
```

```
Namespace:      root/PG_InterOp  
Filter:         root/PG_InterOp:IndicationTest_indicationFilter  
Handler:        root/PG_InterOp:CIM_ListenerDestinationCIMXML.IndicationTest  
Query:         "SELECT * FROM TestIndication"  
Destination:    http://test.server.com/  
SubscriptionState: Enabled
```

```
cimsub -d -F IndicationTest_indicationFilter -H IndicationTest
```

Disables the subscription specified by -F and -H, and displays the result in verbose mode.



### **APPL=ENV**

The indicator for the CIM server to display the value of one or all environment variables that are currently defined for the CIM server address space.

To display a list of all defined environment variables, issue the command without further parameters.

To display the value of a single environment variable, specify the *varname* parameter.

*varname*

The name of an environment variable to be displayed.

## **Examples**

**F CFZCIM,APPL=CONFIG,traceComponents=xml io**

**F CFZCIM,APPL=CONFIG,traceLevel=4**

Turns on tracing of the CIM server's XML traffic.

**F CFZCIM,APPL=CONFIG,enableRemotePrivilegedUserAccess=true,PLANNED**

Permanently enables superusers (UID=0) to issue requests against the CIM server from a remote system.

**F CFZCIM,APPL=ENV**

Displays a list with all currently defined environment variables along with their values.

**F CFZCIM,APPL=ENV,OSBASE\_TRACE**

Displays the current value of the OSBASE\_TRACE environment variable.

---

## **Part 4. Provider reference**





---

## Chapter 13. Profiles

A profile defines the CIM model and its behavior that represents a particular domain to be managed. The CIM model comprises CIM classes, associations, indications, properties, methods, and values to describe the domain and its characteristics.

---

### SMI-S profiles

The Storage Management Initiative Specification (SMI-S) was developed by members of the Storage Networking Industry Association (SNIA) and defines an interface for the secure, extensible, and interoperable management of a distributed and heterogeneous storage system. The specification describes the information available to a WBEM client from an SMI-S compliant CIM WBEM server.

The SMI-S specifies standards-based profiles to manage storage networks. It builds on other standards such as CIM. The scope of SMI-S includes storage, storage virtualizers, fibre channel fabrics and IP connectivity, and host storage-specific CIM-based profiles.

The host storage portion of the specification defines profiles for the management of host-based storage devices.

CIM for z/OS supports the host-based storage profiles:

#### **Host Discovered Resources profile**

The Host Discovered Resources (HDR) profile defines the model for the storage devices presented to z/OS.

#### **SB Multipath Management profile**

The Host Discovered Resource profile defines the model of the logical relationship of a host driver path to a logical unit. The SB Multipath Management profile defines the asynchronous notification of changes applying to this relation, using CIM life cycle indications.

#### **Storage HBA profile**

The Storage Host-Bus-Adapter (HBA) profile represents the manageable elements of an HBA and optionally, the storage connected to it, including the HBA Hot Swap Events for HBA creation and deletion, using CIM life cycle indications.

For more information, refer to the SNIA, Storage Management Initiative Specification (SMI-S) website, *Storage Management Technical Specification, Part 6 Host Elements*.

### **Host Discovered Resources profile**

The Host Discovered Resources profile allows a client application to discover

- the storage hardware resources (such as host adapters and storage devices, and including the connectivity and correlatable names) attached to a host system,
- the logical storage resources (such as special files that represent storage devices) available through the operating system, and
- the relationship between these hardware and logical resources.

Figure 5 shows a Host Discovered Resources instance diagram with the host portion consisting of a ComputerSystem and an Initiator SBProtocolEndpoint and the storage controller portion consisting of a Target SBProtocolEndpoint and a LogicalDisk.

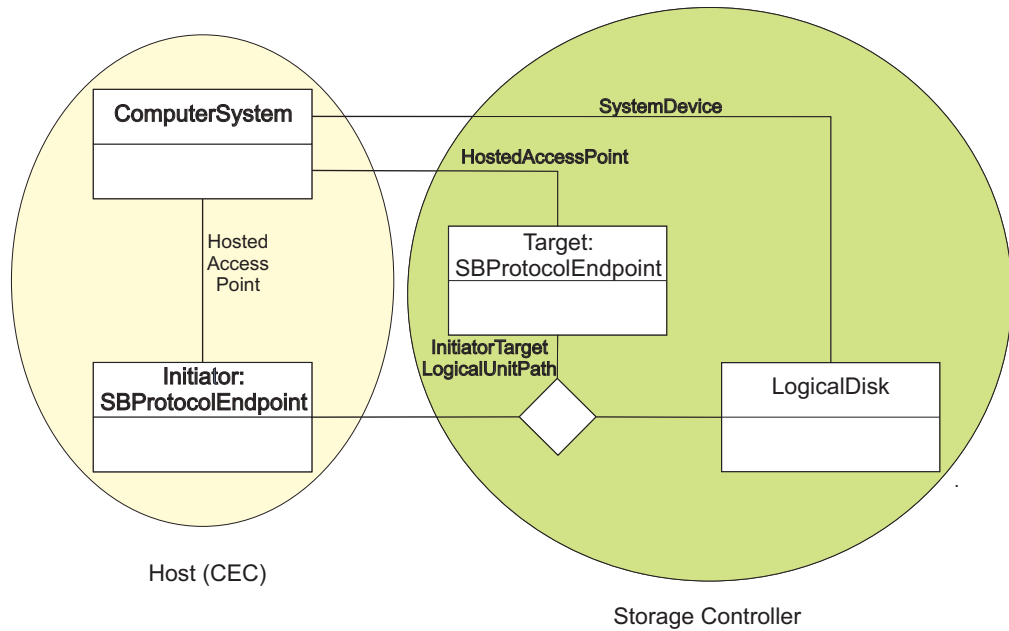

Figure 5. Host Discovered Resources Instance Diagram

### Used CIM elements

Element name	implementing z/OS class	Reference
CIM_ComputerSystem	IBMzOS_ComputerSystem	see page 133
CIM_LogicalDisk	IBMzOS_LogicalDisk	see page 153
CIM_StorageExtent	IBMzOS_LogicalDisk	see page 153
CIM_SystemDevice	IBMzOS_CSFCPortController	see page 268
CIM_ProtocolEndpoint	IBMzOS_SBProtocolEndpoint	see page 261
Association CIM_HostedAccessPoint	Association IBMzOS_SBHostedAccessPoint	see page 274
Association CIM_Initiator TargetLogicalUnitPath	Association IBMzOS_SBInitiator TargetLogicalUnitPath	see page 275

## SB Multipath Management profile

The SB Multipath Management is a subprofile of the Host Discovered Resource profile. This profile provides the asynchronous notification of the creation, state change and deletion of paths between devices and control units. The asynchronous notification is implemented as CIM life cycle indication (CIM\_InstCreation, CIM\_InstModification, CIM\_InstDeletion) for a CIM\_InitiatorTargetLogicalUnitPath.

## Storage HBA profile

The storage Host-Bus-Adapter (HBA) profile represents the manageable elements of an HBA and optionally, the storage connected to it. An HBA can be connected to disks contained within a server's internal drive cage or an external drive enclosure or array.

Figure 6 shows an HBA instance diagram with the FC Initiator Port Subprofile consisting of an SBProtocolEndpoint and FCPortStatistics, providing data and implementation for FCPort.

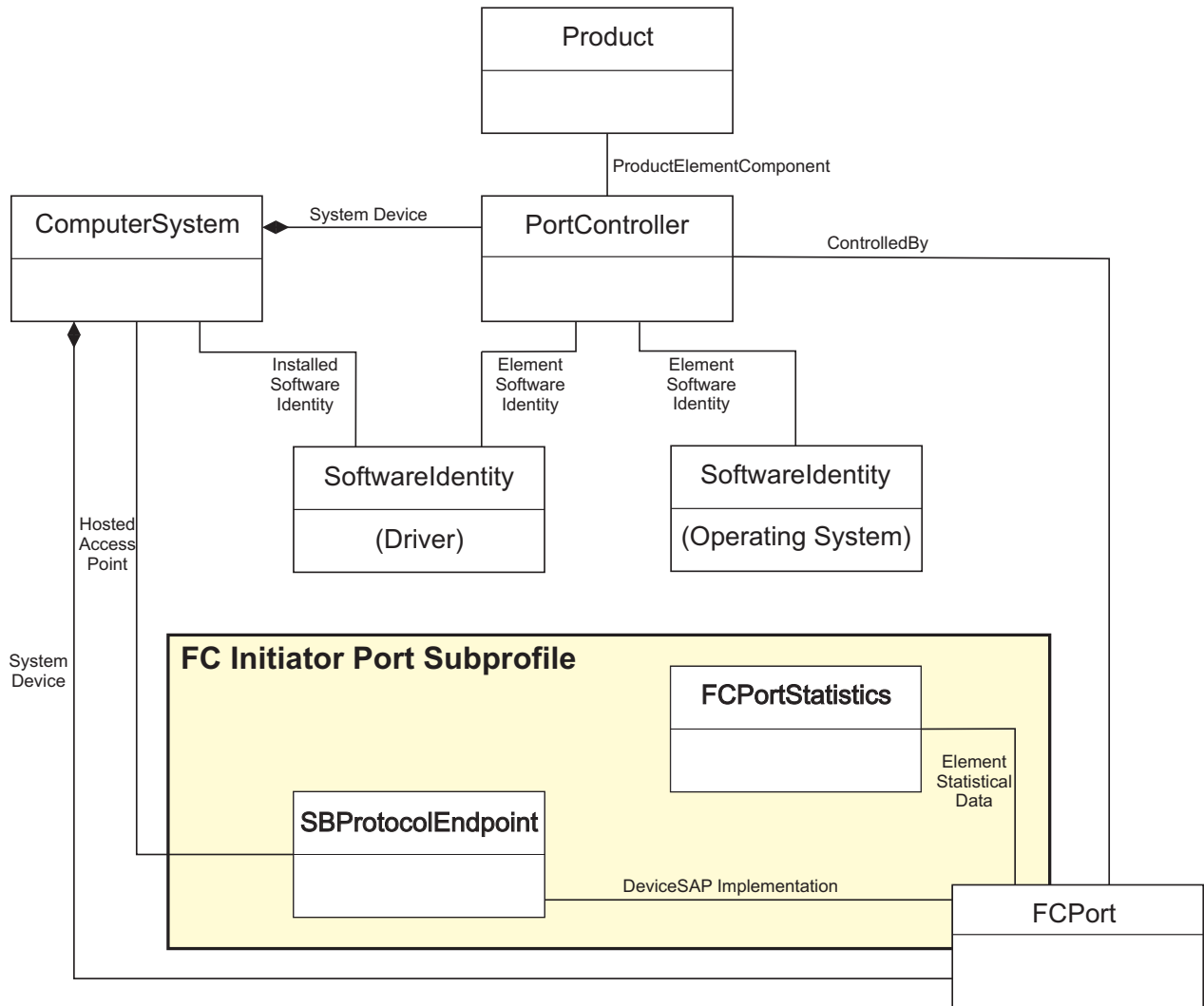

Figure 6. HBA instance diagram

### HBA Hot Swap Events

The CIM server on z/OS implements the HBA Hot Swap Events for the Storage HBA profile using CIM life cycle indications. The notifications indicate the dynamic insertion (CIM\_InstCreation) and deletion (CIM\_InstDeletion) of an HBA represented by a CIM\_PortController (representing a FICON channel port).

## Used CIM elements

Element name	implementing z/OS class	Reference
CIM_FCPort	IBMzOS_FCPort	see page 249
CIM_FCPortStatistics	IBMzOS_FCPortStatistics	see page 255
CIM_PortController	IBMzOS_PortController	see page 258
CIM_Product	IBMzOS_Product	see page 260
CIM_SoftwareIdentity	IBMzOS_SoftwareIdentity	see page 263
CIM_SystemDevice	IBMzOS_CSFCPortController	see page 268
CIM_ProtocolEndpoint	IBMzOS_SBProtocolEndpoint	see page 261
Association CIM_ControlledBy	Association IBMzOS_ControlledBy	see page 266
Association CIM_DeviceSAP Implementation	Association IBMzOS_SBDeviceSAP Implementation	see page 273
Association CIM_ElementSoftwareIdentity	Association IBMzOS _ElementSoftwareIdentity	see page 269
Association CIM_ElementStatisticalData	Association IBMzOS_FCPortStatisticalData	see page 270
Association CIM_HostedAccessPoint	Association IBMzOS_SBHostedAccessPoint	see page 274
Association CIM_InstalledSoftwareIdentity	Association IBMzOS _InstalledSoftwareIdentity	see page 271
Association CIM_Product ElementComponent	Association IBMzOS_Product ElementComponent	see page 272
Association CIM_Initiator TargetLogicalUnitPath	Association IBMzOS_SBInitiator TargetLogicalUnitPath	see page 275

---

## Chapter 14. z/OS Management Instrumentation for CIM

The CIM standard provides the ability to develop management applications that work with systems management data. To work with CIM, developers should have a thorough understanding of the CIM standard defined by the DMTF. For more information about the CIM standard, see Common Information Model (CIM) Standards on the DMTF website.

IBM has developed providers for z/OS that support basic operating system information and some performance metrics. A CIM provider is the link between the CIM server and the system (see Figure 2 on page 5). This interface allows CIM to access and manage the resources. Each CIM provider makes accessible the resources it represents in a standard way.

### Notes:

1. **IBM only supports the classes and properties listed in the present document or in other z/OS documentation provided by IBM. All other classes or properties which are not documented by IBM, IBM does not support, and bears no responsibility for their use.**
2. Not all properties of the supported CIM classes described in this document are implemented by z/OS. Those properties implemented by z/OS are documented in each of the following subchapters. For all CIM properties not implemented by z/OS, the CIM server returns no values.

The following CIM classes and associations are implemented as IBM-supplied providers to provide basic operating system information:

### Base classes

(See page 130)

- IBMzOS\_ComputerSystem: subclass of CIM\_ComputerSystem
- IBMzOS\_OperatingSystem: subclass of CIM\_OperatingSystem
- IBMzOS\_OSProcess: subclass of association CIM\_OSProcess
- IBMzOS\_Process: subclass of CIM\_Process
- IBMzOS\_RunningOS: subclass of association CIM\_RunningOS
- IBMzOS\_UnixProcess: subclass of CIM\_UnixProcess
- IBMzOS\_LogicalDisk: subclass of CIM\_LogicalDisk
- IBMzOS\_LogicalDiskDevice: subclass of association CIM\_SystemDevice

### BaseBoard classes

(See page 143)

- IBM\_BaseBoard: subclass of CIM\_Card
- IBMzOS\_BaseBoard: subclass of IBM\_BaseBoard

### Processor classes

(See page 147)

- IBMzOS\_CSProcessor: subclass of association CIM\_SystemDevice
- IBMzOS\_Processor: subclass of CIM\_Processor

### File System classes

(See page 155)

- IBMzOS\_HostedFileSystem: subclass of association CIM\_HostedFileSystem

- IBMzOS\_NFS: subclass of CIM\_NFS
- IBMzOS\_UnixLocalFileSystem: subclass of CIM\_UnixLocalFileSystem

#### Network classes

(See page 160)

- IBMzOS\_EthernetPort: subclass of CIM\_EthernetPort
- IBMzOS\_CSNetworkPort: subclass of association CIM\_SystemDevice
- IBMzOS\_IPProtocolEndpoint: subclass of CIM\_IPProtocolEndpoint
- IBMzOS\_NetworkPortImplementsIPEndpoint: subclass of association CIM\_PortImplementsEndpoint

#### Job classes

(See page 167)

- IBMzOS\_Job: subclass of CIM\_Job
- IBMzOS\_JES2Job: subclass of IBMzOS\_Job
- IBMzOS\_JES3Job: subclass of IBMzOS\_Job
- IBMzOS\_SysoutDataset: subclass of CIM\_LogicalFile
- IBMzOS\_JES2SysoutDataset: subclass of IBMzOS\_SysoutDataset
- IBMzOS\_JES3SysoutDataset: subclass of IBMzOS\_SysoutDataset
- IBMzOS\_Subsystem: subclass of CIM\_Service
- IBMzOS\_JobsManagementSettings: subclass of CIM\_SettingData
- association IBMzOS\_SubsystemJES2Jobs (between IBMzOS\_Subsystem and IBMzOS\_JES2Job)
- association IBMzOS\_SubsystemJES3Jobs (between IBMzOS\_Subsystem and IBMzOS\_JES3Job)
- association IBMzOS\_UsesJES3SysoutDatasets (between IBMzOS\_JES3Job and IBMzOS\_JES3SysoutDataset)
- association IBMzOS\_UsesJES2SysoutDatasets (between IBMzOS\_JES2Job and IBMzOS\_JES2SysoutDataset)

#### Cluster classes

(See page 200)

- IBMzOS\_Sysplex: subclass of IBMzOS\_Cluster
- IBMzOS\_SysplexNode: subclass of IBMzOS\_ClusterNode
- IBMzOS\_CouplingFacility: subclass of IBMzOS\_ClusterAggregatedResource
- IBMzOS\_CFStructure: subclass of IBMzOS\_ClusterAggregatedResource
- IBMzOS\_CFStructureConnector: subclass of IBMzOS\_ClusterResource
- IBMzOS\_ClusterResource
- IBMzOS\_ClusterGlobalResource
- IBMzOS\_ClusterAggregatedResource
- IBMzOS\_Cluster
- IBMzOS\_ClusterNode
- IBMzOS\_CoupleDataset: subclass of CIM\_LogicalFile
- IBMzOS\_SysplexCoupleDataset: subclass of IBMzOS\_CoupleDataset
- IBMzOS\_CFRMCoupleDataset: subclass of IBMzOS\_CoupleDataset
- IBMzOS\_CouplingFunction: subclass of IBMzOS\_ClusterAggregatedResource
- IBMzOS\_CFRMPolicy: subclass of IBMzOS\_ClusterAggregatedResource

- association IBMzOS\_CollectionOfSysplexNodes
- association IBMzOS\_CollectionOfCFs
- association IBMzOS\_HostedCFStructure
- association IBMzOS\_HostedCFStrConnector
- association IBMzOS\_CFStructureDependsOn
- association IBMzOS\_UsesCFs
- association IBMzOS\_UsesCouplingFunctions
- association IBMzOS\_UsesSysplexCoupleDatasets
- association IBMzOS\_UsesCFRMCoupleDatasets
- association IBMzOS\_UsesCFRMPolicies

#### **Cluster indications**

- IBMzOS\_SysplexInstCreation
- IBMzOS\_SysplexInstModification
- IBMzOS\_Sysplex\_ReallocateInitiated
- IBMzOS\_Sysplex\_ReallocateCompleted
- IBMzOS\_Sysplex\_CFRM\_CDS\_Initialized
- IBMzOS\_SysplexNodeInstCreation
- IBMzOS\_SysplexNodeInstDeletion
- IBMzOS\_SysplexNodeInstModification
- IBMzOS\_CouplingFacilityInstCreation
- IBMzOS\_CouplingFacilityInstDeletion
- IBMzOS\_CouplingFacilityInstModification
- IBMzOS\_CFStructureInstCreation
- IBMzOS\_CFStructureInstDeletion
- IBMzOS\_CFStructureInstModification
- IBMzOS\_CFStrConnectorInstCreation
- IBMzOS\_CFStrConnectorInstDeletion
- IBMzOS\_CFStrConnectorInstModification
- IBMzOS\_CollectionOfSysplexNodesInstCreation
- IBMzOS\_CollectionOfSysplexNodesInstDeletion
- IBMzOS\_CollectionOfCFsInstCreation
- IBMzOS\_CollectionOfCFsInstDeletion
- IBMzOS\_HostedCFStructureInstCreation
- IBMzOS\_HostedCFStructureInstDeletion
- IBMzOS\_HostedCFStrConnectorInstCreation
- IBMzOS\_HostedCFStrConnectorInstDeletion
- IBMzOS\_UsesCFInstCreation: subclass of CIM\_InstCreation
- IBMzOS\_UsesCFInstDeletion: subclass of CIM\_InstDeletion

#### **Storage management classes**

(See page 241)

- CIM\_StorageExtent
- IBMzOS\_FCCUPort
- IBMzOS\_FCPort
- IBMzOS\_FCPortStatistics
- IBMzOS\_FCSBPort

- IBMzOS\_PortController
- IBMzOS\_Product
- IBMzOS\_SBProtocolEndpoint
- IBMzOS\_SoftwareIdentity
- association IBMzOS\_ControlledBy
- association IBMzOS\_CSFCPort
- association IBMzOS\_CSFCPortController
- association IBMzOS\_ElementSoftwareIdentity
- association IBMzOS\_FCPortStatisticalData
- association IBMzOS\_InstalledSoftwareIdentity
- association IBMzOS\_ProductElementComponent
- association IBMzOS\_SBDeviceSAPImplementation
- association IBMzOS\_SBHostedAccessPoint
- association IBMzOS\_SBInitiatorTargetLogicalUnitPath

#### **Storage management indications**

For CIM\_PortController:

- CIM\_InstCreation
- CIM\_InstDeletion

For CIM\_InitiatorTargetLogicalUnitPath:

- CIM\_InstCreation
- CIM\_InstDeletion
- CIM\_InstModification

#### **WLM classes**

(See page 277)

- IBMzOS\_WLM
- association IBMzOS\_WLMOS (between IBMzOS\_WLM and IBMzOS\_ComputerSystem)

#### **WLM indications**

- IBMzOS\_WLMPolicyActivationIndication

#### **CIM classes implemented by RMF**

Please note that for using the CIM providers implemented by RMF you need to have RMF installed and additional configuration is required (see “Setting up the CIM server for RMF monitoring” on page 37). For more information, see *z/OS RMF Programmer’s Guide* and *z/OS RMF User’s Guide*.

- IBMzOS\_BaseMetricValue
- IBMzOS\_BaseMetricDefinition
- IBMzOS\_MetricForME
- IBMzOS\_MetricDefForME
- IBMzOS\_MetricInstance
- IBMzOS\_Channel
- IBMz\_CEC
- IBMz\_ComputerSystem
- IBMzOS\_WLMServiceDefinition
- IBMzOS\_WLMServiceClassPeriod

To exploit this functionality, RMF must be installed and running.



**Notes:**

1. The z/OS Communications Server provides documentation of these CIM classes. For details refer to Considerations for Common Information Model (CIM) providers in *z/OS Communications Server: IP Configuration Guide*.
2. For all classes, the properties that are common for eServer and the z/OS specific properties are documented in separate tables.
3. Starting with z/OS 1.9, the CIM server exploits the functionality of Common event adapter (CEA). CEA is a z/OS component that provides the ability to deliver z/OS events to C-language clients. A CEA address space is started automatically during initialization of every z/OS system. In order for the address space to start successfully, you must configure CEA to work with z/OS. Failure to do so will cause CEA to run in a minimum function mode. For details refer to *z/OS Planning for Installation*.
4. An extra security setup is needed for the Job and Cluster classes.

To understand the syntax of the graphics showing class structures, see “Legend for graphics showing class structures” on page 359.

---

## Supported CIM operations

While the z/OS CIM server supports all of the CIM operations from the DMTF's *CIM Operations over HTTP* specification, only a specific subset of operations is supported by the OS management CIM providers delivered with this release of z/OS.

The following operations are available for all OS management classes or for association classes.

**Available for all OS management classes:**

- EnumerateInstanceNames
- EnumerateInstances
- GetInstance

**Additionally available for all association classes:**

- Associators
- AssociatorNames
- References
- ReferenceNames

# OS management Base classes

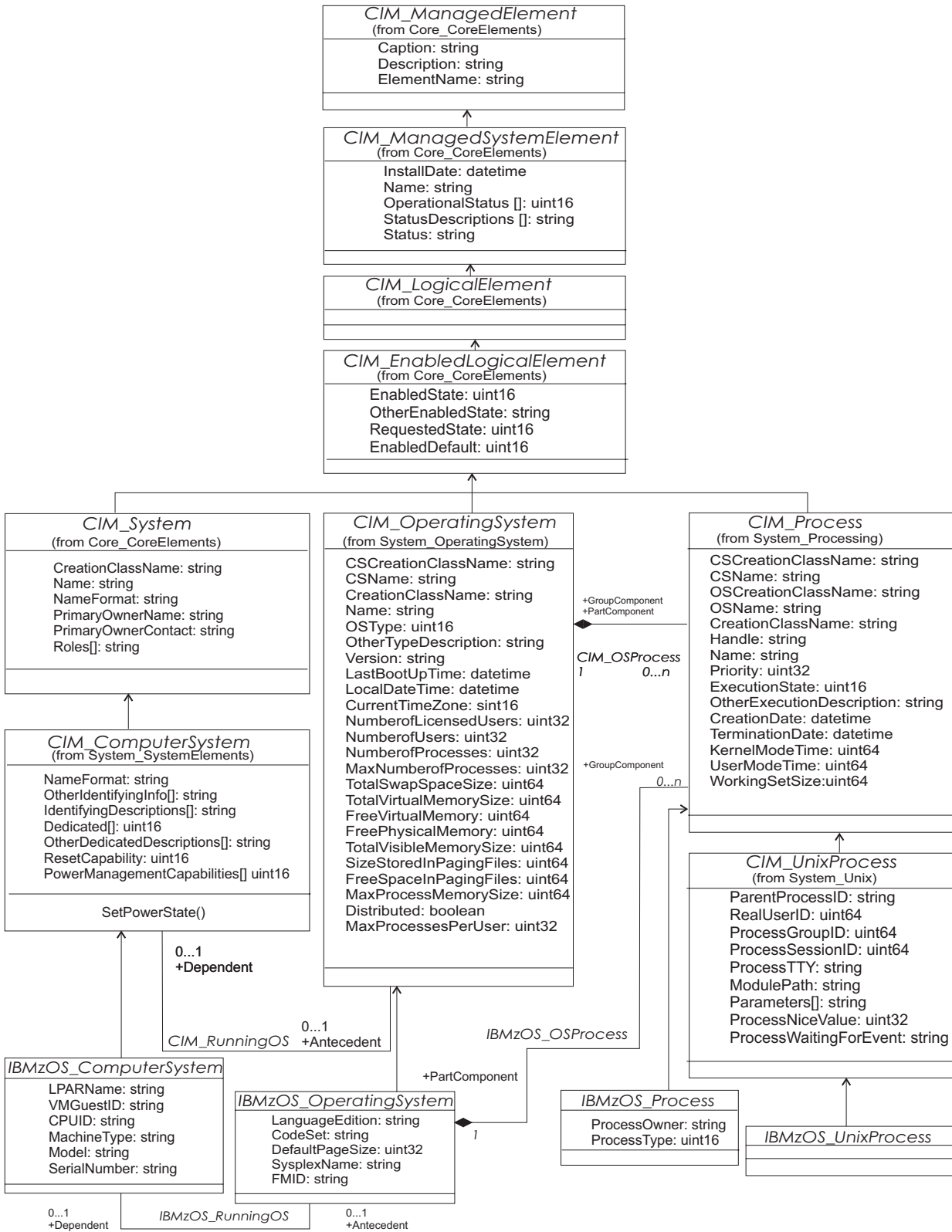

Figure 7. CIM Base classes extended by z/OS-specific classes (1)

Figure 7 on page 130 illustrates the relationship between the IBM extension classes, and the CIM Base classes that they extend. The packages, in which the classes are defined in the CIM Schema, are indicated in parenthesis. The DMTF website provides a detailed description of the CIM base classes. The z/OS-specific classes are described in detail in the following chapters.

The MOF files that define these classes can be found in directory *schemas/os\_management* relative to where the providers for z/OS have been installed. The default is */usr/lpp/wbem/provider*.

## CIM\_ComputerSystem

### Purpose

This class represents either virtual or physical computer systems in the sense of a container inside which an operating system may run. This is the central class of the OS Management data model and aggregates all other resource classes.

### Inheritance

The z/OS specific subclass is IBMzOS\_ComputerSystem (see “IBMzOS\_ComputerSystem” on page 133).

Additional subclasses of CIM\_ComputerSystem are implemented by RMF, namely IBMz\_ComputerSystem (LPARs) and IBMz\_CEC. Unless RMF is installed or the RMF CIM providers have been set up appropriately, no instances or errors for those classes will be reported, for example by an *enumerateInstances* operation against class CIM\_ComputerSystem. Errors for the classes supported by RMF are only reported when a CIM operation is invoked directly against one of the specific subclasses like IBMz\_ComputerSystem.

For further details on classes IBMz\_ComputerSystem and IBMz\_CEC, see the z/OS *RMF Programmer's Guide*.

## CIM\_OperatingSystem

### Purpose

This class represents a running operating system with its basic properties.

### Inheritance

The z/OS specific subclass is IBMzOS\_OperatingSystem (see “IBMzOS\_OperatingSystem” on page 135).

## CIM\_OSProcess

### Purpose

This class associates an operating system with the set of currently active address spaces and UNIX System Services processes.

### Inheritance

The z/OS specific subclass is IBMzOS\_OSProcess (see “IBMzOS\_OSProcess” on page 137).

## **CIM\_Process**

### **Purpose**

This class represents currently active processes on an operating system. For z/OS this is mapped to address spaces and UNIX System Services processes.

### **Inheritance**

The z/OS specific subclasses are:

- IBMzOS\_Process (for address spaces) (see “IBMzOS\_Process” on page 138)
- IBMzOS\_UnixProcess (for UNIX System Services processes) (see “IBMzOS\_UnixProcess” on page 141)

## **CIM\_RunningOS**

### **Purpose**

This class associates a computer system with the currently running operating system (see Figure 7 on page 130).

### **Inheritance**

The z/OS specific subclass is IBMzOS\_RunningOS (see “IBMzOS\_RunningOS” on page 140).

# IBMzOS\_ComputerSystem

## Purpose

This class provides basic computer system information such as computer name, and status information. A provider instruments this class so that it can be used by client applications to identify the managed system on which the provider is running (typically a server or an application).

## Inheritance

CIM\_ManagedElement  
← CIM\_ManagedSystemElement  
← CIM\_LogicalElement  
← CIM\_EnabledLogicalElement  
← CIM\_System  
← CIM\_ComputerSystem  
← IBMzOS\_ComputerSystem

## Module name

The module name of the CMPI provider that is registered for a CIM class which is used by the cimprovider command line tool for the administration of CMPI providers is

IBMzOS\_ComputerSystemProviderModule

## Provider library

The physical name of a CMPI provider's shared object library as it is stored in the hierarchical file system is

libcmpiOSBase\_ComputerSystemProvider.so

## Used by the following CIM profiles

- Host Discovered Resources Profile
- IBM OS management

## Properties

The following properties are common for eServer:

### string Caption

Always set to IBM z/OS Computer System.

### string Description

Always set to This is an IBMzOS\_ComputerSystem.

### string ElementName

Returns IBM:*model*

### string Name [key]

The fully qualified IP host name.

### string CreationClassName [key]

Always set to IBMzOS\_ComputerSystem

### string NameFormat

Describes the format used to build the Name property. Always set to IP.

### uint16 Dedicated[]

Indicates whether this is a special purpose system. Always set to 0 (not dedicated).

**string UUID** The universally unique identifier of the server. For z/OS, no value is supplied for this property, but it is maintained for compatibility with the other IBM eServer platforms.

**string HostingSystemName**  
A name that identifies the underlying hosting system in a virtualized environment. Returns *Elementname + serialnumber*.

**string HostingSystemNameFormat**  
The name format used for HostingSystemName. Always returns Other.

The following properties have data that may be specific to z/OS, or may map to z/OS specific attributes.

**string LPARName**  
Name of the zSeries® logical partition that makes up the computer system. If not running in LPAR mode, a blank string is returned here.

**string VMGuestID**  
z/VM® user ID of the virtual machine, of which the current z/OS image is a guest. If z/OS is not running as a guest under z/VM, a blank string is returned here.

**string CPUID** String containing the readable part of the serial number concatenated with the model number.

**string SerialNumber**  
IBM allocated number used to identify the server on which this computer system is running.

**string MachineType**  
Processor family of this z/OS server.

**string Model** Model number of the server.

**string Manufacturer**  
The name of the company that produced the server.

**uint16 LPARid**  
Logical partition number. This number distinguishes the configuration from all other level-2 configurations provided by the same LPAR hypervisor.

**string Plant** Plant of manufacturer for the CPU.

## IBMzOS\_OperatingSystem

### Purpose

This class is for use by client applications to obtain basic properties of a running z/OS operating system.

### Inheritance

CIM\_OperatingSystem  
← IBMzOS\_OperatingSystem

### Module name

The module name of the CMPI provider that is registered for a CIM class which is used by the cimprovider command line tool for the administration of CMPI providers is

IBMzOS\_OperatingSystemProviderModule

### Provider library

The physical name of a CMPI provider's shared object library as it is stored in the hierarchical file system is

libcmplOSBase\_OperatingSystemProvider.so

### Properties

The following properties are common for eServer:

#### string Name [key]

The name of the z/OS operating system.

#### uint16 OperationalStatus[]

Overall system status.

#### uint16 OSType

Always 68 ('z/OS').

**string Version** Version, release and modification of the operating system in the format of "VV.RR.MM". For example, for z/OS V1.7.0, this will return "01.07.00".

#### datetime LastBootUpTime

Time when the operating system was IPLed.

#### datetime LocalDateTime

Local time of the operating system

#### sint16 CurrentTimeZone

Time zone for the operating system, offset in minutes from GMT.

#### uint32 NumberOfUsers

The number of currently logged on TSO and UNIX System Services users.

#### uint32 NumberOfProcesses

Total number of UNIX processes and active address spaces.

#### uint32 MaxNumberOfProcesses

The maximum number of processes configured in MaxProcSys.

#### uint64 MaxProcessMemorySize

The maximum number of KBytes of memory that can be allocated to a process (RLIMIT\_AS).

**uint64 TotalVirtualMemorySize**

Total number of KBytes of virtual memory available to the operating system.

**uint64 FreeVirtualMemory**

Number of KBytes of virtual memory currently unused and available.

**uint64 FreePhysicalMemory**

Number of KBytes of physical memory currently unused and available.

**uint64 TotalVisibleMemorySize**

The total amount of physical memory (in KBytes) available to the operating system.

**uint64 SizeStoredInPagingFiles**

The total number of KBytes that can be stored in the operating system's page data sets.

**uint64 FreeSpaceInPagingFiles**

The total number of KBytes currently free in the operating system's page data sets.

The following properties have data that may be specific to z/OS, or may map to z/OS specific attributes.

**string LanguageEdition**

eServer specific extension for the language version of the OS. For z/OS always returns 'en-US'.

**string CodeSet**

eServer specific extension for the default OS code page. For z/OS this returns the code page for the CIM server process.

**uint32 DefaultPageSize**

eServer specific extension. The default size of pages used by the virtual memory management in units of bytes. Always 4096 for z/OS.

**string SysplexName**

The name of the z/OS Sysplex to which this operating system belongs.

**string FMID** Function modification identifier of the z/OS operating system.

**uint32 LastBootUpDuration**

Indicates the time in seconds used to complete the IPL.

**string IPLProfile[]**

HMC profile from which the operating system was IPLed. IPLProfile contains 4 elements:

<b>ipaiodfu</b>	IODF unit address
<b>ipalloads</b>	LOADxx suffix
<b>ipaprompt</b>	Operator prompt flag
<b>ipanucid</b>	Nucleus ID

**string sequentialReleaseNumber**

Release number of the operating system as an ever increasing number, e.g. 21.00 for z/OS 1.11.



## IBMzOS\_OSProcess

### Purpose

This class provides a link between the operating system and process(es) running in the context of this operating system. Client applications can use this provider to give clients an understanding of the processes (jobs) running on the managed system within the context of its operating system.

### Inheritance

CIM\_OSProcess  
← IBMzOS\_OSProcess

### Module name

The module name of the CMPI provider that is registered for a CIM class which is used by the cimprovider command line tool for the administration of CMPI providers is

IBMzOS\_OSProcessProviderModule

### Provider library

The physical name of a CMPI provider's shared object library as it is stored in the hierarchical file system is

libcmpiIBMzOS\_OSProcessProvider.so

## IBMzOS\_Process

### Purpose

This class provides basic process information such as process name, priority, and run-time state. Instances of class IBMzOS\_Process are mapped to z/OS address spaces. Client applications can use this class to give clients an understanding of the processes (address spaces) running on the managed system within the context of their operating system.

**Note:** z/OS also provides the notion of a UNIX process through the UNIX System Services. In addition, those processes running under UNIX System Services are supported by the extra IBMzOS\_UnixProcess class which is derived from class CIM\_UnixProcess. When a client enumerates all instances of class CIM\_Process, it gets the complete list of z/OS address spaces, as well as all processes running under UNIX System Services. However, if the client enumerates the instances of class IBMzOS\_Process directly, it only gets the list of address spaces since class IBMzOS\_UnixProcess is not derived from IBMzOS\_Process but only from CIM\_UnixProcess. Ideally, IBMzOS\_UnixProcess should inherit from IBMzOS\_Process, besides inheriting from CIM\_UnixProcess, however, multiple inheritance is not the current standard in CIM version 2. For inheritance information of the mentioned classes refer to Figure 7 on page 130.

### Inheritance

CIM\_Process  
← IBMzOS\_Process

### Module name

The module name of the CMPI provider that is registered for a CIM class which is used by the cimprovider command line tool for the administration of CMPI providers is

IBMzOS\_ProcessProviderModule

### Provider library

The physical name of a CMPI provider's shared object library as it is stored in the hierarchical file system is

libcmplOSBase\_ProcessProvider.so

### Properties

The following properties are common for eServer:

**string Name** The name of the z/OS address space.

**string Handle [key]**  
The decimal representation of the address space ID(ASID).

**uint32 Priority**  
The address space's dispatching priority.

**datetime CreationDate**  
The time when the address space was created.

**uint64 KernelModeTime**  
Not supported for z/OS.

**uint64 UserModeTime**  
Not supported for z/OS.

The following properties have data that may be specific to z/OS, or may map to z/OS specific attributes:

**string ProcessOwner**

The primary z/OS user ID under which an address space was started.

**uint16 ProcessType**

The type of address space. Possible values are: 0 (Other), 1 (TSO User), 2 (Started Task), 3 (Job), 4 (System Address Space), 5 (Initiator).

## IBMzOS\_RunningOS

### Purpose

This class is for use by clients to find associations between a computer system and the operating system that is currently running on the computer system.

### Inheritance

CIM\_OperatingSystem

← IBMzOS\_OperatingSystem

### Module name

The module name of the CMPI provider that is registered for a CIM class which is used by the cimprovider command line tool for the administration of CMPI providers is

IBMzOS\_RunningOSProviderModule

### Provider library

The physical name of a CMPI provider's shared object library as it is stored in the hierarchical file system is

libcmpiIBMzOS\_RunningOSProvider.so

## IBMzOS\_UnixProcess

### Purpose

This class provides basic information about z/OS processes running in the UNIX System Services subsystem. It supports all properties from CIM\_Process plus a set of properties typical for UNIX processes.

### Inheritance

Class IBMzOS\_UnixProcess is not derived from IBMzOS\_Process, and therefore no instances of IBMzOS\_UnixProcess are returned when a client enumerates the instances of class IBMzOS\_Process, rather than class CIM\_Process.

```
CIM_Process
  ← IBMzOS_UnixProcess
```

### Module name

The module name of the CMPI provider that is registered for a CIM class which is used by the cimprovider command line tool for the administration of CMPI providers is

```
IBMzOS_UnixProcessProviderModule
```

### Provider library

The physical name of a CMPI provider's shared object library as it is stored in the hierarchical file system is

```
libcmpiOSBase_UnixProcessProvider.so
```

### Properties

The following properties are common for eServer:

**string Name** The name of the z/OS UNIX process. This is usually the name of the executable that started the process.

**string Handle [key]**  
The z/OS UNIX process ID.

**uint32 Priority**  
The process priority.

**uint16 ExecutionState**  
The process state (ready, blocked, suspended, stopped, and so on).

**datetime CreationDate**  
The time when the process was started.

**uint64 KernelModeTime**  
Not supported on z/OS.

**uint64 UserModeTime**  
Not supported on z/OS.

**string ParentProcessID**  
The parent process ID.

**uint64 RealUserID**  
The real user ID.

**uint64 ProcessGroupID**  
The process group ID.

**uint64 ProcessSessionID**  
The process session ID.

**string ProcessTTY**

The TTY currently associated with this process.

**string ModulePath**

The executing process's command path.

**string Parameters[]**

The operating system parameters provided to the executing process. These are the argv[] values.

Class IBMzOS\_UnixProcess has no z/OS specific properties.

## OS management BaseBoard classes

Figure 8 illustrates the relationship between the IBM extension classes, and the CIM BaseBoard classes that they extend. The packages, in which the classes are defined in the CIM Schema, are indicated in parenthesis. The DMTF website provides a detailed description of the CIM BaseBoard classes. The z/OS-specific classes are described in detail in the following chapters.

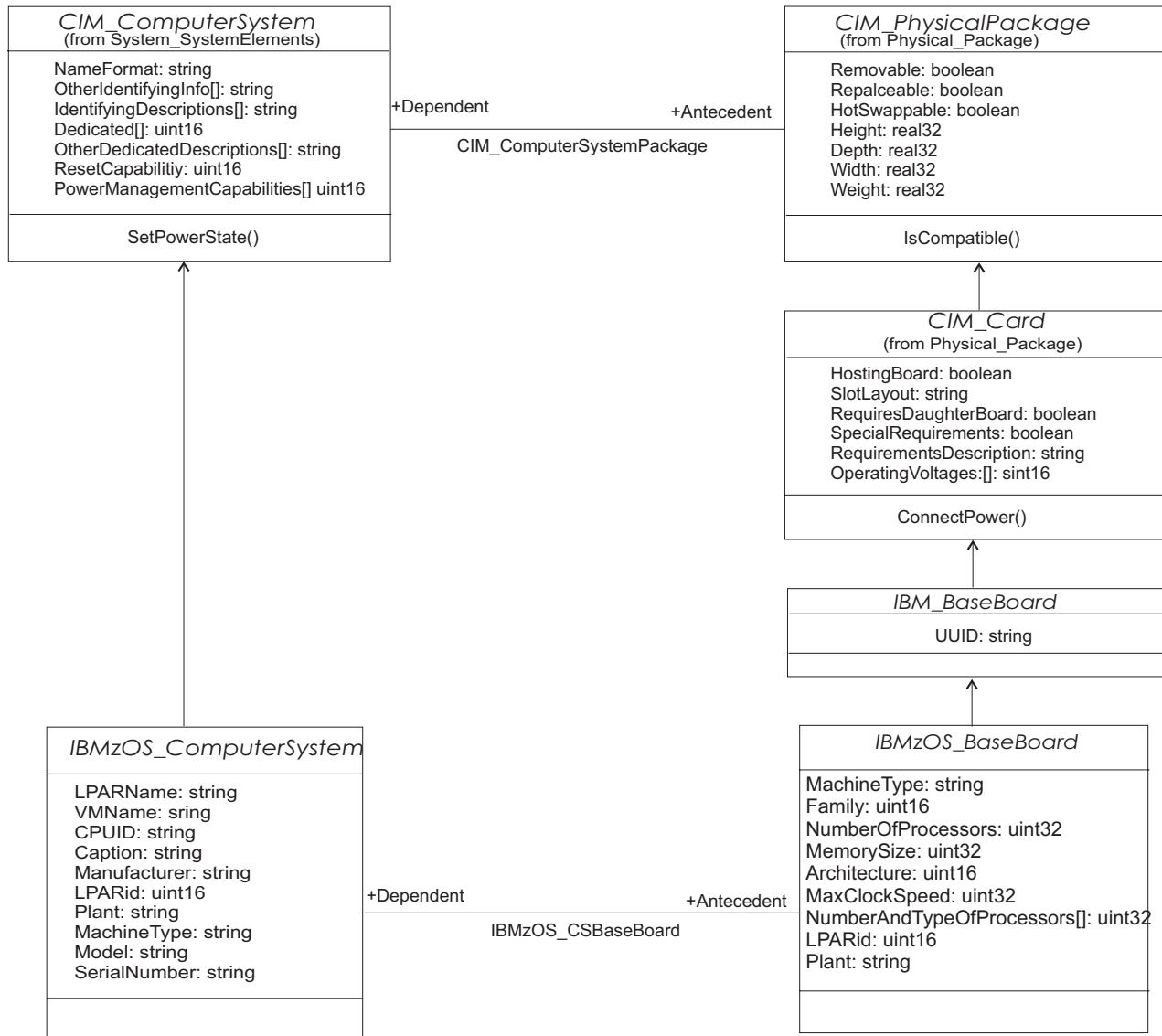

Figure 8. OS management BaseBoard Class

## IBM\_BaseBoard

### Purpose

This class represents the unique characteristics of the physical hardware as recognized by the z/OS operating system running on that hardware (the inband view). On most platforms these are the characteristics of the main board, and therefore, the name IBM\_BaseBoard was chosen for this class. Instances of this class are either identified by a unique ID that was assigned to the main board (property *UUID*) or by the combination of manufacturer, model and serial number. The major purpose of this class is to provide the ability to determine which instances of computer systems are running on the same physical hardware.

### Inheritance

The z/OS specific subclass is IBMzOS\_BaseBoard (see “IBMzOS\_BaseBoard” on page 145).

### Properties

The following properties are common for eServer:

#### string Caption

Always returns *'Base Board'*.

#### string Description

Always returns *'A class derived from Card to deliver the systems base board hardware information.'*

#### string ElementName

Same as property *Tag*.

#### string Tag [key]

A combination of manufacturer, model and serial number in the following format: *manufacturer:model:serialnumber*.

#### string CreationClassName [key]

Always returns *'IBMzOS\_BaseBoard'*.

#### string SerialNumber

IBM allocated number used to identify the CEC.

#### string Model

The model number of the CEC, for example *'314'*.

#### string Manufacturer

The name of the company that produced the CEC.

#### string PartNumber

Not supported for z/OS.

#### boolean HostingBoard

Always returns TRUE, indicating that this card is a main board.

#### string UUID

The unique ID assigned to the main board. For z/OS, no value is supplied for this property, but it is maintained for compatibility with the other IBM eServer platforms.



# IBMzOS\_BaseBoard

## Inheritance

IBM\_BaseBoard  
← IBMzOS\_BaseBoard

## Module name

The module name of the CMPI provider that is registered for a CIM class which is used by the cimprovider command line tool for the administration of CMPI providers is

IBMzOS\_BaseBoardProviderModule

## Provider library

The physical name of a CMPI provider's shared object library as it is stored in the hierarchical file system is

libcmpiOSBase\_BaseBoardProvider.so

## Properties

The following properties have data that may be specific to z/OS, or may map to z/OS specific attributes.

### string MachineType

Processor type for the class of this z/OS server, for example: 2084

**uint16 Family** The processor family. For z/OS, a value of 204 (z/Architecture<sup>®</sup> base) is returned.

### uint32 NumberOfProcessors

The number of general purpose processors installed on the system board.

### uint32 MemorySize

The total amount of physical memory (in Kbytes) available to the operating system through which this data was provided. Note that this is not the total amount of installed memory for the zSeries CEC. This is the inband view of z/OS.

### uint16 Architecture

The processor architecture.

### uint32 NumberAndTypeOfProcessors[]

An array of uint32 where the first element is the number of general purpose processors, the second element is the number of zAAPs, the third element is the number of zIIPs, if supported.

### uint16 LPARid

Logical partition number. This number distinguishes the configuration from all other level-2 configurations provided by the same LPAR hypervisor.

**string Plant** Plant of manufacturer for the CPU.

## Association CIM\_ComputerSystemPackage

### Purpose

This class associates a ComputerSystem with the physical main board of the system on which it runs.

### Inheritance

The z/OS specific subclass is IBMzOS\_CSBaseBoard (see “Association IBMzOS\_CSBaseBoard”).

## Association IBMzOS\_CSBaseBoard

### Purpose

This class associates a z/OS computer system with the physical zSeries CEC on which it runs (see Figure 8 on page 143). It has no properties.

### Inheritance

CIM\_ComputerSystemPackage  
← IBMzOS\_CSBaseBoard

### Module name

The module name of the CMPI provider that is registered for a CIM class which is used by the cimprovider command line tool for the administration of CMPI providers is

IBMzOS\_CSBaseBoardProviderModule

### Provider library

The physical name of a CMPI provider's shared object library as it is stored in the hierarchical file system is

libcmpiIBMzOS\_CSBaseBoardProvider.so

## OS management Processor classes

Figure 9 illustrates the relationship between the IBM extension classes, and the CIM Processor classes that they extend. The packages, in which the classes are defined in the CIM Schema, are indicated in parenthesis. The DMTF website provides a detailed description of the CIM Processor classes. The z/OS-specific classes are described in detail in the following chapters.

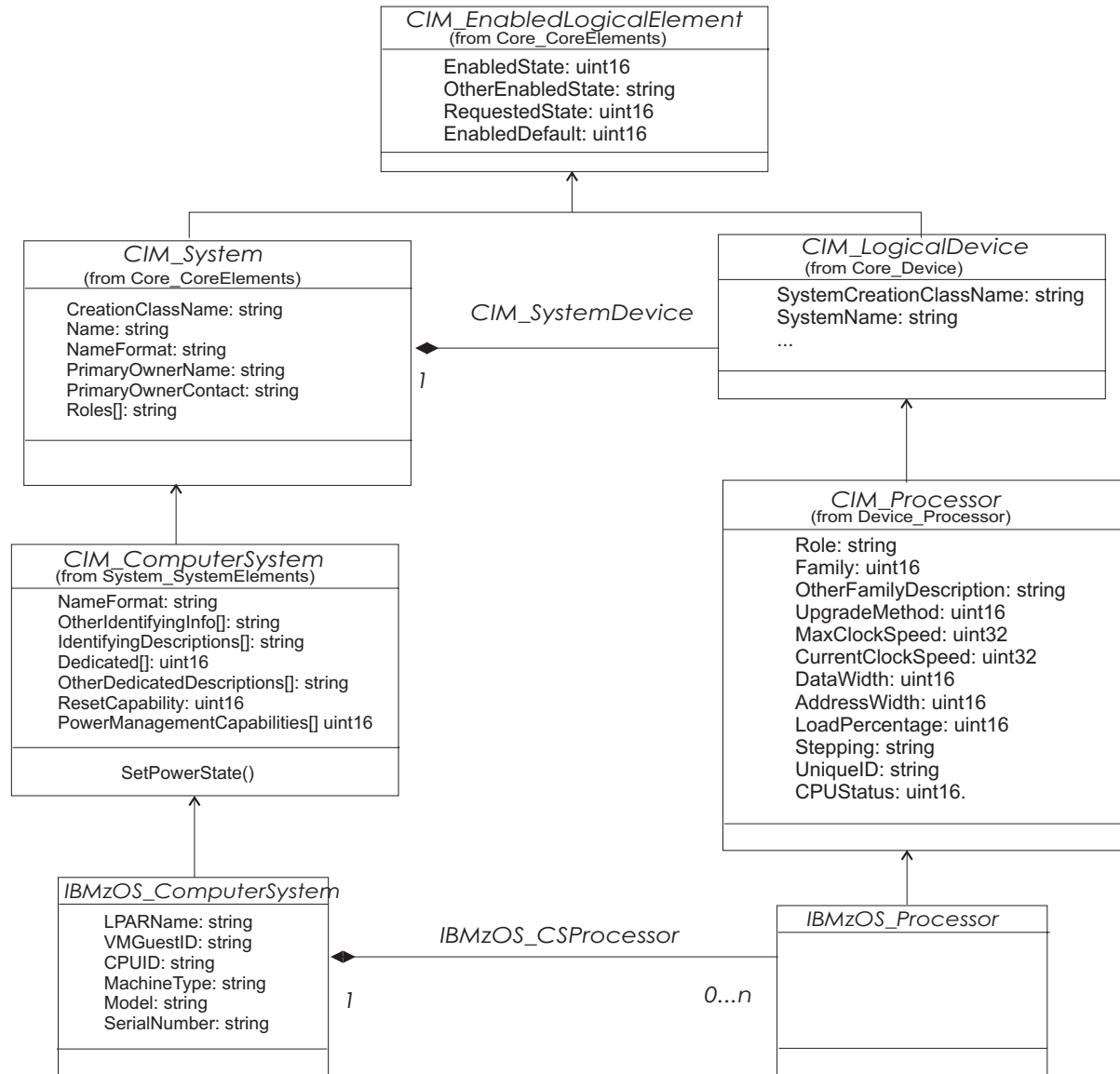

Figure 9. OS management Processor classes

## **CIM\_Processor**

### **Purpose**

This class represents the physical processors that are available to the operating system.

### **Inheritance**

The z/OS specific subclass is IBMzOS\_Processor (see “IBMzOS\_Processor” on page 149).

## **Association CIM\_SystemDevice**

### **Purpose**

This class associates a ComputerSystem with the instrumented processors.

### **Inheritance**

The z/OS specific subclass is IBMzOS\_CSProcessor.

# IBMzOS\_Processor

## Inheritance

CIM\_Processor  
← IBMzOS\_Processor

## Module name

The module name of the CMPI provider that is registered for a CIM class which is used by the cimprovider command line tool for the administration of CMPI providers is

IBMzOS\_ProcessorProviderModule

## Provider library

The physical name of a CMPI provider's shared object library as it is stored in the hierarchical file system is

libIBMzOS\_Processor.so

## Properties

The following properties are common for eServer:

### string Caption

Always set to *'zSeries logical processor'*.

### string Description

Always set to *'This class represents instances of processors currently available to the z/OS operating system'*.

### string ElementName

Same as DeviceID.

### string DeviceID [key]

Concatenation of the CPUID of the physical processor (PCCACPID) + colon (':') + CPU address. CBA987654321:2 is an example for a valid DeviceID.

If a CPU is in Reserved or Offline state, the CPUID is FFFFFFFFFF.

### uint16 EnabledState

2	Online
3	Reserved
6	Offline
9	Offline by WLM

### string Role

CP	Central Processor (including zEAP Processors)
ZIIP	zIIP processor
ZAAP	zAAP processor
UNKNOWN	no assigned role

uint16 Family 200 (*'S/390<sup>®</sup> and zSeries Family'*).

### string OtherFamilyDescription

*'S/390 and zSeries Family'* or specific model like *'z990'*.

### uint32 MaxClockSpeed

Not supported for z/OS.

### uint32 CurrentClockSpeed

Not supported for z/OS.

**uint16 LoadPercentage**

For z/OS provided through RMF metrics provider only.

**string Stepping**

Not supported for z/OS.

**string UniqueID**

CPUID of the physical processor (PCCACPID).

**uint16 CPUStatus**

Not supported for z/OS.

Class IBMzOS\_Processor has no z/OS specific properties.

**Methods**

Method	Description	
unit32 RequestStateChange()	Issues messages for the operator or automation to change the state of the processor.	
	Parameters	Description
	[IN] uint16 RequestedState	Must be one of "Enabled" (2) or "Offline" (6).
	[OUT] CIM_ConcreteJob REFJob	Always returns NULL.
	[IN] datetime TimeoutPeriod	Must be either not defined or a CIM NULL value.
	Return values	Description
	0	Completed without Error
	4	Due to a system error the state change cannot take place. Check target system log.
	5	Parameter <i>RequestedState</i> has not the value "Enabled" (2) or "Offline" (6).
	4097	If the state change is different than from "Reserved" (3), "Offline" (6) to "Online" (2) or from "Online" (2) to "Offline" (6).
4098	If TimeoutPeriod is not 0 or NULL.	

---

## OS management Logical Disk classes

Figure 10 on page 152 illustrates the relationship between the IBM extension classes, and the CIM Base classes that they extend. This figure focuses on class `IBMzOS_LogicalDisk` which was provided in z/OS 1.9 CIM server to support the management of logical disks.

The packages, in which the classes are defined in the CIM Schema, are indicated in parenthesis.

The DMTF website provides a detailed description of the CIM Base classes. The z/OS-specific classes are described in detail in the following chapters.

**Note:** The described metrics are only available for active disks, but not for inactive or offline disks.





## IBMzOS\_LogicalDisk

### Purpose

This class provides basic information about disk devices known to the z/OS operating system based on the logical view.

### Inheritance

- CIM\_ManagedElement
- ← CIM\_ManagedSystemElement
- ← CIM\_LogicalElement
- ← CIM\_EnabledLogicalElement
- ← CIM\_LogicalDevice
- ← CIM\_StorageExtent
- ← CIM\_LogicalDisk
- ← IBMzOS\_LogicalDisk

### Module name

The module name of the CMPI provider that is registered for a CIM class which is used by the cimprovider command line tool for the administration of CMPI providers is

IBMzOS\_LogicalDiskProviderModule

### Provider library

The physical name of a CMPI provider's shared object library as it is stored in the hierarchical file system is

libcmpiIBMzOS\_LogicalDiskProvider.so

### Used by the following CIM profiles

- Host Discovered Resources profile

### Properties

#### string Caption

Always returns z/OS Storage Volume.

#### string Description

Always returns Represents a storage volume as seen by z/OS.

#### string ElementName

Volume Serial Number

#### string Name

Unique identifier for the extent in the form *CC:SS:DDDD*, where  
*CC* is the channel subsystem ID  
*SS* is the SubchannelSetID  
*DDDD* is the DeviceNumber

#### uint16 NameFormat

Returns  
12 OS device name format

#### uint16 NameNamespace

Returns  
8 OS device namespace

#### uint16 EnabledState

Mapped from the UCBOCLI and UCBBBOX values retrieved through UCBSKAN.

See Table 7 for mapping values of *EnabledState* to system data.

**string CreationClassName**

Always returns IBMzOS\_LogicalDisk.

**string DeviceID**

Channel Device ID obtained from UCBCHAN through UCBSKAN.

**string[] IdentifyingDescriptions**

The first array element ([0]) returns Device Node Element Descriptor.

**string[] OtherIdentifyingInfo**

The first array element ([0]) returns

*type.model.manufacturer.plant.sequenceNumber.tag*

Example: 002107.900.IBM.75.0000000CF811.0B09

It is obtained from the NEDID field of the matching IHACDR control block.

**string SystemCreationClassName**

Always returns IBMzOS\_ComputerSystem.

**string SystemName**

The systems fully qualified hostname (see *IBMzOS\_ComputerSystem:colon;Name*). Obtained through the *OSBase\_Common.get\_system\_name()* function.

**uint16 OperationalStatus[]**

Returns

- 0 Unknown
- 2 OK
- 9 Stopping
- 10 Stopped

The property *enabledState* is set based on the UCB control block information as shown in the following table:

Table 7. UCB control block information

UCBONLI	UCBBOX	
	Boxed	Not boxed
Online	Quiesce (9)	Enabled (2)
Offline	Disabled (3)	Disabled (3)
Pending Offline	Shutting down (4)	

**Associations**

**IBMzOS\_SBInitiatorTargetLogicalUnitPath**

**Source** IBMzOS\_LogicalDisk  
**Target** CIM\_ProtocolEndpoint  
 see page 275

**IBMzOS\_LogicalDiskDevice**

**Source** IBMzOS\_ComputerSystem  
**Target** IBMzOS\_LogicalDisk

## OS management File System classes

Figure 11 illustrates the relationship between the IBM extension classes, and the CIM FileSystem classes that they extend. The packages, in which the classes are defined in the CIM Schema, are indicated in parenthesis. The DMTF website provides a detailed description of the CIM FileSystem classes. The z/OS-specific classes are described in detail in the following chapters.

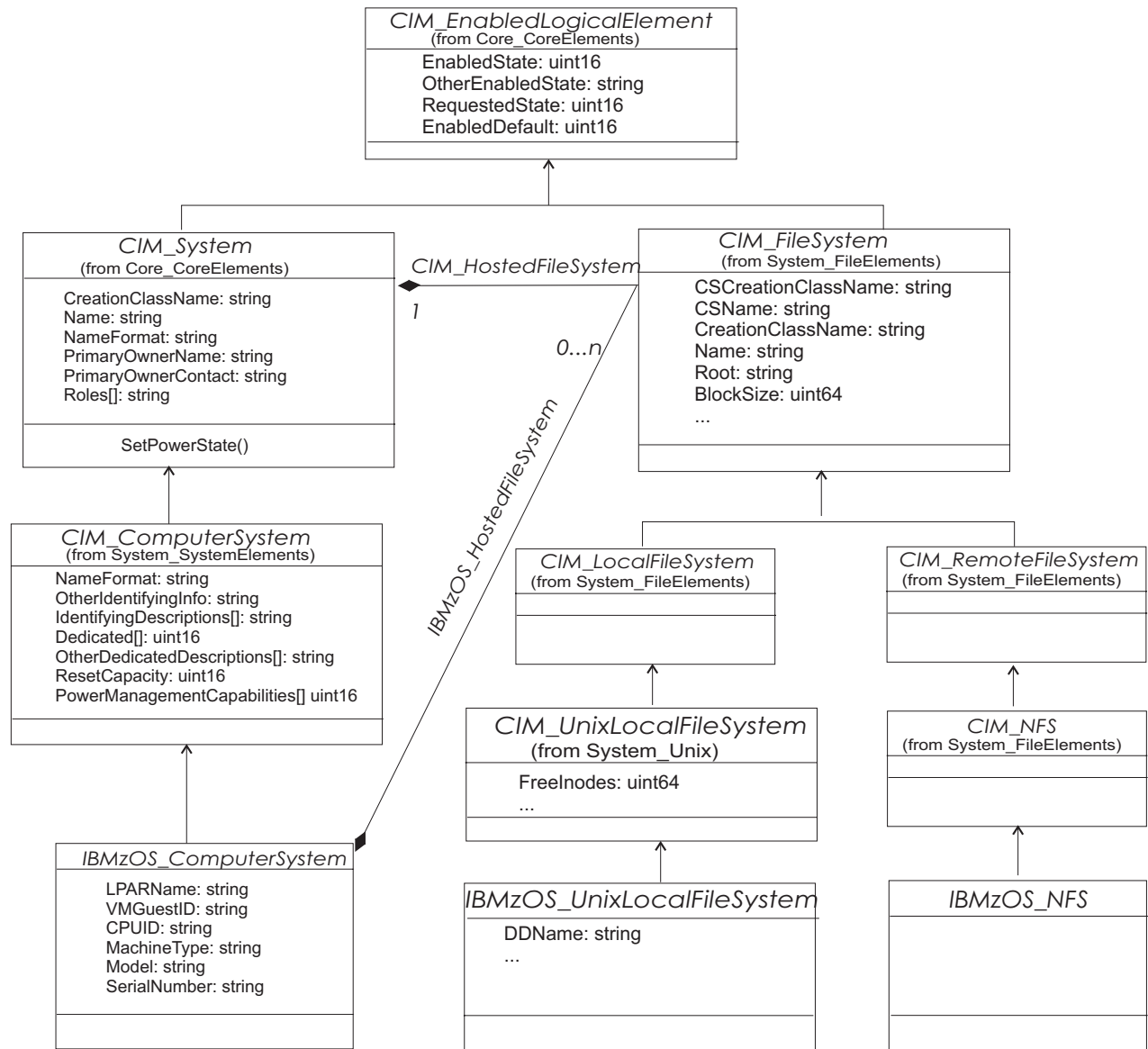

Figure 11. OS management File System classes

## **CIM\_LocalFileSystem**

### **Purpose**

This class represents file systems that are locally attached to a computer system. On z/OS, hierarchical file systems HFS and zFS are supported.

### **Inheritance**

The z/OS specific subclass is IBMzOS\_UnixLocalFileSystem (see “IBMzOS\_UnixLocalFileSystem” on page 157).

## **CIM\_RemoteFileSystem**

### **Purpose**

This class represents file systems that are accessed remotely by a computer system. On z/OS, only NFS is supported.

### **Inheritance**

The z/OS specific subclass is IBMzOS\_NFS (see “IBMzOS\_NFS” on page 159).

## **Association CIM\_HostedFileSystem**

### **Purpose**

The CIM\_HostedFileSystem association associates a ComputerSystem with the set of currently mounted UNIX System Services file systems.

### **Inheritance**

The z/OS specific subclass is IBMzOS\_HostedFileSystem.

# IBMzOS\_UnixLocalFileSystem

## Inheritance

CIM\_LocalFileSystem  
← IBMzOS\_UnixLocalFileSystem

## Module name

The module name of the CMPI provider that is registered for a CIM class which is used by the cimprovider command line tool for the administration of CMPI providers is

IBMzOS\_UnixLocalFileSystemProviderModule

## Provider library

The physical name of a CMPI provider's shared object library as it is stored in the hierarchical file system is

libIBMzOS\_UnixLocalFileSystem.so

## Properties

The following properties are common for eServer:

### string Caption

Always set to *'z/OS hierarchical local file system'*.

### string Description

Always set to *'This class represents instances of currently mounted local hierarchical file systems'*.

### string ElementName

Same as Name.

### string Name [key]

File system name (z/OS data set name).

### string Root

Name of the directory where the file system is mounted.

### uint64 FileSystemSize.

File system size in bytes.

### uint64 AvailableSpace

Space available on the file system in bytes.

### boolean ReadOnly

Indicates whether the file system is mounted read only.

### string FileSystemType

File system type, for example *'NFS'*.

The following properties have data that may be specific to z/OS, or may map to z/OS specific attributes.

### DDName

DD name that was specified on mount.

### FSParentDeviceID

Device ID of the parent file system.

### FSDeviceID

Device number which the STAT command will return for all files in this file system.

### MountParameters

The parameters that were specified for the mount command.

### FSOwner

MVS Owner ID of the file system.

**FSTypeName** The file system type name from the PARMLIB statement.

## IBMzOS\_NFS

### Inheritance

CIM\_RemoteFileSystem  
← IBMzOS\_NFS

### Module name

The module name of the CMPI provider that is registered for a CIM class which is used by the cimprovider command line tool for the administration of CMPI providers is

IBMzOS\_NFSProviderModule

### Provider library

The physical name of a CMPI provider's shared object library as it is stored in the hierarchical file system is

libIBMzOS\_NFS.so

### Properties

The following properties are common for eServer:

#### string Caption

Always set to *'z/OS mounted network file system'*.

#### string Description

Always set to *'This class represents instances of currently mounted network file systems'*.

#### string ElementName

Same as Name.

#### string Name [key]

File system name (corresponds to the *file system argument of the mount command*).

**string Root** Name of the directory where the file system is mounted.

#### uint64 FileSystemSize

File system size in bytes.

#### uint64 AvailableSpace

Space available the on file system in bytes.

#### boolean ReadOnly

Indicates whether the file system is mounted read only.

#### string FileSystemType

File system type, for example *'NFS'*.

Class IBMzOS\_NFS has no z/OS specific properties.

---

## OS management Network classes

The classes described in this section are implemented by the z/OS Communication Server. For details on these CIM classes, refer to *z/OS Communications Server: IP Configuration Guide*.

The providers are installed in the `/usr/lpp/tcpip/lib` hierarchical file system directory and linked to the CIM server's provider directory.

The z/OS CS CIM class definition and provider registration files are installed in the `/usr/lpp/tcpip/mof` hierarchical file system directory and are already integrated into the CIM server.

Figure 12 on page 161 illustrates the relationship between the IBM extension classes, and the CIM Network classes that they extend. The packages, in which the classes are defined in the CIM Schema, are indicated in parenthesis. The DMTF website provides a detailed description of the CIM BaseBoard classes. The z/OS-specific classes are described in detail in the following chapters.



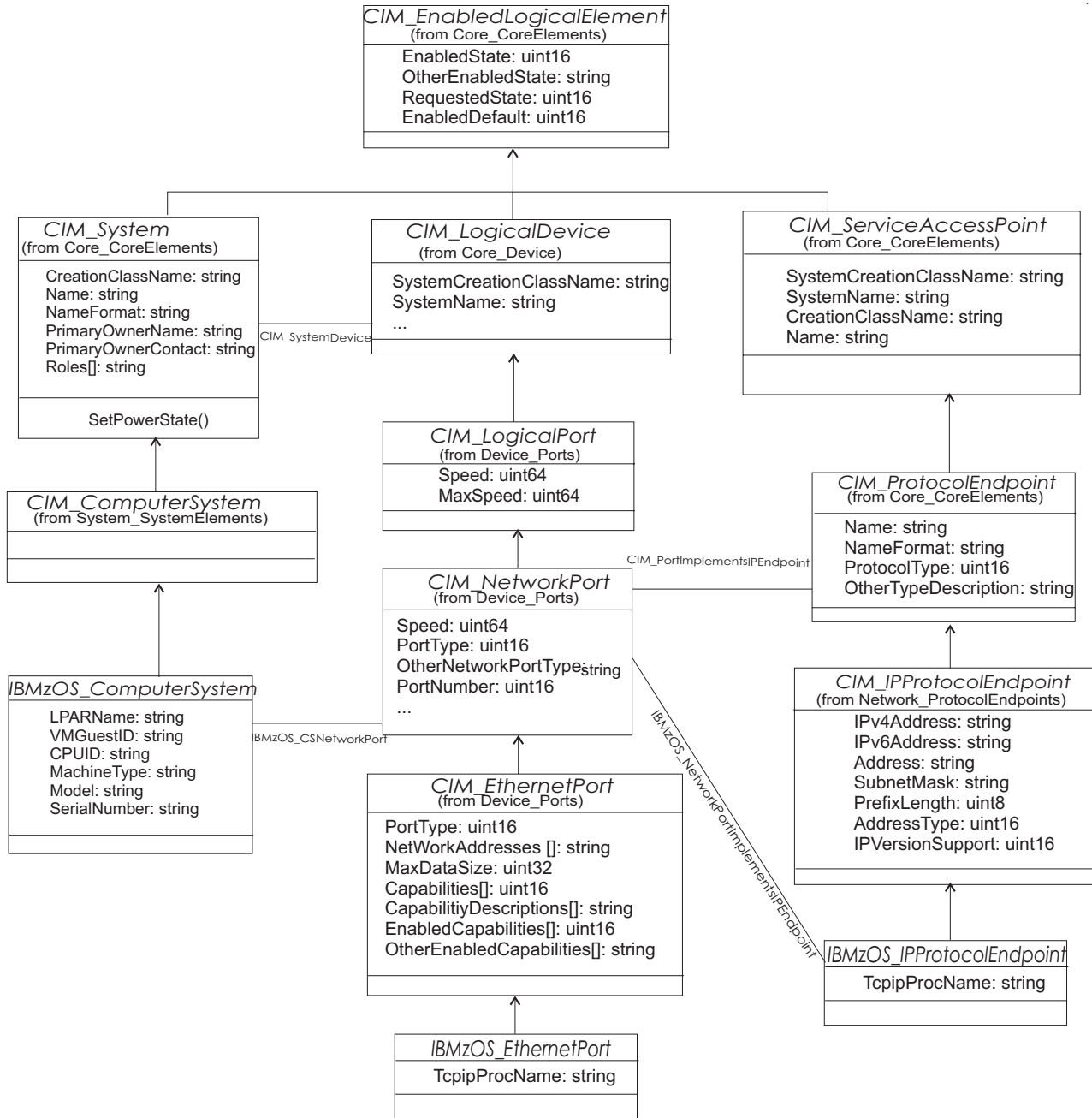

Figure 12. OS management Network classes

## CIM\_EthernetPort

### Purpose

This class represents network ports (interfaces) of type Ethernet. For z/OS, all the Ethernet interfaces configured to the TCP/IP stacks on the MVS image are supported.

### Inheritance

The z/OS specific subclass is IBMzOS\_EthernetPort (see “IBMzOS\_EthernetPort” on page 163).

## CIM\_IPProtocolEndpoint

### Purpose

This class represents the installed IP protocols. For z/OS, all IPv4 addresses configured to the TCP/IP stacks on the MVS image are supported.

### Inheritance

The z/OS specific subclass is IBMzOS\_IPProtocolEndPoint (see “IBMzOS\_IPProtocolEndpoint” on page 165).

## CIM\_PortImplementsEndpoint

### Purpose

This class associates a network port with its installed network protocols. Currently, only IP protocols defined for Ethernet ports are returned.

### Inheritance

The z/OS specific subclass is IBMzOS\_NetworkPortImplementsIPEndpoint.

## Association CIM\_SystemDevice

### Purpose

This class associates a ComputerSystem with the instrumented network ethernet ports.

### Inheritance

The z/OS specific subclass is IBMzOS\_CSNetworkPort.

## IBMzOS\_EthernetPort

### Inheritance

CIM\_EthernetPort  
← IBMzOS\_EthernetPort

### Provider module

The module name of the CMPI provider that is registered for a CIM class which is used by the cimprovider command line tool for the administration of CMPI providers is

IBMzOS\_EthernetPortProviderModule

### Provider library

The physical name of a CMPI provider's shared object library as it is stored in the hierarchical file system is

libcmpiOSBase\_EthernetPortProvider.so

### Owning component

The z/OS component which owns the CMPI provider is

Communication Server

### Properties

The following properties are common for eServer:

#### string Caption

Always set to *'IBMzOS EthernetPort'*.

#### string Description

Variable, depending on the type of interface, for example, *'IP Assist Queued Direct I/O Ethernet protocol port'*.

#### string ElementName

Same as Name.

**string Name** The label by which the NetworkPort is known to the operating system (*'tcpprocname\_intfname'*).

#### uint16 EnabledState

Indicates whether the protocol endpoint is active or not.

#### string DeviceID [key]

Identifying information to uniquely name the ethernet port. (*'tcpprocname\_intfname'*).

**uint64 Speed** The current bandwidth of the port in bits per second.

#### uint64 MaxSpeed

The maximum bandwidth of the port in bits per second. For z/OS, this is always the same value as *Speed*.

#### uint16 LinkTechnology

Always 2 (=Ethernet).

#### string OtherLinkTechnology

Not set for z/OS.

The following properties have data that may be specific to z/OS, or may map to z/OS specific attributes.

**TcpipProcName**

z/OS TCP/IP stack name.

# IBMzOS\_IPProtocolEndpoint

## Inheritance

CIM\_IPProtocolEndpoint  
← IBMzOS\_IPProtocolEndpoint

## Provider module

The module name of the CMPI provider that is registered for a CIM class which is used by the cimprovider command line tool for the administration of CMPI providers is

IBMzOS\_IPProtocolEndpointProviderModule

## Provider library

The physical name of a CMPI provider's shared object library as it is stored in the hierarchical file system is

libcmpiOSBase\_IPProtocolEndpointProvider.so

## Owning component

The z/OS component which owns the CMPI provider is

Communication Server

## Properties

The following properties are common for eServer:

### string Caption

Always set to *'IBMzOS Protocol Endpoint for IP'*.

### string Description

Always set to *'A communication point to send and receive data. This class is dedicated to relate IP interfaces to Logical Networks'*.

### string ElementName

Same as Name.

### string Name [key]

The unique name of the protocol endpoint, constructed according to the template in NameFormat.

### uint16 EnabledState

Returns whether the protocol endpoint is active or not.

### string NameFormat

Describes the format of the name property. For z/OS, this is always set to *'TCPIPPROCNAME\_TYPE\_DEVICE\_IPADDR(ETHY)'*.

### string IPv4Address

The IPv4 IP address.

### string IPv6Address

Not yet supported for z/OS instrumentation.

### string SubnetMask

The IPv4 IP subnet mask.

### uint16 IPVersionSupport

Always returns 1 (=IPv4 only).

The following properties have data that may be specific to z/OS, or may map to z/OS specific attributes.

**TcpipProcName**

z/OS TCP/IP stack name.

---

## OS management Job classes

The classes described in this section are implemented by z/OS to instrument the z/OS jobs subsystems, JES2 and JES3.

For using these providers you need an extra security setup as described in “Setting up the CIM server for Cluster, CoupleDataset, and JES2-JES3Jobs providers” on page 38.

For a list of the Jobs providers' reason codes, see “Appendix C. CEA reason codes” on page 353.

## IBMzOS\_JES2Job

### Purpose

This class is a subclass of IBMzOS\_Job and contains those properties that are unique to a job that has run, or will run, under JES2.

### Inheritance

IBMzOS\_Job  
← IBMzOS\_JES2Job

### Module name

The module name of the CMPI provider that is registered for a CIM class which is used by the cimprovider command line tool for the administration of CMPI providers is

IBMzOS\_JES2JobProviderModule

### Provider library

The physical name of a CMPI provider's shared object library as it is stored in the hierarchical file system is

libcmpiIBMzOS\_JES2JobProvider.so

### Properties

The following properties have been implemented for z/OS:

#### string Caption

A short description of the class. Returns *'IBM z/OS JES2 Job'*.

#### string Description

A description of the class. Returns *'This is an IBMzOS\_JES2Job'*.

#### string ElementName

Name given to this instance of the class (same as Name)

#### datetime InstallDate

Not supported for z/OS.

#### string Name [key]

The property is overridden by *IBMzOS\_JES2Job*. It contains a unique identifier for this job.

#### uint16 OperationalStatus[]

The current status of the JES2 job.

- |    |  |
|----|--|
| 1  | No subchain exists   |
| 2  | Active in CI in FSS address space                            |
| 3  | Awaiting postscan (batch)                                    |
| 4  | Awaiting postscan (damsel)                                   |
| 5  | Awaiting volume fetch  |
| 6  | Awaiting start setup (JES3), Awaiting setup (JES2)           |
| 7  | Awaiting/active in MDS system select processing              |
| 8  | Awaiting resource allocation                                 |
| 9  | Awaiting unavailable volumes                                 |
| 10 | Awaiting volume mounts                                       |
| 11 | Awaiting/active in MDS system verify processing              |
| 12 | Error during MDS processing                                  |
| 13 | Awaiting selection on main (JES3), Awaiting execution (JES2) |
| 14 | Scheduled on main (JES3), Active executing (JES2)            |



17	Awaiting breakdown (JES3), Active in output (JES2)
18	Awaiting MDS restart processing
19	Main MDS processing complete
20	Awaiting output service (JES3), Awaiting hardcopy (JES2)
21	Awaiting output service writer
22	Awaiting reserved services
23	Output service complete
24	Awaiting selection on main (demand select job)
25	Ending function rq waiting or I/O completion
26	Ending function rq not processed
27	Maximum rq index value
128	Active in input processing
129	Awaiting conversion
130	Active in conversion
131	Active in setup
132	Active in spin
133	Awaiting output
134	Awaiting purge
135	Active in purge
136	Active on NJE sysout received
137	Awaiting NJE transmission
138	Active on NJE job transmitter

**string StatusDescriptions[]**

Strings describing the various *OperationalStatus* values. Returns NULL.

**string Status**

Not supported for z/OS.

**string JobStatus**

A free form string containing information about the job.

The primary job status is reflected in *OperationalStatus*. *JobStatus* provides additional implementation-specific details.

**datetime TimeSubmitted**

The time that the Job was submitted to execute.

A value of all zeros indicates that the owning element is not capable of reporting a date and time. Therefore, the *ScheduledStartTime* and *StartTime* are reported as intervals relative to the time their values are required.

**datetime ScheduledStartTime**

Not supported for z/OS.

**datetime StartTime**

The time that the Job was actually started.

This may be represented by an actual date and time, or by an interval relative to the time that this property is requested.

Note that this property is also present in the *JobProcessingStatistics* class. This is necessary to capture the processing information for recurring Jobs, since only the 'last' run time can be stored in this single-valued property.

**datetime ElapsedTime**

The time interval that the Job has been executing or the total execution time if the Job is complete.

Note that this property is also present in the `JobProcessingStatistics` class. This is necessary to capture the processing information for recurring Jobs, since only the 'last' run time can be stored in this single-valued property.

**uint32 JobRunTimes**

Number of times that the Job should be run.

A value of 1 indicates that the Job is NOT recurring, while any non-zero value indicates a limit to the number of times that the Job will recur.

Zero indicates that there is no limit to the number of times that the Job can be processed, but that it is terminated either AFTER the *UntilTime*, or by manual intervention.

By default, a job is processed once.

This property is not modifiable.

**uint8 RunMonth**

Not supported for z/OS.

**sint8 RunDay** Not supported for z/OS.

**sint8 RunDayOfWeek**

Not supported for z/OS.

**datetime RunStartInterval**

The time interval after midnight when the Job should be processed.

For example, 00000000020000.000000:000 indicates that the Job should be run on or after two o'clock, local time of UTC time (distinguished using the *LocalOrUtcTime* property).

This property is not modifiable.

**uint16 LocalOrUtcTime**

This property indicates whether the time represented in the *RunStartInterval* and *UntilTime* properties represent local or UTC times.

Time values are synchronized worldwide by using the enumeration value 2, "UTC Time". Permitted values are:

- 1 Local time
- 2 UTC time

This property is not modifiable.

**datetime UntilTime**

The time after which the Job is invalid or should be stopped.

This may be represented by an actual date and time, or by an interval relative to the time that this property is requested.

A value of all nines indicates that the Job can run indefinitely.

This property is not modifiable.

**string Notify** User to be notified upon the Job completion or failure.

This property can be modified using the *RequestPropertyChange()* method.

**string Owner** The User that submitted the Job or the Service/method name/etc. that caused the job to be created.

**uint32 Priority**

Indicates the urgency or importance of execution of the Job.

The lower the number, the higher the priority.

Note that this property is also present in the `JobProcessingStatistics` class. This is necessary to capture the setting information that would influence a Job's results.

This property can be modified using the `RequestPropertyChange()` method.

**uint16 PercentComplete**

Not supported for z/OS.

**boolean DeleteOnCompletion**

Indicates whether or not the Job should be automatically deleted upon completion.

Note that the 'completion' of a recurring Job is defined by its `JobRunTimes` or `UntilTime` properties, OR when the Job is terminated by manual intervention.

If this property is set to false and the Job completes, then the extrinsic method `DeleteInstance` MUST be used to delete the Job versus updating this property.

This property is not modifiable.

**uint16 ErrorCode**

Not supported for z/OS.

**string ErrorDescription**

Not supported for z/OS.

**uint16 RecoveryAction**

Not supported for z/OS.

**string OtherRecoveryAction**

Not supported for z/OS.

**string AbendCode**

Job completed with abend code.

**string AccountNumber**

Account number from job card.

**boolean ARMRegistered**

Job is ARM registered indicator.

**string AvailableSchedEnvSystem []**

System names on which the scheduling environment required by job is available. Only valid if job requires a scheduling environment and that environment is available on at least one system.

**string AvailableSeclabelSystems []**

System names on which the seclabel associated with the job is available. Only valid if seclabel by system is active in the security product and the seclabel is available on at least on system.

**boolean AwaitingARMRestart**

Job awaiting ARM restart indicator.

**string Building**  
 NJE building.  
 This property is "Expensive".

**uint32 CardCount**  
 Card (output) count.

**string Class** Job class.  
 This property can be modified using the *RequestPropertyChange()* method.

**uint32 CompletionCode**  
 Completion code (set for conditions marked with + in job completion indicator).

**uint8 CompletionType**  
 Specific completion type:

0	No completion info
1	Job ended normally
2	Job ended by CC
3	JCL error
4	Canceled
5	Abended
6	Converter abended
7	Security error
8	Job failed in EOM

**uint16 CopyCount**  
 Job copy count.  
 This property is "Expensive".

**string CSName**  
 The scoping Computer System.

**string DefaultPrintDest**  
 Default print destination.  
 This property can be modified using the *RequestPropertyChange()* method.

**string DefaultPunchDest**  
 Default punch destination.  
 This property can be modified using the *RequestPropertyChange()* method.

**string Department**  
 NJE department.  
 This property is "Expensive".

**string Device** Name of device job is active on.

**uint32 EstimatedTimeToExecution**  
 Estimated time to execution in seconds.  
 This field is only available if the job is awaiting execution, job is scheduled to run to a WLM managed class, job is not held (duplicate job name, operator hold, etc.), member it has affinity to is available, and the scheduling environment is available.

**datetime ExecutionEndTime**  
 Execution end time and date.  
 This property is "Expensive".

**string ExecutionMember**  
 Execution JES2 member name.  
 This property is "Expensive".

**string ExecutionNode**  
 Execution node.  
 This property can be modified using the *RequestPropertyChange()* method.

**datetime ExecutionStartTime**  
 Execution start time and date.  
 This property is "Expensive".

**string ExecutionSystem**  
 Execution MVS system name.  
 This property is "Expensive".

**uint8 HoldIndicator**  
 Job hold indicator:  
 1 Not held  
 2 Held  
 3 Held for duplicate job name

**uint32 InputCount**  
 Job input count.  
 This property is "Expensive".

**string InputDevice**  
 Input device name.  
 This property is "Expensive".

**datetime InputStartTime**  
 Input start time and date.  
 This property is "Expensive".

**string InputSystem**  
 Input system or member.

**boolean JesLogSpinnable**  
 Jeslog spinnable indicator.

**boolean JobClassModeWLM**  
 Job class mode for job. If true, mode is WLM, otherwise mode is JES.

**string JobID** Job identifier.

**boolean JobIsActive**  
 Indicate job is executing.

**string JobName**  
 Job name.

**uint8 JobType** Job type:  
 1 Started task (STC)

- 2 Time sharing user (TSU)
- 3 Batch job (JOB)
- 4 APPC indicator

**uint32 LineCount**

Line count.

This property is "Expensive".

**string MemberName**

JES2 member on which the job is active.

**string MessageClass**

Message class from job card.

**string NotifyNode**

Notify node.

This property is "Expensive".

**string OriginalJobID**

Original job identifier.

**string OriginNode**

Original node (node of submittal).

**string OSName**

The scoping Operating System's name.

**uint32 PageCount**

Job page count.

This property is "Expensive".

**uint8 Phase** Phase job is in:

- 1 No subchain exists
- 2 Active in CI in FSS address space
- 3 Awaiting postscan (batch)
- 4 Awaiting postscan (damsel)
- 5 Awaiting volume fetch
- 6 Awaiting start setup (JES3), Awaiting setup (JES2)
- 7 Awaiting/active in MDS system select processing
- 8 Awaiting resource allocation
- 9 Awaiting unavailable volumes
- 10 Awaiting volume mounts
- 11 Awaiting/active in MDS system verify processing
- 12 Error during MDS processing
- 13 Awaiting selection on main (JES3), Awaiting execution (JES2)
- 14 Scheduled on main (JES3), Active executing (JES2)
- 17 Awaiting breakdown (JES3), Active in output (JES2)
- 18 Awaiting MDS restart processing
- 19 Main MDS processing complete
- 20 Awaiting output service (JES3), Awaiting hardcopy (JES2)
- 21 Awaiting output service writer
- 22 Awaiting reserved services
- 23 Output service complete
- 24 Awaiting selection on main (demand select job)
- 25 Ending function rq waiting or I/O completion
- 26 Ending function rq not processed
- 27 Maximum rq index value
- 128 Active in input processing

129	Awaiting conversion
130	Active in conversion
131	Active in setup
132	Active in spin
133	Awaiting output
134	Awaiting purge
135	Active in purge
136	Active on NJE sysout received
137	Awaiting NJE transmission
138	Active on NJE job transmitter

**string ProgrammerName**

Programmer name from job card.

**string RoomNumber**

Job card room number.

**string Seclabel**

Seclabel from job.

**boolean Spin** Indicator of whether jobs in the job class can be spun.

**string Subsystem**

Subsystem name.

**string SystemName**

MVS system name on which the job is active.

**uint32 WLMActiveJobCount**

Number of active jobs in this WLM service class.

**uint32 WLMJobsOnQueueCount**

Number of jobs on WLM service class queue.

**uint32 WLMPosition**

Position of this job on WLM service class queue.

**uint32 WLM SchedulingEnvironment**

WLM scheduling environment.

This property can be modified using the *RequestPropertyChange()* method.

**string WLMServiceClass**

WLM service class.

This property can be modified using the *RequestPropertyChange()* method.

**string PercentSpoolUtilization**

Percent of spool Used by the following CIM profiles the job.

**boolean ConverterWait**

Job can be converted only by CNVT PCEs that can wait for OS

**boolean Independent**

Job is set to independent mode.

**uint32 JobKey** Job key

**boolean JobNotRunReasonJobBusyOnDevice**

Job not running because job busy on device

**boolean JobNotRunReasonJobClassHeld**

Job not running because job class held

- boolean JobNotRunReasonJobClassLimitReached**  
Job not running because job class limit reached
- boolean JobNotRunReasonNoSystem**  
Job not running because no system with right combination of resources
- boolean JobNotRunReasonSchedulingEnvironment**  
Job not running due to unavailable scheduling environment
- boolean JobNotRunReasonSeclabelAffinity**  
Job not running because of seclabel affinity
- boolean JobNotRunReasonSpoolNotAvailable**  
Job not running because spools not available
- boolean JobNotRunReasonSystemAffinity**  
Job not running due to system affinity
- boolean Protected**  
Job is protected
- uint32 SpoolDataToken**  
Spool data token
- string SystemAffinity []**  
System affinity for job
- boolean SystemDataSet**  
Job represents a system data set
- uint32 TrackGroupCount**  
Number of track groups of spool space used by this job

## Methods

Method	Description	
sint32 Hold()	Holds a job.	
	Parameters	Description
	[IN] datetime TimeoutPeriod	Specifies the maximum amount of time that the client expects the transition to the new state to take.
	[OUT] ResponseText[]	Command response messages.
	[OUT] sint32 ReasonCode	Reason code referencing CEA errors.
sint32 Release()	Releases a job.	
	Parameters	Description
	[IN] datetime TimeoutPeriod	Specifies the maximum amount of time that the client expects the transition to the new state to take.
	[OUT] string ResponseText[]	Command response messages.
	[OUT] sint32 ReasonCode	Reason code referencing CEA errors.



Method	Description	
sint32 ReleaseOutput()	Releases output for a job.	
	Parameters	Description
	[IN] datetime TimeoutPeriod	Specifies the maximum amount of time that the client expects the transition to the new state to take.
	[OUT] string ResponseText[]	Command response messages.
	[OUT] sint32 ReasonCode	Reason code referencing CEA errors.
sint32 RequestPropertyChange()	Changes a property and returns response messages from the generated command.	
	Parameters	Description
	[IN] string PropertyName	The property to be changed.
	[IN] string PropertyValue	The new value for the property.
	[IN] datetime TimeoutPeriod	Specifies the maximum amount of time that the client expects the transition to the new state to take.
	[OUT] string ResponseText[]	Command response messages.
	[OUT] sint32 ReasonCode	Reason code referencing CEA errors.
sint32 Restart()	Restarts a job.	
	Parameters	Description
	[IN] boolean Hold	Indicates if the job should be held prior to its execution.
	[IN] datetime TimeoutPeriod	Specifies the maximum amount of time that the client expects the transition to the new state to take.
	[OUT] string ResponseText[]	Command response messages.
	[OUT] sint32 ReasonCode	Reason code referencing CEA errors.

Method	Description	
sint32 Cancel()	Cancels a job.	
	Parameters	Description
	[IN] boolean PurgeOutput	Indicates if any output associated with the job is to be cancelled.
	[IN] boolean TakeDump	Indicates if a dump should be taken when the job is canceled.
	[IN] datetime TimeoutPeriod	Specifies the maximum amount of time that the client expects the transition to the new state to take.
	[OUT] string ResponseText[]	Command response messages.
	[OUT] sint32 ReasonCode	Reason code referencing CEA errors.

## IBMzOS\_JES3Job

### Purpose

This class is a subclass of `IBMzOS_Job` and contains those properties that are unique to a job that has run, or will run, under JES3.

### Inheritance

`IBMzOS_Job`  
← `IBMzOS_JES3Job`

### Module name

The module name of the CMPI provider that is registered for a CIM class which is used by the `cimprovider` command line tool for the administration of CMPI providers is

`IBMzOS_JES3JobProviderModule`

### Provider library

The physical name of a CMPI provider's shared object library as it is stored in the hierarchical file system is

`libcmplibIBMzOS_JES3JobProvider.so`

### Properties

The following properties have been implemented for z/OS:

#### string Caption

A short description of the class

#### string Description

A description of the class

#### string ElementName

Name of given to this instance of the class

#### datetime InstallDate

Not supported for z/OS.

#### string Name

The property is overridden by `IBMzOS_JES3Job`. It contains a unique identifier for this Job.

#### uint16 OperationalStatus [ ]

The current status of the JES3 Job:

- |    |  |
|----|--|
| 1  | No subchain exists   |
| 2  | Active in CI in FSS address space                            |
| 3  | Awaiting postscan (batch)                                    |
| 4  | Awaiting postscan (damsel)                                   |
| 5  | Awaiting volume fetch  |
| 6  | Awaiting start setup (JES3), Awaiting setup (JES2)           |
| 7  | Awaiting/active in MDS system select processing              |
| 8  | Awaiting resource allocation                                 |
| 9  | Awaiting unavailable volumes                                 |
| 10 | Awaiting volume mounts                                       |
| 11 | Awaiting/active in MDS system verify processing              |
| 12 | Error during MDS processing                                  |
| 13 | Awaiting selection on main (JES3), Awaiting execution (JES2) |
| 14 | Scheduled on main (JES3), Active executing (JES2)            |
| 17 | Awaiting breakdown (JES3), Active in output (JES2)           |
| 18 | Awaiting MDS restart processing                              |

19	Main MDS processing complete
20	Awaiting output service (JES3), Awaiting hardcopy (JES2)
21	Awaiting output service writer
22	Awaiting reserved services
23	Output service complete
24	Awaiting selection on main (demand select job)
25	Ending function rq waiting or I/O completion
26	Ending function rq not processed
27	Maximum rq index value
128	Active in input processing
129	Awaiting conversion
130	Active in conversion
131	Active in setup
132	Active in spin
133	Awaiting output
134	Awaiting purge
135	Active in purge
136	Active on NJE sysout received
137	Awaiting NJE transmission
138	Active on NJE job transmitter

**string StatusDescriptions [ ]**

Strings describing the various Operational Status values.

**string Status** Not supported for z/OS.

**string JobStatus**

A free form string representing the Job's status.

The primary status is reflected in the inherited *OperationStatus* property.

JobStatus provides additional implementation-specific details.

**datetime TimeSubmitted**

The time that the Job was submitted to execute.

A value of all zeros indicates that the owning element is not capable of reporting a date and time. Therefore, the *ScheduledStartTime* and *StartTime* are reported as intervals relative to the time their values are required.

**datetime ScheduledStartTime**

Not supported for z/OS.

**datetime StartTime**

The time that the Job was actually started.

This may be represented by an actual date and time, or by an interval relative to the time that this property is requested.

Note that this property is also present in the JobProcessingStatistics class. This is necessary to capture the processing information for recurring Jobs, since only the 'last' run time can be stored in this single-valued property.

**datetime ElapsedTime**

The time interval that the Job has been executing or the total execution time if the Job is complete.

Note that this property is also present in the `JobProcessingStatistics` class. This is necessary to capture the processing information for recurring Jobs, since only the 'last' run time can be stored in this single-valued property.

**uint32 JobRunTimes**

Number of times that the Job should be run.

A value of 1 indicates that the Job is NOT recurring, while any non-zero value indicates a limit to the number of time that the Job will recur.

Zero indicates that there is no limit to the number of times that the Job can be processed, but that it is terminated either AFTER the *UntilTime*, or by manual intervention.

By default, a Job is processed once.

This property is not modifiable.

**uint8 RunMonth**

Not supported for z/OS.

**sint8 RunDay** Not supported for z/OS.

**sint8 RunDayOfWeek**

Not supported for z/OS.

**datetime RunStartInterval**

The time interval after midnight when the Job should be processed.

For example, 00000000020000.000000:000 indicates that the Job should be run on of after two o'clock, local time of UTC time (distinguished using the *LocalOrUtcTime* property).

This property is not modifiable.

**uint16 LocalOrUtcTime**

This property indicates whether the time represented in the *RunStartInterval* and *UntilTime* properties represent local or UTC times.

Time values are synchronized worldwide by using the enumeration value 2, "UTC Time". Permitted values are:

- 1 Local time
- 2 UTC time

This property is not modifiable.

**datetime UntilTime**

The time after which the Job is invalid or should be stopped. This may be represented by an actual date and time, or by an interval relative to the time that this property is requested. A value of all nines indicates that the Job can run indefinitely.

This property is not modifiable.

**string Notify** User to be notified upon the Job completion or failure.

This property can be modified using the *RequestPropertyChange()* method.

**string Owner** The User that submitted the Job or the Service/method name/etc. that caused the job to be created.

**uint32 Priority**

Indicates the urgency or importance of execution of the Job. The lower the number, the higher the priority. Note that this property is also present in the *JobProcessingStatistics* class. This is necessary to capture the setting information that would influence a Job's results.

This property can be modified using the *RequestPropertyChange()* method.

**uint16 PercentComplete**

Not supported for z/OS.

**boolean DeleteOnCompletion**

Indicates whether or not the Job should be automatically deleted upon completion.

Note that the 'completion' of a recurring Job is defined by its *JobRunTimes* or *UntilTime* properties, OR when the Job is terminated by manual intervention.

If this property is set to false and the Job completes, then the extrinsic method *DeleteInstance* MUST be used to delete the Job versus updating this property.

This property is not modifiable.

**uint16 ErrorCode**

Not supported for z/OS.

**string ErrorDescription**

Not supported for z/OS.

**uint16 RecoveryAction**

Not supported for z/OS.

**string OtherRecoveryAction**

Not supported for z/OS.

**string AbendCode**

Job completed with abend code.

**string AccountNumber**

Account number from job card.

**boolean ARMRegistered**

Job is ARM registered indicator.

**string AvailableSchedEnvSystems [ ]**

System names on which the scheduling environment required by job is available. Only valid if job requires a scheduling environment and that environment is available on at least one system.

**string AvailableSeclabelSystems [ ]**

System names on which the seclabel associated with the job is available. Only valid if seclabel by system is active in the security product and the seclabel is available on at least on system.

**boolean AwaitingARMRestart**

Job awaiting ARM restart indicator.

**string Building**

NJE building.

This property is "Expensive".

**uint32 CardCount**  
Card (output) count.

**string Class** Job class.  
This property can be modified using the *RequestPropertyChange()* method.

**uint32 CompletionCode**  
Completion code (set for conditions marked with + in job completion indicator).

**uint8 CompletionType**  
Specific completion type:

0	No completion info
1	Job ended normally
2	Job ended by CC
3	JCL error
4	Canceled
5	Abended
6	Converter abended
7	Security error
8	Job failed in EOM

**uint16 CopyCount**  
Job copy count.  
This property is "Expensive".

**string CSName**  
The scoping Computer System.

**string DefaultPrintDest**  
Default print destination.  
This property can be modified using the *RequestPropertyChange()* method.

**string DefaultPunchDest**  
Default punch destination.  
This property can be modified using the *RequestPropertyChange()* method.

**string Department**  
NJE department.  
This property is "Expensive".

**string Device** Name of device job is active on.

**uint32 EstimatedTimeToExecution**  
Estimated time to execution in seconds. This field is only available if the job is awaiting execution, job is scheduled to run to a WLM managed class, job is not held (duplicate job name, operator hold, etc.), member it has affinity to is available, and the scheduling environment is available.

**datetime ExecutionEndTime**  
Execution end time and date.  
This property is "Expensive".

**string ExecutionMember**  
Execution JES2 member name.

This property is "Expensive".

**string ExecutionNode**

Execution node.

This property can be modified using the *RequestPropertyChange()* method.

**datetime ExecutionStartTime**

Execution start time and date.

This property is "Expensive".

**string ExecutionSystem**

Execution MVS system name.

This property is "Expensive".

**uint8 HoldIndicator**

Job hold indicator:

- 1 Not held
- 2 Held
- 3 Held for duplicate job name

**uint32 InputCount**

Job input count.

This property is "Expensive".

**string InputDevice**

Input device name.

This property is "Expensive".

**datetime InputStartTime**

Input start time and date.

This property is "Expensive".

**string InputSystem**

Input system or member.

**boolean JesLogSpinnable**

Jeslog spinnable indicator.

**boolean JobClassModeWLM**

Job class mode for job. If true, mode is WLM, otherwise mode is JES.

**string JobID** Job identifier.

**boolean JobIsActive**

Indicate job is executing.

**string JobName**

Job name.

**uint8 JobType** Job type:

- 1 Started task (STC)
- 2 Time sharing user (TSU)
- 3 Batch job (JOB)
- 4 APPC indicator"

**uint32 LineCount**

Line count.

This property is "Expensive".



**string MemberName**  
JES2 member on which the job is active.

**string MessageClass**  
Message class from job card.

**string NotifyUserid**  
Notify user ID.

**string OriginalJobID**  
Original job identifier.

**string OriginNode**  
Original node (node of submittal).

**string OSName**  
The scoping Operating System's name.

**uint32 PageCount**  
Job page count.  
This property is "Expensive".

**uint8 Phase** Phase, the job is in. For the values and their meanings, see property *OperationalStatus*.

**string ProgrammerName**  
Programmer name from job card.

**string RoomNumber**  
Job card room number.

**string Seclabel**  
Seclabel from job.

**boolean Spin** Indicator of whether jobs in the job class can be spun.

**string Subsystem**  
Subsystem name.

**string SystemName**  
MVS system name on which the job is active.

**uint32 WLMActiveJobCount**  
Number of active jobs in this WLM service class.

**uint32 WLMJobsOnQueueCount**  
Number of jobs on WLM service class queue.

**uint32 WLMPosition**  
Position of this job on WLM service class queue.

**uint32 WLM SchedulingEnvironment**  
WLM scheduling environment.  
This property can be modified using the *RequestPropertyChange()* method.

**string WLMServiceClass**  
WLM service class.  
This property can be modified using the *RequestPropertyChange()* method.

**string PercentSpoolUtilization**  
Percent of spool used by the job.

**uint8 JobNotRunReasonCodes [ ]**

List or reasons by system for why job is waiting to run

**string JobNotRunSystems [ ]**

List of system names corresponding to JobNotRunReasonCodes

## Methods

Method	Description	
sint32 Hold()[OUT]	Holds a job.	
	<b>Parameters</b>	<b>Description</b>
	[IN] datetime TimeoutPeriod	Specifies the maximum amount of time that the client expects the transition to the new state to take.
	[OUT] ResponseText[]	Command response messages.
[OUT] sint32 ReasonCode	Reason code referencing CEA errors.	
sint32 Release()	Releases a job.	
	<b>Parameters</b>	<b>Description</b>
	[IN] datetime TimeoutPeriod	Specifies the maximum amount of time that the client expects the transition to the new state to take.
	[OUT] string ResponseText[]	Command response messages.
[OUT] sint32 ReasonCode	Reason code referencing CEA errors.	
sint32 ReleaseOutput()	Releases output for a job.	
	<b>Parameters</b>	<b>Description</b>
	[IN] datetime TimeoutPeriod	Specifies the maximum amount of time that the client expects the transition to the new state to take.
	[OUT] string ResponseText[]	Command response messages.
[OUT] sint32 ReasonCode	Reason code referencing CEA errors.	

Method	Description	
sint32 RequestPropertyChange()	Changes a property and returns response messages from the generated command.	
	Parameters	Description
	[IN] string PropertyName	The property to be changed.
	[IN] string PropertyValue	The new value for the property.
	[IN] datetime TimeoutPeriod	Specifies the maximum amount of time that the client expects the transition to the new state to take.
	[OUT] string ResponseText[]	Command response messages.
	[OUT] sint32 ReasonCode	Reason code referencing CEA errors.
sint32 Restart()	Restarts a job.	
	Parameters	Description
	[IN] boolean Hold	Indicates if the job should be held prior to its execution.
	[IN] datetime TimeoutPeriod	Specifies the maximum amount of time that the client expects the transition to the new state to take.
	[OUT] string ResponseText[]	Command response messages.
	[OUT] sint32 ReasonCode	Reason code referencing CEA errors.
sint32 Cancel()	Cancels a job.	
	Parameters	Description
	[IN] boolean PurgeOutput	Indicates if any output associated with the job is to be cancelled.
	[IN] boolean TakeDump	Indicates if a dump should be taken when the job is canceled.
	[IN] datetime TimeoutPeriod	Specifies the maximum amount of time that the client expects the transition to the new state to take.
	[OUT] string ResponseText[]	Command response messages.
	[OUT] sint32 ReasonCode	Reason code referencing CEA errors.

## IBMzOS\_JES2SysoutDataset

### Purpose

This class is a subclass of IBMzOS\_SysoutDataset and contains those properties that are unique to a job that has run under JES2.

### Inheritance

IBMzOS\_SysoutDataset  
← IBMzOS\_JES2SysoutDataset

### Module name

The module name of the CMPI provider that is registered for a CIM class which is used by the cimprovider command line tool for the administration of CMPI providers is

IBMzOS\_JES2SysoutDatasetProviderModule

### Provider library

The physical name of a CMPI provider's shared object library as it is stored in the hierarchical file system is

libcmpiIBMzOS\_JES2SysoutDatasetProvider.so

### Properties

#### string Caption

A short description of the class

#### string Description

A description of the class

#### string ElementName

Name of given to this instance of the class

#### datetime InstallDate

Not supported for z/OS.

#### string Name [key]

JES2 Sysout Dataset name

#### uint16 OperationalStatus [ ]

The current status of the JES2SysoutDataset:

0 = Unknown

2 = OK

6 = Error

9 = Stopping

#### string StatusDescriptions [ ]

Not supported for z/OS.

#### string Status

Not supported for z/OS.

#### string CSCreationClassName [key]

The scoping ComputerSystem's CreationClassName.

#### string CSName [key]

The scoping ComputerSystem's Name.

#### string FSCreationClassName [key]

The scoping FileSystem's CreationClassName.

**string FSName [key]**  
The scoping FileSystem's Name.

**string CreationClassName [key]**  
Indicates the name of the class or the subclass used in the creation of an instance. When used with the other key properties of this class, this property allows all instances of this class and its subclasses to be uniquely identified.

**uint64 FileSize**  
Not supported for z/OS.

**datetime CreationDate**  
Not supported for z/OS.

**datetime LastModified**  
Not supported for z/OS.

**datetime LastAccessed**  
Not supported for z/OS.

**boolean Readable**  
Boolean indicating that the File can be read.

**boolean Writeable**  
Boolean indicating the File can be written.

**boolean Executable**  
Boolean indicating the File is executable.

**string CompressionMethod**  
Not supported for z/OS.

**string EncryptionMethod**  
Not supported for z/OS.

**uint64 InUseCount**  
Not supported for z/OS.

**string ActiveMember**  
The JES member on which the sysout is active

**string ActiveSysname**  
z/OS system on which the sysout is active

**boolean Burst**  
Indicates whether 'Burst' mode is supported.

**uint64 ByteCount**  
Byte count after blank truncation

**string Class** The sysout class

**datetime CreateTime**  
Date and time the data set became available  
This property is "Expensive".

**string DataSetName**  
Sysout data set name  
This property is "Expensive".

**uint32 DataSetNumber**  
Data set number  
This property is "Expensive".

**string DDName**  
DDName for the data set creation  
This property is "Expensive".

**string Destination**  
Sysout destination

**string DeviceName**  
Name of the device on which sysout is active

**string FCB** The name of the File Control Block (FCB) associated with this dataset.

**boolean HeldByOperator**  
Sysout is held due to operator command

**boolean HeldBySystem**  
Sysout is in a system hold

**boolean HeldByUser**  
Sysout is currently held

**string Identifier**  
This identifier is a value associated with this sysout that can be used in operator commands. The exact contents vary based on whether JES2 or JES3 owns the sysout and the release of JES processing the SSI request.

**boolean IPAddrDest**  
Indicates that the 'Destination' property contains an Internet Protocol (IP) address.

**string JobID** Job identified

**string Jobname**  
Job name

**uint16 MaxLogicalRecordLength**  
Maximum logical record length  
This property is "Expensive".

**string ModifyModname**  
Modify=(modname)

**string ModifyTrc**  
Modify=(,trc)

**boolean NotSelectable**  
Not selectable

**string OutDisp**  
Output disposition

**string Owner** Sysout owner

**uint32 PageCount**  
Page count

**uint8 Priority** Sysout priority

**string ProcessMode**  
Processing mode

**string ProcName**  
Procname for the step creating this data set

**uint32 RecordCount**  
Record count

**string RecordFormat**  
Record format  
This property is "Expensive".

**string Seclabel**  
Seclabel for sysput

**uint32 SegmentID**  
Segment ID (zero if data set is not segmented)

**boolean Spin** Spin data set

**string StepName**  
Stepname for the step creating this data set  
This property is "Expensive".

**string Subsystem**  
Subsystem name

**string SystemHoldReason**  
Reason for system hold

**string TPJobName**  
APPC transaction program jobname that created this data set

**string TranslateTable [ ]**  
Printer translate table

**string UCS** UCS

**string WriterName**  
External writer name

**string JobToken**  
Job token

**string OutputGroupElement**  
Sysout group name

**datetime OutputGroupElementCreateTime**  
JOE creation time

**uint16 OGID1** JOE ID1

**string Forms** specifies the forms on which the data set is to be printed

**string Flash** specifies the form overlay

## IBMzOS\_JES3SysoutDataset

### Purpose

This class is a subclass of IBMzOS\_SysoutDataset and contains those properties that are unique to a job that has run under JES3.

### Inheritance

IBMzOS\_SysoutDataset  
← IBMzOS\_JES3SysoutDataset

### Module name

The module name of the CMPI provider that is registered for a CIM class which is used by the cimprovider command line tool for the administration of CMPI providers is

IBMzOS\_JES3SysoutDatasetProviderModule

### Provider library

The physical name of a CMPI provider's shared object library as it is stored in the hierarchical file system is

libcmplIBMzOS\_JES3SysoutDatasetProvider.so

### Properties

The properties of IBMzOS\_JES3SysoutDataset are the same as for IBMzOS\_JES2SysoutDataset (see "IBMzOS\_JES2SysoutDataset" on page 188 with some exceptions:

IBMzOS\_JES3SysoutDataset does not provide the following properties of IBMzOS\_JES2SysoutDataset:

- OutputGroupElement
- OutputGroupElementCreateTime
- OGID1

The following properties are only part of IBMzOS\_JES3SysoutDataset:

#### boolean HeldForTSO

Sysout is held for TSO

#### boolean HeldForExternalWriter

Sysout is held for external writer



## IBMzOS\_Job

### **Purpose**

This class represents a z/OS job. Jobs are associated with a subsystem, such as JES2, JES3, or MSTR. Some properties may require significant overhead, including I/O, to obtain their data. These properties are identified with the qualifier of "Expensive". To reduce system overhead, the provider will only return the values for these expensive properties if they are explicitly requested by name.

### **Inheritance**

Subclasses are IBMzOS\_JES2Job (see "IBMzOS\_JES2Job" on page 168) and IBMzOS\_JES3Job (see "IBMzOS\_JES3Job" on page 179).

## IBMzOS\_JobsManagementSettings

### Purpose

The IBMzOS\_JobsManagementSettings class provides a mechanism by which users can influence the behavior of the IBMzOS\_JES2SysoutDataset, IBMzOS\_JES3SysoutDataset, IBMzOS\_JES2Jobs, and IBMzOS\_JES3Jobs providers.

### Properties

#### string Caption

A short description of the class

#### string Description

A description of the class

#### string ElementName

Name given to this instance of the class

#### string InstanceID [Key]

Within the scope of the instantiating NameSpace, *InstanceID* opaquely and uniquely identifies an instance of this class. In order to ensure uniqueness within the NameSpace, the value of InstanceID SHOULD be constructed using the following algorithm:  
<OrgID>:<LocalID>

where <OrgID> and <LocalID> are separated by a colon ':', and where <OrgID> MUST include a copyrighted, trademarked or otherwise unique name that is owned by the business entity creating/defining the InstanceID, or is a recognized global authority (This is similar to the <Schema Name>\_<Class Name> structure of Schema class names.) In addition, to ensure uniqueness <OrgID> MUST NOT contain a colon (':'). When using this algorithm, the first colon in InstanceID MUST be between <OrgID> and <LocalID>.

<LocalID> is chosen by the business entity and SHOULD not be re-used to identify different underlying (real-world) elements. If the above 'preferred' algorithm is not used, the defining entity MUST assure that the resultant InstanceID is not re-used across any InstanceIDs produced by this or other providers for this instance's NameSpace.

For DMTF defined instances, the 'preferred' algorithm MUST be used with the <OrgID> set to 'CIM'.

#### uint32 MaxInstances

The maximum number of instances that can be returned.

#### uint32 MaxProperties

The maximum number of properties that can be returned

## IBMzOS\_Subsystem

### Purpose

This class represents a z/OS Subsystem.

### Module name

The module name of the CMPI provider that is registered for a CIM class which is used by the cimprovider command line tool for the administration of CMPI providers is

IBMzOS\_SubsystemProviderModule

### Provider library

The physical name of a CMPI provider's shared object library as it is stored in the hierarchical file system is

libcmpiIBMzOS\_SubsystemProvider.so

### Properties

#### string Caption

A short description of the class

#### string Description

A description of the class

#### string ElementName

Name given to this instance of the class

#### datetime InstallDate

Not supported for z/OS.

#### string Name [key]

Subsystem name

#### uint16 OperationalStatus [ ]

The current status of the JobSubSystem:

0	Unknown
2	OK
6	Error
9	Stopping

#### string StatusDescriptions [ ]

Strings describing the various Operational Status values.

#### string Status

Not supported for z/OS.

#### uint16 EnabledState

Indicates the Enabled or Disabled state.

#### string OtherEnabledState

String describing the Enabled State value.

#### uint16 RequestedState

The last requested State.

#### uint16 EnabledDefault

Indicates the default value for Enabled State.

#### datetime TimeOfLastStateChange

Not supported for z/OS.

#### string SystemCreationClassName [key]

The scoping System's CreationClassName.

**string SystemName [key]**  
The scoping System's Name.

**string CreationClassName [key]**  
Indicates the name of the class or the subclass used in the creation of an instance. When used with the other key properties of this class, this property allows all instances of this class and its subclasses to be uniquely identified.

**string PrimaryOwnerName**  
Not supported for z/OS.

**string PrimaryOwnerContact**  
Not supported for z/OS.

**string StartMode**  
StartMode is a string value indicating whether the Service is automatically started by a System, Operating System, etc. or only started upon request.  
  
This property is deprecated. Use the EnabledDefault property inherited from EnabledLogicalElement instead.

**boolean Started**  
True if subsystem is active.

**boolean Dynamic**  
True is subsystem is dynamic.

**boolean DynamicCommands**  
True if subsystem responds to SETSSI command.

**boolean Primary**  
Indicator for primary subsystem

**uint8 Type**      Subsystem type code:

1	Unknown
2	JES2
3	JES3

## IBMzOS\_SysoutDataset

### Purpose

This class represents a z/OS sysout dataset. Some properties may require significant overhead, including I/O, to obtain their data. These properties are identified with the qualifier of "Expensive". To reduce system overhead, the provider will only return the values for these expensive properties if they are explicitly requested by name.

### Inheritance

Subclasses are

- IBMzOS\_JES2SysoutDataset (see "IBMzOS\_JES2SysoutDataset" on page 188) and
- IBMzOS\_JES3SysoutDataset (see "IBMzOS\_JES3SysoutDataset" on page 192).

## Association IBMzOS\_SubsystemJES2Jobs

### Purpose

This class associates an IBMzOS\_Subsystem with an IBMzOS\_JES2Job.

### Module name

The module name of the CMPI provider that is registered for a CIM class which is used by the cimprovider command line tool for the administration of CMPI providers is

IBMzOS\_SubsystemJES2JobsProviderModule

### Provider library

The physical name of a CMPI provider's shared object library as it is stored in the hierarchical file system is

libcmpiIBMzOS\_SubsystemJES2JobsProvider.so

## Association IBMzOS\_SubsystemJES3Jobs

### Purpose

This class associates an IBMzOS\_Subsystem with an IBMzOS\_JES3Job.

### Module name

The module name of the CMPI provider that is registered for a CIM class which is used by the cimprovider command line tool for the administration of CMPI providers is

IBMzOS\_SubsystemJES3JobsProviderModule

### Provider library

The physical name of a CMPI provider's shared object library as it is stored in the hierarchical file system is

libcmpiIBMzOS\_SubsystemJES3JobsProvider.so

## Association IBMzOS\_UsesJES2SysoutDatasets

### Purpose

This class associates an IBMzOS\_JES2Job with an IBMzOS\_JES2SysoutDataset.

### Module name

The module name of the CMPI provider that is registered for a CIM class which is used by the cimprovider command line tool for the administration of CMPI providers is

IBMzOS\_UsesJES2SysoutDatasetsProviderModule

### Provider library

The physical name of a CMPI provider's shared object library as it is stored in the hierarchical file system is

libcmpiIBMzOS\_UsesJES2SysoutDatasetsProvider.so

## Association IBMzOS\_UsesJES3SysoutDatasets

### Purpose

This class associates an IBMzOS\_JES3Job with an IBMzOS\_JES3SysoutDataset.

**Module name**

The module name of the CMPI provider that is registered for a CIM class which is used by the cimprovider command line tool for the administration of CMPI providers is

IBMzOS\_UsesJES3SysoutDatasetsProviderModule

**Provider library**

The physical name of a CMPI provider's shared object library as it is stored in the hierarchical file system is

libcmpiIBMzOS\_UsesJES3SysoutDatasetsProvider.so

---

## OS management Cluster classes

The classes described in this section are implemented by z/OS to instrument the z/OS "Systems Complex" (Sysplex) clustering facility.

For using these providers you need an extra security setup as described in "Setting up the CIM server for Cluster, CoupleDataset, and JES2-JES3Jobs providers" on page 38.



## IBMzOS\_CFRMCoupleDataset

### Purpose

This class represents Coupling Facility Resource Manager (CFRM) couple datasets. A CFRM couple dataset contains CFRM policies, one of which can be active (started), defining how z/OS manages coupling facility resources.

A CFRM couple dataset can be the active primary, or optionally, the active alternate couple dataset supporting the CFRM coupling function. Minimally, a CFRM couple dataset must be in use as the active primary CFRM couple dataset for CFRM coupling function to be active.

### Inheritance

IBMzOS\_CoupleDataset  
← IBMzOS\_CFRMCoupleDataset

### Module name

The module name of the CMPI provider that is registered for a CIM class which is used by the cimprovider command line tool for the administration of CMPI providers is

IBMzOS\_CFRMCoupleDatasetProviderModule

### Provider library

The physical name of a CMPI provider's shared object library as it is stored in the hierarchical file system is

libcmpiIBMzOS\_CFRMCoupleDatasetProvider.so

### Properties

**string Name** The name of the couple dataset represented by an instance of this class.

#### uint32 NumberOfStructures

The number of coupling facility (CF) structures that the CFRM couple dataset is formatted to support.

It is the maximum number of structures that can be defined for use in a policy contained in this couple dataset.

#### uint32 NumberOfConnectors

Identifies the number of connectors per structure that the couple dataset is formatted to support.

Connectors are programs running under z/OS that establish a connection to a CF structure. It is the maximum number of concurrent connectors that can be supported for each structure defined in the couple dataset.

#### uint32 NumberOfCFs

The number of coupling facilities the couple dataset is formatted to support.

It is the maximum number of CFs that can be defined for use in a CFRM policy contained in this couple dataset.

#### uint32 NumberOfPolicies

The number of administrative (inactive) policies that the couple dataset is formatted to support.

**boolean SystemManagedDuplexing**

Indicates whether or not the couple dataset is formatted to support the use of the system-managed duplexing rebuild process.

System-managed duplexing rebuild is a process managed by z/OS that allows a structure to be maintained as a duplexed pair. The process is controlled by CFRM policy definitions as well as by the program owning the structure. The process can be initiated via operator command (SETXCF), programming interface (IXLREBLD), or can be z/OS-initiated. Note that user-managed duplexing rebuild is controlled and initiated in the same manner as system-managed duplexing rebuild, but is managed by the program owning the structure and applies only to cache structures.

**boolean SystemManagedRebuild**

Indicates whether or not the couple dataset is formatted to support the use of the system-managed structure rebuild process.

System-managed structure rebuild is a process managed by z/OS that allows a structure to be rebuilt by z/OS. The process is controlled by CFRM policy definitions as well as by the program owning the structure. The process can be initiated via operator command (SETXCF), programming interface (IXLREBLD), or can be z/OS-initiated. Note that user-managed structure rebuild is controlled and initiated in the same manner as system-managed rebuild, but is managed by the program owning the structure and applies only to cache structures.

**boolean MessageBased**

Indicates whether or not the couple dataset is formatted to support the use of message-based CFRM event notification and confirmation capabilities.

## IBMzOS\_CFRMPolicy

### Purpose

This class represents administrative (inactive) Coupling Facility Resource Manager (CFRM) policies. CFRM policies are used to control Coupling Facility (CF) and CF structure resources available to a z/OS Sysplex (Systems Complex). There can be only one active CFRM policy and some number of administrative (inactive) policies.

### Module name

The module name of the CMPI provider that is registered for a CIM class which is used by the cimprovider command line tool for the administration of CMPI providers is

IBMzOS\_CFRMPolicyProviderModule

### Provider library

The physical name of a CMPI provider's shared object library as it is stored in the hierarchical file system is

libcmpiIBMzOS\_CFRMPolicyProvider.so

### Properties

#### string Caption

A short description of the class.

#### string Description

A description of the class.

#### string ElementName

Name given to this instance of the class.

#### datetime InstallDate

A datetime value indicating when the object was installed. A lack of a value does not indicate that the object is not installed.

#### string Name [key]

Name of CFRM Policy

#### uint16 OperationalStatus [ ]

The current status of the SysplexCoupleDataset:

0 = Unknown

2 = OK

6 = Error

9 = Stopping

#### string StatusDescriptions [ ]

Strings describing the various Operational Status values.

#### string Status

A string indicating the current status

#### string EnabledState

Indicates the Enabled or Disabled state.

#### string OtherEnabledState

String describing the Enabled State value.

#### uint16 RequestedState

The last requested State.

#### uint16 EnabledDefault

Indicates the default value for Enabled State.

**datetime TimeOfLastStateChange**

The date and time Enabled State was last changed.

**string PolicyText**

This property contains the CFRM policy statements that define the Coupling Facilities (CFs) and CF structures that are eligible to be used by programs operating in the Sysplex when this policy is activated (started) via the *StartPolicy()* method.

The CFRM policy, as defined by its *PolicyText*, governs many aspects of the use of CFs and CF structures by the Sysplex. For example, it governs CF structure placement, fixing, recovery and availability considerations.

**Methods**

**StartPolicy()** Starts a policy.

**StopPolicy()** Stops a policy.

## IBMzOS\_CFStructure

### Purpose

This class represents a zSeries Coupling Facility Structure.

### Module name

The module name of the CMPI provider that is registered for a CIM class which is used by the cimprovider command line tool for the administration of CMPI providers is

IBMzOS\_CFStructureProviderModule

### Provider library

The physical name of a CMPI provider's shared object library as it is stored in the hierarchical file system is

libcmpiIBMzOS\_CFStructureProvider.so

### Properties

#### string Caption

A short description of the class.

#### string Description

A description of the class.

#### string ElementName

Name given to this instance of the class.

#### datetime InstallDate

A datetime value indicating when the object was installed. A lack of a value does not indicate that the object is not installed.

**string Name** The Name of the structure as defined in the CFRM policy.

#### uint16 OperationalStatus [ ]

The current status of the CF Structure:

0	Unknown
2	OK
6	Error
9	Stopping

#### string StatusDescriptions [ ]

Strings describing the various Operational Status values.

**string Status** A string indicating the current status

#### uint16 EnabledState

Indicates the Enabled or Disabled state.

#### string OtherEnabledState

String describing the Enabled State value

#### uint16 RequestedState

The last requested State

#### uint16 EnabledDefault

Indicates the default value for Enabled State

#### datetime TimeOfLastStateChange

The date and time Enabled State was last changed.

#### uint64 IdentityToken [key]

The generated identity value for sysplex cluster. (Part 1 of 2)

**string IdentityName [key]**

The generated identity value for sysplex cluster. (Part 2 of 2)

**uint32 State** CF structure operational state:

- 1 Okay
- 2 Unknown
- 3 Error
- 4 Stopping

**uint32 SubState**

CF structure substate:

- 1 Normal (no exceptional conditions).
- 2 Temporarily degraded (alter in progress, structure dump serialization held).
- 3 Permanently degraded (allocated smaller than desired size, pending CFRM policy change).
- 4 Recovering (Valid only when the value of 'State' is 1 (Okay) or 4 (Stopping) ).

**uint8 Type** Structure type based on exploiter allocation requirements:

- 0x03 List
- 0xFF Lock
- 0x04 Cache
- 0xFE Serialized List

**boolean AllowAlter**

Indicator of whether this structure can be dynamically altered, based on current conditions. All active connectors to the structure specified ALLOWAUTO = YES on the IXLCONN connect request.

**boolean AllowAuto**

All active connectors to the structure specified ALLOWREBLD = YES on the IXLCONN connect request.

**boolean AllowRebuild**

All active connectors to the structure specified ALLOWDUPREBLD = YES on the IXLCONN connect request.

**boolean AllowDupRebuild**

All active connectors to the structure specified ALLOWALTER = YES on the IXLCONN connect request.

**boolean IsDuplexed**

Indicator of whether this structure actually is duplexed at this time. Only when this property indicates that the structure is duplexed, will the following properties be valid:

- MaximumStructureSize2
- InitialStructureSize2
- MinimumStructureSize2
- OverFullThreshold2
- StructureVersion2
- CFName2
- CurrentStructureSize2

**boolean PendPolicyChange**

Indicates that there is a change pending in structure policy.

**boolean Disposition**

Defines whether the structure is persistent when there are no longer any defined connections (active or failed):

**FALSE** Keep  
**TRUE** Delete

**string CFName1**

The name of the Coupling Facility in which this structure instance has been allocated.

It is possible to have two structure instances due to rebuild-in-progress or duplexing.

It is possible to have no structure instances when the structure is not currently allocated.

When Duplexed this is the 'Old' instance of the structure.

**string CFName2**

The name of the Coupling Facility in which the 'New' structure instance has been allocated. Null if not allocated.

This property is only valid when Duplexed.

**string StructureVersion1**

Structure version number for the currently allocated instance of the structure.

It is possible to have two structure instances due to rebuild-in-progress or duplexing. It is possible to have no structure instances when the structure is not currently allocated.

When Duplexed this is the 'Old' instance of the structure.

**string StructureVersion2**

Structure version number for the 'New' instance of the structure, when the structure is in the process of rebuilding or has been duplexed.

This property is only valid when Duplexed.

**uint32 MaximumStructureSize1**

The maximum size to which this instance of the structure can be expanded, in units of 4KB.

When Duplexed this is the 'Old' instance of the structure.

**uint32 MaximumStructureSize2**

The maximum size to which the 'New' instance of the structure can be expanded, in units of 4KB.

This property is only valid when Duplexed.

**uint32 InitialStructureSize1**

The requested initial structure allocation size, in units of 4KB, for this instance of the structure.

When Duplexed this is the 'Old' instance of the structure.

**uint32 InitialStructureSize2**

The requested initial structure allocation size, in units of 4KB, for the 'New' instance of the structure.

This property is only valid when Duplexed.

**uint32 MinimumStructureSize1**

The minimum size at which this instance of the structure can be allocated or contracted to, in units of 4KB.

When Duplexed this is the 'Old' instance of the structure.

**uint32 MinimumStructureSize2**

The minimum size at which the 'New' instance of the structure can be allocated or contracted to, in units of 4KB.

This property is only valid when Duplexed.

**uint32 CurrentStructureSize1**

The allocated structure size, in units of 4 KB, for this instance of the structure. Not provided if the structure is not allocated.

When Duplexed this is the 'Old' instance of the structure.

**uint32 CurrentStructureSize2**

The allocated structure size, in units of 4 KB, for the 'New' instance of the structure. Not provided if the structure is not allocated.

This property is only valid when Duplexed.

**uint32 SysMgdProcessLevel1**

System Managed Process Level required by the instance of the structure to participate in a system-managed process.

When Duplexed this is the 'Old' instance of the structure.

**uint32 SysMgdProcessLevel2**

System Managed Process Level required by the 'New' instance of the structure to participate in a system-managed process.

This property is only valid when Duplexed.

**uint32 ElementCount1**

Element Count for the structure. List set element count for List structures. Data area element count for Cache Structures. Invalid for Lock Structures.

When Duplexed this is the 'Old' instance of the structure.

**uint32 ElementCount2**

Element Count for the 'New' structure. List set element count for List structures. Data area element count for Cache Structures. Invalid for Lock Structures.

This property is only valid when Duplexed.

**uint32 EntryCount1**

Entry Count for the structure. List set entry count for List and Lock Structures. Directory entry count for cache structures.

When Duplexed this is the 'Old' instance of the structure.

**uint32 EntryCount2**

Entry Count for the 'New' structure. List set entry count for List and Lock Structures. Directory entry count for cache structures.

This property is only valid when Duplexed.

**uint32 EMCount1**

Event Monitor Controls count for List Structures. Invalid for Cache structures and Lock structures.



When Duplexed this is the 'Old' instance of the structure.

**uint32 EMCCount2**

Event Monitor Controls count for 'New' List Structures. Invalid for Cache structures and Lock structures.

This property is only valid when Duplexed.

**uint32 LockCount1**

Lock Entry Count. Valid for serialized List and Lock Structures. Invalid for Cache Structures and unserialized List structures.

When Duplexed this is the 'Old' instance of the structure.

**uint32 LockCount2**

Lock Entry Count. Valid for 'New' serialized List and Lock Structures. Invalid for Cache Structures and unserialized List structures.

This property is only valid when Duplexed.

**string LogicalVersion1**

Logical Version number for the instance of the structure.

When Duplexed this is the 'Old' instance of the structure.

**string LogicalVersion2**

Logical Version number for the 'New' instance of the structure.

This property is only valid when Duplexed.

**string PreferenceList1 [ ]**

Structure Preference List for the instance of the structure. It is an array of up to 8 Coupling Facility names.

When Duplexed this is the 'Old' instance of the structure.

**string PreferenceList2 [ ]**

Structure Preference List for the instance of the structure. This is an array of up to 8 coupling facility names.

This property is only valid when Duplexed.

**string ExclusionList1 [ ]**

The Structure Exclusion List for the instance of the structure. This is an array of up to 8 coupling facility names.

When Duplexed this is the 'Old' instance of the structure.

**string ExclusionList2 [ ]**

Structure Exclusion List for the 'New' instance of the structure. This is an array of up to 8 coupling facility names.

This property is only valid when Duplexed.

**uint32 AccessTimeMax1**

This instance of the structure was allocated with access time for IXLCONN ACCESSTIME(MAXIMUM).

When Duplexed this is the 'Old' instance of the structure.

**uint16 AccessTimeMax2**

The 'New' instance of the structure was allocated with access time for IXLCONN ACCESSTIME(MAXIMUM).

This property is only valid when Duplexed.

**uint16 MaximumConnections1**

The maximum number of connections allowed when the structure was allocated in the coupling facility.

When Duplexed this is the 'Old' version of the structure.

**uint16 MaximumConnections2**

The maximum number of connections allowed when the 'New' instance of the structure was allocated in the coupling facility.

This property is only valid when Duplexed.

**uint8 FullThreshold1**

Percentage value for the structure full monitoring threshold for the structure, as defined in CFRM policy. This threshold is set on-platform and is not currently settable through the resource model.

When Duplexed this is the 'Old' version of the structure.

**uint8 FullThreshold2**

Percentage value for the structure full monitoring threshold for the 'New' version of the structure, as defined in CFRM policy. This threshold is set on-platform and is not currently settable through the resource model.

This property is only valid when Duplexed.

**uint8 RebuildPercent1**

REBUILDPERCENT for the instance of the structure as specified in CFRM active policy. Not valid indicates not specified.

When Duplexed this is the 'Old' version of the structure.

**uint8 RebuildPercent2**

REBUILDPERCENT for the 'New' instance of the structure as specified in CFRM active policy. Not valid indicates not specified.

This property is only valid when Duplexed.

**uint8 DuplexPolicy1**

The effective DUPLEX option for the structure as specified in the CFRM active policy or defaulted.

When Duplexed this is the 'Old' version of the structure.

**uint8 DuplexPolicy2**

The effective DUPLEX option for the 'New' structure as specified in the CFRM active policy or defaulted.

This property is only valid when Duplexed.

**boolean OverFullThreshold1**

Indicator of whether or not the instance of the structure is currently in violation of its structure full monitoring threshold.

When Duplexed this is the 'Old' instance of the structure.

**boolean OverFullThreshold2**

Indicator of whether or not the 'New' instance of the structure is currently in violation of its structure full monitoring threshold.

This property is only valid when Duplexed.

**boolean AllowAutoAlter1**

ALLOWAUTOALT(YES) was specified in the CFRM active policy for the structure.

When Duplexed this is the 'Old' instance of the structure.

**boolean AllowAutoAlter2**

ALLOWAUTOALT(YES) was specified in the CFRM active policy for the 'New' structure.

This property is only valid when Duplexed.

**boolean EnforceOrder1**

ENFORCEORDER(YES) was specified in the CFRM active policy for the structure.

When Duplexed this is the 'Old' instance of the structure.

**boolean EnforceOrder2**

ENFORCEORDER(YES) was specified in the CFRM active policy for the 'New' structure.

This property is only valid when Duplexed.

**boolean AllowReallocate1**

ALLOWREALLOCATE(YES) was specified in the CFRM active policy for the structure.

When Duplexed this is the 'Old' instance of the structure.

**boolean AllowReallocate2**

ALLOWREALLOCATE(YES) was specified in the CFRM active policy for the 'New' structure.

This property is only valid when Duplexed.

**boolean AccessTimeNoLimit1**

The instance of the structure was allocated with IXLCONN ACESSTIME(NOLIMIT)

When Duplexed this is the 'Old' instance of the structure.

**boolean AccessTimeNoLimit2**

The 'New' instance of the structure was allocated with IXLCONN ACESSTIME(NOLIMIT).

This property is only valid when Duplexed.

**uint32 MaxElementCount1**

The maximum Element Count for the structure. List set element count for List structures. Data area element count for Cache Structures. Invalid for Lock Structures.

When Duplexed this is the 'Old' instance of the structure.

**uint32 MaxElementCount2**

The maximum Element Count for the 'New' structure. List set element count for List structures. Data area element count for Cache Structures. Invalid for Lock Structures. This property is only valid when Duplexed.

**uint32 MaxEntryCount1**

The maximum Entry Count for the structure. List set entry count for List and Lock Structures. Directory entry count for cache structures.

When Duplexed this is the 'Old' instance of the structure

**uint32 MaxEntryCount2**

The maximum Entry Count for the 'New' structure. List set entry count for List and Lock Structures. Directory entry count for cache structures.

This property is only valid when Duplexed.

**uint32 MaxEMCCount1**

The maximum Event Monitor Controls count for List Structures. Invalid for Cache structures and Lock structures. When Duplexed this is the 'Old' instance of the structure

**uint32 MaxEMCCount2**

The maximum Event Monitor Controls count for 'New' List Structures. Invalid for Cache structures and Lock structures. This property is only valid when Duplexed.

**Methods**

**uint32 StartRebuild()**

Asynchronously rebuilds the structure into the same or a different CF than the one in which it is currently located.

Only works if supported by exploiters. The Location parameter specifies the location where the new structure can be built.

The LessConnAction parameter indicates whether the rebuild should be allowed to continue, in spite of a degradation in connectivity to the new structure.

A rebuild operation should only be requested for structures that are identified as rebuild capable. The rebuild will be performed asynchronously. The return and reason codes will indicate whether the operation was initiated successfully. A property change event will be generated asynchronously when the rebuild has completed.

Coupling Facility Structure operations should only be invoked from a single system in the sysplex.

**uint32 StopRebuild()**

Stops a Rebuild operation.

A property change event will be generated when the operation has completed.

Coupling Facility Structure Operations should only be invoked from a single system in the sysplex.

**uint32 StartDuplex()**

Asynchronously establishes duplexing for the specified structure.

Only works if supported by exploiters. The request to start duplexing will be performed asynchronously. The return and reason codes will indicate whether the operation was initiated successfully. A property change event will be generated asynchronously when the duplexing has completed.

Coupling Facility Structure Operations should only be invoked from a single system in the sysplex.

**uint32 StopDuplex()**

Stops duplexing.

The required Keep parameter indicates which structure is to persist after duplexing has been stopped. The request to stop duplexing will be performed asynchronously. The return and reason codes will indicate whether the operation was initiated successfully. A property change event will be generated asynchronously when operation has completed.

Coupling Facility Structure Operations should only be invoked from a single system in the sysplex.

**uint32 Force()** Asynchronously forces the deallocation of a persistent structure.

Force of a structure does not work if there are any active connectors to the structure, and may or may not work if there are failed connectors to the structure. The return and reason codes will indicate whether the operation was initiated successfully. CFStructure property change event or life cycle event will be generated asynchronously when the Force operation has completed.

**uint32 ForceAll()**

Asynchronously forces the deletion of all failed-persistent connections for this structure.

The return and reason codes will indicate whether the operation was initiated successfully. Connector life cycle events or relationship-related events will be generated asynchronously when the failed persistent connectors are deleted.

## Associations

### IBMzOS\_CFStrDependsOn

<b>Source</b>	IBMzOS_CFStructure
<b>Target</b>	IBMzOS_CFStructureConnector
<b>see</b>	page 237

## Indications

### IBMzOS\_CFStructureInstCreation

A 'life cycle' indication that indicates that an instance of the IBMzOS\_CFStructure class has been created.

### IBMzOS\_CFStructureInstDeletion

A 'life cycle' indication that indicates that an instance of the IBMzOS\_CFStructure class has been deleted.

### IBMzOS\_CFStructureInstModification

A 'life cycle' indication that indicates that an instance of the IBMzOS\_CFStructure class has been modified.

## IBMzOS\_CFStructureConnector

### Purpose

This class represents a zSeries Coupling Facility Structure Connector.

### Module name

The module name of the CMPI provider that is registered for a CIM class which is used by the cimprovider command line tool for the administration of CMPI providers is

IBMzOS\_CFStructureConnectorProviderModule

### Provider library

The physical name of a CMPI provider's shared object library as it is stored in the hierarchical file system is

libcmpiIBMzOS\_CFStructureConnectorProvider.so

### Properties

#### string Caption

A short description of the class.

#### string Description

A description of the class.

#### string ElementName

Name given to this instance of the class.

#### datetime InstallDate

A datetime value indicating when the object was installed. A lack of a value does not indicate that the object is not installed.

#### string Name

The Connector name.

#### uint16 OperationalStatus [ ]

The current status of the CF connector:

0	Unknown
2	OK
6	Error
9	Stopping

#### string StatusDescriptions [ ]

Strings describing the various Operational Status values.

#### string Status

A string indicating the current status

#### uint16 EnabledState

Indicates the Enabled or Disabled state.

#### string OtherEnabledState

String describing the Enabled State value

#### uint16 RequestedState

The last requested State

#### uint16 EnabledDefault

Indicates the default value for Enabled State

#### datetime TimeOfLastStateChange

The date and time Enabled State was last changed.

#### uint64 IdentityToken [key]

The generated identity value for sysplex cluster. (Part 1 of 2)

**string IdentityName [key]**  
The generated identity value for sysplex cluster. (Part 2 of 2)

**string ConnectorStructureName**  
The CFStructure name for the connection.

**string ConnectorSystemName**  
OperatingSystem name for the system where the connector is running.

**string ConnectorProcessName**  
Process name for the process in which the connector is running (for z/OS this is a jobname).

**string ConnectorProcessID [ ]**  
Unique process identification for the process in which the connector is running (for z/OS this is a token).

**uint32 State** Operational state of the CF connector:  
 0 Okay  
 2 Unknown  
 6 Error  
 9 Stopping

**string ConnectorLevel**  
Connector-specified level information, or 0 if not provided by the connector.

**boolean FailureIsolation**  
Indicator of whether or not the structure as currently allocated satisfies this connector's requirements for failure-isolation.

**boolean Disposition**  
Indicator of the connector disposition. Defines whether the connection is persistent if the connection abnormally terminates.  
**FALSE** Delete  
**TRUE** Keep

**boolean NonVolatileRequest**  
Indicator of whether the connector requested non-volatility.

**string ConnectorIdentifier**  
Connector Identifier.

**string ConnectorVersion**  
Connector version number.

**string ConnectorData**  
Connector data.

**uint8 ConnectorInfoLevel**  
Connector Level of information.

**uint8 ConnectorCFLevelRequired**  
Connector CF Level required.

**boolean AllowRebuild**  
Indicates that the connector was connected with ALLOWREBUILD = YES

**boolean AllowDupRebuild**  
Indicates that the connector was connected with ALLOWDUPBUILD = YES

**boolean AllowAuto**

Indicates that the connector was connected with ALLOWAUTO = YES

**boolean AllowAlter**

Indicates that the connector was connected with ALLOWALTER = YES

**boolean Suspend**

Indicates that the connector was connected with ALLOWALTER = YES, SUSPEND = YES

**boolean AllowRatio**

Indicates that the connector was connected with ALLOWALTER = YES, RATIO = YES

**uint8 MinEntry**

Indicates the value the connector specified for MINENTRY

**uint8 MinElement**

Indicates the value the connector specified for MINELEMENT

**uint8 MinEMC**

Indicates the value the connector specified for MINEMC

**Methods**

**uint32 Force()** Asynchronously forces deletion of a failed connector to a structure, following a failure.

For some structures this is not permitted unless the structure itself is also forced (deallocated). This operation can only be performed against a structure connector in the ERROR state. The return and reason codes will indicate whether the operation was initiated successfully. Structure connector property change events or life cycle events will be generated asynchronously when the force operation has completed.

**Indications****IBMzOS\_CFStrConnectorInstCreation**

A 'life cycle' indication that indicates that an instance of the IBMzOS\_CFStrConnector class has been created.

**IBMzOS\_CFStrConnectorInstDeletion**

A 'life cycle' indication that indicates that an instance of the IBMzOS\_CFStrConnector class has been deleted.

**IBMzOS\_CFStrConnectorInstModification**

A 'life cycle' indication that indicates that an instance of the IBMzOS\_CFStrConnector class has been modified.



## IBMzOS\_CoupleDataset

### Purpose

This class represents the methods and properties common to all specific types of z/OS couple datasets. Examples of z/OS couple datasets include z/OS System Complex (Sysplex) and Coupling Facility Resource Manager (CFRM) couple datasets.

### Inheritance

Subclasses are

- IBMzOS\_SysplexCoupleDataset (see “IBMzOS\_SysplexCoupleDataset” on page 233) and
- IBMzOS\_CFRMCoupleDataset (see “IBMzOS\_CFRMCoupleDataset” on page 201).

### Properties

#### string Caption

A short description of the class.

#### string Description

A description of the class.

#### string ElementName

Name given to this instance of the class.

#### datetime InstallDate

Not supported for z/OS.

#### string Name [key]

Name of Couple Dataset

#### uint16 OperationalStatus [ ]

The current status of the SysplexCoupleDataset:

0 = Unknown

2 = OK

6 = Error

9 = Stopping

#### string StatusDescriptions [ ]

Strings describing the various Operational Status values.

#### string Status

Not supported for z/OS.

#### string CSCreationClassName [key]

The scoping ComputerSystem's CreationClassName.

#### string CSName [key]

The scoping ComputerSystem's Name.

#### string FSCreationClassName [key]

The scoping FileSystem's CreationClassName.

#### string FSName [key]

The scoping FileSystem's name.

#### string CreationClassName [key]

CreationClassName indicates the name of the class or the subclass used in the creation of an instance.

When used with the other key properties of this class, this property allows all instances of this class and its subclasses to be uniquely identified.

**uint64 FileSize**

Not supported for z/OS.

**datetime CreationDate**

Not supported for z/OS.

**datetime LastModified**

Not supported for z/OS.

**datetime LastAccessed**

Not supported for z/OS.

**boolean Executable**

Indicates that the File is executable.

**string CompressionMethod**

Not supported for z/OS.

**string EncryptionMethod**

Not supported for z/OS.

**uint64 InUseCount**

Not supported for z/OS.

**string SysplexName**

This is the name of the z/OS Sysplex to which the couple dataset represented by an instance of this class belongs.

Couple datasets are formatted for use in a particular Sysplex and cannot be used by a Sysplex other than the one for which they have been formatted.

**string Volser** This is the volume serial of the logical volume on which the couple dataset is defined.

**string DeviceNumber**

This is the z/OS device number of the logical volume on which the couple dataset is defined. The device number is local to the z/OS system from which this instance was obtained.

A logical volume may have different device numbers on different z/OS systems in the Sysplex, even though it is the same logical volume being shared by the different z/OS systems.

**string NarrativeInfo**

This property contains information used by the couple dataset owner to provide additional descriptive information about the couple dataset and its usage. This information includes formatting characteristics and any special functions or attributes that the couple dataset supports.

**string Type** This property identifies the type of couple dataset the instance represents. Some examples of couple dataset types include CFRM and SYSPLEX. There are other types of couple datasets, although not all of them are externalized through CIM.

**boolean IsPrimary**

This property identifies whether the couple dataset represented by an instance is currently in use as the primary couple dataset for its type.

A value of True indicates that this instance represents the couple dataset that is currently in use as the primary couple dataset of its type.

**boolean IsAlternate**

This property identifies whether the couple dataset represented by an instance is currently in use as the alternate couple dataset "for its type.

A value of True indicates that this instance represents the couple dataset that is currently in use as the alternate couple dataset of its type.

**uint32 MaximumNumberOfSystems**

This property identifies the number of z/OS systems in the Sysplex that the couple dataset represented by this instance was formatted to support.

**datetime FormatTime**

This property identifies the local time that the couple dataset was formatted.

**Note:** This property is in the local time of the operating system host servicing the request.

**boolean IsSynchronized**

This property applies only to instances representing couple datasets that are currently in use as the alternate couple dataset for their type.

A value of True indicates that the couple dataset has been fully synchronized with the primary couple dataset of its type.

A value of False indicates that the couple dataset is still in the process of synchronizing with the primary couple dataset of its type.

An alternate couple dataset must be fully synchronized with the primary couple dataset of its type in order to provide failover capability in the event of an error affecting the primary couple dataset.

**boolean ErrorState**

This property identifies whether the couple dataset is in an error state. When True, the couple dataset has experienced a permanent error and is in the process of being removed from active use.

**uint32 NumberOfStructures**

This is the number of coupling facility (CF) structures that the CFRM couple dataset is formatted to support. It is the maximum number of structures that can be defined for use in a policy contained in this couple dataset.

**uint32 NumberOfConnectors**

Connectors are programs running under z/OS that establish a connection to a CF structure. This property identifies the number of connectors per structure that the couple dataset is formatted to support. It is the maximum number of concurrent connectors that can be supported for each structure defined in the couple dataset.

**uint32 NumberOfCFs**

This is the number of coupling facilities the couple dataset is

formatted to support. It is the maximum number of CFs that can be defined for use in a CFRM policy contained in this couple dataset.

**uint32 NumberOfPolicies**

This is the number of administrative (inactive) policies that the couple dataset is formatted to support.

**Methods**

**uint32 SwitchPrimary()**

This method switches the couple dataset represented by this instance as follows:

If the instance represents a current in-use alternate couple dataset, it is switched to become the current primary couple dataset. If the alternate couple dataset is not fully synchronized or is in an error state, the method returns an error.

If the instance represents a current in-use primary couple dataset, then it is switched out and the current in-use alternate couple dataset is switched to become the primary. If there is no current in-use alternate couple dataset or the in-use alternate couple dataset is not fully synchronized or in an error state, the method returns an error.

This method functions like the z/OS operator command:

```
SETXCF COUPLE,TYPE=___,PSWITCH
```

## IBMzOS\_CouplingFacility

### Purpose

This class represents a zSeries Coupling Facility, which is the system that manages a Sysplex (System Complex).

### Module name

The module name of the CMPI provider that is registered for a CIM class which is used by the cimprovider command line tool for the administration of CMPI providers is

IBMzOS\_CouplingFacilityProviderModule

### Provider library

The physical name of a CMPI provider's shared object library as it is stored in the hierarchical file system is

libcmpiIBMzOS\_CouplingFacilityProvider.so

### Properties

#### string Caption

A short description of the class. Returns *'IBM z/OS Coupling Facility'*.

#### string Description

A description of the class. Returns *This is an IBM z/OS Coupling Facility*.

#### string ElementName

Name given to this instance of the class (same as Name)

#### datetime InstallDate

A datetime value indicating when the object was installed. A lack of a value does not indicate that the object is not installed.

#### string Name

Coupling Facility Logical Name as assigned by CFRM policy definitions.

Note: CF Name is not considered an immutable property of a Coupling Facility, since the name can be changed via a CFRM policy update. The physical CF information is the immutable identification information.

#### uint16 OperationalStatus [ ]

The current status of the CF (summarized from more granular CF state information):

0	Unknown
2	OK
6	Error
9	Stopping

#### string StatusDescriptions [ ]

Strings describing the various Operational Status values.

#### string Status

A string indicating the current status

#### uint16 EnabledState

Indicates the Enabled or Disabled state.

#### string OtherEnabledState

String describing the Enabled State value

**uint16 RequestedState**  
The last requested State

**uint16 EnabledDefault**  
Indicates the default value for Enabled State

**datetime TimeOfLastStateChange**  
The date and time Enabled State was last changed.

**uint64 IdentityToken [key]**  
The generated identity value for sysplex cluster. (Part 1 of 2)

**string IdentityName [key]**  
The generated identity value for sysplex cluster. (Part 2 of 2)

**string MachineType**  
Machine type of the server hosting the CF

**string Manufacturer**  
Name of the manufacturer of the server hosting the CF

**string ManufacturerPlant**  
The plant number where the machine was manufactured

**string SerialNumber**  
A manufacturer assigned number to identify the server hosting the CF

**uint8 LPARid** Platform-assigned ID of a logical partition in which the CF is running. Null if the Computer System is not virtualized

**uint32 CFLevel**  
Facility operational (functionality) level

**uint32 State** CF Operational State (summarized from more granular CF state information):

1	Okay
2	Unknown
6	Error
9	Stopping

**uint16 NumberOfProcessors**  
Total number of CF processors

**uint16 CPUUtilization**  
Percent CF processor utilization

**uint32 FreeSpace**  
Currently unused storage available in the CF (in number of 4KB blocks)

**uint32 TotalSpace**  
Total storage available in the CF (in number of 4KB blocks)

**uint32 FreeDumpSpace**  
Currently unused allocated dump storage available in the CF (in number of 4KB blocks)

**uint32 TotalDumpSpace**  
Total allocated dump storage available in the CF (in number of 4KB blocks)

**uint32 StorageIncrementSize**  
Storage increment. The number of 4K blocks in a single storage increment in this CF.

**boolean Standalone**

Coupling Facility Standalone indicator:

**TRUE** Not Standalone**FALSE** Standalone**boolean Volatile**

Indicator of whether this CF is volatile or nonvolatile (based on battery backup or standby power source)

**boolean CPUType**

Indicates whether all of the CF processors are shared, or whether at least one is dedicated:

**TRUE** All shared**FALSE** Some are dedicated**boolean MaintenanceMode**

Indicates whether the CF is currently in Maintenance mode:

**TRUE** Not in Maintenance mode**FALSE** CF is in Maintenance mode**boolean RecoveryMgrSite****TRUE** Recovery Manager is not active or the CF does not reside at the recovery site**FALSE** Recover Manager is active and the CF resides at the recovery site.**string SiteName**

Name of the SITE specified in the CFRM policy.

**string CPCID** Coupling Facility's Central Processor Complex (CPC) ID.**string CFCCReleaseLevel**

The release level of the CFCC code.

**string CFCCServiceLevel**

The service level of the CFCC code.

**datetime CFCCCodeBuildDate**

The date and time that the CFCC code was built.

**Methods****uint32 StartCFMaintenanceMode()**

Sets the maintenance mode of the specified coupling facility to ON.

When a CF is in maintenance mode, the CF is not eligible for CF structure allocation purposes and all structure allocation processes will modify their CF selection processing accordingly.

**uint32 StopCFMaintenanceMode()**

Sets the maintenance mode of the specified coupling facility to OFF.

When a CF is no longer in maintenance mode, the CF is eligible for CF structure allocation purposes.

**Associations****IBMzOS\_HostedCFStructure****Source** IBMzOS\_CFStructure**Target** IBMzOS\_CouplingFacility**see** page 238**IBMzOS\_UsesCFs**

<b>Source</b>	IBMzOS_SysplexNode
<b>Target</b>	IBMzOS_CouplingFacility
<b>see</b>	page 239

## **Indications**

### **IBMzOS\_CouplingFacilityInstCreation**

A 'life cycle' indication that indicates that an instance of the IBMzOS\_CouplingFacility class has been created.

### **IBMzOS\_CouplingFacilityInstDeletion**

A 'life cycle' indication that indicates that an instance of the IBMzOS\_CouplingFacility class has been deleted.

### **IBMzOS\_CouplingFacilityInstModification**

A 'life cycle' indication that indicates that an instance of the IBMzOS\_CouplingFacility class has been modified.



# IBMzOS\_CouplingFunction

## Purpose

This class represents an abstraction of z/OS clustering capabilities. The clustering capabilities are referred to as coupling functions, each serving a unique purpose in a z/OS Systems Complex (Sysplex). Coupling functions are capabilities that are facilitated through the use of:

- Couple datasets, which serve as repositories.
- Coupling facilities, which are used by z/OS systems to cache data structures, serialization structures and provide signaling capabilities to z/OS systems participating in a Sysplex.
- Cross-System Coupling Facility (XCF) software, which is a component of z/OS that provides functions to support cooperation between authorized programs running within a Sysplex.

Coupling functions include such capabilities as basic Sysplex support and Coupling Facility Resource Manager (CFRM) support. There are other such coupling functions supported by z/OS, though not all of them may be externalized through CIM providers.

## Module name

The module name of the CMPI provider that is registered for a CIM class which is used by the `cimprovider` command line tool for the administration of CMPI providers is

`IBMzOS_CouplingFunctionProviderModule`

## Provider library

The physical name of a CMPI provider's shared object library as it is stored in the hierarchical file system is

`libcmpiIBMzOS_CouplingFunctionProvider.so`

## Properties

### string Caption

A short description of the class.

### string Description

A description of the class.

### string ElementName

Name given to this instance of the class.

### datetime InstallDate

A datetime value indicating when the object was installed. A lack of a value does not indicate that the object is not installed.

### string Name [key]

Name of the coupling function

### uint16 OperationalStatus [ ]

The current status of the SysplexCoupleDataset:

- 0 = Unknown
- 2 = OK
- 6 = Error
- 9 = Stopping

**string StatusDescriptions [ ]**  
 Strings describing the various Operational Status values.

**string Status** A string indicating the current status

**uint16 EnabledState**  
 Indicates the Enabled or Disabled state.

**string OtherEnabledState**  
 String describing the Enabled State value.

**uint16 RequestedState**  
 The last requested State.

**uint16 EnabledDefault**  
 Indicates the default value for Enabled State.

**datetime TimeOfLastStateChange**  
 The date and time Enabled State was last changed.

**uint32 Redundancy**  
 This identifies the level of couple dataset redundancy currently active for the coupling function.

- 0 No couple datasets in use. The coupling function is not active.
- 1 Primary couple dataset in use.
- 2 Primary and alternate couple dataset are in use.

**string ActivePolicyName**  
 Specifies the name of the active policy for the coupling function. Instances of coupling functions such as SYSPLEX, which have no policy, will have a null string value.

**datetime TimeActivePolicyStarted**  
 The local date and time that the active policy was started.

**Note:** This property is in the local time of the operating system host servicing the request.

**boolean isActive**  
 Identifies whether the coupling function is active.

Coupling functions with no primary CDS are considered inactive.

Coupling functions that support policies will be identified as active if they have a primary couple dataset in use, even if there is not active policy.

## Methods

**uint32 StartPolicy()**  
 This method activates (starts) the specified policy.

The policy specified by the name parameter must be an administrative policy defined in the primary couple dataset currently in use by the coupling function.

**uint32 StopPolicy()**  
 This method inactivates the currently active policy. For Coupling Facilities (CFs) or structures that are actively being used, not all aspects of the policy may become inactive immediately. These changes will become pending until the resources in question are no longer being used by programs operating in the Sysplex.

### **uint32 DeletePolicy()**

This method deletes the specified administrative policy.

The policy specified by the name parameter must be an administrative policy defined in the primary couple dataset currently in use by the coupling function.

### **uint32 SwitchPrimary()**

This method makes the current in-use alternate couple dataset the current primary couple dataset for the type represented by the coupling function instance.

The current in-use primary couple dataset at the time this method is invoked, upon successful completion of the method, will no longer be recognized by XCF and the coupling function instance will be operating solely with a primary couple dataset.

This method is similar to the z/OS operator command:

```
SETXCF COUPLE,TYPE=__ ,PSWITCH
```

### **uint32 MakeAlternate()**

This method makes the specified couple dataset the current in use alternate couple dataset for the type represented by the coupling function instance.

The type of the specified couple dataset must be compatible with the coupling function instance for which the method was invoked.

The specified couple dataset must be a newly formatted couple dataset, formatted specifically for use in the Sysplex in which the coupling function instance exists. The method will fail if the specified couple dataset is currently or was previously active in the Sysplex.

The specified couple dataset may be one created using the Duplicate method or one created manually via the XCF couple dataset format utility (IXCL1DSU).

### **uint32 Duplicate()**

This method duplicates the characteristics of the currently active primary couple dataset, for the type represented by the coupling function instance, to a new couple dataset. The name of the new couple dataset and the volume serial of the logical volume on which it will be allocated must be specified by the method invoker. The type of the couple dataset is determined by the coupling function instance.

## **Associations**

### **IBMzOS\_UsesCouplingFunctions**

<b>Source</b>	IBMzOS_Sysplex
<b>Target</b>	IBMzOS_CouplingFunction
<b>see</b>	page 240

### **IBMzOS\_UsesSysplexCoupleDatasets**

<b>Source</b>	IBMzOS_CouplingFunction
<b>Target</b>	IBMzOS_SysplexCoupleDataset
<b>see</b>	page 240

### **IBMzOS\_UsesCFRMCoupleDatasets**

<b>Source</b>	IBMzOS_CouplingFunction
<b>Target</b>	IBMzOS_CFRMCoupleDataset

**see** page 239

## IBMzOS\_SFMAAttributes

### Purpose

An array of embedded instances of this class is used as input parameter to method SetSFMAAttributes() (see “Methods” on page 231).

### Properties

#### uint64 IdentityToken

Is the 'IdentityToken' of the SysplexNode whose SFM attributes are to be modified. The IdentityToken is a 64 bit unsigned integer that must be converted to a 20 character field, padded on the left with the character zero ('0'). An IdentityToken and IdentityName of '0' indicates that default values should be set for all SysplexNodes.

#### string IdentityName

Is the 'IdentityName' of the SysplexNode whose SFM attributes are to be modified. An IdentityToken and IdentityName of '0' indicates that default values should be set for all SysplexNodes.

#### boolean SetSystemWeight

Indicates that the SFM\_Weight property should be updated.

#### boolean SetSystemSFMAAction

Indicates that the SFM\_Action (and possibly the SFM\_Interval) property should be updated.

#### boolean SetMemStallTime

Indicates that the SFM stalled member action for the system should be updated.

#### boolean ResetMemStallTime

Indicates that the SFM stalled member action for the system should be cleared.

#### uint32 System\_Weight

Is the new SFM weight value. The SFM weight is a 32 bit unsigned integer that must be converted to a 10 character field, padded on the left with the character zero ('0').

#### uint32 SFM\_Action

Is the new SFM action value. Valid character values are:

- 1 Prompt operator
- 2 Isolate
- 3 System reset
- 4 Deactivate

#### uint32 SFM\_Interval

Is the time in seconds corresponding to the SFM action. It is valid only when the action is being set to isolate (2), SystemReset (3), or Deactivate (4). The time is a 32 bit unsigned integer that must be converted to a 10 character field, padded on the left with the character zero ('0').

#### uint32 MemStallTime

Is the time in seconds that must pass before SFM takes action against a stalled member causing signal sympathy sickness.

# IBMzOS\_Sysplex

## Purpose

This class represents a zSeries Sysplex (System Complex).

## Inheritance

A subclasses is IBMzOS\_SysplexNode (see "IBMzOS\_SysplexNode" on page 234).

## Module name

The module name of the CMPI provider that is registered for a CIM class which is used by the cimprovider command line tool for the administration of CMPI providers is

IBMzOS\_SysplexProviderModule

## Provider library

The physical name of a CMPI provider's shared object library as it is stored in the hierarchical file system is

libcmplibmzOS\_SysplexProvider.so

## Properties

### string Caption

A short description of the class.

### string Description

A description of the class.

### string ElementName

Name given to this instance of the class.

### datetime InstallDate

A datetime value indicating when the object was installed. A lack of a value does not indicate that the object is not installed.

### string Name

Sysplex name

### uint16 OperationalStatus [ ]

The current status of the Sysplex, based on the states of the systems it is comprised of:

0	Unknown
2	OK
6	Error
9	Stopping

### string StatusDescriptions [ ]

Strings describing the various Operational Status values.

### string Status

A string indicating the current status

### uint16 EnabledState

Indicates the Enabled or Disabled state.

### string OtherEnabledState

String describing the Enabled State value

### uint16 RequestedState

The last requested State

### uint16 EnabledDefault

Indicates the default value for Enabled State

**datetime TimeOfLastStateChange**

The date and time Enabled State was last changed.

**uint64 IdentityToken [key]**

The generated identity value for sysplex cluster. (Part 1 of 2)

**string IdentityName [key]**

The generated identity value for sysplex cluster. (Part 2 of 2)

**uint32 Type** The type of sysplex cluster:

- 1 Local
- 2 Monoplex
- 3 Multisystem

**uint32 State** State of the Sysplex, based on the states of the systems it is comprised of:

- 1 Okay
- 2 Unknown
- 3 Error
- 4 Stopping

z/OS, will only report a state of "Okay" (1)

**boolean SysplexConnectionFail**

Corresponds to the CONNFAIL attribute in the SFM policy. Indicates whether or not action taken when connectivity failure occurs in the sysplex.

**Methods****uint32 SetSFMAAttributes()**

Updates the SFM policy to set the SFM weights for each system specified in the input, SystemArray, and will set the Sysplex Connect Fail property value for the sysplex.

Successful execution of this method will indicate that all the entries in the SystemArray were processed. If any of the system entries could not be processed the method will return an error.

An array of embedded instances of class IBMzOS\_SFMAAttributes is used as input parameter to this method (see "IBMzOS\_SFMAAttributes" on page 229).

**uint32 SetSysplexConnFail()**

Sets the ConnectionFail property value.

**uint32 ResetSysplexConnFail()**

Resets the ConnectionFail property value.

**uint32 StartReallocate()**

Analyzes all structures in the Sysplex and performs corrective actions on structures that are operating outside current CFRM policy parameters.

Sysplex Process Completion Indication will be generated when asynchronous processing has completed.

**uint32 StopReallocate()**

Stops the reallocation of CF structures.

Sysplex Process Completion Indication will be generated when asynchronous processing has completed.

### **uint32 ForceReallocate()**

Forces an in process reallocation to be stopped.

Sysplex Process Completion Indication will be generated when asynchronous processing has completed.

## **Associations**

### **IBMzOS\_CollectionOfCFs**

<b>Source</b>	IBMzOS_Sysplex
<b>Target</b>	IBMzOS_CouplingFacility
<b>see</b>	page 237

### **IBMzOS\_CollectionOfSysplexNodes**

<b>Source</b>	IBMzOS_Sysplex
<b>Target</b>	IBMzOS_SysplexNode
<b>see</b>	page 237

### **IBMzOS\_UsesCouplingFunctions**

<b>Source</b>	IBMzOS_Sysplex
<b>Target</b>	IBMzOS_CouplingFunction
<b>see</b>	page 240

## **Indications**

### **IBMzOS\_SysplexInstCreation**

A 'life cycle' indication that indicates that an instance of the IBMzOS\_Sysplex class has been created. The Sysplex supports services that may report on cluster manageable resources. This event occurs when each system has IPLed into the Sysplex with a Cluster capable Sysplex Couple Dataset. This event occurs on each system when a Cluster capable dataset has been brought into use.

### **IBMzOS\_SysplexInstModification**

A 'life cycle' indication that indicates that an instance of the IBMzOS\_Sysplex class has been modified. The SysplexConnectionFail property has changed.

### **IBMzOS\_Sysplex\_CFRM\_CDS\_Initialized**

A 'process' indication that indicates that the process of reallocating the CF Structures has completed. CFRM Resources (Coupling Facility, CF Structure and CF Structure Connectors) has been defined to the Sysplex. The z/OS Cluster MR Services should be issued to obtain the CFRM resource instances in use by the Sysplex.

### **IBMzOS\_Sysplex\_ReallocateInitiated**

A 'process' indication that indicates that the Start Reallocate CF Structures process has been initiated. The reallocate command may have been initiated by an operator command or through a CIM StartReallocate() method.

### **IBMzOS\_Sysplex\_ReallocateCompleted**

A 'process' indication that indicates that the Start, Stop, or Force Reallocate CF Structures command has completed processing. The reallocate command may have been initiated by an operator command or through a CIM StartReallocate(), StopReallocate(), or ForceReallocate() methods.



# IBMzOS\_SysplexCoupleDataset

## Purpose

This class represents the z/OS Systems Complex (Sysplex) couple datasets. A Sysplex couple dataset contains Sysplex-wide data about systems, groups, and members that use Cross-System Coupling Facility (XCF) services. All z/OS systems in a Sysplex must have connectivity to the Sysplex couple dataset.

A Sysplex couple dataset can be the primary, or optionally, the active alternate couple dataset supporting the Sysplex coupling function. Minimally, a Sysplex couple dataset must be in use as the active primary Sysplex couple dataset for the Sysplex function to be active.

## Inheritance

IBMzOS\_CoupleDataset  
← IBMzOS\_SysplexCoupleDataset

## Module name

The module name of the CMPI provider that is registered for a CIM class which is used by the cimprovider command line tool for the administration of CMPI providers is

IBMzOS\_SysplexCoupleDatasetProviderModule

## Provider library

The physical name of a CMPI provider's shared object library as it is stored in the hierarchical file system is

libcmpiIBMzOS\_SysplexCoupleDatasetProvider.so

## Properties

**string Name** The name of the couple dataset represented by an instance of this class.

### uint32 NumberOfGroups

The number of XCF groups that the couple dataset is formatted to support. It is the maximum number of concurrently active XCF groups that can be active in the Sysplex while this couple dataset is in use as the primary Sysplex couple dataset.

### uint32 NumberOfMembers

The number of XCF members per group that this couple dataset is formatted to support. Each XCF group in the Sysplex may have up to this number of concurrently active programs (XCF members) participating in the group.

### uint32 GRSLevel

Indicates whether or not this couple dataset supports the use of Global Resource Serialization (GRS) STAR for Sysplex-scope resource serialization. GRS STAR provides improved performance and reliability over the use of GRS RING.

# IBMzOS\_SysplexNode

## Purpose

This class represents a node in a zSeries Sysplex (System Complex). There is one node in a Sysplex for every z/OS system that comprises the Sysplex.

## Inheritance

IBMzOS\_Sysplex  
← IBMzOS\_SysplexNode

## Module name

The module name of the CMPI provider that is registered for a CIM class which is used by the cimprovider command line tool for the administration of CMPI providers is

IBMzOS\_SysplexNodeProviderModule

## Provider library

The physical name of a CMPI provider's shared object library as it is stored in the hierarchical file system is

libcmpiIBMzOS\_SysplexNodeProvider.so

## Properties

### string Caption

A short description of the class.

### string Description

A description of the class.

### string ElementName

Name given to this instance of the class.

### datetime InstallDate

A datetime value indicating when the object was installed. A lack of a value does not indicate that the object is not installed.

**string Name** SysplexNode name which is the same as the Operating System's System Name

### uint16 OperationalStatus [ ]

The current status of the SysplexNode:

0	Unknown
2	OK
6	Error
9	Stopping

### string StatusDescriptions [ ]

Strings describing the various Operational Status values.

**string Status** A string indicating the current status

### uint16 EnabledState

Indicates the Enabled or Disabled state.

### string OtherEnabledState

String describing the Enabled State value

### uint16 RequestedState

The last requested State

**uint16 EnabledDefault**

Indicates the default value for Enabled State

**datetime TimeOfLastStateChange**

The date and time Enabled State was last changed.

**uint64 IdentityToken [key]**

The generated identity value for sysplex cluster. (Part 1 of 2)

**string IdentityName [key]**

The generated identity value for sysplex cluster. (Part 2 of 2)

**uint32 State** State of node:

- 1 Okay
- 2 Unknown
- 3 Error
- 4 Stopping

**uint32 SubState**

SubState of node:

- 1 Normal
- 2 StatusUpdateMissing
- 3 InActive
- 4 IPLing

Valid when State = Error. Not valid for all other system states.

**uint32 SystemSFMWeight**

Corresponds to System Weight attribute on SFM policy. Relative system weight used by clique algorithm following Sysplex connectivity failure

**uint32 SystemFDIInterval**

Corresponds to Failure Detection Interval attribute of SFM policy. Time interval during which missing status updates are tolerated. When failure interval is exceeded the SystemPartitionPolicy determines response

**uint32 SystemSFMAction**

Corresponds to Action attribute on SFM policy. One of four actions are settable in the SFM policy:

- 1 Prompt Operator
- 2 Isolate (isolate system using the CF fencing controls)
- 3 System Reset Partition
- 4 Deactivate Partition (deactivate the partition using the HMC controls)

**uint32 SystemSFMInterval**

When the System SFM Action is Automatic, System Reset, or Deactivate, this property will contain the time value in seconds corresponding to the SFM action.

**uint32 SystemMemStallTime**

For MEMSTALLTIME(stalltime), SFM will take action to resolve a sympathy sickness problem attributed to a stalled XCF group member if the problem persists for stalltime seconds.

**uint32 SystemOpNotify**

The length of time after a system is status update missing before SFM takes action. For PROMPT, the interval used is the XCF OPNOTIFY value.

## Methods

### uint32 SetSystemFDIInterval()

Sets the SFM failure detection interval (FDI) for the system.

## Associations

### IBMzOS\_HostedCFStrConnector

<b>Source</b>	IBMzOS_SysplexNode
<b>Target</b>	IBMzOS_CFStructureConnector
<b>see</b>	page 238

### IBMzOS\_UsesCFs

<b>Source</b>	IBMzOS_SysplexNode
<b>Target</b>	IBMzOS_CouplingFacility
<b>see</b>	page 239

## Indications

### IBMzOS\_SysplexNodeInstCreation

A 'life cycle' indication that indicates that an instance of the IBMzOS\_SysplexNode class has been created.

### IBMzOS\_SysplexNodeInstDeletion

A 'life cycle' indication that indicates that an instance of the IBMzOS\_SysplexNode class has been deleted.

### IBMzOS\_SysplexNodeInstModification

A 'life cycle' indication that indicates that an instance of the IBMzOS\_SysplexNode class has been modified.

## Association IBMzOS\_CFStrDependsOn

### Purpose

This class associates an IBMzOS\_CFStructure with an IBMzOS\_CFStructureConnector.

### Module name

The module name of the CMPI provider that is registered for a CIM class which is used by the cimprovider command line tool for the administration of CMPI providers is

IBMzOS\_CFStrDependsOnProviderModule

### Provider library

The physical name of a CMPI provider's shared object library as it is stored in the hierarchical file system is

libcmpiIBMzOS\_CFStrDependsOnProvider.so

### Indications

#### IBMzOS\_CFStrDependsOnInstCreation

A 'life cycle' indication that indicates that an instance of the IBMzOS\_CFStrDependsOn association class has been created.

#### IBMzOS\_CFStrDependsOnInstDeletion

A 'life cycle' indication that indicates that an instance of the IBMzOS\_CFStrDependsOn association class has been deleted.

## Association IBMzOS\_CollectionOfCFs

### Purpose

This class associates an IBMzOS\_Sysplex with an IBMzOS\_CouplingFacility.

### Module name

The module name of the CMPI provider that is registered for a CIM class which is used by the cimprovider command line tool for the administration of CMPI providers is

IBMzOS\_CollectionOfCFsProviderModule

### Provider library

The physical name of a CMPI provider's shared object library as it is stored in the hierarchical file system is

libcmpiIBMzOS\_CollectionOfCFsProvider.so

### Indications

#### IBMzOS\_CollectionOfCFsInstCreation

A 'life cycle' indication that indicates that an instance of the IBMzOS\_CollectionOfCFs association class has been created.

#### IBMzOS\_CollectionOfCFsInstDeletion

A 'life cycle' indication that indicates that an instance of the IBMzOS\_CollectionOfCFs association class has been deleted.

## Association IBMzOS\_CollectionOfSysplexNodes

### Purpose

This class associates an IBMzOS\_Sysplex with an IBMzOS\_SysplexNode.

**Module name**

The module name of the CMPI provider that is registered for a CIM class which is used by the cimprovider command line tool for the administration of CMPI providers is

IBMzOS\_CollectionOfSysplexNodesProviderModule

**Provider library**

The physical name of a CMPI provider's shared object library as it is stored in the hierarchical file system is

libcmpiIBMzOS\_CollectionOfSysplexNodesProvider.so

**Indications****IBMzOS\_CollectionOfSysplexNodesInstCreation**

A 'life cycle' indication that indicates that an instance of the IBMzOS\_CollectionOfSysplexNodes association class has been created.

**IBMzOS\_CollectionOfSysplexNodesInstDeletion**

A 'life cycle' indication that indicates that an instance of the IBMzOS\_CollectionOfSysplexNodes association class has been deleted.

**Association IBMzOS\_HostedCFStructure****Purpose**

This class associates an IBMzOS\_CFStructure with an IBMzOS\_CouplingFacility.

**Module name**

The module name of the CMPI provider that is registered for a CIM class which is used by the cimprovider command line tool for the administration of CMPI providers is

IBMzOS\_HostedCFStructureProviderModule

**Provider library**

The physical name of a CMPI provider's shared object library as it is stored in the hierarchical file system is

libcmpiIBMzOS\_HostedCFStructureProvider.so

**Indications****IBMzOS\_HostedCFStructureInstCreation**

A 'life cycle' indication that indicates that an instance of the IBMzOS\_HostedCFStructure association class has been created.

**IBMzOS\_HostedCFStructureInstDeletion**

A 'life cycle' indication that indicates that an instance of the IBMzOS\_HostedCFStructure association class has been deleted.

**Association IBMzOS\_HostedCFStrConnector****Purpose**

This class associates an IBMzOS\_SysplexNode with an IBMzOS\_CFStructureConnector.

### **Module name**

The module name of the CMPI provider that is registered for a CIM class which is used by the cimprovider command line tool for the administration of CMPI providers is

IBMzOS\_HostedCFStrConnectorProviderModule

### **Provider library**

The physical name of a CMPI provider's shared object library as it is stored in the hierarchical file system is

libcmpiIBMzOS\_HostedCFStrConnectorProvider.so

### **Indications**

#### **IBMzOS\_HostedCFStrConnectorInstCreation**

A 'life cycle' indication that indicates that an instance of the IBMzOS\_HostedCFStrConnector association class has been created.

#### **IBMzOS\_HostedCFStrConnectorInstDeletion**

A 'life cycle' indication that indicates that an instance of the IBMzOS\_HostedCFStrConnector association class has been deleted.

## **Association IBMzOS\_UsesCFs**

### **Purpose**

This class associates an IBMzOS\_SysplexNode with an IBMzOS\_CouplingFacility.

### **Module name**

The module name of the CMPI provider that is registered for a CIM class which is used by the cimprovider command line tool for the administration of CMPI providers is

IBMzOS\_UsesCFsProviderModule

### **Provider library**

The physical name of a CMPI provider's shared object library as it is stored in the hierarchical file system is

libcmpiIBMzOS\_UsesCFsProvider.so

### **Indications**

#### **IBMzOS\_UsesCFsInstCreation**

A 'life cycle' indication that indicates that an instance of the IBMzOS\_UsesCFs association class has been created.

#### **IBMzOS\_UsesCFsInstDeletion**

A 'life cycle' indication that indicates that an instance of the IBMzOS\_UsesCFs association class has been deleted.

## **Association IBMzOS\_UsesCFRMCoupleDatasets**

### **Purpose**

This class associates an instance of IBMzOS\_CouplingFunction with instances of IBMzOS\_CFRMCoupleDataset classes.

### **Module name**

The module name of the CMPI provider that is registered for a CIM class which is used by the cimprovider command line tool for the administration of CMPI providers is

IBMzOS\_UsesCFRMCoupleDatasetsProviderModule

**Provider library**

The physical name of a CMPI provider's shared object library as it is stored in the hierarchical file system is

libcmpiIBMzOS\_UsesCFRMCoupleDatasetsProvider.so

## Association IBMzOS\_UsesCFRMPolicies

**Purpose**

This class associates an instance of the IBMzOS\_CFRMCoupleDataset class with instances of the IBMzOS\_CFRMPolicy classes.

**Module name**

The module name of the CMPI provider that is registered for a CIM class which is used by the cimprovider command line tool for the administration of CMPI providers is

IBMzOS\_UsesCFRMPoliciesProviderModule

**Provider library**

The physical name of a CMPI provider's shared object library as it is stored in the hierarchical file system is

libcmpiIBMzOS\_UsesCFRMPoliciesProvider.so

## Association IBMzOS\_UsesCouplingFunctions

**Purpose**

This class associates an instance of the IBMzOS\_Sysplex class with instances of the IBMzOS\_CouplingFunction classes.

## Association IBMzOS\_UsesSysplexCoupleDatasets

**Purpose**

This class associates an instance of the IBMzOS\_CouplingFunction class with instances of the IBMzOS\_SysplexCoupleDataset classes.

**Module name**

The module name of the CMPI provider that is registered for a CIM class which is used by the cimprovider command line tool for the administration of CMPI providers is

IBMzOS\_UsesSysplexCoupleDatasetsProviderModule

**Provider library**

The physical name of a CMPI provider's shared object library as it is stored in the hierarchical file system is

libcmpiIBMzOS\_UsesSysplexCoupleDatasetsProvider.so



---

## Storage management classes

### CIM\_FCPort

#### Purpose

This class represents capabilities and management of a Fiber Channel Port device.

#### Inheritance

The z/OS specific subclass is IBMzOS\_FCSPort (see “IBMzOS\_FCSPort” on page 257).

### CIM\_FCPortStatistics

#### Inheritance

The z/OS specific subclass is IBMzOS\_FCPortStatistics (see “IBMzOS\_FCPortStatistics” on page 255).

### CIM\_PortController

#### Inheritance

The z/OS specific subclass is IBMzOS\_PortController (see “IBMzOS\_PortController” on page 258).

### CIM\_Product

#### Inheritance

The z/OS specific subclass is IBMzOS\_Product (see “IBMzOS\_Product” on page 260).

### CIM\_ProtocolEndpoint

#### Inheritance

The z/OS specific subclass is IBMzOS\_SBProtocolEndpoint (see “IBMzOS\_SBProtocolEndpoint” on page 261).

### CIM\_SoftwareIdentity

#### Inheritance

The z/OS specific subclass is IBMzOS\_SoftwareIdentity (see “IBMzOS\_SoftwareIdentity” on page 263).

### CIM\_StorageExtent

#### Inheritance

CIM\_StorageExtent is supported as a superclass of IBMzOS\_LogicalDisk (see “IBMzOS\_LogicalDisk” on page 153) and won't have a separate implementation.

- CIM\_ManagedElement
- ← CIM\_ManagedSystemElement
- ← CIM\_LogicalElement
- ← CIM\_EnabledLogicalElement
- ← CIM\_LogicalDevice
- ← CIM\_StorageExtent

## Used by the following CIM profiles

- Host Discovered Resources Profile

## Association CIM\_ControlledBy

### Purpose

The CIM\_ControlledBy relationship indicates which devices such as IBMzOS\_FCPort are controlled by a CIM\_Controller such as IBMzOS\_PortController on z/OS.

### Inheritance

The z/OS specific subclass is IBMzOS\_ControlledBy (see “Association IBMzOS\_ControlledBy” on page 266).

## Association CIM\_DeviceSAPImplementation

### Inheritance

The z/OS specific subclass is IBMzOS\_SBDeviceSAPImplementation (see “Association IBMzOS\_SBDeviceSAPImplementation” on page 273).

## Association CIM\_ElementSoftwareIdentity

### Inheritance

The z/OS specific subclass is IBMzOS\_ElementSoftwareIdentity (see “Association IBMzOS\_ElementSoftwareIdentity” on page 269).

## Association CIM\_ElementStatisticalData

### Inheritance

The z/OS specific subclass is IBMzOS\_FCPortStatisticalData (see “Association IBMzOS\_FCPortStatisticalData” on page 270).

## Association CIM\_HostedAccessPoint

### Inheritance

The z/OS specific subclass is IBMzOS\_SBHostedAccessPoint (see “Association IBMzOS\_SBHostedAccessPoint” on page 274).

## Association CIM\_InitiatorTargetLogicalUnitPath

### Inheritance

The z/OS specific subclass is IBMzOS\_SBInitiatorTargetLogicalUnitPath (see “Association IBMzOS\_SBInitiatorTargetLogicalUnitPath” on page 275).

## Association CIM\_InstalledSoftwareIdentity

### Inheritance

The z/OS specific subclass is IBMzOS\_InstalledSoftwareIdentity (see “Association IBMzOS\_InstalledSoftwareIdentity” on page 271).

## Association CIM\_ProductElementComponent

### Inheritance

The z/OS specific subclass is IBMzOS\_ProductElementComponent (see “Association IBMzOS\_ProductElementComponent” on page 272).

## Association CIM\_SystemDevice

### Inheritance

The z/OS specific subclasses are

- IBMzOS\_CSFCPort (see “Association IBMzOS\_CSFCPort” on page 267) and
- IBMzOS\_CSFCPortController (see “Association IBMzOS\_CSFCPortController” on page 268).

## IBMzOS\_FCCUPort

### Purpose

The IBMzOS\_FCCUPort class represents FICON Control Unit ports attached to the z/OS system.

### Inheritance

- CIM\_ManagedElement
- ← CIM\_ManagedSystemElement
- ← CIM\_LogicalElement
- ← CIM\_EnabledLogicalElement
- ← CIM\_LogicalDevice
- ← CIM\_LogicalPort
- ← CIM\_NetworkPort
- ← CIM\_FCPort
- ← IBMzOS\_FCSBPort
- ← IBMzOS\_FCCUPort

### Module name

The module name of the CMPI provider that is registered for a CIM class which is used by the cimprovider command line tool for the administration of CMPI providers is

IBMzOS\_FCCUPortProviderModule

### Provider library

The physical name of a CMPI provider's shared object library as it is stored in the hierarchical file system is

libcmplibIBMzOS\_FCCUPortProvider.so

### Properties

#### string Caption

Returns IBM z/OS FICON Control Unit Port.

#### string Description

Returns IBM z/OS FICON Control Unit Port.

#### string ElementName

Returns the same value as NodeDescriptor.

#### string Name

Returns the same value as NodeDescriptor.

#### uint16 OperationalStatus [ ]

The first array element ([0]) returns

0 unknown

#### uint16 EnabledState

Returns

0 unknown

#### uint16 RequestedState

Returns

11 not applicable

#### uint16 EnabledDefault

Returns

3 not applicable

**string SystemCreationClassName [key]**  
Returns IBMzOS\_ComputerSystem.

**string SystemName [key]**  
Displays the fully qualified host name of the system.

**string CreationClassName [key]**  
Indicates the name of the class or the subclass used in the creation of an instance.  
Returns IBMzOS\_FCCUPort.

**string DeviceID [key]**  
Returns a unique name for the logical device.

**uint16 PortNumber**  
Returns the interface ID of the control unit port.

**uint16 UsageRestriction**  
Returns  
2 front-end-only

**uint16 PortType**  
Specifies the specific mode currently enabled for the port.  
Returns  
10 N-Port

**uint16 LinkTechnology**  
Specifies the type of link.  
Returns  
4 FC

**string PermanentAddress**  
Defines the network address of the port.  
Returns  
*WWPN* if a network address is available  
NULL else

**uint16 SupportedCOS []**  
Indicates the Fibre Channel Class of Service that is supported.  
The first array element ([0]) returns 3.

**uint16 ActiveCOS []**  
Indicates the Fibre Channel Class of Service that is active.  
The first array element ([0]) returns 3.

**uint16 SupportedFC4Types []**  
Indicates the supported Fibre Channel FC-4 protocol.  
The first array element ([0]) returns  
27 FC-SB-x channel

**uint16 ActiveFC4Types []**  
Indicates the currently running Fibre Channel FC-4 protocol.  
The first array element ([0]) returns  
27 FC-SB-x channel

**NodeDescriptor**  
Indicates the node descriptor of the control unit port in the format:  
*type.model.manufacturer.plant.sequenceNumber.tag*

Example: 002107.900.IBM.75.0000000CF811.0230

## Methods

### **uint32 AssignWWN()**

Assigns a world wide name to the port, if no WWPN is present in the PermanentAddress property.

**Note:** After IPL the assignment is lost.

#### **Parameters:**

##### **uint64 wwn**

The world wide name to be assigned to the port in decimal number format.

#### **Return values:**

- 0 Completed without error.
- 1 The WWN could not be assigned because the logical device already has a fixed WWPN, discovered from the hardware.
- 2 The logical device already has the same WWPN bound to it.
- 3 Unexpected error.

#### **Exceptions:**

##### **CIM\_ERR\_NOT\_FOUND**

The switch port pointed to by the object path does not exist.

##### **CIM\_ERR\_ACCESS\_DENIED**

The caller is not authorized for this function. (You require UPDATE access to profile IOSPORTS CL(FACILITY).)

##### **CIM\_ERR\_INVALID\_PARAMETER**

The specified WWN is invalid.

##### **CIM\_ERR\_NOT\_SUPPORTED**

The requested operation is not supported by the underlying Operating System.

##### **CIM\_ERR\_FAILED**

General Error, for details see status description message.

### **uint32 Decommission()**

Takes all channels or devices attached to the port offline.

The system will not take a device offline if it would remove the last path to an online device. Exceptions will be made if the Force parameter is set to true.

#### **Parameters:**

##### **boolean Force**

Specifies whether or not the last path to a used device is to be removed.

The default is false: The system will not remove the last path to a device.

If set to true, the system takes all channel paths for the specified port offline, even if it is the last path to a device or if there were any other reason that affects the systems ability to communicate with a device over this path.

In any case, the system will not remove the last path to a device that has any of the following attributes: "Allocated", "In use by the system", "A Console", "Assigned to JES3".

**string EmbeddedInstance("CIM\_Message") messages[]**

If available, the CIM\_Message instances contain IOS messages with additional information.

**Return values:**

**0 (Confirmed)**

The port was taken offline.

**1 (Denied other)**

The port cannot be taken offline for an unspecified reason. Not all devices could be taken offline due to other reasons. All eligible devices were taken offline.

**2 (Denied In Use)**

The port cannot be taken offline because it is still in use. Not all devices could be taken offline due to last path – in use. All eligible devices were taken offline.

**3 (Denied last Path)**

The port cannot be taken offline because it is the last path to a device. Not all devices could be taken offline due to last path. All eligible devices were taken offline.

**Exceptions:**

**CIM\_ERR\_NOT\_FOUND**

The port pointed does not exist

**CIM\_ERR\_ACCESS\_DENIED**

The caller is not authorized for this function. (You require UPDATE access to profile IOSPORTS CL(FACILITY).)

**CIM\_ERR\_NOT\_SUPPORTED**

The requested operation is not supported by the underlying Operating System.

**CIM\_ERR\_FAILED**

General error, for details see the status description message.

**uint32 Recommission()**

Brings all channels or devices attached to the port that were online before they had previously been decommissioned back online.

**Parameters:**

**string EmbeddedInstance("CIM\_Message") messages[]**

Returns one or more messages describing the effect that the recommissioning had on the attached devices.

**Return values:**

**0 (OK)**

The port and all associated paths were successfully brought online.

**1 (Other)**

The port cannot be taken online for an unspecified reason. See the messages output parameter for details.

**2 (Denied)**

The port is not in state decommissioned and therefore cannot be recommissioned.

**Exceptions:****CIM\_ERR\_NOT\_FOUND**

The port does not exist

**CIM\_ERR\_ACCESS\_DENIED**

The caller is not authorized for this function. (You require UPDATE access to profile IOSPORTS CL(FACILITY).)

**CIM\_ERR\_NOT\_SUPPORTED**

The requested operation is not supported by the underlying Operating System.

**CIM\_ERR\_FAILED**

General error, for details see the status description message.

**Associations****IBMzOS\_CSFCPort**

<b>Source</b>	IBMzOS_ComputerSystem
<b>Target</b>	IBMzOS_FCCUPort
<b>see</b>	page 267



## IBMzOS\_FCPort

### Purpose

The IBMzOS\_FCPort class defines the capabilities and management of a Fiber Channel Port device on z/OS.

### Inheritance

CIM\_ManagedElement  
← CIM\_ManagedSystemElement  
← CIM\_LogicalElement  
← CIM\_EnabledLogicalElement  
← CIM\_LogicalDevice  
← CIM\_LogicalPort  
← CIM\_NetworkPort  
← CIM\_FCPort  
← IBMzOS\_FCSBPort  
← IBMzOS\_FCPort

### Module name

The module name of the CMPI provider that is registered for a CIM class which is used by the cimprovider command line tool for the administration of CMPI providers is

IBMzOS\_FCPortProviderModule

### Provider library

The physical name of a CMPI provider's shared object library as it is stored in the hierarchical file system is

libcmpiIBMzOS\_FCPortProvider.so

### Used by the following CIM profiles

- Storage HBA profile

### Properties

#### string Caption

Returns IBM z/OS FCPort.

#### string Description

Returns This is a z/OS FCPort.

#### string ElementName

Returns *LPARName:CSSID:CHPID*, where

*LPARName*

is the name of the logical partition - empty if z/OS does not run in an LPAR

*CSSID* is the channel subsystem ID

*CHPID* is the channel path ID

#### string Name

Returns *LPARName:CSSID:CHPID*, where

*LPARName*

is the name of the logical partition - empty if z/OS does not run in an LPAR

*CSSID* is the channel subsystem ID

*CHPID* is the channel path ID

**uint16 OperationalStatus [ ]**

Returns the current status of the FCPort:

2 OK  
11 Stopped

**string StatusDescriptions []**

If the port was decommissioned by the Decommission() method and the OperationalStatus is set to 11 (Stopped), the first array element ([0]) returns DECOMMISSIONED.

**uint16 EnabledState**

Returns

2 enabled

**uint16 RequestedState**

Returns

2 enabled

**uint16 EnabledDefault**

Indicates the administrator's default or startup configuration for the enabled state of an element. Always returns

2 enabled

**string SystemCreationClassName [key]**

Indicates the system's CreationClassName.

Returns IBMzOS\_ComputerSystem.

**string SystemName [key]**

Displays the fully qualified host name of the system.

**string CreationClassName [key]**

Indicates the name of the class or the subclass used in the creation of an instance.

Returns IBMzOS\_FCPort.

**string DeviceID [key]**

Displays the decimal CHPID as a unique ID for the logical device.

**uint16 PortNumber**

Returns the logical port number (CHPID).

**uint64 Speed** Returns the bandwidth of the port in bits per second - 0 if z/OS does not run in an LPAR

**uint64 MaxSpeed**

Returns the maximum bandwidth of the port in bits per second - 0 if z/OS does not run in an LPAR

**uint16 UsageRestriction**

Returns

4 not restricted

**uint16 PortType**

Specifies the specific mode currently enabled for the port.

Returns

10 N-Port

**uint16 LinkTechnology**

Specifies the type of link.

Returns  
4 FC

**string PermanentAddress**

Defines the network address of the port.

Returns  
*WWPN* if a network address is available  
NULL else

**uint64 SupportedMaximumTransmissionUnit**

Specifies the maximum transmission unit (MTU) that can be supported.

Returns 8192.

**uint64 ActiveMaximumTransmissionUnit**

Specifies the active or negotiated maximum transmission unit (MTU) that can be supported.

Returns 8192.

**uint16 SupportedCOS []**

Indicates the Fibre Channel Class of Service that is supported.

Returns 3.

**uint16 ActiveCOS []**

Indicates the Fibre Channel Class of Service that is active.

Returns 3.

**uint16 SupportedFC4Types []**

Indicates the supported Fibre Channel FC-4 protocol.

Returns  
27 FC-SB-x channel

**uint16 ActiveFC4Types []**

Indicates the currently running Fibre Channel FC-4 protocol.

Returns  
27 FC-SB-x channel

**string NodeDescriptor**

Indicates the node element description of the FICON port in the format:

*type.model.manufacturer.plant.sequenceNumber.tag*

Example: 002097.E40.IBM.51.000000070B82.9031

## Methods

**uint32 AssignWWN()**

Assigns a world wide name to the port, if no WWPN is present in the PermanentAddress property.

**Note:** After IPL the assignment is lost.

**Parameters:**

**uint64 wwn**

The World Wide Name to be assigned to the port in decimal number format.

**Return values:**

- 0 Completed without error.
- 1 The WWN could not be assigned because the logical device already has a fixed WWPNN, discovered from the hardware.
- 2 The logical device already has the same WWPNN bound to it.
- 3 Unexpected error.

**Exceptions:**

**CIM\_ERR\_NOT\_FOUND**

The switch port pointed to by the object path does not exist.

**CIM\_ERR\_ACCESS\_DENIED**

The caller is not authorized for this function. (You require UPDATE access to profile IOSPORTS CL(FACILITY).)

**CIM\_ERR\_INVALID\_PARAMETER**

The specified WWN is invalid.

**CIM\_ERR\_NOT\_SUPPORTED**

The requested operation is not supported by the underlying Operating System.

**CIM\_ERR\_FAILED**

General Error, for details see status description message.

**uint32 Decommission()**

Takes all channels or devices attached to the port offline.

The system will reject this command if it would remove the last path to an online device. Exceptions will be made if the Force parameter is set to true.

**Parameters:**

**boolean Force**

Specifies whether or not the last path to a used device is to be removed.

The default is false: The system will not remove the last path to a device.

If set to true, the system takes all channel paths for the specified port offline, even if it is the last path to a device or if there were any other reason that affects the systems ability to communicate with a device over this path.

In any case, the system will not remove the last path to a device that has any of the following attributes: "Allocated", "In use by a system function", "A TP device", "The only active console in the system".

**string EmbeddedInstance("CIM\_Message") messages[]**

If available, the CIM\_Message instances contain IOS messages with additional information.

**Return values:**

**0 (Confirmed)**

The port was taken offline.

### 1 (Denied other)

The port cannot be taken offline for an unspecified reason. Not all devices could be taken offline due to other reasons. The request was rejected.

### 2 (Denied In Use)

The port cannot be taken offline because it is still in use. Not all devices could be taken offline due to last path – in use. The request was rejected.

### 3 (Denied last Path)

The port cannot be taken offline because it is the last path to a device. Not all devices could be taken offline due to last path. The request was rejected.

#### Exceptions:

##### CIM\_ERR\_NOT\_FOUND

The port pointed does not exist

##### CIM\_ERR\_ACCESS\_DENIED

The caller is not authorized for this function. (You require UPDATE access to profile IOSPORTS CL(FACILITY).)

##### CIM\_ERR\_NOT\_SUPPORTED

The requested operation is not supported by the underlying Operating System.

##### CIM\_ERR\_FAILED

General error, for details see the status description message.

### uint32 Recommission()

Brings all channels or devices attached to the port that were online before they had previously been decommissioned back online.

#### Parameters:

##### string EmbeddedInstance("CIM\_Message") messages[]

Returns one or more messages describing the effect that the recommissioning had on the attached devices.

#### Return values:

### 0 (OK)

The port and all associated paths were successfully brought online.

### 1 (Other)

The port cannot be taken online for an unspecified reason. See the messages output parameter for details.

### 2 (Denied)

The port is not in state decommissioned and therefore cannot be recommissioned.

#### Exceptions:

##### CIM\_ERR\_NOT\_FOUND

The port does not exist.

##### CIM\_ERR\_ACCESS\_DENIED

The caller is not authorized for this function. (You require UPDATE access to profile IOSPORTS CL(FACILITY).)

### **CIM\_ERR\_NOT\_SUPPORTED**

The requested operation is not supported by the underlying Operating System.

### **CIM\_ERR\_FAILED**

General error, for details see the status description message.

## **Associations**

### **IBMzOS\_FCPortStatisticalData**

#### **ManagedElement**

IBMzOS\_FCPort

**Stats** IBMzOS\_FCPortStatistics

**see** page 270

### **IBMzOS\_ControlledBy**

**Source** IBMzOS\_PortController

**Target** IBMzOS\_FCPort

**see** page 266

### **IBMzOS\_SBDeviceSAPImplementation**

**Source** IBMzOS\_FCPort

**Target** IBMzOS\_SBProtocolEndpoint

**see** page 273

### **IBMzOS\_CSFCPort**

**Source** IBMzOS\_ComputerSystem

**Target** IBMzOS\_FCPort

**see** page 267

## IBMzOS\_FCPortStatistics

### Purpose

The IBMzOS\_FCPort class defines the statistics for the FCPort on z/OS.

### Inheritance

CIM\_ManagedElement  
← CIM\_StatisticalData  
← CIM\_NetworkPortStatistics  
← CIM\_FCPortStatistics  
← IBMzOS\_FCPortStatistics

### Module name

The module name of the CMPI provider that is registered for a CIM class which is used by the cimprovider command line tool for the administration of CMPI providers is

IBMzOS\_FCPortStatisticsProviderModule

### Provider library

The physical name of a CMPI provider's shared object library as it is stored in the hierarchical file system is

libcmpiIBMzOS\_FCPortStatisticsProvider.so

### Used by the following CIM profiles

- Storage HBA profile

### Properties

#### string Caption

Returns IBM z/OS FCPortStatistics.

#### string Description

Returns This is a z/OS FCPortStatistics.

#### string InstanceID

Returns

**IBM:FCPortStat:CHPID**

where

*CHPID*

is the Channel Path ID

#### string ElementName

Returns FCPortStat:*LPARName*:*CSSID*:*CHPID*, where

*LPARName*

is the name of the logical partition - empty if z/OS does not run in an LPAR

*CSSID* is the channel subsystem ID

*CHPID* is the channel path ID

#### uint64 BytesTransmitted

Returns the total number of bytes that are transmitted, including framing characters - 0 if z/OS does not run in an LPAR

#### uint64 BytesReceived

Returns the total number of bytes that are received, including framing characters - 0 if z/OS does not run in an LPAR

**uint64 PacketsTransmitted**

Returns the total number of packets that are transmitted - 0 if z/OS does not run in an LPAR

**uint64 PacketsReceived**

Returns the total number of packets that are received - 0 if z/OS does not run in an LPAR

**Associations****IBMzOS\_FCPortStatisticalData****ManagedElement**

IBMzOS\_FCPort

**Stats**

IBMzOS\_FCPortStatistics

**see**

page 270



## IBMzOS\_FCSBPort

### Purpose

The IBMzOS\_FCSBPort class defines the capabilities and management of Channel Ports and Control Unit Ports on z/OS. For implementations, see the subclasses “IBMzOS\_FCCUPort” on page 244 and “IBMzOS\_FCPort” on page 249.

### Inheritance

- CIM\_ManagedElement
- ← CIM\_ManagedSystemElement
- ← CIM\_LogicalElement
- ← CIM\_EnabledLogicalElement
- ← CIM\_LogicalDevice
- ← CIM\_LogicalPort
- ← CIM\_NetworkPort
- ← CIM\_FCPort
- ← IBMzOS\_FCSBPort

# IBMzOS\_PortController

## Purpose

The IBMzOS\_PortController class represents a logical device corresponding to a hardware network port controller on z/OS. Port controllers provide various features depending on their types and versions. Since it is not possible from inband z/OS instrumentation to distinguish between Ports and PortControllers, the PortController provider returns one instance for each FCPort, using the same key information.

## Inheritance

- CIM\_ManagedElement
- ← CIM\_ManagedSystemElement
- ← CIM\_LogicalElement
- ← CIM\_EnabledLogicalElement
- ← CIM\_LogicalDevice
- ← CIM\_Controller
- ← CIM\_PortController
- ← IBMzOS\_PortController

## Module name

The module names of the CMPI providers that are registered for a CIM class which are used by the cimprovider command line tool for the administration of CMPI providers are

- IBMzOS\_PortControllerProviderModule
- IBMzOS\_PortControllerIndicationProviderModule

## Provider library

The physical names of a CMPI provider's shared object library stored in the hierarchical file system are

- libcmpiIBMzOS\_PortControllerProvider.so
- libcmpiIBMzOS\_PortControllerIndicationProvider.so

## Used by the following CIM profiles

- Storage HBA profile

## Properties

### string Caption

Returns IBM z/OS PortController.

### string Description

Returns This is a z/OS PortController.

### uint16 OperationalStatus []

Returns  
2 OK

### uint16 EnabledState

Returns  
2 enabled

### uint16 RequestedState

Returns  
2 enabled

**uint16 EnabledDefault**

Indicates the administrator's default or startup configuration for the enabled state of an element.

Returns

2      enabled

**string SystemCreationClassName**

Returns IBMzOS\_ComputerSystem.

**string SystemName**

Displays the fully qualified host name of the system.

**string CreationClassName**

Returns IBMzOS\_PortController.

**string DeviceID**

Displays the CHPID as a unique ID for the logical device.

**uint16 ControllerType**

Returns

4      FC

**Associations****IBMzOS\_ControlledBy**

**Source**      IBMzOS\_PortController

**Target**      IBMzOS\_FCPort

**see**          page 266

**IBMzOS\_ElementSoftwareIdentity**

**Source**      IBMzOS\_SoftwareIdentity

**Target**      IBMzOS\_PortController

**see**          page 269

**Indications****CIM\_InstCreation**

A life cycle indication that indicates that an instance of the IBMzOS\_PortController class has been created.

**CIM\_IndicationFilter query string:**

```
"SELECT * FROM CIM_InstCreation
WHERE SourceInstance ISA CIM_PortController"
```

**CIM\_InstDeletion**

A life cycle indication that indicates that an instance of the IBMzOS\_PortController class has been deleted.

**CIM\_IndicationFilter query string:**

```
"SELECT * FROM CIM_InstDeletion
WHERE SourceInstance ISA CIM_PortController"
```

For more information on how to subscribe to an indication, see "CIM subscription mechanism" on page 305. Specify your queries using the CIM\_IndicationFilter query string (see also "CIM\_IndicationFilter" on page 306).

## IBMzOS\_Product

### Purpose

The IBMzOS\_Product is a concrete class that aggregates PhysicalElements, software (SoftwareIdentity and SoftwareFeatures), services or other products on z/OS.

For z/OS 1.12, an instance of IBMzOS\_Product is created for each FCPort returned by the IBMzOS\_FCPort provider.

### Inheritance

CIM\_ManagedElement  
← CIM\_Product  
← IBMzOS\_Product

### Module name

The module name of the CMPI provider that is registered for a CIM class which is used by the cimprovider command line tool for the administration of CMPI providers is

IBMzOS\_ProductProviderModule

### Provider library

The physical name of a CMPI provider's shared object library as it is stored in the hierarchical file system is

libcmpiIBMzOS\_ProductProvider.so

### Used by the following CIM profiles

- Storage HBA profile

### Properties

#### string Caption

Returns IBM z/OS Product.

#### string Description

Returns Represents a z/OS FCPortController Product.

**string Name** Returns the DeviceID from IBMzOS\_FCPort.

#### string ElementName

Returns the DeviceID from IBMzOS\_FCPort.

#### string IdentifyingNumber

Returns the DeviceID from IBMzOS\_FCPort.

**string Vendor** Returns IBM.

**string Version** Returns unknown.

## IBMzOS\_SBProtocolEndpoint

### Purpose

The IBMzOS\_SBProtocolEndpoint class is used to represent two different entities, Initiator and Target. The Initiator entity describes the protocol endpoint on the computer system side, the target entity describes the protocol endpoint on the disk controller side of a logical disk attached to a computer system.

Protocol endpoints are identified via World Wide Port Numbers (WWPN), which are used as the primary key for the instances of the class IBMzOS\_SBProtocolEndpoint, reflected in the name property. For the retrieval of WWPN the IOS services IOSCDR and IOSCHPD have been extended for z/OS 2.1 to facilitate the retrieval of WWPN for the Initiator (IOSCHPD) and Target (IOSCDR) protocol endpoints. Therefore, the retrieval of WWPN through IOSCDR is only possible under the following conditions:

1. The used hardware is at least an IBM System z10™.
2. The requestor or CIM client has UPDATE access to the IOSCDR profile.

### Inheritance

CIM\_ManagedElement  
← CIM\_ManagedSystemElement  
← CIM\_LogicalElement  
← CIM\_EnabledLogicalElement  
← CIM\_ServiceAccessPoint  
← CIM\_ProtocolEndpoint  
← IBMzOS\_SBProtocolEndpoint

### Module name

The module name of the CMPI provider that is registered for a CIM class which is used by the cimprovider command line tool for the administration of CMPI providers is

IBMzOS\_SBProtocolEndpointProviderModule

### Provider library

The physical name of a CMPI provider's shared object library as it is stored in the hierarchical file system is

libcmpiIBMzOS\_SBProtocolEndpointProvider.so

### Used by the following CIM profiles

- Host Discovered Resources Profile
- Storage HBA profile

### Properties

**string Caption**

Returns IBM z/OS SBProtocolEndpoint.

**string Description**

Returns This is a z/OS SBProtocolEndpoint.

**string Name**

The *Initiator* returns the WWPN of the computer system side.

The *Target* returns the WWPN of the storage controller side.

**uint16 OperationalStatus []**

Returns

2 OK

**uint16 EnabledState**  
Returns  
2 Enabled

**uint16 RequestedState**  
Returns  
2 Enabled

**uint16 EnabledDefault**  
Returns  
2 Enabled

**string SystemCreationClassName**  
Returns IBMzOS\_ComputerSystem

**string SystemName**  
Displays the name of the host system.

**string CreationClassName**  
Returns IBMzOS\_SBProtocolEndpoint

**uint16 ProtocolIFType**  
Returns  
56 Fibre Channel

**string OtherTypeDescription**  
Returns SB.

**uint16 ConnectionType**  
Returns  
2 Fibre Channel

**uint16 Role** Returns  
2 Initiator

or  
3 Target

## Associations

### IBMzOS\_SBHostedAccessPoint

**Source** IBMzOS\_ComputerSystem  
**Target** IBMzOS\_SBProtocolEndpoint (Initiator Instance)  
**see** page 274

### IBMzOS\_SBDeviceSAPImplementation

**Source** IBMzOS\_FCPort  
**Target** IBMzOS\_SBProtocolEndpoint  
**see** page 273

### IBMzOS\_SBInitiatorTargetLogicalUnitPath

**Initiator** IBMzOS\_SBProtocolEndpoint (Initiator Instance)  
**Target** IBMzOS\_SBProtocolEndpoint (Target instance)  
**LogicalUnit** IBMzOS\_LogicalDisk  
**see** page 275

## IBMzOS\_SoftwareIdentity

### Purpose

The IBMzOS\_SoftwareIdentity class provides descriptive information about a software component for asset tracking or installation dependency management.

The idea behind SoftwareIdentity as defined in the SMI-S Storage HBA profile does not match the concepts of z/OS. Therefore this class has only been implemented for formal compliance with the SMI-S Storage HBA profile.

For z/OS 1.12, therefore only one instance of IBMzOS\_SoftwareIdentity is created and associated to all PortControllers. .

### Inheritance

```
CIM_ManagedElement
  ← CIM_ManagedSystemElement
  ← CIM_LogicalElement
  ← CIM_SoftwareIdentity
  ← IBMzOS_SoftwareIdentity
```

### Module name

The module name of the CMPI provider that is registered for a CIM class which is used by the cimprovider command line tool for the administration of CMPI providers is

```
IBMzOS_SoftwareIdentityProviderModule
```

### Provider library

The physical name of a CMPI provider's shared object library as it is stored in the hierarchical file system is

```
libcmpiIBMzOS_SoftwareIdentityProvider.so
```

### Used by the following CIM profiles

- Storage HBA profile

### Properties

#### string Caption

Returns IBM z/OS SoftwareIdentity.

#### string Description

Returns The Software driving the IBMzOS\_PortController.

#### uint16 OperationalStatus []

Returns  
2      OK

#### string InstanceID

Uniquely identifies an instance of this class. Returns  
IBMzOS:CSSID:LPARID, where  
CSSID is the channel subsystem ID  
LPARID is the logical partition ID

#### string ElementName

Returns IBMzOS:CSSID:LPARID, where  
CSSID is the channel subsystem ID  
LPARID is the logical partition ID

**string VersionString**

Returns the z/OS Version and Release number in the form *Major.Minor.Revision*, where  
*Major* is the z/OS version  
*Minor* is the release  
*Revision*  
is the revision number

**string Manufacturer**

Returns IBM.

**uint16 Classifications []**

Returns

2 Driver

and

8 Operating System

**string TargetOperatingSystems []**

Returns z/OS.



## **Associations**

### **IBMzOS\_ElementSoftwareIdentity**

<b>Source</b>	IBMzOS_SoftwareIdentity
<b>Target</b>	IBMzOS_PortController
<b>see</b>	page 269

### **IBMzOS\_InstalledSoftwareIdentity**

<b>Source</b>	IBMzOS_ComputerSystem
<b>Target</b>	IBMzOS_SoftwareIdentity
<b>see</b>	page 271

## Association IBMzOS\_ControlledBy

### Inheritance

CIM\_Dependency  
← CIM\_DeviceConnection  
← CIM\_ControlledBy  
← IBMzOS\_ControlledBy

### Module name

The module name of the CMPI provider that is registered for a CIM class which is used by the cimprovider command line tool for the administration of CMPI providers is

IBMzOS\_ControlledByProviderModule

### Provider library

The physical name of a CMPI provider's shared object library as it is stored in the hierarchical file system is

libcmplibIBMzOS\_ControlledByProvider.so

### Used by the following CIM profiles

- Storage HBA profile

### Properties

#### Ref Antecedent

References an IBMzOS\_PortController

#### Ref Dependent

References an IBMzOS\_FCPort

#### Uint16 AccessState

Returns  
1 Active

#### String DeviceNumber

Returns the device number of the IBMzOS\_FCPort.

#### Uint16 AccessMode

Returns  
2 ReadWrite

## Association IBMzOS\_CSFCPort

### Inheritance

CIM\_Component  
← CIM\_SystemComponent  
← CIM\_SystemDevice  
← IBMzOS\_CSFCPort

### Module name

The module name of the CMPI provider that is registered for a CIM class which is used by the cimprovider command line tool for the administration of CMPI providers is

IBMzOS\_CSFCPortProviderModule

### Provider library

The physical name of a CMPI provider's shared object library as it is stored in the hierarchical file system is

libcmplibIBMzOS\_CSFCPortProvider.so

### Properties

#### Ref GroupComponent

References an IBMzOS\_ComputerSystem

#### Ref PartComponent

References an IBMzOS\_FCCUPort or an IBMzOS\_FCPort

## Association IBMzOS\_CSFCPortController

### Inheritance

- CIM\_Component
- ← CIM\_SystemDevice
- ← IBMzOS\_CSFCPortController

### Module name

The module name of the CMPI provider that is registered for a CIM class which is used by the cimprovider command line tool for the administration of CMPI providers is

IBMzOS\_CSFCPortControllerProviderModule

### Provider library

The physical name of a CMPI provider's shared object library as it is stored in the hierarchical file system is

libcmpiIBMzOS\_CSFCPortControllerProvider.so

### Properties

#### Ref GroupComponent

References an IBMzOS\_ComputerSystem

#### Ref PartComponent

References an IBMzOS\_PortController

## Association IBMzOS\_ElementSoftwareIdentity

### Purpose

The IBMzOS\_ElementSoftwareIdentity class allows a Managed Element such as an IBMzOS\_PortController to report its software related asset information (such as firmware, drivers, or configuration software) on z/OS.

### Inheritance

CIM\_Dependency  
← CIM\_ElementSoftwareIdentity  
← IBMzOS\_ElementSoftwareIdentity

### Used by the following CIM profiles

- Storage HBA profile

### Module name

The module name of the CMPI provider that is registered for a CIM class which is used by the cimprovider command line tool for the administration of CMPI providers is

IBMzOS\_ElementSoftwareIdentityProviderModule

### Provider library

The physical name of a CMPI provider's shared object library as it is stored in the hierarchical file system is

libcmpiIBMzOS\_ElementSoftwareIdentityProvider.so

### Properties

#### Ref Antecedent

References an IBMzOS\_SoftwareIdentity

#### Ref Dependent

References an IBMzOS\_PortController

## Association IBMzOS\_FCPortStatisticalData

### Purpose

This class associates an IBMzOS\_FCPort with IBMzOS\_FCPortStatistics.

### Inheritance

CIM\_ElementStatisticalData

← IBMzOS\_FCPortStatisticalData

### Module name

The module name of the CMPI provider that is registered for a CIM class which is used by the cimprovider command line tool for the administration of CMPI providers is

IBMzOS\_FCPortStatisticalDataProviderModule

### Provider library

The physical name of a CMPI provider's shared object library as it is stored in the hierarchical file system is

libcmplibIBMzOS\_FCPortStatisticalDataProvider.so

### Properties

#### Ref ManagedElement

References an IBMzOS\_FCPort

#### Ref Stats

References IBMzOS\_FCPortStatistics

## Association IBMzOS\_InstalledSoftwareIdentity

### Purpose

The IBMzOS\_InstalledSoftwareIdentity association identifies the Software installed on a system. On z/OS this class has only been implemented for formal compliance with the SMI-S Storage HBA profile and is of limited use.

### Inheritance

CIM\_InstalledSoftwareIdentity  
← IBMzOS\_InstalledSoftwareIdentity

### Used by the following CIM profiles

- Storage HBA profile

### Module name

The module name of the CMPI provider that is registered for a CIM class which is used by the cimprovider command line tool for the administration of CMPI providers is

IBMzOS\_InstalledSoftwareIdentityProviderModule

### Provider library

The physical name of a CMPI provider's shared object library as it is stored in the hierarchical file system is

libcmpiIBMzOS\_InstalledSoftwareIdentityProvider.so

### Properties

**Ref System**      References an IBMzOS\_ComputerSystem

**Ref InstalledSoftware**  
                    References an IBMzOS\_SoftwareIdentity

## Association IBMzOS\_ProductElementComponent

### Inheritance

CIM\_Component  
← CIM\_ProductElementComponent  
← IBMzOS\_ProductElementComponent

### Used by the following CIM profiles

- Storage HBA profile

### Module name

The module name of the CMPI provider that is registered for a CIM class which is used by the cimprovider command line tool for the administration of CMPI providers is

IBMzOS\_ProductElementComponentProviderModule

### Provider library

The physical name of a CMPI provider's shared object library as it is stored in the hierarchical file system is

libcmpiIBMzOS\_ProductElementComponentProvider.so

### Properties

#### Ref GroupComponent

References an IBMzOS\_Product

#### Ref PartComponent

References an IBMzOS\_PortController



## Association IBMzOS\_SBDeviceSAPImplementation

### Purpose

The IBMzOS\_SBDeviceSAPImplementation class describes an association between a ServiceAccessPoint (SAP) and how it is implemented.

### Inheritance

CIM\_Dependency  
← CIM\_DeviceSAPImplementation  
← IBMzOS\_SBDeviceSAPImplementation

### Module name

The module name of the CMPI provider that is registered for a CIM class which is used by the cimprovider command line tool for the administration of CMPI providers is

IBMzOS\_SBDeviceSAPImplementationProviderModule

### Provider library

The physical name of a CMPI provider's shared object library as it is stored in the hierarchical file system is

libcmpiIBMzOS\_SBDeviceSAPImplementationProvider.so

### Used by the following CIM profiles

- Storage HBA profile

### Properties

#### Ref Antecedent

References an IBMzOS\_FCPort

#### Ref Dependent

References an IBMzOS\_SBProtocolEndpoint

## Association IBMzOS\_SBHostedAccessPoint

### Purpose

The IBMzOS\_SBHostedAccessPoint class is an association between a Service Access Point and the System on which it is provided.

### Inheritance

CIM\_Dependency  
← CIM\_HostedDependency  
← CIM\_HostedAccessPoint  
← IBMzOS\_SBHostedAccessPoint

### Module name

The module name of the CMPI provider that is registered for a CIM class which is used by the cimprovider command line tool for the administration of CMPI providers is

IBMzOS\_SBHostedAccessPointProviderModule

### Provider library

The physical name of a CMPI provider's shared object library as it is stored in the hierarchical file system is

libcmpiIBMzOS\_SBHostedAccessPointProvider.so

### Used by the following CIM profiles

- Host Discovered Resources Profile
- Storage HBA profile

### Properties

#### Ref Antecedent

References an IBMzOS\_ComputerSystem

#### Ref Dependent

References an IBMzOS\_SBProtocolEndpoint (Initiator instance)

# Association IBMzOS\_SBInitiatorTargetLogicalUnitPath

## Purpose

The IBMzOS\_SBInitiatorTargetLogicalUnitPath class is a three way association between an z/OS disk device, identified by the LogicalUnit reference, the channel, identified by the Initiator reference and the control unit, identified by the Target reference. Each permutation of initiator and target ProtocolEndpoints and logical units is considered as a separate path.

Retrieving the data for IBMzOS\_SBInitiatorTargetLogicalUnitPath is only possible under the following conditions:

1. The used hardware is at least an IBM System z10.
2. The requestor or CIM client user ID has UPDATE access to the IOSCDR profile.

## Inheritance

CIM\_InitiatorTargetLogicalUnitPath  
← IBMzOS\_SBInitiatorTargetLogicalUnitPath

## Module name

The module name of the CMPI provider that is registered for a CIM class which is used by the cimprovider command line tool for the administration of CMPI providers is

IBMzOS\_SBInitiatorTargetLogicalUnitPathProviderModule

## Provider library

The physical name of a CMPI provider's shared object library as it is stored in the hierarchical file system is

libcmpiIBMzOS\_SBInitiatorTargetLogicalUnitPathProvider.so

## Used by the following CIM profiles

- Host Discovered Resources Profile
- Storage HBA profile

## Properties

**Ref Initiator** References an IBMzOS\_SBProtocolEndpoint (Initiator instance)

**Ref Target** References an IBMzOS\_SBProtocolEndpoint (Target instance)

**Ref LogicalUnit**  
References an IBMzOS\_LogicalDisk

**uint32 State** Returns the state of the path:

2	active
4	disabled
8	removed (boxed)
9	transitioning

## Indications

### CIM\_InstCreation

A life cycle indication that indicates that an instance of the IBMzOS\_SBInitiatorTargetLogicalUnitPath class has been created.

### CIM\_IndicationFilter query string:

```
"SELECT * FROM CIM_InstCreation  
WHERE SourceInstance ISA  
CIM_InitiatorTargetLogicalUnitPath"
```

### **CIM\_InstModification**

A life cycle indication that indicates a path state change of an instance of the IBMzOS\_SBInitiatorTargetLogicalUnitPath class.

#### **CIM\_IndicationFilter query string:**

```
"SELECT * FROM CIM_InstModification
WHERE SourceInstance ISA
CIM_InitiatorTargetLogicalUnitPath AND
SourceInstance.CIM_InitiatorTargetLogicalUnitPath::State
<>
PreviousInstance.CIM_InitiatorTargetLogicalUnitPath::State"
```

### **CIM\_InstDeletion**

A life cycle indication that indicates that an instance of the IBMzOS\_SBInitiatorTargetLogicalUnitPath class has been deleted.

#### **CIM\_IndicationFilter query string:**

```
"SELECT * FROM CIM_InstDeletion
WHERE SourceInstance ISA
CIM_InitiatorTargetLogicalUnitPath"
```

For more information on how to subscribe to an indication, see “CIM subscription mechanism” on page 305. Specify your queries using the CIM\_IndicationFilter query string (see also “CIM\_IndicationFilter” on page 306).

## Chapter 15. WLM classes

Figure 13 shows the relationship between the IBM extension classes, the IBM extension classes for WLM, and the CIM classes that they extend. The DMTF website provides a detailed description of the CIM classes. The z/OS-specific classes are described in detail in the following chapters.

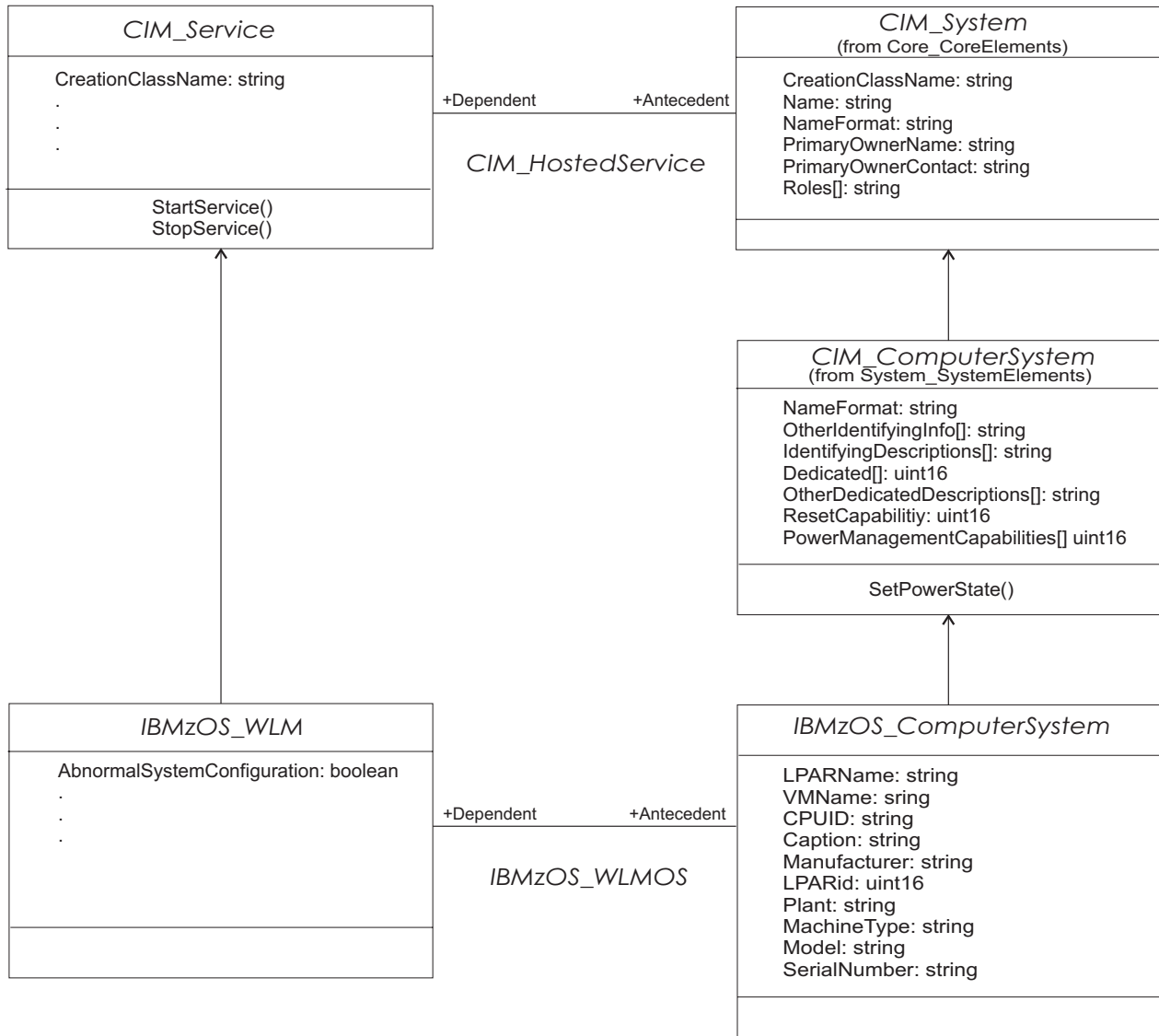

Figure 13. WLM classes

Figure 14 on page 278 shows a process indication that indicates that a service policy has been activated in the sysplex. This event occurs on each system in the sysplex.

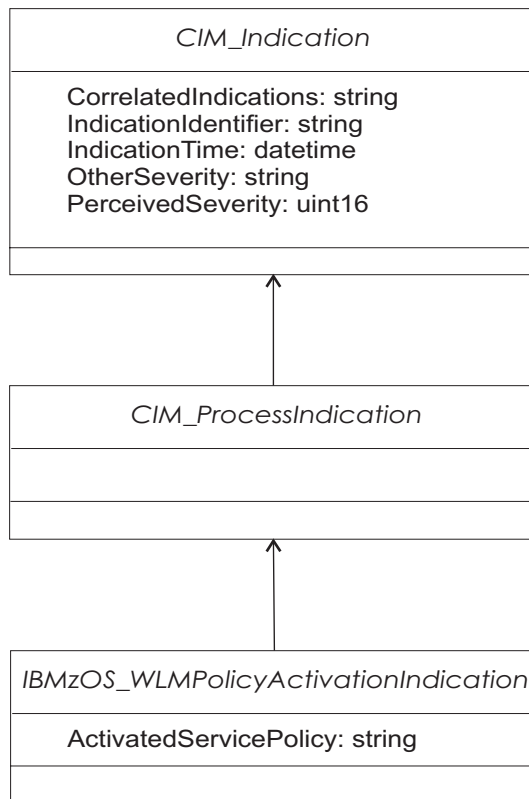

Figure 14. WLM indications

## IBMzOS\_WLM

### Purpose

This class represents the z/OS Workload Manager.

Before you can access this class, be sure that you have prepared the security steps as described in “Setting up the CIM server for WLM management” on page 40

- Grant the requestor's user ID READ access to the RACF facility class MVSADMIN.WLM.POLICY
- If your environment requires program control, be sure that library BLSUXTID in SYS1.MIGLIB is program controlled.

#### Example:

```

RDEFINE PROGRAM BLSUXTID
RALT PROGRAM BLSUXTID ADDMEM('SYS1.MIGLIB'/'*****'/NOPADCHK) +
UACC(READ)
SETROPTS WHEN(PROGRAM) REFRESH
  
```

### Inheritance

- CIM\_ManagedElement
- ← CIM\_ManagedSystemElement
- ← CIM\_LogicalElement

- ← CIM\_EnabledLogicalElement
- ← CIM\_Service
- ← IBMzOS\_WLM

## Module name

The module name of the CMPI provider that is registered for a CIM class which is used by the cimprovider command line tool for the administration of CMPI providers is

IBMzOS\_WLMProviderModule

## Provider library

The physical name of a CMPI provider's shared object library as it is stored in the hierarchical file system is

libwlmprovider.so

## Owning component

The z/OS component which owns the CMPI provider is

WLM

## Properties

### string Caption

A short description of the class

### string Description

A description of the class

### string ElementName

Name given to this instance of the class

### datetime InstallDate

Not supported

### uint16 OperationalStatus[]

The current status of WLM:

[2] [OK]

### string StatusDescriptions[]

Not supported

### string Status

Not supported

### uint16 HealthState

The health status of WLM:

5 OK

### uint16 EnabledState

Indicates the Enabled or Disabled state:

2 Enabled

### string OtherEnabledState

Not supported

### uint16 RequestedState

The last requested state:

2 Enabled

### uint16 EnabledDefault

Indicates the default value for Enabled State:

2 Enabled

**datetime TimeOfLastStateChange**

Not supported

**string SystemCreationClassName [key]**

The scoping system's CreationClassName

**string SystemName [key]**

The name of the scoping system

**string CreationClassName [key]**

Indicates the name of the class used in the creation of an instance

**string Name [key]**

Name of z/OS Workload Management service

**string PrimaryOwnerName**

Not supported

**string PrimaryOwnerContact**

Not supported

**boolean Started**

Indicates if z/OS WLM runs

**string ActiveServicePolicy**

Name of WLM service policy activated for the sysplex

**string PolicyDescription**

Description of the WLM service policy activated for the sysplex

**datetime PolicyActivationTimestamp**

The time the WLM service policy has been activated

**string PolicyActivationUser**

Userid that activated the WLM service policy

**string PolicyActivationSystem**

System from which the WLM service policy activation was triggered

**string RelatedServiceDefinition**

Name of the service definition the WLM service policy was activated from

**datetime ServiceDefinitionInstallationTimestamp**

Time the service definition was installed

**string ServiceDefinitionInstallationUser**

User that installed the service definition

**string ServiceDefinitionInstallationSystem**

System from which the service definition installation was triggered

**uint8 ServiceDefinitionFunctionalityLevel**

Functionality level of the service definition

**string EmbeddedEWLMPolicy**

Name of the EWLM policy embedded in the active WLM service policy

**datetime EWLMDMPolicyActivationTimestamp**

Time the EWLM Domain Manager has triggered the activation of the EWLM policy that is activated on this system



**datetime EWLMPolicyActivationTimestamp**  
Time the EWLM Managed Server has activated the EWLM policy that is activated on this system

**datetime EWLMManagementActivationTimestamp**  
Time when management towards EWLM goals has been activated on this system

**boolean PolicyActivationInProgress**  
Indicates whether a WLM policy activation is currently in progress

**boolean AbnormalSystemConfiguration**  
Indicates an abnormal system configuration

**string PolicyActivatingSystem**  
If a WLM policy activation is currently in progress, the name of the system where the policy activation was triggered

**uint8 WLMVersion**  
WLM version

**uint16 CDSFormat**  
WLM Couple Dataset format

**string SysplexMembersSystemName[]**  
Name of systems in sysplex

**uint8 SysplexMembersWLMMode[]**  
Workload management mode of systems in sysplex:  
 0 Undefined  
 1 Compatibility Mode  
 2 Goal Mode  
 3 EWLM Mode

**uint8 SysplexMembersWLMStatus[]**  
Workload management status of systems in sysplex:  
 0 Undefined  
 1 Initializing  
 2 Active  
 3 Active, Not Running with Active Policy  
 4 Quiesce in Progress  
 5 Cleanup Initiated by System  
 6 WLM Inactive, Cleanup Complete  
 7 Unknown  
 8 System Inactive, Cleanup Pending  
 9 System Inactive, Cleanup Complete  
 10 Unknown

**uint8 SysplexMembersGPAStatus[]**  
Guest platform management provider (GPMP) status of systems in sysplex:  
 0 PgmError  
 1 Inactive  
 2 Started  
 3 Active  
 4 Connected  
 5 Shutdown1  
 6 Shutdown2  
 7 Shutdown3  
 8 Failed  
 9 Stopped

- 10 SevFailed
- 11 Early-IPL
- 12 Disabled
- 13 Unavailable
- 14 Unknown

**string SysplexMembersActivePolicy[]**

Name of WLM service policy active on systems in sysplex

**datetime SysplexMembersPolicyActivationTimestamp[]**

Time the WLM service policy was activated on systems in sysplex

**string SysplexMembersCleaningSystem[]**

If WLM state is 'Cleanup Initiated by System', the name of the system performing the cleanup

**string CouplingFacilityStructureNames[]**

Name of the WLM coupling facility structures

**uint8 CouplingFacilityStructureStatus[]**

Status of the WLM coupling facility structures:

- 0 Disconnected
- 1 Connected

## Methods

**uint32 RequestStateChange()**

Not supported

**uint32 StartService()**

Not supported

**uint32 StopService()**

Not supported

**uint32 ActivateServicePolicy()**

Activate a service policy contained in the WLM service definition installed in the WLM couple dataset. UPDATE access to the RACF facility class MVSADMIN.WLM.POLICY is required to successfully invoke this method. Successful execution of this method is indicated by an IBMzOS\_WLMPolicyActivationIndication indication.

**uint32 InstallServiceDefinition()**

Install the passed service definition to the WLM couple dataset. UPDATE access to the RACF facility class MVSADMIN.WLM.POLICY is required to successfully invoke this method.

**uint32 ExtractServiceDefinition()**

Extract the service definition from the WLM couple dataset. READ access to the RACF facility class MVSADMIN.WLM.POLICY is required to successfully invoke this method.

**uint32 UploadServiceDefinition()**

Save service definition in XML format in a sequential dataset.

**uint32 DownloadServiceDefinition()**

Download a service definition that is stored in XML format in a sequential dataset.

## Indications

### IBMzOS\_WLMPolicyActivationIndication

A 'process' indication that indicates that a service policy has been activated in the sysplex. This event occurs on each system in the sysplex.

## Associations

### IBMzOS\_WLMOS

Source	IBMzOS_WLM
Target	IBMzOS_ComputerSystem
see	page 283

---

## Association IBMzOS\_WLMOS

### Purpose

This class associates an IBMzOS\_WLM with an IBMzOS\_ComputerSystem.

### Inheritance

- CIM\_Dependency
- ← CIM\_HostedDependency
- ← CIM\_HostedService
- ← IBMzOS\_WLMOS

### Module name

The module name of the CMPI provider that is registered for a CIM class which is used by the cimprovider command line tool for the administration of CMPI providers is

IBMzOS\_WLMOSProviderModule

### Provider library

The physical name of a CMPI provider's shared object library as it is stored in the hierarchical file system is

libiwmosProvider.so

### Owning component

The z/OS component which owns the CMPI provider is

WLM



---

## Part 5. Developer's guide



---

## Chapter 16. CMPI provider development for z/OS

The system-specific management data for the CIM Schema and system-specific Schema extension classes are provided through management instrumentation. While some management instrumentation is already provided by z/OS CIM (see Chapter 14, “z/OS Management Instrumentation for CIM,” on page 125), it is also possible to develop additional management instrumentation for other z/OS resources which are not accessible through the existing z/OS management instrumentation.

You can implement management instrumentation by developing a provider. A provider is a dynamic load library that implements a given interface and contains the program code used by the CIM server to interact with the system resource described by a certain CIM class, for example CIM\_Processor. Providers are registered with the CIM server for a defined CIM class, allowing the CIM server to route all client requests directed against this class to the provider for interacting with the resource. A provider logically acts as an extension of the CIM server for interfacing directly with the managed resources.

Providers are the de facto standard concept for developing management instrumentation, though this purpose of providers is not explicitly mentioned by the various CIM and WBEM standards available from the DMTF. The *Common Manageability Programming Interface* (CMPI) technical standard was defined by The Open Group to allow for developing providers independently from a specific CIM server implementation.

Figure 15 shows the CMPI provider interfaces:

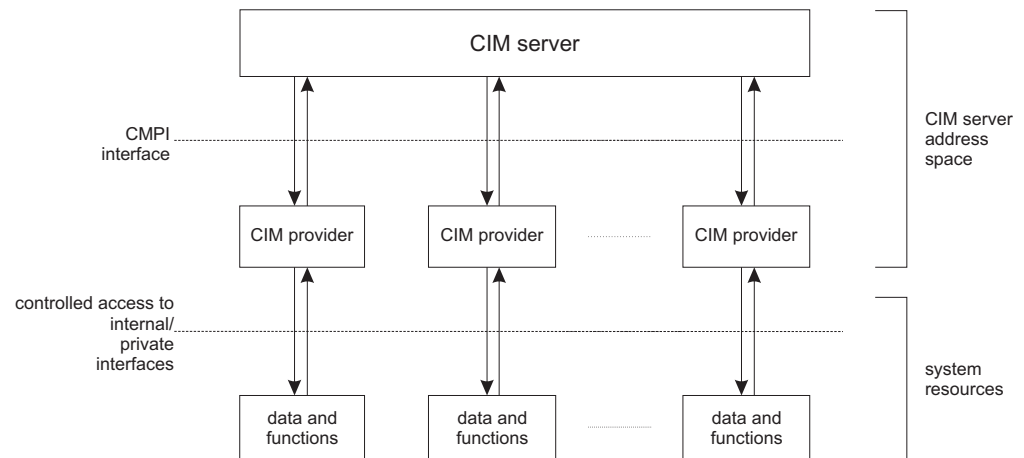

Figure 15. CMPI provider interfaces

CMPI is a C-based programming interface for providers designed for binary compatibility. All management instrumentation included with the z/OS CIM server was developed following the CMPI standard. CMPI is the only supported provider programming interface for the z/OS CIM server. Documentation about the CMPI Technical Standard is available from The Open Group and is not repeated in any documentation available for z/OS. Developers of management instrumentation for

z/OS need to be familiar with the CMPI and CIM/WBEM standards. The information contained here explains the specific aspects that need to be considered for developing CMPI providers for z/OS:

— **1. Obtain the required header files**

To be able to develop a CMPI provider for z/OS, a set of C header files is required that define the CMPI interface. Due to legal implications with the OpenSource nature of these files, they are not provided together with z/OS CIM, but must be obtained from their original location at The Open Group instead.

Due to the CMPI interface design, you need not link a CMPI provider to any library of the z/OS CIM server. Only the header files are needed for developing a CMPI provider library.

See "Obtaining the required header files" for more information.

— **2. Follow general aspects of developing a provider**

(see "Following general aspects of developing a provider" on page 289)

— **3. Expose a provider initialization and function signatures**

(see "Preparing provider initialization and function signatures" on page 290)

— **4. Consider security aspects**

(see "Planning provider security" on page 291)

— **5. Convert EBCDIC provider data into UTF-8**

(see "Converting data to ASCII, EBCDIC and UTF-8" on page 292)

— **6. Follow the guidelines for installing third-party providers**

(see "Provider installation" on page 292)

— **7. Register the provider with the CIM server**

(see "Registering a provider with the CIM server" on page 293)

— **8. Optionally use the out-of-process support for providers**

(see "Using the out-of-process support for providers" on page 301)

---

## Obtaining the required header files

Before you can start to develop a provider dynamic load library, you must obtain the following C header files from the OpenPegasus project through the internet:

<b>cmpidt.h</b>	Data type definitions
<b>cmpift.h</b>	Function signature definitions in the form of function tables
<b>cmpimacs.h</b>	CMPI convenience macros (optional)

These files are available in the OpenPegasus CVS Repository. Users familiar with CVS can check out these files using a CVS client on any platform by following the instructions on the OpenPegasus website in the "CVS Overview" section. The required files are located in directory `pegasus/src/Pegasus/Provider/CMPI`. To get the correct version of the files, they need to be checked out with at least the `RELEASE_2_8_1` tag.

If you are not familiar with using CVS, obtain the files through a web browser starting at the OpenPegasus website. You can navigate from the "Web CVS" section to the required CMPI files by clicking on the following directory names (see also Figure 16 on page 289):

`pegasus` → `src` → `Pegasus` → `Provider` → `CMPI`



## OpenPegasus CVS Repository

File
<a href="#">Attic/</a> [show contents]
<a href="#">atlas/</a>
<a href="#">cvstest/</a>
<a href="#">deleteme/</a>
<a href="#">dmtdocs/</a>
<a href="#">junk/</a>
<a href="#">pegasus/</a>
<a href="#">pegasus-JavaCIMClient/</a>
<a href="#">pegasus_unsupported/</a>
<a href="#">xxxx/</a>

Figure 16. OpenPegasus CVS Repository

Once you have successfully navigated to the CMPI directory, the required header files are at the end of the list of displayed files. To get the correct version of the files, select the tag `RELEASE_2_8_1` or above from the list.

To download the files, first click on the version number displayed in the column after each file name and then select **download** on the next screen where the content of the file is displayed. Once you have successfully downloaded the files, transfer them to the z/OS system on which the provider dynamic load library will be developed, ideally to a ZFS directory. Please note that when transferring files from the workstation to a z/OS system, they should be converted from ASCII to EBCDIC encoding.

There are also a couple of samples for CMPI providers available on the OpenPegasus CVS Repository. They can be obtained the same way as the header files by navigating to the `pegasus/src/Providers/sample/CMPI` directory.

---

## Following general aspects of developing a provider

Before you can start to develop a CMPI provider, you first need to have the CIM class model containing descriptions for the resource to be instrumented in the form of a CIM class. Follow the WBEM standards, and in particular be consistent with the CIM Schema supported by the CIM server when you develop the CIM class. Usually, a CIM class for which a provider is written, is derived from one of the classes in the CIM Schema provided by the DMTF, and named with a vendor-specific class name prefix. For example, the prefix "IBMzOS\_" is used for all classes provided by IBM for the z/OS operating system. This naming scheme also helps to prevent conflicts with the resources that have already been instrumented for CIM by IBM or other vendors.

**Note:** In general it is not recommended to create new providers for resources that have already been instrumented by IBM.

---

## Preparing provider initialization and function signatures

The nature of a CMPI provider does not require static linking to any of the CIM server's libraries. Instead, for each provider function group a single initialization routine (factory) entry point must be exposed following a defined naming scheme, so that the CIM server can call this entry point by name once it has dynamically loaded a provider dynamic load library. The CIM server will attempt to determine the function groups supported by a provider and the respective entry points by verifying the existence of the according provider factory entry points.

The signature for the factory functions looks like this:

```
CMPI<mi-type>MI * <mi-name>_Create_<mi-type>MI(CMPIBroker*,
                                               CMPIContext*,
                                               CMPIStatus*);
```

where <mi-type> refers to the function group of the provider, and <mi-name> refers to the actual provider name as specified during provider registration.

### Important:

The actual signature of this function has an additional '\_' after '\_Create', which is not described as such in the initial version of the CMPI Technical Standard, but is changed in a corrigendum to match the existing implementations of the CMPI interface.

The factory function must return a pointer to a valid CMPI<mi-type>MI structure, where the major component of this structure is the table holding the function pointers, and thus enabling access to the individual provider group functions for the CIM server. An example of such a function pointer is the pointer to the *enumerateInstances* function in the CMPIInstanceMI structure.

The function groups for CMPI providers are *Instance*, *Association*, *Property*, *Method* or *Indication*, where type *Property* is not supported by the z/OS CIM server.

In file *cmpimacs.h*, a set of C preprocessor macros is defined that you may use for the provider initialization code and through which the required code for the <mi-name>\_Create\_<mi-type>MI function is generated in a convenient way. These macros are called *CM<mi-type>MIStub* and they are used in many of the examples referenced in "Samples" on page 301.

For further details refer to "MI Factories" in *CMPI Technical Standard Document* provided by The Open Group.

For each of the CMPI provider function groups, a set of C functions must be implemented as described in "MI Function Signatures" of the *CMPI Technical Standard Document*.

## Instance provider functions

Instance providers are the most common kind of management instrumentation. They implement the basic access to the resources described in a CIM class. With an instance provider it is possible to create, enumerate, modify, delete, query or simply retrieve system resources:

- cleanup(...)
- enumInstanceNames(...)

- enumInstances(...)
- getInstance(...)
- createInstance(...)
- modifyInstance(...)
- deleteInstance(...)
- execQuery(...)

## Method provider functions

Method providers are needed to implement the methods defined for a CIM class.

- cleanup(...)
- invokeMethod(...)

## Association provider functions

Association providers are needed to implement the relationships between system resources as defined by the association classes.

- cleanup(...)
- Associators(...)
- AssociatorNames(...)
- References(...)
- ReferenceNames(...)

## Indication provider functions

Event or indication providers must be implemented for event subscription and notification:

- cleanup(...)
- AuthorizeFilter(...)
- MustPoll(...)
- ActivateFilter(...)
- DeActivateFilter(...)
- EnableIndications(...)
- DisableIndications(...)

Please note that the function *MustPoll* is not supported for z/OS.

---

## Planning provider security

When developing a CMPI provider for z/OS, consider the security context in which the provider runs. Besides the levels of security provided by the z/OS CIM server for authentication and authorization, a provider is processed in the context of a user ID:

### Requestor's user ID

By default, a provider is processed in the context of the requestor's user ID for all invocations that are caused by an external CIM operation. This means that the provider runs under the identity of the requestor's user ID, and resource access authorization occurs against this user ID. See the usage notes for the `pthread_security_np` call in "Callable services descriptions" in *z/OS UNIX System Services Programming: Assembler Callable Services Reference* for additional information.

### Designated user ID

Alternatively, you can provide a designated user ID that runs the provider.

Specify the designated user ID during provider registration using the *UserContext* and *DesignatedUserContext* properties of the *PG\_ProviderModule* class.

When a provider is registered with a designated user ID, the CIM server processes all requests under the designated user ID, regardless which client user ID has issued the request.

The user ID of the requestor is still available for the provider and should be used for further authorization checking in order to prevent unauthorized access to a resource. You have to specify similar security definitions for the designated user ID as for regular client users, as described in “Switching identity (surrogate)” on page 29.

---

## Converting data to ASCII, EBCDIC and UTF-8

Character encoding in the CIM over HTTP protocol is done using UTF-8 character encoding. For that reason CIM clients expect valid UTF-8 returned by the CIM server. The z/OS CIM server executes in the Enhanced ASCII mode. This means that all string data within the CIM server's address space is represented in ASCII rather than EBCDIC encoding. For a provider this means that all string data exchanged with the CIM server is expected to be in ASCII (codepage ISO/IEC 8859-1), encoded in UTF-8 format. Since the native data of z/OS resources is usually represented in EBCDIC, the provider code needs to convert this data before it can return it to the CIM server through the CMPI interface, or when it receives data from the CIM server through the CMPI interface.

UTF-8 is a multi-byte character encoding for UNICODE which can represent much more characters than EBCDIC. While no issue on returning data from a provider through the CIM server to a client, the range of input characters from a client can be larger than a provider can represent in EBCDIC. All valid (7-bit) ASCII characters are also valid UTF-8. Please note that a transformation of the character encoding from EBCDIC to ASCII can generate invalid ASCII, that is ASCII-code above the 7-bit margin.

Therefore it is recommended to compile the provider's C code using the ASCII option of the z/OS XL C/C++ compiler. Using the ASCII option also requires the XPLINK compile and link option.

See *Appendix B* in the *z/OS XL C/C++ Run-Time Library Reference* for additional information about the Enhanced ASCII support. Also see the *z/OS XL C/C++ Guide* and the *z/OS XL C/C++ Programming Guide* for details about the ASCII compiler option.

---

## Provider installation

To enable the CIM server to find and load provider modules and related modules, a provider has to be stored in the hierarchical file system and the CIM server run-time environment has to be tailored. A CMPI provider for z/OS consists of provider modules, dependent modules, the CIM Schema extensions (MOF), and the CMPI provider registration information (MOF).

## Installing providers and dependent load modules

When you develop a CMPI provider, you ship a provider module, a dynamic load library (DLL) module, and, if applicable, its dependent libraries.

- We recommend to store the provider DLL and its dependent libraries in a separate hierarchical file system directory, such as */usr/lpp/myProd/provider*.
- On systems where program control is enabled, flag the provider DLL and its dependent libraries as program controlled using the `extattr` UNIX System Services command:

```
extattr +p <providerfile>
```

We recommend to flag all modules as program controlled by default.

More information:

"Defining modules to program control" in *z/OS UNIX System Services Planning*

## Customizing the CIM server environment for third-party providers

- To enable the CIM server to locate the provider module, extend the CIM server's search list for provider directories by setting the *providerDir* configuration property, such as  

```
providerDir=/usr/lpp/wbem/lib:/usr/lpp/wbem/provider:/usr/lpp/myProd/provider
```

More information: Chapter 9, "CIM server configuration," on page 55
- To locate the provider dependent libraries, extend the library search path (LIBPATH) for the CIM server.
  - The default library search path for the CIM server is defined in the file */etc/wbem/cimserver.env* for the started task CFZCIM. Add your installation directory to the LIBPATH, for example:  

```
LIBPATH=/usr/lpp/wbem/lib:/usr/lpp/wbem/provider:/usr/lib:  
/usr/lpp/myProd/provider
```
  - If you run the CIM server and tools from the UNIX System Services shell, extend the LIBPATH of the shell.

---

## Registering a provider with the CIM server

When the provider dynamic load library has been made physically accessible to the CIM server, it needs to be registered via a special MOF file using the `cimmo` command. A provider registration MOF file contains instances of the CIM classes from the provider registration schema, namely of classes `PG_ProviderModule`, `PG_Provider` and `PG_ProviderCapabilities` as shown in Figure 17 on page 294.

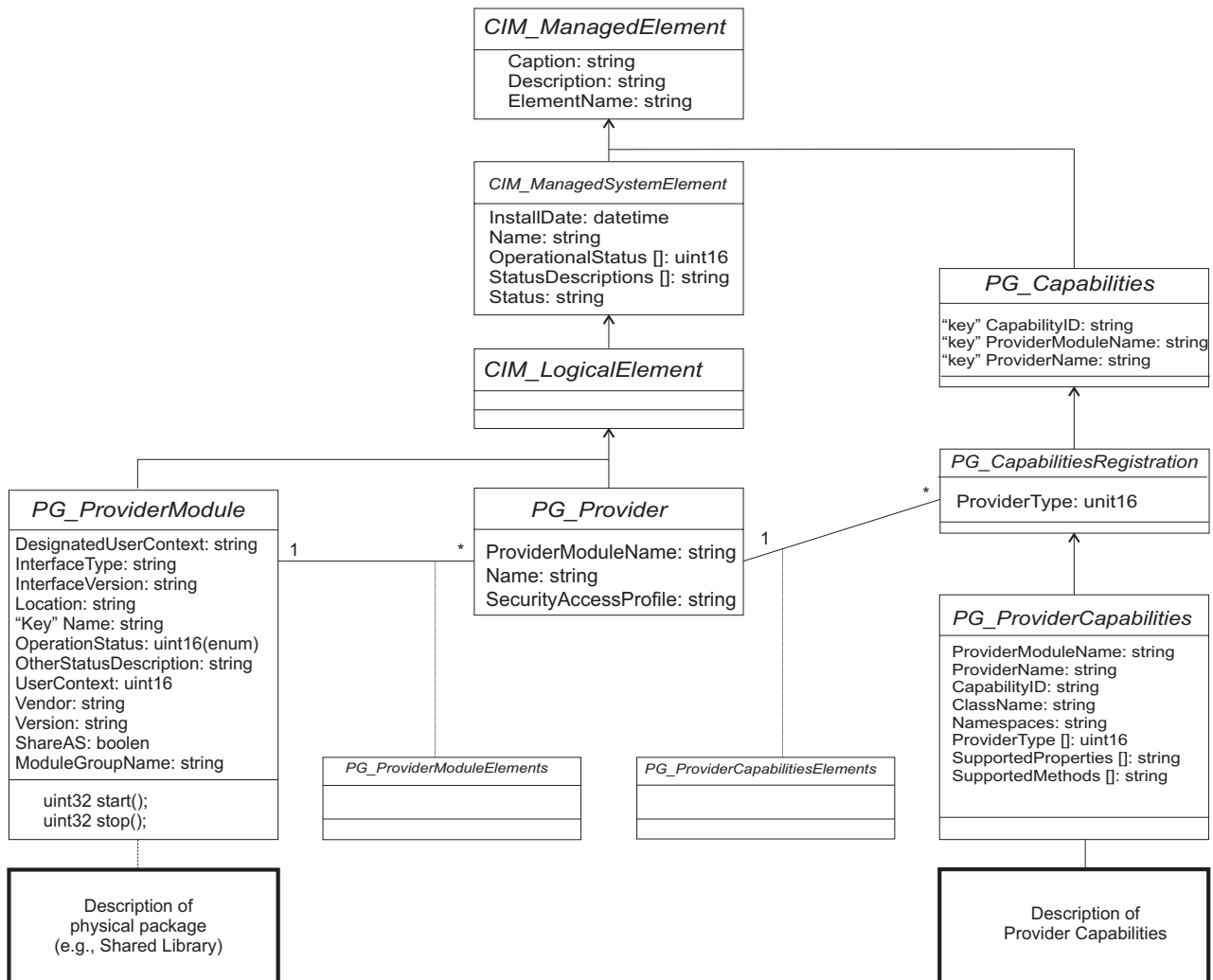

Figure 17. CIM classes from the provider registration schema

The instances of these classes contain all the information that the CIM server needs to know about a provider, for example its physical packaging structure, supported CIM classes and namespaces, as well as the set of supported provider operations.

Once the provider registration MOF file has been created with the instances of classes **PG\_Provider**, **PG\_ProviderModule** and **PG\_ProviderCapabilities**, the content of this MOF file can be loaded into the CIM server's **root/PG\_InterOp** namespace using the **cimmof** command.

The **cimmof** command stores this information in the CIM server run-time repository.

**Example:**

```
cimmof -n root/PG_InterOp TestProviderRegistration.mof
```

The CIM server automatically migrates the repository from one z/OS version to the next. This means, that once the additional provider MOFs have been installed, there is no need to install them again after a z/OS release upgrade.

If the run-time repository including your definitions has been deleted and the CIM server master repository has to be restored, your CIM Schema extensions and provider registration are lost and you have to register them again.

Therefore these MOF files should be part of your delivery and stored in your hierarchical file system directory, such as for example:

*/usr/lpp/myProd/schemas*

stores the schema descriptions and registration information

*MYPROD\_ClassName.mof*

contains the CIM Schema description

*MYPROD\_ClassNameRegistration.mof*

contains the provider registration

More information:

“cimmof” on page 81

“PG\_Provider” on page 296

“PG\_ProviderModule” on page 297

“PG\_ProviderCapabilities” on page 299

## PG\_Provider

### Purpose

This class is the logical representation of a CIM provider. Its only properties are the name of the provider, the name of the provider module in which the code of the provider physically resides and the name of a SAF security profile to be checked before a client is granted access to the provider.

### Properties

#### string ProviderModuleName

The name of the provider module containing the code for this provider. This name needs to match the value of the *Name* property of the corresponding instance of class PG\_ProviderModule.

**string Name** The name of the provider. This name is used to identify a specific provider within a provider module (dynamic load library) and specifies the prefix of a provider's *\_Create\_<mi-type>MI()* initialization function.

#### string SecurityAccessProfile

This property defines the name of a z/OS security server's profile in the CIM server's WBEM class that will be checked for a requestor's access before a request is routed to this provider. Depending on the type of the CIM operation, a different level of access to the security profile is required as listed in Table 2 on page 28.

This is not a required property and can be omitted from the provider registration MOF.

### Examples

Example of an instance of class PG\_Provider in MOF syntax:

```
instance of PG_Provider
{
    //The provider module as defined in PG_ProviderModule
    ProviderModuleName = "TestClassProviderModule";
    // The provider name as referenced in the code
    Name = "TestClassProvider";
};
```



## PG\_ProviderModule

### Purpose

This class represents the physical packaging of one or more providers in a dynamic load library or shared library.

### Properties

**string Name** The logical name of the provider module.

**string Vendor** The name of the provider module vendor, for example, IBM.

**string Version** The provider module version.

**string InterfaceType**

The interface type implemented by the provider. Must be CMPI for z/OS.

**string InterfaceVersion**

The interface version number implemented by the provider. Must be 2.0.0 for CMPI on z/OS.

**string Location**

The name of the dynamic load library or shared library in the hierarchical file system without a path name. The name specified for *Location* is automatically prefixed with `lib` and extended with `.so` by the CIM server:

`lib<Location>.so`

**boolean ShareAS**

Setting the *ShareAS* property to `false` causes the provider module to run in its own copy of a provider agent process. No other provider module will be loaded into this process.

Setting the *ShareAS* property to `false` has a major impact on the performance, so you should not set it to 'false' unless there is an urgent need for a provider module to be protected from other provider modules. The default setting of *ShareAS* is `true`.

Setting *ShareAS* to `false` is only honored by the CIM server, if it is running with the configuration property *forceProviderProcesses* set to `true`.

**uint16 UserContext**

Defines the user context in which this provider module is invoked.

Values:

#### **2 (Requestor), default**

The provider is invoked in the security context of the user requesting an operation.

#### **3 (Designated User)**

The provider is invoked in the security context of the user ID specified by the *DesignatedUserContext* property.

See "Running providers in a designated user context" on page 42 for a general description on running a provider module with a designated user context.

### **string DesignatedUserContext**

Specifies the user ID providing the context in which this provider module is invoked (regardless of which user requests an operation).

Values:

**NULL** when *UserContext* = 2

**non-NULL value**  
when *UserContext* = 3

See “Running providers in a designated user context” on page 42 for a general description on running a provider module with a designated user context.

### **string ModuleGroupName**

Specifies a group name for the provider module, if the configuration property *forceProviderProcesses* is true. Else it has no effect.

This property controls which provider modules are running together in the same provider agent process.

- If the specified value is *CIMServer*, the provider module is loaded into the CIM server process.
- Provider modules having the same group name other than *CIMServer* are loaded into a single agent process.
- If no module group name is defined, the provider either runs in a single shared provider agent process together with all other providers without a module group name, or in its own distinct provider agent process in case *ShareAS* is true.

Can be set dynamically using the *cimprovider* command (see “*cimprovider*” on page 85).

## **Examples**

Example of an instance of class *PG\_ProviderModule* in MOF syntax:

```
instance of PG_ProviderModule
{
    Name = "TestClassProviderModule";
    //The library name on disk
    Location = "TestClassProvider";
    // (will be extended to libTestClassProvider.so)
    Vendor = "IBM";
    Version = "1.0.0";
    InterfaceType = "CMPI";
    InterfaceVersion = "2.0.0";
    ShareAS = true;
    UserContext = 2;
};
```

## PG\_ProviderCapabilities

### Purpose

This class describes the specific capabilities of a provider. Multiple instances of PG\_ProviderCapabilities can be created for each provider allowing the same provider to be registered, for example, for multiple CIM classes.

### Properties

#### string ProviderModuleName

The name of the provider module as specified in the corresponding instances of classes PG\_Provider and PG\_ProviderModule.

#### string ProviderName

The name of the provider as specified in the corresponding instance of class PG\_Provider.

#### string CapabilityID

A value that uniquely identifies this *Capabilities* instance within the set of *Capabilities* for the designated provider.

#### uint16[] ProviderType

Enumerates the kind of provider capabilities (=supported operations) defined for the associated provider:

- 2 Instance
- 3 Association
- 4 Indication
- 5 Method
- 6 IndicationConsumer (not supported for z/OS)
- 7 InstanceQuery

#### string ClassName

Describes the CIM class for which the associated provider supplies instances, associations or indications information.

#### string[] Namespaces

Describes the namespaces that are supported by the provider for this CIM class.

#### string[] SupportedProperties

Lists the properties supported by this provider. If this array is empty, the provider **must** support all of the properties defined in the class.

#### string[] SupportedMethods

Lists the methods supported by this provider. If this array is empty, the provider **must** support all the methods defined in the class.

### Examples

Example of an instance of class PG\_ProviderCapabilities in MOF syntax:

```
instance of PG_ProviderCapabilities
{
    //The provider module as defined in PG_ProviderModule
    ProviderModuleName = "TestClassProviderModule";
    //The provider name as defined in PG_Provider
    ProviderName = "TestClassProvider";
    CapabilityID = "1";
    //Name of the CIM class as defined in the mof
    ClassName = "IBMzOS_TestClassB";
    Namespaces = {"root/cimv2","root/test"};
    ProviderType = { 2, 5 }; // Instance, Method
}
```

```

        SupportedProperties = NULL; // All properties
        SupportedMethods = NULL; // All methods
    };

instance of PG_ProviderCapabilities
{
    //The provider module as defined in PG_ProviderModule
    ProviderModuleName = "TestClassProviderModule";
    //The provider name as defined in PG_Provider
    ProviderName = "TestClassProvider";
    CapabilityID = "2";
    //Name of the CIM class as defined in the mof
    ClassName = "IBMzOS_TestIndication";
    Namespaces = {"root/cimv2"};
    ProviderType = { 4 }; // Indication
    SupportedProperties = NULL; // All properties
    SupportedMethods = NULL; // All methods
};

```

---

## Using the out-of-process support for providers

When the CIM server is started in out-of-process mode using the *forceProviderProcesses* configuration property, providers may run in separate address spaces. Then, the z/OS-specific property *ShareAS* and the common property *ModuleGroupName* for class *PG\_ProviderModule* are considered. You may specify them during provider registration via the registration MOF file. *ModuleGroupName* can also be set dynamically at runtime using the *-g* option of the *cimprovider*.

**To specify that a provider shall always run in its own provider agent process,**

- set the z/OS-specific property *ShareAS* to *false* during provider registration.

**To define a group of providers sharing a provider agent process,**

- assign the same module group name to the respective providers using the property *ModuleGroupName* during provider registration.

**To specify that a provider shall run in the CIM server address space,**

- assign the module group name *CIMserver* to the property *ModuleGroupName* of the provider during provider registration.

**Example** of a provider registration MOF file with properties specified for the out-of-process support:

```
instance of PG_ProviderModule
{
    Name = "OSBase_TestClassProviderModule";
    //The library name on disk
    Location = "cmpiOSBase_TestClassProvider";
    Vendor = "IBM";
    Version = "2.0.0";
    InterfaceType = "CMPI";
    InterfaceVersion = "2.0.0";
    ShareAS = false;
    ModuleGroupName = "CMPITEST";
};
```

---

## Samples

Examples for CMPI providers can be found on the *OpenPegasus CVS Repository*, located in the *pegasus/src/Providers/sample/CMPI* directory. You can access them in the same ways as described in “Obtaining the required header files” on page 288. Please note that these examples have been enabled for z/OS only in an OpenPegasus build environment and will need some minor adoptions for a custom build environment.

Additional examples are available from the *SBLIM OpenSource* project (packages *sblim-cmpi-<xxx>*) hosted on SourceForge.net. Although the CIM providers from SBLIM apply to Linux platforms only, they are examples for how to write CIM providers in general. The SBLIM project also provides a number of useful tools and documents related to provider development.



---

## Chapter 17. CIM indications

Indications in CIM are represented as instances of class CIM\_Indication. This abstract class serves as the base class for all indication classes.

Indications are transient instances used to distribute information from an indication generator to an arbitrary number of indication consumers. Therefore, they are typically very short-living. Indications have a source namespace, this is the value of the *SourceNamespace* property of the CIM\_IndicationFilter instance that produced the indication. Although indications are instances of CIM classes, they are unique in that they cannot be addressed, but can only be received by subscription. Hence, indication instances cannot be enumerated, created, deleted, retrieved or modified by client operations.

Note that z/OS does not ship generic providers, that is, an indication subscription is only processed if the required indication provider exists and is registered with the CIM server for a certain CIM resource class.

The CIM Schema version provided with z/OS supports two types of indications (representing different types of events) which are modeled as CIM\_Indication subclasses. These subclasses include:

### **CIM\_InstIndication**

used to report life cycle events for CIM instances. Types of events include: Instance creation, deletion, modification, method invocation and read access. For each of these types, a specific subclass of CIM\_InstIndication is defined in the CIM Schema: CIM\_InstCreation, CIM\_InstDeletion, CIM\_InstModification, CIM\_InstMethodCall and CIM\_InstRead. Only the first three are currently supported for z/OS.

### **CIM\_ProcessIndication**

used to report the occurrence of any other event, typically alert type events. See "CIM\_ProcessIndication" on page 304.

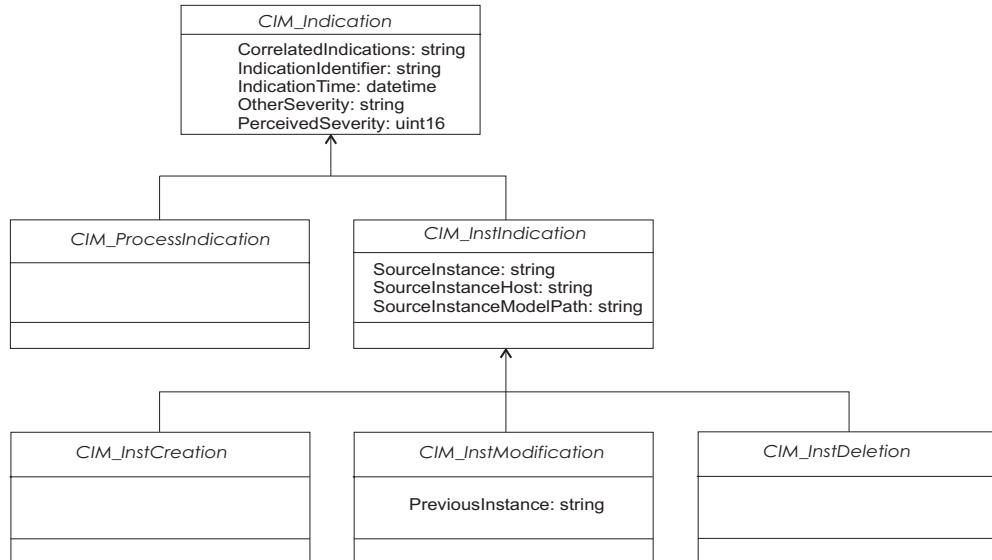

Figure 18. z/OS CIM indication hierarchy

## CIM indication class hierarchy

The CIM indication class hierarchy models the types of events that can be detected. An instance of **CIM\_Indication** represents the occurrence of an event in general. Indication instances cannot be addressed, but they have a source namespace. Although indications are modeled using CIM classes, indications are unique in that they cannot be manipulated or retrieved, but they can only be received by subscription. The **CIM\_Indication** class is the base class for all other indication classes. It includes the following properties:

### IndicationIdentifier

identifies indication instances uniquely within their source namespace.

### IndicationTime

describes, to the extent possible, the time and date of the creation of the underlying event for the indication.

### CorrelatedIndications

specifies a list of other indications, referenced by their *IndicationIdentifier* property values, that are related to this indication. These *IndicationIdentifier* property values are interpreted to have the same source namespace as this indication.

While the *CorrelatedIndications* property values are to be interpreted in the context of a single CIM namespace, any instances of other classes of the CIM Event Model do not need to be located in the same namespace.

## CIM\_ProcessIndication

**CIM\_ProcessIndication** models any events other than life cycle events. In the CIM Schema version supported for z/OS, the following two subclasses of **CIM\_ProcessIndication** are defined:

- **CIM\_AlertIndication** – signals the occurrence of an alert type of event. Properties of this subclass include *PerceivedSeverity*, *ProbableCause*, *RecommendedAction* and *Trending*, describing an alerting situation.



- CIM\_SNMPTrapIndication – used to map SNMP traps to CIM indications. This is currently not supported by the z/OS CIM server.

## CIM\_InstIndication (Lifecycle Event)

An instance of CIM\_InstIndication denotes the occurrence of a life cycle event on a CIM instance. The possible life cycle events are: creating an instance, deleting an instance, modifying an instance, reading an instance or invoking a CIM method on an instance. An instance of CIM\_InstIndication includes an embedded copy (that is, a current snapshot) of the instance, SourceInstance, on which the life cycle event occurred.

Instances of CIM\_InstModification include an embedded copy of the instance, PreviousInstance, before the modification occurred.

Lifecycle events on CIM instances include both, changes caused by a CIM client, and changes that happen spontaneously from a CIM client perspective due to volatile behavior of the CIM provider.

## CIM\_InstModification

Lifecycle events on CIM instances include both, changes caused by a CIM client, and changes that are caused by a change of the underlying system resource that is represented via a CIM instance.

---

## CIM subscription mechanism

The CIM Event Model defines how CIM clients subscribe to receive indications as shown in Figure 19 and Figure 20 on page 307. A CIM\_IndicationFilter instance describes the set of conditions, a CIM\_ListenerDestinationCIMXML instance defines the *CIM listener* and the communication protocol, that is, it describes the method and targets for distributing the indications. Finally, a CIM\_IndicationSubscription association instance between the CIM\_IndicationFilter instance and the CIM\_ListenerDestinationCIMXML instance is used to subscribe for receiving these indications. The creation of this association instance activates the subscription.

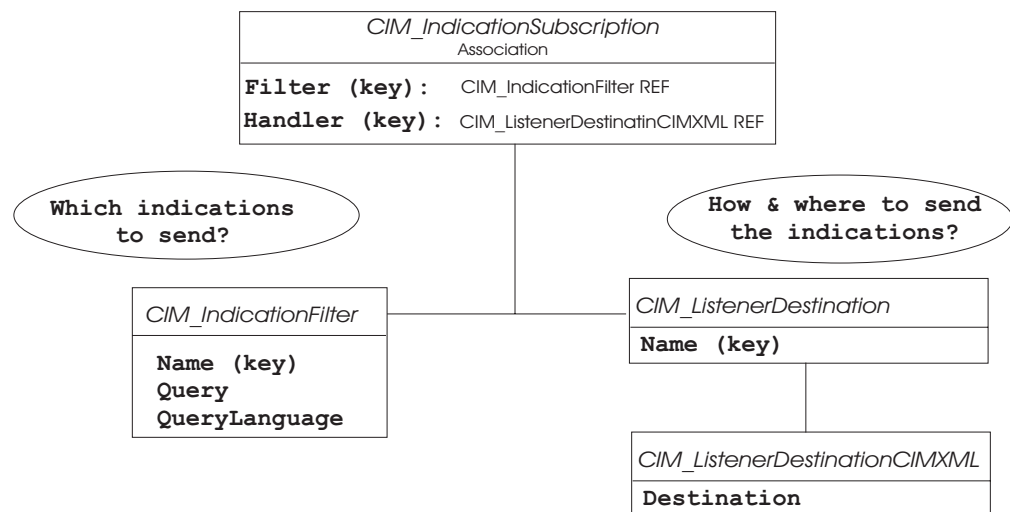

Figure 19. Indication subscription class diagram

## CIM\_IndicationFilter

An instance of CIM\_IndicationFilter describes the set of indications of interest by means of a query expression. This is also called the desired indication stream. The most relevant properties of CIM\_IndicationFilter are:

- **Name, CreationClassName, SystemName, SystemCreationClassName** – key properties.
- **SourceNamespace** – defines the source namespace for the indications resulting from this indication stream.
- **Query** – query string, like “select \* from CIM\_InstModification where ...”; defines the indication class, filter condition and property list of the indication stream.
- **QueryLanguage** – defines the query language used in the **Query** property. The z/OS CIM server supports the query languages “DMTF:CQL” (CIM Query Language) and “WQL” (WBEM Query Language). For more information, see the CIM Query Language Specification.
- **DeliveryRetryInterval** defines the minimum time between two delivery retries.
- **DeliveryRetryAttempts** defines the maximum number of delivery retries.

For information about the complete set of properties of a CIM\_IndicationFilter, refer to the CIM Event Model White Paper or to the definition of this class in the CIM Schema. The white paper also contains an example of a CIM\_IndicationFilter instance.

## CIM\_ListenerDestinationCIMXML

An instance of CIM\_ListenerDestinationCIMXML defines “how and where” to send an indication. In particular, the CIM\_ListenerDestinationCIMXML instance defines the desired indication destination, encoding and protocol for delivery of the indication stream. CIM\_ListenerDestinationCIMXML specializes CIM\_ListenerDestination and is used for indication consumers that support the CIM Operations over HTTP protocol (see Specification for CIM Operations over HTTP, DSP0200, on <http://www.dmtf.org/standards/documents/WBEM/DSP200.html>).

The CIM\_ListenerDestination class hierarchy can be extended to allow the definition of additional indication handling mechanisms.

The most relevant properties of CIM\_ListenerDestinationCIMXML are:

- **Name, CreationClassName, SystemName, SystemCreationClassNam** – key properties
- **Destination** – URL to which the indications are to be delivered

For information about the complete set of properties of CIM\_ListenerDestinationCIMXML, refer to the CIM Event Model White Paper or to the definition of this class in the CIM Schema.

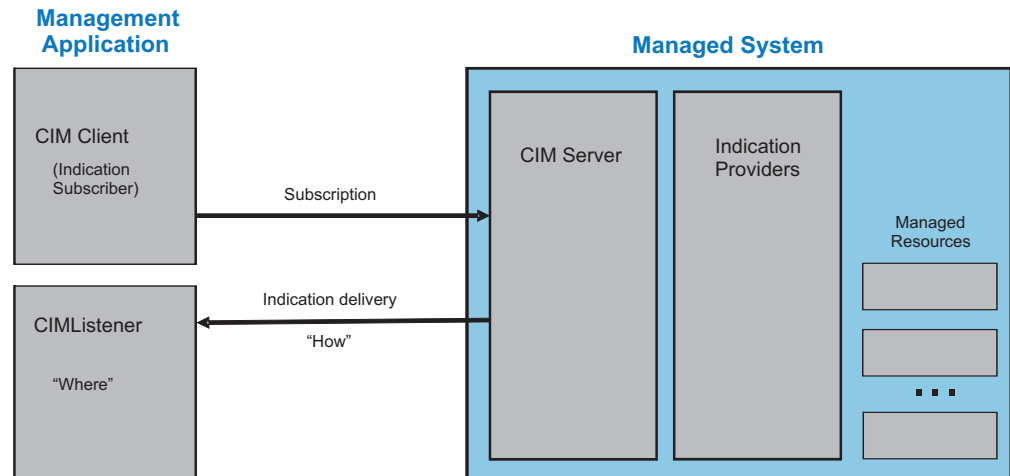

Figure 20. Indication Handler

## CIM\_IndicationSubscription

Primarily, an instance of `CIM_IndicationSubscription` defines the association between a `CIM_IndicationFilter` instance and a `CIM_ListenerDestinationCIMXML` instance. In addition, it includes a set of properties that further specify the behavior of a subscription. The most relevant properties of `CIM_IndicationSubscription` are:

- The **Repeat Notification** properties (those having “RepeatNotification” contained in their property name) define the behavior for handling indications that report the occurrence of the same underlying event (that is, the disk is still generating I/O errors and has not yet been repaired).
- The **Subscription State** properties (those having “SubscriptionState” contained in their property name) allow a CIM client to monitor and control the state of the subscription.
- The **Subscription Failure Handling** properties (`OnFatalErrorPolicy`, `OtherOnFatalErrorPolicy`, `FailureTriggerTimeInterval`) define the desired behavior when a fatal error occurs during subscription processing.
- The **Subscription Duration** properties (`SubscriptionDuration`, `SubscriptionStartTime`, `SubscriptionTimeRemaining`) allow to expire a subscription automatically, based upon elapsed time since its creation, and to monitor the elapsed times since creation and until expiration.

You can find more detailed information about these properties as well as the complete set of properties of `CIM_IndicationSubscription` in the CIM Event Model White Paper or in the definition of this class in the CIM Schema.



---

## Part 6. Messages



---

## Chapter 18. z/OS specific messages

Messages are written into the appropriate logs and also displayed at the z/OS console.

All messages issued by the CIM server are part of the underlying OpenPegasus code. This section documents only those messages that are specific while using the CIM server on z/OS, together with explanation, system action, (system) programmer and user response.

All other OpenPegasus messages are wrapped by one of the following generic z/OS messages.

**CFZ00001I** for INFORMATION log messages  
**CFZ00002W** for WARNING log messages  
**CFZ00004E** for SEVERE and FATAL log messages

---

### CEZ-prefix messages

---

**CEZ02000I** Requesting CONFIG ONLINE for CPU  
*CPU-address*

**Explanation:** The IBMzOS\_Processor method RequestStateChange has been issued with RequestedState=Enabled.

**System action:** None.

**System programmer response:** Issue a CF CPU(*CPU-address*),ONLINE command, or use your automation tool to set the CPU *CPU-address* online.

**User response:** None.

---

**CEZ02001I** Requesting CONFIG OFFLINE for CPU  
*CPU-address*

**Explanation:** The IBMzOS\_Processor method RequestStateChange has been issued with RequestedState=Offline.

**System action:** None.

**System programmer response:** Issue a CF CPU(*CPU-address*),OFFLINE command, or use your automation tool to set the CPU *CPU-address* offline.

**User response:** None.

---

**CEZ03000E** Request user ID *user-ID* requires UPDATE permission on profile IOSCDR CL(FACILITY).

**Explanation:** A CIM operation was invoked that requires the use of an authorized IOSCDR service. The IOSCDR service is used by CIM providers to retrieve device identification information (such as the serial

number and the model number) for an I/O device. Providers that instrument the CIM classes IBMzOS\_SBProtocolEndpoint or IBMzOS\_SBInitiatorTargetLogicalUnitPath are an example for this scenario.

**System action:** The requested CIM operation is returned in error.

**System programmer response:** Verify if the user should be permitted to perform operations using the IOSCDR service. If so, grant the user *user-ID* UPDATE permission to the profile IOSCDR in the class FACILITY. Then restart the CIM server.

**User response:** Report this problem to your system programmer.

---

**CEZ03001E** Internal error occurred. SMI-S Indication Data Cache error *error-code*.

**Explanation:** The SMI-S data cache and thread are in an unrecoverable error state. *error-code* describes the kind of error.

**System action:** The requested CIM operation is returned in error.

**System programmer response:** The error code indicates the kind of error:

- 1 (SMIS\_CACHE\_CONTROL\_ERROR)  
Error in the data cache control structures
- 2 (SMIS\_CACHE\_ERROR)  
Error in the data cache data
- 3 (SMIS\_THREAD\_CREATION\_ERROR)  
Error in data cache thread

Restart the CIM server. If the problem persists, contact IBM service for assistance.

**User response:** Report this problem to your system programmer.

---

**CEZ03002W Lost connection to CEA, trying to reconnect. CIM Indications may get lost.**

**Explanation:** The SMI-S CIM indication provider has lost the connection to CEA. Without this connection, no SMI-S CIM indications can be generated, for example for changes on port controllers.

**System action:** The CIM provider continuously attempts to reconnect to CEA until it becomes available.

**System programmer response:** Restart Common Event Adapter (CEA) in full function mode.

**User response:** Report this problem to your system programmer.

---

**CEZ03003W Failed to reconnect to CEA. CIM Indications may get lost.**

**Explanation:** The SMI-S CIM indication provider failed to reconnect to CEA. Without this connection, no SMI-S CIM indications can be generated, for example for changes on port controllers.

**System action:** The CIM provider continuously attempts to reconnect to the CEA until it becomes available.

**System programmer response:** Restart Common Event Adapter (CEA) in full function mode.

**User response:** Report this problem to your system programmer.

---

**CEZ03004I Successfully reconnected to CEA.**

**Explanation:** The SMI-S CIM indication provider has successfully reconnected to CEA.

**System action:** None.

**System programmer response:** None.

**User response:** None.

---

**CEZ03005I Successfully re-established subscription to CEA.**

**Explanation:** The SMI-S CIM indication provider has successfully renewed its subscriptions for ENF signals to CEA.

**System action:** None.

**System programmer response:** None.

**User response:** None.

---

**CEZ03006E Subscription to CEA failed for handler *module-name* with reason code *reason-code*.**

**Explanation:** The SMI-S CIM indication provider failed to subscribe to CEA in order to receive ENF signals through CEA subscription handler *module-name*.

**System action:** The requested CIM operation is returned in error.

**System programmer response:** The *reason-code* indicates why the CEA subscription to handler *module name* failed. See "Appendix C. CEA reason codes" on page 353 for error details. After correcting the error, restart the CIM server.

**User response:** Report this problem to your system programmer.

---

**CEZ03007E Failed to retrieve CEA event, reason code *reason-code*.**

**Explanation:** The SMI-S CIM indication provider failed to receive a CEA event and therefore cannot process CIM indications.

**System action:** None.

**System programmer response:** See "Appendix C. CEA reason codes" on page 353 for error details. After correcting the error, restart the CIM server.

**User response:** Report this problem to your system programmer.

---

**CEZ03008W Renewing CEA subscription after operator unsubscribe.**

**Explanation:** The SMI-S CIM indication provider has detected an operator forced unsubscribe from CEA. Since this would leave orphaned CIM indication subscriptions, the subscription to CEA is automatically re-established.

**System action:** The SMI-S CIM provider automatically re-establishes the removed CEA subscriptions.

**System programmer response:** Remove SMI-S CIM subscriptions through the `cimsub` utility (see "cimsub" on page 114) or make sure the CIM clients are properly unsubscribed from SMI-S CIM indications for this system.

**User response:** Report this problem to your system programmer.

---

**CEZ03009W Missed CEA event(s) caused loss of CIM indications.**

**Explanation:** The SMI-S CIM indication provider was informed by the Common Event Adapter (CEA) that it has missed a number of events. This causes a loss of CIM indications for subscribed CIM Client applications.

**System action:** None.



**System programmer response:** None.

**User response:** If known, inform the owners of CIM client applications that have subscribed to this z/OS system.

---

**CEZ03010E User *user-ID* not authorized to connect to Common Event Adapter (CEA).**

**Explanation:** The user *user-ID* is not authorized to connect to the Common Event Adapter (CEA). The CIM SMI-S indication providers depend on CEA for issuing indications about state changes related to FC Ports. After correcting the error, restart the CIM server.

**System action:** None.

**System programmer response:** Ensure that the user *user-ID* has READ access to profile CEA.CONNECT in the SERVAUTH class.

See "Setting up the CIM server for storage management" on page 41 for the authorizations required to connect to CEA.

**User response:** Contact your system programmer or security administrator.

---

**CEZ03011E User *user-ID* not authorized for subscription to Common Event Adapter (CEA).**

**Explanation:** The user is not authorized to subscribe for ENF signals through the Common Event Adapter (CEA). The CIM SMI-S indication providers depend on the CEA for issuing indications about state changes.

**System action:** None.

**System programmer response:** Ensure the user *user-ID* has READ access to profiles

- CEA.SUBSCRIBE.ENF\_0009\*
- CEA.SUBSCRIBE.ENF\_0027\*
- CEA.SUBSCRIBE.ENF\_0033\*

in the SERVAUTH class.

See "Setting up the CIM server for storage management" on page 41 for the authorizations required to connect to CEA. After correcting the error, restart the CIM server.

**User response:** Contact your system programmer or security administrator.

---

**CEZ03012E Connection to CEA failed with reason code *reason-code*.**

**Explanation:** The SMI-S CIM indication provider failed to connect to the Common Event Adapter and therefore cannot process CIM indications.

**System action:** CIM Indications for SMI-S are unavailable.

**System programmer response:** See "Appendix C. CEA

reason codes" on page 353 for error details. After correcting the error, restart the CIM server.

**User response:** Contact your system programmer.

---

**CEZ03031E Request user ID *user-ID* requires UPDATE permission on profile IOSPORTS CL(FACILITY).**

**Explanation:** A CIM operation was invoked that requires the use of an authorized IOSPORTS service. The IOSPORTS service is used by CIM providers for port decommissioning and recommissioning, and for assigning a WWN to an IBMzOS\_FCPort or IBMzOS\_FCCUPort.

**System action:** The requested CIM operation is returned in error.

**System programmer response:** Verify if the user should be permitted to perform operations using the IOSPORTS service. If so, grant the user *user-ID* UPDATE permission to the profile IOSPORTS in the class FACILITY. Then restart the CIM server.

**User response:** Report this problem to your system programmer.

---

**CEZ05000E Internal error detected in provider module *module-name* when method *method-name* invoked system service *service-name*. The service returned RC=*return-code* RSN=*CEA-reason-code*. Additional diagnostic information: CEAERRO\_Diag1=*code1* CEAERRO\_Diag2=*code2* CEAERRO\_Diag3=*code3* CEAERRO\_Diag4=*code4* CEAERRO\_Msg=*text***

**Explanation:** The system encountered an internal error while processing a CIM request. The following information is provided:

*module-name*

Name of CIM provider module

*method-name*

Name of CIM method invoked

*service-name*

Name of the internal service, usually in the CEA component

*return-code*

Internal return code

*CEA-reason-code*

Internal CEA reason code. See "Appendix C. CEA reason codes" on page 353 for details.

*CEAERRO\_Diag1-4*

Internal values representing errors in system processing on behalf of the CIM request

*CEAERRO\_Msg*

Textual information saved by system processing on behalf of the CIM request

**System action:** System processing ended with the

error information described in this message.

**System programmer response:** See CEAERRO\_Msg for more informational messages about the problem. If the problem is still unclear or no additional messages are available, contact IBM Service for assistance.

**User response:** Report this problem to your system programmer.

---

**CEZ05001E Internal error detected in provider module *module-name* when method *method-name* invoked system service *service-name*. The service returned RC=*return-code* RSN=*CEA-reason-code***

**Explanation:** The system encountered an internal error while processing a CIM request. The following information is provided:

*module-name*

Name of CIM provider module

*method-name*

Name of CIM method invoked

*service-name*

Name of the internal service, usually in the CEA component

*return-code*

Internal return code

*CEA-reason-code*

Internal CEA reason code. See "Appendix C. CEA reason codes" on page 353 for details.

**System action:** The requested CIM operation is returned in error. System processing ended with the error information described in this message.

**System programmer response:** Contact IBM Service for assistance.

**User response:** Report this problem to your system programmer.

---

**CEZ05002E Common Event Adapter (CEA) not available.**

**Explanation:** A CIM method was invoked, but the CEA address space was not active to process the request.

**System action:** The requested CIM operation is returned in error.

**System programmer response:** Enter the command START CEA from the operator console to start the CEA address space. Verify that CEA is active through the command D A,CEA.

**User response:** Report this problem to your system programmer.

---

**CEZ05003E User *user-name* not authorized for Common Event Adapter (CEA) request.**

**Explanation:** A CIM method was invoked, but the user is not authorized to issue requests to the CEA component.

**System action:** The requested CIM operation is returned in error.

**System programmer response:** Ensure that the user has access to CEA. Refer to "RACF setup" on page 39.

**User response:** Report this problem to your system programmer.

---

**CEZ05004E IPCS Sysplex Dump Directory cannot find incident information.**

**Explanation:** A CIM method was invoked to locate a specific incident, but the Common Event Adapter (CEA) component cannot locate the incident in the sysplex dump directory (SYS1.DDIR). Common reasons include:

- Sysplex dump directory SYS1.DDIR (or equivalent data set name) is not set up correctly
- Dump incident is not in the directory
- Incident could have been previously deleted from the directory.

**System action:** The requested CIM operation is returned in error. If the failure occurred while performing a set tracking number or set PMR number operation, the function ends without having updated either value.

**System programmer response:** Verify that the sysplex dump directory exists and is usable. Default name is SYS1.DDIR. For more information, see the topic on troubleshooting problems in *z/OS Management Facility User's Guide*. If the problem persists, contact IBM Service for assistance.

**User response:** Report this problem to your system programmer.

---

**CEZ05005E System REXX not available.**

**Explanation:** A CIM method was invoked, requiring the invocation of a system REXX exec. However, the System REXX address space (AXR) or facilities that it provides are not available.

**System action:** The requested CIM operation is returned in error.

**System programmer response:** Enter the command START AXRPSTRT from the operator console to start System REXX. Verify that System REXX is active with the D A,AXR command.

**User response:** Report this problem to your system programmer.

---

**CEZ05006E System REXX is not configured to support compiled REXX execs.**

**Explanation:** A CIM method was invoked, requiring the invocation of a system REXX exec. However, the System REXX component cannot process the exec. This usually indicates that the run time support for compiled REXX has not been set up.

**System action:** The requested CIM operation is returned in error.

**System programmer response:** The REXX library and the REXX Alternate library must be installed. Refer to the Program Directory of these optional products for installation instructions.

**User response:** Report this problem to your system programmer.

---

**CEZ05007W The request *method-name* has timed out.**

**Explanation:** A CIM method was invoked, requiring the invocation of a system REXX exec that timed out.

**System action:** The requested CIM operation is returned in error.

**System programmer response:** This is an internal problem related to the TIMEINT parameter on the AXREXX macro. Contact IBM Service for assistance.

**User response:** Report this problem to your system programmer.

---

**CEZ05008W The request *method-name* could not be processed at this time.**

**Explanation:** A CIM method was invoked, but System REXX is overloaded and cannot schedule the corresponding REXX exec to run at this time.

**System action:** System REXX limits the number of active and waiting requests to 5000. The requested CIM operation is returned in error.

**System programmer response:** Enter the command SYSREXX STATUS and check the value specified as "REQUESTS QUEUED" in message AXR0200I. Have the user retry the operation when there are fewer System REXX requests being processed. If still unsuccessful, contact IBM Service for assistance.

**User response:** Report this problem to your system programmer.

---

**CEZ05009E SYS1.MIGLIB is not APF authorized.**

**Explanation:** A CIM method was invoked that requires the use of an authorized service in SYS1.MIGLIB (such as AMATERSE). However, SYS1.MIGLIB is not APF authorized, which prevents CEA from invoking those programs.

**System action:** The requested CIM operation is returned in error.

**System programmer response:** From the operator console, enter the command

```
SETPROG APF,ADD,DSN=SYS1.MIGLIB,  
VOL=<volser>
```

where <volser> is the volume on which MIGLIB resides.

**User response:** Report this problem to your system programmer.

---

**CEZ05010E User *user-name* not authorized to view operator log snapshot *logstream-or-dataset-name*.**

**Explanation:** A CIM method was invoked, referencing an OPERLOG snapshot for a specific incident, but the invoker is not SAF authorized to view information about the snapshot. OPERLOG diagnostic snapshots are stored in DASD log streams with data set names containing the high level data set qualifier specified in the CEAPRMxx PARMLIB member.

**System action:** The requested CIM operation is returned in error.

**System programmer response:**

- The security administrator must authorize the invoker of the service to the high-level qualifier (HLQ) of this dataset.
- The PARMLIB member CEAPRM00 (or the customized member CEAPRMxx, where xx is the suffix particular to your system) should contain the customized HLQ value or its default ('CEA').

**User response:** Report this problem to your system programmer.

---

**CEZ05011E The System Logger is not available. CEAERRO\_Diag4=*code***

**Explanation:** A CIM method was invoked, attempting to access a DASD log stream, but the System Logger facility is not available. The *code* value associated with CEAERRO\_Diag4 refers to a system logger return code.

**System action:** The requested CIM operation is returned in error.

**System programmer response:**

- See the description of IXGCON in *z/OS MVS Data Areas, Vol 3* for an explanation of the logger reason code in CEAERRO\_Diag4.
- If the system is not running with a logger couple data set, this is a permanent condition for the IPL. Otherwise, restart the system logger and enter the request again.

**User response:** Report this problem to your system programmer.

---

**CEZ05012E The Common Event Adapter (CEA) event *event-name* was forced removed by the system operator.**

**Explanation:** The system operator used the CEUnsubscribe console command to force the removal of this event while there was a CIM user subscribed to it. The following console command may have been issued:

```
f cea,diag,remove,client=clientname,
    event=eventname
```

**System action:** The CIM indication will no longer be surfaced.

**System programmer response:** Avoid removing events that have outstanding subscriptions.

**User response:** Unsubscribe to the event specified in the message and resubscribe.

---

**CEZ05013E Common Event Adapter (CEA) is running in minimum mode.**

**Explanation:** The system operator has forced CEA into 'minimum mode' by using the command:

```
f cea,mode=min
```

CIM indication processing is unavailable.

**System action:** CIM indications will not be supported.

**System programmer response:** Change CEA to run in 'full mode'. The following console command can be used:

```
f cea,mode=full
```

**User response:** Contact your system programmer.

---

**CEZ05014E Internal error detected in provider module *module-name* while invoking method *method-name*.**

**Explanation:** A CIM method was invoked, but an internal provider error occurred in the CIM provider.

**System action:** The requested CIM operation is returned in error.

**System programmer response:** Contact IBM Service for assistance.

**User response:** Report this problem to your system programmer.

---

**CEZ05015E Target operating system *version/release* not supported for provider module *module-name* method *method-name*.**

**Explanation:** A CIM method was invoked, but the provider requires the identified minimum operating system *version/release*.

**System action:** The requested CIM operation is returned in error.

**System programmer response:** Contact IBM Service for assistance.

**User response:** Report this problem to your system programmer.

---

**CEZ05016E IPCS Sysplex Dump Directory failure.**

**Explanation:** A CIM method was invoked to locate incident information, but the Common Event Adapter (CEA) component encountered a File Open Error when accessing the sysplex dump directory (SYS1.DDIR or equivalent data set name). A possible cause is that SYS1.DDIR is not set up correctly.

**System action:** The requested CIM operation is returned in error. If the failure occurred while performing a set problem tracking number or set PMR number operation, the function will end without having updated the value.

**System programmer response:**

- Verify that the sysplex dump directory exists and is usable. Default name is SYS1.DDIR.
- For more information, see the topic on troubleshooting problems in *IBM z/OS Management Facility User's Guide*.
- If you still encounter a problem, contact IBM Service for assistance.

**User response:** Report this problem to your system programmer.

---

**CEZ05017E IPCS Sysplex Dump Directory busy. Please try request again.**

**Explanation:** A CIM method was invoked to locate incident information, but the Common Event Adapter (CEA) experienced an ENQ Problem when accessing the Sysplex Dump Directory (SYS1.DDIR). A possible cause is that a job or IPCS user is accessing SYS1.DDIR while CEA is attempting to access it.

**System action:** The requested CIM operation is returned in error.

**System programmer response:** Ensure that no other users are attempting to access the sysplex dump directory at the same time by checking for an exclusive ENQ on SYS1.DDIR (using D GRS). If so, consider cancelling the suspect user or job.

**User response:** Report this problem to your system programmer.

---

**CEZ10000E Unable to obtain a passticket for GPMSERVE. RACF permissions probably missing.**

**Explanation:** The Monitoring providers were unable to obtain a valid passticket for the application GPMSERVE (RMF Distributed Data Server).

**System action:** The CIM request is not processed.

**System programmer response:** Make sure that the RMF Distributed Data Server is set up for accepting PassTickets as described in *z/OS RMF User's Guide*.

**User response:** Contact your system programmer.

---

**CEZ10001E Unable to connect to GPMSERVE.**

**Explanation:** The Monitoring providers were unable to connect to the application GPMSERVE (RMF Distributed Data Server).

---

## CFZ-prefix messages

---

**CFZ00409E Bind failed: *subsequent message*.**

**Explanation:** The CIM server is unable to bind the socket.

**System action:** None.

**System programmer response:** The reason for the bind failure is described in the *subsequent message*.

**User response:** Report this problem to your system programmer.

---

**CFZ02202W Property value is not valid: *name=value***

**Explanation:** The value that was specified for the configuration property is not valid. See Chapter 9, "CIM server configuration," on page 55 for the correct values of configuration properties.

**System action:** None.

**System programmer response:** None.

**User response:** Re-enter the command specifying a correct value for the configuration property.

---

**CFZ02207W The configuration property *name* is not dynamic.**

**Explanation:** The configuration property *name* cannot be changed dynamically for a running CIM server. Instead the change has to be made as a planned value to become effective after a CIM server restart. See "cimconfig" on page 83 or "MODIFY console command" on page 117 for details on how to change planned values.

**System action:** None.

**System programmer response:** None.

**User response:** Change the planned configuration value and restart the CIM server.

---

**CFZ02300I Configuration property *conf-property* is not supported. Setting ignored.**

**Explanation:** The mentioned configuration property is no longer supported.

---

**System action:** The CIM request is not processed.

**System programmer response:** Either start the GPMSERVE application or disable the Monitoring providers by setting the environment variable RMF\_CIM\_PROVIDER=DISABLE.

**User response:** Contact your system programmer.

---

**System action:** The CIM server ignores this setting and continues.

**System programmer response:** Please remove the mentioned configuration property from the planned configuration of the CIM server's */etc/wbem/cimserver\_planned.conf*.

**User response:** None.

---

**CFZ03029E Unsupported *UserContext* value: "*value*".**

**Explanation:** A provider module was registered with a *UserContext* value of *value*, but that value is not supported by this version of the CIM server. Valid values are 2 for "Requestor" and 3 for "Designated User".

**System action:** The provider module is not registered.

**System programmer response:** Check the provider registration MOF and replace the invalid *UserContext* value with a value that is valid on z/OS.

**User response:** Contact your system programmer.

---

**CFZ03030E Missing *DesignatedUserContext* property in PG\_ProviderModule instance.**

**Explanation:** A provider module was registered with a *UserContext* value of 3 ("Designated User"). The user ID of the designated user has to be specified in *DesignatedUserContext*, but no value was found (see "PG\_ProviderModule" on page 297).

**System action:** The provider module is not registered.

**System programmer response:** Check the provider registration MOF and add a valid user ID for the *DesignatedUserContext* property to all provider modules that are registered with a *UserContext* value of 3.

**User response:** Contact your system programmer.

---

**CFZ05000E A system error occurred. Retry the CIM operation at a later time.**

**Explanation:** A CIM-XML operation exceeds the server's memory.

**System action:** Stop the CIM-XML operation.

---

**System programmer response:** Look for message CFZ08101E identifying the source of the CIM-XML request. Contact the owner of the application issuing the request and analyze the reason for the size of the operation. Limit the result objects for this request. Restart the server to clean it up.

**User response:** Contact your system programmer.

---

**CFZ05203W The user *user-ID* is not authorized to run operation in the namespace *namespace*.**

**Explanation:** The user ID that invoked CIM operation *operation* is not authorized to run this operation in namespace *namespace* of the CIM server.

**System action:** The CIM request is denied.

**System programmer response:** Check the system console for further detailed error messages that indicate which authorization is missing for user *user-ID*. In most cases, the user has no UPDATE authority for profile CIMSERV in class WBEM.

**User response:** Contact your system administrator for obtaining the required level of authorization.

---

**CFZ06201W Command not recognized by CIM server.**

**Explanation:** The command that was entered in the system console is not supported by the CIM server.

**System action:** None.

**System programmer response:** None.

**User response:** None.

---

**CFZ06202I STOP command received from z/OS console, initiating shutdown.**

**Explanation:** The CIM server received the STOP command from the console.

**System action:** The CIM server is shutting down.

**System programmer response:** None.

**User response:** None.

---

**CFZ06203E CIM server Console command thread cannot be created: *error-text* (errno *error-number*, reason code *X'reason-code'*).**

**Explanation:** The CIM server cannot start the thread handling commands issued at the console. For a description of error *error-text* with error number *error-number* and the last four digits of the reason code *X'reason-code'*, see *z/OS UNIX System Services Messages and Codes*, or enter the reason code in the BPXMTEXT TSO command.

**System action:** None.

**System programmer response:** The CIM server cannot

be stopped using the console command. To stop the CIM server, purge the address space or use a privileged UNIX user ID to issue the command `cimserver -s` from the UNIX System Services command prompt.

**User response:** Contact your system programmer.

---

**CFZ06204E Console Communication Service failed: *error-text* (errno *error-number*, reason code *X'reason-code'*).**

**Explanation:** The CIM server is connected to the system console by using the Console Communication Service. The CIM server received the unrecoverable error *error-text*. For a description of error *error-text* with errno *error-number* and the last four digits of the reason code *X'reason-code'*, see *z/OS UNIX System Services Messages and Codes*, or enter the reason code in the BPXMTEXT TSO command.

**System action:** CIM server shuts down.

**System programmer response:** Errno *error-number* and the last four digits of the reason code *X'reason-code'* point out the reason for the error. Check the console for more messages indicating the problem.

**User response:** None.

---

**CFZ06205E CIM MODIFY command rejected due to syntax error.**

**Explanation:** A MODIFY command was entered for the CIM server that could not be recognized due to invalid syntax.

**System action:** None.

**System programmer response:** None.

**User response:** Enter the command with the correct syntax.

---

**CFZ06206I Syntax is: MODIFY  
CFZCIM,APPL=CONFIG,  
*name=value*,PLANNED]**

**Explanation:** This messages describes the expected format for CIM server MODIFY command.

**System action:** None.

**System programmer response:** None.

**User response:** None.

---

**CFZ06207E Failed to update configuration value.**

**Explanation:** The CIM server failed to update a configuration value that was entered through the system console.

**System action:** None.

**System programmer response:** Look for other messages indicating the problem.

**User response:** Look for other messages indicating the problem.

---

**CFZ06208I Updated current value for *name* to *value*.**

**Explanation:** A configuration value for a running CIM server has immediately been updated. The changed value will stay in effect as long as the CIM server is running. After a restart the value is reset to either the default or to the planned configuration value.

**System action:** The change requested by the MODIFY command is now in effect.

**System programmer response:** None.

**User response:** None.

---

**CFZ06209I Updated planned value for *name* to *value*.**

**Explanation:** A configuration value has been updated for the planned configuration of the CIM server. It will become active after the CIM server is restarted. This change is persistent until the planned value is changed again.

**System action:** The change requested by the MODIFY command becomes effective after the next CIM server restart.

**System programmer response:** None.

**User response:** None.

---

**CFZ06210I This change will become effective after CIM server restart.**

**Explanation:** The change requested by the MODIFY command will not be in effect until the CIM server is restarted.

**System action:** None.

**System programmer response:** None.

**User response:** None.

---

**CFZ06211E MODIFY command failed: *message***

**Explanation:** A configuration update requested through the MODIFY command failed. The detailed cause is indicated by *message*.

**System action:** None.

**System programmer response:** None.

**User response:** None.

---

**CFZ06212E *name* is not a valid configuration property.**

**Explanation:** The configuration property *name* is not recognized by the CIM server as a valid configuration property.

**System action:** None.

**System programmer response:** None.

**User response:** Use the correct name for the configuration property and enter the command again.

---

**CFZ06213I List of CIM server environment variables: *variable-list***

**Explanation:** When you have issued the MODIFY APPL=ENV command, this message displays the current list of all environment variables that are active for the CIM server address space along with their current values.

**System action:** None.

**System programmer response:** None.

**User response:** None.

---

**CFZ06214I *variable-name=value***

**Explanation:** When you have issued the MODIFY APPL=ENV,*variable-name* command, this message displays the current value of the environment variable specified by *variable-name*.

**System action:** None.

**System programmer response:** None.

**User response:** None.

---

**CFZ06215E Variable "*variable-name*" is undefined**

**Explanation:** When you have issued the MODIFY APPL=ENV,*variable-name* command, this message indicates that no environment variable with the name *variable-name* is defined in the CIM server address space.

**System action:** None.

**System programmer response:** None.

**User response:** None.

---

**CFZ07801E CIM HTTP or HTTPS connection failed to create the socket.**

**Explanation:** The CIM server was unable to create a socket.

**System action:** None.

**System programmer response:** Check the PORT and PORTANGE statements in the PROFILE.TCPIP configuration file to ensure that the ports specified by the *httpPort* and *httpsPort* CIM server configuration properties are accessible by the CIM server. Check the security product configuration to ensure that the CIM server is able to access the ports specified by the *httpPort* and *httpsPort* CIM server configuration properties.

For example, OEM security product ACF2 may require "Stack & Port security authorization" for the CIM server. Use the TCP/IP NETSTAT ALLCONN PORT command to check for servers using the ports specified by the *httpPort* and *httpsPort* CIM server configuration properties.

Example:

```
TSO NETSTAT ALLCONN (PORT 5988
```

**User response:** Report this problem to your system programmer.

---

**CFZ07805E Failed to bind socket on port**  
*port-number: error-text (error code*  
*error-code, reason code 0xreason-code).*

**Explanation:** Before listening on network port *port-number* the CIM server failed to bind the socket with *error-code* and *0xreason-code*. It therefore will not be able to communicate over this network port. Probably the port is already in use by another program or has been reserved by the TCP/IP configuration.

**System action:** The CIM server does not start.

**System programmer response:** Error code *error-code* and the last four digits of the reason code *0xreason-code* point out the reason for the error.

For a description of error *error-text* with error code *error-code* and the last four digits of the reason code *0xreason-code*, see *z/OS UNIX System Services Messages and Codes*, or enter the reason code in the BPXMTEXT TSO command.

**User response:** None.

---

**CFZ07806E Failed to set permission on local domain socket**  
*socket: error-text (error code*  
*error-code, reason code 0xreason-code).*

**Explanation:** The CIM server is not able to set the permission on socket file *socket* for local communication.

**System action:** The CIM server does not start.

**System programmer response:** Error code *error-code* and the last four digits of the reason code *0xreason-code* point out the reason for the error. For a description of error *error-text* with error code *error-code* and the last four digits of the reason code *0xreason-code*, see *z/OS UNIX System Services Messages and Codes*, or enter the reason code in the BPXMTEXT TSO command.

**User response:** None.

---

**CFZ07807E Failed to listen on socket**  
*socket-number: error-text (error code error-code, reason*  
*code 0xreason-code).*

**Explanation:** The CIM server failed to listen on socket *socket-number*. It therefore will not be able to communicate over this network port. Probably the port

is already in use by another program or has been reserved by the TCP/IP configuration.

**System action:** The CIM server does not start.

**System programmer response:** Error code *error-code* and the last four digits of the reason code *0xreason-code* point out the reason for the error. For a description of error *error-text* with error code *error-code* and the last four digits of the reason code *0xreason-code*, see *z/OS UNIX System Services Messages and Codes*, or enter the reason code in the BPXMTEXT TSO command.

**User response:** None.

---

**CFZ08001W CIM HTTP or HTTPS connector cannot connect to host:port. Connection failed.**

**Explanation:** The CIM server or a CIM client could not connect to a CIM indication listener or CIM server on *host:port*.

**System action:** None.

**System programmer response:** None.

**User response:** Check that the target of the connection is a valid hostname, IP connectivity exists to that host and that a CIM indication listener or a CIM server is listening on *port* of the target system.

---

**CFZ08101E Internal server error. Connection with IP address IP-address closed.**

**Explanation:** An unrecoverable error occurred during the communication with the client connected by *IP-address*.

**System action:** The connection is closed.

**System programmer response:** This message provides the affected IP address. Look for a previous CFZ message describing details of the internal error.

**User response:** Contact your system programmer.

---

**CFZ09100I TCP/IP temporary unavailable.**

**Explanation:** The TCP/IP stack used by the CIM server is not available.

**System action:** The CIM server is waiting for a restart of the TCP/IP stack. The CIM server will be not able to handle any commands and requests until the restart of the TCP/IP stack has completed. Currently processed requests are terminated.

**System programmer response:** Restart the TCP/IP stack the CIM server was using. If this stack is no longer used, restart the CIM server.

**User response:** None.



---

**CFZ10024I** Unable to start the CIM server. CIM server is already running.

**Explanation:** The CIM server detects that another instance of the CIM server is already running. There can be only one running CIM server.

**System action:** None.

**System programmer response:** Do not start the CIM server again. If you want to start a new CIM server on the system, use the stop command at the system console (/p cfz cim ) or look for the CIM server running in the UNIX System Services (/d omvs,a=all ) and cancel the process (/c cfz cim).

**User response:** None.

---

**CFZ10025I** The CIM server is listening on HTTP port *port-number*.

**Explanation:** The CIM server is starting up and will listen on port *port-number* for incoming requests from clients. For information about how to configure the CIM server's HTTP connections see Chapter 9, "CIM server configuration," on page 55.

**System action:** None.

**System programmer response:** None.

**User response:** None.

---

**CFZ10026I** The CIM server is listening on HTTPS port *port-number*.

**Explanation:** The CIM server is starting up and will listen on port *port-number* for incoming requests from clients using SSL encryption. Please note that special TCP/IP configuration settings are required for enabling the CIM server to support SSL encryption for HTTPS. For information about how to configure the CIM server's HTTPS connections see "Configuring the CIM server HTTPS connection using AT-TLS" on page 29.

**System action:** None.

**System programmer response:** None.

**User response:** None.

---

**CFZ10028I** The CIM server is listening on the local connection socket.

**Explanation:** The CIM server is starting up and will listen for incoming requests from clients. For information about how to configure the CIM server's HTTP connections see Chapter 9, "CIM server configuration," on page 55.

**System action:** None.

**System programmer response:** None.

**User response:** None.

---

**CFZ10030I** Started CIM server version *version*.

**Explanation:** The CIM server is now started and accepts CIM client requests.

**System action:** None.

**System programmer response:** None.

**User response:** None.

---

**CFZ10031I** CIM server - stopped.

**Explanation:** The CIM server is now stopped. CIM client requests are no longer accepted.

**System action:** None.

**System programmer response:** None.

**User response:** None.

---

**CFZ10033E** The CIM server is not started: *subsequent message*.

**Explanation:** The CIM server was not started due to an error condition described in *subsequent message*.

**System action:** The CIM server is not started.

**System programmer response:** See the error condition as described in the *subsequent message*.

**User response:** Report this problem to your system programmer.

---

**CFZ10034E** CIM server repository contains files with wrong tags. Unable to set file tags. Stopping CIM server startup.

**Explanation:** The CIM server repository contains files tagged with the wrong CCSID. The CIM server tried to set the right CCSID (ISO8859-1) tag on this file, but was not successful.

**System action:** The CIM server stops.

**System programmer response:** Look for previously issued messages (CFZ10035E or equivalent LE messages) about access violations for path */var/wbem*. Grant the denied access right to the user ID running the CIM server. Restart the CIM server.

**User response:** None.

---

**CFZ10035E** Failed to change file tag for *file-name*. Error (*error-number*): *error-message*.

**Explanation:** The CIM server is not able to change the file tag for the file *file-name*. For the reason, see the system error number *error-number* and the system error message *error-message*.

**System action:** The CIM server stops.

**System programmer response:** Correct the reason for failing to change the file tag. The reason is indicated by

the system error number *error-number* and the system error message *error-message*.

**User response:** None.

---

**CFZ10036W CIM server repaired file tags for *number* repository files.**

**Explanation:** The CIM server was able to restore the correct CCSID (ISO8859-1) file tag for a number of *number* repository files.

**System action:** None.

**System programmer response:** Repository file tags were missing or wrong. Please revise procedures handling files located in */var/wbem* to preserve file tags. If file tags are preserved, this message will not be displayed again.

**User response:** None.

---

**CFZ10037E Failed to open repository directory *repository-directory*: *error-text* (error code *error-code*, reason code *0xreason-code*).**

**Explanation:** The CIM server is not able to open the directory *repository-directory* containing the repository.

**System action:** The CIM server does not start.

**System programmer response:** Error code *error-code* and the last four digits of the reason code *0xreason-code* point out the reason for the error. For a description of error *error-text* with error code *error-code* and the last four digits of the reason code *0xreason-code*, see *z/OS UNIX System Services Messages and Codes*, or enter the reason code in the BPXMTEXT TSO command.

**User response:** None.

---

**CFZ10206W No providers accepted the subscription.**

**Explanation:** The subscription request for a CIM indication failed because there is no CIM indication provider that accepts the query contained in the indication filter. Either the filter contains an invalid or unsupported query, or an error has occurred during subscription processing.

**System action:** The indication subscription fails and the subscription is not persistent on the CIM server.

**System programmer response:** Check the z/OS console for other error messages that indicate the cause of the subscription failure.

**User response:** Check the query in the indication filter and make sure this query is supported by the target CIM server. If the problem persists contact the system programmer of the target system.

---

**CFZ10215W Subscription (*name*) in namespace *namespace* has no provider.**

**Explanation:** During startup the CIM server has failed to re-establish a persistent CIM indication subscription because there is no CIM indication provider that accepts the query contained in the indication filter. Either the filter contains an invalid or unsupported query, or an error has occurred during subscription processing.

**System action:** The subscription *name* is inactive.

**System programmer response:** Check the z/OS console for other error messages that indicate the cause of the subscription failure. Correct the error(s) and then restart the CIM server.

**User response:** None.

---

**CFZ10405W Failed to deliver an indication: *message-details***

**Explanation:** The CIM server was unable to deliver a CIM indication to a subscribed indication listener. See *message-details* for the potential cause.

**System action:** The CIM indication is not delivered and discarded.

**System programmer response:** Ensure the destination system of the indication subscription is available and reachable. To remove obsolete indication subscriptions use the *cimsub* command (see "cimsub" on page 114).

**User response:** None.

---

**CFZ12500E Not loading dynamic load library *library-name* due to missing program control flag.**

**Explanation:** The CIM server runs on a system with Enhanced Security and thus does not load dynamic libraries which are not audited by a system programmer.

**System action:** The system does not load the named dynamic library.

**System programmer response:** Set the program control flag on the dynamic library using the UNIX System Services command *extattr +p <filename>*.

**User response:** Contact a system programmer to audit the dynamic library and set the program control flag.

---

**CFZ12501E Security profile CIMSERV in CLASS WBEM must be defined. Ending CIM server.**

**Explanation:** The CIM server detected an incomplete security setup.

**System action:** The CIM server does not start.

**System programmer response:** Complete the security

setup by defining the profile CIMSERV in class WBEM. Refer to Chapter 6, "CIM server security setup," on page 23 for further details.

**User response:** Contact your system programmer.

---

**CFZ12502E CIM server user ID requires either READ access to BPX.SERVER or must be UID 0. Ending CIM server.**

**Explanation:** The CIM server user ID must have READ access to the security profile BPX.SERVER, or, if BPX.SERVER is not defined on your system, must be a privileged user.

**System action:** The CIM server stops.

**System programmer response:** Permit the user ID to run the CIM server by either giving it READ access to profile BPX.SERVER, or, if not running in an Enhanced Security environment, set the UID to 0.

**User response:** Contact your system programmer.

---

**CFZ12503E CIM server address space dirty due to loading from a not program controlled load library. Ending CIM server.**

**Explanation:** The CIM server loaded a dynamic library that is not program controlled. Either the security setup is not complete or a dynamic library has been changed without a system programmer's audit.

**System action:** The CIM server stops.

**Programmer response:** Check all dynamic libraries for their program control flag and ensure that no library changed. Make sure that the Language Environment libraries SCEERUN and SCEERUN2 are program controlled.

**User response:** Contact your system programmer.

---

**CFZ12504E CIM server does not have appropriate privileges to check SAF security environment. Ending CIM server.**

**Explanation:** The CIM server user ID must have READ access to the security profile BPX.SERVER, or, if BPX.SERVER is not defined on your system, must be privileged.

**System action:** The CIM server stops.

**System programmer response:** Permit the user ID to run the CIM server by either giving it READ access to profile BPX.SERVER, or, if not running in an Enhanced Security environment, set the UID to 0.

**User response:** Contact your system programmer.

---

**CFZ12505E CIM server user ID requires either READ access to BPX.SERVER or must be UID 0. Ending CIM server.**

**Explanation:** The CIM server user ID must have READ access to the security profile BPX.SERVER, or, if BPX.SERVER is not defined on your system, must be privileged.

**System action:** The CIM server stops.

**System programmer response:** Permit the user ID to run the CIM server by either giving it READ access to profile BPX.SERVER, or, if not running in an Enhanced Security environment, set the UID to 0.

**User response:** Contact your system programmer.

---

**CFZ12506E CIM server address space dirty due loading from a not program controlled load library. Ending CIM server.**

**Explanation:** The CIM server has loaded a dynamic library that is not program controlled. Either the security setup is not complete or a dynamic library has been changed without a system programmer's audit.

**System action:** The CIM server stops.

**Programmer response:** Check all dynamic libraries for their program control flag and ensure that no library has changed. Make sure the Language Environment libraries SCEERUN and SCEERUN2 are program controlled.

**User response:** Contact your system programmer.

---

**CFZ12507W CIM server does not have surrogate for client user ID *user-ID*.**

**Explanation:** A request sent from the user ID could not be processed. The CIM server does not have access to act as surrogate for the requesting user ID.

**System action:** The user request is ignored and an error message is sent to the client.

**System programmer response:** To permit the CIM server user ID to act as a surrogate for the client user, grant the user ID running the CIM server READ access to the RACF profile BPX.SRV.*user-ID* as described in "Switching identity (surrogate)" on page 29.

**User response:** Contact your system programmer.

---

**CFZ12508W Failure *error-number* deleting thread security.**

**Explanation:** The CIM server was not able to delete the thread level security built for a specific request.

**System action:** None.

**System programmer response:** None.

**User response:** None.

---

**CFZ12509E** The CIM server user ID requires either READ access to BPX.SERVER or must be UID 0. Stopping CIM server startup.

**Explanation:** The user ID that starts the CIM server must have READ access to the security profile BPX.SERVER, or, if BPX.SERVER is not defined on your system, must be a privileged user.

**System action:** The CIM server does not start.

**System programmer response:** Permit the user ID to run the CIM server by either giving it READ access to profile BPX.SERVER, or, if not running in an Enhanced Security environment, set the UID to 0.

**User response:** Contact your system programmer.

---

**CFZ12510E** CIM server address space dirty due to loading from a not program controlled load library. Stopping CIM server startup.

**Explanation:** The CIM server loaded a dynamic library that is not program controlled during startup. Probably the security setup is not complete or a dynamic library has been changed without a system programmer's audit.

**System action:** The CIM server does not start.

**Programmer response:** Check all dynamic libraries for their program control flag and ensure that no library changed. Make sure the Language Environment libraries SCEERUN and SCEERUN2 are program controlled.

**User response:** Contact your system programmer.

---

**CFZ12511E** CIM server does not have appropriate privileges to check SAF security environment. Stopping CIM server startup.

**Explanation:** The user ID that starts the CIM server must have READ access to the security profile BPX.SERVER, or, if BPX.SERVER is not defined on your system, must be a privileged user.

**System action:** The CIM server does not start.

**System programmer response:** Permit the user ID to run the CIM server by either giving it READ access to profile BPX.SERVER, or, if not running in an Enhanced Security environment, set the UID to 0.

**User response:** Contact your system programmer.

---

**CFZ12512E** Security profile CIMSERV in CLASS WBEM must be defined. Stopping CIM server startup.

**Explanation:** The CIM server detected an incomplete security setup on startup.

**System action:** The CIM server does not start.

**System programmer response:** To complete the security setup, define the profile CIMSERV in class WBEM. Refer to Chapter 6, "CIM server security setup," on page 23 for further details.

**User response:** Contact your system programmer.

---

**CFZ12513E** The CIM server user ID requires CONTROL access to security profile CIMSERV in CLASS WBEM. Stopping CIM server startup.

**Explanation:** The CIM server user ID requires CONTROL access to security profile CIMSERV in CLASS WBEM.

**System action:** The CIM server does not start.

**System programmer response:** To permit the CIM server user ID to perform administrative CIM tasks, give it CONTROL permission to profile CIMSERV in class WBEM. Refer to Chapter 6, "CIM server security setup," on page 23 for further details.

**User response:** Contact your system programmer.

---

**CFZ12514E** Security profile *profile-name* in CLASS WBEM must be defined.

**Explanation:** A provider defined a security profile at registration that is not defined for RACF class WBEM.

**System action:** None.

**System programmer response:** Create the RACF profile in class WBEM and permit users who should have access to the provider. Verify if the security profile is defined for RACF and make sure that the class WBEM has been refreshed. Verify if the provider really should be registered with the mentioned security profile and if it should be checked.

**User response:** Contact your system programmer.

---

**CFZ12515W** User *user-ID* not authorized to perform intrinsic CIM operation *operation* against provider *provider-name*. *access-type* access to *profile-name* in CLASS WBEM required.

**Explanation:** User *user-ID* is not authorized to perform CIM operation *operation* involving the provider *provider-name*. The user needs *access-type* access to SAF security profile *profile-name* that is defined in class WBEM.

**System action:** The request is not processed and an "Access Denied" notification is sent to the client.

**System programmer response:** Verify if the user should be permitted to perform the current request. If so, grant the user *access-type* access to the profile *profile-name*.

**User response:** None. Access has been denied to a

user with insufficient authority.

---

**CFZ12516E** CIM server does not have appropriate privileges to check SAF security environment. Ending CIM server.

**Explanation:** The CIM server user ID must have READ access to the security profile BPX.SERVER, or, if BPX.SERVER is not defined on your system, must be a privileged user.

**System action:** The CIM server stops.

**System programmer response:** Permit the user ID to run the CIM server by either giving it READ access to profile BPX.SERVER, or, if not running in an Enhanced Security environment, set the UID to 0.

**User response:** None.

---

**CFZ12517E** Missing IdentityContainer (no username) in request.

**Explanation:** The security component of the CIM server detected an invalid operation context that does not contain a username.

**System action:** The request is not processed and an "Access Denied" notification is sent to the client.

**System programmer response:** None.

**User response:** None.

---

**CFZ12519E** An unexpected error occurs: *error-text* (error number *error-number*, reason code *0xreason-code*). Stopping CIM server startup.

**Explanation:** During startup, the CIM server received the unrecoverable error *error-text*. For a description of error *error-text* with error number *error-number* and the last four digits of the reason code *0xreason-code*, see *z/OS UNIX System Services Messages and Codes*, or enter the reason code in the BPXMTEXT TSO command.

**System action:** The CIM server does not start.

**System programmer response:** Error number *error-number* and the last four digits of the reason code *0xreason-code* point out the reason for the error. Check the console for more messages indicating the problem.

**User response:** Contact your system programmer.

---

**CFZ12520E** CIM server did not set *Must Stay Clean*. Stopping provider agent startup.

**Explanation:** The provider agent determined that the *Must Stay Clean* flag was not set. The provider agent startup is not processed by the CIM server.

**System action:** The provider agent does not start.

**System programmer response:** Ensure that the provider agent can only be started by the CIM server.

**User response:** Contact your system programmer.

---

**CFZ12521E** An unexpected error occurs: *error-text* (error number *error-number*, reason code *X'reason-code'*). Stopping provider agent startup.

**Explanation:** During startup, the provider agent received the unrecoverable error *error-text*. For a description of error *error-text* with error number *error-number* and the last four digits of the reason code *X'reason-code'*, see *z/OS UNIX System Services Messages and Codes*, or enter the reason code in the BPXMTEXT TSO command.

**System action:** The provider agent does not start.

**System programmer response:** Error number *error-number* and the last four digits of the reason code *X'reason-code'* point out the reason for the error. Check the console for more messages indicating the problem.

**User response:** Contact your system programmer.

---

**CFZ12523E** CIM Runtime Environment user ID requires either READ access to BPX.SERVER or has to be UID 0. Stopping provider agent startup.

**Explanation:** The user ID that runs the provider agent must have READ access to the security profile BPX.SERVER, or, if BPX.SERVER is not defined on your system, must be a privileged user.

**System action:** The provider agent does not start.

**System programmer response:** Permit the user ID to run the CIM server by either giving it READ access to profile BPX.SERVER, or, if not running in an Enhanced Security environment, set the UID to 0.

**User response:** Contact your system programmer.

---

**CFZ12524E** Provider agent address space dirty due to loading from a not program controlled load library. Stopping provider agent startup.

**Explanation:** The provider agent has loaded a dynamic library that is not program controlled. Either the security setup is not complete or a dynamic library has been changed without a system programmer's audit.

**System action:** The provider agent does not start.

**System programmer response:** Check all dynamic libraries for their program control flag and ensure that no library has changed. For details on program control look at *z/OS UNIX System Services Planning* and *z/OS Security Server RACF Security Administrator's Guide*.

**User response:** Contact your system programmer.

---

**CFZ12525E** CIM Runtime Environment does not have appropriate privileges to check SAF security environment. Stopping provider agent startup.

**Explanation:** The user ID that runs the provider agent must have READ access to the security profile BPX.SERVER, or, if BPX.SERVER is not defined on your system, must be a privileged user.

**System action:** The provider agent does not start.

**System programmer response:** Permit the user ID to run the provider agent by either giving it READ access to profile BPX.SERVER, or, if not running in an Enhanced Security environment, set the UID to 0.

**User response:** Contact your system programmer.

---

**CFZ12526E** Unsupported *UserContext* value: "value".

**Explanation:** A provider module was registered with a *UserContext* value of *value*, but that value is not supported by this version of the CIM server. Valid values are 2 ("Requestor") and 3 ("Designated User").

**System action:** The addressed provider module is not correctly registered. The request fails and an error is sent back to the requestor.

**System programmer response:** Identify the failing provider module, remove the provider using the *cimprovider* utility (see "cimprovider" on page 85) and re-register the provider with a correct provider registration MOF.

**User response:** Contact your system programmer.

---

**CFZ12527E** Missing *DesignatedUserContext* property in PG\_ProviderModule instance.

**Explanation:** A provider module was registered with a *UserContext* value of 3 ("Designated User"). The user ID of the designated user has to be specified in *DesignatedUserContext*, but no value was found (see "PG\_ProviderModule" on page 297).

**System action:** The request that is directed against the provider module in error will fail and an error is sent back to the requestor.

**System programmer response:** Identify the failing provider module, remove the provider using the *cimprovider* utility (see "cimprovider" on page 85) and re-register the provider with a correct provider registration MOF.

**User response:** Contact your system programmer.

---

**CFZ12528I** Cannot switch to designated user *user-ID*. User is unknown to the security product, or has no OMVS segment.

**Explanation:** The CIM server failed to switch the security context to *user-ID* for a provider configured

with a designated user context. The user *user-ID* defined for the provider's security context is not defined to the system or does not have an OMVS segment.

**System action:** The request fails and an authorization error is sent back to the requestor/client.

**System programmer response:** Check if the user *user-ID* is the right user ID to run with or check for the existence of the user *user-ID* within your security product with the appropriate OMVS segment. If the problem persists you may want to remove the failing provider using the *cimprovider* utility and re-register the provider with the correct designated user defined in the provider registration MOF.

**User response:** None.

---

**CFZ12529E** An unexpected error occurred when switching to user *user-ID*: error-text (error code *error-code* , reason code *0xreason-code*).

**Explanation:** The CIM server failed to switch to *user-ID* for the designated user context of a provider.

**System action:** The request fails and an authorization error is sent back to the requestor/client.

**System programmer response:** Error code *error-code* and the last four digits of the reason code *0xreason-code* point out the reason for the error. For a description of error *error-text* with error code *error-code* and the last four digits of the reason code *0xreason-code*, see *z/OS UNIX System Services Messages and Codes*, or enter the reason code in the BPXMTEXT TSO command.

**User response:** None.

---

**CFZ12530E** Cannot switch to user *user-ID* because a SAF authorization error occurred. For the reason, see the SAF RACROUTE EXTRACT service reason code *reason-code*.

**Explanation:** A SAF authorization error has occurred. The message returns the SAF specific reason code. For RACF, the two rightmost bytes contain the RACF return code and the RACF reason code.

Example: For reason code 0x0BE80820, the RACF return code is 08 and the RACF reason code is 20.

**System action:** The CIM server terminates the user request.

**System programmer response:** Use the reason-code for your SAF RACROUTE EXTRACT service to find more details to resolve the authorization error.

For RACF: For details of the authorization error, use the RACF return code and reason code. See the *z/OS UNIX System Services Programming: Assembler Callable Services Reference* , table "RACF return and reason

codes", for the specific reason of the failure.

**User response:** Report this problem to your system programmer.

---

**CFZ12531E** User *user-ID* is not authorized to shut down the CIM server. RC=*returncode*  
RSN=*reasoncode*

**Explanation:** The attempt of user *user-ID* to shut down the CIM server has failed because the user does not have the required permissions.

Shutting down the CIM server requires CONTROL access to the CIMSERV profile in class WBEM. For information about other required but missing permissions, use the bpxmtext command along with the *reasoncode*.

**System action:** The CIM server is not stopped

**System programmer response:** None.

**User response:** Obtain the required permissions or use a different user ID.

---

**CFZ12532I** CIM server successfully registered to ARM using element name  
CFZ\_SRV\_*system-name*.

**Explanation:** The CIM server successfully registered to the Automatic Restart Manager.

**System action:** None.

**System programmer response:** None.

**User response:** None.

---

**CFZ12533I** CIM server failed to register with ARM using element name  
CFZ\_SRV\_*system-name*: return code  
*X'error-number'*, reason code *X'reason-code'*.

**Explanation:** The CIM server failed to register with the Automatic Restart Manager using the element name CFZ\_SRV\_*system-name*.

**System action:** None.

**System programmer response:** If you do not want to use the Automatic Restart Manager, you can ignore this message. If you want to use ARM, use *X'error-number'* and *X'reason-code'* to look up the return and reason codes for the IXCARM macro in the *z/OS MVS Programming: Sysplex Services Reference* for the reason to fail to register with ARM.

**User response:** None.

---

**CFZ12534W** Authorization failed: User ID *user-ID* does not have CONTROL permission to profile CIMSERV CL(WBEM).

**Explanation:** The user ID requesting an administrative task, for example, cimconfig or cimprovider, does not

have the required permission.

**System action:** The request is not processed and an "Access Denied" notification is sent to the client.

**System programmer response:** Permit the user to perform administrative CIM tasks by giving him CONTROL permission to profile CIMSERV in class WBEM.

**User response:** Contact your system programmer.

---

**CFZ12535W** Authorization error: User ID *user-ID* cannot run the requested CIM operation because it lacks UPDATE permission to profile CIMSERV CL(WBEM).

**Explanation:** A client with the named user ID has sent a CIM request for a CIM write operation (SetProperty, InvokeMethod, CreateInstance, ModifyInstance, DeleteInstance) to the CIM server without having the appropriate access rights.

**System action:** The request is not processed and an "Access Denied" notification is sent to the client.

**System programmer response:** None.

**User response:** If you need to perform CIM write operations, ask your system programmer to grant you at least UPDATE access to profile CIMSERV CL(WBEM).

---

**CFZ12540E** ATTLS reset the connection due to handshake failure. Connection closed.

**Explanation:** AT-TLS reset the connection with the client due to a handshake failure.

**System action:** The connection is closed.

**System programmer response:** This message documents an unsuccessful connect to AT-TLS. If this prevents a connection from a client to the server, switch on tracing at the AT-TLS policy to find the reason for this closure.

**User response:** Contact your system programmer.

---

**CFZ12541E** An unexpected error occurs: *error-text* (error number *error-number*, reason code *X'reason-code'*). Connection closed.

**Explanation:** While querying the AT-TLS connection using `ioctl()`, the CIM server received an unknown error. For a description of error *error-text* with error number *error-number* and the last four digits of the reason code *X'reason-code'*, see *z/OS UNIX System Services Messages and Codes*, or enter the reason code in the BPXMTEXT TSO command.

**System action:** The connection is closed.

**System programmer response:** Contact IBM support.

**User response:** Contact your system programmer.

---

**CFZ12542E** ATTLS policy is not active for the CIM server HTTPS port. Communication not secured. Connection closed.

**Explanation:** The CIM server is configured to use HTTPS by defining the configuration property *enableHttpsConnection*, but the AT-TLS policy is not configured correctly for the CIM server.

**System action:** The connection is closed.

**System programmer response:** Please refer to Chapter 6, "CIM server security setup," on page 23 for information about how to configure AT-TLS for the CIM server.

**User response:** Contact your system programmer.

---

**CFZ12543E** ATTLS policy not valid for CIM server. Set *ApplicationControlled* to OFF. Connection closed.

**Explanation:** The value of the property *ApplicationControlled* defined in the AT-TLS policy for the CIM server is ON. Hence, the CIM server is only aware of AT-TLS but does not control it.

**System action:** The connection is closed.

**System programmer response:** Change the property *ApplicationControlled* to OFF in the AT-TLS policy defined for the CIM server. Refer to Chapter 6, "CIM server security setup," on page 23 for information about how to configure AT-TLS for the CIM server.

**User response:** None.

---

**CFZ12544E** ATTLS policy specifies the wrong *HandshakeRole* for the CIM server HTTPS port. Communication not secured. Connection closed.

**Explanation:** The property *HandshakeRole* defined in the inbound AT-TLS policy for the CIM server is not configured correctly.

**System action:** The connection is closed.

**System programmer response:** Change the property *HandshakeRole* to *ServerWithClientAuth* or to the server at the inbound AT-TLS policy defined for the CIM server. Refer to Chapter 6, "CIM server security setup," on page 23 for information about how to configure AT-TLS for the CIM server.

**User response:** None.

---

**CFZ12545E** Automatic repository upgrade failed at step *step-number*. Stopping CIM server startup.

**Explanation:** The CIM server failed to automatically migrate the old repository in */var/wbem* to the new schema level. No actual migration action was run, because the basic setup is not correct.

**System action:** The CIM server does not start.

**System programmer response:** To find out the reason for this error, check the previously issued message. Correct the basic setup and restart the CIM server.

**User response:** None.

---

**CFZ12546E** Automatic repository upgrade failed at step *step-number*. Recovery completed successfully. Stopping CIM server startup.

**Explanation:** The CIM server failed to automatically migrate the old repository in */var/wbem* to the new schema level. Migration started and ran to a certain point. Though they failed, the accomplished migration actions were successfully rolled back.

**System action:** The CIM server does not start.

**System programmer response:** To find out the reason for this error, check the previously issued message. Correct the setup problem and restart the CIM server.

**User response:** Contact your system programmer.

---

**CFZ12547F** Automatic repository upgrade failed at step *step-number*. Recovery failed, manual intervention required. Stopping CIM server startup.

**Explanation:** The CIM server failed to automatically migrate the old repository in */var/wbem* to the new schema level. Migration started and ran into a critical break. The attempt to roll back the taken actions failed. Manual user intervention is required to roll back taken migration actions.

**System action:** The CIM server does not start.

**System programmer response:** To find out the reason for this error, check the previously issued message. fallback the taken migration actions as described in that message. Fix the setup problem and restart the CIM server.

**User response:** None.

---

**CFZ12548E** Failed to initiate command: *command* with error: *error-number*.

**Explanation:** The CIM server failed to automatically migrate the old repository in */var/wbem* to the new schema level. Processing of the named command failed with error *error-number*.

**System action:** The CIM server will roll back already taken migration actions. The CIM server does not start.

**System programmer response:** Investigate why the named command cannot perform successfully. Fix the system setup and restart the CIM server.

You can find further details in *STDERR* and *STDOUT* of the job output.



**User response:** Contact your system programmer.

---

**CFZ12549E** Command *command* failed with status *status-code*.

**Explanation:** The CIM server failed to automatically migrate the old repository in */var/wbem* to the new schema level. The processing of the named command failed with status *status-code*.

**System action:** The CIM server will roll back the already taken migration actions. CIM server does not start.

**System programmer response:** Investigate why the named command cannot perform successfully. Fix the system setup and restart the CIM server.

Further details can be found in STDERR and STDOUT of the job output.

**User response:** Contact your system programmer.

---

**CFZ12550E** Failed to rename directory *source-directory-name* to *target-directory-name* with error: *error-number*.

**Explanation:** The CIM server failed to automatically migrate the old repository in */var/wbem* to the new schema level. Renaming of source directory to target directory failed.

**System action:** The CIM server will roll back already taken migration actions. CIM server does not start.

**System programmer response:** Investigate the reason of the renaming failure. Possible reasons are missing file access rights, a full file system or missing access right to run a program in an extra UNIX System Services address space.

**User response:** Contact your system programmer.

---

**CFZ12551E** Failed to create repository status files with: *error-text*.

**Explanation:** The CIM server failed to write the repository status file while automatically migrating the old repository in */var/wbem* to the new schema level. The migration is nearly complete, but writing the repository status file failed. The repository status file serves to avoid repeated attempts to migrate the repository.

**System action:** A message is logged to the system console. The CIM server startup continues.

**System programmer response:** Either fix the reason for the failed write of the repository status file and stop and restart the CIM server, or copy the file supplied in */usr/lpp/wbem/* to */var/wbem/*.

**User response:** Contact your system programmer.

---

**CFZ12552I** Starting automatic repository upgrade.

**Explanation:** The CIM server will start to migrate the old repository to the new schema level.

**System action:** The CIM server starts to migrate the repository.

**System programmer response:** None.

**User response:** None.

---

**CFZ12554E** Error during automatic repository upgrade. No reference repository found at *directory-name*.

**Explanation:** The CIM server could not locate the new repository at location *directory-name*. No actual migration action was run, because basic setup is not correct.

**System action:** The CIM server does not start.

**System programmer response:** Check the SMP/E installation. Directory and files should have been copied to the named location in the SMP/E APPLY step.

**User response:** Contact your system programmer.

---

**CFZ12555E** Rename of previous repository to *directory-name* failed.

**Explanation:** The CIM server failed to automatically migrate the old repository in */var/wbem* to the new schema level. Even though migration successfully created the new repository, renaming the old repository for backup failed.

**System action:** The CIM server will remove the new repository to roll back the taken migration actions. The CIM server does not start.

**System programmer response:** Investigate why the CIM server was unable to rename the directory */var/wbem/repository* to the directory *directory-name*. Probable causes are insufficient disk space or missing access rights.

**User response:** None.

---

**CFZ12556E** Rename of new repository to *directory-name* failed.

**Explanation:** The CIM server failed to automatically migrate the old repository in */var/wbem* to the new schema level. Even though migration successfully created the new repository and backed up the old repository, renaming the new repository to */var/wbem/repository* failed.

**System action:** The CIM server tries to roll back the taken migration actions and also removes the new repository and renames the backed up version to */var/wbem/repository*.

**System programmer response:** Investigate why the CIM server was unable to rename the directory. Probable reasons are insufficient disk space or missing access rights. If fallback actions fail (indicated by message CFZ12547E), manually remove the directory named */var/wbem/repository\_new* and rename the latest backed up repository version to */var/wbem/repository*.

**User response:** None.

---

**CFZ12557E Failure during automatic repository upgrade. Trying to recover.**

**Explanation:** The CIM server failed to automatically migrate the old repository in */var/wbem* to the new schema level.

**System action:** The CIM server will try to roll back the taken migration actions.

**System programmer response:** Check former and further messages for details and possible required actions.

**User response:** None.

---

**CFZ12558E Failed to remove incomplete new repository at *directory-name*.**

**Explanation:** The CIM server failed to automatically migrate the old repository in */var/wbem* to the new schema level. Removing the new, migrated repository failed.

**System action:** The CIM server does not start.

**System programmer response:** Remove the directory */var/wbem/repository\_new* and its subfolders and files. Check the system log for earlier messages for details on the actual migration step that failed. Fix the situation and restart the CIM server. The most common reason for this problem is insufficient disk space at */var/wbem*.

**User response:** None.

---

**CFZ12559F Failed to restore previous repository on recovery. Manual rename of *source-directory-name* back to *target-directory-name* required!**

**Explanation:** The CIM server tried to roll back the migration actions. Renaming the backed up copy of the old repository to target directory name failed.

**System action:** The CIM server does not start.

**System programmer response:** Rename the source directory to the target directory name. Investigate the reason for the failure of the automatic repository migration by checking the system log for former error messages. Fix the system setup and restart the CIM server.

**User response:** Contact your system programmer.

---

**CFZ12560E Failed to create repository status file *directory-name*. Manual intervention required!**

**Explanation:** The CIM server failed to write the repository status file while automatically migrating the old repository in */var/wbem* to the new schema level. The migration is nearly complete, but writing the repository status file failed. The repository status file serves to avoid repeated tries to migrate the repository.

**System action:** A message is logged to the system console. The CIM server startup continues.

**System programmer response:** Either fix the reason for the failed write of the repository status file and stop and restart the CIM server, or copy the file supplied in */usr/lpp/wbem/* to */var/wbem*.

**User response:** Contact your system programmer.

---

**CFZ12561E Repository in directory *directory-name* is backlevel. Run migration job for repository upgrade.**

**Explanation:** The CIM server failed to automatically migrate the old repository in */var/wbem* to the new schema level. No actual migration action was run, because the basic setup is not correct. The old repository found at *directory-name* is not a z/OS 1.8 level repository.

**System action:** The CIM server does not start.

**System programmer response:** Use migration job CFZRCUST to migrate the repository.

**User response:** Contact your system programmer.

---

**CFZ12562I Previous repository was renamed to *directory-name* for backup and can be removed.**

**Explanation:** The CIM server successfully migrated the old repository to the new schema level. A backup copy of the old repository is stored at *directory-name*. The copy should be backed up and then can be deleted to free up disk space.

**System action:** The CIM server startup continues.

**System programmer response:** You may want to backup the old repository, and delete the copy on hard disk.

**User response:** None.

---

**CFZ12563I Automatic repository upgrade completed successfully.**

**Explanation:** The CIM server successfully migrated the old repository to the new schema level.

**System action:** The CIM server startup continues.

**System programmer response:** None.

---

**User response:** None.

---

**CFZ12564W Failed to obtain information about file system *path-name*. Error: *error-text*.**

**Explanation:** The CIM server failed to determine information about the file system at *path-name*. The cause of the failure was error *error-text*.

**System action:** Automatic repository upgrade continues.

**System programmer response:** None.

**User response:** None.

---

**CFZ12565W File system at *path-name* is smaller than the recommended 102400 KB (100MB).**

**Explanation:** The file system available at *path-name* should be at least 100MB large or be able to extend to that size. The CIM server might run out of space when automatically upgrading the repository.

**System action:** Automatic repository upgrade continues.

**System programmer response:** Make sure that there is enough space for data to be stored in the file system at *path-name*. Recommended is a system specific data set with at least 100MB space mounted at */var/wbem*.

**User response:** None.

---

**CFZ12566W Less free space than 61440 KB (60MB) available on file system *path-name*.**

**Explanation:** The CIM server detected less than 60MB space available in the file system *path-name*. The CIM server might run out of space when automatically upgrading the repository.

**System action:** Automatic repository upgrade continues.

**System programmer response:** Make sure that there is enough space for data to be stored in the file system at *path-name*. Recommended is a system specific data set with at least 60MB space mounted at */var/wbem*.

**User response:** None.

---

**CFZ12568E ATTLS is not active for TCP-IP stack the CIM server is using for HTTPS connections. Communication not secured. Connection closed.**

**Explanation:** The CIM server is configured to use HTTPS by defining the configuration property *enableHttpsConnection*, but the Communication Server Policy Agent was not enabled on the stack the CIM server is using when AT-TLS policy mapping was performed for the connection.

**System action:** The connection is closed.

**System programmer response:** Ensure that Communication Server Policy Agent is configured for the TCP/IP stack the CIM server is listening. Please refer to Chapter 6, "CIM server security setup," on page 23 for information about how to configure AT-TLS for the CIM server.

**User response:** Contact your system programmer.

---

**CFZ12569E There is no ATTLS policy found for the CIM server HTTPS connections. Communication not secured. Connection closed.**

**Explanation:** The CIM server is configured to use HTTPS by defining the configuration property *enableHttpsConnection*, but the Communication Server Policy Agent did not find an AT-TLS policy for the CIM server when AT-TLS policy mapping was performed for the connection.

**System action:** The connection is closed.

**System programmer response:** Ensure that a Communication Server Policy Agent policy is defined for CIM server. Please refer to Chapter 6, "CIM server security setup," on page 23 for information about how to configure AT-TLS for the CIM server.

**User response:** Contact your system programmer.

---

**CFZ12570I Created directory */var/wbem*.**

**Explanation:** CIM server successfully created the directory */var/wbem*.

**System action:** None.

**System programmer response:** None.

**User response:** None.

---

**CFZ12571E Failed to create directory */var/wbem* with error: *error-message*. Stopping CIM server startup.**

**Explanation:** CIM server failed to create the directory */var/wbem* with error *error-message*.

**System action:** The CIM server does not start.

**System programmer response:** Check the system setup for a system-specific data set mounted at path */var/wbem* with 100Mb space. Fix the problem and restart the CIM server.

**User response:** Contact your system programmer.

---

**CFZ12572W Failed to read repository status file: *error-message*.**

**Explanation:** CIM server failed to read information from the repository status file at */var/wbem*.

**System action:** CIM server startup proceeds and the repository is automatically migrated to the latest level

available from `/usr/lpp/wbem`.

**System programmer response:** Check the error condition described by *error-message* and fix the indicated problem in the system setup.

**User response:** Contact your system programmer.

---

**CFZ12574W File *file-name* contains quotes which should be removed. Removing quotes and stopping CIM server startup. Restart the CIM server.**

**Explanation:** CIM server found quote characters in file *file-name*. Quotes can cause environment variable setup problems.

**System action:** CIM server tries to remove all quotes. The CIM server does not start.

**System programmer response:** None.

**User response:** Restart the CIM server.

---

**CFZ12575E Failed to open *file-name* for write with error: *error-message*.**

**Explanation:** CIM server failed to open *file-name* for writing. The reason is named in *error-message*. CIM server found quote characters in the environment variable setup file for the started task procedure. CIM server tried to open the environment variable setup file to remove all quotes.

**System action:** CIM server does not start.

**System programmer response:** Remove all quotes in file *file-name* manually or check the error condition described by *error-message* and fix the indicated problem in the system setup. Restart the CIM server.

**User response:** Contact your system programmer.

---

**CFZ12576F Failed to write all data to *file-name* file.**

**Explanation:** CIM server failed to write to *file-name* for the reason named in *error-message*. CIM server found quote characters in the environment variable setup file for the started task procedure. CIM server tried to write the environment variable setup file with all quote removed, but the file was written partially.

**System action:** CIM server does not start.

**System programmer response:** Check the error condition described by *error-message* and fix the indicated problem in the system setup. Create a new environment variables setup file *file-name* using the default shipped in `/usr/lpp/wbem/install`. Restart the CIM server.

**User response:** Contact your system programmer.

---

**CFZ12577I Successfully removed all quotes from *file-name*.**

**Explanation:** CIM server removed all quote characters from file *file-name*. Quotes can cause environment variable setup problems for the started task procedure. To avoid issues caused by partially setup environment variables the CIM server is stopped and needs to be restarted.

**System action:** CIM server does not start.

**System programmer response:** Restart the CIM server.

**User response:** Restart the CIM server.

---

**CFZ12578W Directory */var/wbem* does not exist. CIM server will create it.**

**Explanation:** On CIM server startup the automated migration procedure detected that path */var/wbem* does not exist.

**System action:** CIM server creates the directory */var/wbem*.

**System programmer response:** None.

**User response:** None.

---

**CFZ12579W Failed switching to zIIP mode, RC=*returncode*. CIM server running on CP.**

**Explanation:** An error occurred when the CIM server process tried to establish eligibility for running on zIIP processors.

**RC=0x00000408 and  
RC=0x00000508**

indicate a problem with the CIM server installation in the z/OS UNIX file system.

**RC=0x00000708**

indicates that CIM server library `libcfzsys.so` located in `/usr/lpp/wbem/lib` is not APF authorized.

**System action:** The CIM server process with all its threads is executing on CP processors.

**System programmer response:** For RC=0x00000708, use the command

```
extattr +a /usr/lpp/wbem/lib/libcfzsys.so
```

to restore the extended attribute to APF authorize the library.

All other return codes indicate a general problem during program execution, please contact IBM for service.

**User response:** Contact your system programmer.

---

---

**CFZ12580I** CIM server running eligible for zIIP.

**Explanation:** CIM server process has successfully established eligibility for running on zIIP processors.

**System action:** The CIM server process with all its threads is executing on zIIP processors.

**System programmer response:** None.

**User response:** None.

---

**CFZ13006W** Request user ID *user-ID* doesn't have READ permission to profile CIMSERV CL(WBEM).

**Explanation:** The user ID requesting a CIM operation using a remote connection is not permitted to use the CIM server.

**System action:** The request is not processed and an "Access Denied" notification is sent to the client.

**System programmer response:** Permit the user to perform CIM requests by giving the user ID READ access to profile CIMSERV CL(WBEM).

**User response:** Contact your system programmer to permit your user ID to perform CIM requests. Repeat your request.

---

**CFZ13007W** Request user ID *user-ID* doesn't have READ permission to profile CIMSERV CL(WBEM).

**Explanation:** The user ID requesting a CIM operation using a local connection is not permitted to use the CIM server.

**System action:** The CIM request is not processed and an "Access Denied" notification is sent to the client.

**System programmer response:** Permit the user to perform CIM requests by giving the user ID READ access to profile CIMSERV CL(WBEM).

**User response:** Contact your system programmer to permit your user ID to perform CIM requests. Repeat your request.

---

**CFZ13607E** CIM server cannot execute out-of-process provider agent: *error-text* (error number *error-number*, reason code *X'reason-code'*).

**Explanation:** The CIM server failed to process the out-of-process provider agent caused by the problem *error-text*. For further details, see the description of error number *error-number* and the last four digits of the reason code *X'reason-code'* in *z/OS UNIX System Services Messages and Codes*.

**System action:** None.

**System programmer response:** Stop the CIM server. Error number *error-number* and the last four digits of

the reason code *X'reason-code'* point out the reason for the error. Check the console for more messages indicating the problem.

**User response:** Contact your system programmer.

---

**CFZ17200W** Authentication failed for user *user-ID*.

**Explanation:** The authentication for user *user-ID* against the z/OS system failed. Either the user ID or password contained in a request was invalid or revoked, or the user ID has not been authorized to use CIM.

**System action:** The CIM request is denied.

**System programmer response:** None.

**User response:** Check that you are using a valid user ID and password and that the user ID has been authorized to use CIM. If the problem persists, contact the system programmer of the target system to check for more detailed authentication error messages on the system console.

---

**CFZ17201W** Authentication failed for user *user-ID* because *enableRemotePrivilegedUserAccess* is not set to true.

**Explanation:** The CIM server refused login for user *user-ID*, because *user-ID* is a superuser (UID=0), and the current CIM server configuration prohibits superuser logins (the configuration option *enableRemotePrivilegedUserAccess* is false).

**System action:** The CIM request is denied.

**System programmer response:** To allow superuser logon to the CIM server set the *enableRemotePrivilegedUserAccess* configuration option to true, as described in Chapter 9, "CIM server configuration," on page 55.

**User response:** Either use a non-superuser user ID for logon to the CIM server, or contact your system administrator to enable superuser login for the CIM server.

---

**CFZ17202W** Request user ID *user-ID* doesn't have READ permission to profile CIMSERV CL(WBEM).

**Explanation:** The user ID requesting a CIM operation using a remote connection is not permitted to use the CIM server.

**System action:** The request is not processed and an "Access Denied" notification is sent to the client.

**System programmer response:** Permit the user to perform CIM requests by giving the user READ access to profile CIMSERV CL(WBEM).

**User response:** Contact your system programmer to

permit your user ID to perform CIM requests and afterwards repeat your request.

---

**CFZ17203W Request user ID *user-ID* misses password.**

**Explanation:** A request was sent to the CIM server with user *user-ID* but no password was specified.

**System action:** The request is rejected as unauthorized.

**System programmer response:** None.

**User response:** Specify a password with your request.

---

**CFZ17204I CIM server authentication is using application ID OMVSAPPL.**

**Explanation:** The CIM server is using the application ID 'OMVSAPPL' for authentication.

**System action:** Application ID 'OMVSAPPL' is used for authentication.

**System programmer response:** If the usage of application ID 'OMVSAPPL' is intended, no action has to be taken.

Otherwise, if you want to use the application ID 'CFZAPPL',

1. Set the configuration property *enableCFZAPPLID* to true
2. Restart the CIM server

**User response:** None.

---

**CFZ17205W Authentication failed for user *user-ID* from client IP address *IP-address*.**

**Explanation:** The authentication for user *user-ID* issued by the IP address *IP-address* against the z/OS system failed. Either the user ID or password contained in a request was invalid or revoked, or the user ID has not been authorized to use CIM.

**System action:** The CIM request is denied.

**System programmer response:** None.

**User response:** Check that you are using a valid user ID and password and that the user ID has been authorized to use CIM. If the problem persists, contact the system programmer of the target system to check for more detailed authentication error messages on the system console.

---

**CFZ17400W Request user ID *user-ID* does not have READ permission to profile CIMSERV CL(WBEM).**

**Explanation:** The user ID requesting a CIM operation using a local connection is not permitted to use the CIM server.

**System action:** The request is not processed and an "Access Denied" notification is sent to the client.

**System programmer response:** Permit the user to perform CIM requests by giving the user READ access to profile CIMSERV CL(WBEM).

**User response:** Contact your system programmer to permit your user ID to perform CIM requests and afterwards repeat your request.

---

**CFZ17600E Change owner action of security token file failed, which is required for local authentication.**

**Explanation:** The CIM server cannot change the ownership of a file to the user requesting local authentication. The file is located at */tmp* and the file name matches the pattern: *cimclient\_<USERID>\_\**. The file is only valid for a short time. The server should remove this file automatically. It can be deleted.

**System action:** The request is not processed and an "Access Denied" notification is sent to the client.

**System programmer response:** Either define CHOWN.UNRESTRICTED in RACF, or grant the CIM server runtime environment user ID READ access to the SUPERUSER.FILESYS.CHOWN resource in the UNIXPRIV RACF class. For details refer to "Configuring the CIM server's resource authorization model" on page 25.

**User response:** Contact your system programmer.

---

**CFZ17805I Audit logging is enabled.**

**Explanation:** Audit logging is enabled.

**System action:** The CIM server starts writing SMF 86 records. These records are only recorded if the SMF configuration contains record 86 and the security is set up accordingly. For details see "Audit logging with SMF record 86" on page 73.

**System programmer response:** None.

**User response:** None.

---

**CFZ17806I Audit logging is disabled.**

**Explanation:** Audit logging is disabled.

**System action:** The CIM server stops writing SMF 86 records.

**System programmer response:** None.

**User response:** None.

---

**CFZ18202E CIM server registration with internal SLP failed.**

**Explanation:** The CIM server failed to register itself as a service for the Service Location Protocol (SLP). Clients will not be able to detect the CIM server on the

local networking using the SLP protocol.

**System action:** None.

**System programmer response:** Check the system log for further messages indicating CIM server configuration problems or general communication problems. This message usually indicates an issue with the CIM server setup.

**User response:** None.

---

**CFZ18204I SLP registration initiated.**

**Explanation:** The CIM server has successfully registered itself as a service for the Service Location Protocol (SLP). Clients using the SLP protocol can now detect this CIM server on the local network.

**System action:** None.

**System programmer response:** None.

**User response:** None.

---

**CFZ18603E Could not get CLASSPATH from environment.**

**Explanation:** Initialization of the Java Virtual Machine failed due to environment variable CLASSPATH not being set. The CIM client request cannot be answered as JMPI (Java Managed Provider Interface) providers do not run without a correctly set CLASSPATH.

**System action:** None.

**System programmer response:** Set the CLASSPATH as described by the provider.

**User response:** Contact your system programmer.

---

**CFZ20400E A system error occurred. Retry the WS-Management operation at a later time.**

**Explanation:** A WS-Management operation exceeds the server's memory.

**System action:** Stop the WS-Management operation.

**System programmer response:** Look for message CFZ08101E identifying the source of the WS-Management request. Contact the owner of the application issuing the request and analyze the reason for the size of the operation. Limit the result objects for this request. Restart the server to clean it up.

**User response:** Contact your system programmer.

---

**IWMCP001E Internal error.**

**Explanation:** An unspecified internal error occurred. The requested operation could not be completed.

**System action:** No action was performed.

**System programmer response:** None.

---

**User response:** No action required. The function may be successful if invoked again.

---

**IWMCP002E Severe internal error.**

**Explanation:** An unspecified internal error occurred. The requested operation might have been partly or completely processed.

**System action:** Operation was partly or fully completed.

**System programmer response:** None.

**User response:** Check the system state. If the operation was not fully completed, the function may be successful if invoked again.

---

**IWMCP003E Memory shortage.**

**Explanation:** Storage is not available for the requested operation. The requested operation could not be performed.

**System action:** No action was performed.

**System programmer response:** None.

**User response:** There is a storage shortage. The function may work successfully later on.

---

**IWMCP004E Module IWMP2PCS missing.**

**Explanation:** Unsupported operating system environment. The WLM CIM provider requires z/OS V1R10 or higher. It cannot be used on z/OS V1R9 or lower.

**System action:** No action was performed.

**System programmer response:** Install WLM CIM provider on z/OS V1R10 or higher.

**User response:** None.

---

**IWMCP005E Invalid or missing parameter.**

**Explanation:** One or several CIM provider method parameters are not valid.

**System action:** No action was performed.

**System programmer response:** None.

**User response:** Check the parameters passed to CIM provider methods.

---

**IWMCP006E Insufficient access rights.**

**Explanation:** The caller is not authorized to perform the requested operation. The RACF facility class is active and a profile has been defined for the MVSADMIN.WLM.POLICY RACF facility class profile to which the caller does not have sufficient read or update access.

**System action:** No action was performed.

---

**System programmer response:** Grant user appropriate access for RACF profile MVSADMIN.WLM.POLICY.

**User response:** Contact the System Programmer to get the required authorization.



---

## Appendix A. Troubleshooting

This chapter contains the following subsections:

- “Garbage on the screen”
- “Typical error scenarios”

For problem determination, you can switch on tracing and logging. For details, see

- “Tracing” on page 68
- “Logging” on page 71

You can find further helpful information in Chapter 18, “z/OS specific messages,” on page 311.

---

### Garbage on the screen

Since the z/OS CIM server and all of its command-line utilities operate in the enhanced ASCII environment, all output is written using ASCII encoding. This can lead to garbage being displayed when watching the output from the CIM server command-line utilities, sample programs or from the CIM server itself. By default, the configuration files *cimserver.env* and *profile.add* shipped with the CIM server provide the required settings for automatic conversion to the correct encoding. For details on how to enable the automatic conversion and about Enhanced ASCII in general, refer to Using Enhanced ASCII functionality in *z/OS UNIX System Services Planning*.

One important issue is that automatic conversion so far only occurs for *UNIX System Service* applications. When the output of the CIM server or any of its clients should be consumed or displayed by applications other than *UNIX System Services* applications, the conversion must take place when the data are created. To achieve this, the output files need to be tagged as EBCDIC so that, for example, the CIM server's output is converted to EBCDIC before it is consumed by these applications.

---

### Typical error scenarios

The following is a list of typical errors that can be observed when working with CIM:

**Error:**

**BPXP014I ENVIRONMENT MUST REMAIN CONTROLLED FOR DAEMON (BPX.DAEMON) PROCESSING.**

**BPXP015I HFS PROGRAM /usr/lpp/wbem/provider/<provider\_library> IS NOT MARKED PROGRAM CONTROLLED.**

The provider <provider\_library> is not marked program controlled.

**When or where seen:** Messages on the console.

**Solution:** Mark the dynamic load library /usr/lpp/wbem/provider/<provider\_library> as program controlled by using the command `extattr +p <fully qualified dynamic load library name>`. Restart the CIM server and try again.

**Error: CIM\_ERR\_ACCESS\_DENIED**

Access to a CIM resource was not available to the client: "Not authorized to run <name of a CIM operation> in the namespace root/PG\_Internal"

**When or where seen:** Client application / Details in the CIM server trace log

**Solution:** Permit the user ID to execute a configuration command with CONTROL access to Security profile CIMSERV in class WBEM.

**Error: CIM runtime environment user ID requires CONTROL access to profile CIMSERV in class WBEM.**

**When or where seen:** The CIM server error log after CIM server fails to start

**Solution:** The CIM server startup fails because the CIM server user ID fails to have CONTROL access to profile CIMSERV in class WBEM. Grant the CIM server user ID CONTROL access to profile CIMSERV in class WBEM.

**Error: CIM runtime environment user ID requires either READ access to BPX.SERVER or it must be user ID 0.**

**When or where seen:**The CIM server error log after CIM server fails to start

**Solution:** Either permit the user ID READ access to BPX.SERVER if BPX.SERVER is set up, or run the command under a privileged user ID (UID 0).

**Error: CFZ17201W: ACCESS IS NOT ENABLED FOR REMOTE USERS WITH SUPERUSER AUTHORITY.**

**When or where seen:** On the client side.

**Solution:** The remote client uses a local user with UID=0. However, the CIM server is configured to reject remote access if the local user is a super-user (parameter enableRemotePrivilegedUserAccess=false). If you want to enable the local user with remote privileged access, then switch the parameter to true. Otherwise, change the local user to a non-super-user by setting the UID ≠ 0.

**Error:**

**CFZ10033E: The CIM server is not started:**

**CFZ00409E: Bind failed:**

**CFZ07801E: CIM HTTP or HTTPS connection failed to create the socket.**

**When or where seen:** CIM server startup console messages

**Solution:** The CIM server cannot start because it fails to listen on one of the ports 5988 (for http) or 5989 (for https). Either the CIM server is already running, another server is listening on one of these ports, or the ports have been blocked by the TCP/IP configuration.

The *httpPort* and *httpsPort* CIM server configuration properties define the HTTP port and HTTPS port numbers (see Chapter 9, "CIM server configuration," on page 55).

- Check the PORT and PORTRANGE statements in the PROFILE.TCPIP configuration file to ensure that the specified ports are accessible to the CIM server.
- Check the security product configuration to ensure that the CIM server is able to access the specified ports. For example, OEM security product ACF2 may require "Stack & Port security authorization" for the CIM server.

— Use the TCP/IP NETSTAT ALLCONN PORT command to check for servers using the specified ports, for example issue  
TSO NETSTAT ALLCONN (PORT 5988

See “Configuring the ports for the CIM server” on page 45 for more information.

**Error: HTTP Error (401 Unauthorized)**

**When or where seen:** Client application

**Solution:** The user authentication failed. The client application either did not provide user ID and password on a request at all, or the supplied user ID and password are not valid for the z/OS system on which the CIM server is running.

Permit the user ID to execute a client request with at least READ access to Security profile CIMSERV in class WBEM. Check the server log for a detailed error report.

**Error: ICH14080I**

Warning: RACF detected a possible error in the dynamic class descriptor table, entry WBEM, error code 01. The class is available for further processing. The class name does not contain a national character nor a number. To assure IBM does not create an IBM-defined class in the future by this same name, you should choose a class name which contains at least one national character or a number.

**When or where seen:** RACF setup of dynamic class WBEM

**Solution:** Ignore the warning.

**Error:**

**ICH408I USER(CFZSRV)  
GROUP(CFZSRVGP) NAME(#####)  
CL(PROCESS )  
INSUFFICIENT AUTHORITY TO NEWJOBNAME**

**When or where seen:** Message on the console.

**Solution:** Grant the CIM server user ID READ access to profile BPX.JOBNAME in class FACILITY to be allowed to set the job name of the out-of-process agent to CFZOOA (see “Running providers in separate address spaces” on page 66).

**Error: IEF450I CFZCIM - ABEND=S1C7 U0000 REASON=FFFF0006**

**When or where seen:** Message on the console.

**Solution:** Look for CSV042I and ICH422I program control messages. CSV042I message points out the module to be marked as program controlled. If no CSV042I and ICH422I messages occur contact IBM Service.

**Example:**

```
CSV042I REQUESTED MODULE BLSUXTID NOT ACCESSED.  
        THE MODULE IS NOT PROGRAM CONTROLLED  
ICH422I THE ENVIRONMENT CANNOT BECOME UNCONTROLLED.  
CSV028I ABEND306-42 JOBNAME=CFZCIM STEPNAME=  
BPXP014I ENVIRONMENT MUST REMAIN CONTROLLED FOR  
        DAEMON (BPX.DAEMON) PROCESSING.  
IEF450I CFZCIM - ABEND=S1C7 U0000 REASON=FFFF0006 TIME=14.16.12
```

**Error: JGP00001W: Number of Instances Exceeded Threshold**

This error message might be issued at enumeration of IBMzOS\_Job instances, when the number of instances to be enumerated is greater than a configured limit. This limit has been defined to prevent the CIM server from resource exhaust.

It is recommended to change your enumeration to a subset of IBMzOS\_Job.

To query the current limit of the IBMzOS\_Job provider, receive the IBMzOS\_JobsManagementSettings instance of the CIM server. The property *MaxInstances* contains the currently defined limit.

To change the limits, set the property *MaxInstances* to a new value by modifying the IBMzOS\_JobsManagementSettings instance.

```
cimcli mi
  IBMzOS_JobsManagementSettings.InstanceID=\"IBMzOS:JobsManagementSettings\"
  MaxInstances=<new_value>
```

**Client Side Error: CIM\_ERR\_ACCESS\_DENIED**

Access to a CIM resource was not available to the client: "EDC5139I  
Operation not permitted."

**When or where seen:** Client application / Details in the CIM server trace log

**Solution:** Permit the CIM server runtime environment user ID as surrogate for the requesting client user ID to use the command: PERMIT BPX.SRV.<client uid> CL(SURROGAT) ID(<CIMServer UID>) ACCESS(READ)

**Client side error: HTTP Error (413 Request Entity Too Large)**

There wasn't enough memory available to the client to successfully read the entire response from the server into memory.

**When or where seen:** Client application, like for instance cimivp.

**Solution:** Allow the client to use more memory. If the application runs within a JOB, increase the REGION size. If the client runs from a UNIX System Services shell, increase the ASSIZEMAX value in the OMVS segment of the user running the shell.

---

## Appendix B. Step-by-step explanation of the CFZSEC job

This appendix provides an explanation for each single step of the CIM security setup job CFZSEC.

Please note that the CFZSEC job provides a quick security setup for CIM. Because this job provides a solution for each configuration, necessarily the job steps which do not apply to your system will fail. But this does not affect the job's functionality.

The job creates security profiles, users and groups required to run CIM and grants them the necessary permissions to system resources.

---

### Step BASICSUP

```
/* Step BASICSUP dose set-up basic security settings.
/*      - Program control for runtime libraries.
//BASICSUP EXEC PGM=IKJEFT01,DYNAMNBR=99
//SYSPRINT DD SYSOUT=*
//SYSPRINT DD SYSOUT=*
//SYSTSIN DD *

RALT PROGRAM * ADDMEM('SYS1.SCEERUN'/'*****'/NOPADCHK) +
  UACC(READ)
RALT PROGRAM * ADDMEM('SYS1.SCEERUN2'/'*****'/NOPADCHK) +
  UACC(READ)

SETROPTS WHEN(PROGRAM) REFRESH
/*
```

This sets up the basic security for the CIM server. To enable the CIM server to run in a program controlled environment, the Language Environment runtime libraries SCEERUN and SCEERUN2 must be program controlled.

## Step CRUSR

### Step CRUSR

```
/*
/* Step CRUSR creates default groups and users required for CIM
/* CFZSRVGP - CIM server ID's default group
/* CFZADMGP - CIM admin ID's default group
/* CFZUSRGP - CIM end-users ID's default group
/*
/* CFZSRV - CIM server UserId used by Started Task
/*
/*CRUSR EXEC PGM=IKJEFT01,DYNAMNBR=99
//SYSPRINT DD SYSOUT=*
//SYSTSPRT DD SYSOUT=*
//SYSTSIN DD *

ADDGROUP CFZSRVGP OMVS(GID(9501))
ADDGROUP CFZADMGP OMVS(GID(9502))
ADDGROUP CFZUSRGP OMVS(GID(9503))

ADDUSER CFZSRV DFLTGRP(CFZSRVGP) OMVS(UID(0) PROGRAM('/bin/sh') +
HOME('/u/cfzsrv')) NOPASSWORD NOOIDCARD
ADDSD 'CFZSRV.**' UACC(NONE)
PERMIT 'CFZSRV.**' CLASS(DATASET) ID(CFZSRV) ACCESS(ALTER)
SETROPTS GENERIC(DATASET) REFRESH
ALTUSER CFZSRV DFLTGRP(CFZSRVGP) OMVS(UID(0) PROGRAM('/bin/sh') +
HOME('/u/cfzsrv')) NOPASSWORD NOOIDCARD NOPHASE
/*
```

This step creates or updates the user CFZSRV for running the CIM server as a started task. By default the UID for the CIM server user is set to 0 to run the CIM server with superuser privileges. While this may be sufficient for a simple setup, if you have defined the BPX.SERVER profile in the class FACILITY, and class FACILITY is activated, it is recommended to change the UID for CFZSERV to a non null value. The default in this case is 9500.

A default data set profile is created to ensure that the CIM server user ID can access its home profile and other relevant settings.

In addition this step creates distinct groups for the CIM server user (CFZSRVGP), CIM server administrators (CFZADMGP) and end users (CFZUSRGP). To grant a user access to CIM, simply connect the user to the according group, for example with the command

```
CONNECT (username) GROUP(CFZUSRGP) AUTHORITY(USE)
```

The CFZUSRGP grants a user access to all resources that are managed through CIM. Depending on how granular you want to control users' access to CIM, you may want to create additional groups that allow access only to a subset of resources managed through CIM.

---

## Step CRWBEM

### Step CRWBEM

```
/* Step CRWBEM creates class WBEM and profile CIMSERV
//CRWBEM EXEC PGM=IKJEFT01,DYNAMNBR=99
//SYSPRINT DD SYSOUT=*
//SYSTSPRT DD SYSOUT=*
//SYSTSIN DD *

SETROPTS CLASSACT(CDT) RACLIST(CDT)

RDEFINE +
  CDT WBEM +
  UACC(NONE) +
  CDTINFO( CASE(UPPER) +
    MAXLENGTH(246) +
    FIRST(ALPHA) +
    OTHER(ALPHA,NUMERIC) +
    MAXLENX(246) +
    KEYQUALIFIERS(0) +
    PROFILESALLOWED(YES) +
    POSIT(200) +
    DEFAULTTRC(8) +
    DEFAULTUACC(NONE) +
    RACLIST(REQUIRED))

SETROPTS RACLIST(CDT) REFRESH

SETROPTS CLASSACT(WBEM) RACLIST(WBEM)

RDEFINE WBEM CIMSERV UACC(NONE)

SETROPTS CLASSACT(WBEM) RACLIST(WBEM)
/*
```

This step creates the RACF class and profile required to control access to the CIM server.

If the POSIT value 200 for RACF is already in use on your system, change the value defined in this step.

## Step PEUSR

### Step PEUSR

```
/* Step PEUSR
/*      - permits default UserID's to required resources
/*      - sets up required surrogate
/*      - permits CFZSRV to BPX.SERVER (no effect if BPX.SERVER is not
/*              enabled on the system)
/*      - authorizes CIM server to write SMF records
/*      - authorizes CIM server to write to console
//PEUSR EXEC PGM=IKJEFT01,DYNAMNBR=99
//SYSPRINT DD SYSOUT=*
//SYSTSPRT DD SYSOUT=*
//SYSTSIN DD *

PERMIT CIMSERV CL(WBEM) ACCESS(CONTROL) ID(CFZSRV)
PERMIT CIMSERV CL(WBEM) ACCESS(CONTROL) ID(CFZADMGP)
PERMIT CIMSERV CL(WBEM) ACCESS(UPDATE) ID(CFZUSRGP)
SETROPTS RACLIST(WBEM) REFRESH

SETROPTS CLASSACT(SURROGAT) RACLIST(SURROGAT) GENERIC(SURROGAT)
RDEFINE SURROGAT BPX.SRV.** UACC(NONE)
PERMIT BPX.SRV.** CL(SURROGAT) ACCESS(READ) ID(CFZSRV)
SETROPTS RACLIST(SURROGAT) REFRESH

PERMIT BPX.SERVER CL(FACILITY) ACCESS(UPDATE) ID(CFZSRV)
SETROPTS RACLIST(FACILITY) REFRESH

RDEFINE FACILITY BPX.SMF UACC(NONE)
PERMIT BPX.SMF CL(FACILITY) ACCESS(READ) ID(CFZSRV)
PERMIT BPX.CONSOLE CL(FACILITY) ACCESS(READ) ID(CFZSRV)
SETROPTS RACLIST(FACILITY) REFRESH

/*
```

This step grants CIM users the necessary permissions to run, to control and to access the CIM server.

In detail it grants the following permissions:

#### For the CIM server user:

- CONTROL access to profile CIMSERV in class WBEM  
This allows the user to start the CIM server.
- READ access to profile BPX.SRV.\*\* in class SURROGAT  
This allows the CIM server to switch a TCB into a requestor's user for running client requests under the authority of the client's user.
- UPDATE access to profile BPX.SERVER in class FACILITY  
This authorizes the CIM server to validate user credentials and to verify user access to RACF profiles.
- READ access to profile BPX.SMF in class FACILITY  
This allows the CIM server to write SMF records when it is configured to do so. (See "Audit logging with SMF record 86" on page 73 for details on SMF support in CIM.)
- READ access to profile BPX.CONSOLE in class FACILITY  
This allows the CIM server to issue messages on the z/OS console when the BPX.CONSOLE profile is defined.



**For the CIM administrator group:**

- CONTROL access to profile CIMSERV in class WBEM  
This allows a user to perform administrative functions.

**For the CIM users group:**

- UPDATE access to profile CIMSERV in class WBEM  
This allows a user to access CIM as a regular user.

---

## Step PEAPPL

### Step PEAPPL

```
/* Step PEAPPL Permit CIM groups and users to net application CFZAPPL
/* This has no effect if class APPL is not active.
//PEAPPL EXEC PGM=IKJEFT01,DYNAMNBR=99
//SYSPRINT DD SYSOUT=*
//SYSPRINT DD SYSOUT=*
//SYSTSIN DD *
RDEFINE APPL CFZAPPL UACC(NONE)
PERMIT CFZAPPL CL(APPL) ACCESS(READ) ID(CFZSRV)
PERMIT CFZAPPL CL(APPL) ACCESS(READ) ID(CFZADMGP)
PERMIT CFZAPPL CL(APPL) ACCESS(READ) ID(CFZUSRGP)
SETROPTS RACLIST(APPL) REFRESH
/*
```

When class APPL is active, the CFZAPPL profile protects access to the CIM server application. Any user who wants to access the CIM server requires at least READ access to the CFZAPPL profile in the APPL class. This job step grants this access for the CIM server user, the CIM administrator group, and the CIM users group.

---

## Step SETARM

### Step SETARM

```
/* Step SETARM establishes security setup required for ARM
/* A sample ARM policy (CFZARMP) resides in the installed
/* SYS1.SAMPLIB
//SETARM EXEC PGM=IKJEFT01,DYNAMNBR=99
//SYSPRINT DD SYSOUT=*
//SYSPRINT DD SYSOUT=*
//SYSTSIN DD *
SETROPTS CLASSACT(FACILITY) RACLIST(FACILITY) GENERIC(FACILITY)
RDEFINE FACILITY IXCARM.DEFAULT.CFZ_SRV_* UACC(NONE)
PERMIT IXCARM.DEFAULT.CFZ_SRV_* CLASS(FACILITY) +
ID(CFZSRV) ACCESS(UPDATE)

SETROPTS RACLIST(FACILITY) REFRESH
/*
```

This step enables the CIM server for registering with the z/OS Automatic Restart Manager (ARM).

To completely enable the CIM server for ARM, additional customization is required as described in “Automatically restarting the CIM server” on page 74.

---

## Step ENSTC

### Step ENSTC

```
/* Step ENSTC establishes CFZSRV as the Started Task User for CIM
//ENSTC EXEC PGM=IKJEFT01,DYNAMNBR=99
//SYSPRINT DD SYSOUT=*
//SYSTSPRT DD SYSOUT=*
//SYSTSIN DD *
  SETROPTS CLASSACT(STARTED) RACLIST(STARTED) GENERIC(STARTED)
  RDEFINE STARTED CFZCIM.* STDATA(USER(CFZSRV) GROUP(CFZSRVGP))
  SETROPTS RACLIST(STARTED) REFRESH
/*
```

This step connects the CIM server started task procedure CFZCIM with the CIM server user CFZSRV.

For further details on configuring the CIM server started task procedure, see “Customizing the started task procedure CFZCIM” on page 50.

## Step PECEA

### Step PECEA

```
/* Step PECEA permits CIM Cluster and JES jobs provider to access CEA
/*
//PECEA EXEC PGM=IKJEFT01,DYNAMNBR=99
//SYSPRINT DD SYSOUT=*
//SYSPRINT DD SYSOUT=*
//SYSTSIN DD *
ADDSD 'CEA.*' UACC(NONE)
PERMIT 'CEA.*' CLASS(DATASET) ID(CFZUSRGP) ACCESS(ALTER)
PERMIT 'CEA.*' CLASS(DATASET) ID(CFZADMGP) ACCESS(ALTER)
SETROPTS GENERIC(DATASET) REFRESH

PERMIT CEA.* CLASS(SERVAUTH) ID(CFZSRV) ACCESS(UPDATE)
SETROPTS CLASSACT(SERVAUTH) RACLIST(SERVAUTH) GENERIC(SERVAUTH)
RDEFINE SERVAUTH CEA.* UACC(NONE)

PERMIT CEA.* CLASS(SERVAUTH) ID(CFZADMGP) ACCESS(UPDATE)
PERMIT CEA.* CLASS(SERVAUTH) ID(CFZUSRGP) ACCESS(UPDATE)

PERMIT CEA.CONNECT CLASS(SERVAUTH) ID(CFZADMGP) ACCESS(UPDATE)
PERMIT CEA.SUBSCRIBE.* CLASS(SERVAUTH) ID(CFZADMGP) ACCESS(UPDATE)
PERMIT CEA.SUBSCRIBE.ENF_0068* CLASS(SERVAUTH) ID(CFZADMGP) +
ACCESS(UPDATE)
PERMIT CEA.CEAGETPS CLASS(SERVAUTH) ID(CFZADMGP) ACCESS(UPDATE)
PERMIT CEA.CEADOCMD CLASS(SERVAUTH) ID(CFZADMGP) ACCESS(UPDATE)
PERMIT CEA.CEAPDWB* CLASS(SERVAUTH) ID(CFZADMGP) ACCESS(UPDATE)
PERMIT CEA.CEADOCONSOLECMD CLASS(SERVAUTH) ID(CFZADMGP) ACCESS(UPDATE)

PERMIT CEA.CONNECT CLASS(SERVAUTH) ID(CFZUSRGP) ACCESS(UPDATE)
PERMIT CEA.SUBSCRIBE.* CLASS(SERVAUTH) ID(CFZUSRGP) ACCESS(UPDATE)
PERMIT CEA.SUBSCRIBE.ENF_0068* CLASS(SERVAUTH) ID(CFZUSRGP) +
ACCESS(UPDATE)
PERMIT CEA.CEAGETPS CLASS(SERVAUTH) ID(CFZUSRGP) ACCESS(UPDATE)
PERMIT CEA.CEADOCMD CLASS(SERVAUTH) ID(CFZUSRGP) ACCESS(UPDATE)
PERMIT CEA.CEAPDWB* CLASS(SERVAUTH) ID(CFZUSRGP) ACCESS(UPDATE)
PERMIT CEA.CEADOCONSOLECMD CLASS(SERVAUTH) ID(CFZUSRGP) ACCESS(UPDATE)

PERMIT CEA.CONNECT CLASS(SERVAUTH) ID(CFZSRV) ACCESS(UPDATE)
PERMIT CEA.SUBSCRIBE.* CLASS(SERVAUTH) ID(CFZSRV) ACCESS(UPDATE)
PERMIT CEA.SUBSCRIBE.ENF_0078* CLASS(SERVAUTH) ID(CFZSRV) +
ACCESS(UPDATE)

SETROPTS RACLIST(SERVAUTH) REFRESH
/*
```

This step permits CIM users and administrators to access CEA through the CIM providers for the OS management Jobs and Cluster classes described in “OS management Job classes” on page 167 and “OS management Cluster classes” on page 200.

**Note:** This step defines the generic resource profile CEA.\* and permits the CIM default groups CFZADMGP and CFZUSRGP access to it.

For the case that you have already defined the specific resource profiles (CEA.CONNECT, etc), this step also permits the CIM default groups to these specific resource profiles.

Depending on what you have actually defined, you can customize this job step to match your environment by removing obsolete commands.

For granting users a more fine grained access to CIM you may consider to define an additional group here that grants access just for OS management Jobs and Cluster classes.

For further details on the required setup for using the OS management Jobs and Cluster classes see “Setting up the CIM server for Cluster, CoupleDataset, and JES2-JES3Jobs providers” on page 38.

---

## Step ENCLCDS

### Step ENCLCDS

```
/* Step ENCLCDS Setup for Cluster/Couple Dataset Providers
/*
//ENCLCDS EXEC PGM=IKJEFT01,DYNAMNBR=99
//SYSPRINT DD SYSOUT=*
//SYSPRINT DD SYSOUT=*
//SYSTSIN DD *

SETROPTS CLASSACT(FACILITY) RACLIST(FACILITY) GENERIC(FACILITY)

RDEFINE FACILITY MRCLASS.CLUSTER UACC(NONE)
PERMIT MRCLASS.CLUSTER CLASS(FACILITY) ID(CFZUSRGP) ACCESS(UPDATE)
PERMIT MRCLASS.CLUSTER CLASS(FACILITY) ID(CFZADMGP) ACCESS(UPDATE)

RDEFINE FACILITY MVSADMIN.* UACC(NONE)
PERMIT MVSADMIN.* CLASS(FACILITY) ID(CFZUSRGP) ACCESS(UPDATE)
PERMIT MVSADMIN.* CLASS(FACILITY) ID(CFZADMGP) ACCESS(UPDATE)
PERMIT MVSADMIN.XCF.* CLASS(FACILITY) ID(CFZUSRGP) ACCESS(UPDATE)
PERMIT MVSADMIN.XCF.* CLASS(FACILITY) ID(CFZADMGP) ACCESS(UPDATE)
PERMIT MVSADMIN.XCF.CFRM CLASS(FACILITY) ID(CFZUSRGP) ACCESS(UPDATE)
PERMIT MVSADMIN.XCF.CFRM CLASS(FACILITY) ID(CFZADMGP) ACCESS(UPDATE)

SETROPTS RACLIST(FACILITY) REFRESH
/*
```

This step permits CIM users and administrators to use the CIM providers for the OS management Cluster classes described in “OS management Cluster classes” on page 200.

For granting users a more fine-grained access to CIM, you may consider to define an additional group here that grants access just for OS management Cluster classes.

For further details on the required setup for using the OS management Cluster classes see “Setting up the CIM server for Cluster, CoupleDataset, and JES2-JES3Jobs providers” on page 38.

## Step ENSMIS

### Step ENSMIS

```
/* Step ENSMIS enables the SMI-S CIM providers
//ENSMIS EXEC PGM=IKJEFT01,DYNAMNBR=99
//SYSPRINT DD SYSOUT=*
//SYSTSPRT DD SYSOUT=*
//SYSTSIN DD *
SETROPTS CLASSACT(FACILITY) RACLIST(FACILITY) GENERIC(FACILITY)
RDEFINE FACILITY IOSCDR UACC(NONE)

PERMIT IOSCDR CL(FACILITY) ID(CFZUSRGP) ACCESS(UPDATE)
PERMIT IOSCDR CL(FACILITY) ID(CFZADMGP) ACCESS(UPDATE)
PERMIT IOSCDR CL(FACILITY) ID(CFZSRV) ACCESS(UPDATE)

RDEFINE FACILITY IOSPORTS UACC(NONE)
PERMIT IOSPORTS CL(FACILITY) ID(CFZUSRGP) ACCESS(UPDATE)
PERMIT IOSPORTS CL(FACILITY) ID(CFZADMGP) ACCESS(UPDATE)

SETROPTS CLASSACT(SERVAUTH) RACLIST(SERVAUTH) GENERIC(SERVAUTH)

RDEFINE SERVAUTH CEA.* UACC(NONE)
PERMIT CEA.* CLASS(SERVAUTH) ID(CFZSRV) ACCESS(READ)
PERMIT CEA.CONNECT CLASS(SERVAUTH) ID(CFZSRV) ACCESS(READ)
PERMIT CEA.SUBSCRIBE.ENF_0009* CLASS(SERVAUTH) ID(CFZSRV) +
ACCESS(READ)
PERMIT CEA.SUBSCRIBE.ENF_0027* CLASS(SERVAUTH) ID(CFZSRV) +
ACCESS(READ)
PERMIT CEA.SUBSCRIBE.ENF_0033* CLASS(SERVAUTH) ID(CFZSRV) +
ACCESS(READ)

SETROPTS RACLIST(FACILITY) REFRESH
SETROPTS RACLIST(SERVAUTH) REFRESH
/*
```

This step permits the CIM server user ID to access CEA through the CIM live cycle indication providers for the Storage management classes as described in “Storage management classes” on page 241.

In particular a CIM user requires this permission to access the CIM providers for the following storage management classes:

- IBMzOS\_SBProtocolEndpoint
- Association IBMzOS\_SBInitiatorTargetLogicalUnitPath

This step defines the generic resource profile CEA.\* and permits the default CIM server user ID CFZSRV access to it. For the case that you have already defined the specific resource profiles such as CEA.CONNECT, this step also permits the default CIM server user ID to these specific resource profiles. Depending on what you have actually defined, you can customize this job step to match your environment by removing obsolete commands.

For granting users a more fine-grained access to CIM, you may consider to define an additional group that grants access just for Storage management classes.

---

## Step ENTICIP

### Step ENTICIP

```
/* Step ENTICIP enables the Network CIM providers
//ENTICIP EXEC PGM=IKJEFT01,DYNAMNBR=99
//SYSPRINT DD SYSOUT=*
//SYSTSPRT DD SYSOUT=*
//SYSTSIN DD *

SETROPTS CLASSACT(SERVAUTH) RACLIST(SERVAUTH) GENERIC(SERVAUTH)
RDEFINE SERVAUTH EZB.CIMPROV.* UACC(NONE)

PERMIT EZB.CIMPROV.* CL(SERVAUTH) ID(CFZADMGP) ACCESS(READ)
PERMIT EZB.CIMPROV.* CL(SERVAUTH) ID(CFZUSRGP) ACCESS(READ)

SETROPTS RACLIST(SERVAUTH) REFRESH
/*
```

This step permits CIM users and administrators to use the CIM providers for the OS management Network classes described in “OS management Network classes” on page 160.

For granting users a more fine-grained access to CIM, you may consider to define an additional group here that grants access just for the OS management Network classes.

---

## Step ENWLM

### Step ENWLM

```
/* Step ENWLM Setup for WLM Providers
/*
//ENWLM EXEC PGM=IKJEFT01,DYNAMNBR=99
//SYSPRINT DD SYSOUT=*
//SYSTSPRT DD SYSOUT=*
//SYSTSIN DD *

SETROPTS CLASSACT(FACILITY) RACLIST(FACILITY) GENERIC(FACILITY)

RDEFINE FACILITY MVSADMIN.* UACC(NONE)
PERMIT MVSADMIN.* CLASS(FACILITY) ID(CFZUSRGP) ACCESS(UPDATE)
PERMIT MVSADMIN.* CLASS(FACILITY) ID(CFZADMGP) ACCESS(UPDATE)
PERMIT MVSADMIN.WLM.* CLASS(FACILITY) ID(CFZUSRGP) ACCESS(UPDATE)
PERMIT MVSADMIN.WLM.* CLASS(FACILITY) ID(CFZADMGP) ACCESS(UPDATE)
PERMIT MVSADMIN.WLM.POLICY CLASS(FACILITY) ID(CFZUSRGP) ACCESS(UPDATE)
PERMIT MVSADMIN.WLM.POLICY CLASS(FACILITY) ID(CFZADMGP) ACCESS(UPDATE)
RDEFINE PROGRAM BLSUXTID
RALT PROGRAM BLSUXTID ADDMEM('SYS1.MIGLIB/'*****'/NOPADCHK) +
UACC(READ)

SETROPTS RACLIST(FACILITY) REFRESH
SETROPTS WHEN(PROGRAM) REFRESH
/*
```

This step permits CIM users and administrators to use the CIM providers for the WLM classes described in Chapter 15, “WLM classes,” on page 277.

For granting users a more fine-grained access to CIM, you may consider to define an additional group here that grants access just for the WLM classes.

---

## Step ENRMF

### Step ENRMF

```
/* Step ENRMF creates profiles necessary to allow passtickets being
/*          generated for authentication with the DDS
//ENRMF EXEC PGM=IKJEFT01,DYNAMNBR=99
//SYSPRINT DD SYSOUT=*
//SYSPRINT DD SYSOUT=*
//SYSTSIN DD *
  SETROPTS CLASSACT(PTKTDATA) RACLIST(PTKTDATA) GENERIC(PTKTDATA)
  RDEFINE PTKTDATA GPMSERVE SSIGNON(KEYMASKED(#rkeymask))
  RDEFINE PTKTDATA IRRPTAUTH.GPMSERVE.* UACC(NONE)
  PERMIT IRRPTAUTH.GPMSERVE.* CL(PTKTDATA) ID(CFZSRV) ACCESS(UPDATE)
  SETROPTS RACLIST(PTKTDATA) REFRESH
/*
```

If you are not using the z/OS Resource Measurement Facility (RMF) optional element, remove this step from the job. Otherwise this step permits the CIM server access to the RMF Distributed Data Server using passtickets. For this, replace #rkeymask by a 16-digit (0-9,A-F) keymask value to setup connectivity between CIM and RMF via passtickets.

#### Note:

The keymask value is a secret passkey. In a secure environment it is recommended to execute step ENRMF separately to avoid storing the passkey in the job log in readable format.

The CIM classes implemented by RMF are described in the *z/OS RMF Programmer's Guide* and *z/OS RMF User's Guide*.





## Appendix C. CEA reason codes

The following list of reason codes may be returned by the methods in the Jobs providers. The first four digits (X'xxxx') may be any value.

Table 8. Jobs providers' reason codes

Reason code (hex)	Description	User action	IBM Service Information
X'xxxx0100'	Common Event Adapter (CEA) communication unavailable.	Ensure CEA is active; Call IBM Service.	CEAUNAVAIL
X'xxxx0117'	Instrumentation is unable to accommodate additional CIM indication providers.	Remove unused/unnecessary indication provider connections from the instrumentation. Call IBM Service if this is a consistent problem.	CEAMAXCLIENTSCONNECTED
X'xxxx011F'	z/OS System Operator forced the unsubscribe of the event.	Resubscribe to the event.	CEASYSOPFORCEUNSUBSCRIBE
X'xxxx0121'	Common Event Adapter (CEA) is no longer able to communicate with CIM indication providers.	Adjust CEA by transitioning the component from minimum mode to full mode. Operator must use F CEA,MODE=FULL	CEAFORCEMINMODE
X'xxxx0126'	Instrumentation is unable to accept any more subscriptions to indication events.	Remove unused/unnecessary indication event subscriptions	CEAMAXPGMSUBSCRIBED
X'xxxx020A'	Common Event Adapter (CEA) was unable to find exit handler.	Ensure that the exit handler is installed properly by the SMP/E installation step. The handlers are usually installed in the LPA.	CEAHANDLERNOTFOUND
X'xxxx0300'	Internal CIM error.	Call IBM Service.	CEAREQUESTNOTRECOGNIZED
X'xxxx0301'	Internal CIM error.	Call IBM Service.	CEAREQUESTNOTIMPLEMENTED
X'xxxx0302'	Internal CIM error.	Call IBM Service.	CEAPROPERTYSTRUCTBADPTR
X'xxxx0303'	Internal CIM error.	Call IBM Service.	CEAPROPERTYSTRUCTBADEYE
X'xxxx0304'	Internal CIM error.	Call IBM Service.	CEAPROPERTYSTRUCTBADVERSION
X'xxxx0305'	Internal CIM error.	Call IBM Service.	CEAPROPERTYBADRESOURCE
X'xxxx0306'	Internal CIM error.	Call IBM Service.	CEAPROPERTYNOMATCH
X'xxxx0307'	Internal CIM error.	Call IBM Service.	CEAPROPERTYSTRUCTEMPTY
X'xxxx0308'	Internal CEA error.	Call IBM Service.	CEAENVBAD

Table 8. Jobs providers' reason codes (continued)

Reason code (hex)	Description	User action	IBM Service Information
X'xxxx0309'	Internal CIM error.	Call IBM Service.	CEAFILTERSTRUCTBADEYE
X'xxxx030A'	Internal CIM error.	Call IBM Service.	CEAFILTERSTRUCTBADVERSION
X'xxxx030B'	Internal CIM error.	Call IBM Service.	CEAFILTERBADRESOURCE
X'xxxx030C'	Internal CIM error.	Call IBM Service.	CEAFILTERNOMATCH
X'xxxx030D'	Internal CIM error.	Call IBM Service.	CEABADPARMPTR
X'xxxx030E'	Internal CEA error.	Call IBM Service.	CEABADSSISUBSYSTEM
X'xxxx030F'	Internal CEA error.	Call IBM Service.	CEABADSSICALL
X'xxxx0310'	Internal CEA error.	Ensure JES2/JES3 is active. Ensure that ExtendedSubsystem is available. Call IBM Service.	CEANOSSI
X'xxxx0311'	Internal CEA error.	Call IBM Service.	CEABADSSIENV
X'xxxx0312'	Internal CEA error.	Look for SDUMP. Call IBM Service.	CEAENVBADSSI
X'xxxx0314'	Internal CEA error.	Look for SDUMP. Check storage indicators (monitors). Call IBM Service if external symptom not resolved.	CEAUNABLETOALLOCATE
X'xxxx0315'	Internal CEA error.	Call IBM Service.	CEANOTJOBSTERSEELEMENT
X'xxxx0316'	Internal CEA error.	SSI Abend. Look for SDUMP. Call IBM Service.	CEAJOBCHAINBROKEN
X'xxxx0317'	Internal CEA error.	Look for SDUMP. Call IBM Service.	CEABADDATENV
X'xxxx0318'	Internal CEA error.	Look for SDUMP. Call IBM Service.	CEASYSOUTCHAINBROKEN
X'xxxx0319'	Internal CEA error.	Look for SDUMP. Call IBM Service.	CEANOTSYSOUTHRELEMENT
X'xxxx031A'	Internal CEA error.	Call IBM Service.	CEABADFREEPTR
X'xxxx031B'	Internal CEA error.	Call IBM Service.	CEABADFREEBLK
X'xxxx031C'	Internal CEA error.	Call IBM Service.	CEABADFREEENV
X'xxxx031D'	Internal CEA error.	Call IBM Service.	CEAUNABLETOFREE
X'xxxx031E'	Internal CEA error.	Call IBM Service.	CEABADIEFQRY
X'xxxx031F'	Internal CEA error.	Look for SDUMP. Call IBM Service.	CEASSCHAINBROKEN
X'xxxx0320'	Internal CEA error.	Look for SDUMP. Call IBM Service.	CEAENVBADJSQY
X'xxxx0321'	Internal CEA error.	Call IBM Service.	CEABADFILTEROPER
X'xxxx0322'	Internal CEA error.	Call IBM Service.	CEABADS54SUBSYSTEM
X'xxxx0323'	Internal CEA error.	Call IBM Service.	CEABADS54CALL
X'xxxx0324'	Internal CEA error.	SSI not activated. Call IBM Service.	CEANOS54

Table 8. Jobs providers' reason codes (continued)

Reason code (hex)	Description	User action	IBM Service Information
X'xxxx0325'	Internal CEA error.	Call IBM Service.	CEABADS54ENV
X'xxxx0327'	Internal CEA error.	Call IBM Service.	CEABADS54STOR
X'xxxx0328'	Internal CIM error.	Call IBM Service.	CEATIMEOUTMAXIMUMEXCEEDED
X'xxxx0329'	Internal CEA error.	Call IBM Service.	CEANEEDSYSOUTFILTER
X'xxxx032A'	Internal CIM error.	Call IBM Service.	CEABUFFERTOOLARGE
X'xxxx032B'	Internal CEA error.	Call IBM Service.	CEACCMDSDIAGRCSET
X'xxxx032C'	Internal CEA error.	Ensure SYSREXX is active/operational using the F AXR,DISPLAY command. Call IBM Service if AXREXX is active.	CEACCMDSAXREXXRCSET
X'xxxx032D'	Client not authorized for instrumentation	Ensure user has access to instrumentation facilities.	CEANOINSTRAUTH
X'xxxx032E'	Internal CIM error.	Call IBM Service.	CEATOOMUCHDATA
X'xxxx032F'	Internal CEA error.	Call IBM Service.	CEAFILTERNOTSUPPORTED
X'xxxx0330'	Internal CEA error.	Call IBM Service.	CEAPRIMARYTYPE MISMATCH
X'xxxx0331'	Internal CEA error.	Call IBM Service.	CEABADSUBSYSTEM
X'xxxx0332'	Internal CEA error.	Call IBM Service.	CEAUNABLETOALLOCATE2
X'xxxx0333'	Internal CEA error.	Call IBM Service.	CEABADBUFFER
X'xxxx0334'	Internal CIM error.	Call IBM Service.	CEATIMEOUTLESSTHANMINIMUM
X'xxxx0335'	Internal CIM error.	Call IBM Service.	CEACMDS SYNTAX ERROR
X'xxxx0336'	The CIM provider request was cancelled in-process.	Retry the command request. If it does not work, call IBM Service.	CEACMDSHALTERROR
X'xxxx0337'	Internal CIM error.	Call IBM Service.	CEACMDSUNINITERROR
X'xxxx0338'	Internal CEA error.	Call IBM Service.	CEAFILTERBADCOMBO
X'xxxx0339'	Underlying command did not complete in the time specified.	Increase timeout value in the CIM method request and retry request.	CEACMDSTIMEDOUT



---

## Related links

**CIM Event Model White Paper**

<http://www.dmtf.org/standards/documents/CIM/DSP0107.pdf>

**CIM Query Language Specification**

[http://www.dmtf.org/sites/default/files/standards/documents/DSP0202\\_1.0.0.pdf](http://www.dmtf.org/sites/default/files/standards/documents/DSP0202_1.0.0.pdf)

**Common Information Model (CIM) Standards**

<http://www.dmtf.org/standards/cim>

**DMTF website**

<http://www.dmtf.org>

**DMTF DSP0226: Web Services for Management (WS-Management) Specification**

[http://www.dmtf.org/sites/default/files/standards/documents/DSP0226\\_1.0.0.pdf](http://www.dmtf.org/sites/default/files/standards/documents/DSP0226_1.0.0.pdf)

**DMTF DSP0227: WS-Management CIM Binding Specification**

[http://www.dmtf.org/sites/default/files/standards/documents/DSP0227\\_1.0.0.pdf](http://www.dmtf.org/sites/default/files/standards/documents/DSP0227_1.0.0.pdf)

**DMTF DSP0230: WS-CIM Mapping Specification**

[http://www.dmtf.org/sites/default/files/standards/documents/DSP0230\\_1.0.1.pdf](http://www.dmtf.org/sites/default/files/standards/documents/DSP0230_1.0.1.pdf)

**eServer Common Information Model**

[http://publib.boulder.ibm.com/infocenter/eserver/v1r1/en\\_US/info/ciminfo/eicah.pdf](http://publib.boulder.ibm.com/infocenter/eserver/v1r1/en_US/info/ciminfo/eicah.pdf)

**LookAt website for online message explanations**

<http://www.ibm.com/systems/z/os/zos/bkserv/lookat/>

**OpenPegasus website**

<http://www.openpegasus.org>

**SNIA website**

<http://www.snia.org/>

**SourceForge.net**

<http://sourceforge.net/>

**Specification for CIM Operations over HTTP**

[http://www.dmtf.org/standards/published\\_documents/DSP0200\\_1.3.0.pdf](http://www.dmtf.org/standards/published_documents/DSP0200_1.3.0.pdf)

**Storage Management Initiative Specification (SMI-S)**

[http://www.snia.org/tech\\_activities/standards/curr\\_standards/smi/](http://www.snia.org/tech_activities/standards/curr_standards/smi/)

**WBEM standards**

<http://www.dmtf.org/standards/wbem>

**Web Services for Management**

[http://dmtf.org/sites/default/files/standards/documents/DSP0226\\_1.1.pdf](http://dmtf.org/sites/default/files/standards/documents/DSP0226_1.1.pdf)

**WS-CIM Mapping specification**

[http://dmtf.org/sites/default/files/standards/documents/DSP0230\\_1.0.2.pdf](http://dmtf.org/sites/default/files/standards/documents/DSP0230_1.0.2.pdf)

**WS-Management CIM Binding Specification**

[http://dmtf.org/sites/default/files/standards/documents/DSP0227\\_1.1.0.pdf](http://dmtf.org/sites/default/files/standards/documents/DSP0227_1.1.0.pdf)



**z/OS information updates on the web**

[http://publibz.boulder.ibm.com/cgi-bin/bookmgr\\_OS390/BOOKS/ZIDOCMST/CCONTENTS](http://publibz.boulder.ibm.com/cgi-bin/bookmgr_OS390/BOOKS/ZIDOCMST/CCONTENTS)

## Legend for graphics showing class structures

The graphics in this book showing class structures illustrate the CIM object modeling using the UML syntax:

Table 9. UML syntax

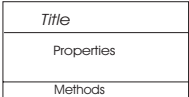
Construct	Description	Syntax
association	A relationship between two or more classifiers that involves connections among their instances.	
aggregation	A special form of association that specifies a whole-part relationship between the aggregate (whole) and the component part.	
inheritance	A relationship among classes where one class shares the structure and/or behavior defined for one or more other classes. Inheritance is the mechanism that makes generalization, subclasses, and superclasses possible.	
class	Denotes the representation of a CIM class in UML notation with title, properties, and methods.	





---

## How to read syntax diagrams

This section describes how to read syntax diagrams. It defines syntax diagram symbols, items that may be contained within the diagrams (keywords, variables, delimiters, operators, fragment references, operands) and provides syntax examples that contain these items.

Syntax diagrams pictorially display the order and parts (options and arguments) that comprise a command statement. They are read from left to right and from top to bottom, following the main path of the horizontal line.

For users accessing the Information Center using a screen reader, syntax diagrams are provided in dotted decimal format.

---

## Symbols

The following symbols may be displayed in syntax diagrams:

Symbol	Definition
▶—	Indicates the beginning of the syntax diagram.
—→	Indicates that the syntax diagram is continued to the next line.
▶—	Indicates that the syntax is continued from the previous line.
—▶	Indicates the end of the syntax diagram.

---

## Syntax items

Syntax diagrams contain many different items. Syntax items include:

- Keywords - a command name or any other literal information.
- Variables - variables are italicized, appear in lowercase, and represent the name of values you can supply.
- Delimiters - delimiters indicate the start or end of keywords, variables, or operators. For example, a left parenthesis is a delimiter.
- Operators - operators include add (+), subtract (-), multiply (\*), divide (/), equal (=), and other mathematical operations that may need to be performed.
- Fragment references - a part of a syntax diagram, separated from the diagram to show greater detail.
- Separators - a separator separates keywords, variables or operators. For example, a comma (,) is a separator.

**Note:** If a syntax diagram shows a character that is not alphanumeric (for example, parentheses, periods, commas, equal signs, a blank space), enter the character as part of the syntax.

Keywords, variables, and operators may be displayed as required, optional, or default. Fragments, separators, and delimiters may be displayed as required or optional.

Item type	Definition
<b>Required</b>	Required items are displayed on the main path of the horizontal line.

<b>Optional</b>	Optional items are displayed below the main path of the horizontal line.
<b>Default</b>	Default items are displayed above the main path of the horizontal line.

## Syntax examples

The following table provides syntax examples.

Table 10. Syntax examples

Item	Syntax example
Required item.	
Required items appear on the main path of the horizontal line. You must specify these items.	
Required choice.	
A required choice (two or more items) appears in a vertical stack on the main path of the horizontal line. You must choose one of the items in the stack.	
Optional item.	
Optional items appear below the main path of the horizontal line.	
Optional choice.	
An optional choice (two or more items) appears in a vertical stack below the main path of the horizontal line. You may choose one of the items in the stack.	
Default.	
Default items appear above the main path of the horizontal line. The remaining items (required or optional) appear on (required) or below (optional) the main path of the horizontal line. The following example displays a default with optional items.	
Variable.	
Variables appear in lowercase italics. They represent names or values.	
Repeatable item.	
An arrow returning to the left above the main path of the horizontal line indicates an item that can be repeated.	
A character within the arrow means you must separate repeated items with that character.	
An arrow returning to the left above a group of repeatable items indicates that one of the items can be selected, or a single item can be repeated.	

Table 10. Syntax examples (continued)

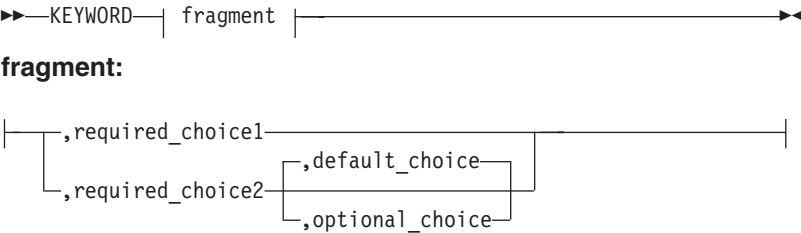
Item	Syntax example
<p>Fragment.</p> <p>The fragment symbol indicates that a labelled group is described below the main syntax diagram. Syntax is occasionally broken into fragments if the inclusion of the fragment would overly complicate the main syntax diagram.</p>	 <p>The diagram shows a fragment symbol: a double arrow pointing right, followed by the text 'KEYWORD', a vertical bar, the text 'fragment', another vertical bar, and a long horizontal line ending in a double arrow pointing right. Below this, the word 'fragment:' is written. Underneath, a choice structure is shown: a vertical bar on the left, a horizontal line to the right, and a vertical bar on the right. From the horizontal line, two lines branch downwards to the left, labeled ',required_choice1' and ',required_choice2'. From the vertical bar on the right, two lines branch downwards to the left, labeled ',default_choice' and ',optional_choice'. The lines for ',required_choice1' and ',optional_choice' meet at the right vertical bar. The lines for ',required_choice2' and ',default_choice' meet at the right vertical bar.</p>



---

## Accessibility

Accessible publications for this product are offered through the z/OS Information Center, which is available at <http://www.ibm.com/systems/z/os/zos/bkserv/>. If you experience any accessibility problems with the z/OS Information Center, send an email to [mhvrcfs@us.ibm.com](mailto:mhvrcfs@us.ibm.com) or write to the following address:

IBM Corporation  
Attention: MHVRCFS Reader Comments  
Department H6MA, Building 707  
2455 South Road  
Poughkeepsie, NY 12601-5400  
USA

Accessibility features help a user who has a physical disability, such as restricted mobility or limited vision, to use software products successfully. The major accessibility features in z/OS enable users to:

- Use assistive technologies such as screen readers and screen magnifier software
- Operate specific or equivalent features using only the keyboard
- Customize display attributes such as color, contrast, and font size.

---

## Using assistive technologies

Assistive technology products, such as screen readers, function with the user interfaces found in z/OS. Consult the assistive technology documentation for specific information when using such products to access z/OS interfaces.

---

## Keyboard navigation of the user interface

Users can access z/OS user interfaces using TSO/E or ISPF. Refer to *z/OS TSO/E Primer*, *z/OS TSO/E User's Guide*, and *z/OS ISPF User's Guide Vol I* for information about accessing TSO/E and ISPF interfaces. These guides describe how to use TSO/E and ISPF, including the use of keyboard shortcuts or function keys (PF keys). Each guide includes the default settings for the PF keys and explains how to modify their functions.



---

## Dotted decimal syntax diagrams

Syntax diagrams are provided in dotted decimal format for users accessing the Information Center using a screen reader. In dotted decimal format, each syntax element is written on a separate line. If two or more syntax elements are always present together (or always absent together), they can appear on the same line, because they can be considered as a single compound syntax element.

Each line starts with a dotted decimal number; for example, 3 or 3.1 or 3.1.1. To hear these numbers correctly, make sure that your screen reader is set to read out punctuation. All the syntax elements that have the same dotted decimal number (for example, all the syntax elements that have the number 3.1) are mutually exclusive alternatives. If you hear the lines 3.1 USERID and 3.1 SYSTEMID, you know that your syntax can include either USERID or SYSTEMID, but not both.

The dotted decimal numbering level denotes the level of nesting. For example, if a syntax element with dotted decimal number 3 is followed by a series of syntax elements with dotted decimal number 3.1, all the syntax elements numbered 3.1 are subordinate to the syntax element numbered 3.

Certain words and symbols are used next to the dotted decimal numbers to add information about the syntax elements. Occasionally, these words and symbols might occur at the beginning of the element itself. For ease of identification, if the word or symbol is a part of the syntax element, it is preceded by the backslash (\) character. The \* symbol can be used next to a dotted decimal number to indicate that the syntax element repeats. For example, syntax element \*FILE with dotted decimal number 3 is given the format 3 \\* FILE. Format 3\* FILE indicates that syntax element FILE repeats. Format 3\* \\* FILE indicates that syntax element \* FILE repeats.

Characters such as commas, which are used to separate a string of syntax elements, are shown in the syntax just before the items they separate. These characters can appear on the same line as each item, or on a separate line with the same dotted decimal number as the relevant items. The line can also show another symbol giving information about the syntax elements. For example, the lines 5.1\*, 5.1 LASTRUN, and 5.1 DELETE mean that if you use more than one of the LASTRUN and DELETE syntax elements, the elements must be separated by a comma. If no separator is given, assume that you use a blank to separate each syntax element.

If a syntax element is preceded by the % symbol, this indicates a reference that is defined elsewhere. The string following the % symbol is the name of a syntax fragment rather than a literal. For example, the line 2.1 %OP1 means that you should refer to separate syntax fragment OP1.

The following words and symbols are used next to the dotted decimal numbers:

- ? means an optional syntax element. A dotted decimal number followed by the ? symbol indicates that all the syntax elements with a corresponding dotted decimal number, and any subordinate syntax elements, are optional. If there is only one syntax element with a dotted decimal number, the ? symbol is displayed on the same line as the syntax element, (for example 5? NOTIFY). If there is more than one syntax element with a dotted decimal number, the ? symbol is displayed on a line by itself, followed by the syntax elements that are

optional. For example, if you hear the lines 5 ?, 5 NOTIFY, and 5 UPDATE, you know that syntax elements NOTIFY and UPDATE are optional; that is, you can choose one or none of them. The ? symbol is equivalent to a bypass line in a railroad diagram.

- ! means a default syntax element. A dotted decimal number followed by the ! symbol and a syntax element indicates that the syntax element is the default option for all syntax elements that share the same dotted decimal number. Only one of the syntax elements that share the same dotted decimal number can specify a ! symbol. For example, if you hear the lines 2? FILE, 2.1! (KEEP), and 2.1 (DELETE), you know that (KEEP) is the default option for the FILE keyword. In this example, if you include the FILE keyword but do not specify an option, default option KEEP will be applied. A default option also applies to the next higher dotted decimal number. In this example, if the FILE keyword is omitted, default FILE(KEEP) is used. However, if you hear the lines 2? FILE, 2.1, 2.1.1! (KEEP), and 2.1.1 (DELETE), the default option KEEP only applies to the next higher dotted decimal number, 2.1 (which does not have an associated keyword), and does not apply to 2? FILE. Nothing is used if the keyword FILE is omitted.
- \* means a syntax element that can be repeated 0 or more times. A dotted decimal number followed by the \* symbol indicates that this syntax element can be used zero or more times; that is, it is optional and can be repeated. For example, if you hear the line 5.1\* data area, you know that you can include one data area, more than one data area, or no data area. If you hear the lines 3\*, 3 HOST, and 3 STATE, you know that you can include HOST, STATE, both together, or nothing.

**Notes:**

1. If a dotted decimal number has an asterisk (\*) next to it and there is only one item with that dotted decimal number, you can repeat that same item more than once.
  2. If a dotted decimal number has an asterisk next to it and several items have that dotted decimal number, you can use more than one item from the list, but you cannot use the items more than once each. In the previous example, you could write HOST STATE, but you could not write HOST HOST.
  3. The \* symbol is equivalent to a loop-back line in a railroad syntax diagram.
- + means a syntax element that must be included one or more times. A dotted decimal number followed by the + symbol indicates that this syntax element must be included one or more times; that is, it must be included at least once and can be repeated. For example, if you hear the line 6.1+ data area, you must include at least one data area. If you hear the lines 2+, 2 HOST, and 2 STATE, you know that you must include HOST, STATE, or both. Similar to the \* symbol, the + symbol can only repeat a particular item if it is the only item with that dotted decimal number. The + symbol, like the \* symbol, is equivalent to a loop-back line in a railroad syntax diagram.



---

## Notices

This information was developed for products and services offered in the U.S.A.

IBM may not offer the products, services, or features discussed in this document in other countries. Consult your local IBM representative for information about the products and services currently available in your area. Any reference to an IBM product, program, or service is not intended to state or imply that only that IBM product, program, or service may be used. Any functionally equivalent product, program, or service that does not infringe any IBM intellectual property right may be used instead. However, it is the user's responsibility to evaluate and verify the operation of any non-IBM product, program, or service.

IBM may have patents or pending patent applications covering subject matter described in this document. The furnishing of this document does not give you any license to these patents. You can send license inquiries, in writing, to:

IBM Director of Licensing  
IBM Corporation  
North Castle Drive  
Armonk, NY 10504-1785  
U.S.A.

Licensees of this program who wish to have information about it for the purpose of enabling: (i) the exchange of information between independently created programs and other programs (including this one) and (ii) the mutual use of the information which has been exchanged, should contact:

IBM Corporation  
Mail Station P300  
2455 South Road  
Poughkeepsie New York 12601-5400  
U.S.A.

Such information may be available, subject to appropriate terms and conditions, including in some cases, payment of a fee.

The licensed program described in this document and all licensed material available for it are provided by IBM under terms of the IBM Customer Agreement, IBM International Program License Agreement or any equivalent agreement between us.

For license inquiries regarding double-byte (DBCS) information, contact the IBM Intellectual Property Department in your country or send inquiries, in writing, to:

Intellectual Property Licensing  
Legal and Intellectual Property Law  
IBM Japan, Ltd.  
1623-14, Shimotsuruma, Yamato-shi  
Kanagawa 242-8502 Japan

The following paragraph does not apply to the United Kingdom or any other country where such provisions are inconsistent with local law: INTERNATIONAL

BUSINESS MACHINES CORPORATION PROVIDES THIS PUBLICATION "AS IS" WITHOUT WARRANTY OF ANY KIND, EITHER EXPRESS OR IMPLIED, INCLUDING, BUT NOT LIMITED TO, THE IMPLIED WARRANTIES OF NON-INFRINGEMENT, MERCHANTABILITY OR FITNESS FOR A PARTICULAR PURPOSE. Some states do not allow disclaimer of express or implied warranties in certain transactions, therefore, this statement may not apply to you.

This information could include technical inaccuracies or typographical errors. Changes are periodically made to the information herein; these changes will be incorporated in new editions of the publication. IBM may make improvements and/or changes in the product(s) and/or the program(s) described in this publication at any time without notice.

Any references in this information to non-IBM websites are provided for convenience only and do not in any manner serve as an endorsement of those websites. The materials at those websites are not part of the materials for this IBM product and use of those websites is at your own risk.

If you are viewing this information softcopy, the photographs and color illustrations may not be visible.

---

## Programming Interface Information

This book is intended to help the customer to use the Common Information Model to write system management applications for z/OS systems.

The book also documents intended Programming Interfaces that allow the customer to write programs to obtain the services of CIM.

---

## Trademarks

IBM, the IBM logo, and [ibm.com](http://www.ibm.com)<sup>®</sup> are trademarks or registered trademarks of International Business Machines Corporation in the United States, other countries, or both. If these and other IBM trademarked terms are marked on their first occurrence in this information with a trademark symbol (<sup>®</sup> or <sup>™</sup>), these symbols indicate U.S. registered or common law trademarks owned by IBM at the time this information was published. Such trademarks may also be registered or common law trademarks in other countries. A current list of IBM trademarks is available on the Web at "Copyright and trademark information" at <http://www.ibm.com/legal/copytrade.shtml>.

Adobe, the Adobe logo, PostScript, and the PostScript logo are either registered trademarks or trademarks of Adobe Systems Incorporated in the United States, and/or other countries.

UNIX is a registered trademark of The Open Group in the United States and other countries.

Linux is a registered trademark of Linus Torvalds in the United States, other countries, or both.

Java and all Java-based trademarks and logos are trademarks of Sun Microsystems, Inc. in the United States, other countries, or both.

Other company, product, or service names may be trademarks or service marks of others.

---

## Terms and conditions for downloading and printing publications

Permissions for the use of the publications you have selected for download are granted subject to the following terms and conditions and your indication of acceptance thereof.

**Personal Use:** You may reproduce these Publications for your personal, noncommercial use provided that all proprietary notices are preserved. You may not distribute, display or make derivative works of these Publications, or any portion thereof, without the express consent of IBM.

**Commercial Use:** You may reproduce, distribute and display these Publications solely within your enterprise provided that all proprietary notices are preserved. You may not make derivative works of these Publications, or reproduce, distribute or display these Publications or any portion thereof outside your enterprise, without the express consent of IBM.

Except as expressly granted in this permission, no other permissions, licenses or rights are granted, either express or implied, to the Publications or any information, data, software or other intellectual property contained therein.

IBM reserves the right to withdraw the permissions granted herein whenever, in its discretion, the use of the Publications is detrimental to its interest or, as determined by IBM, the above instructions are not being properly followed.

You may not download, export or re-export this information except in full compliance with all applicable laws and regulations, including all United States export laws and regulations. IBM MAKES NO GUARANTEE ABOUT THE CONTENT OF THESE PUBLICATIONS. THE PUBLICATIONS ARE PROVIDED "AS-IS" AND WITHOUT WARRANTY OF ANY KIND, EITHER EXPRESSED OR IMPLIED, INCLUDING BUT NOT LIMITED TO IMPLIED WARRANTIES OF MERCHANTABILITY AND FITNESS FOR A PARTICULAR PURPOSE.

All material copyrighted by IBM Corporation.

By downloading or printing a publication from this site, you have indicated your agreement with these terms and conditions.



---

# Index

## Special characters

\_\_TAG\_REDIR\_ERR 52  
\_\_TAG\_REDIR\_IN 52  
\_BPX\_JOBNAME 50, 73  
\_BPX\_SHAREAS 28, 52, 66  
\_BPXK\_AUTOCVT 52  
\_CEE\_RUNOPTS 52  
\_TAG\_REDIR\_ERR 52  
\_TAG\_REDIR\_IN 52  
\_TAG\_REDIR\_OUT 52

## A

accessibility 365  
    contact IBM 365  
    features 365  
ADDUSER command 25  
administrator access 28  
ALTUSER command 25  
APPL 35  
Application Transparent Transport Layer Security  
    *See* AT-TLS  
ARM 39, 74  
    element name 75  
    policy 75  
    security 36  
ASCII 52, 69, 292  
ASCII-EBCDIC conversion 337  
assistive technologies 365  
association  
    classes 106, 107, 129  
    provider function 291  
AT-TLS 11, 12, 29  
audit logging 73  
authentication 11, 12, 28  
    based on SSL certificates 31  
authorization 11, 13, 25, 42  
    check 43  
    model 25  
    model, provider-based 43  
    of users 20  
automatic restart 74  
Automatic Restart Manager  
    *See* ARM

## B

backup  
    CIM server configuration 74  
    CIM server repository 77  
Base classes 125, 130  
BaseBoard classes 125, 143  
BPX parmlib member 21  
BPX.DAEMON 27  
BPX.JOBNAME 66  
BPX.POE 35  
BPX.SERVER 20, 25  
BPX.SMF 73  
BPX.SRV 25, 29

## C

- CDT 24
- CDTINFO 24
- CEA 38, 39, 41, 353
- certificate 11, 29, 30, 31
- Certificate Authority 30
- CFRM 39
- CFZAPPL 35
- CFZARMP 75
- CFZCIM 19, 21, 50, 65, 73, 74
  - customization 50
  - start 65
  - stop 65
- CFZIVP 19, 22
- CFZRCUST 19, 20
  - customization 46
- CFZRCUST parameter
  - noDS 48
  - noSpaceCheck 47, 48
- CFZSEC 19, 341
  - step BASICSUP 341
  - step CRUSR 342
  - step CRWBEM 343
  - step ENCLCDS 348
  - step ENRMF 351
  - step ENSMIS 349
  - step ENSTC 346
  - step ENTICIP 350
  - step ENWLM 350
  - step PEAPPL 345
  - step PECEA 347
  - step PEUSR 344
  - step SETARM 345
- CFZSRV 21, 25
- CFZSRVGP 25
- CIM
  - introduction 3
- CIM client 4, 5
  - authentication 29, 31
  - request 79, 88
- CIM client for Java 4
- CIM Event Model 7
- CIM indication
  - See* indication
- CIM instrumentation 121
- CIM listener 9
- CIM model 121
- CIM operations 88, 129
- CIM operations over HTTP 4
- CIM provider
  - See* provider
- CIM Query Language 9
- CIM registered profile
  - HBA 121, 123
  - HDR 121
- CIM registered profiles 121
  - SMI-S 121
- CIM Schema 4
- CIM server 4
  - access 24, 28
  - administration 65
  - automatic restart 74
  - configuration 55
  - configuration backup 74
  - configuration for audit logging 73
  - logging configuration 71
  - logon 28

- CIM server *(continued)*
  - quick security setup 19
  - quick setup 19
  - request 23
  - runtime configuration 29
  - runtime environment 28
  - runtime environment security 11
  - security 11
  - security setup 23
  - setup 45
  - setup verification 19
  - start 19, 21, 50, 52, 65
  - stop 65
- CIM server group
  - definition 25
- CIM server user 21
  - and identity switch 29
  - and resource authorization 26
  - association with a started task 50
  - authorization to register to ARM 36
  - definition 25, 26
- CIM\_AlertIndication 304
- CIM\_ComputerSystem 131
- CIM\_ComputerSystemPackage 146
- CIM\_ControlledBy 242
- CIM\_DeviceSAPImplementation 242
- CIM\_ElementSoftwareIdentity 242
- CIM\_ElementStatisticalData 242
- CIM\_EthernetPort 162
- CIM\_FCPort 241
- CIM\_FCPortStatistics 241
- CIM\_HostedAccessPoint 242
- CIM\_HostedFileSystem 156
- CIM\_Indication 303, 304
- CIM\_IndicationFilter 9, 306
- CIM\_IndicationSubscription 9, 307
- CIM\_InitiatorTargetLogicalUnitPath 242
- CIM\_InstalledSoftwareIdentity 242
- CIM\_InstIndication 303, 305
- CIM\_InstModification 305
- CIM\_IPProtocolEndpoint 162
- CIM\_ListenerDestinationCIMXML 9, 305, 306
- CIM\_LocalFileSystem 156
- CIM\_LogicalDisk 152
- CIM\_OperatingSystem 131
- CIM\_OSProcess 131
- CIM\_PortController 241
- CIM\_PortImplementsEndpoint 162
- CIM\_Process 132
- CIM\_ProcessClassIndication 303
- CIM\_ProcessIndication 304
- CIM\_Processor 148
- CIM\_Product 241
- CIM\_ProductElementComponent 243
- CIM\_ProtocolEndpoint 241
- CIM\_RemoteFileSystem 156
- CIM\_RunningOS 132
- CIM\_SNMPTrapIndication 305
- CIM\_SoftwareIdentity 241
- CIM\_StorageExtent 241
- CIM\_SystemDevice 148, 162, 243
- cimcli 88
  - a, associators 89
  - an, associatorNames 90
  - ci, createInstance 91
  - dc, deleteClass 92
  - di, deleteInstance 93

- cimcli (*continued*)
  - dq, deleteQualifier 94
  - ec, enumerateClasses 95
  - ei, enumerateInstances 96
  - eq, enumerateQualifiers 97
  - gc, getClass 98
  - gi, getInstance 99
  - gq, getQualifier 100
  - im, invokeMethod 101
  - instance specification 113
  - mi, modifyInstance 102
  - nc, enumerateClassNames 103
  - ni, enumerateInstanceNames 104
  - ns, enumerateNamespaces 105
  - options 111
  - r, references 106
  - rn, referenceNames 107
  - sp, setProperty 108
  - ti, testInstance 109
  - xq, execQuery 110
- cimconfig 67, 68, 83
  - options 55
- CIMIVP 61
- cimmof 81
- cimprovider 44, 85
- CIMSERV 11, 13, 25, 28, 79
  - definition 24
- cimserver command 66
- cimserver\_planned.conf 74
- cimserver.env 17, 18, 50, 51, 65, 74
- cimserver.err 50
- cimserver.out 50
- cimserver.trc 69
- cimsub 114
- class descriptor table 24
- class SURROGAT 25
- client 4, 5
  - authentication 29, 31
  - user 29
- Cluster classes 126, 200
- Cluster provider setup 38
- CMPI 287
  - header files 288
- CMPI provider
  - function signatures 290
  - initialization 290
  - samples 301
  - security 291
- command
  - syntax diagrams 361
- command-line utilities 79
- commands 79
- Common Area Data Space 39
- Common Event Adapter
  - See* CEA
- Common Information Model
  - See* CIM
- Common Manageability Programming Interface
  - See* CMPI
- compilation 81
- concepts of CIM 3
- configuration properties 55
  - dynamic 55, 67
  - for tracing 68
  - modification 117
  - modification, current 67
  - modification, planned 67, 117



- configuration property
  - daemon 55
  - enableAuditLog 55, 73
  - enableHttpConnection 55
  - enableHttpsConnection 29, 56
  - enableIndicationService 56
  - enableRemotePrivilegedUserAccess 56
  - forceProviderProcesses 56, 66, 301
  - httpPort 45, 56
  - httpsPort 29, 45, 56
  - idleConnectionTimeout 56
  - logLevel 56, 71, 72
  - maxFailedProviderModuleRestarts 57
  - maxIndicationDeliveryRetryAttempts 57
  - maxProviderProcesses 57
  - messageDir 57
  - minIndicationDeliveryRetryInterval 57
  - providerDir 57
  - repositoryDir 57
  - repositoryIsDefaultInstanceProvider 57
  - shutdownTimeout 58
  - slp 58
  - socketWriteTimeout 58
  - traceComponents 58, 68
  - traceFacility 58, 69, 71
  - traceFilePath 58, 69
  - traceLevel 59, 68
  - traceMemoryBufferKbytes 59, 69
- connectivity 121
- console 71, 74, 117
- CoupleDataset provider setup 38
- CQL 9
- createClass 88
- current configuration property 67, 83

## D

- daemon configuration property 55
- data encryption 11
- DDNAME 50
- DDS 37, 53
- DeliveryRetryAttempts property 8
- DeliveryRetryInterval property 8
- designated user 13, 25, 42, 291
- DesignatedUserContext property 43, 292
- directory paths 20
  - base hierarchical file system 17
  - CIM client for Java 17
  - CIM message files for NLS 17
  - CIM provider libraries provided with z/OS 17
  - CIM schema master repository 17
  - CIM server executables 17
  - CIM server libraries 17
  - configuration files 48
  - data repository 48
  - DMTF CIM schema files (MOF) 17
  - IBM z/OS instrumentation MOF files 17
  - log 48
  - sample profile 17
  - SMP/E target library path 17
  - started task environment 48
- Distributed Data Server
  - See* DDS
- Distributed Management Task Force
  - See* DMTF
- DMTF xi, 3

- dynamic
  - CDT 24
  - configuration property 55, 67
- dynamic load library 13
  - program control 13

## E

- EBCDIC 52, 292, 337
- ELEMTerm termination type 75
- enableAuditLog configuration property 55, 73
- enableHttpConnection configuration property 55
- enableHttpsConnection configuration property 29, 56
- enableIndicationService configuration property 56
- enableRemotePrivilegedUserAccess configuration property 56
- encryption 11, 29, 31
  - key 35
- Enhanced ASCII 337
- Enhanced Security model 13, 25
- EnumerateInstanceNames 129
- EnumerateInstances 129
- environment variable 51
  - \_BPX\_JOBNAME 73
  - \_BPX\_SHAREAS 28, 52
  - \_BPXK\_AUTOCVT 52
  - \_CEE\_RUNOPTS 52
  - \_TAG\_REDIR\_ERR 52
  - \_TAG\_REDIR\_IN 52
  - \_TAG\_REDIR\_OUT 52
  - LIBPATH 52
  - OSBASE\_TRACE 53
  - OSBASE\_TRACE\_FILE 53
  - PATH 53
  - PEGASUS\_HOME 51, 52
  - RMF\_CIM\_BENCH 53
  - RMF\_CIM\_HOST 53
  - RMF\_CIM\_PORT 53
  - RMF\_CIM\_PROVIDER 53
  - RMF\_CIM\_TRACE 53
  - RMF\_CIM\_TRACE\_FILE 53
  - WLM\_CIMPROVIDER\_TRACE\_FILE 53
  - WLM\_CIMPROVIDER\_TRACE\_LEVEL 53
- environment variables
  - file cimserver.env 17, 50, 51, 74
  - file profile.add 50, 51, 337
  - modification 52
- EOTRACE 69
- error messages 337
- eServer CIM 6
- event 7
  - subscription 7
- Event Model 7
- event provider function 291
- extattr 27

## F

- fallback 18
- FATAL log level 71
- file system 20
- File System classes 125, 155
- filter condition 7
- forceProviderProcesses configuration property 56, 66, 301

## G

- GetInstance 129
- GID
  - definition, CIM server 25
- group ID
  - See GID

## H

- HBA 121, 123
  - Hot Swap Events 123
  - instance diagram 123
- HDR 121
- header files
  - CMPI 288
- host adapter 121
- Host Discovered Resources
  - instance diagram 122
  - profile 121
- Host-Bus-Adapter
  - See HBA
- HTTP 21, 28
- HTTP port 45
- HTTP\_NOAUTH 37
- httpPort
  - configuration property 45
- httpPort configuration property 45, 56
- HTTPS 21, 28, 29
- HTTPS port 45
- httpsPort
  - configuration property 45
- httpsPort configuration property 29, 56

## I

- IBM\_BaseBoard 144
- IBMzOS\_SBDDeviceSAPIImplementation 273
- IBMzOS\_SBInitiatorTargetLogicalUnitPath 154, 275
- IBMzOS\_BaseBoard 145
- IBMzOS\_CFRMCoupleDataset 201
- IBMzOS\_CFRMPolicy 203
- IBMzOS\_CFStrDependsOn 237
- IBMzOS\_CFStructure 205
- IBMzOS\_CFStructureConnector 214
- IBMzOS\_CollectionOfCFs 237
- IBMzOS\_CollectionOfSysplexNodes 237
- IBMzOS\_ComputerSystem 133
- IBMzOS\_ControlledBy 266
- IBMzOS\_CoupleDataset 217
- IBMzOS\_CouplingFacility 221
- IBMzOS\_CouplingFunction 225
- IBMzOS\_CSBaseBoard 146
- IBMzOS\_CSFCPort 267
- IBMzOS\_CSFCPortController 268
- IBMzOS\_ElementSoftwareIdentity 269
- IBMzOS\_EthernetPort 163
- IBMzOS\_FCCUPort 244
- IBMzOS\_FCPort 249
- IBMzOS\_FCPortStatisticalData 270
- IBMzOS\_FCPortStatistics 255
- IBMzOS\_FCSBPort 257
- IBMzOS\_HostedCFStrConnector 238
- IBMzOS\_HostedCFStructure 238
- IBMzOS\_InstalledSoftwareIdentity 271
- IBMzOS\_IPProtocolEndpoint 165
- IBMzOS\_JES2Job 168

- IBMzOS\_JES2SysoutDataset 188
- IBMzOS\_JES3Job 179
- IBMzOS\_JES3SysoutDataset 192
- IBMzOS\_Job 193
- IBMzOS\_JobsManagementSettings 194
- IBMzOS\_LogicalDisk 153
- IBMzOS\_LogicalDiskDevice 154
- IBMzOS\_NFS 159
- IBMzOS\_OperatingSystem 135
- IBMzOS\_OSProcess 137
- IBMzOS\_PortController 258
- IBMzOS\_Process 138
- IBMzOS\_Processor 149
- IBMzOS\_Product 260
- IBMzOS\_ProductElementComponent 272
- IBMzOS\_RunningOS 140
- IBMzOS\_SBHostedAccessPoint 274
- IBMzOS\_SBProtocolEndpoint 261
- IBMzOS\_SFMAAttributes 229
- IBMzOS\_SoftwareIdentity 263
- IBMzOS\_Subsystem 195
- IBMzOS\_SubsystemJES2Jobs 198
- IBMzOS\_SubsystemJES3Jobs 198
- IBMzOS\_SysoutDataset 197
- IBMzOS\_Sysplex 230
- IBMzOS\_SysplexCoupleDataset 233
- IBMzOS\_SysplexNode 234
- IBMzOS\_UnixLocalFileSystem 157
- IBMzOS\_UnixProcess 141
- IBMzOS\_UsesCFRMCoupleDatasets 239
- IBMzOS\_UsesCFRMPolicies 240
- IBMzOS\_UsesCFs 239
- IBMzOS\_UsesCouplingFunctions 240
- IBMzOS\_UsesJES2SysoutDatasets 198
- IBMzOS\_UsesJES3SysoutDatasets 198
- IBMzOS\_UsesSysplexCoupleDatasets 240
- IBMzOS\_WLM 278
- IBMzOS\_WLMOS 283
- ICHRIN03 started procedures table 50
- IClassifyBy cimelement\_def.dita ii
- identity switch 29
- idleConnectionTimeout configuration property 56
- INADDRANYCOUNT 21
- INADDRANYPORT 21
- indication 7, 303
  - end point 33
  - hierarchy 303
  - provider 9
  - provider function 291
  - secured 33
  - stream 305, 306
  - subscription 305
- indication delivery retry 8
- INFORMATION log level 71
- installation 17
  - directories 17
  - verification 19, 22, 61
- installation verification program
  - See IVP
- instance provider function 290
- Internal Providert
  - Internal Provider 68
- introduction to CIM 3
- IOS service 41
- IOSCDR 41
- IOSCHPD 41
- IVP 19, 22, 61

IXCARM 36  
IXCL1DSU format utility 39

## J

Java  
    CIM client 4  
JES2Job provider setup 38  
JES3Job provider setup 38  
Job classes 126, 167

## K

key 30, 35  
key ring 30  
keyboard  
    navigation 365  
    PF keys 365  
    shortcut keys 365

## L

LIBPATH environment variable 17, 52, 53  
lifetime 8  
log 71  
    level 72  
        FATAL 71  
        INFORMATION 71  
        SEVERE 71  
        TRACE 71  
        WARNING 71  
    level modification 71  
    message 69, 71, 72  
    records for audit logging 73  
    routing 70  
logging 71, 72  
    *See* log  
Logical Disk classes 151  
logical storage resource 121  
logLevel configuration property 72  
logLevel configuration property 56, 71  
LogMessages trace component 70, 71  
logon  
    to the CIM server 28, 35

## M

managed object format  
    *See* MOF  
management instrumentation  
    for additional z/OS resources 287  
master repository 17  
maxFailedProviderModuleRestarts configuration property 57  
maxIndicationDeliveryRetryAttempts configuration property 57  
maxProviderProcesses configuration property 57  
memory dump 69  
message  
    shutdown 74  
    startup 74  
messageDir configuration property 57  
messages 311  
    troubleshooting 337  
method provider function 291  
migration 17  
minIndicationDeliveryRetryInterval configuration property 57

- MLS 35, 56
- MODIFY console command 67, 68, 117
- modifyClass 88
- modifyInstance 88
- ModuleGroupName 67, 301
- MOF 79
  - compiler 81
  - file, provider registration 43, 44
- monitoring provider 53
- multi level security
  - See MLS
- must-stay-clean 26

## N

- navigation
  - keyboard 365
- Network classes 126, 160
- Network provider setup 38
- NOOIDCARD attribute 25
- NOPASSWORD attribute 25
- NOPHRASE attribute 25

## O

- oidcard 43
- OOP
  - See out-of-process support
- OpenPegasus 4
- OS (operating system) 5
- OS management
  - Base classes 125, 130
  - BaseBoard classes 125, 143
  - Cluster classes 126, 200
  - File System classes 125, 155
  - Job classes 126, 167
  - Logical Disk classes 151
  - Network classes 126, 160
  - Processor classes 125, 147
- OSBASE\_TRACE 53
- OSBASE\_TRACE\_FILE 53
- out-of-process support 26, 56, 66
  - developing providers OOP 301
  - tracing providers 70

## P

- PARMLIB 38
- passphrase 43
- PassTicket 11
  - authentication 37
  - keymask 20
  - passkey 20
  - validation 35
- password 11
- PATH 53
- PEGASUS\_HOME 51, 52
- PEGASUMEMTRACE 69
- performance benchmark 53
- performance implications 70
- PG\_Provider 43, 293, 296
- PG\_ProviderCapabilities 293, 299
- PG\_ProviderModule 43, 293, 297
- planned configuration property 67, 83
  - file cimserver\_planned.conf 74

- policy
  - inbound 31, 32
  - outbound 32, 33
- Policy Agent 29
  - setup 30
- port 45
- port 5980 21
- port 5988 21
- port number 45
- POSIT 24, 343
- PreviousInstance 305
- PreviousInstance property 304
- priority for z/OS CIM 54
- privileged user 25, 26
- Processor classes 125, 147
- profile.add 50, 51, 337
- program control 27
- protected user
  - definition 25
- protection of resources 11
- provider 4
  - based authorization 13, 43
  - CMPI 287
  - development 287
  - disabling 85
  - enabling 85
  - function signatures 290
  - function, association 291
  - function, indication 291
  - function, instance 290
  - function, method 291
  - IBM-supplied 125
  - initialization 290
  - listing 85
  - profile 13
  - registration 293
  - registration compilation 81
  - registration MOF file 43, 44, 301
  - registration processing 294
  - registration schema 293
  - removal 85
  - RMF 53
  - samples 301
  - security 291
  - setup 38, 39
  - trace 70
  - WLM 53
- provider agent 26, 70, 301
- providerDir configuration property 57
- ProviderModuleName 296
- PTKTDATA 35, 37
- publish/subscribe event paradigm 8

## R

- RACF 23, 37
  - class definition 24
  - class WBEM 24
  - profile definition 24
  - setup 39
- reason codes 353
- repository 17, 57, 81
  - backup 77
  - maintenance 77
  - recovery 77
- repositoryDir configuration property 57
- repositoryIsDefaultInstanceProvider configuration property 57

- requestor 23, 25, 42
  - user ID 43
- resource
  - access 42
  - authorization model 25
- Resource Access Control Facility
  - See* RACF
- Resource Measurement Facility
  - See* RMF
- restart
  - automatic restart using ARM 74
- REXX 39
- RMF 28
  - provider 53
- RMF monitoring 37
- RMF\_CIM\_BENCH 53
- RMF\_CIM\_HOST 37, 53
- RMF\_CIM\_PORT 53
- RMF\_CIM\_PROVIDER 53
- RMF\_CIM\_TRACE 53
- RMF\_CIM\_TRACE\_FILE 53
- runtime
  - configuration 29
  - environment 28
  - environment security 11

## S

- SAF 11, 29, 30, 32, 36, 43, 73, 296, 315, 323, 324, 325, 326
- SAF profile
  - BPX.SERVER 20, 25
  - BPX.SMF 73
  - CFZAPPL 35
  - CIMSERV 24, 28
- SAF profiles
  - security 44
- SB Multipath Management
  - profile 121, 122
- SBLIM 4, 301
- security 11
  - aspects for developing providers 291
  - context 43
  - of the network 12
  - profile 11, 13, 44
  - quick setup for the CIM server 19
  - setup for CIM server 23
  - setup for the CIM server, quick 19
  - using ARM 36
- SecurityAccessProfile 43, 293, 296
- sequence identifier 8
- service class for CIM priority 54
- SEVERE log level 71
- ShareAS 67, 301
- shortcut keys 365
- shutdown message 74
- shutdownTimeout configuration property 58, 117
- slp configuration property 58
- SMF
  - configuration 73
  - record 55, 73
- SMI-S 121
  - profile 121
- SMP/E installation 17, 75
- SNIA 121
- socketWriteTimeout configuration property 58
- SourceInstance 305
- SSL 11, 29



- SSL (*continued*)
  - protected indication delivery 33
  - protection including certificate based authentication 31
  - simple protection 31
- STARTED class 50
- started task 25, 50
  - CFZCIM 65
  - CFZCIM customization 50
- starting the CIM server 19, 21, 65
- startup message 74
- STDENV 50
- stderr 71
- STDERR 50
- STDOUT 50
- stopping the CIM server 65
- storage
  - device 121
  - hardware resources 121
  - network 121
- Storage HBA
  - profile 121, 123
- storage management 41
- Storage management classes 241
- Storage Management Initiative Specification
  - See* SMI-S
- Storage Networking Industry Association
  - See* SNIA
- subscription 7
- SURROGAT class 25, 29
- surrogate 29
- switching identity 29
- syntax check 81
- syntax diagram
  - cimcli 88
  - cimconfig 83
  - cimmof 81
  - cimprovider 85
  - cimsub 114
  - MODIFY 117
- syntax diagrams
  - how to read 361
- syslog
  - configuration file 72
  - daemon 71, 72
    - configuration 73
  - level 72
  - service 72
- syslog.conf 72
- sysplex 36, 74
- SYSREXX support 39
- System Authorization Facility
  - See* SAF
- system logger
  - See* syslog

## T

- TCP/IP 21
  - address 53
  - hostname 53
  - port number 53
- termination type 75
- The Open Group 4
- trace 68
  - buffer size 69
  - components 68
  - configuration 68

- trace (*continued*)
  - disabling 70
  - enabling 68
  - facility 69, 71
  - file 53, 69
  - file name 70
  - level 53, 68
  - level for the RMF CIM provider 53
  - level for the z/OS WLM provider 53
  - message 69, 71
  - modification 68
  - providers 70
  - routing 70
  - variable 51
- trace component
  - All 68, 69
  - Authentication 68
  - Authorization 68
  - BinaryMessageHandler 68
  - CIMExportRequestDispatcher 68
  - CIMOMHandle 68
  - CMPIProvider 68
  - CMPIProviderInterface 68
  - Config 68
  - ControlProvider 68
  - CQL 68
  - DiscardedData 68, 69
  - Dispatcher 68
  - ExportClient 68
  - Http 68
  - IndicationFormatter 68
  - IndicationGeneration 68
  - IndicationHandler 68
  - IndicationReceipt 68
  - IndicationService 68
  - IPC 68
  - L10N 68
  - Listener 68
  - LogMessages 68, 69
  - MessageQueueService 68
  - ObjectResolution 68
  - OsAbstraction 68
  - ProviderAgent 68
  - ProviderManager 68
  - Repository 68
  - Server 68
  - Shutdown 68
  - SSL 68
  - StatisticalData 68, 69
  - Thread 68
  - UserManager 68
  - WQL 68
  - WsmServer 68
  - Xml 68
  - XmlIO 69
- TRACE log level 71
- traceComponents configuration property 58, 68, 71
- traceFacility configuration property 58, 69, 71
- traceFilePath configuration property 58, 69, 70
- traceLevel configuration property 59, 68
- traceMemoryBufferKbytes configuration property 59, 69
- tracing
  - See* trace
- troubleshooting 337

## U

- UID 20, 25, 26
- UNIX
  - file system 20
  - System Services command prompt 51, 53, 66
  - System Services shell 21, 50, 51, 79, 88
- user 23
  - access 28
  - authorization 20
  - certificate 11
  - context 42, 291
- user ID 11, 23
  - CIM server user ID switch 29
  - client 29
  - definition, CIM server 25
  - designated 13, 43
  - privileged 25
  - protected 25
  - requestor 43
- user identity
  - See* user ID
- user interface
  - ISPF 365
  - TSO/E 365
- UserContext 43
- UTF-8 292

## V

- velocity goal 54
- verification
  - CIM server startup 22, 65, 66
  - customization 22, 61
  - installation 22, 61

## W

- WARNING log level 71
- WBEM xi, 3, 13, 24
- wbemexec 80
- Web Based Enterprise Management
  - See* WBEM
- Web Services for Management 4
- WLM
  - classes 278
  - provider 53
  - service class for CIM priority 54
- WLM management 40
- WLM\_CIMPROVIDER\_TRACE\_FILE 53
- WLM\_CIMPROVIDER\_TRACE\_LEVEL 53
- Workload Manager 278
  - See* WLM
- World Wide Port Number
  - See* WWPN
- WS-Enumeration 4
- WS-Management 4
- WS-Transfer 4
- WWPN 41, 261

## X

- XCF address space
  - See* XCFAS
- XCFAS 36

## Z

- z/OS Communications Server 129
  - system logger
    - See* syslog
- z/OS Security Server 24, 28
- z/OS Sysplex
  - Considerations 49
- z/OS system console
  - See* console
- zFS data set 46





Product Number: 5650-ZOS

Printed in USA

SC34-2671-00

