

IBM i
7.3

*Database
SQL programming*

IBM

Note

Before using this information and the product it supports, read the information in [“Notices” on page 399](#).

This edition applies to IBM i 7.3 (product number 5770-SS1) and to all subsequent releases and modifications until otherwise indicated in new editions. This version does not run on all reduced instruction set computer (RISC) models nor does it run on CISC models.

This document may contain references to Licensed Internal Code. Licensed Internal Code is Machine Code and is licensed to you under the terms of the IBM License Agreement for Machine Code.

© **Copyright International Business Machines Corporation 1998, 2015.**

US Government Users Restricted Rights – Use, duplication or disclosure restricted by GSA ADP Schedule Contract with IBM Corp.

Contents

SQL programming.....	1
What's new for IBM i 7.3.....	1
PDF file for SQL programming.....	3
Introduction to Db2 for i Structured Query Language.....	3
SQL concepts.....	3
SQL relational database and system terminology.....	5
SQL and system naming conventions.....	6
Types of SQL statements.....	6
SQL communication area.....	8
SQL diagnostics area.....	8
SQL objects.....	9
Schemas.....	9
Journals and journal receivers.....	9
Catalogs.....	9
Tables, rows, and columns.....	9
Aliases.....	10
Views.....	10
Indexes.....	10
Constraints.....	10
Triggers.....	11
Stored procedures.....	11
Sequences.....	11
Global variables.....	12
User-defined functions.....	12
User-defined types.....	12
XSR objects.....	12
SQL packages.....	12
Application program objects.....	13
User source file.....	14
Output source file member.....	14
Program.....	14
SQL package.....	15
Module.....	15
Service program.....	15
Data definition language.....	15
Creating a schema.....	16
Creating a table.....	16
Adding and removing constraints.....	17
Referential integrity and tables.....	17
Adding and removing referential constraints.....	18
Example: Adding referential constraints.....	18
Example: Removing constraints.....	19
Check pending.....	19
Creating a table using LIKE.....	20
Creating a table using AS.....	20
Creating and altering a materialized query table.....	21
Creating a system-period temporal table.....	22
Declaring a global temporary table.....	23
Creating a table with remote server data.....	23
Creating a row change timestamp column.....	24
Creating auditing columns.....	24

Creating and altering an identity column.....	25
Using ROWID.....	26
Creating and using sequences.....	26
Comparison of identity columns and sequences.....	28
Defining field procedures.....	29
Field definition for field procedures.....	29
Specifying the field procedure.....	30
When field procedures are invoked.....	30
Parameter list for execution of field procedures.....	31
The field procedure parameter value list (FPPVL).....	33
Parameter value descriptors for field procedures.....	33
Field-definition (function code 8).....	34
Field-encoding (function code 0).....	35
Field-decoding (function code 4).....	36
Example field procedure program.....	36
General guidelines for writing field procedures.....	47
Index considerations.....	48
Thread considerations.....	49
Debug considerations.....	49
Guidelines for writing field procedures that mask data.....	49
Example field procedure program that masks data.....	51
Creating descriptive labels using the LABEL ON statement.....	53
Describing an SQL object using COMMENT ON.....	54
Changing a table definition.....	54
Adding a column.....	54
Changing a column.....	55
Allowable conversions of data types.....	55
Deleting a column.....	56
Order of operations for the ALTER TABLE statement.....	57
Using CREATE OR REPLACE TABLE.....	57
Creating and using ALIAS names.....	58
Creating and using views.....	59
WITH CHECK OPTION on a view.....	61
WITH CASCADED CHECK OPTION.....	61
WITH LOCAL CHECK OPTION.....	62
Example: Cascaded check option.....	62
Creating indexes.....	63
Creating and using global variables.....	64
Replacing existing objects.....	64
Catalogs in database design.....	65
Getting catalog information about a table.....	65
Getting catalog information about a column.....	65
Dropping a database object.....	66
Data manipulation language.....	66
Retrieving data using the SELECT statement.....	66
Basic SELECT statement.....	66
Specifying a search condition using the WHERE clause.....	68
Expressions in the WHERE clause.....	69
Comparison operators.....	70
NOT keyword.....	70
GROUP BY clause.....	70
HAVING clause.....	72
ORDER BY clause.....	73
Static SELECT statements.....	75
Handling null values.....	76
Special registers in SQL statements.....	77
Casting data types.....	78
Date, time, and timestamp data types.....	79

Specifying current date and time values.....	79
Date/time arithmetic.....	80
Row change expressions.....	80
Handling duplicate rows.....	80
Defining complex search conditions.....	81
Special considerations for LIKE.....	82
Multiple search conditions within a WHERE clause.....	83
Using OLAP specifications.....	84
Joining data from more than one table.....	90
Inner join.....	90
Left outer join.....	91
Right outer join.....	92
Exception join.....	92
Cross join.....	93
Full outer join.....	94
Multiple join types in one statement.....	94
Using table expressions.....	95
Using recursive queries.....	97
Using the UNION keyword to combine subselects.....	109
Specifying the UNION ALL keyword.....	112
Using the EXCEPT keyword.....	113
Using the INTERSECT keyword.....	115
Data retrieval errors.....	117
Inserting rows using the INSERT statement.....	118
Inserting rows using the VALUES clause.....	120
Inserting rows using a select-statement.....	120
Inserting multiple rows using the blocked INSERT statement.....	121
Inserting data into tables with referential constraints.....	121
Inserting values into an identity column.....	122
Selecting inserted values.....	123
Inserting data from a remote database.....	124
Changing data in a table using the UPDATE statement.....	124
Updating a table using a scalar-subselect.....	125
Updating a table with rows from another table.....	126
Updating tables with referential constraints.....	126
Examples: UPDATE rules.....	127
Updating an identity column.....	127
Updating data as it is retrieved from a table.....	128
Removing rows from a table using the DELETE statement.....	129
Removing rows from tables with referential constraints.....	130
Example: DELETE rules.....	131
Removing rows from a table using the TRUNCATE statement.....	132
Merging data	133
Using subqueries.....	134
Subqueries in SELECT statements.....	134
Subqueries and search conditions.....	135
Usage notes on subqueries.....	136
Including subqueries in the WHERE or HAVING clause.....	136
Correlated subqueries.....	138
Correlated names and references.....	138
Example: Correlated subquery in a WHERE clause.....	138
Example: Correlated subquery in a HAVING clause.....	139
Example: Correlated subquery in a select-list.....	140
Example: Correlated subquery in an UPDATE statement.....	141
Example: Correlated subquery in a DELETE statement.....	141
Sort sequences and normalization in SQL.....	142
Sort sequence used with ORDER BY and row selection.....	142
Sort sequence and ORDER BY.....	143

Sort sequence and row selection.....	144
Sort sequence and views.....	145
Sort sequence and the CREATE INDEX statement.....	146
Sort sequence and constraints.....	146
ICU sort sequence.....	146
Normalization.....	147
Data protection.....	148
Security for SQL objects.....	148
Authorization ID.....	149
Views.....	149
Column masks and row permissions.....	149
Auditing.....	149
Data integrity.....	150
Concurrency.....	150
Journaling.....	151
Commitment control.....	152
Savepoints.....	156
Atomic operations.....	157
Constraints.....	159
Adding and using check constraints.....	159
Save and restore functions.....	160
Damage tolerance.....	161
Index recovery.....	161
Catalog integrity.....	161
User auxiliary storage pool.....	162
Independent auxiliary storage pool.....	162
Routines.....	163
Stored procedures.....	163
Defining an external procedure.....	164
Defining an SQL procedure.....	164
Defining a procedure with default parameters.....	169
Calling a stored procedure.....	170
Using the CALL statement where procedure definition exists.....	171
Using the embedded CALL statement where no procedure definition exists.....	172
Using the embedded CALL statement with an SQLDA.....	172
Using the dynamic CALL statement where no CREATE PROCEDURE exists.....	173
Examples: CALL statements.....	174
Returning result sets from stored procedures.....	179
Example 1: Calling a stored procedure that returns a single result set.....	180
Example 2: Calling a stored procedure that returns a result set from a nested procedure.....	181
Writing a program or SQL procedure to receive the result sets from a stored procedure.....	186
Parameter passing conventions for stored procedures and user-defined functions.....	191
Indicator variables and stored procedures.....	196
Returning a completion status to the calling program.....	198
Passing parameters from Db2 to external procedures.....	198
Parameter style SQL.....	198
Parameter style GENERAL.....	200
Parameter style GENERAL WITH NULLS.....	200
Parameter style DB2GENERAL.....	200
Parameter style Java.....	200
Dynamic compound statement.....	201
Using user-defined functions.....	201
UDF concepts.....	202
Writing UDFs as SQL functions.....	204
Example: SQL scalar UDFs.....	204
Example: SQL table UDFs.....	205
Writing UDFs as external functions.....	205
Registering UDFs.....	206

Passing arguments from Db2 to external functions.....	209
Table function considerations.....	214
Error processing for UDFs.....	214
Threads considerations.....	215
Parallel processing.....	215
Fenced or unfenced considerations.....	215
Save and restore considerations.....	216
Defining UDFs with default parameters.....	216
Examples: UDF code.....	217
Example: Square of a number UDF.....	217
Example: Counter.....	218
Example: Weather table function.....	219
Using UDFs in SQL statements.....	224
Using parameter markers or the NULL values as function arguments.....	224
Using qualified function references.....	225
Using unqualified function references.....	225
Invoking UDFs with named arguments.....	226
Summary of function references.....	226
Triggers.....	228
SQL triggers.....	229
BEFORE SQL triggers.....	229
AFTER SQL triggers.....	230
Multiple event SQL triggers.....	231
INSTEAD OF SQL triggers.....	233
Handlers in SQL triggers.....	234
SQL trigger transition tables.....	235
External triggers.....	236
Varying length parameter lists for external procedures and functions	236
Using the INCLUDE statement.....	237
Array support in SQL procedures and functions.....	241
Debugging an SQL routine.....	243
Obfuscating an SQL routine or SQL trigger.....	244
Managing SQL and external routine objects.....	245
Improving performance of procedures and functions.....	246
Improving implementation of procedures and functions.....	247
Redesigning routines for performance.....	249
Processing special data types.....	250
Large objects.....	250
Large object data types.....	250
Large object locators.....	251
Example: Using a locator to work with a CLOB value.....	251
Example: LOBLOC in C.....	252
Example: LOBLOC in COBOL.....	253
Indicator variables and LOB locators.....	254
LOB file reference variables.....	254
Example: Extracting CLOB data to a file.....	255
Example: LOBFILE in C.....	256
Example: LOBFILE in COBOL.....	256
Example: Inserting data into a CLOB column.....	257
Displaying the layout of LOB columns.....	257
Journal entry layout of LOB columns.....	258
User-defined distinct types.....	258
Defining a UDT.....	259
Example: Money.....	259
Example: Resumé.....	260
Defining tables with UDTs.....	260
Example: Sales.....	260
Example: Application forms.....	260

Manipulating UDTs.....	261
Examples: Using UDTs.....	261
Example: Comparisons between UDTs and constants.....	261
Example: Casting between UDTs.....	261
Example: Comparisons involving UDTs.....	262
Example: Sourced UDFs involving UDTs.....	263
Example: Assignments involving UDTs.....	263
Example: Assignments in dynamic SQL.....	263
Example: Assignments involving different UDTs	264
Example: Using UDTs in UNION.....	264
Examples: Using UDTs, UDFs, and LOBs.....	265
Example: Defining the UDT and UDFs	265
Example: Using the LOB function to populate the database.....	266
Example: Using UDFs to query instances of UDTs.....	266
Example: Using LOB locators to manipulate UDT instances.....	267
Using DataLinks.....	267
Linking control levels in DataLinks.....	268
NO LINK CONTROL.....	268
FILE LINK CONTROL with FS permissions.....	268
FILE LINK CONTROL with DB permissions.....	268
Working with DataLinks.....	269
HTTP functions overview.....	270
Working with JSON data.....	275
JSON concepts.....	275
Using JSON_TABLE.....	278
Generating JSON data.....	282
Using SQL in different environments.....	288
Using a cursor.....	288
Types of cursors.....	288
Examples: Using a cursor.....	289
Step 1: Defining the cursor.....	291
Step 2: Opening the cursor.....	292
Step 3: Specifying what to do when the end of data is reached.....	292
Step 4: Retrieving a row using a cursor.....	293
Step 5a: Updating the current row.....	293
Step 5b: Deleting the current row.....	294
Step 6: Closing the cursor.....	294
Example: Using the OFFSET clause with a cursor.....	295
Using the multiple-row FETCH statement.....	295
Multiple-row FETCH using a host structure array.....	296
Multiple-row FETCH using a row storage area.....	297
Unit of work and open cursors.....	299
Dynamic SQL applications.....	300
Running dynamic SQL statements.....	300
CCSID of dynamic SQL statements.....	300
Processing non-SELECT statements.....	301
Using the PREPARE and EXECUTE statements.....	301
Processing SELECT statements and using a descriptor.....	302
Fixed-list SELECT statements.....	302
Varying-list SELECT statements.....	303
SQL descriptor areas.....	303
SQLDA format.....	304
Example: A SELECT statement for allocating storage for SQLDA.....	306
Example: A SELECT statement using an allocated SQL descriptor.....	310
Parameter markers.....	313
Using interactive SQL.....	314
Starting interactive SQL.....	315
Using the statement entry function.....	316

Prompting.....	316
Syntax checking.....	318
Statement processing mode.....	318
Subqueries.....	318
CREATE TABLE prompting.....	318
Entering DBCS data.....	318
Using the list selection function.....	319
Example: Using the list selection function.....	319
Session services description.....	321
Exiting interactive SQL.....	322
Using an existing SQL session.....	323
Recovering an SQL session.....	323
Accessing remote databases with interactive SQL.....	323
Using the SQL statement processor.....	325
Execution of statements after errors occur.....	327
Commitment control in the SQL statement processor.....	327
Source listing for the SQL statement processor.....	327
Using the RUNSQL CL command.....	328
Distributed relational database function and SQL.....	330
Db2 for i distributed relational database support.....	331
Db2 for i distributed relational database example program.....	332
SQL package support.....	333
Valid SQL statements in an SQL package.....	333
Considerations for creating an SQL package.....	334
CRTSQLPKG authorization.....	334
Creating a package on a database other than Db2 for i.....	334
Target release (TGTRLS) parameter.....	334
SQL statement size.....	335
Statements that do not require a package.....	335
Package object type.....	335
ILE programs and service programs.....	335
Package creation connection.....	335
Unit of work.....	335
Creating packages locally.....	336
Labels.....	336
Consistency token.....	336
SQL and recursion.....	336
CCSID considerations for SQL.....	336
Connection management and activation groups.....	337
Source code for PGM1.....	337
Source code for PGM2.....	338
Source code for PGM3.....	338
Multiple connections to the same relational database.....	340
Implicit connection management for the default activation group.....	341
Implicit connection management for nondefault activation groups.....	341
Distributed support.....	342
Determining the connection type.....	342
Connect and commitment control restrictions.....	344
Determining the connection status.....	345
Distributed unit of work connection considerations.....	346
Ending connections.....	347
Distributed unit of work.....	347
Managing distributed unit of work connections.....	347
Checking the connection status.....	349
Cursors and prepared statements.....	349
DRDA stored procedure considerations.....	350
WebSphere MQ with Db2.....	350
WebSphere MQ messages.....	351

WebSphere MQ message handling.....	351
Db2 MQ services.....	351
Db2 MQ policies.....	352
Db2 MQ functions.....	352
Db2 MQ dependencies.....	354
Db2 MQ tables.....	354
Db2 MQ CCSID conversion.....	362
WebSphere MQ transactions.....	363
Basic messaging with WebSphere MQ.....	364
Sending messages with WebSphere MQ.....	365
Retrieving messages with WebSphere MQ.....	365
Application to application connectivity with WebSphere MQ.....	366
Db2 for i sample tables.....	367
Sample tables.....	367
Department table (DEPARTMENT).....	367
DEPARTMENT.....	368
Employee table (EMPLOYEE).....	369
EMPLOYEE.....	371
Employee photo table (EMP_PHOTO).....	372
EMP_PHOTO.....	372
Employee resumé table (EMP_RESUME).....	372
EMP_RESUME.....	373
Employee to project activity table (EMPPROJACT).....	373
EMPPROJACT.....	374
Project table (PROJECT).....	376
PROJECT.....	377
Project activity table (PROJACT).....	378
PROJACT.....	379
Activity table (ACT).....	381
ACT.....	381
Class schedule table (CL_SCHED).....	382
CL_SCHED.....	382
In-tray table (IN_TRAY).....	382
IN_TRAY.....	383
Organization table (ORG).....	384
ORG.....	384
Staff table (STAFF).....	384
STAFF.....	385
Sales table (SALES).....	386
SALES.....	386
Sample XML tables.....	387
Product table (PRODUCT).....	388
PRODUCT.....	388
Purchase order table (PURCHASEORDER).....	389
PURCHASEORDER.....	390
Customer table (CUSTOMER).....	393
CUSTOMER.....	393
Catalog table (CATALOG).....	395
CATALOG.....	395
Suppliers table (SUPPLIERS).....	395
SUPPLIERS.....	395
Inventory table (INVENTORY).....	395
INVENTORY.....	396
Product Supplier table (PRODUCTSUPPLIER).....	396
PRODUCTSUPPLIER.....	396
Db2 for i CL command descriptions.....	396

Notices.....	399
Programming interface information.....	400
Trademarks.....	400
Terms and conditions.....	401

SQL programming

The Db2® for IBM® i database provides a wide range of support for Structured Query Language (SQL).

The examples of SQL statements shown in this topic collection are based on the sample tables and assume that the following statements are true:

- Each SQL example is shown on several lines, with each clause of the statement on a separate line.
- SQL keywords are highlighted.
- Table names provided in the sample tables use the schema CORPDATA. Table names that are not found in the Sample Tables should use schemas you create.
- The SQL naming convention is used.
- The APOST and APOSTSQL precompiler options are assumed although they are not the default options in COBOL. Character string literals within SQL and host language statements are delimited by single-quotation marks (').
- A sort sequence of *HEX is used, unless otherwise noted.

Whenever the examples vary from these assumptions, it is stated.

Because this topic collection is for the application programmer, most of the examples are shown as if they were written in an application program. However, many examples can be slightly changed and run interactively by using interactive SQL. The syntax of an SQL statement, when using interactive SQL, differs slightly from the format of the same statement when it is embedded in a program.

Note: By using the code examples, you agree to the terms of the [“Code license and disclaimer information”](#) on page 396.

Related concepts

[Embedded SQL programming](#)

Related reference

[Db2 for i sample tables](#)

These sample tables are referred to and used in the SQL programming and the SQL reference topic collections.

[Db2 for i SQL reference](#)

What's new for IBM i 7.3

Read about new or significantly changed information for the SQL programming topic collection.

System-period temporal tables

You can define a table that maintains historical data. For more information, see [“Creating a system-period temporal table”](#) on page 22.

Auditing columns

You can define columns in a table that are maintained by the system to track information about changes to a row such as type of change and the user that made the change. For more information, see [“Creating auditing columns”](#) on page 24.

OLAP aggregates

Additional OLAP aggregate functions have been added. See [“Using OLAP specifications”](#) on page 84 for some examples.

OFFSET clause

The OFFSET clause can be used to return data starting at a specified position within a result set. For more information, see [“Example: Using the OFFSET clause with a cursor” on page 295.](#)

FIELDPROC example in ILE RPG and C

A new example of a FIELDPROC is written in both ILE RPG and C versions. For more information, see [“Example field procedure program” on page 36.](#)

What's new as of May 2022

- The HTTP_PATCH and HTTP_PATCH_VERBOSE function are added to QSYS2. [“HTTP functions overview” on page 270](#)

What's new as of September 2021

- A set of HTTP functions in QSYS2 can make HTTP requests that use web services. These functions use the HTTP Transport support provided by the AXIS APIs. [“HTTP functions overview” on page 270](#)

What's new as of October 2019

- External functions and procedures removed the limit of 32 routine attributes that can be saved in the associated program or service program object.

What's new as of August 2018

External procedures and functions set the number of parameters in the operational descriptor when calling an ILE service program. For more information, see [“Varying length parameter lists for external procedures and functions” on page 236.](#)

What's new as of October 2017

SQL can generate and consume JSON. For more information, see [“Working with JSON data” on page 275.](#)

What's new as of October 2016



SQL procedures, functions, and triggers can use the INCLUDE statement to share common code. For more information, see [“Using the INCLUDE statement” on page 237.](#)

What's new since 7.2

- The OR REPLACE option has been added to the CREATE TABLE statement. For more information, see [“Using CREATE OR REPLACE TABLE” on page 57.](#)
- A pipelined SQL table function is a more flexible version of a table function. For more information, see [“Example: SQL table UDFs” on page 205.](#)
- Debugging of SQL routines allows you to display values of SQL variables. For more information, see [“Debugging an SQL routine” on page 243.](#)
- A listing can be requested for the RUNSQL command. For more information, see [“Using the RUNSQL CL command” on page 328.](#)

How to see what's new or changed

To help you see where technical changes have been made, the information center uses:

- The  image to mark where new or changed information begins.
- The  image to mark where new or changed information ends.

In PDF files, you might see revision bars (|) in the left margin of new and changed information.

To find other information about what's new or changed this release, see the [Memo to users](#).

PDF file for SQL programming

You can view and print a PDF file of this information.

To view or download the PDF version of this document, select [SQL programming](#).

Saving PDF files

To save a PDF on your workstation for viewing or printing:

1. Right-click the PDF link in your browser.
2. Click the option that saves the PDF locally.
3. Navigate to the directory in which you want to save the PDF.
4. Click **Save**.

Downloading Adobe Reader

You need Adobe Reader installed on your system to view or print these PDFs. You can download a free copy from the [Adobe Web site](http://get.adobe.com/reader/) (<http://get.adobe.com/reader/>) .

Introduction to Db2 for i Structured Query Language

Structured Query Language (SQL) is a standardized language for defining and manipulating data in a relational database. These topics describe the IBM i implementation of the SQL using the Db2 for i database and the IBM DB2® Query Manager and SQL Development Kit for i licensed program.

SQL manages information based on the relational model of data. SQL statements can be embedded in high-level languages, dynamically prepared and run, or run interactively. For information about embedded SQL, see [Embedded SQL programming](#).

SQL consists of statements and clauses that describe what you want to do with the data in a database and under what conditions you want to do it.

SQL can access data in a remote relational database, using the IBM Distributed Relational Database Architecture™ (DRDA).

Related concepts

[Distributed database programming](#)

Related reference

[Distributed relational database function and SQL](#)

A *distributed relational database* consists of a set of SQL objects that are spread across interconnected computer systems.

SQL concepts

Db2 for i SQL consists of several main parts, such as SQL runtime support, precompilers, and interactive SQL.

- SQL runtime support

SQL run time parses SQL statements and runs any SQL statements. This support is part of the IBM i licensed program, which allows applications that contain SQL statements to be run on systems where the IBM DB2 Query Manager and SQL Development Kit for i licensed program is not installed.

- SQL precompilers

SQL precompilers support precompiling embedded SQL statements in host languages. The following languages are supported:

- ILE C
- ILE C++
- ILE COBOL
- COBOL
- PL/I
- RPG III (part of RPG)
- ILE RPG

The SQL host language precompilers prepare an application program that contains SQL statements. The host language compilers then compile the precompiled host source programs. For more information about precompiling, see [Preparing and running a program with SQL statements](#) in the Embedded SQL programming information. The precompiler support is part of the IBM DB2 Query Manager and SQL Development Kit for i licensed program.

- SQL interactive interface

The SQL interactive interface allows you to create and run SQL statements. For more information about interactive SQL, see [“Using interactive SQL”](#) on page 314. Interactive SQL is part of the IBM DB2 Query Manager and SQL Development Kit for i licensed program.

- Run SQL Scripts

The Run SQL Scripts window in System i® Navigator allows you to create, edit, run, and troubleshoot scripts of SQL statements.

- Run SQL Scripts in IBM i Access Client Solutions (ACS)

For information about ACS, see <http://www-03.ibm.com/systems/power/software/i/access/solutions.html>

- Run SQL Statements (RUNSQLSTM) CL command

The RUNSQLSTM command can be used to run a series of SQL statements that are stored in a source file or a source stream file. For more information about the RUNSQLSTM command, see [“Using the SQL statement processor”](#) on page 325.

- Run SQL (RUNSQL) CL command

The RUNSQL command can be used to run a single SQL statements. For more information about the RUNSQL command, see [“Using the RUNSQL CL command”](#) on page 328.

- DB2 Query Manager

DB2 Query Manager provides a prompt-driven interactive interface that allows you to create data, add data, maintain data, and run reports on the databases. Query Manager is part of the IBM DB2 Query Manager and SQL Development Kit for i licensed program. For more information, see [Query Manager](#)

Use  .

- SQL REXX interface

The SQL REXX interface allows you to run SQL statements in a REXX procedure. For more information about using SQL statements in REXX procedures, see [Coding SQL statements in REXX applications](#) in the Embedded SQL programming information.

- SQL call level interface

The Db2 for i database supports the SQL call level interface. This allows users of any of the ILE languages to access SQL functions directly through bound calls to a service program that is provided by the system. Using the SQL call level interface, you can perform all the SQL functions without the need to precompile. This is a standard set of procedure calls to prepare SQL statements, run SQL statements,

fetch rows of data, and even perform advanced functions, such as accessing the catalogs and binding program variables to output columns.

For a complete description of all the available functions and their syntax, see [SQL call level interface](#) in the Database section of the IBM i Information Center.

- Process Extended Dynamic SQL (QSQPRCED) API

This application programming interface (API) provides an extended dynamic SQL capability. You can prepare SQL statements into an SQL package and run them by using this API. Statements that are prepared into a package by this API persist until the package or statement is explicitly dropped. For more information about the QSQPRCED API, see [Process Extended Dynamic SQL \(QSQPRCED\) API](#). For general information about APIs, see [Application programming interfaces](#).

- Syntax Check SQL Statement (QSQCHKS) API

This API syntax checks SQL statements. For more information about the QSQCHKS API, see [Syntax Check SQL Statement \(QSQCHKS\) API](#). For general information about APIs, see [Application programming interfaces](#).

- DB2 Multisystem

This feature of the operating system allows your data to be distributed across multiple systems. It is also allows the definition of partitioned tables. For more information, see [DB2 Multisystem](#).

- DB2 Symmetric Multiprocessing

This feature of the operating system provides the query optimizer with additional methods for retrieving data that include parallel processing. Symmetric multiprocessing (SMP) is a form of parallelism achieved on a single system where multiple processors (CPU and I/O processors) that share memory and disk resource work simultaneously toward achieving a single end result. This parallel processing means that the database manager can have more than one (or all) of the system processors working on a single query simultaneously. For more information, see [Controlling parallel processing for queries](#) in the Database performance and query optimization topic collection.

SQL relational database and system terminology

In the relational model of data, all data is perceived as existing in tables. Db2 for i objects are created and maintained as system objects.

The following table shows the relationship between system terms and SQL relational database terms.

<i>Table 1. Relationship of system terms to SQL terms</i>	
System terms	SQL terms
Library. Groups related objects and allows you to find the objects by name.	Schema. Consists of a library, a journal, a journal receiver, an SQL catalog, and optionally a data dictionary. A schema groups related objects and allows you to find the objects by name.
Physical file. A set of records.	Table. A set of columns and rows.
Record. A set of fields.	Row. The horizontal part of a table containing a serial set of columns.
Field. One or more characters of related information of one data type.	Column. The vertical part of a table of one data type.
Logical file. A subset of fields and records of one or more physical files.	View. A subset of columns and rows of one or more tables.
SQL package. An object type that is used to run SQL statements.	Package. An object type that is used to run SQL statements.
User Profile	Authorization name or Authorization ID.

Related concepts

[Distributed database programming](#)

SQL and system naming conventions

You can use either the system (*SYS) or the SQL (*SQL) naming convention in Db2 for i programming.

The naming convention used affects the method for qualifying file and table names and the terms used on the interactive SQL displays. The naming convention used is selected by a parameter on the SQL commands or by using the SET OPTION statement.

System naming (*SYS)

In the system naming convention, tables and other SQL objects in an SQL statement are qualified by schema name in the form:

```
schema/table
```

or

```
schema.table
```

SQL naming (*SQL)

In the SQL naming convention, tables and other SQL objects in an SQL statement are qualified by schema name in the form:

```
schema.table
```

Related reference

[Qualification of unqualified object names](#)

Types of SQL statements

There are several basic types of SQL statements. They are listed here according to their functions.

- SQL schema statements, also known as data definition language (DDL) statements
- SQL data and data change statements, also known as data manipulation language (DML) statements
- Dynamic SQL statements
- Embedded SQL host language statements

SQL schema statements

ALTER FUNCTION
ALTER MASK
ALTER PERMISSION
ALTER PROCEDURE
ALTER SEQUENCE
ALTER TABLE
ALTER TRIGGER
COMMENT ON
CREATE ALIAS
CREATE FUNCTION
CREATE INDEX
CREATE MASK
CREATE PERMISSION
CREATE PROCEDURE
CREATE SCHEMA
CREATE SEQUENCE
CREATE TABLE
CREATE TRIGGER
CREATE TYPE
CREATE VARIABLE
CREATE VIEW
DROP
GRANT
LABEL ON
RENAME
REVOKE
TRANSFER OWNERSHIP

SQL data change statements

DELETE
INSERT
MERGE
TRUNCATE
UPDATE

SQL transaction statements

COMMIT
RELEASE SAVEPOINT
ROLLBACK
SAVEPOINT
SET TRANSACTION

SQL data statements

ALLOCATE CURSOR
ASSOCIATE LOCATORS
CLOSE
DECLARE CURSOR
DELETE
FETCH
FREE LOCATOR
HOLD LOCATOR
INSERT
LOCK TABLE
OPEN
REFRESH TABLE
SELECT INTO
SET variable
UPDATE
VALUES INTO

SQL connection statements

CONNECT
DISCONNECT
RELEASE
SET CONNECTION

SQL session statements

DECLARE GLOBAL TEMPORARY TABLE
SET CURRENT DECFLOAT ROUNDING MODE
SET CURRENT DEGREE
SET CURRENT IMPLICIT XMLPARSE OPTION
SET CURRENT TEMPORAL SYSTEM_TIME
SET ENCRYPTION PASSWORD
SET PATH
SET SCHEMA
SET SESSION AUTHORIZATION

Dynamic SQL statements

ALLOCATE DESCRIPTOR
compound (dynamic)
DEALLOCATE DESCRIPTOR
DESCRIBE
DESCRIBE CURSOR
DESCRIBE INPUT
DESCRIBE PROCEDURE
DESCRIBE TABLE
EXECUTE
EXECUTE IMMEDIATE
GET DESCRIPTOR
PREPARE
SET DESCRIPTOR

Embedded SQL host language statements

BEGIN DECLARE SECTION
DECLARE PROCEDURE
DECLARE STATEMENT
DECLARE VARIABLE
END DECLARE SECTION
GET DIAGNOSTICS
INCLUDE
SET OPTION
SET RESULT SETS
SIGNAL
WHENEVER

SQL control statements

CALL

SQL statements can operate on objects that are created by SQL as well as externally described physical files and single-format logical files. They do not refer to the interactive data definition utility (IDDU) dictionary definition for program-described files. Program-described files appear as a table with only a single column.

Related concepts

Data definition language

Data definition language (DDL) describes the portion of SQL that creates, alters, and deletes database objects. These database objects include schemas, tables, views, sequences, catalogs, indexes, variables, masks, permissions, and aliases.

Data manipulation language

Data manipulation language (DML) describes the portion of SQL that manipulates or controls data.

Related reference

Db2 for i SQL reference

SQL communication area

The SQL communication area (SQLCA) is a set of variables that provides an application program with information about its execution of SQL statements. The SQLCA is updated at the end of the execution of every SQL statement.

Related concepts

SQLCA (SQL communication area)

Handling SQL error return codes using the SQLCA

SQL diagnostics area

The SQL diagnostics area maintained by the database manager provides information about the SQL statement that is most recently run. Your application program can access the SQL diagnostics area using the GET DIAGNOSTICS statement.

Related concepts

Using the SQL diagnostics area

Related reference

GET DIAGNOSTICS statement

SQL objects

SQL *objects* are schemas, journals, catalogs, tables, aliases, views, indexes, constraints, triggers, masks, permissions, sequences, stored procedures, user-defined functions, user-defined types, global variables, and SQL packages. SQL creates and maintains these objects as system objects.

Schemas

A schema provides a logical grouping of SQL objects. A *schema* consists of a library, a journal, a journal receiver, a catalog, and, optionally, a data dictionary.

Tables, views, and system objects (such as programs) can be created, moved, or restored into any system library. All system files can be created or moved into an SQL schema if the SQL schema does not contain a data dictionary. If the SQL schema contains a data dictionary then:

- Source physical files or nonsource physical files with one member can be created, moved, or restored into an SQL schema.
- Logical files cannot be placed in an SQL schema because they cannot be described in the data dictionary.

You can create and own many schemas.

Journals and journal receivers

A *journal* and a *journal receiver* are used to record changes to tables and views in the database.

Journals and journal receivers are used in processing the SQL COMMIT, ROLLBACK, SAVEPOINT, and RELEASE SAVEPOINT statements. Journals and journal receivers can also be used as audit trails or for forward or backward recovery.

Related concepts

[Journal management](#)

[Commitment control](#)

Catalogs

An SQL *catalog* is a collection of tables and views that describe tables, views, indexes, procedures, functions, sequences, triggers, masks, permissions, variables, constraints, programs, packages, and XSR objects.

This information is contained in a set of cross-reference tables in libraries QSYS and QSYS2. In each SQL schema there is a set of views built over the catalog tables that contains information about the objects in the schema.

A catalog is automatically created when you create a schema. You cannot drop or explicitly change the catalog.

Related reference

[Catalog](#)

Tables, rows, and columns

A *table* is a two-dimensional arrangement of data that consists of *rows* and *columns*.

The row is the horizontal part containing one or more columns. The column is the vertical part containing one or more rows of data of one data type. All data for a column must be of the same type. A table in SQL is a keyed or non-keyed physical file.

A *materialized query table* is a table that is used to contain materialized data that is derived from one or more source tables specified by a select-statement.

A *system-period temporal table* is a table that has a related history table that is used by the system to save all historical versions of rows for the table.

A *partitioned table* is a table whose data is contained in one or more local partitions (members).

Related concepts

[Db2 Multisystem](#)

Related reference

[Data types](#)

[Creating and altering a materialized query table](#)

A *materialized query table* is a table whose definition is based on the result of a query, and whose data is in the form of precomputed results that are taken from the table or tables on which the materialized query table definition is based.

Aliases

An *alias* is an alternate name for a table or view.

You can use an alias to refer to a table or view in those cases where an existing table or view can be referred to. Additionally, aliases can refer to a specific member of a table. An alias can also be a three-part name with an RDB name that refers to a remote system.

Related reference

[Aliases](#)

Views

A *view* appears like a table to an application program. However, a view contains no data and only logically represents one or more tables over which it is created.

A view can contain all the columns and rows of the given tables or a subset of them. The columns can be arranged differently in a view than they are in the tables from which they are taken. A view in SQL is a special form of a nonkeyed logical file.

Related reference

[Views](#)

Indexes

An SQL *index* is a subset of the data in the columns of a table that are logically arranged in either ascending or descending order.

Each index defines a set of columns or expressions as keys. These keys are used for ordering, grouping, and joining. The index is used by the system for faster data retrieval.

Db2 for i supports two types of indexes: binary radix tree indexes and encoded vector indexes (EVIs).

Creating an index is optional. You can create any number of indexes. You can create or drop an index at any time. The index is automatically maintained by the system. However, because the indexes are maintained by the system, a large number of indexes can adversely affect the performance of the applications that change the table.

Related concepts

[Creating an index strategy](#)

Related reference

[CREATE INDEX](#)

Constraints

A *constraint* is a rule enforced by the database manager to limit the values that can be inserted, deleted, or updated in a table.

Db2 for i supports the following constraints:

- Unique constraints

A *unique constraint* is the rule that the values of the key are valid only if they are unique. You can create a unique constraint using the CREATE TABLE or ALTER TABLE statement. Although the CREATE INDEX statement can create a unique index that also guarantees uniqueness, such an index is not a constraint.

Unique constraints are enforced during the execution of INSERT and UPDATE statements. A PRIMARY KEY constraint is a form of the UNIQUE constraint. The difference is that a PRIMARY KEY cannot contain any nullable columns.

- Referential constraints

A *referential constraint* is the rule that the values of the foreign key are valid only if one of the following conditions is met:

- They appear as values of a parent key.
- Some component of the foreign key is null.

Referential constraints are enforced during the execution of INSERT, UPDATE, and DELETE statements.

- Check constraints

A *check constraint* is the rule that limits the values allowed in a column or group of columns. You can create a check constraint using the CREATE TABLE or ALTER TABLE statement. Check constraints are enforced during the execution of INSERT and UPDATE statements. To satisfy the constraint, each row of data inserted or updated in the table must make the specified condition either TRUE or unknown (because of a null value).

Related reference

Constraints

The Db2 for i database supports unique, referential, and check constraints.

Triggers

A *trigger* is a set of actions that runs automatically whenever a specified event occurs to a specified table or view.

An event can be an insert, an update, a delete, or a read operation. A trigger can run either before or after the event. Db2 for i supports SQL insert, update, and delete triggers and external triggers.

Related tasks

Triggering automatic events in your database

Stored procedures

A *stored procedure* is a program that can be called with the SQL CALL statement.

Db2 for i supports external procedures and SQL procedures. An external procedure can be any system program, service program, or REXX procedure. It cannot be a System/36 program or procedure. An SQL procedure is defined entirely in SQL and can contain SQL statements, including SQL control statements.

Related concepts

Stored procedures

A *procedure* (often called a stored procedure) is a program that can be called to perform operations. A procedure can include both host language statements and SQL statements. Procedures in SQL provide the same benefits as procedures in a host language.

Sequences

A *sequence* is a data area object that provides a quick and easy way of generating unique numbers.

You can use a sequence to replace an identity column or a user-generated numeric column. A sequence has uses similar to these alternatives.

Related reference

Creating and using sequences

Sequences are similar to identity columns in that they both generate unique values. However, sequences are objects that are independent of any tables. You can use sequences to generate values quickly and easily.

Global variables

A *global variable* is a named variable that can be created, accessed, and modified using SQL.

A global variable can provide a unique value for a session. The variable can be used as part of any expression in places such as a query, a create view, or an insert statement.

User-defined functions

A *user-defined function* is a program that can be called like any built-in functions.

Db2 for i supports external functions, SQL functions, and sourced functions. An external function can be any system ILE program or service program. An SQL function is defined entirely in SQL and can contain SQL statements, including SQL control statements. A sourced function is built over any built-in or any existing user-defined function. You can create a scalar function or a table function as either an SQL function or an external function.

Related concepts

[Using user-defined functions](#)

In writing SQL applications, you can implement some actions or operations as a user-defined function (UDF) or as a subroutine in your application. Although it might appear easier to implement new operations as subroutines, you might want to consider the advantages of using a UDF instead.

User-defined types

A *user-defined type* is a data type that you can define independently of the data types that are provided by the database management system.

Distinct data types map to built-in types. Array data types are defined using a built-in type as the element type and a maximum cardinality value.

Related concepts

[User-defined distinct types](#)

A user-defined distinct type (UDT) is a mechanism to extend Db2 capabilities beyond the built-in data types that are available.

XSR objects

An *XSR object* is one or more XML schema documents that have been registered in the XML schema repository with the same name.

You can use an XSR object during validation of an XML document or during annotated XML schema decomposition.

SQL packages

An *SQL package* is an object that contains the control structure produced when the SQL statements in an application program are bound to a remote relational database management system (DBMS).

The DBMS uses the control structure to process SQL statements encountered while running the application program.

SQL packages are created when a relational database name (RDB parameter) is specified on a Create SQL (CRTSQLxxx) command and a program object is created. Packages can also be created with the Create SQL Package (CRTSQLPKG) command.

Note: The xxx in this command refers to the host language indicators: CI for ILE C, CPPI for ILE C++, CBL for COBOL, CBLI for ILE COBOL, PLI for PL/I, RPG for RPG/400®, and RPGI for ILE RPG.

SQL packages can also be created with the Process Extended Dynamic SQL (QSQRCEd) API. The SQL packages mentioned within this topic collection refer exclusively to distributed program SQL packages. The QSQRCEd API uses SQL packages to provide extended dynamic SQL support.

Related reference

[Distributed relational database function and SQL](#)

A *distributed relational database* consists of a set of SQL objects that are spread across interconnected computer systems.

[Process Extended Dynamic SQL \(QSQRCEd\) API](#)

Application program objects

Several objects are created when a Db2 for i application program is being precompiled.

Db2 for i supports both non-ILE and ILE precompilers. Application programs can be either distributed or nondistributed.

With the Db2 for i database, you might need to manage the following objects:

- The original source
- Optionally, the module object for ILE programs
- The program or service program
- The SQL package for distributed programs

With a nondistributed non-ILE Db2 for i program, you must manage only the original source and the resulting program. The following figure shows the objects involved and the steps that happen during the precompile and compile processes for a nondistributed non-ILE Db2 for i program. The user source file precompiles the source to a temporary source file member. This member is then compiled into a program.

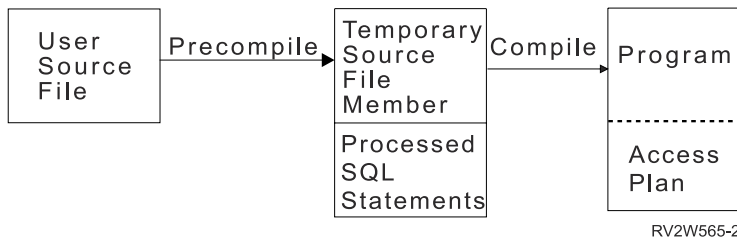

With a nondistributed ILE Db2 for i program, you might need to manage the original source, the modules, and the resulting program or service program. The following figure shows the objects involved and the steps that happen during the precompile and compile processes for a nondistributed ILE Db2 for i program when OBJTYPE(*PGM) is specified on the precompile command. The user source file precompiles the source to a temporary source file member. This member is then compiled into a module that binds to a program.

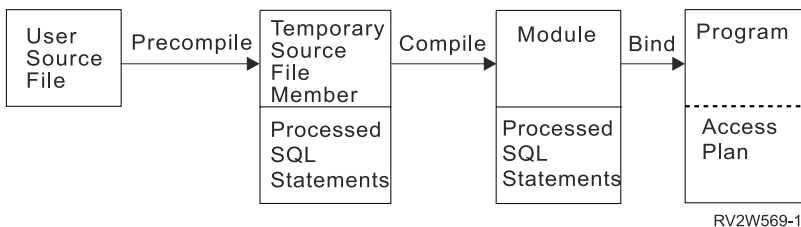

With a distributed non-ILE Db2 for i program, you must manage the original source, the resulting program, and the resulting package. The following figure shows the objects and the steps that occur during the precompile and compile processes for a distributed non-ILE Db2 for i program. The user source file precompiles the source to a temporary source file member. This member is then compiled into a program. After the program is created, an SQL package is created to hold the program.

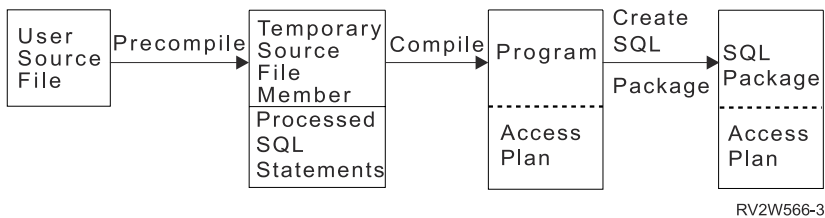

With a distributed ILE Db2 for i program, you must manage the original source, module objects, the resulting program or service program, and the resulting packages. An SQL package can be created for each distributed module in a distributed ILE program or service program. The following figure shows the objects and the steps that occur during the precompile and compile processes for a distributed ILE Db2 for i program. The user source file precompiles the source to a temporary source file member. This member is then compiled into a module that binds to a program. After the program is created, an SQL package is created to hold the program.

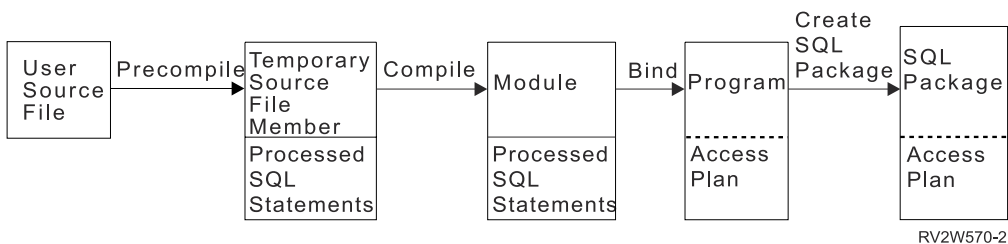

Note: The access plans associated with the Db2 for i distributed program object are not created until the program is run locally.

Related tasks

[Preparing and running a program with SQL statements](#)

User source file

A source file member or a source stream file contains the application language and SQL statements. You can create and maintain the source file member by using the source entry utility (SEU), a part of the IBM Rational® Development Studio for i licensed program.

Output source file member

By default, the precompile process creates a temporary source file QSQLTxxxxx in the QTEMP library. However, you can specify the output source file as a permanent file on the precompile command.

If the precompile process uses the QTEMP library, the system automatically deletes the file when the job is completed. A member with the same name as the program name is added to the output source file. This member contains the following items:

- Calls to the SQL runtime support, which have replaced embedded SQL statements
- Parsed and syntax-checked SQL statements

By default, the precompiler calls the host language compiler.

Related tasks

[Preparing and running a program with SQL statements](#)

Program

A *program* is an object that is created as a result of the compilation process for non-ILE compilations or as a result of the bind process for ILE compilations.

An *access plan* is a set of internal structures and information that tells SQL how to run an embedded SQL statement most effectively. It is created only when the program has been successfully created. Access

plans are not created during program creation for SQL statements if the statements refer to an object, such as a table or view, that cannot be found or to which you are not authorized.

The access plans for such statements are created when the program is run. If, at that time, the table or view still cannot be found or you are still not authorized, a negative SQLCODE is returned. Access plans are stored and maintained in the program object for non-distributed SQL programs and in the SQL package for distributed SQL programs.

SQL package

An SQL package contains the access plans for a distributed SQL program.

An SQL package is an object that is created when:

- You successfully create a distributed SQL program by specifying the relational database (RDB) parameter on the CREATE SQL (CRTSQLxxx) commands.
- You run the Create SQL Package (CRTSQLPKG) command.

When a distributed SQL program is created, the name of the SQL package and an internal consistency token are saved in the program. They are used at run time to find the SQL package and to verify that the SQL package is correct for this program. Because the name of the SQL package is critical for running distributed SQL programs, an SQL package cannot be:

- Moved
- Renamed
- Duplicated
- Restored to a different library

Module

A *module* is an Integrated Language Environment® (ILE) object that you create by compiling source code using the Create Module (CRTxxxMOD) command (or any of the Create Bound Program (CRTBNDxxx) commands, where xxx is C, CBL, CPP, or RPG).

You can run a module only if you use the Create Program (CRTPGM) command to bind it into a program. You typically bind several modules together, but you can bind a module by itself. Modules contain information about the SQL statements; however, the SQL access plans are not created until the modules are bound into either a program or service program.

Related reference

[Create Program \(CRTPGM\) command](#)

Service program

A *service program* is an Integrated Language Environment (ILE) object that provides a means of packaging externally supported callable routines (functions or procedures) into a separate object.

Bound programs and other service programs can access these routines by resolving their imports to the exports provided by a service program. The connections to these services are made when the calling programs are created. This improves call performance to these routines without including the code in the calling program.

Data definition language

Data definition language (DDL) describes the portion of SQL that creates, alters, and deletes database objects. These database objects include schemas, tables, views, sequences, catalogs, indexes, variables, masks, permissions, and aliases.

Related concepts

[Types of SQL statements](#)

There are several basic types of SQL statements. They are listed here according to their functions.

Related tasks

[Getting started with SQL](#)

Creating a schema

A schema provides a logical grouping of SQL objects. To create a schema, use the CREATE SCHEMA statement.

A schema consists of a library, a journal, a journal receiver, a catalog, and optionally, a data dictionary. Tables, views, and system objects (such as programs) can be created, moved, or restored into any system libraries. All system files can be created or moved into an SQL schema if the SQL schema does not contain a data dictionary. If the SQL schema contains a data dictionary then:

- Source physical files or nonsource physical files with one member can be created, moved, or restored into an SQL schema.
- Logical files cannot be placed in an SQL schema because they cannot be described in the data dictionary.

You can create and own many schemas.

You can create a schema using the CREATE SCHEMA statement. For example, create a schema called DBTEMP:

```
CREATE SCHEMA DBTEMP
```

Related reference

[CREATE SCHEMA](#)

Creating a table

A table can be visualized as a two-dimensional arrangement of data that consists of rows and columns. To create a table, use the CREATE TABLE statement.

The row is the horizontal part containing one or more columns. The column is the vertical part containing one or more rows of data of one data type. All data for a column must be of the same type. A table in SQL is a keyed or non-keyed physical file.

You can create a table using the CREATE TABLE statement. You provide a name for the table. If the table name is not a valid system object name, you can use the optional FOR SYSTEM NAME clause to specify a system name.

The definition includes the names and attributes of its columns. The definition can include other attributes of the table, such as the primary key.

Example: Given that you have administrative authority, create a table named 'INVENTORY' with the following columns:

- Part number: Integer between 1 and 9999, and must not be null
- Description: Character of length 0 to 24
- Quantity on hand: Integer between 0 and 100000

The primary key is PARTNO.

```
CREATE TABLE INVENTORY
(PARTNO          SMALLINT      NOT NULL,
DESCR           VARCHAR(24 ),
QONHAND         INT,
PRIMARY KEY(PARTNO))
```

Related concepts

[Data types](#)

Adding and removing constraints

Constraints can be added to a new table or to an existing table. To add a unique or primary key, a referential constraint, or a check constraint, use the CREATE TABLE or the ALTER TABLE statement. To remove a constraint, use the ALTER TABLE statement.

For example, add a primary key to an existing table using the ALTER TABLE statement:

```
ALTER TABLE CORPDATA.DEPARTMENT
ADD PRIMARY KEY (DEPTNO)
```

To make this key a unique key, replace the keyword PRIMARY with UNIQUE.

You can remove a constraint using the same ALTER TABLE statement:

```
ALTER TABLE CORPDATA.DEPARTMENT
DROP PRIMARY KEY (DEPTNO)
```

Referential integrity and tables

Referential integrity is the condition of a set of tables in a database in which all references from one table to another are valid.

Consider the following example:

- CORPDATA.EMPLOYEE serves as a master list of employees.
- CORPDATA.DEPARTMENT acts as a master list of all valid department numbers.
- CORPDATA.EMP_ACT provides a master list of activities performed for projects.

Other tables refer to the same entities described in these tables. When a table contains data for which there is a master list, that data should actually appear in the master list, or the reference is not valid. The table that contains the master list is the *parent table*, and the table that refers to it is a *dependent table*. When the references from the dependent table to the parent table are valid, the condition of the set of tables is called *referential integrity*.

Stated another way, referential integrity is the state of a database in which all values of all foreign keys are valid. Each value of the foreign key must also exist in the parent key or be null. This definition of referential integrity requires an understanding of the following terms:

- A *unique key* is a column or set of columns in a table that uniquely identify a row. Although a table can have several unique keys, no two rows in a table can have the same unique key value.
- A *primary key* is a unique key that does not allow nulls. A table cannot have more than one primary key.
- A *parent key* is either a unique key or a primary key that is referenced in a referential constraint.
- A *foreign key* is a column or set of columns whose values must match those of a parent key. If any column value used to build the foreign key is null, the rule does not apply.
- A *parent table* is a table that contains the parent key.
- A *dependent table* is the table that contains the foreign key.
- A *descendent table* is a table that is a dependent table or a descendent of a dependent table.

Enforcement of referential integrity prevents the violation of the rule that states that every non-null foreign key must have a matching parent key.

SQL supports the referential integrity concept with the CREATE TABLE and ALTER TABLE statements.

Related reference

[CREATE TABLE](#)

[ALTER TABLE](#)

Adding and removing referential constraints

You can use the CREATE TABLE statement or the ALTER TABLE statement to add a referential constraint. To remove a referential constraint, use the ALTER TABLE statement.

Constraints are rules that ensure that references from one table, a dependent table, to data in another table, the parent table, are valid. You use referential constraints to ensure referential integrity.

With a referential constraint, non-null values of the foreign key are valid only if they also appear as values of a parent key. When you define a referential constraint, you specify:

- A primary or unique key
- A foreign key
- Delete and update rules that specify the action taken with respect to dependent rows when the parent row is deleted or updated.

Optionally, you can specify a name for the constraint. If a name is not specified, one is automatically generated.

After a referential constraint is defined, the system enforces the constraint on every INSERT, DELETE, and UPDATE operation performed through SQL or any other interface, including System i Navigator, CL commands, utilities, or high-level language statements.

Related reference

[CREATE TABLE](#)

[ALTER TABLE](#)

Example: Adding referential constraints

You define a referential constraint that every department number in the sample employee table must appear in the department table. The referential constraint ensures that every employee belongs to an existing department.

The following SQL statements create the CORPDATA.DEPARTMENT and CORPDATA.EMPLOYEE tables with those constraint relationships defined.

```
CREATE TABLE CORPDATA.DEPARTMENT
(DEPTNO    CHAR(3)    NOT NULL PRIMARY KEY,
DEPTNAME  VARCHAR(29) NOT NULL,
MGRNO     CHAR(6),
ADMRDEPT  CHAR(3)    NOT NULL
CONSTRAINT REPORTS_TO_EXISTS
REFERENCES CORPDATA.DEPARTMENT (DEPTNO)
ON DELETE CASCADE)

CREATE TABLE CORPDATA.EMPLOYEE
(EMPNO     CHAR(6)    NOT NULL PRIMARY KEY,
FIRSTNAME VARCHAR(12) NOT NULL,
MIDINIT   CHAR(1)    NOT NULL,
LASTNAME  VARCHAR(15) NOT NULL,
WORKDEPT  CHAR(3)    CONSTRAINT WORKDEPT_EXISTS
REFERENCES CORPDATA.DEPARTMENT (DEPTNO)
ON DELETE SET NULL ON UPDATE RESTRICT,

PHONENO   CHAR(4),
HIREDATE  DATE,
JOB       CHAR(8),
EDLEVEL   SMALLINT  NOT NULL,
SEX       CHAR(1),
BIRTHDATE DATE,
SALARY    DECIMAL(9,2),
BONUS     DECIMAL(9,2),
COMM      DECIMAL(9,2),
CONSTRAINT UNIQUE_LNAME_IN_DEPT UNIQUE (WORKDEPT, LASTNAME))
```

In this case, the DEPARTMENT table has a column of unique department numbers (DEPTNO) which functions as a primary key, and is a parent table in two constraint relationships:

REPORTS_TO_EXISTS

is a self-referencing constraint in which the DEPARTMENT table is both the parent and the dependent in the same relationship. Every non-null value of ADMRDEPT must match a value of DEPTNO. A

department must report to an existing department in the database. The DELETE CASCADE rule indicates that if a row with a DEPTNO value n is deleted, every row in the table for which the ADMRDEPT is n is also deleted.

WORKDEPT_EXISTS

establishes the EMPLOYEE table as a dependent table, and the column of employee department assignments (WORKDEPT) as a foreign key. Thus, every value of WORKDEPT must match a value of DEPTNO. The DELETE SET NULL rule says that if a row is deleted from DEPARTMENT in which the value of DEPTNO is n , then the value of WORKDEPT in EMPLOYEE is set to null in every row in which the value was n . The UPDATE RESTRICT rule says that a value of DEPTNO in DEPARTMENT cannot be updated if there are values of WORKDEPT in EMPLOYEE that match the current DEPTNO value.

Constraint UNIQUE_LNAME_IN_DEPT in the EMPLOYEE table causes LASTNAME to be unique within a department. While this constraint is unlikely, it illustrates how a constraint made up of several columns can be defined at the table level.

Example: Removing constraints

When you remove the primary key over the DEPTNO column in the DEPARTMENT table, other tables are affected.

You also remove the REPORTS_TO_EXISTS constraint that is defined on the DEPARTMENT table and the WORKDEPT_EXISTS constraint that is defined on the EMPLOYEE table, because the primary key that you remove is the parent key in those constraint relationships.

```
ALTER TABLE CORPDATA.EMPLOYEE DROP PRIMARY KEY
```

You can also remove a constraint by name, as in the following example:

```
ALTER TABLE CORPDATA.DEPARTMENT  
DROP CONSTRAINT UNIQUE_LNAME_IN_DEPT
```

Check pending

Referential constraints and check constraints can be in a check pending state, where potential violations of the constraints exist.

For referential constraints, a violation occurs when potential mismatches exist between parent and foreign keys. For check constraints, a violation occurs when potential values exist in columns that are limited by the check constraint. When the system determines that a constraint might have been violated (such as after a restore operation), the constraint is marked as check pending. When this happens, restrictions are placed on the use of tables involved in the constraint. For referential constraints, the following restrictions apply:

- No input or output operations are allowed on the dependent file.
- Only read and insert operations are allowed on the parent file.

When a check constraint is in check pending, the following restrictions apply:

- Read operations are not allowed on the file.
- Insert and update operations are allowed and the constraint is enforced.

To get a constraint out of check pending, follow these steps:

1. Disable the relationship with the Change Physical File Constraint (CHGPFCST) CL command.
2. Correct the key (foreign, parent, or both) data for referential constraints or column data for check constraints.
3. Enable the constraint again with the CHGPFCST CL command.

You can identify the rows that are in violation of the constraint with the Display Check Pending Constraint (DSPCPCST) CL command or by looking in the Database Maintenance folder in IBM i Navigator.

Related concepts

[Check pending status in referential constraints](#)

Related tasks

[Working with constraints that are in check pending status](#)

Creating a table using LIKE

You can create a table that looks like another table. That is, you can create a table that includes all of the column definitions from an existing table.

The following definitions are copied:

- Column names (and system column names)
- Data type, length, precision, and scale
- CCSID
- FIELDPROC

If the LIKE clause immediately follows the table name and is not enclosed in parentheses, the following attributes are also included:

- Column text (LABEL ON)
- Column heading (LABEL ON)
- Default value
- Hidden attribute
- Identity attribute
- Nullability

If the specified table or view contains an identity column, you must specify the option INCLUDING IDENTITY on the CREATE TABLE statement if you want the identity column to exist in the new table. The default behavior for CREATE TABLE is EXCLUDING IDENTITY. There are similar options to include the default value, the hidden attribute, and the row change timestamp attribute. If the specified table or view is a non-SQL-created physical file or logical file, any non-SQL attributes are removed.

Create a table EMPLOYEE2 that includes all of the columns in EMPLOYEE:

```
CREATE TABLE EMPLOYEE2 LIKE EMPLOYEE
```

Related reference

[CREATE TABLE](#)

Creating a table using AS

You can create a table from the result of a SELECT statement. To create this type of table, use the CREATE TABLE AS statement.

All of the expressions that can be used in a SELECT statement can be used in a CREATE TABLE AS statement. You can also include all of the data from the table or tables that you are selecting from.

For example, create a table named EMPLOYEE3 that includes a subset of column definitions and data from the EMPLOYEE table where the WORKDEPT = D11.

```
CREATE TABLE EMPLOYEE3 AS
(SELECT EMPNO, LASTNAME, JOB
 FROM EMPLOYEE
 WHERE WORKDEPT = 'D11') WITH DATA
```

If the specified table or view contains an identity column, you must specify the option INCLUDING IDENTITY on the CREATE TABLE statement if you want the identity column to exist in the new table. The default behavior for CREATE TABLE is EXCLUDING IDENTITY. There are similar options to include the default value, the hidden attribute, and the row change timestamp attribute. The WITH NO DATA

clause indicates that the column definitions are to be copied without the data. If you want to include the data in the new table EMPLOYEE3, include the WITH DATA clause. If the specified query includes a non-SQL-created physical file or logical file, any non-SQL result attributes are removed.

Related concepts

[Retrieving data using the SELECT statement](#)

The SELECT statement tailors your query to gather data. You can use the SELECT statement to retrieve a specific row or retrieve data in a specific way.

Related reference

[Creating a table with remote server data](#)

You can create a table on the local server that references one or more tables on a remote server.

[CREATE TABLE](#)

Creating and altering a materialized query table

A *materialized query table* is a table whose definition is based on the result of a query, and whose data is in the form of precomputed results that are taken from the table or tables on which the materialized query table definition is based.

If the optimizer determines that a query runs faster against a materialized query table than it does against the base table or tables, the query will run against the materialized query table. You can directly query a materialized query table. For more information about how the optimizer uses materialized query tables, see the [Database performance and query optimization](#) topic.

Assume a very large transaction table named TRANS contains one row for each transaction processed by a company. The table is defined with many columns. Create a materialized query table for the TRANS table that contains daily summary data for the date and amount of a transaction by issuing the following:

```
CREATE TABLE STRANS
  AS (SELECT YEAR AS SYEAR, MONTH AS SMONTH, DAY AS SDAY, SUM(AMOUNT) AS SSUM
      FROM TRANS
      GROUP BY YEAR, MONTH, DAY )
DATA INITIALLY DEFERRED
REFRESH DEFERRED
MAINTAINED BY USER
```

This materialized query table specifies that the table is not populated at the time that it is created by using the DATA INITIALLY DEFERRED clause. REFRESH DEFERRED indicates that changes made to TRANS are not reflected in STRANS. Additionally, this table is maintained by the user, enabling the user to use ALTER, INSERT, DELETE, and UPDATE statements.

To populate the materialized query table or refresh the table after it has been populated, use the REFRESH TABLE statement. This causes the query associated with the materialized query table to be run and causes the table to be filled with the results of the query. To populate the STRANS table, run the following statement:

```
REFRESH TABLE STRANS
```

You can create a materialized query table from an existing base table as long as the result of the select-statement provides a set of columns that match the columns in the existing table (same number of columns and compatible column definitions). For example, create a table TRANSCOUNT. Then, change the base table TRANSCOUNT into a materialized query table:

To create the table:

```
CREATE TABLE TRANSCOUNT
  (ACCTID SMALLINT NOT NULL,
   LOCID SMALLINT,
   YEAR DATE
   CNT INTEGER)
```

You can alter this table to be a materialized query table:

```
ALTER TABLE TRANSCOUNT
ADD MATERIALIZED QUERY
(SELECT ACCTID, LOCID, YEAR, COUNT(*) AS CNT
FROM TRANS
GROUP BY ACCTID, LOCID, YEAR )
DATA INITIALLY DEFERRED
REFRESH DEFERRED
MAINTAINED BY USER
```

Finally, you can change a materialized query table back to a base table. For example:

```
ALTER TABLE TRANSCOUNT
DROP MATERIALIZED QUERY
```

In this example, the table TRANSCOUNT is not dropped, but it is no longer a materialized query table.

Related concepts

[Tables, rows, and columns](#)

A *table* is a two-dimensional arrangement of data that consists of *rows* and *columns*.

Creating a system-period temporal table

You can define a pair of tables that are used to maintain the current data as well as the historical data for a table. These tables are called a system-period temporal table and a history table.

A system-period temporal table is defined just like any other table except that it must have three additional timestamp columns and a system period. The history table is defined with identical columns to the system-period temporal table. An ALTER TABLE statement is used to connect the two tables in a versioned relationship.

For example, suppose you want to keep track of all changes to the DEPARTMENT table. You would define the table as follows:

```
CREATE OR REPLACE TABLE DEPARTMENT
(DEPTNO CHAR(3) NOT NULL,
DEPTNAME VARCHAR(36) NOT NULL,
MGRNO CHAR(6),
ADMRDEPT CHAR(3) NOT NULL,
LOCATION CHAR(16),
START_TS TIMESTAMP(12) NOT NULL GENERATED ALWAYS AS ROW BEGIN,
END_TS TIMESTAMP(12) NOT NULL GENERATED ALWAYS AS ROW END,
TS_ID TIMESTAMP(12) GENERATED ALWAYS AS TRANSACTION START ID,
PERIOD SYSTEM_TIME (START_TS, END_TS),
PRIMARY KEY (DEPTNO))
```

You would define the corresponding history table as follows:

```
CREATE TABLE DEPARTMENT_HIST LIKE DEPARTMENT
```

Then you would tie them together in a versioning relationship like this:

```
ALTER TABLE DEPARTMENT ADD VERSIONING USE HISTORY TABLE DEPARTMENT_HIST
```

Once versioning is defined for the system-period temporal table, updates and deletes to it cause the version of the row prior to the change to be inserted as a row in the history table. The special row begin and row end timestamp columns are set by the system to indicate the time span when the data for the historical row was the active data.

You can write a query that will automatically return data from both the system-period temporal table and the history table.

For example, to see what the DEPARTMENT table looked like six months ago, issue the following query:

```
SELECT * FROM DEPARTMENT FOR SYSTEM_TIME AS OF CURRENT_TIMESTAMP - 6 MONTHS
```

Related reference

[Working with system-period temporal tables](#)

[CREATE TABLE](#)

[ALTER TABLE](#)

Declaring a global temporary table

You can create a temporary table for use with your current session. To create a temporary table, use the `DECLARE GLOBAL TEMPORARY TABLE` statement.

This temporary table does not appear in the system catalog and cannot be shared by other sessions. When you end your session, the rows of the table are deleted and the table is dropped.

The syntax of this statement is similar to that of the `CREATE TABLE` statement and can include the `LIKE` or `AS` clause.

For example, create a temporary table `ORDERS`:

```
DECLARE GLOBAL TEMPORARY TABLE ORDERS
(PARTNO SMALLINT NOT NULL,
DESCR VARCHAR(24),
QONHAND INT)
ON COMMIT DELETE ROWS
```

This table is created in `QTEMP`. To reference the table using a schema name, use either `SESSION` or `QTEMP`. You can issue `SELECT`, `INSERT`, `UPDATE`, and `DELETE` statements against this table, the same as any other table. You can drop this table by issuing the `DROP TABLE` statement:

```
DROP TABLE ORDERS
```

Related reference

[DECLARE GLOBAL TEMPORARY TABLE](#)

Creating a table with remote server data

You can create a table on the local server that references one or more tables on a remote server.

Along with the select-statement, you can specify copy options to get attributes such as the default values or identity column information copied for the new table. The `WITH DATA` or `WITH NO DATA` clause must be specified to indicate whether to populate the table from the remote system.

For example, create a table named `EMPLOYEE4` that includes column definitions from the `EMPLOYEE` table on remote server `REMOTESYS`. Include the data from the remote system as well.

```
CREATE TABLE EMPLOYEE4 AS
(SELECT PROJNO, PROJNAME, DEPTNO
FROM REMOTESYS.TESTSCHEMA.EMPLOYEE
WHERE DEPTNO = 'D11') WITH DATA
```

You can also create this table as a global temporary table, which will create it in `QTEMP`. In this example, different column names are provided for the new table. The table definition will pick up the default values for its columns from the remote server.

```
DECLARE GLOBAL TEMPORARY TABLE EMPLOYEE4 (Project_number, Project_name, Department_number) AS
(SELECT PROJNO, PROJNAME, DEPTNO
FROM REMOTESYS.TESTSCHEMA.EMPLOYEE
WHERE DEPTNO = 'D11') WITH DATA INCLUDING DEFAULTS
```

The following restrictions apply to using a remote server as the source for the new table:

- The materialized query table clauses are not allowed.
- A column with a `FIELDPROC` cannot be listed in the select list.
- The copy options cannot be specified if the remote server is Db2 for LUW or Db2 for z/OS®.

Related reference

[Creating a table using AS](#)

You can create a table from the result of a SELECT statement. To create this type of table, use the CREATE TABLE AS statement.

Creating a row change timestamp column

Every time a row is added or changed in a table with a row change timestamp column, the row change timestamp column value is set to the timestamp corresponding to the time of the insert or update operation.

The data type of a row change timestamp column must be TIMESTAMP. You can define only one row change timestamp column in a table.

When you create a table, you can define a column in the table to be a row change timestamp column. For example, create a table ORDERS with columns called ORDERNO, SHIPPED_TO, ORDER_DATE, STATUS, and CHANGE_TS. Define CHANGE_TS as a row change timestamp column.

```
CREATE TABLE ORDERS
  (ORDERNO SMALLINT,
   SHIPPED_TO VARCHAR(36),
   ORDER_DATE DATE,
   STATUS CHAR(1),
   CHANGE_TS TIMESTAMP FOR EACH ROW ON UPDATE AS ROW CHANGE TIMESTAMP NOT NULL)
```

When a row is inserted into the ORDERS table, the CHANGE_TS column for the row is set to the timestamp of the insert operation. Any time a row in ORDERS is updated, the CHANGE_TS column for the row is modified to reflect the timestamp of the update operation.

You can drop the row change timestamp attribute from a column:

```
ALTER TABLE ORDER
  ALTER COLUMN CHANGE_TS
  DROP ROW CHANGE TIMESTAMP
```

The column CHANGE_TS remains as a TIMESTAMP column in the table, but the system no longer automatically updates timestamp values for this column.

Creating auditing columns

Every time a row is added or changed in a table that has an auditing column, the value of the audit column is generated by the database manager. These generated values are maintained for both SQL and native changes to the row.

There are three types of values that the system uses to maintain status information for any modification to a row: the type of data change, a special register, or a built-in global variable. You can have multiple columns in a table that track this information. Each column defined as one of these generated expression columns must have a data type that exactly matches the required definition for the item being generated.

- A column defined to contain a generated data change operation column will be updated with an I or U to indicate whether the last modification was an insert or an update. For a history table, a value of D can be generated to indicate that the row was deleted.
- A column defined to contain a generated special register value will be assigned the current value of the special register when the data change operation occurs.
- A column defined to contain a generated built-in global variable value will be assigned the current value of the global variable when the data change operation occurs.

When you create a table, you can define columns for these generated expressions. For example, create a table EMPLOYEE with columns called EMPNO, NAME, WORKDEPT, and SALARY. Define auditing columns

to track the type of change, the user who made the change, the application that made the change, and the qualified job name where the change originated.

```
CREATE TABLE EMPLOYEE
(EMPNO CHAR(6),
NAME VARCHAR(50),
WORKDEPT CHAR(3),
SALARY DECIMAL(9,2),
EMP_CHANGE_TYPE CHAR(1) GENERATED ALWAYS AS (DATA_CHANGE_OPERATION),
EMP_CHANGE_USER VARCHAR(128) GENERATED ALWAYS AS (SESSION_USER),
EMP_CHANGE_APPLNAME VARCHAR(255) GENERATED ALWAYS AS (CURRENT_CLIENT_APPLNAME),
EMP_CHANGE_JOBNAME VARCHAR(28) GENERATED ALWAYS AS (QSYS2.JOB_NAME))
```

When you add a generated expression column to an existing table, defining the IMPLICITLY HIDDEN attribute for the column as well can prevent existing applications that use SQL from requiring modifications. Hidden columns are excluded when a SELECT *, an INSERT without a column list, or an UPDATE using ROW determines its implicit list of columns. The only time a hidden column is included is when it is explicitly mentioned by name.

These auditing columns can be especially useful when using a system-period temporal table. Since all the historical rows are kept in the corresponding history table, an auditing column will complement the history by recording information such as who was responsible for each change.

Related reference

[CREATE TABLE](#)

[Using a system-period temporal table for tracking auditing information](#)

Creating and altering an identity column

Every time a row is added to a table with an identity column, the identity column value for the new row is generated by the system.

Only columns of type SMALLINT, INTEGER, BIGINT, DECIMAL, or NUMERIC can be created as identity columns. You are allowed only one identity column per table. When you are changing a table definition, only a column that you are adding can be specified as an identity column; existing columns cannot.

When you create a table, you can define a column in the table to be an identity column. For example, create a table ORDERS with three columns called ORDERNO, SHIPPED_TO, and ORDER_DATE. Define ORDERNO as an identity column.

```
CREATE TABLE ORDERS
(ORDERNO SMALLINT NOT NULL
GENERATED ALWAYS AS IDENTITY
(START WITH 500
INCREMENT BY 1
CYCLE),
SHIPPED_TO VARCHAR (36) ,
ORDER_DATE DATE)
```

This column is defined with a starting value of 500, incremented by 1 for every new row inserted, and will recycle when the maximum value is reached. In this example, the maximum value for the identity column is the maximum value for the data type. Because the data type is defined as SMALLINT, the range of values that can be assigned to ORDERNO is from 500 to 32 767. When this column value reaches 32 767, it will restart at 500 again. If 500 is still assigned to a column, and a unique key is specified on the identity column, a duplicate key error is returned. The next insert operation will attempt to use 501. If you do not have a unique key specified for the identity column, 500 is used again, regardless of how many times it appears in the table.

For a larger range of values, specify the column to be data type INTEGER or even BIGINT. If you want the value of the identity column to decrease, specify a negative value for the INCREMENT option. It is also possible to specify the exact range of numbers by using MINVALUE and MAXVALUE.

You can modify the attributes of an existing identity column using the ALTER TABLE statement. For example, you want to restart the identity column with a new value:

```
ALTER TABLE ORDER
ALTER COLUMN ORDERNO
RESTART WITH 1
```

You can also drop the identity attribute from a column:

```
ALTER TABLE ORDER
ALTER COLUMN ORDERNO
DROP IDENTITY
```

The column ORDERNO remains as a SMALLINT column, but the identity attribute is dropped. The system will no longer generate values for this column.

Related reference

[Comparison of identity columns and sequences](#)

While identity columns and sequences are similar in many ways, there are also differences.

[Inserting values into an identity column](#)

You can insert a value into an identity column or allow the system to insert a value for you.

[Updating an identity column](#)

You can update the value in an identity column to a specified value or have the system generate a new value.

Using ROWID

Using ROWID is another way to have the system assign a unique value to a column. ROWID is similar to identity columns. But rather than being an attribute of a numeric column, it is a separate data type.

To create a table similar to the identity column example:

```
CREATE TABLE ORDERS
(OORDERNO ROWID
GENERATED ALWAYS,
SHIPPED_TO VARCHAR (36) ,
ORDER_DATE DATE)
```

Creating and using sequences

Sequences are similar to identity columns in that they both generate unique values. However, sequences are objects that are independent of any tables. You can use sequences to generate values quickly and easily.

Sequences are not tied to a column in a table and are accessed separately. Additionally, they are not treated as any part of a transaction's unit of work.

You create a sequence using the CREATE SEQUENCE statement. For an example similar to the identity column example, create a sequence ORDER_SEQ:

```
CREATE SEQUENCE ORDER_SEQ
START WITH 500
INCREMENT BY 1
MAXVALUE 1000
CYCLE
CACHE 24
```

This sequence is defined with a starting value of 500, incremented by 1 for every use, and recycles when the maximum value is reached. In this example, the maximum value for the sequence is 1000. When this value reaches 1000, it will restart at 500 again.

After this sequence is created, you can insert values into a column using the sequence. For example, insert the next value of the sequence ORDER_SEQ into a table ORDERS with columns ORDERNO and CUSTNO.

First, create the table ORDERS:

```
CREATE TABLE ORDERS
(ORDERNO SMALLINT NOT NULL,
CUSTNO SMALLINT);
```

Then, insert the sequence value:

```
INSERT INTO ORDERS (ORDERNO, CUSTNO)
VALUES (NEXT VALUE FOR ORDER_SEQ, 12)
```

Running the following statement returns the values in the columns:

```
SELECT *
FROM ORDERS
```

Table 2. Results for SELECT from table ORDERS

ORDERNO	CUSTNO
500	12

In this example, the next value for sequence ORDER is inserted into the ORDERNO column. Issue the INSERT statement again. Then run the SELECT statement.

Table 3. Results for SELECT from table ORDERS

ORDERNO	CUSTNO
500	12
501	12

You can also insert the previous value for the sequence ORDER by using the PREVIOUS VALUE expression. You can use NEXT VALUE and PREVIOUS VALUE in the following expressions:

- Within the *select-clause* of a SELECT statement or SELECT INTO statement as long as the statement does not contain a DISTINCT keyword, a GROUP BY clause, an ORDER BY clause, a UNION keyword, an INTERSECT keyword, or an EXCEPT keyword
- Within a VALUES clause of an INSERT statement
- Within the *select-clause* of the fullselect of an INSERT statement
- Within the SET clause of a searched or positioned UPDATE statement, though NEXT VALUE cannot be specified in the *select-clause* of the subselect of an expression in the SET clause

You can alter a sequence by issuing the ALTER SEQUENCE statement. Sequences can be altered in the following ways:

- Restarting the sequence
- Changing the increment between future sequence values
- Setting or eliminating the minimum or maximum values
- Changing the number of cached sequence numbers
- Changing the attribute that determines whether the sequence can cycle or not
- Changing whether sequence numbers must be generated in order of request

For example, change the increment of values of sequence ORDER from 1 to 5:

```
ALTER SEQUENCE ORDER_SEQ
INCREMENT BY 5
```

After this change is complete, run the INSERT statement again and then the SELECT statement. Now the table contains the following columns.

<i>Table 4. Results for SELECT from table ORDERS</i>	
ORDERNO	CUSTNO
500	12
501	12
528	12

Notice that the next value that the sequence uses is a 528. At first glance, this number appears to be incorrect. However, look at the events that lead up to this assignment. First, when the sequence was originally create, a cache value of 24 was assigned. The system assigns the first 24 values for this cache. Next, the sequence was altered. When the ALTER SEQUENCE statement is issued, the system drops the assigned values and starts up again with the next available value; in this case the original 24 that was cached, plus the next increment, 5. If the original CREATE SEQUENCE statement did not have the CACHE clause, the system automatically assigns a default cache value of 20. If that sequence was altered, then the next available value is 25.

Related concepts

Sequences

A *sequence* is a data area object that provides a quick and easy way of generating unique numbers.

Comparison of identity columns and sequences

While identity columns and sequences are similar in many ways, there are also differences.

Examine these differences before you decide which to use.

An identity column has the following characteristics:

- An identity column can be defined as part of a table when the table is created or it can be added to a column using alter table. After a table is created, the identity column characteristics can be changed.
- An identity column automatically generates values for a single table.
- When an identity column is defined as GENERATED ALWAYS, the values used are always generated by the database manager. Applications are not allowed to provide their own values when changing the contents of the table.
- The IDENTITY_VAL_LOCAL function can be used to see the most recently assigned value for an identity column.

A sequence has the following characteristics:

- A sequence is a system object of type *DTAARA that is not tied to a table.
- A sequence generates sequential values that can be used in any SQL statement.
- There are two expressions used to retrieve the next values in the sequence and to look at the previous value assigned for the sequence. The PREVIOUS VALUE expression returns the most recently generated value for the specified sequence for a previous statement within the current session. The NEXT VALUE expression returns the next value for the specified sequence. The use of these expressions allows the same value to be used across several SQL statements within several tables.

While these are not all of the characteristics of identity columns and sequences, these characteristics can help you determine which to use depending on your database design and the applications that use the database.

Related reference

Creating and altering an identity column

Every time a row is added to a table with an identity column, the identity column value for the new row is generated by the system.

Defining field procedures

Field procedures are assigned to a table by the FIELDPROC clause of the CREATE TABLE and ALTER TABLE statements. A field procedure is a user-written exit routine that transforms values in a single column.

When values in the column are changed, or new values inserted, the field procedure is invoked for each value, and can transform that value (encode it) in any way. The encoded value is then stored. When values are retrieved from the column, the field procedure is invoked for each value, which is encoded, and must decode it back to the original value. Any indexes defined on a non-derived column that uses a field procedure are built with encoded values.

The transformation your field procedure performs on a value is called *field-encoding*. The same routine is used to undo the transformation when values are retrieved; that operation is called *field-decoding*. Values in columns with a field procedure are described to Db2 in two ways:

1. The description of the column as defined in CREATE TABLE or ALTER TABLE appears in the catalog table QSYS2.SYSCOLUMNS. That is the description of the field-decoded value, and is called the *column description*.
2. The description of the encoded value, as it is stored in the database, appears in the catalog table QSYS2.SYSFIELDS. That is the description of the field-encoded value, and is called the *field description*.

Important: The field-decoding function must be the exact inverse of the field-encoding function. For example, if a routine encodes 'ALABAMA' to '01', it must decode '01' to 'ALABAMA'. A violation of this rule can lead to unpredictable results. See [“General guidelines for writing field procedures”](#) on page 47.

Field procedures can also perform masking of data when decoded (retrieved). In this case, the field procedure would decode '01' to 'ALABAMA' for certain users or environments and for other users or environments may return a masked value such as 'XXXXXXXX' instead. See [“Guidelines for writing field procedures that mask data”](#) on page 49.

Field procedures can be defined for columns in a physical file. However, if the Change Physical File (CHGPF) command is used to alter the definition, the field procedure is removed and must be re-established.

Field definition for field procedures

The field procedure is also invoked when the table is created or altered, to define the data type and attributes of an encoded value to Db2. That operation is called *field-definition*.

The data type of the encoded value can be any valid SQL data type except ROWID or DATALINK. Also a field procedure cannot be associated with any column having values generated as IDENTITY, ROW CHANGE TIMESTAMP, ROW BEGIN, ROW END, TRANSACTION START ID, or a generated expression.

If a DDS-created physical file is altered to add a field procedure, the encoded attribute data type cannot be a LOB type or DataLink. If an SQL table is altered to add a field procedure, the encoded attribute precision field must be 0 if the encoded attribute data type is any of the integer types.

A field procedure may not be added to a column that has a default value of CURRENT DATE, CURRENT TIME, CURRENT TIMESTAMP, or USER.

A column defined with a user-defined data type can have a field procedure if the source type of the user-defined data type is any of the allowed SQL data types. Db2 casts the value of the column to the source type before it passes it to the field procedure.

Specifying the field procedure

To name a field procedure for a column, use the `FIELDPROC` clause of the `CREATE TABLE` or `ALTER TABLE` statement, followed by the name of the procedure and, optionally, a list of parameters.

The optional parameter list that follows the procedure name is a list of constants, enclosed in parentheses, called the *literal list*. The literal list is converted by Db2 into a data structure called the *field procedure parameter value list* (FPPVL). The FPPVL is passed to the field procedure during the field-definition operation. At that time, the procedure can modify it or return it unchanged. The output form of the FPPVL is called the *modified FPPVL*. It is stored in the Db2 `QSYS2.SYSFIELDS` catalog table as part of the column description. The modified FPPVL is passed again to the field procedure whenever that procedure is invoked for field-encoding or field-decoding.

When field procedures are invoked

A field procedure that is specified for a column is invoked in three general situations.

- For field-definition, when the `CREATE TABLE` or `ALTER TABLE` statement that names the procedure is executed. During this invocation, the procedure is expected to:
 - Determine whether the data type and attributes of the column are valid.
 - Verify the literal list, and change it if desired.
 - Provide the field description of the column.
- For field-encoding, when a column value is to be encoded. Encoding occurs for any value that:
 - Is inserted in the column by an SQL `INSERT` statement, SQL `MERGE` statement, or native write operation.
 - Is changed by an SQL `UPDATE` statement, SQL `MERGE` statement, or native update operation.
 - If the data needs to be copied and the target column has a field procedure, it is possible that the field procedure may be invoked to encode the copied data. Examples include the SQL statements `ALTER TABLE` or `CREATE TABLE` (with a `LIKE` or *as-result-table clause*) and the CL commands `CPYF` or `RGZPFM`.
 - Is compared to a column with a field procedure. The `QAQQINI` option `FIELDPROC_ENCODED_COMPARISON` is used by the optimizer to decide if the column value is decoded or if the variable, constant, or join column is encoded.
 - At `CREATE` or `ALTER TABLE` time for the `DEFAULT` value, if the column has a field procedure.

If there are any after or read triggers, the field procedure is invoked before any of these triggers.

For before triggers, there may be multiple invocations of the field procedure with encode and decode operations. The number of calls to the field procedure depends on many factors including the type of trigger and if the trigger changes the data in the trigger buffer. The database manager will ensure that the field procedure is called to encode the data that will be inserted into the table.

- For field-decoding, when a stored value is to be field-decoded back into its original value. This occurs for any value that is:
 - Retrieved by an SQL `SELECT` or `FETCH` statement, or by a native read operation.
 - If the data needs to be copied and the source column has a field procedure, it is possible that the field procedure may be invoked to decode the data prior to making the copy. Examples include the SQL statements `ALTER TABLE` or `CREATE TABLE` (with a `LIKE` or *as-result-table clause*) and the CL commands `CPYF` or `RGZPFM`.
 - Is compared to a column with a field procedure. The `QAQQINI` option `FIELDPROC_ENCODED_COMPARISON` is used by the optimizer to decide if the column value is decoded or if the variable or constant is encoded.

A field procedure is never invoked to process a null value. It is also not invoked for a `DELETE` operation without a `WHERE` clause when the table has no `DELETE` triggers. The field procedure is invoked for empty strings.

Recommendation: Avoid encoding blanks in a field procedure. When Db2 for i compares the values of two strings with different lengths, it temporarily pads the shorter string with the appropriate blank characters (for example, EBCDIC or double-byte blanks) up to the length of the longer string. If the shorter string is the value of a column with a field procedure, padding is done to the encoded value, but the pad character is not encoded. Therefore, if the procedure changes blanks to some other character, encoded blanks at the end of the longer string are not equal to padded blanks at the end of the shorter string. That situation can lead to errors; for example, some strings that ought to be equal might not be recognized as such. Therefore, encoding blanks in a field procedure is not recommended.

Parameter list for execution of field procedures

The field procedure parameter list communicates general information to a field procedure.

The parameter list tells what operation is to be done and allows the field procedure to signal errors. Db2 provides storage for all parameters that are passed to the field procedure. Therefore, parameters are passed to the field procedure by address.

When defining and using the parameters in the field procedure, care should be taken to ensure that no more storage is referenced for a given parameter than is defined for that parameter. The parameters are all stored in the same space and exceeding a given parameter's storage space can overwrite another parameter's value. This, in turn, can cause the field procedure to see invalid input data or cause the value returned to the database to be invalid.

Parameter 1

A small (2 byte) integer that describes the function to be performed. This parameter is input only. Supported values are:

- 0 – field-encoding
- 4 – field-decoding
- 8 – field-definition

Parameter 2

A structure that defines the field procedure parameter value list (FPPVL).

- For function code 8, this parameter is input/output.
- For function code 0 and 4, this parameter contains the output of the function code 8 call. This parameter is input only

Parameter 3

The decoded data attribute that is defined by the Column Value Descriptor (CVD). This is the column attributes that were specified at CREATE TABLE or ALTER TABLE time. This parameter is input only.

Parameter 4

The decoded data. The exact structure is dependent on function code.

- If function code 8, then the NULL value. This parameter is input only.
- If function code 0, then the data to be encoded. This parameter is input only.
- If function code 4, then the location to place the decoded data. This parameter is output only.

Parameter 5

The encoded data attribute that is defined by the Field Value Descriptor (FVD).

- If function code 8, then the structure containing the encoded data attributes. This parameter is output only.
- If function code 0 or 4, then a structure containing the encoded data attributes that was returned by the function 8 call. This parameter is input only.

Parameter 6

The encoded data that is defined by the Field Value Descriptor (FVD). The exact structure is dependent on function code.

- If function code 8, then the NULL value. This parameter is input only.

- If function code 0, then the location to place the encoded data. This parameter is output only.
- If function code 4, then the encoded form of the data. This parameter is input only.

Parameter 7

The SQLSTATE (character(5)). This parameter is input/output.

This parameter is set by Db2 to '00000' before calling the field procedure. It can be set by the field procedure. While normally the SQLSTATE is not set by a field procedure, it can be used to signal an error to the database as follows:

- If the field procedure detects an error, it should set the SQLSTATE to '38xxx', where xxx may be one of several possible strings. For more information, see Db2 Messages and Codes.

Warnings are not supported for field procedures

Parameter 8

The message text area (varchar(1000)). This parameter is input/output.

This argument is set by Db2 to the empty string before calling the field procedure. It is a VARCHAR(1000) value that can be used by the field procedure to send message text back when an SQLSTATE error is signaled by the field procedure. Message text is ignored by Db2 unless the SQLSTATE parameter is set by the field procedure. The message text is assumed to be in the job CCSID.

Parameter 9

A 128-byte structure containing additional information for the field procedure. This parameter is input only.

This structure is set by Db2 before calling the field procedure.

- `sqlfpNoMask` - For field procedures that mask data, it indicates that the caller is a system function that requires that the data be decoded without masking. For example, in some cases, RGZPFM and ALTER TABLE may need to copy data. If the field procedure ignores this parameter and masks data when these operations are performed, the column data will be lost. Hence, it is critical that a field procedure that masks data properly handle this parameter.

Supported values are:

- '0' - Normal masking applied if needed.
- '1' - Do not mask, this decode operation is being performed on behalf of the database manager.

- `sqlfpOperation` - This parameter indicates whether the field procedure is being called for an encode operation that is building a key value for a key positioning operation. Key positioning operations such as RPG SETLL, RPG CHAIN, and COBOL START are common in applications that use the non-SQL interface for data access. This parameter can be useful for field procedure that mask data.

Supported values are:

- '0' - Not called for key positioning.
- '1' - Called for key positioning.

If a field procedure encounters a masked value on an encode request to build a key value, there are two actions for the field procedure to take:

- Return SQLSTATE '09501' in parameter 7 which will cause the key positioning operation to fail with a field procedure error.
- Return the masked value as the encoded value in parameter 6, so that the key positioning operation can continue using the masked value. In this case, the key positioning operation may or may not be successful. For example, an RPG SETLL request will likely be successful. However, an RPG CHAIN operation will likely fail with a record not found error.

Include SQLFP in QSYSINC/H describes these parameters.

The field procedure parameter value list (FPPVL)

The field procedure parameter value list communicates the literal list, supplied in the CREATE TABLE or ALTER TABLE statement, to the field procedure during field-definition.

At that time, the field procedure can reformat the FPPVL; it is the reformatted FPPVL that is stored in QSYS2.SYSFIELDS and communicated to the field procedure during field-encoding and field-decoding as the *modified FPPVL*.

The following tables describe the FPPVL:

Name	Offset	Data Type	Description
sqlfpOptParmValueListLength	0	4-byte integer	Length in bytes of this structure
sqlfpNumberOfOptionalParms	4	4-byte integer	Number of value descriptors that follow. Equal to the number of parameters in the FIELDPROC clause. Zero if no parameters were listed.
sqlfpParmList	8	structure sqlfpOptionalParameterValueDescriptor_T	A list containing sqlfpNumberOfOptionalParms count of sqlfpOptionalParameterValueDescriptor_T items.

Name	Offset	Data Type	Description
sqlfpOptDescLength	0	4-byte integer	Length in bytes of this structure
sqlfpParmDesc	4	structure sqlfpParameterDescription_T	Parameter description
reserved2	38	character(12)	Not used
sqlfpParmData	40		The optional parameter data value. <ul style="list-style-type: none"> • If the value is a varying-length string, the first 2 bytes contains its length. • If the value is a LOB or XML string, the first 4 bytes contains its length. • If this value is numeric, the internal numeric representation of the data. • If a datetime value, the value is in *ISO format.

Parameter value descriptors for field procedures

A parameter value descriptor describes the data type and other attributes of a value.

Parameter value descriptors are used with field procedures in these ways:

- During field-definition, they describe each constant in the field procedure parameter value list (FPPVL). The set of these optional parameter value descriptors are part of the FPPVL control block.
- During field-encoding and field-decoding, the decoded (column) value and the encoded (field) attributes are described by the column value descriptor (CVD) and the field value descriptor (FVD).

The *column value descriptor (CVD)* contains a description of a column value. During field-encoding, the CVD describes the value to be encoded. During field-decoding, it describes the decoded value to be supplied by the field procedure. During field-definition, it describes the column as defined in the CREATE TABLE or ALTER TABLE statement.

The *field value descriptor (FVD)* contains a description of a field value. During field-encoding, the FVD describes the encoded value to be returned from the field procedure. During field-decoding, it describes the value to be decoded. During field-definition a description of the encoded value must put into the FVD.

The following table describes a parameter value descriptor:

Table 7. sqlfpParameterDescription_T			
Name	Offset	Data Type	Description
sqlfpSqlType	0	2-byte integer	SQL data type of this parameter. See Appendix D of the SQL Reference for supported values.
sqlfpByteLength	2	unsigned 4-byte integer	Length in bytes of this parameter. For datetime parameters, the length of the string representation of the parameter.
sqlfpLength	6	unsigned 4-byte integer	Length in characters of this parameter. If this is not a character or graphic type, sqlfpLength and sqlfpByteLength are the same value.
sqlfpPrecision	10	2-byte integer	Precision if this is a numeric parameter that has precision (decimal, zoned, binary with precision and scale).
sqlfpScale	12	2-byte integer	Scale if this is a numeric parameter that has scale (decimal, zoned, binary with precision and scale). Scale of 0 if this is a date or time parameter. Scale of 6 if this is a timestamp parameter.
sqlfpCcsid	14	unsigned 2-byte integer	CCSID of this parameter if character or graphic or XML.
sqlfpAllocatedLength	16	unsigned 2-byte integer	The allocated length specified for the column on the CREATE TABLE or ALTER TABLE statement.
reserved1	18	character(14)	Reserved.

Field-definition (function code 8)

The input provided to the field-definition operation, and the output required, are as follows:

- **Parameter 1**

Input - A small (2 byte) integer that describes the function to be performed (8 - field-definition).

- **Parameter 2**

Input/Output - A structure that defines the field procedure parameter value list (FPPVL). This is an auto-extendable space. The minimum length of this structure is 8 bytes. The maximum returned length of this structure is 32K.

- **Parameter 3**

Input - The structure sqlfpParameterDescription_T containing the decoded data attributes.

- **Parameter 4**

Not used.

- **Parameter 5**

Output - The structure sqlfpParameterDescription_T containing the encoded data attributes. The output sqlfpParameterDescription_T must be valid with the appropriate CCSID, length, precision, and scale fields set.

- **Parameter 6**

Not used.

- **Parameter 7**

Input/Output - The SQLSTATE (character(5)).

- **Parameter 8**

Input/Output - The message text area (varchar(1000)).

- **Parameter 9**

Input - Reserved.

Errors returned by a field procedure result in SQLCODE -681 (SQLSTATE '23507'), which is set in the SQL communication area (SQLCA) and the DB2_RETURNED_SQLCODE and RETURNED_SQLSTATE condition area item of the SQL diagnostics area. The contents of Parameter 7 and 8 are placed into the tokens, in SQLCA, as field SQLERRMT and in the SQL Diagnostic area condition area item MESSAGE_TEXT. The meaning of the error message is determined by the field procedure.

Invalid data in Parameter 5, sqlfpParameterDescription_T, or an invalid length in Parameter 2 results in SQLCODE -685 (SQLSTATE '58002'). If the database manager is unable to invoke the field procedure then SQLCODE -682 (SQLSTATE '57010') is returned.

The FPPVL can be redefined to suit the field procedure, and returned as the modified FPPVL, subject to the following restriction:

- sqlfpOptParmValueListLength must contain the actual length of the modified FPPVL. If no parameter list is returned, then sqlfpOptParmValueListLength must be set to 8.

The modified FPPVL is recorded in the catalog table QSYS2.SYSFIELDS, and is passed to the field procedure during field-encoding and field-decoding. The modified FPPVL need not have the format of a field procedure parameter list, and it need not describe constants by optional parameter value descriptors.

The nullability attribute of the column may not be changed.

If the encoded data attribute is a character, graphic or XML type, the CCSID value must be set to a valid CCSID for the data type.

If the column has a non-null default value, the encoded default value must not exceed the length allowed for the column's default value.

Field-encoding (function code 0)

The input provided to the field-encoding operation, and the output required, are as follows:

- **Parameter 1**

Input - A small (2 byte) integer that describes the function to be performed (0 - field-encoding).

- **Parameter 2**

Input - A structure that defines the modified field procedure parameter value list (FPPVL).

- **Parameter 3**

Input - A structure described by sqlfpParameterDescription_T containing the decoded data attributes.

- **Parameter 4**

Input - Data to be encoded.

If the value is a varying-length string, the first 2 bytes contains its length. If the value is a LOB or XML, then the first 4 bytes contains the length. If the value is numeric, the internal numeric representation of the data. If a datetime value, the value is in *ISO format.

- **Parameter 5**

Input - A structure described by sqlfpParameterDescription_T containing the encoded data attributes.

- **Parameter 6**

Output - Location to place the encoded data.

If the encoded value is a varying-length string, the first 2 bytes must contain the length. If the encoded value is a LOB or XML, then the first 4 bytes must contain the length. If the value is numeric, the internal numeric representation of the data. If a datetime value, the value must be in *ISO format.

- **Parameter 7**

Input/Output - The SQLSTATE (character(5)).

- **Parameter 8**

Input/Output - The message text area (varchar(1000)).

- **Parameter 9**

Input - Reserved.

Errors returned by a field procedure result in SQLCODE -681 (SQLSTATE '23507'), which is set in the SQL communication area (SQLCA) and the DB2_RETURNED_SQLCODE and RETURNED_SQLSTATE condition area item of the SQL diagnostics area. The contents of Parameter 7 and 8 are placed into the tokens, in SQLCA, as field SQLERRMT and in the SQL Diagnostic area condition area item MESSAGE_TEXT. If the database manager is unable to invoke the field procedure then SQLCODE -682 (SQLSTATE '57010') is returned.

Field-decoding (function code 4)

The input provided to the field-decoding operation, and the output required, are as follows:

- **Parameter 1**
Input - A small (2 byte) integer that describes the function to be performed (4 - field-decoding).
- **Parameter 2**
Input - A structure that defines the modified field procedure parameter value list (FPPVL).
- **Parameter 3**
Input - A structure described by sqlfpParameterDescription_T containing the decoded data attributes.
- **Parameter 4**
Output – Location to place the decoded data.

If the decoded value is a varying-length string, the first 2 bytes must contain the length. If the decoded value is a LOB or XML, then the first 4 bytes must contain the length. If the value is numeric, the internal numeric representation of the data. If a datetime value, the value must be in *ISO format.
- **Parameter 5**
Input - A structure described by sqlfpParameterDescription_T containing the encoded data attributes.
- **Parameter 6**
Input - encoded data

If the value is a varying-length string, the first 2 bytes contains its length. If the value is a LOB or XML, then the first 4 bytes contains the length. If the value is numeric, the internal numeric representation of the data. If a datetime value, the value is in *ISO format.
- **Parameter 7**
Input/Output - The SQLSTATE (character(5)).
- **Parameter 8**
Input/Output - The message text area (varchar(1000)).
- **Parameter 9**
Input - Indicates that the caller is a system function that requires that the data be decoded without masking.

Errors returned by a field procedure result in SQLCODE -681 (SQLSTATE '23507'), which is set in the SQL communication area (SQLCA) and the DB2_RETURNED_SQLCODE and RETURNED_SQLSTATE condition area item of the SQL diagnostics area. The contents of Parameter 7 and 8 are placed into the tokens, in SQLCA, as field SQLERRMT and in the SQL Diagnostic area condition area item MESSAGE_TEXT. If the database manager is unable to invoke the field procedure then SQLCODE -682 (SQLSTATE '57010') is returned.

Example field procedure program

Add field procedure FP1 to column C1. The Field Procedure FP1 takes one parameter which indicates the number of bytes of the column the field procedure should operate on.

```
ALTER TABLE TESTTAB ALTER C1 SET FIELDPROC FP1(10)
```

The following two field procedure programs demonstrate the same operations being done first in ILE RPG and then in C. These programs illustrate how a field procedure program could use the IBM i Cryptographic Services APIs to encrypt and decrypt fixed length character, variable length character, or character LOB data.

The program demonstrates some of the possibilities with field procedure programs but does not attempt to handle every possible situation and error. Note how the following items are handled:

- Changing of the encoded data type from the decoded data type
- The addressing differences required for fixed length character, varying length character, and CLOB data.
- Usage of the optional parm structure (sqlfpOptionalParameterValueDescriptor_T).

More information about IBM i Cryptographic Services APIs, see [Cryptographic Services APIs](#)

Example field procedure written in ILE RPG

For a field procedure written in ILE RPG, you should consider the following items:

- For better performance, ACTGRP(*CALLER) and STGMDL(*INHERIT) is recommended when you compile your program. This example has these keywords in the Control statements (H specs).
- The THREAD keyword must be specified on the Control statements. This example has THREAD(*CONCURRENT), but THREAD(*SERIALIZE) could also be used.

```
ctl-opt main(SampleFieldProcProgram);
ctl-opt option(*srcstmt);
ctl-opt stgmdl(*inherit);
ctl-opt thread(*concurrent);
/if defined(*crtbndrpg)
  ctl-opt actgrp(*caller);
/endif

/copy QSYSINC/QRPGLESRC,QC3CCI
/copy QSYSINC/QRPGLESRC,QUSEC
/copy QSYSINC/QRPGLESRC,SQL
/copy QSYSINC/QRPGLESRC,SQLFP

// QSYSINC/H QC3DTAEN
dcl-pr Qc3EncryptData extproc(*dclcase);
  clearData pointer value;
  clearDataLen int(10) const;
  clearDataFormat char(8) const;
  algorithmDesc likeds(QC3D0200); // Qc3_Format_ALGD0200
  algorithmDescFormat char(8) const;
  keyDesc likeds(T_key_descriptor0200) const;
  keyDescFormat char(8) const;
  cryptoServiceProvider char(1) const;
  cryptoDeviceName char(10) const;
  encryptedData pointer value;
  lengthOfAreaForEncryptedData int(10) const;
  lengthOfEncryptedDataReturned int(10);
  errorCode likeds(QUSEC);
end-pr;

// QSYSINC/H QC3DTADE
dcl-pr Qc3DecryptData extproc(*dclcase);
  encryptedData pointer value;
  encryptedDataLen int(10) const;
  algorithmDesc likeds(QC3D0200); // Qc3_Format_ALGD0200
  algorithmDescFormat char(8) const;
  keyDesc likeds(T_key_descriptor0200) const;
  keyDescFormat char(8) const;
  cryptoServiceProvider char(1) const;
  cryptoDeviceName char(10) const;
  clearData pointer value;
  lengthOfAreaForClearData int(10) const;
  lengthOfClearDataReturned int(10);
  errorCode likeds(QUSEC);
end-pr;

// Constants from QSYSINC/H QC3CCI
dcl-c Qc3_AES 22;
dcl-c Qc3_ECB '0';
dcl-c Qc3_Pad_Char '1';
dcl-c Qc3_Bin_String '0';
dcl-c Qc3_Key_Parms 'KEYD0200';
dcl-c Qc3_Algorithm_Block_Cipher 'ALGD0200';
dcl-c Qc3_Data 'DATA0100';
dcl-c Qc3_Any_CSP '0';

// Constants from QSYSINC/H SQL
```

```

dcl-c SQL_TYP_CLOB          408; // CLOB - varying length string
dcl-c SQL_TYP_NCLOB        409; // (SQL_TYP_CLOB + 1 for NULL)

dcl-c SQL_TYP_VARCHAR      448; // VARCHAR(i) - varying length string
                                // (2 byte length)
dcl-c SQL_TYP_NVARCHAR     449; // (SQL_TYP_VARCHAR + 1 for NULL)
dcl-c SQL_TYP_CHAR         452; // CHAR(i) - fixed length string
dcl-c SQL_TYP_NCHAR        453; // (SQL_TYP_CHAR + 1 for NULL)
dcl-c SQL_TYP_BLOB         404; // BLOB - varying length string
dcl-c SQL_TYP_NBLOB        405; // (SQL_TYP_BLOB + 1 for NULL)

// Other constants
dcl-c KEY_MGMT_SIZE 16;
dcl-c MAX_VARCHAR_SIZE 32767;
dcl-c MAX_CLOB_SIZE 100000;

dcl-ds T_key_descriptor0200 template qualified;
    desc likeds(QC3D020000);
    key char(KEY_MGMT_SIZE);
end-ds;

// T_DECODED_VARCHAR is the same as a VARCHAR field in RPG
// but it is convenient to define it as a structure
// for this purpose
dcl-ds T_DECODED_VARCHAR qualified template;
    len int(5);
    data char(MAX_VARCHAR_SIZE);
end-ds;

dcl-ds T_DECODED_CLOB qualified template;
    len int(10);
    data char(MAX_CLOB_SIZE);
end-ds;

dcl-ds T_ENCODED_VARCHAR qualified template;
    len int(5);
    keyManagementData char(KEY_MGMT_SIZE);
    data char(MAX_VARCHAR_SIZE);
end-ds;

dcl-ds T_ENCODED_CLOB qualified template;
    len int(10);
    keyManagementData char(KEY_MGMT_SIZE);
    data char(MAX_CLOB_SIZE);
end-ds;

dcl-ds T_DECODED_DATA qualified template;
    varchar likeds(T_DECODED_VARCHAR) pos(1);
    clob likeds(T_DECODED_CLOB) pos(1);
end-ds;

dcl-ds T_ENCODED_DATA qualified template;
    varchar likeds(T_ENCODED_VARCHAR) pos(1);
    clob likeds(T_ENCODED_CLOB) pos(1);
end-ds;

dcl-ds T_optional qualified template;
    bytes uns(10);
    type_indicator char(1);
end-ds;

// Main procedure
dcl-proc SampleFieldProcProgram;

    dcl-pi *n EXTPGM('FP_EXV1RPG');
        FuncCode uns(5) const;
        OptionalParms likeds(T_optional);
        DecodedDataType likeds(SQLFPD); // sqlfpParameterDescription_T
        DecodedData likeds(T_DECODED_DATA);
        EncodedDataType likeds(SQLFPD); // sqlfpParameterDescription_T
        EncodedData likeds(T_ENCODED_DATA);
        SqlState char(5);
        Msgtext varchar(1000); // SQLFMT DS in QSYSINC/SQLFP is an RPG VARCHAR
    end-pi;

    dcl-ds ErrCode likeds(QUSEC) inz;

    dcl-ds ALGD0200 likeds(QC3D0200) inz;
    dcl-ds T_key_descriptor0200 qualified inz;
        desc LIKEDS(QC3D020000);
        key char(KEY_MGMT_SIZE);
    end-ds;

```

```

dcl-ds KeyDesc0200 likeds(T_key_descriptor0200) inz;

dcl-s DecryptedDataLen int(10);
dcl-s DecryptedData char(MAX_CLOB_SIZE) based(Decrypted_Datap);
dcl-s Decrypted_Datap pointer;

dcl-s EncryptedDataLen int(10);
dcl-s EncryptedData char(MAX_CLOB_SIZE) based(Encrypted_Datap);
dcl-s Encrypted_Datap pointer;

dcl-s RtnLen int(10);
dcl-s KeyManagement char(KEY_MGMT_SIZE) based(KeyMgmtp);
dcl-s KeyMgmtp pointer;

ErrCode = *allx'00';
ErrCode.QUSBPRV = %size(QUSEC); // Bytes_provided

if FuncCode = 8; // create or alter time
    FieldCreatedOrAltered (%addr(OptionalParms)
        : DecodedDataType
        : EncodedDataType
        : SqlState
        : Msgtext);

    return;
endif;

// Initialize the Algorithm Description Format
ALGD0200 = *allx'00';
ALGD0200.QC3BCA = Qc3_AES; // set block cipher algorithm
ALGD0200.QC3BL = 16; // set block length
ALGD0200.QC3MODE = Qc3_ECB; // set mode
ALGD0200.QC3PO = Qc3_Pad_Char; // set pad option

// Initialize the Key Description Format
KeyDesc0200 = *allx'00';
KeyDesc0200.desc.QC3KT = Qc3_AES; // set key type
KeyDesc0200.desc.QC3KSL = 16; // set key string length
KeyDesc0200.desc.QC3KF = Qc3_Bin_String; // set key format

if FuncCode = 0; // encode

    // Get the actual length of the data depending on the type
    select;
    when DecodedDataType.SQFST = SQL_TYP_VARCHAR
    or DecodedDataType.SQFST = SQL_TYP_NVARCHAR;
        DecryptedDataLen = DecodedData.varchar.len;
        Decrypted_Datap = %addr(DecodedData.varchar.data);
    when DecodedDataType.SQFST = SQL_TYP_CLOB
    or DecodedDataType.SQFST = SQL_TYP_NCLOB;
        DecryptedDataLen = DecodedData.Clob.len;
        Decrypted_Datap = %addr(DecodedData.Clob.data);
    other; // must be fixed length
        // for fixed length, only the data is passed, get the
        // length of the data from the data type parameter
        DecryptedDataLen = DecodedDataType.SQFBL; // byte length
        Decrypted_Datap = %addr(DecodedData);
    endsl;

    // Determine if the encoded data type is varchar or CLOB based on
    // the optional parameter information that was saved at create time.
    if OptionalParms.type_indicator = '0'; // encoded data is varchar
        Encrypted_Datap = %addr(EncodedData.Varchar.data);
        KeyMgmtp = %addr(EncodedData.Varchar.keyManagementData);
    else; // encoded data is CLOB
        Encrypted_Datap = %addr(EncodedData.Clob.data);
        KeyMgmtp = %addr(EncodedData.Clob.keyManagementData);
    endif;

    if DecryptedDataLen > 0; // have some data to encrypt.
        // get the encrypt key
        getKeyMgmt('E' : KeyManagement : KeyDesc0200.key);
        // Set the number of bytes available for encrypting. Subtracting
        // off the bytes used for "key management".
        EncryptedDataLen = EncodedDataType.SQFBL - KEY_MGMT_SIZE;
        // Encrypt the data
        Qc3EncryptData(Decrypted_Datap
            : DecryptedDataLen
            : Qc3_Data
            : ALGD0200
            : Qc3_Alg_Block_Cipher
            : KeyDesc0200
            : Qc3_Key_Parms

```

```

        : Qc3_Any_CSP
        : ' '
        : Encrypted_Datap
        : EncryptedDataLen
        : RtnLen
        : ErrCode);
    RtnLen += KEY_MGMT_SIZE; // add in the Key Area size
else; // length is 0
    RtnLen = 0;
endif;
// store the length (number of bytes that database needs to write)
// in either the 2 or 4 byte length field based on the encrypted
// data type
if OptionalParms.type_indicator = '0';
    EncodedData.Varchar.len = RtnLen;
else;
    EncodedData.Clob.len = RtnLen;
endif;
elseif FuncCode = 4; // decode
    // Determine if the encoded data type is varchar or CLOB based on the
    // optional parameter information that was saved at create time. Set
    // pointers to the key management data, the user encrypted data, and
    // the length of the data.
    if OptionalParms.type_indicator = '0'; // varchar
        KeyMgmtp = %addr(EncodedData.Varchar.keyManagementData);
        Encrypted_Datap = %addr(EncodedData.Varchar.data);
        EncryptedDataLen = EncodedData.Varchar.len;
    else; // CLOB
        KeyMgmtp = %addr(EncodedData.Clob.keyManagementData);
        Encrypted_Datap = %addr(EncodedData.Clob.data);
        EncryptedDataLen = EncodedData.Clob.len;
    endif;
    // Set the number of bytes to decrypt. Subtract
    // off the bytes used for "key management".
    EncryptedDataLen -= KEY_MGMT_SIZE;
    if EncryptedDataLen > 0; // have data to decrypt
        // Set the pointer to where the decrypted data should
        // be placed.
        select;
        when DecodedDataType.SQLFST = SQL_TYP_VARCHAR
        or   DecodedDataType.SQLFST = SQL_TYP_NVARCHAR;
            Decrypted_Datap = %addr(DecodedData.varchar.data);
        when DecodedDataType.SQLFST = SQL_TYP_CLOB
        or   DecodedDataType.SQLFST = SQL_TYP_NCLOB;
            decryptedDataLen = DecodedData.Clob.len;
            decrypted_Datap = %addr(DecodedData.Clob.data);
        other; // must be fixed length
            decrypted_Datap = %addr(DecodedData);
        ends1;

        // get the decrypt key
        getKeyMgmt('D' : KeyManagement : KeyDesc0200.key);
        // get the maximum number of bytes available for the
        // decode space
        DecryptedDataLen = DecodedDataType.SQLFBL;
        // decrypt the data
        Qc3DecryptData(Encrypted_Datap
            : EncryptedDataLen
            : ALGD0200
            : Qc3_Alg_Block_Cipher
            : KeyDesc0200
            : Qc3_Key_Parms
            : Qc3_Any_CSP
            : ' '
            : Decrypted_Datap
            : DecryptedDataLen
            : RtnLen
            : ErrCode);
    else; // 0 length data
        RtnLen = 0;
    endif;
    // tell the database manager how many characters of data are being returned
    select;
    when DecodedDataType.SQLFST = SQL_TYP_VARCHAR
    or   DecodedDataType.SQLFST = SQL_TYP_NVARCHAR;
        DecodedData.varchar.len = RtnLen;
    when DecodedDataType.SQLFST = SQL_TYP_CLOB
    or   DecodedDataType.SQLFST = SQL_TYP_NCLOB;
        DecodedData.clob.len = RtnLen;
    other;
        // must be fixed length and the full number of characters must be
        // returned

```

```

        ends1;
    else; // unsupported option -- error
        SqlState = '38003';
    endif;

    if ErrCode.QUSB AVL > 0; // Something failed on encrypt/decrypt
        // set an error and return the exception id
        SqlState = '38004';
        msgtext = ErrCode.QUSEI; // Exception_Id
    endif;

end-proc SampleFieldProcProgram;

// procedure FieldCreatedOrAltered
dcl-proc FieldCreatedOrAltered;
    dcl-pi *n extproc(*dclcase);
        OptionalParms_p pointer value;
        DecodedDataType likeds(SQLFPD); // sqlfpParameterDescription_T
        EncodedDataType likeds(SQLFPD); // sqlfpParameterDescription_T
        SqlState char(5);
        Msgtext varchar(1000);
    end-pi;

    // Note that while optional parameters are not supported on input into
    // this fieldproc, it will set information into the structure for
    // usage by encode/decode operations. The length of this
    // structure must be at least 8 bytes long, so the length is not
    // reset.

    // The optional parameter as it is passed in to this program
    dcl-ds inputOptionalParms likeds(SQLFFPPL) // sqlfpFieldProcedureParameterList_T
        based(OptionalParms_p);

    // The optional parameter as it is modified by this program
    // to later be passed for Encrypt and Decrypt
    dcl-ds outputOptionalParms likeds(T_optional)
        based(OptionalParms_p);

    dcl-c errortext1 'Unsupported type in fieldproc.';

    if inputOptionalParms.SQLFNOOP <> 0; // sqlfpNumberOfOptionalParms
        // this fieldproc does not handle optional parameters
        SqlState = '38001';
        return;
    endif;

    select;
    when DecodedDataType.SQLFST = SQL_TYP_CHAR // Fixed char
    or DecodedDataType.SQLFST = SQL_TYP_NCHAR;
        // set the encode data type to VarChar
        EncodedDataType.SQLFST = SQL_TYP_VARCHAR;
        // This example shows how the fieldproc pgm can modify the optional parm data area
to
        // store "constant" information to be used by the fieldproc on encode and decode
operations.
        // Indicate that the encode type is varchar.
        outputOptionalParms.type_indicator = '0';
    when DecodedDataType.SQLFST = SQL_TYP_VARCHAR // Varying char
    or DecodedDataType.SQLFST = SQL_TYP_NVARCHAR;
        // set the data type to BLOB */
        EncodedDataType.SQLFST = SQL_TYP_VARCHAR;
        // This example shows how the fieldproc pgm can modify the optional parm data area
to
        // store "constant" information to be used by the fieldproc on encode and decode
operations.
        // Indicate that the encode type is varchar.
        outputOptionalParms.type_indicator = '0';
    when DecodedDataType.SQLFST = SQL_TYP_CLOB // CLOB
    or DecodedDataType.SQLFST = SQL_TYP_NCLOB;
        // set the data type to BLOB */
        EncodedDataType.SQLFST = SQL_TYP_BLOB;
        // This example shows how the fieldproc pgm can modify the optional parm data area
to
        // store "constant" information to be used by the fieldproc on encode and decode
operations.
        // Indicate that the encode type is CLOB.
        outputOptionalParms.type_indicator = '1';
    other;
        // this field proc does not handle any other data types
        SqlState = '38002';
        msgtext = errortext1;
        return;
end-proc;

```

```

        ends1;

        // finish setting the rest of encoded data type values

        // the null-ness of the encoded and decoded type must match
        if %bitand(DecodedDataType.SQLFST : x'01') = 1;
            EncodedDataType.SQLFST = %bitor(EncodedDataType.SQLFST : x'01'); // set to null
capable
        endif;

        // Determine the result length by adding one byte for the pad character counter and
        // rounding the length up to a multiple of 15-- the AES encryption algorithm
        // will return the encrypted data in a multiple of 15.
        // This example also shows how additional data can be stored by the fieldproc
        // program in the encrypted data. An additional 16 bytes are added for use by
        // the fieldproc program.
        // Note that this fieldproc does not check for exceeding the maximum length for
        // the data type. There may also be other conditions that are not handled by
        // this sample fieldproc program.
        EncodedDataType.SQFL =
            (%div(DecodedDataType.SQFL + 16 : 16) * 16) + KEY_MGMT_SIZE; // characters
        EncodedDataType.SQFBL = EncodedDataType.SQFL; // Byte
        // result is *HEX CCSID
        EncodedDataType.SQFC = 65535;

        if DecodedDataType.SQFST = SQL_TYP_CHAR
        or DecodedDataType.SQFST = SQL_TYP_NCHAR; // fixed length character
            // need to set the allocated length for fixed length since the default value
            // must fit in the allocated portion of varchar. Note that if the varchar or
            // CLOB had a default value of something other than the empty string, the
            // allocated length must be set appropriately but this fieldproc does not
            // handle this situation.
            EncodedDataType.SQFAL = EncodedDataType.SQFL;
        endif;
    end-proc FieldCreatedOrAltered;

    // procedure getKeyMgmt
    dcl-proc getKeyMgmt;

        dcl-pi *n extproc(*dclcase);
            type char(1) const;
            keyMgmt char(KEY_MGMT_SIZE);
            keyData char(KEY_MGMT_SIZE);
        end-pi;

        // This is a trivial key management idea and is used to demonstrate how additional
        // information may be stored in the encoded data which is written to the table and
        // be used to communicate between the encode and decode operations.
        if type = 'E'; // encoding, set the current key
            keyMgmt = 'KEYTYPE2';
            keyData = '0123456789ABCDEG'; // end in G
        elseif keyMgmt = 'KEYTYPE1'; // decoding, determine which key to use
            keyData = '0123456789ABCDEG'; // end in F
        elseif keyMgmt = 'KEYTYPE2';
            keyData = '0123456789ABCDEG'; // end in G
        endif;

    end-proc getKeyMgmt;

```

Example field procedure written in C

For better performance for a field procedure written in C, ACTGRP(*CALLER), TERASPACE(*YES) and STGMDDL(*INHERIT) are recommended when you compile your program.

```

#include <string.h>
#include <stdlib.h>
#include <stdio.h>
#include <QC3CCI.H>
#include <QUSEC.H>
#include <QC3DTAEN.H>
#include <QC3DTADE.H>
#include <SQL.h>
#include <SQLFP.h>

#define KEY_MGMT_SIZE 16
typedef _Packed struct
{
    unsigned short int len;

```

```

    char data[];
}T_VARCHAR;

typedef _Packed struct
{
    unsigned long len;
    char data[];
}T_CLOB;

typedef _Packed struct
{
    unsigned short int len;
    char keyManagementData[KEY_MGMT_SIZE];
    char data[];
}T_ENCODED_VARCHAR;

typedef _Packed struct
{
    unsigned long len;
    char keyManagementData[KEY_MGMT_SIZE];
    char data[];
}T_ENCODED_CLOB;

typedef _Packed struct
{
    unsigned long bytes;
    char type_indicator;
    char not_used[3];
}T_optional;

typedef struct KeyDescriptor0200
{
    Qc3_Format_KEYD0200_T desc;
    char key[KEY_MGMT_SIZE];
} T_key_descriptor0200;

static void fieldCreatedOrAltered(void *argv[]);
static void KeyMgmt(char type, char *keyMgmt, char *keyData);

main(int argc, void *argv[])
{
    short *funccode = argv[1];
    T_optional *optionalParms = argv[2];
    char *sqlstate = argv[7];
    sqlfpMessageText_T *msgtext = argv[8];
    sqlfpOptionalParameterValueDescriptor_T *optionalParmPtr;
    T_VARCHAR *VarCharStrp;
    T_CLOB *ClobStrp;
    T_ENCODED_VARCHAR *VarCharEncodedStrp;
    T_ENCODED_CLOB *ClobEncodedStrp;
    char *Encrypted_Datap;
    char *Decrypted_Datap;
    int EncryptedDataLen;
    int DecryptedDataLen;
    int RtnLen;
    char *keyMgmt;
    char Qc3_Any_CSP_Flag = Qc3_Any_CSP;
    Qc3_Format_ALGD0200_T *ALGD0200;
    T_key_descriptor0200 *KeyDesc0200;
    Qus_EC_t ERRCODE;

    memset(&ERRCODE, '\x00', sizeof(Qus_EC_t));
    ERRCODE.Bytes_Provided = sizeof(Qus_EC_t);

    if (*funccode == 8) // create time
    {
        fieldCreatedOrAltered(argv);
        return;
    }

    // allocate space and initialize space for Algorithm Description Format
    ALGD0200 = (Qc3_Format_ALGD0200_T *)malloc(sizeof(Qc3_Format_ALGD0200_T));
    memset(ALGD0200, '\x00', sizeof(Qc3_Format_ALGD0200_T));
    ALGD0200->Block_Cipher_Al = Qc3_AES;
    ALGD0200->Block_Length = 16;
    ALGD0200->Mode = Qc3_ECB;
    ALGD0200->Pad_Option = Qc3_Pad_Char;

    // allocate space and initialize space for Key Description Format
    KeyDesc0200 =
        (T_key_descriptor0200 *)malloc(sizeof(T_key_descriptor0200));
    memset(KeyDesc0200, '\x00', sizeof(T_key_descriptor0200));

```

```

KeyDesc0200->desc.Key_Type = Qc3_AES ;
KeyDesc0200->desc.Key_String_Len = 16;
KeyDesc0200->desc.Key_Format = Qc3_Bin_String;

sqlfpParameterDescription_T *decodedDataType = argv[3];
sqlfpParameterDescription_T *encodedDataType = argv[5];

if (*funccode == 0) // encode
{
    // Address the data and get the actual length of the data.
    switch(decodedDataType->sqlfpSqlType)
    {
        case SQL_TYP_VARCHAR:
        case SQL_TYP_NVARCHAR:
        {
            // varchar data is passed with a 2 byte length followed
            // by the data
            VarCharStrp = argv[4];
            DecryptedDataLen = VarCharStrp->len;
            Decrypted_Datap = VarCharStrp->data;
            break;
        }
        case SQL_TYP_CLOB:
        case SQL_TYP_NCLOB:
        {
            // CLOB data is passed with a 4 byte length followed
            // by the data
            ClobStrp = argv[4];
            DecryptedDataLen = ClobStrp->len;
            Decrypted_Datap = ClobStrp->data;
            break;
        }
        default:// must be fixed Length
        {
            // for fixed length, only the data is passed, get the
            // length of the data from the data type parameter
            DecryptedDataLen = decodedDataType->sqlfpByteLength;
            Decrypted_Datap = argv[4];
            break;
        }
    }
    // Determine if the encoded data type is varchar or CLOB based on
    // the optional parameter information that was saved at create time.
    if (optionalParms->type_indicator == '0') // encoded data is varchar
    {
        VarCharEncodedStrp = argv[6];
        Encrypted_Datap = VarCharEncodedStrp->data;
        keyMgmtp = VarCharEncodedStrp->keyManagementData;
    }
    else // encoded data is CLOB
    {
        ClobEncodedStrp = argv[6];
        Encrypted_Datap = ClobEncodedStrp->data;
        keyMgmtp = ClobEncodedStrp->keyManagementData;
    }
    if (DecryptedDataLen >0) // have some data to encrypt.
    {
        // get the encrypt key
        KeyMgmt('E', keyMgmtp, KeyDesc0200->key);
        // Set the number of bytes available for encrypting. Subtracting
        // off the bytes used for "key management".
        EncryptedDataLen = encodedDataType->sqlfpByteLength - KEY_MGMT_SIZE;
        // Encrypt the data
        Qc3EncryptData(Decrypted_Datap,
            &DecryptedDataLen,
            Qc3_Data,
            (char *)ALGD0200,
            Qc3_Alg_Block_Cipher,
            (char *)KeyDesc0200,
            Qc3_Key_Parms,
            &Qc3_Any_CSP_Flag,
            "",
            Encrypted_Datap,
            &EncryptedDataLen,
            &RtnLen,
            &ERRCODE);
        RtnLen += KEY_MGMT_SIZE; // add in the Key Area size
    }
    else // length is 0
        RtnLen = 0;
    // store the length (number of bytes that database needs to write)
    // in either the 2 or 4 byte length field based on the encrypted

```



```

// data type
if (optionalParms->type_indicator == '0')
    VarCharEncodedStrp->len = RtnLen;
else
    ClobEncodedStrp->len = RtnLen;
}
else if (*funccode == 4) // decode
{
    // Determine if the encoded data type is varchar or CLOB based on the
    // optional parameter information that was saved at create time. Set
    // pointers to the key management data, the user encrypted data, and
    // the length of the data.
    if (optionalParms->type_indicator == '0') // varchar
    {
        VarCharEncodedStrp = argv[6];
        keyMgmtp = VarCharEncodedStrp->keyManagementData;
        Encrypted_Datap = VarCharEncodedStrp->data;
        EncryptedDataLen = VarCharEncodedStrp->len;
    }
    else // CLOB
    {
        ClobEncodedStrp = argv[6];
        keyMgmtp = ClobEncodedStrp->keyManagementData;
        Encrypted_Datap = ClobEncodedStrp->data;
        EncryptedDataLen = ClobEncodedStrp->len;
    }
    // Set the number of bytes to decrypt. Subtract
    // off the bytes used for "key management".
    EncryptedDataLen -= KEY_MGMT_SIZE;
    if (EncryptedDataLen > 0) // have data to decrypt
    {
        // Set the pointer to where the decrypted data should
        // be placed.
        switch (decodedDataType->sqlfpSqlType)
        {
            case SQL_TYP_VARCHAR:
            case SQL_TYP_NVARCHAR:
            {
                VarCharStrp = argv[4];
                Decrypted_Datap = VarCharStrp->data;
                break;
            }
            case SQL_TYP_CLOB:
            case SQL_TYP_NCLOB:
            {
                ClobStrp = argv[4];
                Decrypted_Datap = ClobStrp->data;
                break;
            }
            default: // must be fixed length
            {
                Decrypted_Datap = argv[4];
                break;
            }
        }
        // get the decrypt key
        KeyMgmt('D', keyMgmtp, KeyDesc0200->key);
        // get the maximum number of bytes available for the
        // decode space
        DecryptedDataLen = decodedDataType->sqlfpByteLength;
        // decrypt the data
        Qc3DecryptData(Encrypted_Datap,
            &EncryptedDataLen,
            (char *)ALGD0200,
            Qc3_Alg_Block_Cipher,
            (char *)KeyDesc0200,
            Qc3_Key_Parms,
            &Qc3_Any_CSP_Flag,
            "",
            Decrypted_Datap,
            &DecryptedDataLen,
            &RtnLen,
            &ERRCODE);
    }
    else // 0 length data
        RtnLen = 0;

    // tell the database manager how many characters of data are being returned
    switch (decodedDataType->sqlfpSqlType)
    {
        case SQL_TYP_VARCHAR:
        case SQL_TYP_NVARCHAR:

```

```

        VarCharStrp->len = RtnLen;
        break;
    case SQL_TYP_CLOB:
    case SQL_TYP_NCLOB:
        ClobStrp->len = RtnLen;
        break;
    default:
        // must be fixed length and the full number of characters must be
        // returned
        break;
    }
}
else // unsupported option -- error
    memcpy(sqlstate, "38003",5);

if (ERRCODE.Bytes_Available > 0) // Something failed on encrypt/decrypt
{
    // set an error and return the exception id
    memcpy(sqlstate, "38004",5);
    msgtext->sqlfpMessageTextLength = 7;
    memcpy(msgtext->sqlfpMessageTextData, ERRCODE.Exception_Id, 7);
}
// free allocated storage
free(KeyDesc0200);
free(ALGD0200);
}

static void fieldCreatedOrAltered(void *argv[])
{
    char *sqlstate = argv[7];
    sqlfpMessageText_T *msgtext = argv[8];
    char *errortext1="Unsupported type in fieldproc.";

    // Note that while optional parameters are not supported on input into
    // this fieldproc, it will set information into the structure for
    // usage by encode/decode operations. The length of this
    // structure must be at least 8 bytes long, so the length is not
    // reset.
    sqlfpFieldProcedureParameterList_T *inputOptionalParms = argv[2];
    T_optional *outputOptionalParms = argv[2];

    sqlfpParameterDescription_T *decodedDataType = argv[3];
    sqlfpParameterDescription_T *encodedDataType = argv[5];

    if (inputOptionalParms->sqlfpNumberOfOptionalParms != 0)
    {
        // this fieldproc does not handle input optional parameters
        memcpy(sqlstate,"38001",5);
        return;
    }

    switch(decodedDataType->sqlfpSqlType)
    {
    case SQL_TYP_CHAR: /* Fixed char */
    case SQL_TYP_NCHAR:
        // set the encode data type to VarChar
        encodedDataType->sqlfpSqlType = SQL_TYP_VARCHAR;
        // This example shows how the fieldproc pgm can modify the optional parm data area to
        // store "constant" information to be used by the fieldproc on encode and decode
        operations.
        // Indicate that the encode type is varchar.
        outputOptionalParms->type_indicator = '0';
        break;
    case SQL_TYP_VARCHAR:
    case SQL_TYP_NVARCHAR:
        /* set the data type to BLOB */
        encodedDataType->sqlfpSqlType = SQL_TYP_VARCHAR;
        // This example shows how the fieldproc pgm can modify the optional parm data area to
        // store "constant" information to be used by the fieldproc on encode and decode
        operations.
        // Indicate that the encode type is varchar.
        outputOptionalParms->type_indicator = '0';
        break;

    case SQL_TYP_CLOB:
    case SQL_TYP_NCLOB:
        /* set the data type to BLOB */
        encodedDataType->sqlfpSqlType = SQL_TYP_BLOB;
        // This example shows how the fieldproc pgm can modify the optional parm data area to
        // store "constant" information to be used by the fieldproc on encode and decode
        operations.

```

```

        // Indicate that the encode type is BLOB.
        outputOptionalParms->type_indicator = '1';
        break;
    default:
        /* this field proc does not handle any other data types */
        memcpy(sqlstate,"38002",5);
        memcpy(msgtext->sqlfpMessageTextData,
            errortext1, sizeof(errortext1));
        msgtext->sqlfpMessageTextLength=sizeof(errortext1);
        return;
    }

    // finish setting the rest of encoded data type values

    // the null-ness of the encoded and decoded type must match
    if (decodedDataType->sqlfpSqlType % 2 == 1)
        ++encodedDataType->sqlfpSqlType; // set to null capable

    // Determine the result length by adding one byte for the pad character counter and
    // rounding the length up to a multiple of 15-- the AES encryption algorithm
    // will return the encrypted data in a multiple of 15.
    // This example also shows how additional data can be stored by the fieldproc
    // program in the encrypted data. An additional 16 bytes are added for use by
    // the fieldproc program.
    // Note that this fieldproc does not check for exceeding the maximum length for
    // the data type. There may also be other conditions that are not handled by
    // this sample fieldproc program.
    encodedDataType->sqlfpLength =
        (((decodedDataType->sqlfpLength + 16) /16) * 16) + KEY_MGMT_SIZE;
    encodedDataType->sqlfpByteLength = encodedDataType->sqlfpLength;
    // result is *HEX CCSID
    encodedDataType->sqlfpCcsid = 65535;

    if (decodedDataType->sqlfpSqlType == SQL_TYP_CHAR ||
        decodedDataType->sqlfpSqlType == SQL_TYP_NCHAR) // fixed length character
    {
        // need to set the allocated length for fixed length since the default value
        // must fit in the allocated portion of varchar. Note that if the varchar or
        // CLOB had a default value of something other than the empty string, the
        // allocated length must be set appropriately but this fieldproc does not
        // handle this situation.
        encodedDataType->sqlfpAllocatedLength = encodedDataType->sqlfpLength;
    }
}

// This is a trivial key management idea and is used to demonstrate how additional
// information may be stored in the encoded data which is written to the table and
// be used to communicate between the encode and decode operations.
static void KeyMgmt(char type, char *keyMgmt, char *keyData)
{
    if (type == 'E') // encoding, set the current key
    {
        memcpy((char *)keyMgmt, "KEYTYPE2", KEY_MGMT_SIZE);
        memcpy(keyData, "0123456789ABCDEF", 16);
    }
    else // decoding, determine which key to use
    if (memcmp(keyMgmt, "KEYTYPE1", KEY_MGMT_SIZE) == 0)
        memcpy(keyData, "0123456789ABCDEF", 16);
    else
    if (memcmp(keyMgmt, "KEYTYPE2", KEY_MGMT_SIZE) == 0)
        memcpy(keyData, "0123456789ABCDEF", 16);
}
}

```

General guidelines for writing field procedures

The following considerations must be considered when writing field procedures:

- Must be an ILE *PGM object. *SRVPGMs, OPM *PGMs, and JAVA objects are not supported.
- Authority to the field procedure *PGM object is checked when the field procedure is added to the table. Authority checking is not done when the field procedure is invoked.
 - Create the field procedure program so that it runs under the user profile of the user who created it. In this way, users who do not have the same level of authority to the program will not encounter errors.
 - Create the program with USRPRF(*OWNER) and *EXCLUDE public authority. Do not grant authorities to the field procedure program to USER(*PUBLIC). Avoid having the field procedure program altered or replaced by other users.

- No SQL is allowed in a field procedure.
- The field procedure will not be called if the data to be encoded or decoded is the null value.
- On an encode operation, packed decimal and zoned decimal values will be converted to the preferred sign prior to calling the user field procedure program.
- The field procedure must be deterministic. For SQE, caching of results will occur based on the QAQQINI FIELDPROC_ENCODED_COMPARISON.
- The field procedure must be parallel capable and capable of running in a multi-threaded environment. For RPG, this means the THREAD control specification keyword must be specified. For COBOL, this means the THREAD(SERIALIZE) process option must be specified.
- Must be capable of running in both a fenced and non-fenced environment.
- The program cannot be created with ACTGRP(*NEW). If the program is created with ACTGRP(*CALLER), the program will run in the default activation group.
- Field procedure programs are expected to be short running. It is recommended that the field procedure program avoid commitment control and native database operations.
- Create the program in the physical file's library.
- If an error occurs or is detected in the field procedure program, the field procedure program should set the SQLSTATE and message text parameters. If the SQLSTATE parameter is not set to indicate an error, database assumes that the field procedure ran successfully. This might cause the user data to end up in an inconsistent state.

Warning: Field procedures are a productive way both to provide application functions and to manage information. However, field procedure programs could provide the ability for someone with devious intentions to create a "Trojan horse"¹ on your system. This is why it is important to restrict who has the authority to alter a table. If you are managing object authority carefully, the typical user will not have sufficient authority to add a field procedure program.

Index considerations

Indexes may be recovered at IPL time based on the RECOVER parameter of CRTPF, CRTLF, CHGPF, or CHGLF commands. Indexes that are based on a column that has a field procedure have special considerations.

Use of PASE(QSH) and JAVA within field procedures must be avoided if the index keys are built over expressions that contain columns with field procedures or the sparse index criteria references a column with an associated field procedure. If use of PASE or JAVA is required, consider changing indexes to RECOVER(*NO) so that they are not recovered during the IPL process and recovered during an open operation instead.

The following restrictions apply to keys for both SQL indexes and DDS keyed files.

- If the column has a field procedure, the index key must be a column. No expressions (derivations) are allowed. This includes DDS keywords like SST and CONCAT.
- Sort sequence cannot be applied to the column.
- If the field procedure column is part of a foreign key, the corresponding parent key column must use the same field procedure.
- The WHERE clause of the SQL Create Index or the Select/Omit criteria of a DDS logical file cannot reference a column that has a field procedure.

See the SQL Reference for more details on indexes and field procedures.

¹ In history, the Trojan horse was a large hollow wooden horse that was filled with Greek soldiers. After the horse was introduced within the walls of Troy, the soldiers climbed out of the horse and fought the Trojans. In the computer world, a program that hides destructive functions is often called a Trojan horse.

Thread considerations

A field procedure runs in the same job as the operation that initiated the field procedure. However, the field procedure may or may not run in a different system thread (fenced or not fenced) which are separate from the thread from the initiating request.

Because the field procedure runs in the same job, it shares much of the same environment as the initiating request. However, because it may run under a separate thread, the following threads considerations apply:

- Field procedures do not inherit any program adopted authority that may have been active at the time the request was initiated. Field procedure authority comes from the authority associated with the field procedure program or from the authority of the user running.
- The field procedure cannot perform any operation that is blocked from being run in a secondary thread.
- The field procedure program must be created such that it either runs under a named activation group or in the activation group of its caller (ACTGRP parameter). Programs that specify *CALLER will run in the default activation group.

Debug considerations

There are some things to keep in mind when debugging field procedures.

Since field procedures can run in a secondary thread, it is recommended that debugging should be done using STRSRVJOB or the graphical debugger.

For natively run field procedures, the database manager uses the job default wait time. If the field procedure does not return within that specified time, an error is returned. This default wait time may need to be increased when debugging field procedures. For example, to change the default wait time to 5 minutes: CHGJOB DFTWAIT(300)

Guidelines for writing field procedures that mask data

Field procedures can be used to mask data for certain users or environments when data is decoded. Field procedures that mask data must be coded to handle special situations to ensure data is not corrupted.

The following special situations must be handled by a field procedure that masks data:

- Field-decoding
 - Masking must only be performed for field-decoding. It must not be performed for field-encoding. If masking was performed for field-encoding, the masked data would be stored in the table and the actual value would be lost.
 - In some cases, system code needs to copy data internally (the data is not being returned to the user in these cases). For example, in some cases, RGZPFM, ALTER TABLE, and CRTDUPOBJ must copy data internally. Likewise, data passed internally to triggers must not be masked. During these operations, when the data is read, field-decoding will occur and when the data is written, field-encoding will occur. If masking is performed in these cases during field-decoding, the mask data will then be written and the actual data will be lost.

To prevent corruption, the ninth parameter to the field procedure indicates whether this is a system operation where masking must not be performed. It is critical that the field procedure be written to check this parameter during field-decoding and if the parameter indicates that masking must not be performed, the field procedure must not mask regardless of the user or environment.

- Field-encoding
 - For native update and insert operations, the field procedure must be able to identify when masked data is being passed to the field procedure and take special actions. For example, a field procedure might be written to mask a credit card number column. That same user may be authorized to read and update the table through an RPG application that performs READ and UPDATE operations. When the READ is performed, the credit card number is masked to prevent the user from seeing it, but when the user performs the UPDATE, the masked data will be passed back to database on the UPDATE operation and the field procedure will be called to encode the data. If the field procedure does not recognize that the value being passed is masked, the masked data would be encoded and

stored in the table and the original value in the row would be corrupted with an encoded masked data.

To prevent corruption, the field procedure must recognize on field-encoding that the data is masked. Instead of encoding the data, the field procedure must return a warning SQLSTATE value of '09501' in the seventh parameter.

- For an UPDATE operation, '09501' indicates to Db2 that the current value for the column should be used.
- For an INSERT operation, '09501' indicates to Db2 that the default value should be used for the associated column value.

Query Considerations: There are several considerations that apply to queries that reference a column of a table that has a field procedure that masks data:

- Depending on how the optimizer implements a query, the same query may return different rows and values for different users or environments. This will occur in cases where optimizer must decode the data in order to perform comparisons or evaluate expressions in a query. If masking is performed for one user but not for another user, the result of the decode operation will be very different, so the resulting rows and values can also be quite different for the two users.

For example, assume that a field procedure returns (decodes) data for user profile MAIN without masking and returns (decodes) data for user profile QUSER with masking. An application contains the following query:

```
SELECT * FROM orders WHERE cardnum = '112233'
```

By default, the optimizer will try to implement the search condition (logically) as follows:

```
WHERE cardnum = FieldProc ENCODE('112233')
```

This is the best performing implementation since it allows Db2 to compare the encoded version of the constant '112233' with the encoded version of the CARDNUM values that are stored in the orders table. Since the optimizer did not decode the data to perform the comparison, the query will return the same rows for the MAIN and QUSER user profiles. The only difference will be that QUSER will see masked values in the result rows for the CARDNUM column.

The implementation of queries that reference a field procedure column can be controlled by the QAQQINI FIELDPROC_ENCODED_COMPARISON option. The default value for this option is *ALLOW_EQUAL. This option enables the optimizer to implement the comparison using the encoded values.

In the previous example, if the FIELDPROC_ENCODED_COMPARISON option was changed to *NONE, the query would return different rows for the two users. When the value is *NONE, an equal comparison will be implemented internally by Db2 as follows:

```
WHERE FieldProc DECODE(cardnum)='112233'
```

In this case, Db2 has to decode the CARDNUM values for every row in the table to compare against the original constant '112233'. This means that the comparison for the MAIN user profile will compare the decoded and unmasked card number values (112233, 332211, etc) to '112233'. The MAIN user profile will find the orders associated with the specified card number (112233). However, the query will not return any rows for the QUSER user profile. That is because the comparison for QUSER will be comparing the masked value of the card numbers (****33, ****11, etc) with the constant '112233'.

For more information on how the QAQQINI FIELDPROC_ENCODED_COMPARISON option affects field procedures see the Database Performance and Query Optimization topic in the Information Center.

- REFRESH of a materialized query table is affected by the QAQQINI FIELDPROC_ENCODED_COMPARISON option. If the materialized query table references a column with a field procedure that masks, it is imperative that the REFRESH of the MQT be issued by a user that is allowed to see unmasked data. Otherwise, the results in the MQT will be incorrect for all users.

- CREATE TABLE LIKE, CREATE TABLE AS, DECLARE GLOBAL TEMPORARY TABLE LIKE, or DECLARE GLOBAL TEMPORARY TABLE AS are affected by the QAQQINI FIELDPROC_ENCODED_COMPARISON option. If the statements are issued by a user that is not allowed to see unmasked data, the resulting table will contain masked data.
- OPNQRYF and Query/400® are not affected by the QAQQINI FIELDPROC_ENCODED_COMPARISON option. The optimizer always processes by decoding values (similar to a FIELDPROC_ENCODED_COMPARISON option of *NONE).
- Select/omit DDS-created logical files are also not affected by the QAQQINI FIELDPROC_ENCODED_COMPARISON option. The logical file is processed by decoding values (similar to a FIELDPROC_ENCODED_COMPARISON option of *NONE).

Best Practices: There are two QAQQINI options that are strongly recommended for use if you have field procedures that mask data:

FIELDPROC_ENCODED_COMPARISON

The default option for FIELDPROC_ENCODED_COMPARISON is *ALLOW_EQUAL which works very well for field procedures that do not mask data. If field procedures are used that do mask data, however, *NONE is the most secure and recommended option.

CACHE_RESULTS

The default option for CACHE_RESULTS is *SYSTEM. In many cases, this option works well. However, if field procedures that mask data are used, you should specify *JOB for CACHE_RESULTS.

Since these two options can affect the behavior of field procedures that mask data, it is also important to ensure that only authorized users be allowed to specify new or different QAQQINI options:

- CHGQRYA command

Verify that only authorized users can execute the CHGQRYA command. By default only users with job control (*JOBCTL) special authority or have the QIBM_DB_SQLADM function usage are authorized to the CHGQRYA command.

- QUSRSYS/QAQQINI file

Verify that only authorized users can create the QUSRSYS/QAQQINI file or update it if it already exists. By default *PUBLIC has *USE authority to QUSRSYS which is not be enough authority to create a new QUSRSYS.QAQQINI file.

Example field procedure program that masks data

Add field procedure FP1 to column C1. The field procedure FP1 expects an additional parameter which it uses to indicate a version level for the field procedure.

```
ALTER TABLE TESTTAB ALTER C1 SET FIELDPROC FP1(1)

#include "string.h"
#include <QSYSINC/H/SQLFP>
void reverse(char *in, char *out, long length);
main(int argc, void *argv[])
{
    short *funcrcode = argv[1];
    sqlfpFieldProcedureParameterList_T *optionalParms = argv[2];
    char *sqlstate = argv[7];
    sqlfpMessageText_T *msgtext = argv[8];
    int version;
    sqlfpOptionalParameterValueDescriptor_T *optionalParmPtr;
    sqlfpInformation_T *info = argv[9];
    int masked;
    if (optionalParms->sqlfpNumberOfOptionalParms != 1)
    {
        memcpy(sqlstate, "38001", 5);
        return;
    }
    optionalParmPtr = (void *)&(optionalParms->sqlfpParmList);
    version = *((int *)&optionalParmPtr->sqlfpParmData);
    /******
    /* CREATE CALL
    /******
    if (*funcrcode == 8) /* create time */
```

```

{
sqlfpParameterDescription_T *inDataType = argv[3];
sqlfpParameterDescription_T *outDataType = argv[5];
if (inDataType->sqlfpSqlType !=452 &&
    inDataType->sqlfpSqlType !=453 ) /* only support fixed length char */
{
    memcpy(sqlstate,"38002",5);
    return;
}
/* an example of how an optional parm could be used */
/* In this case it is used to add version support if it is */
/* expected that the fieldproc program may support multiple */
/* versions */
if (version != 1) /* only support version 1 at this time */
{
    memcpy(sqlstate,"38003",5);
    return;
}

/* do something here to determine the result data type */
/* ..... */
/* in this example input and output types are exactly the same */
/* so just copy */
memcpy(outDataType, inDataType, sizeof(sqlfpParameterDescription_T));
}
/*****
/* ENCODE (WRITE) CALL */
/*****
else if (*funccode == 0) /* encode */
{
sqlfpParameterDescription_T *decodedDataType = argv[3];
char *decodedData = argv[4];
char *encodedData = argv[6];
/* Detect that the value passed on encode is masked. */
/* Return 09501 to tell DB that: */
/* - The field should not be updated for an update operation */
/* - The default value should be used for an insert operation*/
if ( memcmp(decodedData, "XXXXXXXXXX", 12) == 0 )
{
    memcpy(sqlstate,"09501",5);
}
else
{
    reverse(decodedData, encodedData, decodedDataType->sqlfpByteLength);
}
}
/*****
/* DECODE (READ) CALL */
/*****
else if (*funccode == 4) /* decode */
{
char *decodedData = argv[4];
sqlfpParameterDescription_T *encodedDataType = argv[5];
char *encodedData = argv[6];
/* The 9th paramter indicates that the column must not be */
/* masked. For example, during ALTER TABLE or RGZPFM. */
if ( info->sqlfpNoMask == '1' )
{
    reverse(encodedData, decodedData, encodedDataType->sqlfpByteLength);
    return;
}
else
{
    reverse(encodedData, decodedData, encodedDataType->sqlfpByteLength);
    /* Mask the data when appropriate */
    /* Assume mask is set to 0 when it should not be masked */
    /* and 1 when it should be masked */
    if (masked == 1)
    {
        memcpy(decodedData, "XXXXXXXXXX",
            encodedDataType->sqlfpByteLength);
    }
}
}
return;
}
/*****
/* ERROR- UNSUPPORTED OPTION */
/*****
else /* unsupported option -- error */
memcpy(sqlstate, "38003",5);
}
/*****

```



```

/* REVERSE                                                                    */
/*****/
void reverse(char *in, char *out, long length)
{
    int i;
    for (i=0;i<length; ++i) {
        out[length - (i+1)] = in[i];
    }
}

```

Creating descriptive labels using the LABEL ON statement

Sometimes a text description is useful for an object (such as a table or an index) or useful as column text or column headings. You can create a more descriptive label for these names by using the LABEL ON statement.

These labels can be seen in the SQL catalog in the LABEL column.

The LABEL ON statement looks like this:

```

LABEL ON
TABLE CORPDATA.DEPARTMENT IS 'Department Structure Table'

LABEL ON
COLUMN CORPDATA.DEPARTMENT.ADMRDEPT IS 'Reports to Dept.'

```

After these statements are run, the table named DEPARTMENT displays the text description as *Department Structure Table* and the column named ADMRDEPT displays the heading *Reports to Dept.* The label for an object or a column cannot be more than 50 bytes and the label for a column heading cannot be more than 60 bytes (blanks included). Here are the examples of LABEL ON statements for column headings:

This LABEL ON statement provides column heading 1 and column heading 2:

```

*...+...1...+...2...+...3...+...4...+...5...+...6...*
LABEL ON COLUMN CORPDATA.EMPLOYEE.EMPNO IS
    'Employee          Number'

```

This LABEL ON statement provides three levels of column headings for the SALARY column:

```

*...+...1...+...2...+...3...+...4...+...5...+...6...*
LABEL ON COLUMN CORPDATA.EMPLOYEE.SALARY IS
    'Yearly          Salary          (in dollars)'

```

This LABEL ON statement removes the column heading for SALARY:

```

*...+...1...+...2...+...3...+...4...+...5...+...6...*
LABEL ON COLUMN CORPDATA.EMPLOYEE.SALARY IS ''

```

This LABEL ON statement provides a DBCS column heading with two levels specified:

```

*...+...1...+...2...+...3...+...4...+...5...+...6...*
LABEL ON COLUMN CORPDATA.EMPLOYEE.SALARY IS
    '<AABCCDD>          <EEFFGG>'

```

This LABEL ON statement provides the column text for the EDLEVEL column:

```

*...+...1...+...2...+...3...+...4...+...5...+...6...*
LABEL ON COLUMN CORPDATA.EMPLOYEE.EDLEVEL TEXT IS
    'Number of years of formal education'

```

Related reference

[LABEL](#)

Describing an SQL object using COMMENT ON

After you create an SQL object, such as a table or view, you can provide object information for future reference using the COMMENT ON statement.

The information can be the purpose of the object, who uses it, and anything unusual or special about it. You can also include similar information about each column of a table or view. A comment is especially useful if your names do not clearly indicate the contents of the columns or objects. In that case, use a comment to describe the specific contents of the column or objects. Usually, your comment must not be more than 2000 characters. If the object already contains a comment, the old comment is replaced by the new one.

An example of using COMMENT ON follows:

```
COMMENT ON TABLE CORPDATA.EMPLOYEE IS
'Employee table. Each row in this table represents
one employee of the company.'
```

Getting comments after running a COMMENT ON statement

After you run a COMMENT ON statement for a table, your comments are stored in the *LONG_COMMENT* column of SYSTABLES. Comments for the other objects are stored in the LONG_COMMENT column of the appropriate catalog table. The following example gets the comments that are added by the COMMENT ON statement in the previous example:

```
SELECT LONG_COMMENT
FROM CORPDATA.SYSTABLES
WHERE NAME = 'EMPLOYEE'
```

Related reference

[COMMENT](#)

Changing a table definition

You can change the definition of a table by adding a new column, changing an existing column definition such as its length or default value, dropping an existing column, adding or removing constraints, changing partitioning for the table, or altering one of many other options.

To change a table definition, you can use the ALTER TABLE statement. You can add, change, or drop columns and add or remove constraints all with one ALTER TABLE statement. You can also include other options to define or change partitioning, add a materialized query table definition, or change your media preference for the table to use solid state disk storage media.

A second option for changing a table definition is to use the CREATE OR REPLACE TABLE statement. With CREATE OR REPLACE TABLE, all the changes to the table definition are made with the standard CREATE TABLE statement. If the table already exists, any changes between the new table definition and the existing table definition are recognized and applied to the existing table. For example, based on the content of the CREATE OR REPLACE TABLE statement, several new columns could be added, the data type of a column could be changed, and a primary key could be defined.

Related reference

[ALTER TABLE](#)

Adding a column

When you add a new column to a table, the column is initialized with its default value for all existing rows. If NOT NULL is specified, a default value must also be specified.

You can add a column to a table using the ADD COLUMN clause of the SQL ALTER TABLE statement.

The altered table may consist of up to 8000 columns. The sum of the byte counts of the columns must not be greater than 32766 or, if a VARCHAR or VARGRAPHIC column is specified, 32740. If a LOB column is specified, the sum of record data byte counts of the columns must not be greater than 15 728 640.

Related reference

[ALTER TABLE](#)

Changing a column

You can change a column definition in a table using the ALTER COLUMN clause of the ALTER TABLE statement.

When you change the data type of an existing column, the old and new attributes must be compatible. You can always change a character, graphic, or binary column from fixed length to varying length or LOB; or from varying length or LOB to fixed length.

When you convert to a data type with a longer length, data is padded with the appropriate pad character. When you convert to a data type with a shorter length, data might be lost because of truncation. An inquiry message prompts you to confirm the request.

If you have a column that does not allow the null value and you want to change it to now allow the null value, use the DROP NOT NULL clause. If you have a column that allows the null value and you want to prevent the use of null values, use the SET NOT NULL clause. If any of the existing values in that column are the null value, the ALTER TABLE will not be performed and an SQLCODE of -190 will result.

Related reference

[Allowable conversions of data types](#)

When you change the data type of an existing column, the old and new attributes must be compatible.

Related information

[ALTER TABLE](#)

Allowable conversions of data types

When you change the data type of an existing column, the old and new attributes must be compatible.

From data type	To data type
Decimal	Numeric
Decimal	Bigint, Integer, Smallint
Decimal	Decfloat
Decimal	Float
Numeric	Decimal
Numeric	Bigint, Integer, Smallint
Numeric	Decfloat
Numeric	Float
Bigint, Integer, Smallint	Decimal
Bigint, Integer, Smallint	Numeric
Bigint, Integer, Smallint	Decfloat
Bigint, Integer, Smallint	Float
Float	Decimal
Float	Numeric
Float	Bigint, Integer, Smallint
Float	Decfloat

Table 8. Allowable conversions (continued)

From data type	To data type
Character	DBCS-open
Character	UCS-2 or UTF-16 graphic
DBCS-open	Character
DBCS-open	UCS-2 or UTF-16 graphic
DBCS-either	Character
DBCS-either	DBCS-open
DBCS-either	UCS-2 or UTF-16 graphic
DBCS-only	DBCS-open
DBCS-only	DBCS graphic
DBCS-only	UCS-2 or UTF-16 graphic
DBCS graphic	UCS-2 or UTF-16 graphic
UCS-2 or UTF-16 graphic	Character
UCS-2 or UTF-16 graphic	DBCS-open
UCS-2 or UTF-16 graphic	DBCS graphic
<i>distinct type</i>	<i>source type</i>
<i>source type</i>	<i>distinct type</i>

When you change an existing column, only the attributes that you specify are changed. All other attributes remain unchanged. For example, you have a table with the following table definition:

```
CREATE TABLE EX1 (COL1 CHAR(10) DEFAULT 'COL1',
                  COL2 VARCHAR(20) ALLOCATE(10) CCSID 937,
                  COL3 VARGRAPHIC(20) ALLOCATE(10)
                  NOT NULL WITH DEFAULT)
```

After you run the following ALTER TABLE statement, COL2 still has an allocated length of 10 and CCSID 937, and COL3 still has an allocated length of 10.

```
ALTER TABLE EX1 ALTER COLUMN COL2 SET DATA TYPE VARCHAR(30)
ALTER COLUMN COL3 DROP NOT NULL
```

Related reference

Changing a column

You can change a column definition in a table using the ALTER COLUMN clause of the ALTER TABLE statement.

Deleting a column

You can delete a column using the DROP COLUMN clause of the ALTER TABLE statement.

Dropping a column deletes that column from the table definition. If CASCADE is specified, any views, indexes, and constraints dependent on that column will also be dropped. If RESTRICT is specified, and any views, indexes, or constraints are dependent on the column, the column will not be dropped and SQLCODE of -196 will be issued.

```
ALTER TABLE DEPT
DROP COLUMN NUMDEPT
```

Related reference

[ALTER TABLE](#)

Order of operations for the ALTER TABLE statement

Operations for the ALTER TABLE statement are performed in a defined order.

The ALTER TABLE statement is performed as this set of steps shows:

1. Drop constraints
2. Drop materialized query table
3. Drop partition
4. Drop partitioning
5. Drop columns for which the RESTRICT option was specified
6. Alter column definitions (this includes adding columns and dropping columns for which the CASCADE option was specified)
7. Alter partition
8. Add or alter materialized query table
9. Add partitioning to a table
10. Add constraints

Within each of these steps, the order in which you specify the clauses is the order in which they are performed, with one exception. If any columns are being dropped, that operation is logically done before any column definitions are added or altered, in case record length is increased as a result of the ALTER TABLE statement.

Using CREATE OR REPLACE TABLE

The OR REPLACE option on the CREATE TABLE statement can be used to change an existing table definition.

Using CREATE OR REPLACE TABLE lets you consolidate the master definition of a table into one statement. You do not need to maintain the source for the original CREATE TABLE statement plus a complex list of ALTER TABLE statements needed to recreate the most current version of a table. This CREATE TABLE statement can be executed to deploy the current definition of the table either as a new table or to replace a prior version of the table.

There are options to either keep the existing data in the table or to clear the data from the table during the replace. The default is to keep all data. If you elect to clear all the data, your new table definition does not need to be compatible with the original version. In all cases, other objects that depend on the table, such as referential constraints, triggers, and views, must remain satisfied or the replace will fail.

Suppose your original table was this basic INVENTORY table.

```
CREATE TABLE INVENTORY
(PARTNO    SMALLINT NOT NULL,
DESCR     VARCHAR(24),
QONHAND   INT,
PRIMARY KEY(PARTNO))
```

Perhaps over time, you have updated the column names to be more descriptive, changed the DESCR column to be a longer Unicode column, and added a timestamp column for when the row was last updated. The following statement reflects all of these changes and can be executed against any prior version of the table, as long as the column names can be matched to the prior column names and the data types are compatible.

```
CREATE OR REPLACE TABLE INVENTORY
(PART_NUMBER FOR PARTNO    SMALLINT NOT NULL,
DESCRIPTION FOR DESCR     VARCHAR(500) CCSID 1200,
QUANTITY_ON_HAND FOR QONHAND INT,
LAST_MODIFIED FOR MODIFIED  TIMESTAMP)
```

```
NOT NULL GENERATED ALWAYS FOR EACH ROW ON UPDATE AS ROW CHANGE TIMESTAMP,  
PRIMARY KEY(PARTNO))
```

Partitioned tables can be modified using CREATE OR REPLACE TABLE. The following example demonstrates splitting a single partition into multiple partitions.

Suppose your original table was defined to have 3 partitions

```
CREATE TABLE PARTITIONED  
  (KEYFLD BIGINT,  
   DATAFLD VARCHAR(200))  
  PARTITION BY RANGE (KEYFLD)  
    (PARTITION FIRST STARTING 0 ENDING 100,  
     PARTITION SECOND STARTING 100 EXCLUSIVE ENDING 200,  
     PARTITION THIRD STARTING 200 EXCLUSIVE ENDING 300)
```

To break the second partition into 3 pieces, modify the original CREATE TABLE statement to redefine the partitions.

```
CREATE OR REPLACE TABLE PARTITIONED  
  (KEYFLD BIGINT,  
   DATAFLD VARCHAR(200))  
  PARTITION BY RANGE (KEYFLD)  
    (PARTITION FIRST STARTING 0 ENDING 100,  
     PARTITION SECOND STARTING 100 EXCLUSIVE ENDING 150,  
     PARTITION SPLIT1 STARTING 151 EXCLUSIVE ENDING 175,  
     PARTITION SPLIT2 STARTING 176 EXCLUSIVE ENDING 200,  
     PARTITION THIRD STARTING 200 EXCLUSIVE ENDING 300)
```

Now the table will have 5 partitions with the data spread among them according to the new definition.

This example uses the default of ON REPLACE PRESERVE ALL ROWS. That means that all data for all rows is guaranteed to be kept. If data from an existing partition doesn't fit in any new partition, the statement fails. To remove a partition and the data from that partition, omit the partition definition from the CREATE OR REPLACE TABLE statement and use ON REPLACE PRESERVE ROWS. This will preserve all the data that can be assigned to the remaining partitions and discard any that no longer has a defined partition.

Creating and using ALIAS names

When you refer to an existing table or view, or to a physical file that consists of multiple members, you can avoid using file overrides by creating an alias. To create an alias, use the CREATE ALIAS statement.

You can create an alias for:

- A table or view
- A *member* of a table

A table alias defines a name for the file, including the specific member name. You can use this alias name in an SQL statement in the same way that a table name is used. Unlike overrides, alias names are objects that exist until they are dropped.

For example, if there is a multiple member file MYLIB.MYFILE with members MBR1 and MBR2, an alias can be created for the second member so that SQL can easily refer to it.

```
CREATE ALIAS MYLIB.MYMBR2_ALIAS FOR MYLIB.MYFILE (MBR2)
```

When alias MYLIB.MYMBR2_ALIAS is specified on the following insert statement, the values are inserted into member MBR2 in MYLIB.MYFILE:

```
INSERT INTO MYLIB.MYMBR2_ALIAS VALUES('ABC', 6)
```

Alias names can also be specified on DDL statements. Assume that MYLIB.MYALIAS is an alias for table MYLIB.MYTABLE. The following DROP statement drops table MYLIB.MYTABLE:

```
DROP TABLE MYLIB.MYALIAS
```

If you really want to drop the alias name instead, specify the ALIAS keyword on the drop statement:

```
DROP ALIAS MYLIB.MYALIAS
```

Related reference

[CREATE ALIAS](#)

Creating and using views

A view can be used to access data in one or more tables or views. You create a view by using a SELECT statement.

For example, create a view that selects only the family name and the department of all the managers:

```
CREATE VIEW CORPDATA.EMP_MANAGERS FOR SYSTEM NAME EMPMANAGER AS
SELECT LASTNAME, WORKDEPT FROM CORPDATA.EMPLOYEE
WHERE JOB = 'MANAGER'
```

Since the view name, EMP_MANAGERS, is too long for a system object name, the FOR SYSTEM NAME clause can be used to provide the system name. Without adding this clause, a name like EMP_M00001 will be generated for the system object.

After you create the view, you can use it in SQL statements just like a table. You can also change the data in the base table through the view. The following SELECT statement displays the contents of EMP_MANAGERS:

```
SELECT *
FROM CORPDATA.EMP_MANAGERS
```

The results follow.

LASTNAME	WORKDEPT
THOMPSON	B01
KWAN	C01
GEYER	E01
STERN	D11
PULASKI	D21
HENDERSON	E11
SPENSER	E21

If the select list contains elements other than columns such as expressions, functions, constants, or special registers, and the AS clause was not used to name the columns, a column list must be specified for the view. In the following example, the columns of the view are LASTNAME and YEARSOFSERVICE.

```
CREATE VIEW CORPDATA.EMP_YEARSOFSERVICE
(LASTNAME, YEARSOFSERVICE) AS
SELECT LASTNAME, YEAR (CURRENT DATE - HIREDATE)
FROM CORPDATA.EMPLOYEE
```

Because the results of querying this view change as the current year changes, they are not included here.

You can also define the previous view by using the AS clause in the select list to name the columns in the view. For example:

```
CREATE VIEW CORPDATA.EMP_YEARSOFSERVICE AS
SELECT LASTNAME,
       YEARS (CURRENT_DATE - HIREDATE) AS YEARSOFSERVICE
FROM CORPDATA.EMPLOYEE
```

Using the UNION keyword, you can combine two or more subselects to form a single view. For example:

```
CREATE VIEW D11_EMPS_PROJECTS AS
(SELECT EMPNO
 FROM CORPDATA.EMPLOYEE
 WHERE WORKDEPT = 'D11'
 UNION
 SELECT EMPNO
 FROM CORPDATA.EMPPROJACT
 WHERE PROJNO = 'MA2112' OR
        PROJNO = 'MA2113' OR
        PROJNO = 'AD3111')
```

This view has the following data.

Table 9. Results of creating a view as UNION

EMPNO
000060
000150
000160
000170
000180
000190
000200
000210
000220
000230
000240
200170
200220

Views are created with the sort sequence in effect at the time the CREATE VIEW statement is run. The sort sequence applies to all character, or UCS-2 or UTF-16 graphic comparisons in the CREATE VIEW statement subselect.

You can also create views using the WITH CHECK OPTION clause to specify the level of checking when data is inserted or updated through the view.

Related concepts

[Retrieving data using the SELECT statement](#)

The SELECT statement tailors your query to gather data. You can use the SELECT statement to retrieve a specific row or retrieve data in a specific way.

[Sort sequences and normalization in SQL](#)

A sort sequence defines how characters in a character set relate to each other when they are compared or ordered. Normalization allows you to compare strings that contain combining characters.

Related reference

[Using the UNION keyword to combine subselects](#)

Using the UNION keyword, you can combine two or more subselects to form a fullselect.

[CREATE VIEW](#)

WITH CHECK OPTION on a view

WITH CHECK OPTION is an optional clause on the CREATE VIEW statement. It specifies the level of checking when data is inserted or updated through a view.

If WITH CHECK OPTION is specified, every row that is inserted or updated through the view must conform to the definition of the view. The option cannot be specified if the view is read-only. The definition of the view must not include a subquery.

If the view is created without a WITH CHECK OPTION clause, insert and update operations that are performed on the view are not checked for conformance to the view definition. Some checking might still occur if the view is directly or indirectly dependent on another view that includes WITH CHECK OPTION. Because the definition of the view is not used, rows that do not conform to the definition of the view might be inserted or updated through the view. This means that the rows cannot be selected again through the view.

Related reference

[CREATE VIEW](#)

WITH CASCADED CHECK OPTION

The WITH CASCADED CHECK OPTION clause specifies that every row that is inserted or updated through a view must conform to the definition of the view.

In addition, the search conditions of all dependent views are checked when a row is inserted or updated. If a row does not conform to the definition of the view, that row cannot be retrieved through the view.

For example, consider the following updatable view:

```
CREATE VIEW V1 AS SELECT COL1
FROM T1 WHERE COL1 > 10
```

Because no WITH CHECK OPTION is specified, the following INSERT statement is successful even though the value being inserted does not meet the search condition of the view.

```
INSERT INTO V1 VALUES (5)
```

Create another view over V1, specifying the WITH CASCADED CHECK OPTION clause:

```
CREATE VIEW V2 AS SELECT COL1
FROM V1 WITH CASCADED CHECK OPTION
```

The following INSERT statement fails because it produces a row that does not conform to the definition of V2:

```
INSERT INTO V2 VALUES (5)
```

Consider one more view created over V2:

```
CREATE VIEW V3 AS SELECT COL1
FROM V2 WHERE COL1 < 100
```

The following INSERT statement fails only because V3 is dependent on V2, and V2 has a WITH CASCADED CHECK OPTION.

```
INSERT INTO V3 VALUES (5)
```

However, the following INSERT statement is successful because it conforms to the definition of V2. Because V3 does not have a WITH CASCADED CHECK OPTION, it does not matter that the statement does not conform to the definition of V3.

```
INSERT INTO V3 VALUES (200)
```

WITH LOCAL CHECK OPTION

The WITH LOCAL CHECK OPTION clause is identical to the WITH CASCADED CHECK OPTION clause except that you can update a row so that it can no longer be retrieved through the view. This can happen only when the view is directly or indirectly dependent on a view that was defined with no WITH CHECK OPTION clause.

For example, consider the same updatable view used in the previous example:

```
CREATE VIEW V1 AS SELECT COL1
FROM T1 WHERE COL1 > 10
```

Create second view over V1, this time specifying WITH LOCAL CHECK OPTION:

```
CREATE VIEW V2 AS SELECT COL1
FROM V1 WITH LOCAL CHECK OPTION
```

The same INSERT statement that failed in the previous CASCADED CHECK OPTION example succeeds now because V2 does not have any search conditions, and the search conditions of V1 do not need to be checked since V1 does not specify a check option.

```
INSERT INTO V2 VALUES (5)
```

Consider one more view created over V2:

```
CREATE VIEW V3 AS SELECT COL1
FROM V2 WHERE COL1 < 100
```

The following INSERT is successful again because the search condition on V1 is not checked due to the WITH LOCAL CHECK OPTION on V2, versus the WITH CASCADED CHECK OPTION in the previous example.

```
INSERT INTO V3 VALUES (5)
```

The difference between LOCAL and CASCADED CHECK OPTION lies in how many of the dependent views' search conditions are checked when a row is inserted or updated.

- WITH LOCAL CHECK OPTION specifies that the search conditions of only those dependent views that have the WITH LOCAL CHECK OPTION or WITH CASCADED CHECK OPTION are checked when a row is inserted or updated.
- WITH CASCADED CHECK OPTION specifies that the search conditions of all dependent views are checked when a row is inserted or updated.

Example: Cascaded check option

This example shows how the check option is enforced on a number of dependent views that are defined with or without a check option.

Use the following table and views:

```
CREATE TABLE T1 (COL1 CHAR(10))
CREATE VIEW V1 AS SELECT COL1
FROM T1 WHERE COL1 LIKE 'A%'
CREATE VIEW V2 AS SELECT COL1
FROM V1 WHERE COL1 LIKE '%Z'
WITH LOCAL CHECK OPTION
CREATE VIEW V3 AS SELECT COL1
FROM V2 WHERE COL1 LIKE 'AB%'
CREATE VIEW V4 AS SELECT COL1
FROM V3 WHERE COL1 LIKE '%YZ'
WITH CASCADED CHECK OPTION
CREATE VIEW V5 AS SELECT COL1
FROM V4 WHERE COL1 LIKE 'ABC%'
```

Different search conditions are going to be checked depending on which view is being operated on with an INSERT or UPDATE statement.

- If V1 is operated on, no conditions are checked because V1 does not have a WITH CHECK OPTION specified.
- If V2 is operated on,
 - COL1 must end in the letter Z, but it doesn't need to start with the letter A. This is because the check option is LOCAL, and view V1 does not have a check option specified.
- If V3 is operated on,
 - COL1 must end in the letter Z, but it does not need to start with the letter A. V3 does not have a check option specified, so its own search condition must not be met. However, the search condition for V2 must be checked because V3 is defined on V2, and V2 has a check option.
- If V4 is operated on,
 - COL1 must start with 'AB' and must end with 'YZ'. Because V4 has the WITH CASCADED CHECK OPTION specified, every search condition for every view on which V4 is dependent must be checked.
- If V5 is operated on,
 - COL1 must start with 'AB', but not necessarily 'ABC'. This is because V5 does not specify a check option, so its own search condition does not need to be checked. However, because V5 is defined on V4, and V4 had a cascaded check option, every search condition for V4, V3, V2, and V1 must be checked. That is, COL1 must start with 'AB' and end with 'YZ'.

If V5 were created WITH LOCAL CHECK OPTION, operating on V5 means that COL1 must start with 'ABC' and end with 'YZ'. The LOCAL CHECK OPTION adds the additional requirement that the third character must be a 'C'.

Creating indexes

You can use indexes to sort and select data. In addition, indexes help the system retrieve data faster for better query performance.

Use the CREATE INDEX statement to create indexes. The following example creates an index over the column *LASTNAME* in the CORPDATA.EMPLOYEE table:

```
CREATE INDEX CORPDATA.INX1 ON CORPDATA.EMPLOYEE (LASTNAME)
```

You can also create an index that does not exactly match the data for a column in a table. For example, you can create an index that uses the uppercase version of an employee name:

```
CREATE INDEX CORPDATA.INX2 ON CORPDATA.EMPLOYEE (UPPER(LASTNAME))
```

Most expressions allowed by SQL can be used in the definition of the key columns.

You can create any number of indexes. However, because the indexes are maintained by the system, a large number of indexes can adversely affect performance. One type of index, the encoded vector index (EVI), allows for faster scans that can be more easily processed in parallel.

If an index is created that has exactly the same attributes as an existing index, the new index shares the existing indexes' binary tree. Otherwise, another binary tree is created. If the attributes of the new index are exactly the same as another index, except that the new index has fewer columns, another binary tree is still created. It is still created because the extra columns prevent the index from being used by cursors or UPDATE statements that update those extra columns.

Indexes are created with the sort sequence in effect at the time the CREATE INDEX statement is run. The sort sequence applies to all SBCS character fields, or UCS-2 or UTF-16 graphic fields of the index.

Related concepts

[Sort sequences and normalization in SQL](#)

A sort sequence defines how characters in a character set relate to each other when they are compared or ordered. Normalization allows you to compare strings that contain combining characters.

[Creating an index strategy](#)

Related reference

[CREATE INDEX](#)

Creating and using global variables

You can use global variables to assign specific variable values for a session.

Use the CREATE VARIABLE statement to create a global variable. The following example creates a global variable that defines a user class.

```
CREATE VARIABLE USER_CLASS INT DEFAULT (CLASS_FUNC(USER))
```

This variable will have its initial value set based on the result of invoking a function called CLASS_FUNC. This function is assumed to assign a class value such as administrator or clerk based on the USER special register value.

A global variable is instantiated for a session the first time it is referenced. Once it is set, it will maintain its value unless explicitly changed within the session.

A global variable can be used in a query to determine what results will be returned. In the following example, a list of all employees from department A00 are listed. Only a session that has a global variable with a USER_CLASS value of 1 will see the salaries for these employees.

```
SELECT EMPNO, LASTNAME, CASE WHEN USER_CLASS = 1 THEN SALARY ELSE NULL END  
FROM EMPLOYEE  
WHERE WORKDEPT = 'A00'
```

Global variables can be used in any context where an expression is allowed. Unlike a host variable, a global variable can be used in a CREATE VIEW statement.

Replacing existing objects

You can replace an existing object using a CREATE statement rather than always needing to drop the object first.

For many SQL objects, you can optionally replace an existing object when using the CREATE SQL statement. The existing object is effectively dropped before the new object is created. The following SQL statements have that option:

- CREATE ALIAS
- CREATE FUNCTION
- CREATE MASK
- CREATE PERMISSION
- CREATE PROCEDURE
- CREATE SEQUENCE
- CREATE TABLE
- CREATE TRIGGER
- CREATE VARIABLE
- CREATE VIEW

When the replace option is used for any of these statements, the privileges for the existing object are kept. The object definition is replaced by the new definition.

Example: Create or replace sequence

To create a sequence called MYSEQUENCE, or replace a sequence of that name if it exists, use the following SQL statement

```
CREATE OR REPLACE SEQUENCE MYSEQUENCE AS BIGINT
```

The sequence will be created if it does not already exist. If it does exist, the privileges from the existing sequence will be transferred to the new sequence.

Catalogs in database design

A catalog is automatically created when you create a schema. There is also a system-wide catalog that is always in the QSYS2 library.

When an SQL object is created in a schema, information is added to both the system catalog tables and the schema's catalog tables. When an SQL object is created in a library, only the QSYS2 catalog is updated. A table created with DECLARE GLOBAL TEMPORARY TABLE is not added to a catalog.

As the following examples show, you can display catalog information. You cannot insert, delete, or update catalog information. You must have SELECT privileges on the catalog views to run the following examples.

Related reference

[Db2 for i catalog views](#)

Getting catalog information about a table

The SYSTABLES view contains a row for each table and view in the SQL schema. The SYSTABLES view provides information such as the object type (table or view), the object name, the owner of the object, and the schema where the object exists.

The following example statement displays information for the CORPDATA.DEPARTMENT table:

```
SELECT *  
FROM CORPDATA.SYSTABLES  
WHERE TABLE_NAME = 'DEPARTMENT'
```

Getting catalog information about a column

The SYSCOLUMNS view contains a row for each column of a table and view in the schema.

The following example statement displays all the column names in the CORPDATA.DEPARTMENT table:

```
SELECT *  
FROM CORPDATA.SYSCOLUMNS  
WHERE TABLE_NAME = 'DEPARTMENT'
```

The result of the previous example statement is a row of information for each column in the table.

For specific information about each column, specify a select-statement like this:

```
SELECT COLUMN_NAME, TABLE_NAME, DATA_TYPE, LENGTH, HAS_DEFAULT  
FROM CORPDATA.SYSCOLUMNS  
WHERE TABLE_NAME = 'DEPARTMENT'
```

In addition to the column name for each column, the select-statement shows:

- The name of the table that contains the column
- The data type of the column
- The length attribute of the column
- If the column allows default values

The result looks like this.

COLUMN_NAME	TABLE_NAME	DATA_TYPE	LENGTH	HAS_DEFAULT
DEPTNO	DEPARTMENT	CHAR	3	N
DEPTNAME	DEPARTMENT	VARCHAR	29	N
MGRNO	DEPARTMENT	CHAR	6	Y
ADMRDEPT	DEPARTMENT	CHAR	3	N

Dropping a database object

The DROP statement deletes an object. Depending on the action requested, any objects that are directly or indirectly dependent on that object might also be deleted or might prevent the drop from happening.

For example, if you drop a table, any aliases, constraints, triggers, views, or indexes associated with that table are also dropped. Whenever an object is deleted, its description is deleted from the catalog.

For example, to drop table EMPLOYEE, issue the following statement:

```
DROP TABLE EMPLOYEE RESTRICT
```

Related reference

[DROP](#)

Data manipulation language

Data manipulation language (DML) describes the portion of SQL that manipulates or controls data.

Related concepts

[Types of SQL statements](#)

There are several basic types of SQL statements. They are listed here according to their functions.

Retrieving data using the SELECT statement

The SELECT statement tailors your query to gather data. You can use the SELECT statement to retrieve a specific row or retrieve data in a specific way.

If SQL is unable to find a row that satisfies the search condition, an SQLCODE of +100 is returned.

If SQL finds errors while running your select-statement, a negative SQLCODE is returned. If SQL finds more host variables than results, +326 is returned.

Related reference

[Creating a table using AS](#)

You can create a table from the result of a SELECT statement. To create this type of table, use the CREATE TABLE AS statement.

[Creating and using views](#)

A view can be used to access data in one or more tables or views. You create a view by using a SELECT statement.

Basic SELECT statement

The basic format and syntax of the SELECT statement consists of several required and optional clauses.

You can write SQL statements on one line or on many lines. For SQL statements in precompiled programs, the rules for the continuation of lines are the same as those of the host language (the language the program is written in). A SELECT statement can also be used by a cursor in a program. Finally, a SELECT statement can be prepared in a dynamic application.

Notes:

1. The SQL statements described in this section can be run on SQL tables and views, and database physical and logical files.

2. Character strings specified in an SQL statement (such as those used with WHERE or VALUES clauses) are case-sensitive; that is, uppercase characters must be entered in uppercase and lowercase characters must be entered in lowercase.

```
WHERE ADMRDEPT='a00'      (does not return a result)
WHERE ADMRDEPT='A00'      (returns a valid department number)
```

Comparisons might not be case sensitive if a shared-weight sort sequence is used where uppercase and lowercase characters are treated as the same characters.

A SELECT statement can include the following:

1. The name of each column you want to include in the result.
2. The name of the table or view that contains the data.
3. A search condition to identify the rows that contain the information you want.
4. The name of each column used to group your data.
5. A search condition that uniquely identifies a group that contains the information you want.
6. The order of the results.
7. An offset into the result set to enable skipping a number of rows.
8. The number of rows to return.

A SELECT statement looks like this:

```
SELECT column names
FROM table or view name
WHERE search condition
GROUP BY column names
HAVING search condition
ORDER BY column-name
OFFSET number of rows
FETCH FIRST n ROWS ONLY
```

The SELECT and FROM clauses must be specified. The other clauses are optional.

With the SELECT clause, you specify the name of each column you want to retrieve. For example:

```
SELECT EMPNO, LASTNAME, WORKDEPT
```

You can specify that only one column be retrieved, or as many as 8000 columns. The value of each column you name is retrieved in the order specified in the SELECT clause.

If you want to retrieve all columns (in the same order as they appear in the table's definition), use an asterisk (*) instead of naming the columns:

```
SELECT *
```

The FROM clause specifies the table that you want to select data *from*. You can select columns from more than one table. When issuing a SELECT, you must specify a FROM clause. Issue the following statement:

```
SELECT *
FROM EMPLOYEE
```

The result is all of the columns and rows from the table EMPLOYEE.

The SELECT list can also contain expressions, including constants, special registers, and scalar fullselects. An AS clause can be used to give the resulting column a name. For example, issue the following statement:

```
SELECT LASTNAME, SALARY * .05 AS RAISE
FROM EMPLOYEE
WHERE EMPNO = '200140'
```

The result of this statement follows.

Table 10. Results for query

LASTNAME	RAISE
NATZ	1421

Specifying a search condition using the WHERE clause

The WHERE clause specifies a search condition that identifies the row or rows that you want to retrieve, update, or delete.

The number of rows you process with an SQL statement then depends on the number of rows that satisfy the WHERE clause **search condition**. A search condition consists of one or more **predicates**. A predicate specifies a test that you want SQL to apply to a specified row or rows of a table.

In the following example, WORKDEPT = 'C01' is a predicate, WORKDEPT and 'C01' are expressions, and the equal sign (=) is a comparison operator. Note that character values are enclosed in apostrophes (' '); numeric values are not. This applies to all constant values wherever they are coded within an SQL statement. For example, to specify that you are interested in the rows where the department number is C01, issue the following statement:

```
... WHERE WORKDEPT = 'C01'
```

In this case, the search condition consists of one predicate: WORKDEPT = 'C01'.

To further illustrate WHERE, put it into a SELECT statement. Assume that each department listed in the CORPDATA.DEPARTMENT table has a unique department number. You want to retrieve the department name and manager number from the CORPDATA.DEPARTMENT table for department C01. Issue the following statement:

```
SELECT DEPTNAME, MGRNO
FROM CORPDATA.DEPARTMENT
WHERE DEPTNO = 'C01'
```

The result of this statement is one row.

Table 11. Result table

DEPTNAME	MGRNO
INFORMATION CENTER	000030

If the search condition contains character, or UCS-2 or UTF-16 graphic column predicates, the sort sequence that is in effect when the query is run is applied to those predicates. If a sort sequence is not being used, character constants must be specified in uppercase or lowercase to match the column or expression they are being compared to.

Related concepts

[Sort sequences and normalization in SQL](#)

A sort sequence defines how characters in a character set relate to each other when they are compared or ordered. Normalization allows you to compare strings that contain combining characters.

Related reference

[Defining complex search conditions](#)

In addition to the basic comparison predicates, such as = and >, a search condition can contain any of these predicates: BETWEEN, IN, EXISTS, IS NULL, and LIKE.

[Multiple search conditions within a WHERE clause](#)

You can qualify your request further by coding a search condition that includes several predicates.

Expressions in the WHERE clause

An expression in a WHERE clause names or specifies something that you want to compare to something else.

The expressions you specify can be:

- A **column name** names a column. For example:

```
... WHERE EMPNO = '000200'
```

EMPNO names a column that is defined as a 6-byte character value.

- An **expression** identifies two values that are added (+), subtracted (-), multiplied (*), divided (/), have exponentiation (**), or concatenated (CONCAT or ||) to result in a value. The most common operands of an expression are:
 - A constant
 - A column
 - A host variable
 - A global variable
 - A function
 - A special register
 - A scalar fullselect
 - Another expression

For example:

```
... WHERE INTEGER(PRENDATE - PRSTDATE) > 100
```

When the order of evaluation is not specified by parentheses, the expression is evaluated in the following order:

1. Prefix operators
2. Exponentiation
3. Multiplication, division, and concatenation
4. Addition and subtraction

Operators on the same precedence level are applied from left to right.

- A **constant** specifies a literal value for the expression. For example:

```
... WHERE 40000 < SALARY
```

SALARY names a column that is defined as a 9-digit packed decimal value (DECIMAL(9,2)). It is compared to the numeric constant 40000.

- A **host variable** identifies a variable in an application program. For example:

```
... WHERE EMPNO = :EMP
```

- A **special register** identifies a special value defined by the database manager. For example:

```
... WHERE LASTNAME = USER
```

- The **NULL** value specifies the condition of having an unknown value.

```
... WHERE DUE_DATE IS NULL
```

A search condition can specify many predicates separated by AND and OR. No matter how complex the search condition, it supplies a TRUE or FALSE value when evaluated against a row. There is also an

unknown truth value, which is effectively false. That is, if the value of a row is null, this null value is not returned as a result of a search because it is not less than, equal to, or greater than the value specified in the search condition.

To fully understand the WHERE clause, you need to know the order SQL evaluates search conditions and predicates, and compares the values of expressions. This topic is discussed in the [Db2 for i SQL reference](#) topic collection.

Related concepts

[Using subqueries](#)

You can use subqueries in a search condition as another way to select data. Subqueries can be used anywhere an expression can be used.

Related reference

[Defining complex search conditions](#)

In addition to the basic comparison predicates, such as = and >, a search condition can contain any of these predicates: BETWEEN, IN, EXISTS, IS NULL, and LIKE.

[Expressions](#)

Comparison operators

SQL supports several comparison operators.

Comparison operator	Description
<> or \neq or \neq	Not equal to
=	Equal to
<	Less than
>	Greater than
\leq or \geq or \leq	Less than or equal to (or not greater than)
\geq or \leq or \geq	Greater than or equal to (or not less than)

NOT keyword

You can precede a predicate with the NOT keyword to specify that you want the opposite of the predicate's value (that is, TRUE if the predicate is FALSE).

NOT applies only to the predicate it precedes, not to all predicates in the WHERE clause. For example, to indicate that you are interested in all employees except those working in the department C01, you can say:

```
... WHERE NOT WORKDEPT = 'C01'
```

which is equivalent to:

```
... WHERE WORKDEPT <> 'C01'
```

GROUP BY clause

The GROUP BY clause allows you to find the characteristics of groups of rows rather than individual rows.

When you specify a GROUP BY clause, SQL divides the selected rows into groups such that the rows of each group have matching values in one or more columns or expressions. Next, SQL processes each group to produce a single-row result for the group. You can specify one or more columns or expressions in the GROUP BY clause to group the rows. The items you specify in the SELECT statement are properties of each group of rows, not properties of individual rows in a table or view.

Without a GROUP BY clause, the application of SQL aggregate functions returns *one* row. When GROUP BY is used, the function is applied to *each* group, thereby returning as many rows as there are groups.

For example, the CORPDATA.EMPLOYEE table has several sets of rows, and each set consists of rows describing members of a specific department. To find the average salary of people in each department, you can issue:

```
SELECT WORKDEPT, DECIMAL (AVG(SALARY),5,0)
FROM CORPDATA.EMPLOYEE
GROUP BY WORKDEPT
```

The result is several rows, one for each department.

WORKDEPT	AVG-SALARY
A00	40850
B01	41250
C01	29722
D11	25147
D21	25668
E01	40175
E11	21020
E21	24086

Notes:

1. Grouping the rows does not mean ordering them. Grouping puts each selected row in a group, which SQL then processes to derive characteristics of the group. Ordering the rows puts all the rows in the results table in ascending or descending collating sequence. Depending on the implementation selected by the database manager, the resulting groups might appear to be ordered.
2. If there are null values in the column you specify in the GROUP BY clause, a single-row result is produced for the data in the rows with null values.
3. If the grouping occurs over character, or UCS-2 or UTF-16 graphic columns, the sort sequence in effect when the query is run is applied to the grouping.

When you use GROUP BY, you list the columns or expressions you want SQL to use to group the rows. For example, suppose that you want a list of the number of people working on each major project described in the CORPDATA.PROJECT table. You can issue:

```
SELECT SUM(PRSTAFF), MAJPROJ
FROM CORPDATA.PROJECT
GROUP BY MAJPROJ
```

The result is a list of the company's current major projects and the number of people working on each project.

SUM(PRSTAFF)	MAJPROJ
6	AD3100
5	AD3110
10	MA2100
8	MA2110
5	OP1000
4	OP2000
3	OP2010

SUM(PRSTAFF)	MAJPROJ
32.5	?

You can also specify that you want the rows grouped by more than one column or expression. For example, you can issue a select statement to find the average salary for men and women in each department, using the CORPDATA.EMPLOYEE table. To do this, you can issue:

```
SELECT WORKDEPT, SEX, DECIMAL(AVG(SALARY),5,0) AS AVG_WAGES
FROM CORPDATA.EMPLOYEE
GROUP BY WORKDEPT, SEX
```

The result follows.

WORKDEPT	SEX	AVG_WAGES
A00	F	49625
A00	M	35000
B01	M	41250
C01	F	29722
D11	F	25817
D11	M	24764
D21	F	26933
D21	M	24720
E01	M	40175
E11	F	22810
E11	M	16545
E21	F	25370
E21	M	23830

Because you did not include a WHERE clause in this example, SQL examines and processes all rows in the CORPDATA.EMPLOYEE table. The rows are grouped first by department number and next (within each department) by sex before SQL derives the average SALARY value for each group.

Related concepts

[Sort sequences and normalization in SQL](#)

A sort sequence defines how characters in a character set relate to each other when they are compared or ordered. Normalization allows you to compare strings that contain combining characters.

Related reference

[ORDER BY clause](#)

The ORDER BY clause specifies the particular order in which you want selected rows returned. The order is sorted by ascending or descending collating sequence of a column's or an expression's value.

HAVING clause

The HAVING clause specifies a search condition for the groups selected by the GROUP BY clause.

The HAVING clause says that you want *only* those groups that satisfy the condition in that clause. Therefore, the search condition you specify in the HAVING clause must test properties of each group rather than properties of individual rows in the group.

The HAVING clause follows the GROUP BY clause and can contain the same kind of search condition as you can specify in a WHERE clause. In addition, you can specify aggregate functions in a HAVING clause.

For example, suppose that you want to retrieve the average salary of women in each department. To do this, use the AVG aggregate function and group the resulting rows by WORKDEPT and specify a WHERE clause of SEX = ' F '.

To specify that you want this data only when all the female employees in the selected department have an education level equal to or greater than 16 (a college graduate), use the HAVING clause. The HAVING clause tests a property of the group. In this case, the test is on MIN(EDLEVEL), which is a group property:

```
SELECT WORKDEPT, DECIMAL(AVG(SALARY),5,0) AS AVG_WAGES, MIN(EDLEVEL) AS MIN_EDUC
FROM CORPDATA.EMPLOYEE
WHERE SEX=' F '
GROUP BY WORKDEPT
HAVING MIN(EDLEVEL)>=16
```

The result follows.

WORKDEPT	AVG_WAGES	MIN_EDUC
A00	49625	18
C01	29722	16
D11	25817	17

You can use multiple predicates in a HAVING clause by connecting them with AND and OR, and you can use NOT for any predicate of a search condition.

Note: If you intend to update a column or delete a row, you cannot include a GROUP BY or HAVING clause in the SELECT statement within a DECLARE CURSOR statement. These clauses make it a read-only cursor.

Predicates with arguments that are not aggregate functions can be coded in either WHERE or HAVING clauses. It is typically more efficient to code the selection criteria in the WHERE clause because it is handled earlier in the query processing. The HAVING selection is performed in post processing of the result table.

If the search condition contains predicates involving character, or UCS-2 or UTF-16 graphic columns, the sort sequence in effect when the query is run is applied to those predicates.

Related concepts

[Sort sequences and normalization in SQL](#)

A sort sequence defines how characters in a character set relate to each other when they are compared or ordered. Normalization allows you to compare strings that contain combining characters.

Related reference

[Using a cursor](#)

When SQL runs a SELECT statement, the resulting rows comprise the result table. A cursor provides a way to access a result table.

ORDER BY clause

The ORDER BY clause specifies the particular order in which you want selected rows returned. The order is sorted by ascending or descending collating sequence of a column's or an expression's value.

For example, to retrieve the names and department numbers of female employees listed in the alphanumeric order of their department numbers, you can use this select-statement:

```
SELECT LASTNAME, WORKDEPT
FROM CORPDATA.EMPLOYEE
WHERE SEX=' F '
ORDER BY WORKDEPT
```

The result follows.

LASTNAME	WORKDEPT
HAAS	A00
HEMMINGER	A00
KWAN	C01
QUINTANA	C01
NICHOLLS	C01
NATZ	C01
PIANKA	D11
SCOUTTEN	D11
LUTZ	D11
JOHN	D11
PULASKI	D21
JOHNSON	D21
PEREZ	D21
HENDERSON	E11
SCHNEIDER	E11
SETRIGHT	E11
SCHWARTZ	E11
SPRINGER	E11
WONG	E21

Note: Null values are ordered as the highest value.

The column specified in the ORDER BY clause does not need to be included in the SELECT clause. For example, the following statement will return all female employees ordered with the largest salary first:

```
SELECT LASTNAME, FIRSTNAME
FROM CORPDATA.EMPLOYEE
WHERE SEX='F'
ORDER BY SALARY DESC
```

If an AS clause is specified to name a result column in the select-list, this name can be specified in the ORDER BY clause. The name specified in the AS clause must be unique in the select-list. For example, to retrieve the full names of employees listed in alphabetic order, you can use this select-statement:

```
SELECT LASTNAME CONCAT FIRSTNAME AS FULLNAME
FROM CORPDATA.EMPLOYEE
ORDER BY FULLNAME
```

This select-statement can optionally be written as:

```
SELECT LASTNAME CONCAT FIRSTNAME
FROM CORPDATA.EMPLOYEE
ORDER BY LASTNAME CONCAT FIRSTNAME
```

Instead of naming the columns to order the results, you can use a number. For example, ORDER BY 3 specifies that you want the results ordered by the *third* column of the results table, as specified by the select-list. Use a number to order the rows of the results table when the sequencing value is not a named column.

You can also specify whether you want SQL to collate the rows in ascending (ASC) or descending (DESC) sequence. An ascending collating sequence is the default. In the previous select-statement, SQL first returns the row with the lowest *FULLNAME* expression (alphabetically and numerically), followed by rows with higher values. To order the rows in descending collating sequence based on this name, specify:

```
... ORDER BY FULLNAME DESC
```

You can specify a secondary ordering sequence (or several levels of ordering sequences) as well as a primary one. In the previous example, you might want the rows ordered first by department number, and within each department, ordered by employee name. To do this, specify:

```
... ORDER BY WORKDEPT, FULLNAME
```

If character columns, or UCS-2 or UTF-16 graphic columns are used in the ORDER BY clause, ordering for these columns is based on the sort sequence in effect when the query is run.

Related concepts

[Sort sequences and normalization in SQL](#)

A sort sequence defines how characters in a character set relate to each other when they are compared or ordered. Normalization allows you to compare strings that contain combining characters.

Related reference

[GROUP BY clause](#)

The GROUP BY clause allows you to find the characteristics of groups of rows rather than individual rows.

Static SELECT statements

For a static SELECT statement (one embedded in an SQL program), an INTO clause must be specified before the FROM clause.

The INTO clause names the host variables (variables in your program used to contain retrieved column values). The value of the first result column specified in the SELECT clause is put into the first host variable named in the INTO clause; the second value is put into the second host variable, and so on.

The result table for a SELECT INTO should contain just one row. For example, each row in the CORPDATA.EMPLOYEE table has a unique EMPNO (employee number) column. The result of a SELECT INTO statement for this table, if the WHERE clause contains an equal comparison on the EMPNO column, will be exactly one row (or no rows). Finding more than one row is an error, but one row is still returned. You can control which row will be returned in this error condition by specifying the ORDER BY clause. If you use the ORDER BY clause, the first row in the result table is returned.

If you want more than one row to be the result of a SELECT INTO statement, use a DECLARE CURSOR statement to select the rows, followed by a FETCH statement to move the column values into host variables one or many rows at a time.

When using the select-statement in an application program, list the column names to give your program more data independence. There are two reasons for this:

1. When you look at the source code statement, you can easily see the one-to-one correspondence between the column names in the SELECT clause and the host variables named in the INTO clause.
2. If a column is added to a table or view you access and you use "SELECT * ...," and you create the program again from source, the INTO clause does not have a matching host variable named for the new column. The extra column causes you to get a warning (not an error) in the SQLCA (SQLWARN3 will contain a "W"). When using the GET DIAGNOSTICS statement, the RETURNED_SQLSTATE item will have a value of '01503'.

Related reference

[Using a cursor](#)

When SQL runs a SELECT statement, the resulting rows comprise the result table. A cursor provides a way to access a result table.

Handling null values

A null value indicates the absence of a column value in a row. A null value is an unknown value; it is not the same as zero or all blanks.

Null values can be used as a condition in the WHERE and HAVING clauses. For example, a WHERE clause can specify a column that, for some rows, contains a null value. A basic comparison predicate using a column that contains null values does not select a row that has a null value for the column. This is because a null value is not less than, equal to, or greater than the value specified in the condition. The IS NULL predicate is used to check for null values. To select the values for all rows that contain a null value for the manager number, you can specify:

```
SELECT DEPTNO, DEPTNAME, ADMRDEPT
FROM CORPDATA.DEPARTMENT
WHERE MGRNO IS NULL
```

The result follows.

DEPTNO	DEPTNAME	ADMRDEPT
D01	DEVELOPMENT CENTER	A00
F22	BRANCH OFFICE F2	E01
G22	BRANCH OFFICE G2	E01
H22	BRANCH OFFICE H2	E01
I22	BRANCH OFFICE I2	E01
J22	BRANCH OFFICE J2	E01

To get the rows that do not have a null value for the manager number, you can change the WHERE clause like this:

```
WHERE MGRNO IS NOT NULL
```

Another predicate that is useful for comparing values that can contain the NULL value is the DISTINCT predicate. Comparing two columns using a normal equal comparison (COL1 = COL2) will be true if both columns contain an equal non-null value. If both columns are null, the result will be false because null is never equal to any other value, not even another null value. Using the DISTINCT predicate, null values are considered equal. So COL1 is NOT DISTINCT from COL2 will be true if both columns contain an equal non-null value and also when both columns are the null value.

For example, suppose that you want to select information from two tables that contain null values. The first table T1 has a column C1 with the following values.

C1
2
1
null

The second table T2 has a column C2 with the following values.

C2
2
null

Run the following SELECT statement:

```
SELECT *  
FROM T1, T2  
WHERE C1 IS DISTINCT FROM C2
```

The result follows.

C1	C2
1	2
1	-
2	-
-	2

For more information about the use of null values, see the [Db2 for i SQL reference](#) topic collection.

Special registers in SQL statements

You can specify certain special registers in SQL statements. A *special register*, for example, CURRENT DATE, contains information that can be referenced in SQL statements.

For locally run SQL statements, the special registers and their contents are shown in the following table.

Special registers	Contents
CURRENT CLIENT_ACCTNG CLIENT ACCTNG	The accounting string for the client connection.
CURRENT CLIENT_APPLNAME CLIENT APPLNAME	The application name for the client connection.
CURRENT CLIENT_PROGRAMID CLIENT PROGRAMID	The program ID for the client connection.
CURRENT CLIENT_USERID CLIENT USERID	The client user ID for the client connection.
CURRENT CLIENT_WRKSTNNAME CLIENT WRKSTNNAME	The workstation name for the client connection.
CURRENT DATE CURRENT_DATE	The current date.
CURRENT DEBUG MODE	The debug mode to be used when creating or altering routines.
CURRENT DECFLOAT ROUNDING MODE	The rounding mode to be used when working with decimal floating point values.
CURRENT DEGREE	The number of tasks the database manager should run in parallel.
CURRENT IMPLICIT XMLPARSE OPTION	The whitespace handling options to be used for XML data when implicitly parsed without validation.

Special registers	Contents
CURRENT PATH CURRENT_PATH CURRENT FUNCTION PATH	The SQL path used to resolve unqualified data type names, procedure names, and function names in dynamically prepared SQL statements.
CURRENT SCHEMA	The schema name used to qualify unqualified database object references where applicable in dynamically prepared SQL statements.
CURRENT SERVER CURRENT_SERVER	The name of the relational database currently being used.
CURRENT TEMPORAL SYSTEM_TIME	The timestamp to use when querying a system_period temporal table.
CURRENT TIME CURRENT_TIME	The current time.
CURRENT TIMESTAMP CURRENT_TIMESTAMP	The current date and time in timestamp format.
CURRENT TIMEZONE CURRENT_TIMEZONE	A duration of time that links local time to Universal Time Coordinated (UTC) using the formula: <div style="background-color: #f0f0f0; padding: 5px; margin: 5px 0;"> $\text{local time} - \text{CURRENT_TIMEZONE} = \text{UTC}$ </div> It is taken from the system value QUTCOFFSET.
CURRENT USER CURRENT_USER	The primary authorization identifier of the job.
SESSION_USER USER	The runtime authorization identifier (user profile) of the job.
SYSTEM_USER	The authorization identifier (user profile) of the user connected to the database.

If a single statement contains more than one reference to any of CURRENT DATE, CURRENT TIME, or CURRENT TIMESTAMP special registers, or the CURDATE, CURTIME, or NOW scalar functions, all values are based on a single clock reading.

For remotely run SQL statements, the values for special registers are determined at the remote system.

When a query over a distributed table references a special register, the contents of the special register on the system that requests the query are used. For more information about distributed tables, see the [DB2 Multisystem](#) topic collection.

Casting data types

Sometimes you need to cast or change the type of an expression to a different data type or to the same data type with a different length, precision, or scale.

For example, if you want to compare two columns of different types, such as a user-defined type based on a character and an integer, you can change the character to an integer or the integer to a character to make the comparison possible. A data type that can be changed to another data type is *castable* from the source data type to the target data type.

You can use cast functions or CAST specification to explicitly cast a data type to another data type. For example, if you have a column of dates (BIRTHDATE) defined as DATE and want to cast the column data type to CHARACTER with a fixed length of 10, enter the following:

```
SELECT CHAR (BIRTHDATE,USA)
FROM CORPDATA.EMPLOYEE
```

You can also use the CAST specification to cast data types directly:

```
SELECT CAST(BIRTHDATE AS CHAR(10))
FROM CORPDATA.EMPLOYEE
```

Related reference

[Casting between data types](#)

Date, time, and timestamp data types

Date, time, and timestamp are data types that are represented in an internal form not seen by an SQL user.

Date, time, and timestamp can be represented by character string values and assigned to character string variables. The database manager recognizes the following as date, time, and timestamp values:

- A value returned by the DATE, TIME, or TIMESTAMP scalar function.
- A value returned by the CURRENT DATE, CURRENT TIME, or CURRENT TIMESTAMP special register.
- A value of a character string in the ANSI/ISO standard date, time, or timestamp format, for example, **DATE** '1950-01-01'.
- A character string when it is an operand of an arithmetic expression or a comparison *and* the other operand is a date, time, or timestamp. For example, in the predicate:

```
... WHERE HIREDATE < '1950-01-01'
```

if HIREDATE is a date column, the character string '1950-01-01' is interpreted as a date.

- A character string variable or constant used to set a date, time, or timestamp column in either the SET clause of an UPDATE statement, or the VALUES clause of an INSERT statement.

When the CURRENT TIMESTAMP special register or a variable with the TIMESTAMP data type is used with a precision greater than 6, the timestamp value is a combination of the system clock and uniqueness bits. The uniqueness bits are assigned in an ascending order. Therefore, comparison operations for timestamps with any precision will represent an accurate order of when the timestamps were assigned.

Related reference

[Data types](#)

Specifying current date and time values

You can specify a current date, time, or timestamp in an expression by using one of these special registers: CURRENT DATE, CURRENT TIME, and CURRENT TIMESTAMP.

The value of each is based on a time-of-day clock reading obtained during the running of the statement. Multiple references to CURRENT DATE, CURRENT TIME, or CURRENT TIMESTAMP within the same SQL statement use the same value. The following statement returns the age (in years) of each employee in the EMPLOYEE table when the statement is run:

```
SELECT YEAR(CURRENT DATE - BIRTHDATE)
FROM CORPDATA.EMPLOYEE
```

The CURRENT TIMEZONE special register allows a local time to be converted to Universal Time Coordinated (UTC). For example, if you have a table named DATETIME that contains a time column type with a name of STARTT, and you want to convert STARTT to UTC, you can use the following statement:

```
SELECT STARTT - CURRENT TIMEZONE
FROM DATETIME
```

Date/time arithmetic

Addition and subtraction are the only arithmetic operators applicable to date, time, and timestamp values.

You can increment and decrement a date, time, or timestamp by a duration; or subtract a date from a date, a time from a time, or a timestamp from a timestamp.

Related reference

[Datetime arithmetic in SQL](#)

Row change expressions

The ROW CHANGE TIMESTAMP and ROW CHANGE TOKEN expressions can be used to determine when a row was last changed.

To use a ROW CHANGE TIMESTAMP expression for a table, the table must be defined to have a row change timestamp column.

The following query can find all the orders that are at least four weeks old and can list when they were last modified:

```
SELECT ORDERNO, ROW CHANGE TIMESTAMP FOR ORDERS
FROM ORDERS
WHERE ORDER_DATE < CURRENT DATE - 4 WEEKS
```

The ROW CHANGE TOKEN expression can be used for both tables that have a row change timestamp and tables that do not. It represents a modification point for a row. If a table has a row change timestamp, it is derived from the timestamp. If a table does not have a row change timestamp, it is based on an internal modification time that is not row-based, so it is not as accurate as for a table that has a row change timestamp.

Handling duplicate rows

When SQL evaluates a select-statement, several rows might qualify to be in the result table, depending on the number of rows that satisfy the search condition of the select-statement. Some of the rows in the result table might be duplicate.

You can specify that you do not want any duplicates by using the DISTINCT keyword, followed by the list of expressions:

```
SELECT DISTINCT JOB, SEX
...
```

DISTINCT means that you want to select only the unique rows. If a selected row duplicates another row in the result table, the duplicate row is ignored (it is not put into the result table). For example, suppose you want a list of employee job codes. You do not need to know which employee has what job code. Because it is probable that several people in a department have the same job code, you can use DISTINCT to ensure that the result table has only unique values.

The following example shows how to do this:

```
SELECT DISTINCT JOB
FROM CORPDATA.EMPLOYEE
WHERE WORKDEPT = 'D11'
```

The result is two rows.

JOB

DESIGNER

MANAGER

If you do not include `DISTINCT` in a `SELECT` clause, you might find duplicate rows in your result, because SQL returns the `JOB` column's value for each row that satisfies the search condition. Null values are treated as duplicate rows for `DISTINCT`.

If you include `DISTINCT` in a `SELECT` clause and you also include a shared-weight sort sequence, fewer values might be returned. The sort sequence causes values that contain the same characters to be weighted the same. If 'MGR', 'Mgr', and 'mgr' are all in the same table, only one of these values is returned.

Related concepts

[Sort sequences and normalization in SQL](#)

A sort sequence defines how characters in a character set relate to each other when they are compared or ordered. Normalization allows you to compare strings that contain combining characters.

Defining complex search conditions

In addition to the basic comparison predicates, such as `=` and `>`, a search condition can contain any of these predicates: `BETWEEN`, `IN`, `EXISTS`, `IS NULL`, and `LIKE`.

A search condition can include a scalar `fullselect`.

For character, or UCS-2 or UTF-16 graphic column predicates, the sort sequence is applied to the operands before evaluation of the predicates for `BETWEEN`, `IN`, `EXISTS`, and `LIKE` clauses.

You can also perform multiple search conditions.

- **BETWEEN ... AND ...** is used to specify a search condition that is satisfied by any value that falls on or between two other values. For example, to find all employees who were hired in 1987, you can use this:

```
... WHERE HIREDATE BETWEEN '1987-01-01' AND '1987-12-31'
```

The `BETWEEN` keyword is inclusive. A more complex, but explicit, search condition that produces the same result is:

```
... WHERE HIREDATE >= '1987-01-01' AND HIREDATE <= '1987-12-31'
```

- **IN** says you are interested in rows in which the value of the specified expression is among the values you listed. For example, to find the names of all employees in departments A00, C01, and E21, you can specify:

```
... WHERE WORKDEPT IN ('A00', 'C01', 'E21')
```

- **EXISTS** says you are interested in testing for the existence of certain rows. For example, to find out if there are any employees that have a salary greater than 60000, you can specify:

```
EXISTS (SELECT * FROM EMPLOYEE WHERE SALARY > 60000)
```

- **IS NULL** says that you are interested in testing for null values. For example, to find out if there are any employees without a phone listing, you can specify:

```
... WHERE EMPLOYEE.PHONE IS NULL
```

- **LIKE** says you are interested in rows in which an expression is similar to the value you supply. When you use `LIKE`, SQL searches for a character string similar to the one you specify. The degree of similarity is determined by two special characters used in the string that you include in the search condition:

— An underline character stands for any single character.

%

A percent sign stands for an unknown string of 0 or more characters. If the percent sign starts the search string, then SQL allows 0 or more character(s) to precede the matching value in the column. Otherwise, the search string must begin in the first position of the column.

Note: If you are operating on MIXED data, the following distinction applies: an SBCS underline character refers to one SBCS character. No such restriction applies to the percent sign; that is, a percent sign refers to any number of SBCS or DBCS characters. See the [Db2 for i SQL reference](#) topic collection for more information about the LIKE predicate and MIXED data.

Use the underline character or percent sign either when you do not know or do not care about all the characters of the column's value. For example, to find out which employees live in Minneapolis, you can specify:

```
... WHERE ADDRESS LIKE '%MINNEAPOLIS%'
```

SQL returns any row with the string MINNEAPOLIS in the ADDRESS column, no matter where the string occurs.

In another example, to list the towns whose names begin with 'SAN', you can specify:

```
... WHERE TOWN LIKE 'SAN%'
```

If you want to find any addresses where the street name isn't in your master street name list, you can use an expression in the LIKE expression. In this example, the STREET column in the table is assumed to be upper case.

```
... WHERE UCASE (:address_variable) NOT LIKE '%|STREET|'|'
```

If you want to search for a character string that contains either the underscore or percent character, use the ESCAPE clause to specify an escape character. For example, to see all businesses that have a percent in their name, you can specify:

```
... WHERE BUSINESS_NAME LIKE '%@%' ESCAPE '@'
```

The first and last percent characters in the LIKE string are interpreted as the normal LIKE percent characters. The combination '@%' is taken as the actual percent character.

Related concepts

[Using subqueries](#)

You can use subqueries in a search condition as another way to select data. Subqueries can be used anywhere an expression can be used.

[Sort sequences and normalization in SQL](#)

A sort sequence defines how characters in a character set relate to each other when they are compared or ordered. Normalization allows you to compare strings that contain combining characters.

Related reference

[Specifying a search condition using the WHERE clause](#)

The WHERE clause specifies a search condition that identifies the row or rows that you want to retrieve, update, or delete.

[Expressions in the WHERE clause](#)

An expression in a WHERE clause names or specifies something that you want to compare to something else.

[Predicates](#)

Special considerations for LIKE

Here are some considerations for using the LIKE predicate.

- When host variables are used in place of string constants in a search pattern, you should consider using varying length host variables. This allows you to:

- Assign previously used string constants to host variables without any changes.
- Obtain the same selection criteria and results as if a string constant were used.
- When fixed-length host variables are used in place of string constants in a search pattern, you should ensure that the value specified in the host variable matches the pattern previously used by the string constants. All characters in a host variable that are not assigned a value are initialized with a blank.

For example, if you do a search using the string pattern 'ABC%' in a varying length host variable, these are some of the values that can be returned:

```
'ABCD'      'ABCDE'    'ABCxxx'    'ABC '
```

However, if you do a search using the search pattern 'ABC%' contained in a host variable with a fixed length of 10, these values can be returned, assuming that the column has a length of 12:

```
'ABCDE'      'ABCD'      'ABCxxx'    'ABC'
```

Note: All returned values start with 'ABC' and end with at least 6 blanks. Blanks are used because the last 6 characters in the host variable are not assigned a specific value.

If you want to do a search using a fixed-length host variable where the last 7 characters can be anything, search for 'ABC%%%%%%%%'. These are some of the values that can be returned:

```
'ABCDEFGHIJ' 'ABCXXXXXXX' 'ABCDE'      'ABCDD'
```

Multiple search conditions within a WHERE clause

You can qualify your request further by coding a search condition that includes several predicates.

The search condition you specify can contain any of the comparison operators or the predicates BETWEEN, DISTINCT, IN, LIKE, EXISTS, IS NULL, and IS NOT NULL.

You can combine any two predicates with AND and OR. In addition, you can use the NOT keyword to specify that the search condition that you want is the negated value of the specified search condition. A WHERE clause can have as many predicates as you want.

- **AND** says that, for a row to qualify, the row must satisfy both predicates of the search condition. For example, to find out which employees in department D21 were hired after December 31, 1987, specify:

```
... WHERE WORKDEPT = 'D21' AND HIREDATE > '1987-12-31'
```

- **OR** says that, for a row to qualify, the row can satisfy the condition set by either or both predicates of the search condition. For example, to find out which employees are in either department C01 or D11, you can specify :

```
... WHERE WORKDEPT = 'C01' OR WORKDEPT = 'D11'
```

Note: You can also use IN to specify this request: WHERE WORKDEPT IN ('C01', 'D11').

- **NOT** says that, to qualify, a row must not meet the criteria set by the search condition or predicate that follows the NOT. For example, to find all employees in the department E11 except those with a job code equal to analyst, you can specify:

```
... WHERE WORKDEPT = 'E11' AND NOT JOB = 'ANALYST'
```

When SQL evaluates search conditions that contain these connectors, it does so in a specific order. SQL first evaluates the NOT clauses, next evaluates the AND clauses, and then the OR clauses.

You can change the order of evaluation by using parentheses. The search conditions enclosed in parentheses are evaluated first. For example, to select all employees in departments E11 and E21 who have education levels greater than 12, you can specify:

```
...
WHERE EDLEVEL > 12 AND
      (WORKDEPT = 'E11' OR WORKDEPT = 'E21')
```

The parentheses determine the meaning of the search condition. In this example, you want all rows that have a:

- WORKDEPT value of E11 or E21, and
- EDLEVEL value greater than 12

If you did not use parentheses:

```
...
WHERE EDLEVEL > 12 AND WORKDEPT = 'E11'
OR WORKDEPT = 'E21'
```

Your result is different. The selected rows are rows that have:

- WORKDEPT = E11 and EDLEVEL > 12, or
- WORKDEPT = E21, regardless of the EDLEVEL value

If you are combining multiple equal comparisons, you can write the predicate with the ANDs as shown in the following example:

```
...
WHERE WORKDEPT = 'E11' AND EDLEVEL = 12 AND JOB = 'CLERK'
```

You can also compare two lists, for example:

```
...
WHERE (WORKDEPT, EDLEVEL, JOB) = ('E11', 12, 'CLERK')
```

When two lists are used, the first item in the first list is compared to the first item in the second list, and so on through both lists. Thus, each list must contain the same number of entries. Using lists is identical to writing the query with AND. Lists can only be used with the equal and not equal comparison operators.

Related reference

[Specifying a search condition using the WHERE clause](#)

The WHERE clause specifies a search condition that identifies the row or rows that you want to retrieve, update, or delete.

Using OLAP specifications

Online analytical processing (OLAP) specifications provide the ability to return ranking, row numbering, and other aggregate function information as a scalar value in a query result.

Example: Ranking and row numbering

Suppose that you want a list of the top 10 salaries along with their ranking. The following query generates the ranking number for you:

```
SELECT EMPNO, SALARY,
       RANK() OVER(ORDER BY SALARY DESC),
       DENSE_RANK() OVER(ORDER BY SALARY DESC),
       ROW_NUMBER() OVER(ORDER BY SALARY DESC)
FROM EMPLOYEE
FETCH FIRST 10 ROWS ONLY
```

This query returns the following information.

Table 12. Results of the previous query

EMPNO	SALARY	RANK	DENSE_RANK	ROW_NUMBER
000010	52,750.00	1	1	1
000110	46,500.00	2	2	2
200010	46,500.00	2	2	3
000020	41,250.00	4	3	4
000050	40,175.00	5	4	5
000030	38,250.00	6	5	6
000070	36,170.00	7	6	7
000060	32,250.00	8	7	8
000220	29,840.00	9	8	9
200220	29,840.00	9	8	10

In this example, the SALARY descending order with the top 10 returned. The RANK column shows the relative ranking of each salary. Notice that there are two rows with the same salary at position 2. Each of those rows is assigned the same rank value. The following row is assigned the value of 4. RANK returns a value for a row that is one more than the total number of rows that precede that row. There are gaps in the numbering sequence whenever there are duplicates.

In contrast, the DENSE_RANK column shows a value of 3 for the row directly after the duplicate rows. DENSE_RANK returns a value for a row that is one more than the number of distinct row values that precede it. There will never be gaps in the numbering sequence.

ROW_NUMBER returns a unique number for each row. For rows that contain duplicate values according to the specified ordering, the assignment of a row number is arbitrary; the row numbers could be assigned in a different order for the duplicate rows when the query is run another time.

Example: Ranking groups

Suppose that you want to find out which department has the highest average salary and the quantile of the average salary for each department. The following query groups the data by department, determines the average salary for each department, ranks the resulting averages, and shows a quantile for the average salary.

```
SELECT WORKDEPT, INT(AVG(SALARY)) AS AVERAGE,
       RANK() OVER(ORDER BY AVG(SALARY) DESC) AS AVG_SALARY,
       NTILE(3) OVER(ORDER BY AVG(SALARY) DESC) AS QUANTILE
FROM EMPLOYEE
GROUP BY WORKDEPT
```

This query returns the following information.

Table 13. Results of previous query

WORKDEPT	AVERAGE	AVG_SALARY	QUANTILE
B01	41,250	1	1
A00	40,850	2	1
E01	40,175	3	1
C01	29,722	4	2
D21	25,668	5	2

Table 13. Results of previous query (continued)

WORKDEPT	AVERAGE	AVG_SALARY	QUANTILE
D11	25,147	6	2
E21	24,086	7	3
E11	21,020	8	3

In this example, the NTILE function has an argument of 3, meaning that the results are to be grouped into 3 equal-sized sets. Since the result set is not evenly divisible by the number of quantiles, an additional row is included in each of the two lowest number quantiles.

Example: Ranking within a department

Suppose that you want a list of employees along with how their bonus ranks within their department. Using the PARTITION BY clause, you can specify groups that are to be numbered separately.

```
SELECT LASTNAME, WORKDEPT, BONUS,
       DENSE_RANK() OVER(PARTITION BY WORKDEPT ORDER BY BONUS DESC)
       AS BONUS_RANK_IN_DEPT
FROM EMPLOYEE
WHERE WORKDEPT LIKE 'E%'
```

This query returns the following information.

Table 14. Results of the previous query

LASTNAME	WORKDEPT	BONUS	BONUS_RANK_IN_DEPT
GEYER	E01	800.00	1
HENDERSON	E11	600.00	1
SCHNEIDER	E11	500.00	2
SCHWARTZ	E11	500.00	2
SMITH	E11	400.00	3
PARKER	E11	300.00	4
SETRIGHT	E11	300.00	4
SPRINGER	E11	300.00	4
SPENSER	E21	500.00	1
LEE	E21	500.00	1
GOUNOT	E21	500.00	1
WONG	E21	500.00	1
ALONZO	E21	500.00	1
MENTA	E21	400.00	2

Example: Ranking and ordering by table expression results

Suppose that you want to find the top five employees whose salaries are the highest along with their department names. The department name is in the *department* table, so a join operation is needed.

Because ordering is already being done in the nested table expression, that ordering can also be used for determining the ROW_NUMBER value. The ORDER BY ORDER OF *table* clause is used to do this.

```
SELECT ROW_NUMBER() OVER(ORDER BY ORDER OF EMP),
       EMPNO, SALARY, DEPTNO, DEPTNAME
FROM (SELECT EMPNO, WORKDEPT, SALARY
      FROM EMPLOYEE
      ORDER BY SALARY DESC
      FETCH FIRST 5 ROWS ONLY) EMP,
      DEPARTMENT
WHERE DEPTNO = WORKDEPT
```

This query returns the following information.

Table 15. Results of the previous query

ROW_NUMBER	EMPNO	SALARY	DEPTNO	DEPTNAME
1	000010	52,750.00	A00	SPIFFY COMPUTER SERVICE DIV.
2	000110	46,500.00	A00	SPIFFY COMPUTER SERVICE DIV.
3	200010	46,500.00	A00	SPIFFY COMPUTER SERVICE DIV.
4	000020	41,250.00	B01	PLANNING
5	000050	40,175.00	E01	SUPPORT SERVICES

Example: Using OLAP Aggregates and CUME_DIST

Suppose that you want to find the rolling sum of the salaries for employees in department D11 and also the distribution of the salary.

```
SELECT ROW_NUMBER() OVER() AS ROW, LASTNAME, SALARY,
       SUM(SALARY) OVER(ORDER BY SALARY
                       RANGE BETWEEN UNBOUNDED PRECEDING AND CURRENT ROW) AS ROLLING_TOTAL_RANGE,
       SUM(SALARY) OVER(ORDER BY SALARY
                       ROWS BETWEEN UNBOUNDED PRECEDING AND CURRENT ROW) AS ROLLING_TOTAL_ROWS,
       DECIMAL(CUME_DIST() OVER (ORDER BY SALARY),4,3) AS DISTRIBUTION
FROM EMPLOYEE
WHERE WORKDEPT = 'D11'
ORDER BY SALARY
```

This query returns the following information.

Table 16. Results of the previous query

ROW	LASTNAME	SALARY	ROLLING_TOTAL_RANGE	ROLLING_TOTAL_ROWS	DISTRIBUTION
1	JONES	18,270.00	18,270.00	18,270.00	.091
2	WALKER	20,450.00	38,720.00	38,720.00	.182
3	SCOUTTEN	21,340.00	60,060.00	60,060.00	.273
4	PIANKA	22,250.00	82,310.00	82,310.00	.364
5	YOSHIMURA	24,680.00	131,670.00	106,990.00	.545
6	YAMAMOTO	24,680.00	131,670.00	131,670.00	.545

Table 16. Results of the previous query (continued)

ROW	LASTNAME	SALARY	ROLLING_TOTAL_RANGE	ROLLING_TOTAL_ROWS	DISTRIBUTION
7	ADAMSON	25,280.00	156,950.00	156,950.00	.636
8	BROWN	27,740.00	184,690.00	184,690.00	.727
9	LUTZ	29,840.00	244,370.00	214,530.00	.909
10	JOHN	29,840.00	244,370.00	244,370.00	.909
11	STERN	32,250.00	276,620.00	276,620.00	1.000

This example shows two ways of defining the window to be used for calculating the value of a group.

The first way to define the window is with RANGE, which defines a group for all rows that have the same order by value. Row numbers 5 and 6 have the same salary value, so they are treated as a group. Their salaries are summed together and added to the previous total to generate the same value for each of the rows as seen in the ROLLING_TOTAL_RANGE column.

The second way to define the window is with ROWS, which treats each row as a group. In the ROLLING_TOTAL_ROWS column each row shows the sum calculated up to and including the current row. For rows that have the same salary value, such as rows 5 and 6, the order in which they are returned is not defined.

RANGE BETWEEN UNBOUNDED PRECEDING AND CURRENT ROW is the default aggregation group and could be omitted from the ROLLING_TOTAL_RANGE specification.

An ORDER BY is specified for the entire query to guarantee the rows are returned ordered.

Example: Using a RANGE windowing specification

Suppose you want to further analyze the salaries for DEPT D11.

This example groups salaries together by windowing, using a range to work with salary values 1000 less than or greater than each row's salary. It also returns which salary is the first value and the last value for the group used to calculate the sum.

```
SELECT LASTNAME, SALARY,
       SUM(SALARY) OVER(ORDER BY SALARY AS ROLLING_TOTAL,
                       SUM(SALARY) OVER(ORDER BY SALARY
                                           RANGE BETWEEN 1000 PRECEDING AND 1000 FOLLOWING) AS WINDOWED_TOTAL,
       FIRST_VALUE(SALARY) OVER(ORDER BY SALARY
                                 RANGE BETWEEN 1000 PRECEDING AND 1000 FOLLOWING),
       LAST_VALUE(SALARY) OVER(ORDER BY SALARY
                                RANGE BETWEEN 1000 PRECEDING AND 1000 FOLLOWING)
FROM EMPLOYEE
WHERE WORKDEPT = 'D11'
ORDER BY SALARY
```

This query returns the following information.

Table 17. Results of the previous query

LASTNAME	SALARY	ROLLING_TOTAL	WINDOWED_TOTAL	FIRST_VALUE	LAST_VALUE
JONES	18,270.00	18,270.00	18,270.00	18,270.00	18,270.00
WALKER	20,450.00	38,720.00	41,790.00	20,450.00	21,340.00
SCOUTTEN	21,340.00	60,060.00	64,040.00	20,450.00	22,250.00

Table 17. Results of the previous query (continued)

LASTNAME	SALARY	ROLLING_TOTAL	WINDOWED_TOTAL	FIRST_VALUE	LAST_VALUE
PIANKA	22,250.00	82,310.00	43,590.00	21,340.00	25,280.00
YOSHIMURA	24,680.00	131,670.00	74,640.00	24,680.00	25,280.00
YAMAMOTO	24,680.00	131,670.00	74,640.00	24,680.00	25,280.00
ADAMSON	25,280.00	156,950.00	74,640.00	24,680.00	25,280.00
BROWN	27,740.00	184,690.00	27,740.00	27,740.00	27,740.00
LUTZ	29,840.00	244,370.00	59,680.00	29,840.00	29,840.00
JOHN	29,840.00	244,370.00	59,680.00	29,840.00	29,840.00
STERN	32,250.00	276,620.00	32,250.00	32,250.00	32,250.00

For each employee, a group is defined that contains all other employees in department D11 with salaries that fall within a range of 1000 below (PRECEDING) or 1000 above (FOLLOWING) that employee's salary. The WINDOWED_TOTAL column returns the sum of all the salaries in that group. The FIRST_VALUE column returns the lowest salary value that is part of the group. The LAST_VALUE column returns the highest salary value that is part of the group. Any employee that has a salary that is more than 1000 from the closest other salary is its own group.

An ORDER BY is specified for the entire query to guarantee the rows are returned ordered.

Example: Using a ROWS windowing specification

This example groups salaries together by windowing, using ROWS to work with salary values that are one row before and after each employee salary. The average of the 3 rows is returned.

```
SELECT LASTNAME, SALARY,
       DECIMAL(AVG(SALARY) OVER(ORDER BY SALARY
                               ROWS BETWEEN 1 PRECEDING AND 1 FOLLOWING),2) AS AVG_SALARY
FROM EMPLOYEE
WHERE WORKDEPT = 'D11'
ORDER BY SALARY
```

This query returns the following information.

Table 18. Results of the previous query

LASTNAME	SALARY	AVG_SALARY
JONES	18,270.00	19,360.00
WALKER	20,450.00	20,020.00
SCOUTTEN	21,340.00	21,346.66
PIANKA	22,250.00	22,756.66
YOSHIMURA	24,680.00	23,870.00
YAMAMOTO	24,680.00	24,880.00
ADAMSON	25,280.00	25,900.00
BROWN	27,740.00	27,620.00
LUTZ	29,840.00	29,140.00
JOHN	29,840.00	30,643.33

Table 18. Results of the previous query (continued)

LASTNAME	SALARY	AVG_SALARY
STERN	32,250.00	31,045.00

Joining data from more than one table

Sometimes the information you want to see is not in a single table. To form a row of the result table, you might want to retrieve some column values from one table and some column values from another table. You can retrieve and join column values from two or more tables into a single row.

Several different types of joins are supported by Db2 for i: inner join, left outer join, right outer join, left exception join, right exception join, and cross join.

Usage notes on join operations

When you join two or more tables, consider the following items:

- If there are common column names, you must qualify each common name with the name of the table (or a correlation name). Column names that are unique do not need to be qualified. However, the USING clause can be used in a join to allow you to identify columns that exist in both tables without specifying table names.
- If you do not list the column names you want, but instead use SELECT *, SQL returns rows that consist of all the columns of the first table, followed by all the columns of the second table, and so on.
- You must be authorized to select rows from each table or view specified in the FROM clause.
- The sort sequence is applied to all character, or UCS-2 or UTF-16 graphic columns being joined.

Inner join

An inner join returns only the rows from each table that have matching values in the join columns. Any rows that do not have a match between the tables do not appear in the result table.

With an inner join, column values from one row of a table are combined with column values from another row of another (or the same) table to form a single row of data. SQL examines both tables specified for the join to retrieve data from all the rows that meet the search condition for the join. There are two ways of specifying an inner join: using the JOIN syntax, and using the WHERE clause.

Suppose you want to retrieve the employee numbers, names, and project numbers for all employees that are responsible for a project. In other words, you want the EMPNO and LASTNAME columns from the CORPDATA.EMPLOYEE table and the PROJNO column from the CORPDATA.PROJECT table. Only employees with last names starting with 'S' or later should be considered. To find this information, you need to join the two tables.

Inner join using the JOIN syntax

To use the inner join syntax, both of the tables you are joining are listed in the FROM clause, along with the join condition that applies to the tables.

The join condition is specified after the ON keyword and determines how the two tables are to be compared to each other to produce the join result. The condition can be any comparison operator; it does not need to be the equal operator. Multiple join conditions can be specified in the ON clause separated by the AND keyword. Any additional conditions that do not relate to the actual join are specified in either the WHERE clause or as part of the actual join in the ON clause.

```
SELECT EMPNO, LASTNAME, PROJNO
FROM CORPDATA.EMPLOYEE INNER JOIN CORPDATA.PROJECT
ON EMPNO = RESPEMP
WHERE LASTNAME > 'S'
```

In this example, the join is done on the two tables using the EMPNO and RESPEMP columns from the tables. Since only employees that have last names starting with at least 'S' are to be returned, this additional condition is provided in the WHERE clause.

This query returns the following output.

EMPNO	LASTNAME	PROJNO
000250	SMITH	AD3112
000060	STERN	MA2110
000100	SPENSER	OP2010
000020	THOMPSON	PL2100

Inner join using the WHERE clause

To use the WHERE clause to perform the same join as you perform using the INNER JOIN syntax, enter both the join condition and the additional selection condition in the WHERE clause.

The tables to be joined are listed in the FROM clause, separated by commas.

```
SELECT EMPNO, LASTNAME, PROJNO
FROM CORPDATA.EMPLOYEE, CORPDATA.PROJECT
WHERE EMPNO = RESPEMP
AND LASTNAME > 'S'
```

This query returns the same output as the previous example.

Joining data with the USING clause

You can use the USING clause for a shorthand way of defining join conditions. The USING clause is equivalent to a join condition where each column from the left table is compared to a column with the same name in the right table.

For example, look at the USING clause in this statement:

```
SELECT EMPNO, ACSTDATE
FROM CORPDATA.PROJECT INNER JOIN CORPDATA.EMPPROJECT
USING (PROJNO, ACTNO)
WHERE ACSTDATE > '1982-12-31';
```

The syntax in this statement is valid and equivalent to the join condition in the following statement:

```
SELECT EMPNO, ACSTDATE
FROM CORPDATA.PROJECT INNER JOIN CORPDATA.EMPPROJECT
ON CORPDATA.PROJECT.PROJNO = CORPDATA.EMPPROJECT.PROJNO AND
CORPDATA.PROJECT.ACTNO = CORPDATA.EMPPROJECT.ACTNO
WHERE ACSTDATE > '1982-12-31';
```

Left outer join

A left outer join returns all the rows that an inner join returns plus one row for each of the other rows in the first table that do not have a match in the second table.

Suppose you want to find all employees and the projects they are currently responsible for. You want to see those employees that are not currently in charge of a project as well. The following query will return a list of all employees whose names are greater than 'S', along with their assigned project numbers.

```
SELECT EMPNO, LASTNAME, PROJNO
FROM CORPDATA.EMPLOYEE LEFT OUTER JOIN CORPDATA.PROJECT
ON EMPNO = RESPEMP
WHERE LASTNAME > 'S'
```

The result of this query contains some employees that do not have a project number. They are listed in the query, but have the null value returned for their project number.

EMPNO	LASTNAME	PROJNO
000020	THOMPSON	PL2100
000060	STERN	MA2110

EMPNO	LASTNAME	PROJNO
000100	SPENSER	OP2010
000170	YOSHIMURA	-
000180	SCOUTTEN	-
000190	WALKER	-
000250	SMITH	AD3112
000280	SCHNEIDER	-
000300	SMITH	-
000310	SETRIGHT	-
200170	YAMAMOTO	-
200280	SCHWARTZ	-
200310	SPRINGER	-
200330	WONG	-

Note: Using the RRN scalar function to return the relative record number for a column in the table on the right in a left outer join or exception join will return a value of 0 for the unmatched rows.

Right outer join

A right outer join returns all the rows that an inner join returns plus one row for each of the other rows in the second table that do not have a match in the first table. It is the same as a left outer join with the tables specified in the opposite order.

The query that was used as the left outer join example can be rewritten as a right outer join as follows:

```
SELECT EMPNO, LASTNAME, PROJNO
FROM CORPDATA.PROJECT RIGHT OUTER JOIN CORPDATA.EMPLOYEE
ON EMPNO = RESPEMP
WHERE LASTNAME > 'S'
```

The results of this query are identical to the results from the left outer join query.

Exception join

A left exception join returns only the rows from the first table that do **not** have a match in the second table.

Using the same tables as before, return those employees that are not responsible for any projects.

```
SELECT EMPNO, LASTNAME, PROJNO
FROM CORPDATA.EMPLOYEE EXCEPTION JOIN CORPDATA.PROJECT
ON EMPNO = RESPEMP
WHERE LASTNAME > 'S'
```

This join returns the following output.

EMPNO	LASTNAME	PROJNO
000170	YOSHIMURA	-
000180	SCOUTTEN	-
000190	WALKER	-
000280	SCHNEIDER	-
000300	SMITH	-

EMPNO	LASTNAME	PROJNO
000310	SETRIGHT	-
200170	YAMAMOTO	-
200280	SCHWARTZ	-
200310	SPRINGER	-
200330	WONG	-

An exception join can also be written as a subquery using the NOT EXISTS predicate. The previous query can be rewritten in the following way:

```
SELECT EMPNO, LASTNAME
FROM CORPDATA.EMPLOYEE
WHERE LASTNAME > 'S'
AND NOT EXISTS
  (SELECT * FROM CORPDATA.PROJECT
   WHERE EMPNO = RESPEMP)
```

The only difference in this query is that it cannot return values from the PROJECT table.

There is a right exception join, too, that works just like a left exception join but with the tables reversed.

Cross join

A cross join, also known as a Cartesian Product join, returns a result table where each row from the first table is combined with each row from the second table.

The number of rows in the result table is the product of the number of rows in each table. If the tables involved are large, this join can take a very long time.

A cross join can be specified in two ways: using the JOIN syntax or by listing the tables in the FROM clause separated by commas without using a WHERE clause to supply join criteria.

Suppose that the following tables exist.

Table 19. Table A

ACOL1	ACOL2
A1	AA1
A2	AA2
A3	AA3

Table 20. Table B

BCOL1	BCOL2
B1	BB1
B2	BB2

The following two select statements produce identical results.

```
SELECT * FROM A CROSS JOIN B
```

```
SELECT * FROM A, B
```

The result table for either of these SELECT statements looks like this.

ACOL1	ACOL2	BCOL1	BCOL2
A1	AA1	B1	BB1
A1	AA1	B2	BB2
A2	AA2	B1	BB1
A2	AA2	B2	BB2
A3	AA3	B1	BB1
A3	AA3	B2	BB2

Full outer join

Like the left and right outer joins, a full outer join returns matching rows from both tables. However, a full outer join also returns nonmatching rows from both tables.

Suppose that you want to find all employees and all of their projects. You want to see those employees that are not currently in charge of a project as well as any projects that do not have an employee assigned. The following query returns a list of all employees whose names are greater than 'S', along with their assigned project numbers:

```
SELECT EMPNO, LASTNAME, PROJNO
FROM CORPDATA.EMPLOYEE FULL OUTER JOIN CORPDATA.PROJECT
ON EMPNO = RESPEMP
WHERE LASTNAME > 'S'
```

Because there are no projects without an assigned employee, the query returns the same rows as a left outer join. Here are the results.

EMPNO	LASTNAME	PROJNO
000020	THOMPSON	PL2100
000060	STERN	MA2110
000100	SPENSER	OP2010
000170	YOSHIMURA	-
000180	SCOUTTEN	-
000190	WALKER	-
000250	SMITH	AD3112
000280	SCHNEIDER	-
000300	SMITH	-
000310	SETRIGHT	-
200170	YAMAMOTO	-
200280	SCHWARTZ	-
200310	SPRINGER	-
200330	WONG	-

Multiple join types in one statement

Sometimes you need to join more than two tables to produce the result that you want.

If you want to return all the employees, their department names, and the projects they are responsible for, if any, you need to join the EMPLOYEE table, the DEPARTMENT table, and the PROJECT table to get the information. The following example shows the query and the results:

```

SELECT EMPNO, LASTNAME, DEPTNAME, PROJNO
FROM CORPDATA.EMPLOYEE INNER JOIN CORPDATA.DEPARTMENT
ON WORKDEPT = DEPTNO
LEFT OUTER JOIN CORPDATA.PROJECT
ON EMPNO = RESPEMP
WHERE LASTNAME > 'S'

```

EMPNO	LASTNAME	DEPTNAME	PROJNO
000020	THOMPSON	PLANNING	PL2100
000060	STERN	MANUFACTURING SYSTEMS	MA2110
000100	SPENSER	SOFTWARE SUPPORT	OP2010
000170	YOSHIMURA	MANUFACTURING SYSTEMS	-
000180	SCOUTTEN	MANUFACTURING SYSTEMS	-
000190	WALKER	MANUFACTURING SYSTEMS	-
000250	SMITH	ADMINISTRATION SYSTEMS	AD3112
000280	SCHNEIDER	OPERATIONS	-
000300	SMITH	OPERATIONS	-
000310	SETRIGHT	OPERATIONS	-

Using table expressions

You can use table expressions to specify an intermediate result table.

Table expressions can be used in place of a view to avoid creating the view when general use of the view is not required. Table expressions consist of nested table expressions (also called derived tables) and common table expressions.

Nested table expressions are specified within parentheses in the FROM clause. For example, suppose you want a result table that shows the manager number, department number, and maximum salary for each department. The manager number is in the DEPARTMENT table, the department number is in both the DEPARTMENT and EMPLOYEE tables, and the salaries are in the EMPLOYEE table. You can use a table expression in the FROM clause to select the maximum salary for each department. You can also add a correlation name, T2, following the nested table expression to name the derived table. The outer select then uses T2 to qualify columns that are selected from the derived table, in this case MAXSAL and WORKDEPT. Note that the MAX(SALARY) column selected in the nested table expression must be named in order to be referenced in the outer select. The AS clause is used to do that.

```

SELECT MGRNO, T1.DEPTNO, MAXSAL
FROM CORPDATA.DEPARTMENT T1,
    (SELECT MAX(SALARY) AS MAXSAL, WORKDEPT
     FROM CORPDATA.EMPLOYEE E1
     GROUP BY WORKDEPT) T2
WHERE T1.DEPTNO = T2.WORKDEPT
ORDER BY DEPTNO

```

The result of the query follows.

MGRNO	DEPTNO	MAXSAL
000010	A00	52750.00
000020	B01	41250.00
000030	C01	38250.00
000060	D11	32250.00
000070	D21	36170.00

MGRNO	DEPTNO	MAXSAL
000050	E01	40175.00
000090	E11	29750.00
000100	E21	26150.00

Common table expressions can be specified before the full-select in a SELECT statement, an INSERT statement, or a CREATE VIEW statement. They can be used when the same result table needs to be shared in a full-select. Common table expressions are preceded with the keyword WITH.

For example, suppose you want a table that shows the minimum and maximum of the average salary of a certain set of departments. The first character of the department number has some meaning and you want to get the minimum and maximum for those departments that start with the letter 'D' and those that start with the letter 'E'. You can use a common table expression to select the average salary for each department. Again, you must name the derived table; in this case, the name is DT. You can then specify a SELECT statement using a WHERE clause to restrict the selection to only the departments that begin with a certain letter. Specify the minimum and maximum of column AVGSAL from the derived table DT. Specify a UNION to get the results for the letter 'E' and the results for the letter 'D'.

```
WITH DT AS (SELECT E.WORKDEPT AS DEPTNO, AVG(SALARY) AS AVGSAL
            FROM CORPDATA.DEPARTMENT D , CORPDATA.EMPLOYEE E
            WHERE D.DEPTNO = E.WORKDEPT
            GROUP BY E.WORKDEPT)
SELECT 'E', MAX(AVGSAL), MIN(AVGSAL) FROM DT
WHERE DEPTNO LIKE 'E%'
UNION
SELECT 'D', MAX(AVGSAL), MIN(AVGSAL) FROM DT
WHERE DEPTNO LIKE 'D%'
```

The result of the query follows.

	MAX(AVGSAL)	MIN(AVGSAL)
E	40175.00	21020.00
D	25668.57	25147.27

Suppose that you want to write a query against your ordering database that will return the top 5 items (in total quantity ordered) within the last 1000 orders from customers who also ordered item 'XXX'.

```
WITH X AS (SELECT ORDER_ID, CUST_ID
            FROM ORDERS
            ORDER BY ORD_DATE DESC
            FETCH FIRST 1000 ROWS ONLY),
Y AS (SELECT CUST_ID, LINE_ID, ORDER_QTY
       FROM X, ORDERLINE
       WHERE X.ORDER_ID = ORDERLINE.ORDER_ID)
SELECT LINE_ID
FROM (SELECT LINE_ID
       FROM Y
       WHERE Y.CUST_ID IN (SELECT DISTINCT CUST_ID
                           FROM Y
                           WHERE LINE.ID = 'XXX' )
       GROUP BY LINE_ID
       ORDER BY SUM(ORDER_QTY) DESC)
FETCH FIRST 5 ROWS ONLY
```

The first common table expression (X) returns the most recent 1000 order numbers. The result is ordered by the date in descending order and then only the first 1000 of those ordered rows are returned as the result table.

The second common table expression (Y) joins the most recent 1000 orders with the line item table and returns (for each of the 1000 orders) the customer, line item, and quantity of the line item for that order.

The derived table in the main select statement returns the line items for the customers who are in the top 1000 orders who ordered item XXX. The results for all customers who ordered XXX are then grouped by the line item and the groups are ordered by the total quantity of the line item.

Finally, the outer select selects only the first 5 rows from the ordered list that the derived table returned.

Using recursive queries

Some applications work with data that is recursive in nature. To query this type of data, you can use a hierarchical query or a recursive common table expression.

One example of recursive data is a Bill of Materials (BOM) application that works with the expansion of parts and its component subparts. For example, a chair might be made of a seat unit and a leg assembly. The seat unit might consist of a seat and two arms. Each of these parts can be further broken down into its subparts until there is a list of all the parts needed to build a chair.

Db2 for i provides two ways of defining a recursive query. The first one is called a hierarchical query which uses the CONNECT BY clause to define how a parent row is to be associated with its child rows. The second method is to use a recursive common table expression. This uses a common table expression to define the first, or seed, rows and then uses a UNION to define how the child rows are determined.

Each of these methods of defining a recursive query has advantages and disadvantages. The CONNECT BY syntax is much simpler to understand, but has fewer ways to derive the data in its query. CONNECT BY can be specified in any subselect anywhere in a query. A recursive common table expression has more options for how the union is defined to generate the child rows.

There are a couple of behavioral differences between a connect by recursive query and a recursive common table expression query. First, they differ in how they handle cyclic data. This difference is discussed in the examples. Second, connect by allows a sort among siblings. This is also shown in the examples. Finally, the two implementations differ in how the data is put on a queue that is used to implement the recursion. By default a recursive common table expression's data tends to come out in breadth first order, first in first out. With connect by, the order is designed to come out depth first. This means that rows in a recursive step immediately follow their parent row. The recursive common table expression syntax gives you a choice of depth or breadth first hierarchical order by adding the SEARCH clause. The connect by syntax is always depth first.

In the trip planner examples for these recursive methods, airline flights and train connections are used to find transportation paths between cities. The following table definitions and data are used in the examples.

```
CREATE TABLE FLIGHTS (DEPARTURE CHAR(20),
                      ARRIVAL CHAR(20),
                      CARRIER CHAR(15),
                      FLIGHT_NUMBER CHAR(5),
                      PRICE INT);

INSERT INTO FLIGHTS VALUES('New York', 'Paris', 'Atlantic', '234', 400);
INSERT INTO FLIGHTS VALUES('Chicago', 'Miami', 'NA Air', '2334', 300);
INSERT INTO FLIGHTS VALUES('New York', 'London', 'Atlantic', '5473', 350);
INSERT INTO FLIGHTS VALUES('London', 'Athens', 'Mediterranean', '247', 340);
INSERT INTO FLIGHTS VALUES('Athens', 'Nicosia', 'Mediterranean', '2356', 280);
INSERT INTO FLIGHTS VALUES('Paris', 'Madrid', 'Euro Air', '3256', 380);
INSERT INTO FLIGHTS VALUES('Paris', 'Cairo', 'Euro Air', '63', 480);
INSERT INTO FLIGHTS VALUES('Chicago', 'Frankfurt', 'Atlantic', '37', 480);
INSERT INTO FLIGHTS VALUES('Frankfurt', 'Moscow', 'Asia Air', '2337', 580);
INSERT INTO FLIGHTS VALUES('Frankfurt', 'Beijing', 'Asia Air', '77', 480);
INSERT INTO FLIGHTS VALUES('Moscow', 'Tokyo', 'Asia Air', '437', 680);
INSERT INTO FLIGHTS VALUES('Frankfurt', 'Vienna', 'Euro Air', '59', 200);
INSERT INTO FLIGHTS VALUES('Paris', 'Rome', 'Euro Air', '534', 340);
INSERT INTO FLIGHTS VALUES('Miami', 'Lima', 'SA Air', '5234', 530);
INSERT INTO FLIGHTS VALUES('New York', 'Los Angeles', 'NA Air', '84', 330);
INSERT INTO FLIGHTS VALUES('Los Angeles', 'Tokyo', 'Pacific Air', '824', 530);
INSERT INTO FLIGHTS VALUES('Tokyo', 'Hawaii', 'Asia Air', '94', 330);
INSERT INTO FLIGHTS VALUES('Washington', 'Toronto', 'NA Air', '104', 250);

CREATE TABLE TRAINS(DEPARTURE CHAR(20),
                    ARRIVAL CHAR(20),
                    RAILLINE CHAR(15),
                    TRAIN CHAR(5),
```

```

PRICE INT);

INSERT INTO TRAINS VALUES('Chicago', 'Washington', 'UsTrack', '323', 90);
INSERT INTO TRAINS VALUES('Madrid', 'Barcelona', 'EuroTrack', '5234', 60);
INSERT INTO TRAINS VALUES('Washington', 'Boston', 'UsTrack', '232', 50);

CREATE TABLE FLIGHTSTATS(FLIGHT# CHAR(5),
                           ON_TIME_PERCENT DECIMAL(5,2),
                           CANCEL_PERCENT DECIMAL(5,2));

INSERT INTO FLIGHTSTATS VALUES('234', 85.0, 0.20);
INSERT INTO FLIGHTSTATS VALUES('2334', 92.0, 0.10);
INSERT INTO FLIGHTSTATS VALUES('5473', 86.2, 0.10);
INSERT INTO FLIGHTSTATS VALUES('247', 91.0, 0.10);
INSERT INTO FLIGHTSTATS VALUES('2356', 91.0, 0.10);
INSERT INTO FLIGHTSTATS VALUES('3256', 92.0, 0.10);
INSERT INTO FLIGHTSTATS VALUES('63', 90.5, 0.10);
INSERT INTO FLIGHTSTATS VALUES('37', 87.0, 0.20);
INSERT INTO FLIGHTSTATS VALUES('2337', 80.0, 0.20);
INSERT INTO FLIGHTSTATS VALUES('77', 86.0, 0.10);
INSERT INTO FLIGHTSTATS VALUES('437', 81.0, 0.10);
INSERT INTO FLIGHTSTATS VALUES('59', 85.0, 0.10);
INSERT INTO FLIGHTSTATS VALUES('534', 87.0, 0.10);
INSERT INTO FLIGHTSTATS VALUES('5234', 88.0, 0.20);
INSERT INTO FLIGHTSTATS VALUES('84', 88.0, 0.1);
INSERT INTO FLIGHTSTATS VALUES('824', 93.0, 0.10);
INSERT INTO FLIGHTSTATS VALUES('94', 92.0, 0.10);
INSERT INTO FLIGHTSTATS VALUES('104', 93.0, 0.10);

```

Using CONNECT BY hierarchical queries

Suppose you want to find out what cities you can fly to if you start in Chicago, and how many separate flights it will take to get there. The following query shows you that information.

```

SELECT CONNECT_BY_ROOT departure AS origin, departure, arrival, LEVEL AS flight_count
FROM flights
START WITH departure = 'Chicago'
CONNECT BY PRIOR arrival = departure

```

This query returns the following information.

Table 21. Results of the previous query

ORIGIN	DEPARTURE	ARRIVAL	FLIGHT_COUNT
Chicago	Chicago	Miami	1
Chicago	Miami	Lima	2
Chicago	Chicago	Frankfurt	1
Chicago	Frankfurt	Vienna	2
Chicago	Frankfurt	Beijing	2
Chicago	Frankfurt	Moscow	2
Chicago	Moscow	Tokyo	3
Chicago	Tokyo	Hawaii	4

There are several parts to this hierarchical query. There is an initial selection which defines the initial seed for the recursion. In this case, it is the rows from the flights table that START WITH a departure from 'Chicago'. The CONNECT BY clause is used to define how the rows that have already been generated are to be 'connected' to generate more rows for subsequent iterations of the query. The PRIOR unary operator tells Db2 how to select a new row based on the results of the previous row. The recursive join column (typically one column but could have several) selected by the result of the START WITH clause is referenced by the PRIOR keyword. This means that the previous row's ARRIVAL city becomes the new row's PRIOR value for the DEPARTURE city. This is encapsulated in the clause CONNECT BY PRIOR arrival = departure.

There are two other connect by features illustrated in this example query. The unary operator `CONNECT_BY_ROOT` is used to define a fixed expression value that is determined in the initialization step and is the same for all the generated recursive result rows. Typically, it is your starting value for that particular iteration as you might have multiple `START WITH` values. In this query, it defines in the result set the `ORIGIN` of the different destination options from Chicago. If the `START WITH` clause selected multiple cities, `ORIGIN` would indicate which city a row used as its start value.

`LEVEL` is one of three pseudo columns available when using connect by recursion. The value of `LEVEL` reflects the recursion level of the current row. In this example, `LEVEL` also reflects the number of flights it would take to get from the city of `ORIGIN` (Chicago) to the different `ARRIVAL` cities.

A hierarchical query is run just like its equivalent recursive common table expression query and generates the same result set. See [“Using recursive common table expressions and recursive views” on page 103](#). The only difference is in the order of the returned rows. The connect by query returns the rows in depth first order; every row of the result set immediately follows its parent row. The recursive common table expression query returns the rows in breadth first order; all the rows for one level are returned, then all the rows that were generated from the previous level are returned.

Example: Two tables used for recursion using `CONNECT BY`

Now, suppose you start in Chicago but want to add in transportation options by rail in addition to flights and you want to know which cities you can get to and how many connections it would take.

The following connect by query returns that information. Note that in the corresponding recursive common table expression example, [“Example: Two tables used for recursion using recursive common table expressions” on page 105](#), we can also distinguish between the number of rail vs number of airline connections and sum the ongoing ticket cost of the connections to that destination. Those calculations are examples of derivations allowed using the more complex but more flexible recursive common table expression syntax. That capability is not available when using the connect by syntax.

```
SELECT CONNECT_BY_ROOT departure AS departure, arrival, LEVEL - 1 connections
FROM
  ( SELECT departure, arrival FROM flights
    UNION
    SELECT departure, arrival FROM trains) t
START WITH departure = 'Chicago'
CONNECT BY PRIOR arrival = departure;
```

This query returns the following information.

<i>Table 22. Results of the previous query</i>		
DEPARTURE	ARRIVAL	CONNECTIONS
Chicago	Miami	0
Chicago	Lima	1
Chicago	Frankfurt	0
Chicago	Vienna	1
Chicago	Beijing	1
Chicago	Moscow	1
Chicago	Tokyo	2
Chicago	Hawaii	3
Chicago	Washington	0
Chicago	Boston	1
Chicago	Toronto	1

In this example, there are two data sources feeding the recursion, a list of flights and a list of trains. In the final results, you see how many connections are needed to travel between the cities.

Example: Sibling ordering using CONNECT BY

One of the drawbacks of recursive common table expressions is that you cannot order the results among siblings based on a particular column value. You can do this with connect by. For example, if you want to output destinations from New York but you also want to order your hierarchical data among siblings by a certain value, such as the cost of a ticket to that destination, you can do that by specifying the ORDER SIBLINGS BY clause.

```
SELECT CONNECT_BY_ROOT departure AS origin, departure, arrival,  
       LEVEL level, price ticket_price  
FROM   flights  
START WITH departure = 'New York'  
CONNECT BY PRIOR arrival = departure  
ORDER SIBLINGS BY price ASC
```

This query returns the following information.

Table 23. Results of the previous query

ORIGIN	DEPARTURE	ARRIVAL	LEVEL	TICKET_PRICE
New York	New York	LA	1	330
New York	LA	Tokyo	2	530
New York	Tokyo	Hawaii	3	330
New York	New York	London	1	350
New York	London	Athens	2	340
New York	Athens	Nicosia	3	280
New York	New York	Paris	1	400
New York	Paris	Rome	2	340
New York	Paris	Madrid	2	380
New York	Paris	Cairo	2	480

The result table shows all the destinations possible from the origin city of New York. All sibling destinations (those destinations that originate from the same departure city) are output sorted by ticket price. For example, the destinations from Paris are Rome, Madrid and Cairo; they are output ordered by ascending ticket price. Note that the output shows New York to LA as the first destination directly from New York because it has a less expensive ticket price (330) than did the direct connects to London or Paris which are 350 and 400 respectively.

Example: Cyclic data checks using CONNECT BY

The key to any recursive process, whether is it a recursive program or a recursive query, is that the recursion must be finite. If not, you will get into a never ending loop. CONNECT BY is unlike recursive common table expressions in that it always checks for infinite recursion and terminates that cycle automatically so you never have to worry about a runaway query.

By default, if connect by encounters cyclic data, it will issue an SQL error, SQ20451: Cycle detected in hierarchical query. This error causes termination of the query so no results are returned.

If you want results back and just want the infinite cycle to stop, you can specify the NOCYCLE keyword on the CONNECT BY clause. This means no error will be issued for cyclic data.

Using the NOCYCLE option along with the CONNECT_BY_ISCYCLE pseudo column is a way you can find cyclic data and correct the data if desired.

Inserting the following row into the *FLIGHTS* table results in potentially infinite recursion since Paris goes to Cairo and Cairo goes to Paris.

```
INSERT INTO flights VALUES ('Cairo', 'Paris', 'Atlantic', '1134', 440);
```

The following query illustrates the tolerance of the cyclic data by specifying NOCYCLE. In addition, the CONNECT_BY_ISCYCLE pseudo column is used to identify cyclic rows and the function SYS_CONNECT_BY_PATH is used to build an *Itinerary* string of all the connection cities leading up to the destination. SYS_CONNECT_BY_PATH is implemented as a CLOB data type so you have a large result column to reflect deep recursions.

```
SELECT CONNECT_BY_ROOT departure AS origin, arrival,
       SYS_CONNECT_BY_PATH(TRIM(arrival), ' : ') itinerary, CONNECT_BY_ISCYCLE cyclic
FROM flights
START WITH departure = 'New York'
CONNECT BY NOCYCLE PRIOR arrival = departure;
```

This query returns the following information.

Table 24. Results of the previous query

ORIGIN	ARRIVAL	ITINERARY	CYCLIC
New York	Paris	: Paris	0
New York	Rome	: Paris : Rome	0
New York	Cairo	: Paris : Cairo	0
New York	Paris	: Paris : Cairo : Paris	1
New York	Madrid	: Paris : Madrid	0
New York	London	: London	0
New York	Athens	: London : Athens	0
New York	Nicosia	: London : Athens : Nicosia	0
New York	LA	: LA	0
New York	Tokyo	: LA : Tokyo	0
New York	Hawaii	: LA : Tokyo : Hawaii	0

Note that the result set row that reflects cyclic data often depends on where you start in the cycle with the START WITH clause.

Example: Pseudo column CONNECT_BY_ISLEAF in CONNECT BY

There may be times when processing recursive data that you may want to know which rows result in no further recursion. In other words, which rows are leaf rows or have no children in the hierarchy.

In the following query, you can find out which destinations are final destinations; in other words, which destinations have no outbound flights. The CONNECT_BY_ISLEAF pseudo column will be 0 if it is not a leaf and 1 if it is. You can also specify CONNECT_BY_ISLEAF in a WHERE predicate to see only leaf rows.

```
SELECT CONNECT_BY_ROOT departure AS origin, arrival,
       SYS_CONNECT_BY_PATH(TRIM(arrival), ' : ') itinerary, CONNECT_BY_ISLEAF leaf
FROM flights
START WITH departure = 'New York'
CONNECT BY PRIOR arrival = departure;
```

This query returns the following information.

Table 25. Results of the previous query

ORIGIN	ARRIVAL	ITINERARY	LEAF
New York	Paris	: Paris	0
New York	Rome	: Paris : Rome	1
New York	Cairo	: Paris : Cairo	1
New York	Madrid	: Paris : Madrid	1
New York	London	: London	0
New York	Athens	: London : Athens	0
New York	Nicosia	: London : Athens : Nicosia	1
New York	LA	: LA	0
New York	Tokyo	: LA : Tokyo	0
New York	Hawaii	: LA : Tokyo : Hawaii	1

Example: Join predicates and where clause selection with CONNECT BY

Often times the hierarchical nature of your data is reflected in one table but you need to join those results to additional tables to fully determine the output of the row.

In a connect by query you can use any type of join supported by Db2 for i including INNER JOIN, LEFT OUTER JOIN, and LEFT EXCEPTION JOIN. When you explicitly use a JOIN clause, the predicate specified in the ON clause is applied first, before the connect by operation, and any WHERE clause in the connect by query is applied after the recursion. The WHERE selection is applied after the connect by so that the recursive process results don't end too soon.

In the following query, you are looking for all the flight connections starting in New York that have an ON_TIME_PERCENT greater than 90%.

```
SELECT CONNECT_BY_ROOT departure AS origin, departure, arrival,
       flight_number, on_time_Percent AS onTime
FROM flights INNER JOIN flightstats ON flight_number = flight#
WHERE on_time_percent > 90
START WITH departure = 'New York'
CONNECT BY PRIOR arrival = departure;
```

This query returns the following information.

Table 26. Results of the previous query

ORIGIN	DEPARTURE	ARRIVAL	FLIGHT#	ONTIME
New York	Paris	Cairo	63	90.50
New York	Paris	Madrid	3256	92.00
New York	London	Athens	247	91.00
New York	Athens	Nicosia	2356	91.00
New York	LA	Tokyo	824	93.00
New York	Tokyo	Hawaii	94	92.00

This query can also be expressed without using the JOIN syntax. The query optimizer will pull out of the WHERE clause those predicates that are join predicates to be processed first and leave any remaining WHERE predicates to be evaluated after the recursion.

```

SELECT CONNECT_BY_ROOT departure AS origin, departure, arrival, flight_number, on_time_percent
AS onTime
FROM flights, flightstats
WHERE flight_number = flight# AND on_time_percent > 90
START WITH departure = 'New York'
CONNECT BY PRIOR arrival = departure;

```

In this second example, if the WHERE predicates are more complex, you may need to aid the optimizer by explicitly pulling out the JOIN predicates between the *flights* and *flightstats* tables and using both an ON clause and a WHERE clause.

If you want additional search conditions to be applied as part of the recursion process, for example you never want to take a flight with an on time percentage of less than 90%, you can also control the join results by putting the join in a derived table with a join predicate and a WHERE clause.

```

SELECT CONNECT_BY_ROOT departure AS origin, departure, arrival, flight_number, on_time_percent
AS onTime
FROM (SELECT departure, arrival, flight_number, on_time_percent
FROM flights, flightstats
WHERE flight_number = flight# AND on_time_percent > 90) t1
START WITH departure='New York'
CONNECT BY PRIOR arrival = departure;

```

Another option is to put the selection predicates in the START WITH and CONNECT BY clauses.

```

SELECT CONNECT_BY_ROOT departure AS origin, departure, arrival, flight_number, on_time_percent
AS onTime
FROM flights, flightstats
WHERE flight_number = flight#
START WITH departure = 'New York' AND on_time_percent > 90
CONNECT BY PRIOR arrival = departure AND on_time_percent > 90

```

In this case, you would be out of luck as there are no direct flights out of New York with a greater than 90% on time statistic. Since there is nothing to seed the recursion, no rows are returned from the query.

Using recursive common table expressions and recursive views

Suppose you want to find out what cities you can fly to if you start in Chicago, and how many separate flights it will take to get there. The following query shows you that information.

```

WITH destinations (origin, departure, arrival, flight_count) AS
(SELECT a.departure, a.departure, a.arrival, 1
FROM flights a
WHERE a.departure = 'Chicago'
UNION ALL
SELECT r.origin, b.departure, b.arrival, r.flight_count + 1
FROM destinations r, flights b
WHERE r.arrival = b.departure)
SELECT origin, departure, arrival, flight_count
FROM destinations

```

This query returns the following information.

Table 27. Results of the previous query			
ORIGIN	DEPARTURE	ARRIVAL	FLIGHT_COUNT
Chicago	Chicago	Miami	1
Chicago	Chicago	Frankfurt	1
Chicago	Miami	Lima	2
Chicago	Frankfurt	Moscow	2
Chicago	Frankfurt	Beijing	2
Chicago	Frankfurt	Vienna	2
Chicago	Moscow	Tokyo	3

Table 27. Results of the previous query (continued)			
ORIGIN	DEPARTURE	ARRIVAL	FLIGHT_COUNT
Chicago	Tokyo	Hawaii	4

This recursive query is written in two parts. The first part of the common table expression is called the *initialization fullselect*. It selects the first rows for the result set of the common table expression. In this example, it selects the two rows in the *flights* table that get you directly to another location from Chicago. It also initializes the number of flight legs to one for each row it selects.

The second part of the recursive query joins the rows from the current result set of the common table expression with other rows from the original table. It is called the *iterative fullselect*. This is where the recursion is introduced. Notice that the rows that have already been selected for the result set are referenced by using the name of the common table expression as the table name and the common table expression result column names as the column names.

In this recursive part of the query, any rows from the original table that you can get to from each of the previously selected arrival cities are selected. A previously selected row's arrival city becomes the new departure city. Each row from this recursive select increments the flight count to the destination by one more flight. As these new rows are added to the common table expression result set, they are also fed into the iterative fullselect to generate more result set rows. In the data for the final result, you can see that the total number of flights is actually the total number of recursive joins (plus 1) it took to get to that arrival city.

A recursive view looks very similar to a recursive common table expression. You can write the previous recursive common table expression as a recursive view like this:

```
CREATE VIEW destinations (origin, departure, arrival, flight_count) AS
  SELECT departure, departure, arrival, 1
     FROM flights
     WHERE departure = 'Chicago'
  UNION ALL
  SELECT r.origin, b.departure, b.arrival, r.flight_count + 1
     FROM destinations r, flights b
     WHERE r.arrival = b.departure)
```

The iterative fullselect part of this view definition refers to the view itself. Selection from this view returns the same rows as you get from the previous recursive common table expression. For comparison, note that connect by recursion is allowed anywhere a SELECT is allowed, so it can easily be included in a view definition.

Example: Two starting cities using recursive common table expressions

Suppose you are willing to fly from either Chicago or New York, and you want to know where you could go and how much it would cost.

```
WITH destinations (departure, arrival, connections, cost) AS
  (SELECT a.departure, a.arrival, 0, price
     FROM flights a
     WHERE a.departure = 'Chicago' OR
           a.departure = 'New York'
  UNION ALL
  SELECT r.departure, b.arrival, r.connections + 1,
         r.cost + b.price
     FROM destinations r, flights b
     WHERE r.arrival = b.departure)
  SELECT departure, arrival, connections, cost
     FROM destinations
```

This query returns the following information.

Table 28. Results of the previous query

DEPARTURE	ARRIVAL	CONNECTIONS	COST
Chicago	Miami	0	300
Chicago	Frankfurt	0	480
New York	Paris	0	400
New York	London	0	350
New York	Los Angeles	0	330
Chicago	Lima	1	830
Chicago	Moscow	1	1,060
Chicago	Beijing	1	960
Chicago	Vienna	1	680
New York	Madrid	1	780
New York	Cairo	1	880
New York	Rome	1	740
New York	Athens	1	690
New York	Tokyo	1	860
Chicago	Tokyo	2	1,740
New York	Nicosia	2	970
New York	Hawaii	2	1,190
Chicago	Hawaii	3	2,070

For each returned row, the results show the starting departure city and the final destination city. It counts the number of connections needed rather than the total number of flight and adds up the total cost for all the flights.

Example: Two tables used for recursion using recursive common table expressions

Now, suppose you start in Chicago but add in transportation by railway in addition to the airline flights, and you want to know which cities you can go to.

The following query returns that information:

```
WITH destinations (departure, arrival, connections, flights, trains, cost) AS
  (SELECT f.departure, f.arrival, 0, 1, 0, price
   FROM flights f
   WHERE f.departure = 'Chicago'
  UNION ALL
   SELECT t.departure, t.arrival, 0, 0, 1, price
   FROM trains t
   WHERE t.departure = 'Chicago'
  UNION ALL
   SELECT r.departure, b.arrival, r.connections + 1 , r.flights + 1, r.trains,
         r.cost + b.price
   FROM destinations r, flights b
   WHERE r.arrival = b.departure
  UNION ALL
   SELECT r.departure, c.arrival, r.connections + 1 ,
         r.flights, r.trains + 1, r.cost + c.price
   FROM destinations r, trains c
   WHERE r.arrival = c.departure)
SELECT departure, arrival, connections, flights, trains, cost
FROM destinations
```

This query returns the following information.

<i>Table 29. Results of the previous query</i>					
DEPARTURE	ARRIVAL	CONNECTIONS	FLIGHTS	TRAINS	COST
Chicago	Miami	0	1	0	300
Chicago	Frankfurt	0	1	0	480
Chicago	Washington	0	0	1	90
Chicago	Lima	1	2	0	830
Chicago	Moscow	1	2	0	1,060
Chicago	Beijing	1	2	0	960
Chicago	Vienna	1	2	0	680
Chicago	Toronto	1	1	1	340
Chicago	Boston	1	0	2	140
Chicago	Tokyo	2	3	0	1,740
Chicago	Hawaii	3	4	0	2,070

In this example, there are two parts of the common table expression that provide initialization values to the query: one for flights and one for trains. For each of the result rows, there are two recursive references to get from the previous arrival location to the next possible destination: one for continuing by air, the other for continuing by train. In the final results, you would see how many connections are needed and how many airline or train trips can be taken.

Example: DEPTH FIRST and BREADTH FIRST options for recursive common table expressions

The two examples here show the difference in the result set row order based on whether the recursion is processed depth first or breadth first.

Note: The search clause is not supported directly for recursive views. You can define a view that contains a recursive common table expression to get this function.

The option to determine the result using breadth first or depth first is a recursive relationship sort based on the recursive join column specified for the SEARCH BY clause. When the recursion is handled breadth first, all children are processed first, then all grandchildren, then all great grandchildren. When the recursion is handled depth first, the full recursive ancestry chain of one child is processed before going to the next child.

In both of these cases, you specify an extra column name that is used by the recursive process to keep track of the depth first or breadth first ordering. This column must be used in the ORDER BY clause of the outer query to get the rows back in the specified order. If this column is not used in the ORDER BY, the DEPTH FIRST or BREADTH FIRST processing option is ignored.

The selection of which column to use for the SEARCH BY column is important. To have any meaning in the result, it must be the column that is used in the iterative fullselect to join from the initialization fullselect. In this example, *ARRIVAL* is the column to use.

The following query returns that information:

```
WITH destinations (departure, arrival, connections, cost) AS
  (SELECT f.departure, f.arrival, 0, price
   FROM flights f
   WHERE f.departure = 'Chicago'
  UNION ALL
   SELECT r.departure, b.arrival, r.connections + 1,
          r.cost + b.price
```

```

FROM destinations r, flights b
WHERE r.arrival = b.departure)
SEARCH DEPTH FIRST BY arrival SET ordcol
SELECT *
FROM destinations
ORDER BY ordcol

```

This query returns the following information.

Table 30. Results of the previous query

DEPARTURE	ARRIVAL	CONNECTIONS	COST
Chicago	Miami	0	300
Chicago	Lima	1	830
Chicago	Frankfurt	0	480
Chicago	Moscow	1	1,060
Chicago	Tokyo	2	1,740
Chicago	Hawaii	3	2,070
Chicago	Beijing	1	960
Chicago	Vienna	1	680

In this result data, you can see that all destinations that are generated from the Chicago-to-Miami row are listed before the destinations from the Chicago-to-Frankfort row.

Next, you can run the same query but request the result to be ordered breadth first.

```

WITH destinations (departure, arrival, connections, cost) AS
(SELECT f.departure, f.arrival, 0, price
FROM flights f
WHERE f.departure = 'Chicago'
UNION ALL
SELECT r.departure, b.arrival, r.connections + 1,
r.cost + b.price
FROM destinations r, flights b
WHERE r.arrival = b.departure)
SEARCH BREADTH FIRST BY arrival SET ordcol
SELECT *
FROM destinations
ORDER BY ordcol

```

This query returns the following information.

Table 31. Results of the previous query

DEPARTURE	ARRIVAL	CONNECTIONS	COST
Chicago	Miami	0	300
Chicago	Frankfurt	0	480
Chicago	Lima	1	830
Chicago	Moscow	1	1,060
Chicago	Beijing	1	960
Chicago	Vienna	1	680
Chicago	Tokyo	2	1,740
Chicago	Hawaii	3	2,070

In this result data, you can see that all the direct connections from Chicago are listed before the connecting flights. The data is identical to the results from the previous query, but in a breadth first order. As you can see, there is no ordering done based on any values of the column used for depth or breadth first processing. To get ordering, the ORDER SIBLINGS BY construct available with the CONNECT BY form of recursion can be used.

Example: Cyclic data using recursive common table expressions

The key to any recursive process, whether it is a recursive programming algorithm or querying recursive data, is that the recursion must be finite. If not, you will get into a never ending loop. The CYCLE option allows you to safeguard against cyclic data. Not only will it terminate repeating cycles but it also allows you to optionally output a cycle mark indicator that may lead you to find cyclic data.

Note: The cycle clause is not supported directly for recursive views. You can define a view that contains a recursive common table expression to get this function.

For a final example, suppose we have a cycle in the data. By adding one more row to the table, there is now a flight from Cairo to Paris and one from Paris to Cairo. Without accounting for possible cyclic data like this, it is quite easy to generate a query that will go into an infinite loop processing the data.

The following query returns that information:

```
INSERT INTO FLIGHTS VALUES('Cairo', 'Paris', 'Euro Air', '1134', 440)

WITH destinations (departure, arrival, connections, cost, itinerary) AS
  (SELECT f.departure, f.arrival, 1, price,
         CAST(f.departure CONCAT f.arrival AS VARCHAR(2000))
   FROM flights f
   WHERE f.departure = 'New York'
  UNION ALL
  SELECT r.departure, b.arrival, r.connections + 1,
         r.cost + b.price, CAST(r.itinerary CONCAT b.arrival AS VARCHAR(2000))
   FROM destinations r, flights b
   WHERE r.arrival = b.departure)
CYCLE arrival SET cyclic_data TO '1' DEFAULT '0'
SELECT departure, arrival, itinerary, cyclic_data
FROM destinations
```

This query returns the following information.

Table 32. Results of the previous query

DEPARTURE	ARRIVAL	ITINERARY	CYCLIC_DATA
New York	Paris	New York Paris	0
New York	London	New York London	0
New York	Los Angeles	New York Los Angeles	0
New York	Madrid	New York Paris Madrid	0
New York	Cairo	New York Paris Cairo	0
New York	Rome	New York Paris Rome	0
New York	Athens	New York London Athens	0
New York	Tokyo	New York Los Angeles Tokyo	0
New York	Paris	New York Paris Cairo Paris	1
New York	Nicosia	New York London Athens Nicosia	0
New York	Hawaii	New York Los Angeles Tokyo Hawaii	0

In this example, the ARRIVAL column is defined in the CYCLE clause as the column to use for detecting a cycle in the data. When a cycle is found, a special column, CYCLIC_DATA in this case, is set to the character value of '1' for the cycling row in the result set. All other rows will contain the default value of '0'. When a cycle on the ARRIVAL column is found, processing will not proceed any further in the data so

the infinite loop will not happen. To see if your data actually has a cyclic reference, the *CYCLIC_DATA* column can be referenced in the outer query. You can choose to exclude cyclic rows by adding a predicate: *WHERE CYCLIC_DATA = 0*.

Using the UNION keyword to combine subselects

Using the UNION keyword, you can combine two or more subselects to form a fullselect.

When SQL encounters the UNION keyword, it processes each subselect to form an interim result table, then it combines the interim result table of each subselect and deletes duplicate rows to form a combined result table. You can use different clauses and techniques when coding select-statements.

You can use UNION to eliminate duplicates when merging lists of values obtained from several tables. For example, you can obtain a combined list of employee numbers that includes:

- People in department D11
- People whose assignments include projects MA2112, MA2113, and AD3111

The combined list is derived from two tables and contains no duplicates. To do this, specify:

```
SELECT EMPNO
FROM CORPDATA.EMPLOYEE
WHERE WORKDEPT = 'D11'
UNION
SELECT EMPNO
FROM CORPDATA.EMPPROJACT
WHERE PROJNO = 'MA2112' OR
      PROJNO = 'MA2113' OR
      PROJNO = 'AD3111'
ORDER BY EMPNO
```

To better understand the results from these SQL statements, imagine that SQL goes through the following process:

Step 1. SQL processes the first SELECT statement:

```
SELECT EMPNO
FROM CORPDATA.EMPLOYEE
WHERE WORKDEPT = 'D11'
```

The query returns the following interim result table.

EMPNO from CORPDATA.EMPLOYEE

000060

000150

000160

000170

000180

000190

000200

000210

000220

200170

200220

Step 2. SQL processes the second SELECT statement:

```
SELECT EMPNO
FROM CORPDATA.EMPPROJACT
WHERE PROJNO='MA2112' OR
      PROJNO='MA2113' OR
      PROJNO='AD3111'
```

The query returns another interim result table.

EMPNO from CORPDATA.EMPPROJACT
000230
000230
000240
000230
000230
000240
000230
000150
000170
000190
000170
000190
000150
000160
000180
000170
000210
000210

Step 3. SQL combines the two interim result tables, removes duplicate rows, and orders the result:

```
SELECT EMPNO
FROM CORPDATA.EMPLOYEE
WHERE WORKDEPT = 'D11'
UNION
SELECT EMPNO
FROM CORPDATA.EMPPROJACT
WHERE PROJNO='MA2112' OR
      PROJNO='MA2113' OR
      PROJNO='AD3111'
ORDER BY EMPNO
```

The query returns a combined result table with values in ascending sequence.

EMPNO
000060
000150
000160

EMPNO

000170

000180

000190

000200

000210

000220

000230

000240

200170

200220

When you use UNION:

- Any ORDER BY clause must appear after the last subselect that is part of the union. In this example, the results are sequenced on the basis of the first selected column, *EMPNO*. The ORDER BY clause specifies that the combined result table is to be in collated sequence. ORDER BY is not allowed in a view.
- A name may be specified on the ORDER BY clause if the result columns are named. A result column is named if the corresponding columns in each of the unioned select-statements have the same name. An AS clause can be used to assign a name to columns in the select list.

```
SELECT A + B AS X ...  
UNION  
SELECT X ... ORDER BY X
```

If the result columns are unnamed, use a positive integer to order the result. The number refers to the position of the expression in the list of expressions you include in your subselects.

```
SELECT A + B ...  
UNION  
SELECT X ... ORDER BY 1
```

To identify which subselect each row is from, you can include a constant at the end of the select list of each subselect in the union. When SQL returns your results, the last column contains the constant for the subselect that is the source of that row. For example, you can specify:

```
SELECT A, B, 'A1' ...  
UNION  
SELECT X, Y, 'B2' ...
```

When a row is returned, it includes a value (either A1 or B2) to indicate the table that is the source of the row's values. If the column names in the union are different, SQL uses the set of column names specified in the first subselect when interactive SQL displays or prints the results, or in the SQLDA resulting from processing an SQL DESCRIBE statement.

Note: Sort sequence is applied after the fields across the UNION pieces are made compatible. The sort sequence is used for the distinct processing that implicitly occurs during UNION processing.

Related concepts

[Sort sequences and normalization in SQL](#)

A sort sequence defines how characters in a character set relate to each other when they are compared or ordered. Normalization allows you to compare strings that contain combining characters.

Related reference

[Creating and using views](#)

A view can be used to access data in one or more tables or views. You create a view by using a SELECT statement.

Specifying the UNION ALL keyword

If you want to keep duplicates in the result of a UNION operation, specify the UNION ALL keyword instead of just UNION.

This topic uses the same steps and example as [“Using the UNION keyword to combine subselects”](#) on page 109.

Step 3. SQL combines two interim result tables:

```
SELECT EMPNO
  FROM CORPDATA.EMPLOYEE
 WHERE WORKDEPT = 'D11'
UNION ALL
SELECT EMPNO
  FROM CORPDATA.EMPPROJACT
 WHERE PROJNO='MA2112' OR
        PROJNO= 'MA2113' OR
        PROJNO= 'AD3111'
 ORDER BY EMPNO
```

The query returns an ordered result table that includes duplicates.

EMPNO
000060
000150
000150
000150
000160
000160
000170
000170
000170
000170
000180
000180
000190
000190
000190
000200
000210
000210
000210
000220
000230
000230

EMPNO

000230

000230

000230

000240

000240

200170

200220

The UNION ALL operation is associative, for example:

```
(SELECT PROJNO FROM CORPDATA.PROJECT
UNION ALL
SELECT PROJNO FROM CORPDATA.PROJECT)
UNION ALL
SELECT PROJNO FROM CORPDATA.EMPPROJACT
```

This statement can also be written as:

```
SELECT PROJNO FROM CORPDATA.PROJECT
UNION ALL
(SELECT PROJNO FROM CORPDATA.PROJECT
UNION ALL
SELECT PROJNO FROM CORPDATA.EMPPROJACT)
```

When you include the UNION ALL in the same SQL statement as a UNION operator, however, the result of the operation depends on the order of evaluation. Where there are no parentheses, evaluation is from left to right. Where parentheses are included, the parenthesized subselect is evaluated first, followed, from left to right, by the other parts of the statement.

Using the EXCEPT keyword

The EXCEPT keyword returns the result set of the first subselect minus any matching rows from the second subselect.

Suppose that you want to find a list of employee numbers that includes people in department D11 minus those people whose assignments include projects MA2112, MA2113, and AD3111.

This query returns all of the people in department D11 who are *not* working on projects MA2112, MA2113, and AD3111:

```
SELECT EMPNO
FROM CORPDATA.EMPLOYEE
WHERE WORKDEPT = 'D11'
EXCEPT
SELECT EMPNO
FROM CORPDATA.EMPPROJACT
WHERE PROJNO = 'MA2112' OR
PROJNO = 'MA2113' OR
PROJNO = 'AD3111'
ORDER BY EMPNO
```

To better understand the results from these SQL statements, imagine that SQL goes through the following process:

Step 1. SQL processes the first SELECT statement:

```
SELECT EMPNO
FROM CORPDATA.EMPLOYEE
WHERE WORKDEPT = 'D11'
```

This query returns an interim result table.

EMPNO from CORPDATA.EMPLOYEE

000060

000150

000160

000170

000180

000190

000200

000210

000220

200170

200220

Step 2. SQL processes the second SELECT statement:

```
SELECT EMPNO
FROM CORPDATA.EMPPROJECT
WHERE PROJNO='MA2112' OR
      PROJNO= 'MA2113' OR
      PROJNO= 'AD3111'
```

This query returns another interim result table.

EMPNO from CORPDATA.EMPPROJECT

000230

000230

000240

000230

000230

000240

000230

000150

000170

000190

000170

000190

000150

000160

000180

000170

000210

000210

Step 3. SQL takes the first interim result table, removes all of the rows that also appear in the second interim result table, removes duplicate rows, and orders the result:

```
SELECT EMPNO
FROM CORPDATA.EMPLOYEE
WHERE WORKDEPT = 'D11'
EXCEPT
SELECT EMPNO
FROM CORPDATA.EMPPROJACT
WHERE PROJNO='MA2112' OR
      PROJNO= 'MA2113' OR
      PROJNO= 'AD3111'
ORDER BY EMPNO
```

This query returns a combined result table with values in ascending sequence.

EMPNO
000060
000200
000220
200170
200220

Using the INTERSECT keyword

The INTERSECT keyword returns a combined result set that consists of all of the rows existing in both result sets.

Suppose that you want to find a list of employee numbers that include people in department D11 whose assignments include projects MA2112, MA2113, and AD3111.

The INTERSECT operation returns all of the employee numbers that exist in both result sets. In other words, this query returns all of the people in department D11 who are also working on projects MA2112, MA2113, and AD3111:

```
SELECT EMPNO
FROM CORPDATA.EMPLOYEE
WHERE WORKDEPT = 'D11'
INTERSECT
SELECT EMPNO
FROM CORPDATA.EMPPROJACT
WHERE PROJNO = 'MA2112' OR
      PROJNO = 'MA2113' OR
      PROJNO = 'AD3111'
ORDER BY EMPNO
```

To better understand the results from these SQL statements, imagine that SQL goes through the following process:

Step 1. SQL processes the first SELECT statement:

```
SELECT EMPNO
FROM CORPDATA.EMPLOYEE
WHERE WORKDEPT = 'D11'
```

This query returns an interim result table.

EMPNO from CORPDATA.EMPLOYEE
000060
000150
000160

EMPNO from CORPDATA.EMPLOYEE

000170

000180

000190

000200

000210

000220

200170

200220

Step 2. SQL processes the second SELECT statement:

```
SELECT EMPNO
FROM CORPDATA.EMPPROJECT
WHERE PROJNO='MA2112' OR
      PROJNO= 'MA2113' OR
      PROJNO= 'AD3111'
```

This query returns another interim result table.

EMPNO from CORPDATA.EMPPROJECT

000230

000230

000240

000230

000230

000240

000230

000150

000170

000190

000170

000190

000150

000160

000180

000170

000210

000210

Step 3. SQL takes the first interim result table, compares it to the second interim result table, and returns the rows that exist in both tables minus any duplicate rows, and orders the results.

```
SELECT EMPNO
FROM CORPDATA.EMPLOYEE
WHERE WORKDEPT = 'D11'
INTERSECT
SELECT EMPNO
FROM CORPDATA.EMPPROJACT
WHERE PROJNO='MA2112' OR
      PROJNO= 'MA2113' OR
      PROJNO= 'AD3111'
ORDER BY EMPNO
```

This query returns a combined result table with values in ascending sequence.

EMPNO
000150
000160
000170
000180
000190
000210

Data retrieval errors

Use this information to understand how SQL handles errors that occur when retrieving data.

If SQL finds that a retrieved character or graphic column is too long to be placed in a host variable, SQL does the following:

- Truncates the data while assigning the value to the host variable.
- Sets SQLWARN0 and SQLWARN1 in the SQLCA to the value 'W' or sets RETURNED_SQLSTATE to '01004' in the SQL diagnostics area.
- Sets the indicator variable, if provided, to the length of the value before truncation.

If SQL finds a data mapping error while running a statement, one of two things occurs:

- If the error occurs on an expression in the SELECT list and an indicator variable is provided for the expression in error:
 - SQL returns a -2 for the indicator variable corresponding to the expression in error.
 - SQL returns all valid data for that row.
 - SQL returns a positive SQLCODE.
- If an indicator variable is not provided, SQL returns the corresponding negative SQLCODE.

Data mapping errors include:

- +138 - Argument of the substringing function is not valid.
- +180 - Syntax for a string representation of a date, time, or timestamp is not valid.
- +181 - String representation of a date, time, or timestamp is not a valid value.
- +183 - Invalid result from a date/time expression. The resulting date or timestamp is not within the valid range of dates or timestamps.
- +191 - MIXED data is not properly formed.
- +304 - Numeric conversion error (for example, overflow, underflow, or division by zero).
- +331 - Characters cannot be converted.
- +364 - DECFLOAT arithmetic error.

- +420 - Character in the CAST argument is not valid.
- +802 - Data conversion or data mapping error.

For data mapping errors, the SQLCA reports only the last error detected. The indicator variable corresponding to each result column having an error is set to -2.

For data mapping errors on a multi-row FETCH, each mapping error reported as a warning SQLSTATE will have a separate condition area in the SQL diagnostics area. Note that SQL stops on the first error, so only one mapping error that is reported as an error SQLSTATE will be returned in the SQL diagnostics area.

For all other SQL statements, only the last warning SQLSTATE will be reported in the SQL diagnostics area.

If the full-select contains DISTINCT in the select list and a column in the select list contains numeric data that is not valid, the data is considered equal to a null value if the query is completed as a sort. If an existing index is used, the data is not considered equal to a null.

The impact of data mapping errors on the ORDER BY clause depends on the situation:

- If the data mapping error occurs while data is being assigned to a host variable in a SELECT INTO or FETCH statement, and that same expression is used in the ORDER BY clause, the result record is ordered based on the value of the expression. It is not ordered as if it were a null (higher than all other values). This is because the expression was evaluated before the assignment to the host variable is attempted.
- If the data mapping error occurs while an expression in the select-list is being evaluated and the same expression is used in the ORDER BY clause, the result column is normally ordered as if it were a null value (higher than all other values). If the ORDER BY clause is implemented by using a sort, the result column is ordered as if it were a null value. If the ORDER BY clause is implemented by using an existing index, in the following cases, the result column is ordered based on the actual value of the expression in the index:
 - The expression is a date column with a date format of *MDY, *DMY, *YMD, or *JUL, and a date conversion error occurs because the date is not within the valid range for dates.
 - The expression is a character column and a character cannot be converted.
 - The expression is a decimal column and a numeric value that is not valid is detected.

Inserting rows using the INSERT statement

To add a single row or multiple rows to a table or view, use a form of the INSERT statement.

You can use the INSERT statement to add new rows to a table or view in one of the following ways:

- Specifying values in the INSERT statement for columns to be added.
- Including a select-statement in the INSERT statement to tell SQL what data for the new row is contained in another table or view.
- Specifying the blocked form of the INSERT statement to add multiple rows.

For every row you insert, you must supply a value for each column defined with the NOT NULL attribute if that column does not have a default value. The INSERT statement for adding a row to a table or view may look like this:

```
INSERT INTO table-name
      (column1, column2, ... )
VALUES (value-for-column1, value-for-column2, ... )
```

The INTO clause names the columns for which you specify values. The VALUES clause specifies a value for each column named in the INTO clause. The value you specify can be:

- A **constant**. Inserts the value provided in the VALUES clause.
- A **null value**. Inserts the null value, using the keyword NULL. The column must be defined as capable of containing a null value or an error occurs.
- A **host variable**. Inserts the contents of a host variable.

- A **global variable**. Inserts the contents of the global variable.
- A **special register**. Inserts a special register value; for example, USER.
- An **expression**. Inserts the value that results from an expression.
- A **scalar fullselect**. Inserts the value that is the result of running the select statement.
- The **DEFAULT** keyword. Inserts the default value of the column. The column must have a default value defined for it or allow the NULL value, or an error occurs.

You must provide a value in the VALUES clause for each column named in an INSERT statement's column list. The column name list can be omitted if all columns in the table have a value provided in the VALUES clause. If a column has a default value, the keyword DEFAULT may be used as a value in the VALUES clause. This causes the default value for the column to be placed in the column.

It is a good idea to name all columns into which you are inserting values because:

- Your INSERT statement is more descriptive.
- You can verify that you are providing the values in the proper order based on the column names.
- You have better data independence. The order in which the columns are defined in the table does not affect your INSERT statement.

If the column is defined to allow null values or to have a default, you do not need to name it in the column name list or specify a value for it. The default value is used. If the column is defined to have a default value, the default value is placed in the column. If DEFAULT was specified for the column definition without an explicit default value, SQL places the default value for that data type in the column. If the column does not have a default value defined for it, but is defined to allow the null value (NOT NULL was not specified in the column definition), SQL places the null value in the column.

- For numeric columns, the default value is 0.
- For fixed length character or graphic columns, the default is blanks.
- For fixed length binary columns, the default is hexadecimal zeros.
- For varying length character, graphic, or binary columns and for LOB columns, the default is a zero length string.
- For date, time, and timestamp columns, the default value is the current date, time, or timestamp. When inserting a block of records, the default date/time value is extracted from the system when the block is written. This means that the column will be assigned the same default value for each row in the block.
- For DataLink columns, the default value corresponds to DLVALUE('','URL,').
- For distinct-type columns, the default value is the default value of the corresponding source type.
- For ROWID columns or columns that are defined AS IDENTITY, the database manager generates a default value.
- For XML columns, there is no default allowed except the null value.

When your program attempts to insert a row that duplicates another row already in the table, an error might occur. Multiple null values may or may not be considered duplicate values, depending on the option used when the index was created.

- If the table has a primary key, unique key, or unique index, the row is not inserted. Instead, SQL returns an SQLCODE of -803.
- If the table does not have a primary key, unique key, or unique index, the row can be inserted without error.

If SQL finds an error while running the INSERT statement, it stops inserting data. If you specify COMMIT(*ALL), COMMIT(*CS), COMMIT(*CHG), or COMMIT(*RR), no rows are inserted. Rows already inserted by this statement, in the case of INSERT with a select-statement or blocked insert, are deleted. If you specify COMMIT(*NONE), any rows already inserted are *not* deleted.

A table created by SQL is created with the Reuse Deleted Records parameter of *YES. This allows the database manager to reuse any rows in the table that were marked as deleted. The CHGPF command can be used to change the attribute to *NO. This causes INSERT to always add rows to the end of the table.

The order in which rows are inserted does not guarantee the order in which they will be retrieved.

If the row is inserted without error, the SQLERRD(3) field of the SQLCA has a value of 1.

Note: For blocked INSERT or for INSERT with select-statement, more than one row can be inserted. The number of rows inserted is reflected in SQLERRD(3) in the SQLCA. It is also available from the ROW_COUNT diagnostics item in the GET DIAGNOSTICS statement.

Related reference

[INSERT](#)

Inserting rows using the VALUES clause

You use the VALUES clause in the INSERT statement to insert a single row or multiple rows into a table.

An example of this is to insert a new row into the DEPARTMENT table. The columns for the new row are as follows:

- Department number (DEPTNO) is 'E31'
- Department name (DEPTNAME) is 'ARCHITECTURE'
- Manager number (MGRNO) is '00390'
- Reports to (ADMRDEPT) department 'E01'

The INSERT statement for this new row is as follows:

```
INSERT INTO DEPARTMENT (DEPTNO, DEPTNAME, MGRNO, ADMRDEPT)
VALUES ('E31', 'ARCHITECTURE', '00390', 'E01')
```

You can also insert multiple rows into a table using the VALUES clause. The following example inserts two rows into the PROJECT table. Values for the Project number (PROJNO), Project name (PROJNAME), Department number (DEPTNO), and Responsible employee (RESPEMP) are given in the values list. The value for the Project start date (PRSTDATE) uses the current date. The rest of the columns in the table that are not listed in the column list are assigned their default value.

```
INSERT INTO PROJECT (PROJNO, PROJNAME, DEPTNO, RESPEMP, PRSTDATE)
VALUES ('HG0023', 'NEW NETWORK', 'E11', '200280', CURRENT DATE),
('HG0024', 'NETWORK PGM', 'E11', '200310', CURRENT DATE)
```

Inserting rows using a select-statement

You can use a select-statement within an INSERT statement to insert zero, one, or more rows into a table from the result table of the select-statement.

One use for this kind of INSERT statement is to move data into a table you created for summary data. For example, suppose you want a table that shows each employee's time commitments to projects. Create a table called EMPTIME with the columns *EMPNUMBER*, *PROJNUMBER*, *STARTDATE*, and *ENDDATE* and then use the following INSERT statement to fill the table:

```
INSERT INTO CORPDATA.EMPTIME
(EMPNUMBER, PROJNUMBER, STARTDATE, ENDDATE)
SELECT EMPNO, PROJNO, EMSTDATE, EMENDATE
FROM CORPDATA.EMPPROJECT
```

The select-statement embedded in the INSERT statement is no different from the select-statement you use to retrieve data. With the exception of FOR READ ONLY, FOR UPDATE, or the OPTIMIZE clause, you can use all the keywords, functions, and techniques used to retrieve data. SQL inserts all the rows that meet the search conditions into the table you specify. Inserting rows from one table into another table does not affect any existing rows in either the source table or the target table.

You should consider the following when inserting multiple rows into a table:

Notes:

1. The number of columns implicitly or explicitly listed in the INSERT statement must equal the number of columns listed in the select-statement.
2. The data in the columns you are selecting must be compatible with the columns you are inserting into when using the INSERT with select-statement.
3. In the event the select-statement embedded in the INSERT returns no rows, an SQLCODE of 100 is returned to alert you that no rows were inserted. If you successfully insert rows, the SQLERRD(3) field of the SQLCA has an integer representing the number of rows SQL actually inserted. This value is also available from the ROW_COUNT diagnostics item in the GET DIAGNOSTICS statement.
4. If SQL finds an error while running the INSERT statement, SQL stops the operation. If you specify COMMIT (*CHG), COMMIT(*CS), COMMIT (*ALL), or COMMIT(*RR), nothing is inserted into the table and a negative SQLCODE is returned. If you specify COMMIT(*NONE), any rows inserted before the error remain in the table.

Related reference

[Inserting data from a remote database](#)

You can insert into a table on the local server using a select statement to get rows from a remote server.

Inserting multiple rows using the blocked INSERT statement

Using a blocked INSERT statement, you can insert multiple rows into a table with a single INSERT statement.

The blocked INSERT statement is supported in all of the languages except REXX. The data inserted into the table must be in a host structure array. If indicator variables are used with a blocked INSERT, they must also be in a host structure array.

For example, to add ten employees to the CORPDATA.EMPLOYEE table:

```
INSERT INTO CORPDATA.EMPLOYEE
          (EMPNO, FIRSTNME, MIDINIT, LASTNAME, WORKDEPT)
10 ROWS VALUES (:DSTRUCT:ISTRUCT)
```

DSTRUCT is a host structure array with five elements that is declared in the program. The five elements correspond to EMPNO, FIRSTNME, MIDINIT, LASTNAME, and WORKDEPT. DSTRUCT has a dimension of at least ten to accommodate inserting ten rows. ISTRUCT is a host structure array that is declared in the program. ISTRUCT has a dimension of at least ten small integer fields for the indicators.

Blocked INSERT statements are supported for non-distributed SQL applications and for distributed applications where both the application server and the application requester are IBM i products.

Related concepts

[Embedded SQL programming](#)

Inserting data into tables with referential constraints

When you insert data into tables with referential constraints, you need to consider these rules.

If you are inserting data into a parent table with a parent key, SQL does not allow:

- Duplicate values for the parent key
- If the parent key is a primary key, a null value for any column of the primary key

If you are inserting data into a dependent table with foreign keys:

- Each non-null value you insert into a foreign key column must be equal to some value in the corresponding parent key of the parent table.
- If any column in the foreign key is null, the entire foreign key is considered null. If all foreign keys that contain the column are null, the INSERT succeeds (as long as there are no unique index violations).

Alter the sample application project table (PROJECT) to define two foreign keys:

- A foreign key on the department number (DEPTNO) which references the department table

- A foreign key on the employee number (RESPEMP) which references the employee table.

```
ALTER TABLE CORPDATA.PROJECT ADD CONSTRAINT RESP_DEPT_EXISTS
    FOREIGN KEY (DEPTNO)
    REFERENCES CORPDATA.DEPARTMENT
    ON DELETE RESTRICT

ALTER TABLE CORPDATA.PROJECT ADD CONSTRAINT RESP_EMP_EXISTS
    FOREIGN KEY (RESPEMP)
    REFERENCES CORPDATA.EMPLOYEE
    ON DELETE RESTRICT
```

Notice that the parent table columns are not specified in the REFERENCES clause. The columns are not required to be specified as long as the referenced table has a primary key or eligible unique key which can be used as the parent key.

Every row inserted into the PROJECT table must have a value of DEPTNO that is equal to some value of DEPTNO in the department table. (The null value is not allowed because DEPTNO in the project table is defined as NOT NULL.) The row must also have a value of RESPEMP that is either equal to some value of EMPNO in the employee table or is null.

The following INSERT statement fails because there is no matching DEPTNO value ('A01') in the DEPARTMENT table.

```
INSERT INTO CORPDATA.PROJECT (PROJNO, PROJNAME, DEPTNO, RESPEMP)
VALUES ('AD3120', 'BENEFITS ADMIN', 'A01', '000010')
```

Likewise, the following INSERT statement is unsuccessful because there is no EMPNO value of '000011' in the EMPLOYEE table.

```
INSERT INTO CORPDATA.PROJECT (PROJNO, PROJNAME, DEPTNO, RESPEMP)
VALUES ('AD3130', 'BILLING', 'D21', '000011')
```

The following INSERT statement completes successfully because there is a matching DEPTNO value of 'E01' in the DEPARTMENT table and a matching EMPNO value of '000010' in the EMPLOYEE table.

```
INSERT INTO CORPDATA.PROJECT (PROJNO, PROJNAME, DEPTNO, RESPEMP)
VALUES ('AD3120', 'BENEFITS ADMIN', 'E01', '000010')
```

Inserting values into an identity column

You can insert a value into an identity column or allow the system to insert a value for you.

For example, a table has columns called ORDERNO (identity column), SHIPPED_TO (varchar(36)), and ORDER_DATE (date). You can insert a row into this table by issuing the following statement:

```
INSERT INTO ORDERS (SHIPPED_TO, ORDER_DATE)
VALUES ('BME TOOL', '2002-02-04')
```

In this case, a value is generated by the system for the identity column automatically. You can also write this statement using the DEFAULT keyword:

```
INSERT INTO ORDERS (SHIPPED_TO, ORDER_DATE, ORDERNO)
VALUES ('BME TOOL', '2002-02-04', DEFAULT)
```

After the insert, you can use the IDENTITY_VAL_LOCAL function to determine the value that the system assigned to the column.

Sometimes a value for an identity column is specified by the user, such as in this INSERT statement using a SELECT:

```
INSERT INTO ORDERS OVERRIDING USER VALUE
(SELECT * FROM TODAYS_ORDER)
```

In this case, **OVERRIDING USER VALUE** tells the system to ignore the value provided for the identity column from the **SELECT** and to generate a new value for the identity column. **OVERRIDING USER VALUE** must be used if the identity column was created with the **GENERATED ALWAYS** clause; it is optional for **GENERATED BY DEFAULT**. If **OVERRIDING USER VALUE** is not specified for a **GENERATED BY DEFAULT** identity column, the value provided for the column in the **SELECT** is inserted.

You can force the system to use the value from the select for a **GENERATED ALWAYS** identity column by specifying **OVERRIDING SYSTEM VALUE**. For example, issue the following statement:

```
INSERT INTO ORDERS OVERRIDING SYSTEM VALUE  
(SELECT * FROM TODAYS_ORDER)
```

This **INSERT** statement uses the value from **SELECT**; it does not generate a new value for the identity column. You cannot provide a value for an identity column created using **GENERATED ALWAYS** without using the **OVERRIDING SYSTEM VALUE** clause.

Related reference

[Creating and altering an identity column](#)

Every time a row is added to a table with an identity column, the identity column value for the new row is generated by the system.

[Scalar functions](#)

Selecting inserted values

You can retrieve the values for rows that are being inserted by specifying the **INSERT** statement in the **FROM** clause of a **SELECT** statement.

When you insert one or more rows into a table, you can select the result rows of the insert operation. These rows include any of the following values:

- The value of any generated column, such as identity, **ROWID**, or row change timestamp columns
- Any default values used for columns
- All values for all rows inserted by a multiple-row insert operation
- Values that were changed by a before insert trigger

The following example uses a table defined as follows:

```
CREATE TABLE EMPSAMP  
(EMPNO INTEGER GENERATED ALWAYS AS IDENTITY,  
NAME CHAR(30),  
SALARY DECIMAL(10,2),  
DEPTNO SMALLINT,  
LEVEL CHAR(30),  
HIRETYPE VARCHAR(30) NOT NULL DEFAULT 'New Employee',  
HIREDATE DATE NOT NULL WITH DEFAULT)
```

To insert a row for a new employee and see the values that were used for **EMPNO**, **HIRETYPE**, and **HIREDATE**, use the following statement:

```
SELECT EMPNO, HIRETYPE, HIREDATE  
FROM FINAL TABLE ( INSERT INTO EMPSAMP (NAME, SALARY, DEPTNO, LEVEL)  
VALUES('Mary Smith', 35000.00, 11, 'Associate'))
```

The returned values are the generated value for **EMPNO**, 'New Employee' for **HIRETYPE**, and the current date for **HIREDATE**.

Inserting data from a remote database

You can insert into a table on the local server using a select statement to get rows from a remote server.

To insert all the rows from the SALES table on REMOTESYS for sales made yesterday, use the following statement:

```
INSERT INTO SALES
  (SELECT * FROM REMOTESYS.TESTSCHEMA.SALES WHERE SALES_DATE = CURRENT DATE - 1 DAY)
```

Db2 for i will connect to REMOTESYS to run the SELECT, return the selected rows to the local system, and insert them into the local SALES table. The value for CURRENT DATE will be the current date on REMOTESYS.

Since a three-part object name or an alias that is defined to reference a three-part name of a table or view creates an implicit connection to the application server, a server authentication entry must exist. Use the Add Server Authentication Entry (ADDSVRAUTE) command on the application requestor specifying the server name, user ID, and password. The server name and user ID must be entered in upper case.

```
ADDSVRAUTE USRPRF(yourprf) SERVER(DRDASERVERNAME) USRID(YOURUID) PASSWORD(yourpwd)
```

See [Distributed Database Programming](#) for additional details on server authentication usage for DRDA.

Related reference

[Inserting rows using a select-statement](#)

You can use a select-statement within an INSERT statement to insert zero, one, or more rows into a table from the result table of the select-statement.

Changing data in a table using the UPDATE statement

To update data in a table or view, use the UPDATE statement.

With the UPDATE statement, you can change the value of one or more columns in each row that meets the search condition of the WHERE clause. The result of the UPDATE statement is one or more changed column values in zero or more rows of a table (depending on how many rows meet the search condition specified in the WHERE clause). The UPDATE statement looks like this:

```
UPDATE table-name
  SET column-1 = value-1,
      column-2 = value-2, ...
  WHERE search-condition ...
```

Suppose that an employee is relocated. To update the CORPDATA.EMPLOYEE table to reflect the move, run the following statement:

```
UPDATE CORPDATA.EMPLOYEE
  SET JOB = :PGM-CODE,
      PHONENO = :PGM-PHONE
  WHERE EMPNO = :PGM-SERIAL
```

Use the SET clause to specify a new value for each column that you want to update. The SET clause names the columns that you want updated and provides the values that you want them changed to. You can specify the following types of values:

- A **column name**. Replace the column's current value with the contents of another column in the same row.
- A **constant**. Replace the column's current value with the value provided in the SET clause.
- A **null value**. Replace the column's current value with the null value, using the keyword NULL. The column must be defined as capable of containing a null value when the table was created, or an error occurs.
- A **host variable**. Replace the column's current value with the contents of a host variable.
- A **global variable**. Replace the column's current value with the contents of a global variable.

- A **special register**. Replace the column's current value with a special register value; for example, USER.
- An **expression**. Replace the column's current value with the value that results from an expression.
- A **scalar fullselect**. Replace the column's current value with the value that the subquery returns.
- The **DEFAULT** keyword. Replace the column's current value with the default value of the column. The column must have a default value defined for it or allow the NULL value, or an error occurs.

The following UPDATE statement uses many different values:

```
UPDATE WORKTABLE
SET COL1 = 'ASC',
    COL2 = NULL,
    COL3 = :FIELD3,
    COL4 = CURRENT TIME,
    COL5 = AMT - 6.00,
    COL6 = COL7
WHERE EMPNO = :PGM-SERIAL
```

To identify the rows to be updated, use the WHERE clause:

- To update a single row, use a WHERE clause that selects only one row.
- To update several rows, use a WHERE clause that selects only the rows you want to update.

You can omit the WHERE clause. If you do, SQL updates each row in the table or view with the values you supply.

If the database manager finds an error while running your UPDATE statement, it stops updating and returns a negative SQLCODE. If you specify COMMIT(*ALL), COMMIT(*CS), COMMIT(*CHG), or COMMIT(*RR), no rows in the table are changed (rows already changed by this statement, if any, are restored to their previous values). If COMMIT(*NONE) is specified, any rows already changed are *not* restored to previous values.

If the database manager cannot find any rows that meet the search condition, an SQLCODE of +100 is returned.

Note: The UPDATE statement may have updated more than one row. The number of rows updated is reflected in SQLERRD(3) of the SQLCA. This value is also available from the ROW_COUNT diagnostics item in the GET DIAGNOSTICS statement.

The SET clause of an UPDATE statement can be used in many ways to determine the actual values to be set in each row being updated. The following example lists each column with its corresponding value:

```
UPDATE EMPLOYEE
SET WORKDEPT = 'D11',
    PHONENO = '7213',
    JOB = 'DESIGNER'
WHERE EMPNO = '000270'
```

You can also write this UPDATE statement by specifying all of the columns and then all of the values:

```
UPDATE EMPLOYEE
SET (WORKDEPT, PHONENO, JOB)
= ('D11', '7213', 'DESIGNER')
WHERE EMPNO = '000270'
```

Related reference

[UPDATE](#)

Updating a table using a scalar-subselect

Using a scalar-subselect, you can update one or more columns in a table with one or more values selected from another table.

In the following example, an employee moves to a different department but continues working on the same projects. The employee table has already been updated to contain the new department number.

Now the project table needs to be updated to reflect the new department number of this employee (employee number is '000030').

```
UPDATE PROJECT
SET DEPTNO =
  (SELECT WORKDEPT FROM EMPLOYEE
   WHERE PROJECT.RESPEMP = EMPLOYEE.EMPNO)
WHERE RESPEMP='000030'
```

This same technique can be used to update a list of columns with multiple values returned from a single select.

Updating a table with rows from another table

You can update an entire row in one table with values from a row in another table.

Suppose that a master class schedule table needs to be updated with changes that have been made in a copy of the table. The changes are made to the work copy and merged into the master table every night. The two tables have exactly the same columns and one column, CLASS_CODE, is a unique key column.

```
UPDATE CL_SCHED
SET ROW =
  (SELECT * FROM MYCOPY
   WHERE CL_SCHED.CLASS_CODE = MYCOPY.CLASS_CODE)
```

This update will update all of the rows in CL_SCHED with the values from MYCOPY.

Updating tables with referential constraints

If you are updating a parent table, you cannot modify a primary key for which dependent rows exist.

Changing the key violates referential constraints for dependent tables and leaves some rows without a parent. Furthermore, you cannot give any part of a primary key a null value.

Update rules

The action taken on dependent tables when an UPDATE is performed on a parent table depends on the update rule specified for the referential constraint. If no update rule was defined for a referential constraint, the UPDATE NO ACTION rule is used.

UPDATE NO ACTION

Specifies that the row in the parent table can be updated if no other row depends on it. If a dependent row exists in the relationship, the UPDATE fails. The check for dependent rows is performed at the end of the statement.

UPDATE RESTRICT

Specifies that the row in the parent table can be updated if no other row depends on it. If a dependent row exists in the relationship, the UPDATE fails. The check for dependent rows is performed immediately.

The subtle difference between the RESTRICT rule and the NO ACTION rule is easiest seen when looking at the interaction of triggers and referential constraints. Triggers can be defined to fire either before or after an operation (an UPDATE statement, in this case). A *before trigger* fires before the UPDATE is performed and therefore before any checking of constraints. An *after trigger* is fired after the UPDATE is performed, and after a constraint rule of RESTRICT (where checking is performed immediately), but before a constraint rule of NO ACTION (where checking is performed at the end of the statement). The triggers and rules occur in the following order:

1. A *before trigger* is fired before the UPDATE and before a constraint rule of RESTRICT or NO ACTION.
2. An *after trigger* is fired after a constraint rule of RESTRICT, but before a NO ACTION rule.

If you are updating a *dependent* table, any non-null foreign key values that you change must match the primary key for each relationship in which the table is a dependent. For example, department numbers

in the employee table depend on the department numbers in the department table. You can assign an employee to no department (the null value), but not to a department that does not exist.

If an UPDATE against a table with a referential constraint fails, all changes made during the update operation are undone.

Related reference

Journaling

The Db2 for i journal support provides an audit trail and forward and backward recovery.

Commitment control

The Db2 for i commitment control support provides a means for processing a group of database changes, such as update, insert, or delete operations or data definition language (DDL) operations, as a single unit of work (also referred to as a *transaction*).

Examples: UPDATE rules

These examples illustrate the UPDATE rules for tables with referential constraints.

For example, you cannot update a department number from the DEPARTMENT table if the department is still responsible for a project that is described by a dependent row in the PROJECT table.

The following UPDATE statement fails because the PROJECT table has rows that are dependent on DEPARTMENT.DEPTNO that has a value of 'D01' (the row targeted by the WHERE statement). If this UPDATE statement were to be allowed, the referential constraint between the PROJECT and DEPARTMENT tables would be broken.

```
UPDATE CORPDATA.DEPARTMENT
SET DEPTNO = 'D99'
WHERE DEPTNAME = 'DEVELOPMENT CENTER'
```

The following statement fails because it violates the referential constraint that exists between the primary key DEPTNO in DEPARTMENT and the foreign key DEPTNO in PROJECT:

```
UPDATE CORPDATA.PROJECT
SET DEPTNO = 'D00'
WHERE DEPTNO = 'D01';
```

The statement attempts to change all department numbers of D01 to department number D00. Because D00 is not a value of the primary key DEPTNO in DEPARTMENT, the statement fails.

Updating an identity column

You can update the value in an identity column to a specified value or have the system generate a new value.

For example, using the table with columns called ORDERNO (identity column), SHIPPED_TO (varchar(36)), and ORDER_DATE (date), you can update the value in an identity column by issuing the following statement:

```
UPDATE ORDERS
SET (ORDERNO, ORDER_DATE)=
(DEFAULT, 2002-02-05)
WHERE SHIPPED_TO = 'BME TOOL'
```

A value is generated by the system for the identity column automatically. You can override having the system generate a value by using the OVERRIDING SYSTEM VALUE clause:

```
UPDATE ORDERS OVERRIDING SYSTEM VALUE
SET (ORDERNO, ORDER_DATE)=
(553, '2002-02-05')
WHERE SHIPPED_TO = 'BME TOOL'
```

Related reference

[Creating and altering an identity column](#)

Every time a row is added to a table with an identity column, the identity column value for the new row is generated by the system.

Updating data as it is retrieved from a table

You can update rows of data as you retrieve them by using a cursor.

On the select-statement, use FOR UPDATE OF followed by a list of columns that may be updated. Then use the cursor-controlled UPDATE statement. The WHERE CURRENT OF clause names the cursor that points to the row you want to update. If a FOR UPDATE OF, an ORDER BY, a FOR READ ONLY, or a SCROLL clause without the DYNAMIC clause is not specified, all columns can be updated.

If a multiple-row FETCH statement has been specified and run, the cursor is positioned on the last row of the block. Therefore, if the WHERE CURRENT OF clause is specified on the UPDATE statement, the last row in the block is updated. If a row within the block must be updated, the program must first position the cursor on that row. Then the UPDATE WHERE CURRENT OF can be specified. Consider the following example:

Table 33. Updating a table

Scrollable Cursor SQL Statement	Comments
<pre>EXEC SQL DECLARE THISEMP DYNAMIC SCROLL CURSOR FOR SELECT EMPNO, WORKDEPT, BONUS FROM CORPDATA.EMPLOYEE WHERE WORKDEPT = 'D11' FOR UPDATE OF BONUS END-EXEC.</pre>	
<pre>EXEC SQL OPEN THISEMP END-EXEC.</pre>	
<pre>EXEC SQL WHENEVER NOT FOUND GO TO CLOSE-THISEMP END-EXEC.</pre>	
<pre>EXEC SQL FETCH NEXT FROM THISEMP FOR 5 ROWS INTO :DEPTINFO :IND-ARRAY END-EXEC.</pre>	DEPTINFO and IND-ARRAY are declared in the program as a host structure array and an indicator array.
<p>... determine if any employees in department D11 receive a bonus less than \$500.00. If so, update that record to the new minimum of \$500.00.</p>	
<pre>EXEC SQL FETCH RELATIVE :NUMBACK FROM THISEMP END-EXEC.</pre>	... positions to the record in the block to update by fetching in the reverse order.
<pre>EXEC SQL UPDATE CORPDATA.EMPLOYEE SET BONUS = 500 WHERE CURRENT OF THISEMP END-EXEC.</pre>	... updates the bonus for the employee in department D11 that is under the new \$500.00 minimum.

Table 33. Updating a table (continued)

Scrollable Cursor SQL Statement	Comments
<pre>EXEC SQL FETCH RELATIVE :NUMBACK FROM THISEMP FOR 5 ROWS INTO :DEPTINFO :IND-ARRAY END-EXEC.</pre>	... positions to the beginning of the same block that was already fetched and fetches the block again. (NUMBACK -(5 - NUMBACK - 1))
... branch back to determine if any more employees in the block have a bonus under \$500.00.	
... branch back to fetch and process the next block of rows.	
<pre>CLOSE-THISEMP. EXEC SQL CLOSE THISEMP END-EXEC.</pre>	

Related reference

Using a cursor

When SQL runs a SELECT statement, the resulting rows comprise the result table. A cursor provides a way to access a result table.

Removing rows from a table using the DELETE statement

To remove rows from a table, use the DELETE statement.

When you delete a row, you remove the entire row. The DELETE statement does not remove specific columns from the row. The result of the DELETE statement is the removal of zero or more rows of a table, depending on how many rows satisfy the search condition specified in the WHERE clause. If you omit the WHERE clause from a DELETE statement, SQL removes all the rows from the table. The DELETE statement looks like this:

```
DELETE FROM table-name
WHERE search-condition ...
```

For example, suppose that department D11 is moved to another site. You delete each row in the CORPDATA.EMPLOYEE table with a WORKDEPT value of D11 as follows:

```
DELETE FROM CORPDATA.EMPLOYEE
WHERE WORKDEPT = 'D11'
```

The WHERE clause tells SQL which rows you want to delete from the table. SQL deletes all the rows that satisfy the search condition from the base table. Deleting rows from a view deletes the rows from the base table. You can omit the WHERE clause, but it is best to include one, because a DELETE statement without a WHERE clause deletes all the rows from the table or view. To delete a table definition as well as the table contents, issue the DROP statement.

If SQL finds an error while running your DELETE statement, it stops deleting data and returns a negative SQLCODE. If you specify COMMIT(*ALL), COMMIT(*CS), COMMIT(*CHG), or COMMIT(*RR), no rows in the table are deleted (rows already deleted by this statement, if any, are restored to their previous values). If COMMIT(*NONE) is specified, any rows already deleted are *not* restored to their previous values.

If SQL cannot find any rows that satisfy the search condition, an SQLCODE of +100 is returned.

Note: The DELETE statement may have deleted more than one row. The number of rows deleted is reflected in SQLERRD(3) of the SQLCA. This value is also available from the ROW_COUNT diagnostics item in the GET DIAGNOSTICS statement.

Related concepts

[Removing rows from a table using the TRUNCATE statement](#)

To remove all the rows from a table, use the TRUNCATE statement.

Related reference

[DROP](#)

[DELETE](#)

Removing rows from tables with referential constraints

If a table has a primary key but no dependents, or if a table has only foreign keys but no primary key, the DELETE statement operates the same way as it does for tables without referential constraints. If a table has a primary key and dependent tables, the DELETE statement operates according to the delete rules specified for the table.

All delete rules of all affected relationships must be satisfied in order for the delete operation to succeed. If a referential constraint is violated, the DELETE operation fails.

The action to be taken on dependent tables when a DELETE is performed on a parent table depends on the delete rule specified for the referential constraint. If no delete rule was defined, the DELETE NO ACTION rule is used.

DELETE NO ACTION

Specifies that the row in the parent table can be deleted if no other row depends on it. If a dependent row exists in the relationship, the DELETE fails. The check for dependent rows is performed at the end of the statement.

DELETE RESTRICT

Specifies that the row in the parent table can be deleted if no other row depends on it. If a dependent row exists in the relationship, the DELETE fails. The check for dependent rows is performed immediately.

For example, you cannot delete a department from the department table if it is still responsible for some project that is described by a dependent row in the project table.

DELETE CASCADE

Specifies that first the designated rows in the parent table are deleted. Then, the dependent rows are deleted.

For example, you can delete a department by deleting its row in the department table. Deleting the row from the department table also deletes:

- The rows for all departments that report to it
- All departments that report to those departments and so forth.

DELETE SET NULL

Specifies that each nullable column of the foreign key in each dependent row is set to its default value. This means that the column is only set to its default value if it is a member of a foreign key that references the row being deleted. Only the dependent rows that are immediate descendents are affected.

DELETE SET DEFAULT

Specifies that each column of the foreign key in each dependent row is set to its default value. This means that the column is only set to its default value if it is a member of a foreign key that references the row being deleted. Only the dependent rows that are immediate descendants are affected.

For example, you can delete an employee from the employee table (EMPLOYEE) even if the employee manages some department. In that case, the value of MGRNO for each employee who reported to the manager is set to blanks in the department table (DEPARTMENT). If some other default value was specified on the create of the table, that value is used.

This is due to the REPORTS_TO_EXISTS constraint defined for the department table.

If a descendent table has a delete rule of RESTRICT or NO ACTION and a row is found such that a descendant row cannot be deleted, the entire DELETE fails.

When running this statement with a program, the number of rows deleted is returned in SQLERRD(3) in the SQLCA. This number includes only the number of rows deleted in the table specified in the DELETE statement. It does not include those rows deleted according to the CASCADE rule. SQLERRD(5) in the SQLCA contains the number of rows that were affected by referential constraints in all tables. The SQLERRD(3) value is also available from the ROW_COUNT item in the GET DIAGNOSTICS statement. The SQLERRD(5) value is available from the DB2_ROW_COUNT_SECONDARY item.

The subtle difference between RESTRICT and NO ACTION rules is easiest seen when looking at the interaction of triggers and referential constraints. Triggers can be defined to fire either before or after an operation (a DELETE statement, in this case). A *before trigger* fires before the DELETE is performed and therefore before any checking of constraints. An *after trigger* is fired after the DELETE is performed, and after a constraint rule of RESTRICT (where checking is performed immediately), but before a constraint rule of NO ACTION (where checking is performed at the end of the statement). The triggers and rules occur in the following order:

1. A *before trigger* is fired before the DELETE and before a constraint rule of RESTRICT or NO ACTION.
2. An *after trigger* is fired after a constraint rule of RESTRICT, but before a NO ACTION rule.

Example: DELETE rules

Suppose that deleting a department from the DEPARTMENT table sets WORKDEPT in the EMPLOYEE table to null for every employee assigned to that department.

Consider the following DELETE statement:

```
DELETE FROM CORPDATA.DEPARTMENT
WHERE DEPTNO = 'E11'
```

Given the tables and the data in the “Db2 for i sample tables” on page 367, one row is deleted from table DEPARTMENT, and table EMPLOYEE is updated to set the value of WORKDEPT to its default wherever the value was 'E11'. A question mark (?) in the following sample data reflects the null value. The results appear as follows:

Table 34. DEPARTMENT table. Contents of the table after the DELETE statement is complete.

DEPTNO	DEPTNAME	MGRNO	ADMRDEPT
A00	SPIFFY COMPUTER SERVICE DIV.	000010	A00
B01	PLANNING	000020	A00
C01	INFORMATION CENTER	000030	A00
D01	DEVELOPMENT CENTER	?	A00
D11	MANUFACTURING SYSTEMS	000060	D01
D21	ADMINISTRATION SYSTEMS	000070	D01
E01	SUPPORT SERVICES	000050	A00
E21	SOFTWARE SUPPORT	000100	E01
F22	BRANCH OFFICE F2	?	E01
G22	BRANCH OFFICE G2	?	E01
H22	BRANCH OFFICE H2	?	E01
I22	BRANCH OFFICE I2	?	E01
J22	BRANCH OFFICE J2	?	E01

Note that there were no cascaded delete operations in the DEPARTMENT table because no department reported to department 'E11'.

Below are the snapshots of one affected portion of the EMPLOYEE table before and after the DELETE statement is completed.

Table 35. Partial EMPLOYEE table. Partial contents before the DELETE statement.

EMPNO	FIRSTNME	MI	LASTNAME	WORKDEPT	PHONENO	HIREDATE
000230	JAMES	J	JEFFERSON	D21	2094	1966-11-21
000240	SALVATORE	M	MARINO	D21	3780	1979-12-05
000250	DANIEL	S	SMITH	D21	0961	1960-10-30
000260	SYBIL	P	JOHNSON	D21	8953	1975-09-11
000270	MARIA	L	PEREZ	D21	9001	1980-09-30
000280	ETHEL	R	SCHNEIDER	E11	0997	1967-03-24
000290	JOHN	R	PARKER	E11	4502	1980-05-30
000300	PHILIP	X	SMITH	E11	2095	1972-06-19
000310	MAUDE	F	SETRIGHT	E11	3332	1964-09-12
000320	RAMLAL	V	MEHTA	E21	9990	1965-07-07
000330	WING		LEE	E21	2103	1976-02-23
000340	JASON	R	GOUNOT	E21	5696	1947-05-05

Table 36. Partial EMPLOYEE table. Partial contents after the DELETE statement.

EMPNO	FIRSTNME	MI	LASTNAME	WORKDEPT	PHONENO	HIREDATE
000230	JAMES	J	JEFFERSON	D21	2094	1966-11-21
000240	SALVATORE	M	MARINO	D21	3780	1979-12-05
000250	DANIEL	S	SMITH	D21	0961	1960-10-30
000260	SYBIL	P	JOHNSON	D21	8953	1975-09-11
000270	MARIA	L	PEREZ	D21	9001	1980-09-30
000280	ETHEL	R	SCHNEIDER	?	0997	1967-03-24
000290	JOHN	R	PARKER	?	4502	1980-05-30
000300	PHILIP	X	SMITH	?	2095	1972-06-19
000310	MAUDE	F	SETRIGHT	?	3332	1964-09-12
000320	RAMLAL	V	MEHTA	E21	9990	1965-07-07
000330	WING		LEE	E21	2103	1976-02-23
000340	JASON	R	GOUNOT	E21	5696	1947-05-05

Removing rows from a table using the TRUNCATE statement

To remove all the rows from a table, use the TRUNCATE statement.

The TRUNCATE statement looks like this:

```
TRUNCATE TABLE table-name
```

This is equivalent to the following DELETE statement:

```
DELETE FROM table-name
```

The TRUNCATE statement has some additional options that are not available on the DELETE statement to control how triggers are handled during the truncation operation and the behavior of the table's identity column after truncation is complete.

The default for TRUNCATE is to not activate any delete triggers during truncation. If you want delete triggers to be activated, you must use the DELETE statement.

For an identity column, you can specify to either continue generating identity values in the same way as if the truncate operation did not occur, or you can request to have the identity column start from its initial value when it was first defined. The default is to continue generating values.

Note: The TRUNCATE statement does not return the number of rows deleted in SQLERRD(3) of the SQLCA or the ROW_COUNT diagnostics item in the GET DIAGNOSTICS statement.

Related concepts

[Removing rows from a table using the DELETE statement](#)

To remove rows from a table, use the DELETE statement.

Related reference

[TRUNCATE](#)

Merging data

Use the MERGE statement to conditionally insert, update, or delete rows in a table or view.

You can use the MERGE statement to update a target table from another table, a derived table, or any other table-reference. This other table is called the source table. The simplest form of a source table is a list of values.

Based on whether or not a row from the source table exists in the target table, the MERGE statement can insert a new row, or update or delete the matching row.

The most basic form of a MERGE statement is one where a new row is to be inserted if it doesn't already exist, or updated if it does exist. Rather than attempting the insert or update and, based on the SQLCODE or SQLSTATE, then trying the other option, by using the MERGE statement the appropriate action will be performed.

In this example, you want to add or replace a row for a department. If the department does not already exist, a row will be inserted. If the department does exist, information for the department will be updated.

```
MERGE INTO DEPARTMENT USING  
  (VALUES ('K22', 'BRANCH OFFICE K2', 'E01')) INSROW (DEPTNO, DEPTNAME, ADMRDEPT)  
ON DEPARTMENT.DEPTNO = INSROW.DEPTNO  
WHEN NOT MATCHED THEN  
  INSERT VALUES(INSROW.DEPTNO, INSROW.DEPTNAME, NULL, INSROW.ADMRDEPT, NULL)  
WHEN MATCHED THEN  
  UPDATE SET DEPTNAME = INSROW.DEPTNAME, ADMRDEPT = INSROW.ADMRDEPT
```

Suppose you have a temporary table that is a copy of the EMP_PHOTO table. In this table, you have added photo information for new employees and updated the photo for existing employees. The temporary table only contains changes, no rows for unchanged photo information.

To merge these updates into the master EMP_PHOTO table, you can use the following MERGE statement.

```
MERGE INTO EMP_PHOTO target USING TEMP_EMP_PHOTO source  
  ON target.EMPNO = source.EMPNO  
    AND target.PHOTO_FORMAT = source.PHOTO_FORMAT  
WHEN NOT MATCHED THEN  
  INSERT VALUES(EMPNO, PHOTO_FORMAT, PICTURE)  
WHEN MATCHED THEN  
  UPDATE SET PICTURE = source.PICTURE
```

When this statement is run, the rows in the target table are compared to the rows in the source table using the EMPNO and PHOTO_FORMAT columns. These are the columns that make up the primary key for the table, so they guarantee uniqueness. Any row that is in the source table that does not have a matching EMPNO and PHOTO_FORMAT row in the target table (NOT MATCHED) will perform the INSERT action. In this case, it will insert a new row into the target table containing the EMPNO, PHOTO_FORMAT, and PICTURE values from the source table. Any row in the source table that already has a corresponding row in the target table (MATCHED) will have the target table's row updated with the PICTURE value from the source table.

To make the merge a little bit more complex, let's add a column to the EMP_PHOTO table.

```
ALTER TABLE EMP_PHOTO ADD COLUMN LAST_CHANGED TIMESTAMP
GENERATED BY DEFAULT FOR EACH ROW ON UPDATE AS ROW CHANGE TIMESTAMP
```

Now, let us assume that the person who maintains the TEMP_EMP_PHOTO table has some rows in the temporary table that have already been merged into the master copy of the EMP_PHOTO table. When doing the MERGE, you don't want to update the same rows again since the values have not changed. It is also possible that someone else has updated the master EMP_PHOTO with a more recent picture.

```
MERGE INTO EMP_PHOTO target USING TEMP_EMP_PHOTO source
ON target.EMPNO = source.EMPNO
AND target.PHOTO_FORMAT = source.PHOTO_FORMAT
WHEN NOT MATCHED THEN
INSERT VALUES(EMPNO, PHOTO_FORMAT, PICTURE, LAST_CHANGED)
WHEN MATCHED AND target.LAST_CHANGED < source.LAST_CHANGED THEN
UPDATE SET PICTURE = source.PICTURE,
LAST_CHANGED = source.LAST_CHANGED
```

This statement has an extra condition added to the MATCHED clause. Adding the comparison of the LAST_CHANGED column will prevent the master EMP_PHOTO table from being updated with a photo that has a timestamp older than the current master's timestamp.

Using subqueries

You can use subqueries in a search condition as another way to select data. Subqueries can be used anywhere an expression can be used.

Conceptually, a subquery is evaluated whenever a new row or a group of rows must be processed. In fact, if the subquery is the same for every row or group, it is evaluated only once. Subqueries like this are said to be **uncorrelated**.

Some subqueries return different values from row to row or group to group. The mechanism that allows this is called **correlation**, and the subqueries are said to be **correlated**.

Related reference

[Expressions in the WHERE clause](#)

An expression in a WHERE clause names or specifies something that you want to compare to something else.

[Defining complex search conditions](#)

In addition to the basic comparison predicates, such as = and >, a search condition can contain any of these predicates: BETWEEN, IN, EXISTS, IS NULL, and LIKE.

Subqueries in SELECT statements

Subqueries further refine your search conditions in SELECT statements.

In simple WHERE and HAVING clauses, you can specify a search condition by using a literal value, a column name, an expression, or a special register. In those search conditions, you know that you are searching for a specific value. However, sometimes you cannot supply that value until you have retrieved other data from a table. For example, suppose you want a list of the employee numbers, names, and job

codes of all employees working on a particular project, say project number MA2100. The first part of the statement is easy to write:

```
SELECT EMPNO, LASTNAME, JOB
FROM CORPDATA.EMPLOYEE
WHERE EMPNO ...
```

But you cannot go further because the CORPDATA.EMPLOYEE table does not include project number data. You do not know which employees are working on project MA2100 without issuing another SELECT statement against the CORPDATA.EMP_ACT table.

With SQL, you can nest one SELECT statement within another to solve this problem. The inner SELECT statement is called a **subquery**. The SELECT statement surrounding the subquery is called the **outer-level SELECT**. Using a subquery, you can issue just one SQL statement to retrieve the employee numbers, names, and job codes for employees who work on the project MA2100:

```
SELECT EMPNO, LASTNAME, JOB
FROM CORPDATA.EMPLOYEE
WHERE EMPNO IN
  (SELECT EMPNO
   FROM CORPDATA.EMPPROJECT
   WHERE PROJNO = 'MA2100')
```

To better understand what will result from this SQL statement, imagine that SQL goes through the following process:

Step 1: SQL evaluates the subquery to obtain a list of EMPNO values:

```
(SELECT EMPNO
 FROM CORPDATA.EMPPROJECT
 WHERE PROJNO= 'MA2100')
```

The result in an interim result table follows.

EMPNO from CORPDATA.EMPPROJECT

000010

000110

Step 2: The interim result table then serves as a list in the search condition of the outer-level SELECT statement. Essentially, this is the statement that is run:

```
SELECT EMPNO, LASTNAME, JOB
FROM CORPDATA.EMPLOYEE
WHERE EMPNO IN
  ('000010', '000110')
```

The final result table looks like this.

EMPNO	LASTNAME	JOB
000010	HAAS	PRES
000110	LUCCHESSI	SALESREP

Subqueries and search conditions

A subquery can be part of a search condition. The search condition is in the form of *operand operator operand*. Either operand can be a subquery.

In the following example, the first **operand** is EMPNO and **operator** is IN. The search condition can be part of a WHERE or HAVING clause. The clause can include more than one search condition that contains a subquery. A search condition that contains a subquery, like any other search condition, can be enclosed in parentheses, can be preceded by the keyword NOT, and can be linked to other search conditions

through the keywords AND and OR. For example, the WHERE clause of a query can look something like this:

```
WHERE (subquery1) = X AND (Y > SOME (subquery2) OR Z = 100)
```

Subqueries can also appear in the search conditions of other subqueries. Such subqueries are said to be **nested** at some level of nesting. For example, a subquery within a subquery within an outer-level SELECT is nested at a nesting level of two. SQL allows nesting down to a nesting level of 32.

Usage notes on subqueries

Here are some considerations for using subqueries to refine your search conditions.

1. When nesting SELECT statements, you can use as many as you need to satisfy your requirements (1 to 255 subqueries), although performance is slower for each additional subquery.
2. For predicates that use the keywords ALL, ANY, SOME, or EXISTS, the number of rows returned from the subquery can vary from zero to many. For all other subqueries, the number of rows returned must be zero or one.
3. For the following predicates, a row fullselect can be used for the subquery. This means that the subquery can return more than one value for a row.
 - Basic predicate with equal or not equal comparisons
 - Quantified predicates using =ANY, =ALL, and =SOME
 - IN and NOT IN predicates

If a row fullselect is used:

- The select list must not contain SELECT *. Explicit values must be specified.
 - A row fullselect must be compared to a row expression. A row expression is a list of values enclosed in parentheses. There must be the same number of values returned from the subquery as there are in the row expression.
 - The row expression for an IN or NOT IN predicate cannot contain an untyped parameter marker. Use CAST to supply a result data type for these parameter markers.
 - The subquery cannot contain UNION, EXCEPT, or INTERSECT or a correlated reference.
4. A subquery cannot include the ORDER BY, FOR READ ONLY, FETCH FIRST *n* ROWS, UPDATE, or OPTIMIZE clause.

Including subqueries in the WHERE or HAVING clause

You can include a subquery in a WHERE or HAVING clause by using a basic or quantified comparison, the IN keyword, or the EXISTS keyword.

Basic comparisons

You can use a subquery before or after any of the comparison operators. The subquery can return only one row. It can return multiple values for the row if the equal or not equal operators are used. SQL compares each value from the subquery row with the corresponding value on the other side of the comparison operator. For example, suppose that you want to find the employee numbers, names, and salaries for employees whose education level is higher than the average education level throughout the company.

```
SELECT EMPNO, LASTNAME, SALARY
FROM CORPDATA.EMPLOYEE
WHERE EDLEVEL >
      (SELECT AVG(EDLEVEL)
       FROM CORPDATA.EMPLOYEE)
```

SQL first evaluates the subquery and then substitutes the result in the WHERE clause of the SELECT statement. In this example, the result is the company-wide average educational level. Besides returning a single row, a subquery can return no rows. If it does, the result of the compare is unknown.

Quantified comparisons (ALL, ANY, and SOME)

You can use a subquery after a comparison operator followed by the keyword ALL, ANY, or SOME. When used in this way, the subquery can return zero, one, or many rows, including null values. You can use ALL, ANY, and SOME in the following ways:

- Use ALL to indicate that the value you supplied must compare in the indicated way to **ALL** the rows the subquery returns. For example, suppose you use the greater-than comparison operator with ALL:

```
... WHERE expression > ALL (subquery)
```

To satisfy this WHERE clause, the value of the expression must be greater than the result for each of the rows (that is, greater than the highest value) returned by the subquery. If the subquery returns an empty set (that is, no rows were selected), the condition is satisfied.

- Use ANY or SOME to indicate that the value you supplied must compare in the indicated way to *at least one* of the rows the subquery returns. For example, suppose you use the greater-than comparison operator with **ANY**:

```
... WHERE expression > ANY (subquery)
```

To satisfy this WHERE clause, the value in the expression must be greater than at least one of the rows (that is, greater than the lowest value) returned by the subquery. If what the subquery returns is the empty set, the condition is not satisfied.

Note: The results when a subquery returns one or more null values may surprise you, unless you are familiar with formal logic.

IN keyword

You can use IN to say that the value in the expression must be among the rows returned by the subquery. Using IN is equivalent to using =ANY or =SOME. Using ANY and SOME were previously described. You can also use the IN keyword with the NOT keyword in order to select rows when the value is not among the rows returned by the subquery. For example, you can use:

```
... WHERE WORKDEPT NOT IN (SELECT ...)
```

EXISTS keyword

In the subqueries presented so far, SQL evaluates the subquery and uses the result as part of the WHERE clause of the outer-level SELECT. In contrast, when you use the keyword EXISTS, SQL checks whether the subquery returns one or more rows. If it does, the condition is satisfied. If it returns no rows, the condition is not satisfied. For example:

```
SELECT EMPNO, LASTNAME
FROM CORPDATA.EMPLOYEE
WHERE EXISTS
  (SELECT *
   FROM CORPDATA.PROJECT
   WHERE PRSTDATE > '1982-01-01');
```

In the example, the search condition is true if any project represented in the CORPDATA.PROJECT table has an estimated start date that is later than January 1, 1982. This example does not show the full power of EXISTS, because the result is always the same for every row examined for the outer-level SELECT. As a consequence, either every row appears in the results, or none appear. In a more powerful example, the subquery itself would be correlated, and change from row to row.

As shown in the example, you do not need to specify column names in the select-list of the subquery of an EXISTS clause. Instead, you should code SELECT *.

You can also use the EXISTS keyword with the NOT keyword in order to select rows when the data or condition you specify does not exist. You can use the following:

```
... WHERE NOT EXISTS (SELECT ...)
```

Correlated subqueries

A *correlated subquery* is a subquery that SQL might need to re-evaluate when it examines each new row (the WHERE clause) or each group of rows (the HAVING clause) in the outer-level SELECT statement.

Correlated names and references

A correlated reference can appear in a search condition in a subquery. The reference is always in the form of X.C, where X is a correlation name and C is the name of a column in the table that X represents.

You can define a correlation name for any table appearing in a FROM clause. A correlation name provides a unique name for a table in a query. The same table name can be used many times within a query and its nested subselects. Specifying different correlation names for each table reference makes it possible to uniquely designate which table a column refers to.

The correlation name is defined in the FROM clause of a query. This query can be the outer-level SELECT, or any of the subqueries that contain the one with the reference. Suppose, for example, that a query contains subqueries A, B, and C, and that A contains B and B contains C. Then a correlation name used in C can be defined in B, A, or the outer-level SELECT. To define a correlation name, include the correlation name after the table name. Leave one or more blanks between a table name and its correlation name, and place a comma after the correlation name if it is followed by another table name. The following FROM clause defines the correlation names TA and TB for the tables TABLEA and TABLEB, and no correlation name for the table TABLEC.

```
FROM TABLEA TA, TABLEC, TABLEB TB
```

Any number of correlated references can appear in a subquery. For example, one correlated name in a search condition can be defined in the outer-level SELECT, while another can be defined in a containing subquery.

Before the subquery is executed, a value from the referenced column is always substituted for the correlated reference.

Example: Correlated subquery in a WHERE clause

Suppose that you want a list of all the employees whose education levels are higher than the average education levels in their respective departments. To get this information, SQL must search the CORPDATA.EMPLOYEE table.

For each employee in the table, SQL needs to compare the employee's education level to the average education level for the employee's department. In the subquery, you tell SQL to calculate the average education level for the department number in the current row. For example:

```
SELECT EMPNO, LASTNAME, WORKDEPT, EDLEVEL
FROM CORPDATA.EMPLOYEE X
WHERE EDLEVEL >
  (SELECT AVG(EDLEVEL)
   FROM CORPDATA.EMPLOYEE
   WHERE WORKDEPT = X.WORKDEPT)
```

A correlated subquery looks like an uncorrelated one, except for the presence of one or more correlated references. In the example, the single correlated reference is the occurrence of X.WORKDEPT in the subselect's FROM clause. Here, the qualifier X is the correlation name defined in the FROM clause of the outer SELECT statement. In that clause, X is introduced as the correlation name of the table CORPDATA.EMPLOYEE.

Now, consider what happens when the subquery is executed for a given row of CORPDATA.EMPLOYEE. Before it is executed, the occurrence of X.WORKDEPT is replaced with the value of the WORKDEPT

column for that row. Suppose, for example, that the row is for CHRISTINE I HAAS. Her work department is A00, which is the value of WORKDEPT for this row. The subquery executed for this row is:

```
(SELECT AVG(EDLEVEL)
FROM CORPDATA.EMPLOYEE
WHERE WORKDEPT = 'A00')
```

Thus, for the row considered, the subquery produces the average education level of Christine's department. This is then compared in the outer statement to Christine's own education level. For some other row for which WORKDEPT has a different value, that value appears in the subquery in place of A00. For example, for the row for MICHAEL L THOMPSON, this value is B01, and the subquery for his row delivers the average education level for department B01.

The result table produced by the query has the following values.

Table 37. Result set for previous query

EMPNO	LASTNAME	WORKDEPT	EDLEVEL
000010	HAAS	A00	18
000030	KWAN	C01	20
000070	PULASKI	D21	16
000090	HENDERSON	E11	16
000110	LUCCHESSI	A00	19
000160	PIANKA	D11	17
000180	SCOUTTEN	D11	17
000210	JONES	D11	17
000220	LUTZ	D11	18
000240	MARINO	D21	17
000260	JOHNSON	D21	16
000280	SCHNEIDER	E11	17
000320	MEHTA	E21	16
000340	GOUNOT	E21	16
200010	HEMMINGER	A00	18
200220	JOHN	D11	18
200240	MONTEVERDE	D21	17
200280	SCHWARTZ	E11	17
200340	ALONZO	E21	16

Example: Correlated subquery in a HAVING clause

Suppose that you want a list of all the departments whose average salaries are higher than the average salaries of their areas (all departments whose WORKDEPT begins with the same letter belong to the same area). To get this information, SQL must search the CORPDATA.EMPLOYEE table.

For each department in the table, SQL compares the department's average salary to the average salary of the area. In the subquery, SQL calculates the average salary for the area of the department in the current group. For example:

```
SELECT WORKDEPT, DECIMAL(AVG(SALARY),8,2)
FROM CORPDATA.EMPLOYEE X
```

```

GROUP BY WORKDEPT
HAVING AVG(SALARY) >
  (SELECT AVG(SALARY)
   FROM CORPDATA.EMPLOYEE
   WHERE SUBSTR(X.WORKDEPT,1,1) = SUBSTR(WORKDEPT,1,1))

```

Consider what happens when the subquery is executed for a given department of CORPDATA.EMPLOYEE. Before it is executed, the occurrence of X.WORKDEPT is replaced with the value of the WORKDEPT column for that group. Suppose, for example, that the first group selected has A00 for the value of WORKDEPT. The subquery executed for this group is:

```

(SELECT AVG(SALARY)
 FROM CORPDATA.EMPLOYEE
 WHERE SUBSTR('A00',1,1) = SUBSTR(WORKDEPT,1,1))

```

Thus, for the group considered, the subquery produces the average salary for the area. This value is then compared in the outer statement to the average salary for department 'A00'. For some other group for which WORKDEPT is 'B01', the subquery results in the average salary for the area where department B01 belongs.

The result table produced by the query has the following values.

WORKDEPT	AVG SALARY
D21	25668.57
E01	40175.00
E21	24086.66

Example: Correlated subquery in a select-list

Suppose that you want a list of all the departments, including the department name, number, and manager's name.

Department names and numbers are found in the CORPDATA.DEPARTMENT table. However, DEPARTMENT has only the manager's number, not the manager's name. To find the name of the manager for each department, you need to find the employee number from the EMPLOYEE table that matches the manager number in the DEPARTMENT table and return the name for the row that matches. Only departments that currently have managers assigned are to be returned. Execute the following SQL statement:

```

SELECT DEPTNO, DEPTNAME,
  (SELECT FIRSTNAME CONCAT ' ' CONCAT
   MIDINIT CONCAT ' ' CONCAT LASTNAME
   FROM EMPLOYEE X
   WHERE X.EMPNO = Y.MGRNO) AS MANAGER_NAME
 FROM DEPARTMENT Y
 WHERE MGRNO IS NOT NULL

```

For each row returned for DEPTNO and DEPTNAME, the system finds where EMPNO = MGRNO and returns the manager's name. The result table produced by the query has the following values.

Table 38. Result set for previous query

DEPTNO	DEPTNAME	MANAGER_NAME
A00	SPIFFY COMPUTER SERVICE DIV.	CHRISTINE I HAAS
B01	PLANNING	MICHAEL L THOMPSON
C01	INFORMATION CENTER	SALLY A KWAN
D11	MANUFACTURING SYSTEMS	IRVING F STERN
D21	ADMINISTRATION SYSTEMS	EVA D PULASKI
E01	SUPPORT SERVICES	JOHN B GEYER

Table 38. Result set for previous query (continued)

DEPTNO	DEPTNAME	MANAGER_NAME
E11	OPERATIONS	EILEEN W HENDERSON
E21	SOFTWARE SUPPORT	THEODORE Q SPENSER

Example: Correlated subquery in an UPDATE statement

When you use a correlated subquery in an UPDATE statement, the correlation name refers to the rows that you want to update.

For example, when all activities of a project must be completed before September 1983, your department considers that project to be a priority project. You can use the following SQL statement to evaluate the projects in the CORPDATA.PROJECT table, and write a 1 (a flag to indicate PRIORITY) in the PRIORITY column (a column you added to CORPDATA.PROJECT for this purpose) for each priority project.

First, alter the table to add the PRIORITY column:

```
ALTER TABLE CORPDATA.PROJECT ADD COLUMN PRIORITY INT
```

Then run this query to perform the update:

```
UPDATE CORPDATA.PROJECT X
SET PRIORITY = 1
WHERE '1983-09-01' >
      (SELECT MAX(EMENDATE)
       FROM CORPDATA.EMPPROJECT
       WHERE PROJNO = X.PROJNO)
```

As SQL examines each row in the CORPDATA.EMPPROJECT table, it determines the maximum activity end date (EMENDATE) for all activities of the project (from the CORPDATA.PROJECT table). If the end date of each activity associated with the project is before September 1983, the current row in the CORPDATA.PROJECT table qualifies and is updated.

Update the master order table with any changes to the quantity ordered. If the quantity in the orders table is not set (the NULL value), keep the value that is in the master order table. These tables do not exist in the CORPDATA sample database.

```
UPDATE MASTER_ORDERS X
SET QTY=(SELECT COALESCE (Y.QTY, X.QTY)
         FROM ORDERS Y
         WHERE X.ORDER_NUM = Y.ORDER_NUM)
WHERE X.ORDER_NUM IN (SELECT ORDER_NUM
                     FROM ORDERS)
```

In this example, each row of the MASTER_ORDERS table is checked to see if it has a corresponding row in the ORDERS table. If it does have a matching row in the ORDERS table, the COALESCE function is used to return a value for the QTY column. If QTY in the ORDERS table has a non-null value, that value is used to update the QTY column in the MASTER_ORDERS table. If the QTY value in the ORDERS table is NULL, the MASTER_ORDERS QTY column is updated with its own value.

Example: Correlated subquery in a DELETE statement

When you use a correlated subquery in a DELETE statement, the correlation name represents the row that you want to delete. SQL evaluates the correlated subquery once for each row in the table named in the DELETE statement to decide whether to delete the row.

Suppose that a row in the CORPDATA.PROJECT table is deleted. Rows related to the deleted project in the CORPDATA.EMPPROJECT table must also be deleted. To do this, run the following statement:

```
DELETE FROM CORPDATA.EMPPROJECT X
WHERE NOT EXISTS
      (SELECT *
       FROM CORPDATA.PROJECT
       WHERE PROJNO = X.PROJNO)
```

SQL determines, for each row in the CORPDATA.EMP_ACT table, whether a row with the same project number exists in the CORPDATA.PROJECT table. If not, the CORPDATA.EMP_ACT row is deleted.

Sort sequences and normalization in SQL

A sort sequence defines how characters in a character set relate to each other when they are compared or ordered. Normalization allows you to compare strings that contain combining characters.

The sort sequence is used for all character, and UCS-2 and UTF-16 graphic comparisons performed in SQL statements. There are sort sequence tables for both single byte and double byte character data. Each single byte sort sequence table has an associated double-byte sort sequence table, and vice versa. Conversion between the two tables is performed when necessary to implement a query. In addition, the CREATE INDEX statement has the sort sequence (in effect at the time the statement was run) applied to the character columns referred to in the index.

Related reference

Creating and using views

A view can be used to access data in one or more tables or views. You create a view by using a SELECT statement.

Creating indexes

You can use indexes to sort and select data. In addition, indexes help the system retrieve data faster for better query performance.

Specifying a search condition using the WHERE clause

The WHERE clause specifies a search condition that identifies the row or rows that you want to retrieve, update, or delete.

GROUP BY clause

The GROUP BY clause allows you to find the characteristics of groups of rows rather than individual rows.

HAVING clause

The HAVING clause specifies a search condition for the groups selected by the GROUP BY clause.

ORDER BY clause

The ORDER BY clause specifies the particular order in which you want selected rows returned. The order is sorted by ascending or descending collating sequence of a column's or an expression's value.

Handling duplicate rows

When SQL evaluates a select-statement, several rows might qualify to be in the result table, depending on the number of rows that satisfy the search condition of the select-statement. Some of the rows in the result table might be duplicate.

Defining complex search conditions

In addition to the basic comparison predicates, such as = and >, a search condition can contain any of these predicates: BETWEEN, IN, EXISTS, IS NULL, and LIKE.

Using the UNION keyword to combine subselects

Using the UNION keyword, you can combine two or more subselects to form a fullselect.

Collating sequence

Sort sequence used with ORDER BY and row selection

The examples show how rows are ordered and selected for the sort sequence used.

The values in the JOB column are in mixed case. You can see the values 'Mgr', 'MGR', and 'mgr'.

Table 39. The STAFF table

ID	NAME	DEPT	JOB	YEARS	SALARY	COMM
10	Sanders	20	Mgr	7	18357.50	0
20	Pernal	20	Sales	8	18171.25	612.45

Table 39. The STAFF table (continued)

ID	NAME	DEPT	JOB	YEARS	SALARY	COMM
30	Merenghi	38	MGR	5	17506.75	0
40	OBrien	38	Sales	6	18006.00	846.55
50	Hanes	15	Mgr	10	20659.80	0
60	Quigley	38	SALES	0	16808.30	650.25
70	Rothman	15	Sales	7	16502.83	1152.00
80	James	20	Clerk	0	13504.60	128.20
90	Koonitz	42	sales	6	18001.75	1386.70
100	Plotz	42	mgr	6	18352.80	0

In the following examples, the results are shown for each statement using:

- *HEX sort sequence
- Shared-weight sort sequence using the language identifier ENU
- Unique-weight sort sequence using the language identifier ENU

Note: ENU is chosen as a language identifier by specifying either SRTSEQ(*LANGIDUNQ), or SRTSEQ(*LANGIDSHR) and LANGID(ENU), on the CRTSQLxxx, STRSQL, or RUNSQLSTM commands, or by using the SET OPTION statement.

Sort sequence and ORDER BY

Sort sequences affect ordering done by the ORDER BY clause.

The following SQL statement causes the result table to be sorted using the values in the JOB column:

```
SELECT * FROM STAFF ORDER BY JOB
```

The following table shows the result using a *HEX sort sequence. The rows are sorted based on the EBCDIC value in the JOB column. In this case, all lowercase letters sort before the uppercase letters.

Table 40. Result of using the *HEX sort sequence

ID	NAME	DEPT	JOB	YEARS	SALARY	COMM
100	Plotz	42	mgr	6	18352.80	0
90	Koonitz	42	sales	6	18001.75	1386.70
80	James	20	Clerk	0	13504.60	128.20
10	Sanders	20	Mgr	7	18357.50	0
50	Hanes	15	Mgr	10	20659.80	0
30	Merenghi	38	MGR	5	17506.75	0
20	Pernal	20	Sales	8	18171.25	612.45
40	OBrien	38	Sales	6	18006.00	846.55
70	Rothman	15	Sales	7	16502.83	1152.00
60	Quigley	38	SALES	0	16808.30	650.25

The following table shows how sorting is done for a unique-weight sort sequence. After the sort sequence is applied to the values in the JOB column, the rows are sorted. Notice that after the sort, lowercase

letters are before the same uppercase letters, and the values 'mgr', 'Mgr', and 'MGR' are adjacent to each other.

Table 41. Result of using the unique-weight sort sequence for the ENU language identifier

ID	NAME	DEPT	JOB	YEARS	SALARY	COMM
80	James	20	Clerk	0	13504.60	128.20
100	Plotz	42	mgr	6	18352.80	0
10	Sanders	20	Mgr	7	18357.50	0
50	Hanes	15	Mgr	10	20659.80	0
30	Merenghi	38	MGR	5	17506.75	0
90	Koonitz	42	sales	6	18001.75	1386.70
20	Pernal	20	Sales	8	18171.25	612.45
40	OBrien	38	Sales	6	18006.00	846.55
70	Rothman	15	Sales	7	16502.83	1152.00
60	Quigley	38	SALES	0	16808.30	650.25

The following table shows how sorting is done for a shared-weight sort sequence. After the sort sequence is applied to the values in the JOB column, the rows are sorted. For the sort comparison, each lowercase letter is treated the same as the corresponding uppercase letter. In this table, notice that all the values 'MGR', 'mgr' and 'Mgr' are mixed together.

Table 42. Result of using the shared-weight sort sequence for the ENU language identifier

ID	NAME	DEPT	JOB	YEARS	SALARY	COMM
80	James	20	Clerk	0	13504.60	128.20
10	Sanders	20	Mgr	7	18357.50	0
30	Merenghi	38	MGR	5	17506.75	0
50	Hanes	15	Mgr	10	20659.80	0
100	Plotz	42	mgr	6	18352.80	0
20	Pernal	20	Sales	8	18171.25	612.45
40	OBrien	38	Sales	6	18006.00	846.55
60	Quigley	38	SALES	0	16808.30	650.25
70	Rothman	15	Sales	7	16502.83	1152.00
90	Koonitz	42	sales	6	18001.75	1386.70

Sort sequence and row selection

Sort sequences affect selection of data.

The following SQL statement selects rows with the value 'MGR' in the JOB column:

```
SELECT * FROM STAFF WHERE JOB='MGR'
```

The first table shows how row selection is done with a *HEX sort sequence. The rows that match the row selection criteria for the column JOB are selected exactly as specified in the select statement. Only the uppercase 'MGR' is selected.

Table 43. Result of using the *HEX sort sequence

ID	NAME	DEPT	JOB	YEARS	SALARY	COMM
30	Merenghi	38	MGR	5	17506.75	0

Table 2 shows how row selection is done with a unique-weight sort sequence. The lowercase and uppercase letters are treated as unique. The lowercase 'mgr' is not treated the same as uppercase 'MGR'. Therefore, the lowercase 'mgr' is not selected.

Table 44. Result of using unique-weight sort sequence for the ENU language identifier

ID	NAME	DEPT	JOB	YEARS	SALARY	COMM
30	Merenghi	38	MGR	5	17506.75	0

The following table shows how row selection is done with a shared-weight sort sequence. The rows that match the row selection criteria for the column 'JOB' are selected by treating uppercase letters the same as lowercase letters. Notice that all the values 'mgr', 'Mgr' and 'MGR' are selected.

Table 45. Result of using the shared-weight sort sequence for the ENU language identifier

ID	NAME	DEPT	JOB	YEARS	SALARY	COMM
10	Sanders	20	Mgr	7	18357.50	0
30	Merenghi	38	MGR	5	17506.75	0
50	Hanes	15	Mgr	10	20659.80	0
100	Plotz	42	mgr	6	18352.80	0

Sort sequence and views

Views are created with the sort sequence that is in effect when the CREATE VIEW statement is run.

When the view is referred to in a FROM clause, that sort sequence is used for any character comparisons in the subselect of the CREATE VIEW. At that time, an intermediate result table is produced from the view subselect. The sort sequence in effect when the query is being run is then applied to all the character and UCS-2 graphic comparisons (including those comparisons involving implicit conversions to character, or UCS-2 or UTF-16 graphic) specified in the query.

The following SQL statements and tables show how views and sort sequences work. View V1, used in the following examples, was created with a shared-weight sort sequence of SRTSEQ(*LANGIDSHR) and LANGID(ENU). The CREATE VIEW statement is as follows:

```
CREATE VIEW V1 AS SELECT *
FROM STAFF
WHERE JOB = 'MGR' AND ID < 100
```

Table 46. "SELECT * FROM V1"

ID	NAME	DEPT	JOB	YEARS	SALARY	COMM
10	Sanders	20	Mgr	7	18357.50	0
30	Merenghi	38	MGR	5	17506.75	0
50	Hanes	15	Mgr	10	20659.80	0

Any queries run against view V1 are run against the result table shown above. The query shown below is run with a sort sequence of SRTSEQ(*LANGIDUNQ) and LANGID(ENU).

Table 47. "SELECT * FROM V1 WHERE JOB = 'MGR'" using the unique-weight sort sequence for ENU language identifier

ID	NAME	DEPT	JOB	YEARS	SALARY	COMM
30	Merenghi	38	MGR	5	17506.75	0

Sort sequence and the CREATE INDEX statement

Indexes are created with the sort sequence that is in effect when the CREATE INDEX statement is run.

An entry is added to the index every time an insert is made into the table over which the index is defined. Index entries contain the weighted value for character key, and UCS-2 and UTF-16 graphic key columns. The system gets the weighted value by converting the key value based on the sort sequence of the index.

When selection is made using that sort sequence and that index, the character, or UCS-2 or UTF-16 graphic keys do not need to be converted before comparison. This improves the performance of the query.

Related concepts

[Using indexes with sort sequence](#)

Sort sequence and constraints

Unique constraints are implemented with indexes. If the table on which a unique constraint is added is defined with a sort sequence, the index is created with the same sort sequence.

If defining a referential constraint, the sort sequence between the parent and dependent table must match.

The sort sequence used at the time a check constraint is defined is the same sort sequence the system uses to validate adherence to the constraint at the time of an INSERT or UPDATE.

ICU sort sequence

When an International Components for Unicode (ICU) sort sequence table is used, the database uses the language-specific rules to determine the weight of the data based on the locale of the table.

An ICU sort sequence table named en_us (United States locale) can sort data differently than another ICU table named fr_FR (French locale) for example.

The ICU support (IBM i option 39) properly handles data that is not normalized, producing the same results as if the data were normalized. The ICU sort sequence table can sort all character, graphic, and Unicode (UTF-8, UTF-16 and UCS-2) data.

For example, a UTF-8 character column named NAME contains the following names (the hex values of the column are given as well).

NAME	HEX (NAME)
Gómez	47C3B36D657A
Gomer	476F6D6572
Gumby	47756D6279

A *HEX sort sequence orders the NAME values as follows.

NAME
Gomer
Gumby
Gómez

An ICU sort sequence table named `en_us` correctly orders the `NAME` values as follows.

NAME
Gomer
Gómez
Gumby

When an ICU sort sequence table is specified, the performance of SQL statements that use the table can be much slower than the performance of SQL statements that use a non-ICU sort sequence table or use a *HEX sort sequence. The slower performance results from calling the ICU support to get the weighted value for each piece of data that needs to be sorted. An ICU sort sequence table can provide more sorting function but at the cost of slower running SQL statements. However, indexes created with an ICU sort sequence table can be created over columns to help reduce the need of calling the ICU support. In this case, the index key already contains the ICU weighted value, so there is no need to call the ICU support.

Related concepts

[International Components for Unicode](#)

Normalization

Normalization allows you to compare strings that contain combining characters.

Data tagged with a UTF-8 or UTF-16 CCSID can contain combining characters. Combining characters allow a resulting character to be composed of more than one character. After the first character of the compound character, one of many different non-spacing characters such as umlauts and accents can follow in the data string. If the resulting character is one that is already defined in the character set, normalization of the string results in multiple combining characters being replaced by the value of the defined character. For example, if your string contained the letter 'a' followed by an '¨', the string is normalized to contain the single character 'ä'.

Normalization makes it possible to accurately compare strings. If data is not normalized, two strings that look identical on the display may not compare equal since the stored representation can be different. When UTF-8 and UTF-16 string data is not normalized, it is possible that a column in a table can have one row with the letter 'a' followed by the umlaut character and another row with the combined 'ä' character. These two values are not both compare equal in a comparison predicate: `WHERE C1 = 'ä'`. For this reason, it is recommended that all string columns in a table are stored in normalized form.

You can normalize the data yourself before inserting or updating it, or you can define a column in a table to be automatically normalized by the database. To have the database perform the normalization, specify `NORMALIZED` as part of the column definition. This option is only allowed for columns that are tagged with a CCSID of 1208 (UTF-8) or 1200 (UTF-16). The database assumes all columns in a table have been normalized.

The `NORMALIZED` clause can also be specified for function and procedure parameters. If it is specified for an input parameter, the normalization will be done by the database for the parameter value before invoking the function or procedure. If it is specified for an output parameter, the clause is not enforced; it is assumed that the user's routine code will return a normalized value.

The `NORMALIZE_DATA` option in the `QAQQINI` file is used to indicate whether the system is to perform normalization when working with UTF-8 and UTF-16 data. This option controls whether the system will normalize literals, host variables, parameter markers, and expressions that combine strings before using them in SQL. The option is initialized to not perform normalization. This is the correct value for you if the data in your tables and any literal values in your applications is always normalized already through some other mechanism or never contains characters which will need to be normalized. If this is the case, you will want to avoid the overhead of system normalization in your query. If your data is not already normalized, you will want to switch the value of this option to have the system perform normalization for you.

Related tasks

[Controlling queries dynamically with the query options file QAQQINI](#)

Data protection

The Db2 for i database provides various methods for protecting SQL data from unauthorized users and for ensuring data integrity.

Security for SQL objects

All objects on the system, including SQL objects, are managed by the system security function.

Users can authorize SQL objects through either the SQL GRANT and REVOKE statements, the TRANSFER OWNERSHIP statement, or the Edit Object Authority (EDTOBJAUT), Grant Object Authority (GRTOBJAUT), and Revoke Object Authority (RVKOBJAUT) CL commands.

The SQL GRANT and REVOKE statements operate on SQL functions, SQL packages, SQL procedures, distinct types, array types, sequences, variables, tables, views, schemas, XSR objects, and the individual columns of tables and views. Furthermore, SQL GRANT and REVOKE statements only grant private and public authorities. In some cases, it is necessary to use EDTOBJAUT, GRTOBJAUT, and RVKOBJAUT to authorize users to other objects, such as commands and programs.

The TRANSFER OWNERSHIP statement can be used for a table, index or view to transfer the ownership of an object from the current owner to a new owner.

The authority checked for SQL statements depends on whether the statement is static, dynamic, or being run interactively.

For static SQL statements:

- If the USRPRF value is *USER, the authority to run the SQL statement locally is checked using the user profile of the user running the program. The authority to run the SQL statement remotely is checked using the user profile at the application server. *USER is the default for system (*SYS) naming.
- If the USRPRF value is *OWNER, the authority to run the SQL statement locally is checked using the user profiles of the user running the program and of the owner of the program. The authority to run the SQL statement remotely is checked using the user profiles of the application server job and the owner of the SQL package. The higher authority is the authority that is used. *OWNER is the default for SQL (*SQL) naming.

For dynamic SQL statements:

- If the USRPRF value is *USER, the authority to run the SQL statement locally is checked using the user profile of the person running the program. The authority to run the SQL statement remotely is checked using the user profile of the application server job.
- If the USRPRF value is *OWNER and DYNUSRPRF is *USER, the authority to run the SQL statement locally is checked using the user profile of the person running the program. The authority to run the SQL statement remotely is checked using the user profile of the application server job.
- If the USRPRF value is *OWNER and DYNUSRPRF is *OWNER, the authority to run the SQL statement locally is checked using the user profiles of the user running the program and the owner of the program. The authority to run the SQL statement remotely is checked using the user profiles of the application server job and the owner of the SQL package. The highest authority is the authority that is used. Because of security concerns, you should use the *OWNER parameter value for DYNUSRPRF carefully. This option gives the access authority of the owner program or package to those who run the program.

For interactive SQL statements, authority is checked against the authority of the person processing the statement. Adopted authority is not used for interactive SQL statements.

Related reference

[Security reference](#)

[GRANT \(Table or View Privileges\)](#)

[REVOKE \(Table or View Privileges\)](#)

Authorization ID

An *authorization ID* is a user profile object that identifies a unique user. You can use the Create User Profile (CRTUSRPRF) command to create an authorization ID.

Views

Views can prevent unauthorized users from having access to sensitive data.

The application program can access the data it needs in a table, without having access to sensitive or restricted data in the table. A view can restrict access to particular columns by not specifying those columns in the SELECT list (for example, employee salaries). A view can also restrict access to particular rows in a table by specifying a WHERE clause (for example, allowing access only to the rows associated with a particular department number).

Column masks and row permissions

Column masks and row permissions can be defined for a table to limit the data certain users can see.

A column mask can define an alternate value to be returned for a column. The definition of the mask can use logic to check the application or the type of user that is querying the data to determine how to present the data. An example of a masked value is a credit card number with XXX for many of the digits.

A row permission restricts which rows are available from a query. Like a mask, there is logic that defines the restriction. An example of a row permission would be to let managers only see information about employees in their department, while human resources personnel can see all employees.

The VERIFY_GROUP_FOR_USER scalar function can be used in the logic for masks and permissions to distinguish different categories of users.

Related reference

[CREATE MASK](#)

[CREATE PERMISSION](#)

[VERIFY_GROUP_FOR_USER](#)

[Row and column access control](#)

Auditing

The Db2 for i database is designed to comply with the U.S. government C2 security level. A key feature of the C2 level is the ability to perform auditing on the system.

Db2 for i uses the audit facilities that are managed by the system security function. Auditing can be performed at an object level, a user level, or a system level. The system value QAUDCTL controls whether auditing is performed at the object or user level. The Change User Audit (CHGUSRAUD) and Change Object Audit (CHGOBJAUD) commands specify which users and objects are audited. The system value QAUDLVL controls what types of actions are audited (for example, authorization failures; and create, delete, grant, or revoke operations).

Db2 for i can also audit row changes through the Db2 for i journal support.

In some cases, entries in the auditing journal will not be in the same order as they occurred. For example, a job that is running under commitment control deletes a table, creates a new table with the same name as the one that was deleted, then does a commit. This will be recorded in the auditing journal as a create followed by a delete. This is because objects that are created are journaled immediately. An object that is deleted under commitment control is hidden and not actually deleted until a commit is done. Once the commit is done, the action is journaled.

Related reference

[Security reference](#)

Data integrity

Data integrity protects data from being destroyed or changed by unauthorized persons, system operation or hardware failures (such as physical damage to a disk), programming errors, interruptions before a job is completed (such as a power failure), or interference from running applications at the same time (such as serialization problems).

Related reference

[XA APIs](#)

Concurrency

Concurrency is the ability for multiple users to access and change data in the same table or view at the same time without risk of losing data integrity.

This ability is automatically supplied by the Db2 for i database manager. Locks are implicitly acquired on tables and rows to protect concurrent users from changing the same data at precisely the same time.

Typically, Db2 for i acquires locks on rows to ensure integrity. However, some situations require Db2 for i to acquire a more exclusive table-level lock instead of row locks.

For example, an update (exclusive) lock on a row currently held by one cursor can be acquired by another cursor in the same program (or in a DELETE or UPDATE statement not associated with the cursor). This will prevent a positioned UPDATE or positioned DELETE statement that references the first cursor until another FETCH is performed. A read (shared no-update) lock on a row currently held by one cursor will not prevent another cursor in the same program (or DELETE or UPDATE statement) from acquiring a lock on the same row.

Default and user-specifiable lock-wait timeout values are supported. Db2 for i creates tables, views, and indexes with the default record wait time (60 seconds) and the default file wait time (*IMMED). This lock wait time is used for data manipulation language (DML) statements. You can change these values by using the CL commands Change Physical File (CHGPF), Change Logical File (CHGLF), and Override Database File (OVRDBF).

The lock wait time used for all data definition language (DDL) statements and the LOCK TABLE statement is the job default wait time (DFTWAIT). You can change this value by using the CL command Change Job (CHGJOB) or Change Class (CHGCLS).

If a large record wait time is specified, deadlock detection is provided. For example, assume that one job has an exclusive lock on row 1 and another job has an exclusive lock on row 2. If the first job attempts to lock row 2, it waits because the second job is holding the lock. If the second job then attempts to lock row 1, Db2 for i detects that the two jobs are in a deadlock and an error is returned to the second job.

You can explicitly prevent other users from using a table at the same time by using the SQL LOCK TABLE statement. Using COMMIT(*RR) will also prevent other users from using a table during a unit of work.

To improve performance, Db2 for i frequently leaves the open data path (ODP) open. This performance feature also leaves a lock on tables referenced by the ODP, but does not leave any locks on rows. A lock left on a table might prevent another job from performing an operation on that table. In most cases, however, Db2 for i can detect that other jobs are holding locks and events can be signaled to those jobs. The event causes Db2 for i to close any ODPs (and release the table locks) that are associated with that table and are currently only open for performance reasons.

Note: The lock wait timeout must be large enough for the events to be signalled and the other jobs to close the ODPs, or an error is returned.

Unless the LOCK TABLE statement is used to acquire table locks, or either COMMIT(*ALL) or COMMIT(*RR) is used, data which has been read by one job can be immediately changed by another job. Typically, the data that is read at the time the SQL statement is executed and therefore it is very current (for example, during FETCH). In the following cases, however, data is read before the execution of the SQL statement and therefore the data may not be current (for example, during OPEN).

- ALWCOPYDTA(*OPTIMIZE) was specified and the optimizer determined that making a copy of the data performs better than not making a copy.

- Some queries require the database manager to create a temporary result table. The data in the temporary result table does not reflect changes that are made after the cursor was opened. For information about when a temporary result table is created, see [DECLARE CURSOR](#) in the SQL reference topic collection.
- A basic subquery is evaluated when the query is opened.

The concurrent access resolution option can be used to minimize transaction wait time. This option directs the database manager on how to handle record lock conflicts under certain isolation levels.

The concurrent access resolution option can have one of the following values:

Wait for outcome

This is the default. This value directs the database manager to wait for the commit or rollback when encountering locked data that is in the process of being updated or deleted. Locked rows that are in the process of being inserted are not skipped. This option applies to read-only queries when running under COMMIT(*CS) or COMMIT(*RS) and is ignored otherwise.

Use currently committed

This value allows the database manager to use the currently committed version of the data for read-only queries when encountering row lock contention related to uncommitted updates and deletes. Locked rows in the process of being inserted can be skipped. This option applies where possible when running under COMMIT(*CS) and is ignored otherwise.

Skip locked data

This value directs the database manager to skip rows in the case of record lock conflicts. This option applies only when the query is running under COMMIT(*CS) or COMMIT(*ALL).

The concurrent access resolution values of USE CURRENTLY COMMITTED and SKIP LOCKED DATA can be used to improve concurrency by avoiding lock waits. However, care must be used when using these options because they might affect application functionality. For details on how to specify the concurrent access resolution option, see [Improve concurrency by avoiding lock waits](#)

USE CURRENTLY COMMITTED details and considerations

To find the previously committed version of a row, the database manager searches the journal for the most recently committed row image based upon relative record number. The journal search could fail to find the row or the search could timeout. The Maximum record wait time (WAITRCD) influences how long the database manager will search before failing. The WAITRCD for a file can be changed using the Change Physical File (CHGPF) command.

Visual explain can be used to understand the implementation of a Use currently committed query. The following details are provided:

- Journal Search Time Limit for Currently Committed - Maximum amount of time allowed to search the journal for the currently committed version of a row.
- Journal Search Requests for Currently Committed - Number of times the database manager searched the journal for the currently committed version of a row.
- Journal Search Failures for Currently Committed - Number of times the database manager failed to find the currently committed version of a row in the journal. For each row where the currently committed version was not found, a wait was performed.

Related reference

[LOCK TABLE](#)

Journaling

The Db2 for i journal support provides an audit trail and forward and backward recovery.

Forward recovery can be used to take an older version of a table and apply the changes logged on the journal to the table. Backward recovery can be used to remove changes logged on the journal from the table.

When an SQL schema is created, a journal and journal receiver are created in the schema. When SQL creates the journal and journal receiver, they are only created on a user auxiliary storage pool (ASP) if the

ASP clause is specified on the CREATE SCHEMA statement. However, because placing journal receivers on their own ASPs can improve performance, the person managing the journal might want to create all future journal receivers on a separate ASP.

When a table is created into the schema, it is automatically journaled to the journal that Db2 for i created in the schema (QSQJRN). A table created in a library also has journaling started if a journal named QSQJRN exists in that library. After this point, it is your responsibility to use the journal functions to manage the journal, the journal receivers, and the journaling of tables to the journal. For example, if a table is moved into a schema, no automatic change to the journaling status occurs. If a table is restored, the normal journal rules apply. That is, if the table was journaled at save time, it is journaled to the same journal at restore time. If the table was not journaled at save time, it is not journaled at restore time.

The journal created in the SQL schema is normally the journal used for logging all changes to SQL tables. You can, however, use the system journal functions to journal SQL tables to a different journal.

A user can stop journaling on any table using the journal functions, but doing so prevents an application from running under commitment control. If journaling is stopped on a parent table of a referential constraint with a delete rule of NO ACTION, CASCADE, SET NULL, or SET DEFAULT, all update and delete operations will be prevented. Otherwise, an application is still able to function if you have specified COMMIT(*NONE); however, this does not provide the same level of integrity that journaling and commitment control provide.

Related concepts

[Journal management](#)

Related reference

[Updating tables with referential constraints](#)

If you are updating a parent table, you cannot modify a primary key for which dependent rows exist.

Commitment control

The Db2 for i commitment control support provides a means for processing a group of database changes, such as update, insert, or delete operations or data definition language (DDL) operations, as a single unit of work (also referred to as a *transaction*).

A commit operation guarantees that the group of operations is completed. A rollback operation guarantees that the group of operations is backed out. A savepoint can be used to break a transaction into smaller units that can be rolled back. A commit operation can be issued through several different interfaces. For example,

- An SQL COMMIT statement
- A CL COMMIT command
- A language commit statement (such as an RPG COMMIT statement)

A rollback operation can be issued through several different interfaces. For example,

- An SQL ROLLBACK statement
- A CL ROLLBACK command
- A language rollback statement (such as an RPG ROLBK statement)

The only SQL statements that cannot be committed or rolled back are:

- DROP SCHEMA
- GRANT or REVOKE if an authority holder exists for the specified object

If commitment control was not already started when either an SQL statement is run with an isolation level other than COMMIT(*NONE) or a RELEASE statement is run, then Db2 for i sets up the commitment control environment by running the internal equivalent of the Start Commitment Control (STRCMTCTL) command. Db2 for i specifies the NFYOBJ(*NONE) and CMTSCOPE(*ACTGRP) parameters, along with the LCKLVL parameter. The LCKLVL parameter specified is the lock level on the COMMIT parameter of the Create SQL (CRTSQLxxx), Start SQL Interactive Session (STRSQL), or Run SQL Statements (RUNSQLSTM) command. In REXX, the LCKLVL parameter specified is the lock level on the SET OPTION statement. You

can use the STRCMTCTL command to specify a different CMTSCOPE, NFOBJ, or LCKLVL parameter. If you specify CMTSCOPE(*JOB) to start the job-level commitment definition, Db2 for i uses the job-level commitment definition for programs in that activation group.

Notes:

- When commitment control is used, the tables that are referred to in the application program by data manipulation language (DML) statements must be journaled.
- The LCKLVL parameter specified is only the default lock level. After commitment control is started, the SET TRANSACTION SQL statement and the lock level specified on the COMMIT parameter of the CRTSQLxxx, STRSQL, or RUNSQLSTM command will override the default lock level. Also, the LCKLVL parameter only applies to commitment control operations that are requested through the IBM i traditional system interface (non-SQL). The lock level specified on the LCKLVL parameter is not affected by any subsequent changes to the SQL isolation level that are made by using, for example, the SET TRANSACTION statement.

For cursors that use aggregate functions, GROUP BY, or HAVING, and are running under commitment control, a ROLLBACK HOLD has no effect on the cursor's position. In addition, the following occurs under commitment control:

- If COMMIT(*CHG) and (ALWBLK(*NO) or (ALWBLK(*READ))) is specified for one of these cursors, a message (CPI430B) is sent that says COMMIT(*CHG) requested but not allowed.
- If COMMIT(*ALL), COMMIT(*RR), or COMMIT(*CS) with the KEEP LOCKS clause is specified for one of the cursors, Db2 for i locks all referenced tables in shared mode (*SHRNUP). The lock prevents concurrent application processes from processing any but read-only operations on the named table. A message (either SQL7902 or CPI430A) is sent that says COMMIT(*ALL), COMMIT(*RR), or COMMIT(*CS) with the KEEP LOCKS clause is specified for one of the cursors requested but not allowed. Message SQL0595 might also be sent.

For cursors where COMMIT(*ALL), COMMIT(*RR), or COMMIT(*CS) with the KEEP LOCKS clause is specified and either catalog files are used or a temporary result table is required, Db2 for i locks all referenced tables in shared mode (*SHRNUP). This prevents concurrent processes from processing anything but read-only operations on the named table or tables. A message (either SQL7902 or CPI430A) is sent that says COMMIT(*ALL) is requested but not allowed. Message SQL0595 might also be sent.

If ALWBLK(*ALLREAD) and COMMIT(*CHG) were specified, when the program was precompiled, all read-only cursors will allow blocking of rows and a ROLLBACK HOLD will not roll the cursor position back.

If COMMIT(*RR) is requested, the tables will be locked until the query is closed. If the cursor is read-only, the table will be locked (*SHRNUP). If the cursor is in update mode, the table will be locked (*EXCLRD). Since other users will be locked out of the table, running with repeatable read will prevent concurrent access of the table.

In a highly contentious environment using COMMIT(*RR), an application might need to retry an operation after getting an SQL0913 to allow the database unlocking mechanism time to work.

If an isolation level other than COMMIT(*NONE) was specified and the application issues a ROLLBACK or the activation group ends abnormally (and the commitment definition is not *JOB), all updates, inserts, deletes, and DDL operations made within the unit of work are backed out. If the application issues a COMMIT or the activation group ends normally, all updates, inserts, deletes, and DDL operations made within the unit of work are committed.

Db2 for i uses locks on rows to keep other jobs from accessing changed data before a unit of work is completed. If COMMIT(*ALL) is specified, read locks on rows fetched are also used to prevent other jobs from changing data that was read before a unit of work is completed. This does not prevent other jobs from reading the unchanged rows. This ensures that, if the same unit of work rereads a row, it gets the same result. Read locks do not prevent other jobs from fetching the same rows.

Commitment control handles up to 500 million distinct row changes in a unit of work. If COMMIT(*ALL) or COMMIT(*RR) is specified, all rows read are also included in the limit. (If a row is changed or read more than once in a unit of work, it is only counted once toward the limit.) Holding a large number of locks adversely affects system performance and does not allow concurrent users to access rows locked

in the unit of work until the end of the unit of work. It is in your best interest to keep the number of rows processed in a unit of work small.

COMMIT HOLD and ROLLBACK HOLD allow you to keep the cursor open and start another unit of work without issuing an OPEN statement again. The HOLD value is not available when you are connected to a remote database that is not on an IBM i platform. However, the WITH HOLD option on DECLARE CURSOR can be used to keep the cursor open after a commit. This type of cursor is supported when you are connected to a remote database that is not on an IBM i platform. Such a cursor is closed on a rollback.

SQL statement	COMMIT parameter (see note 5)	Duration of row locks	Lock type
SELECT INTO SET variable VALUES INTO	*NONE *CHG *CS (See note 6) *ALL (See note 2 and 7)	No locks No locks Row locked when read and released From read until ROLLBACK or COMMIT	READ READ
FETCH (read-only cursor)	*NONE *CHG *CS (See note 6) *ALL (See note 2 and 7)	No locks No locks From read until the next FETCH From read until ROLLBACK or COMMIT	READ READ
FETCH (update or delete capable cursor) (See note 1)	*NONE *CHG *CS *ALL	When row is not updated or deleted from read until next FETCH When row is updated from read until next FETCH When row is deleted from read until next DELETE When row is not updated or deleted from read until next FETCH When row is updated or deleted from read until COMMIT or ROLLBACK When row is not updated or deleted from read until next FETCH When row is updated or deleted from read until COMMIT or ROLLBACK From read until ROLLBACK or COMMIT	UPDATE UPDATE UPDATE UPDATE
INSERT (target table) MERGE, INSERT sub-statement	*NONE *CHG *CS *ALL	No locks From insert until ROLLBACK or COMMIT From insert until ROLLBACK or COMMIT From insert until ROLLBACK or COMMIT	UPDATE UPDATE UPDATE ³
INSERT (tables in subselect)	*NONE *CHG *CS *ALL	No locks No locks Each row locked while being read From read until ROLLBACK or COMMIT	READ READ
UPDATE (non-cursor)	*NONE *CHG *CS *ALL	Each row locked while being updated From read until ROLLBACK or COMMIT From read until ROLLBACK or COMMIT From read until ROLLBACK or COMMIT	UPDATE UPDATE UPDATE UPDATE
DELETE (non-cursor)	*NONE *CHG *CS *ALL	Each row locked while being deleted From read until ROLLBACK or COMMIT From read until ROLLBACK or COMMIT From read until ROLLBACK or COMMIT	UPDATE UPDATE UPDATE UPDATE
UPDATE (with cursor)	*NONE *CHG *CS *ALL	From read until next FETCH From read until ROLLBACK or COMMIT From read until ROLLBACK or COMMIT From read until ROLLBACK or COMMIT	UPDATE UPDATE UPDATE UPDATE

Table 48. Row lock duration (continued)

SQL statement	COMMIT parameter (see note 5)	Duration of row locks	Lock type
MERGE, UPDATE sub-statement	*NONE *CHG *CS *ALL	From read until MERGE statement completion From read until ROLLBACK or COMMIT From read until ROLLBACK or COMMIT From read until ROLLBACK or COMMIT	UPDATE UPDATE UPDATE UPDATE
DELETE (with cursor)	*NONE *CHG *CS *ALL	Lock released when row deleted From read until ROLLBACK or COMMIT From read until ROLLBACK or COMMIT From read until ROLLBACK or COMMIT	UPDATE UPDATE UPDATE UPDATE
MERGE, DELETE sub-statement	*NONE *CHG *CS *ALL	From read until MERGE statement completion From read until ROLLBACK or COMMIT From read until ROLLBACK or COMMIT From read until ROLLBACK or COMMIT	UPDATE UPDATE UPDATE UPDATE
Subqueries (update or delete capable cursor or UPDATE or DELETE non-cursor)	*NONE *CHG *CS *ALL (see note 2)	From read until next FETCH From read until next FETCH From read until next FETCH From read until ROLLBACK or COMMIT	READ READ READ READ
Subqueries (read-only cursor or SELECT INTO)	*NONE *CHG *CS *ALL	No locks No locks Each row locked while being read From read until ROLLBACK or COMMIT	READ READ

Notes:

- A cursor is open with UPDATE or DELETE capabilities if the result table is not read-only and if one of the following is true:
 - The cursor is defined with a FOR UPDATE clause.
 - The cursor is defined without a FOR UPDATE, FOR READ ONLY, or ORDER BY clause and the program contains at least one of the following:
 - Cursor UPDATE referring to the same cursor-name
 - Cursor DELETE referring to the same cursor-name
 - An EXECUTE or EXECUTE IMMEDIATE statement and ALWBLK(*READ) or ALWBLK(*NONE) was specified on the CRTSQLxxx command.
- A table or view can be locked exclusively in order to satisfy COMMIT(*ALL). If a subselect is processed that includes a UNION, or if the processing of the query requires the use of a temporary result, an exclusive lock is acquired to protect you from seeing uncommitted changes.
- An UPDATE lock on rows of the target table and a READ lock on the rows of the subselect table.
- A table or view can be locked exclusively in order to satisfy repeatable read. Row locking is still done under repeatable read. The locks acquired and their duration are identical to *ALL.
- Repeatable read (*RR) row locks will be the same as the locks indicated for *ALL.
- If the KEEP LOCKS clause is specified with *CS, any read locks are held until the cursor is closed or until a COMMIT or ROLLBACK is done. If no cursors are associated with the isolation clause, then locks are held until the completion of the SQL statement.
- If the USE AND KEEP EXCLUSIVE LOCKS clause is specified with the *RS or *RR isolation level, an UPDATE lock on the row will be obtained instead of a READ lock.

Related concepts

[Commitment control](#)

Related reference

[DECLARE CURSOR](#)

[Isolation level](#)

[XA APIs](#)

Savepoints

A *savepoint* is a named entity that represents the state of data and schemas at a particular point within a unit of work. You can create savepoints within a transaction. If the transaction rolls back, changes are undone to the specified savepoint, rather than to the beginning of the transaction.

You can set a savepoint using the SAVEPOINT SQL statement. For example, create a savepoint called STOP_HERE:

```
SAVEPOINT STOP_HERE  
ON ROLLBACK RETAIN CURSORS
```

Program logic in the application dictates whether the savepoint name is reused as the application progresses, or if the savepoint name denotes a unique milestone in the application that should not be reused.

If the savepoint represents a unique milestone that should not be moved with another SAVEPOINT statement, specify the UNIQUE keyword. This prevents the accidental reuse of the name that can occur by invoking a stored procedure that uses the identical savepoint name in a SAVEPOINT statement. However, if the SAVEPOINT statement is used in a loop, then the UNIQUE keyword should not be used. The following SQL statement sets a unique savepoint named START_OVER.

```
SAVEPOINT START_OVER UNIQUE  
ON ROLLBACK RETAIN CURSORS
```

To rollback to a savepoint, use the ROLLBACK statement with the TO SAVEPOINT clause. The following example illustrates using the SAVEPOINT and ROLLBACK TO SAVEPOINT statements:

This application logic books airline reservations on a preferred date, then books hotel reservations. If the hotel is unavailable, it rolls back the airline reservations and then repeats the process for another date. Up to 3 dates are tried.

```
got_reservations =0;  
EXEC SQL SAVEPOINT START_OVER UNIQUE ON ROLLBACK RETAIN CURSORS;  
  
if (SQLCODE != 0) return;  
  
for (i=0; i<3 & got_reservations == 0; ++i)  
{  
  Book_Air(dates(i), ok);  
  if (ok)  
  {  
    Book_Hotel(dates(i), ok);  
    if (ok) got_reservations = 1;  
  }  
  else  
  {  
    EXEC SQL ROLLBACK TO SAVEPOINT START_OVER;  
    if (SQLCODE != 0) return;  
  }  
}  
}  
  
EXEC SQL RELEASE SAVEPOINT START_OVER;
```

Savepoints are released using the RELEASE SAVEPOINT statement. If a RELEASE SAVEPOINT statement is not used to explicitly release a savepoint, it is released at the end of the current savepoint level or at the end of the transaction. The following statement releases savepoint START_OVER.

```
RELEASE SAVEPOINT START_OVER
```

Savepoints are released when the transaction is committed or rolled back. Once the savepoint name is released, a rollback to the savepoint name is no longer possible. The COMMIT or ROLLBACK statement releases all savepoint names established within a transactions. Since all savepoint names are released within the transaction, all savepoint names can be reused following a commit or rollback.

Savepoints are scoped to a single connection only. Once a savepoint is established, it is not distributed to all remote databases that the application connects to. The savepoint only applies to the current database that the application is connected to when the savepoint is established.

A single statement can implicitly or explicitly invoke a user-defined function, trigger, or stored procedure. This is known as nesting. In some cases when a new nesting level is initiated, a new savepoint level is also initiated. A new savepoint level isolates the invoking application from any savepoint activity by the lower level routine or trigger.

Savepoints can only be referenced within the same savepoint level (or scope) in which they are defined. A ROLLBACK TO SAVEPOINT statement cannot be used to rollback to a savepoint established outside the current savepoint level. Likewise, a RELEASE SAVEPOINT statement cannot be used to release a savepoint established outside the current savepoint level. The following table summarizes when savepoint levels are initiated and terminated:

A new savepoint level is initiated when:	That savepoint level ends when:
A new unit of work is started	COMMIT or ROLLBACK is issued
A trigger is invoked	The trigger completes
A user-defined function is invoked	The user-defined function returns to the invoker
A stored procedure is invoked, and that stored procedure was created with the NEW SAVEPOINT LEVEL clause	The stored procedure returns to the caller
There is a BEGIN for an ATOMIC compound SQL statement	There is an END for an ATOMIC compound statement

A savepoint that is established in a savepoint level is implicitly released when that savepoint level is terminated.

Atomic operations

When running under COMMIT(*CHG), COMMIT(*CS), or COMMIT(*ALL), all operations are guaranteed to be atomic.

That is, they will complete or they will appear not to have started. This is true regardless of when or how the function was ended or interrupted (such as power failure, abnormal job end, or job cancel).

If COMMIT (*NONE) is specified, however, some underlying database data definition functions are not atomic. The following SQL data definition statements are guaranteed to be atomic:

- ALTER TABLE (See note 1)
- COMMENT (See note 2)
- LABEL (See note 2)
- GRANT (See note 3)
- REVOKE (See note 3)
- DROP TABLE (See note 4)
- DROP VIEW (See note 4)
- DROP INDEX
- DROP PACKAGE
- REFRESH TABLE

Notes:

1. If multiple alter table options are specified, the operations are processed one at a time so the entire SQL statement is not atomic. The order of operations is:
 - Remove constraints

- Remove materialized query table
 - Remove partitions
 - Remove partitioning
 - Drop columns for which the RESTRICT option was specified
 - All other column definition changes (DROP COLUMN CASCADE, ALTER COLUMN, ADD COLUMN)
 - Alter partition
 - Add or alter materialized query table
 - Add partition or partitioning
 - Add constraints
2. If multiple columns are specified for a COMMENT or LABEL statement, the columns are processed one at a time, so the entire SQL statement is not atomic, but the COMMENT or LABEL to each individual column or object will be atomic.
 3. If multiple tables, SQL packages, or users are specified for a GRANT or REVOKE statement, the tables are processed one at a time, so the entire SQL statement is not atomic, but the GRANT or REVOKE to each individual table will be atomic.
 4. If dependent views need to be dropped during DROP TABLE or DROP VIEW, each dependent view is processed one at a time, so the entire SQL statement is not atomic.

The following data definition statements are not atomic because they involve more than one database operation:

- ALTER FUNCTION
- ALTER MASK
- ALTER PERMISSION
- ALTER PROCEDURE
- ALTER SEQUENCE
- ALTER TRIGGER
- CREATE ALIAS
- CREATE TYPE
- CREATE FUNCTION
- CREATE INDEX
- CREATE MASK
- CREATE PERMISSION
- CREATE PROCEDURE
- CREATE SCHEMA
- CREATE SEQUENCE
- CREATE TABLE
- CREATE TRIGGER
- CREATE VARIABLE
- CREATE VIEW
- DECLARE GLOBAL TEMPORARY TABLE
- DROP ALIAS
- DROP FUNCTION
- DROP MASK
- DROP PERMISSION
- DROP PROCEDURE
- DROP SCHEMA

- DROP SEQUENCE
- DROP TRIGGER
- DROP TYPE
- DROP VARIABLE
- RENAME (See note 1)

Note: RENAME is atomic only if the name or the system name is changed. When both are changed, the RENAME is not atomic.

For example, a CREATE TABLE statement can be interrupted after the Db2 for i physical file has been created, but before the member has been added. Therefore, in the case of create statements, if an operation ends abnormally, you might need to drop the object and then create it again. In the case of a DROP SCHEMA statement, you might need to drop the schema again or use the CL command Delete Library (DLTLIB) to remove the remaining parts of the schema.

Constraints

The Db2 for i database supports unique, referential, and check constraints.

A unique constraint is a rule that guarantees that the values of a key are unique. A referential constraint is a rule that all non-null values of foreign keys in a dependent table have a corresponding parent key in a parent table. A check constraint is a rule that limits the values allowed in a column or group of columns.

Db2 for i enforces the validity of the constraint during any data manipulation language (DML) statement. Certain operations (such as restoring the dependent table), however, cause the validity of the constraint to be unknown. In this case, DML statements might be prevented until Db2 for i has verified the validity of the constraint.

- Unique constraints are implemented with indexes. If an index that implements a unique constraint is not valid, the Edit Rebuild of Access Paths (EDTRBDAP) command can be used to display any indexes that currently require being rebuilt.
- If Db2 for i does not currently know whether a referential constraint or check constraint is valid, the constraint is considered to be in a check pending state. The Edit Check Pending Constraints (EDTCPST) command can be used to display any indexes that currently require being rebuilt.

Related concepts

Constraints

A *constraint* is a rule enforced by the database manager to limit the values that can be inserted, deleted, or updated in a table.

Adding and using check constraints

A *check constraint* ensures the validity of data during insert and update operations by limiting the allowed values in a column or group of columns.

Use the SQL CREATE TABLE and ALTER TABLE statements to add or drop check constraints.

In this example, the following statement creates a table with three columns and a check constraint over COL2 that limits the values allowed in that column to positive integers:

```
CREATE TABLE T1 (COL1 INT, COL2 INT CHECK (COL2>0), COL3 INT)
```

Given this table, the following statement:

```
INSERT INTO T1 VALUES (-1, -1, -1)
```

fails because the value to be inserted into COL2 does not meet the check constraint; that is, -1 is not greater than 0.

The following statement is successful:

```
INSERT INTO T1 VALUES (1, 1, 1)
```

Once that row is inserted, the following statement fails:

```
ALTER TABLE T1 ADD CONSTRAINT C1 CHECK (COL1=1 AND COL1<COL2)
```

This ALTER TABLE statement attempts to add a second check constraint that limits the value allowed in COL1 to 1 and also effectively rules that values in COL2 be greater than 1. This constraint is not allowed because the second part of the constraint is not met by the existing data (the value of '1' in COL2 is not less than the value of '1' in COL1).

Related reference

[ALTER TABLE](#)

[CREATE TABLE](#)

Save and restore functions

The IBM i save and restore functions are used to save SQL objects to disk (save file) or to external media.

The saved versions can be restored onto any IBM i operating system later. The save and restore functions allow an entire schema, selected objects, or only objects that have been changed since a given date and time to be saved. All information needed to restore an object to its previous state is saved. You can use the functions to recover from damage to individual tables by restoring the data with a previous version of the table or the entire schema.

When a program or service program that was created for an SQL procedure, an SQL function, or a sourced function is restored, it is automatically added to the SYSROUTINES and SYSPARMS catalogs, as long as a procedure or function does not already exist with the same signature and program name. SQL programs created in QSYS will not be created as SQL procedures when restored. Additionally, external programs or service programs that were referenced on a CREATE PROCEDURE or CREATE FUNCTION statement may contain the information required to register the routine in SYSROUTINES. If the information exists and the signature is unique, the functions or procedures will also be added to SYSROUTINES and SYSPARMS when restored.

When an SQL table is restored, the definitions for the SQL triggers that are defined for the table are also restored. The SQL trigger definitions are automatically added to the SYSTRIGGERS, SYSTRIGDEP, SYSTRIGCOL, and SYSTRIGUPD catalogs. The program object that is created from the SQL CREATE TRIGGER statement must also be saved and restored when the SQL table is saved and restored. The saving and restoring of the program object is not automated by the database manager. The precautions for self-referencing triggers should be reviewed when restoring SQL tables to a new library.

When an *SQLUDT object is restored for a user-defined type, the user-defined type is automatically added to the SYSTYPES catalog. The appropriate functions needed to cast between the user-defined type and the source type are also created, as long as the type and functions do not already exist.

When a *DTAARA for a sequence is restored, the sequence is automatically added to the SYSSEQUENCES catalog. If the catalog is not successfully updated, the *DTAARA will be modified so it cannot be used as a sequence and an SQL9020 informational message will be output in the job log.

When a *SRVPGM for a global variable is restored, the variable is automatically added to the SYSVARIABLES catalog. If the catalog is not successfully updated, the object cannot be used as a global variable. For a situation where it would have been a duplicate name in the schema, it might be possible to have it recognized as a global variable by moving the object to a different schema.

Either a distributed SQL program or its associated SQL package can be saved and restored to any number of systems. This allows any number of copies of the SQL programs on different systems to access the same SQL package on the same application server. This also allows a single distributed SQL program to connect to any number of application servers that have the SQL package restored (CRTSQLPKG can also be used). SQL packages cannot be restored to a different library.

Note: Restoring a schema to an existing library or to a schema that has a different name does not restore the journal, journal receivers, or IDDU dictionary (if one exists). If the schema is restored to a schema with a different name, the catalog views in that schema will only reflect objects in the old schema. The catalog views in QSYS2, however, will appropriately reflect all objects.

Damage tolerance

The Db2 for i database provides several mechanisms to reduce or eliminate damage caused by disk errors.

For example, mirroring, checksums, and Redundant Array of Independent Disks (RAID) can all reduce the possibility of disk problems. The Db2 for i functions also have a certain amount of tolerance to damage caused by disk errors or system errors.

A DROP operation always succeeds, regardless of the damage. This ensures that should damage occur, at least the table, view, SQL package, index, procedure, function, or distinct type can be deleted and restored or created again.

If a disk error has damaged a small portion of the rows in a table, the Db2 for i database manager allows you to read rows that are still accessible.

Index recovery

The Db2 for i database provides several functions to deal with index recovery.

- System managed index protection

The Edit Recovery for Access Paths (EDTRCYAP) CL command allows you to instruct Db2 for i to guarantee that in the event of a system or power failure, the amount of time required to recover all indexes on the system is kept below a specified time. The system automatically journals enough information in a system journal to limit the recovery time to the specified amount.

- Journaling of indexes

Db2 for i provides an index journaling function that makes it unnecessary to rebuild an entire index in the event of a power or system failure. If the index is journaled, the system database support automatically makes sure that the index is in synchronization with the data in the tables without having to rebuild it from scratch. SQL indexes are not journaled automatically. You can, however, use the CL command Start Journal Access Path (STRJRNAP) to journal any index created by Db2 for i.

- Index rebuild

All indexes on the system have a maintenance option that specifies when an index is maintained. SQL indexes are created with an attribute of *IMMED maintenance.

In the event of a power failure or an abnormal system failure, if indexes are not protected by one of the previously described techniques, those indexes in the process of change might need to be rebuilt by the database manager to make sure that they agree with the actual data. All indexes on the system have a recovery option that specifies when an index should be rebuilt if necessary. All SQL indexes with an attribute of UNIQUE are created with a recovery attribute of *IPL (this means that these indexes are rebuilt before the IBM i operating system is started). All other SQL indexes are created with the *AFTIPL recovery option (this means that after the operating system is started, indexes are asynchronously rebuilt). During an IPL, the operator can see a display showing the indexes that need to be rebuilt and their recovery options. The operator can override the recovery options.

- Save and restore of indexes

The save/restore function allows you to save indexes when a table is saved by using ACCPTH(*YES) on the Save Object (SAVOBJ) or Save Library (SAVLIB) CL commands. In the event of a restore when the indexes have also been saved, there is no need to rebuild the indexes. Any indexes not previously saved and restored are automatically and asynchronously rebuilt by the database manager.

Catalog integrity

To ensure that the information in the catalog is always accurate, the Db2 for i database prevents users from explicitly changing the information in the catalog and implicitly maintains the information when an SQL object described in the catalog is changed.

The integrity of the catalog is maintained whether objects in the schema are changed by SQL statements, IBM i CL commands, System/38 Environment CL commands, System/36 Environment functions, or any

other product or utility on an IBM i platform. For example, you can delete a table by running an SQL DROP statement, issuing an IBM i Delete File (DLTF) CL command, issuing a System/38 Delete File (DLTF) CL command, or entering option 4 on a WRKF or WRKOBJ display. Regardless of the interface used to delete the table, the database manager removes the description of the table from the catalog when the table is deleted. The following table lists various functions and their associated effects on the catalog.

Table 49. Effects of various functions on catalogs

Function	Effect on the catalog
Add constraint to table	Information added to catalog
Remove of constraint from table	Related information removed from catalog
Create object into schema	Information added to catalog
Delete of object from schema	Related information removed from catalog
Restore of object into schema	Information added to catalog
Change of object long comment	Comment updated in catalog
Change of object label (text)	Label updated in catalog
Change of object owner	Owner updated in catalog
Move of object from a schema	Related information removed from catalog
Move of object into schema	Information added to catalog
Rename of object	Name of object updated in catalog

User auxiliary storage pool

You can create a schema in a user auxiliary storage pool (ASP) using the ASP clause on the CREATE SCHEMA statement.

The Create Library (CRTLIB) command can also be used to create a library in a user ASP. That library can then be used to receive SQL tables, views, and indexes.

Related concepts

[Backup and recovery](#)

[Disk management](#)

Independent auxiliary storage pool

Independent disk pools are used to set up user databases on the system.

There are three types of independent disk pools: primary, secondary, and user-defined file system (UDFS). Primary independent disk pools are used to set up databases.

You can work with multiple databases. The system provides a system database (often referred to as SYSBAS) and the ability to work with one or more user databases. User databases are implemented on the system through the use of independent disk pools, which are set up in the disk management function of System i Navigator. After an independent disk pool is set up, it appears as another database in the Databases folder of System i Navigator.

Related concepts

[Disk management](#)

Routines

Routines are pieces of code or programs that you can call to perform operations.

Stored procedures

A *procedure* (often called a stored procedure) is a program that can be called to perform operations. A procedure can include both host language statements and SQL statements. Procedures in SQL provide the same benefits as procedures in a host language.

Db2 stored procedure support provides a way for an SQL application to define and then call a procedure through SQL statements. Stored procedures can be used in both distributed and nondistributed Db2 applications. One of the advantages of using stored procedures is that for distributed applications, the processing of one CALL statement on the application requester, or client, can perform any amount of work on the application server.

You may define a procedure as either an SQL procedure or an external procedure. An external procedure can be any supported high level language program (except System/36 programs and procedures) or a REXX procedure. The procedure does not need to contain SQL statements, but it may contain SQL statements. An SQL procedure is defined entirely in SQL, and can contain SQL statements that include SQL control statements.

Coding stored procedures requires that the user understand the following:

- Stored procedure definition through the CREATE PROCEDURE statement
- Stored procedure invocation through the CALL statement
- Parameter passing conventions
- Methods for returning a completion status to the program invoking the procedure.

You may define stored procedures by using the CREATE PROCEDURE statement. The CREATE PROCEDURE statement adds procedure and parameter definitions to the catalog tables SYSROUTINES and SYSPARMS. These definitions are then accessible by any SQL CALL statement on the system.

To create an external procedure or an SQL procedure, you can use the SQL CREATE PROCEDURE statement.

The following sections describe the SQL statements used to define and call the stored procedure, information about passing parameters to the stored procedure, and examples of stored procedure usage.

For more information about stored procedures, see [Stored Procedures, Triggers, and User-Defined](#)

[Functions on DB2 Universal Database for iSeries](#) 

Related concepts

[Stored procedures](#)

A *stored procedure* is a program that can be called with the SQL CALL statement.

[Java SQL routines](#)

Related reference

[DRDA stored procedure considerations](#)

The IBM i Distributed Relational Database Architecture (DRDA) server supports the return of one or more result sets in a stored procedure.

[CREATE PROCEDURE](#)

Defining an external procedure

The CREATE PROCEDURE statement for an external procedure names the procedure, defines the parameters and their attributes, and provides other information about the procedure that the system uses when it calls the procedure.

Consider the following example:

```
CREATE PROCEDURE P1
  (INOUT PARM1 CHAR(10))
  EXTERNAL NAME MYLIB.PROC1
  LANGUAGE C
  GENERAL WITH NULLS
```

This CREATE PROCEDURE statement:

- Names the procedure P1
- Defines one parameter which is used both as an input parameter and an output parameter. The parameter is a character field of length ten. Parameters can be defined to be type IN, OUT, or INOUT. The parameter type determines when the values for the parameters get passed to and from the procedure.
- Defines the name of the program which corresponds to the procedure, which is PROC1 in MYLIB. MYLIB.PROC1 is the program which is called when the procedure is called on a CALL statement.
- Indicates that the procedure P1 (program MYLIB.PROC1) is written in C. The language is important since it impacts the types of parameters that can be passed. It also affects how the parameters are passed to the procedure (for example, for ILE C procedures, a NUL-terminator is passed on character, graphic, date, time, and timestamp parameters).
- Defines the CALL type to be GENERAL WITH NULLS. This indicates that the parameter for the procedure can possibly contain the NULL value, and therefore will like an additional argument passed to the procedure on the CALL statement. The additional argument is an array of N short integers, where N is the number of parameters that are declared in the CREATE PROCEDURE statement. In this example, the array contains only one element since there is only parameter.

It is important to note that it is not necessary to define a procedure in order to call it. However, if no procedure definition is found, either from a prior CREATE PROCEDURE or from a DECLARE PROCEDURE in this program, certain restrictions and assumptions are made when the procedure is called on the CALL statement. For example, the NULL indicator argument cannot be passed.

Related reference

[Using the embedded CALL statement where no procedure definition exists](#)

A static CALL statement without a corresponding CREATE PROCEDURE statement is processed with these rules.

Defining an SQL procedure

The CREATE PROCEDURE statement for an SQL procedure names the procedure, defines the parameters and their attributes, provides other information about the procedure that is used when the procedure is called, and defines the procedure body. It is written in the SQL procedural language called SQL PL.

The *procedure body* is the executable part of the procedure and is a single SQL statement.

Consider the following simple example that takes as input an employee number and a rate and updates the employee's salary:

```
CREATE PROCEDURE UPDATE_SALARY_1
  (IN EMPLOYEE_NUMBER CHAR(10),
  IN RATE DECIMAL(6,2))
  LANGUAGE SQL MODIFIES SQL DATA
  UPDATE CORPDATA.EMPLOYEE
  SET SALARY = SALARY * RATE
  WHERE EMPNO = EMPLOYEE_NUMBER
```

This CREATE PROCEDURE statement:

- Names the procedure UPDATE_SALARY_1.
- Defines parameter EMPLOYEE_NUMBER which is an input parameter and is a character data type of length 6 and parameter RATE which is an input parameter and is a decimal data type.
- Indicates the procedure is an SQL procedure that modifies SQL data.
- Defines the procedure body as a single UPDATE statement. When the procedure is called, the UPDATE statement is executed using the values passed for EMPLOYEE_NUMBER and RATE.

Instead of a single UPDATE statement, logic can be added to the SQL procedure by using SQL control statements. SQL control statements consist of the following statements:

- An assignment statement
- A CALL statement
- A CASE statement
- A compound statement
- A FOR statement
- A GET DIAGNOSTICS statement
- A GOTO statement
- An IF statement
- An ITERATE statement
- A LEAVE statement
- A LOOP statement
- A REPEAT statement
- A RESIGNAL statement
- A RETURN statement
- A SIGNAL statement
- A WHILE statement

The following example takes as input the employee number and a rating that was received on the last evaluation. The procedure uses a CASE statement to determine the appropriate increase and bonus for the update.

```
CREATE PROCEDURE UPDATE_SALARY_2
  (IN EMPLOYEE_NUMBER CHAR(6),
  IN RATING INT)
LANGUAGE SQL MODIFIES SQL DATA
  CASE RATING
    WHEN 1 THEN
      UPDATE CORPDATA.EMPLOYEE
        SET SALARY = SALARY * 1.10,
        BONUS = 1000
      WHERE EMPNO = EMPLOYEE_NUMBER;
    WHEN 2 THEN
      UPDATE CORPDATA.EMPLOYEE
        SET SALARY = SALARY * 1.05,
        BONUS = 500
      WHERE EMPNO = EMPLOYEE_NUMBER;
    ELSE
      UPDATE CORPDATA.EMPLOYEE
        SET SALARY = SALARY * 1.03,
        BONUS = 0
      WHERE EMPNO = EMPLOYEE_NUMBER;
  END CASE
```

This CREATE PROCEDURE statement:

- Names the procedure UPDATE_SALARY_2.
- Defines parameter EMPLOYEE_NUMBER which is an input parameter and is a character data type of length 6 and parameter RATING which is an input parameter and is an integer data type.

- Indicates the procedure is an SQL procedure that modifies SQL data.
- Defines the procedure body. When the procedure is called, input parameter RATING is checked and the appropriate update statement is executed.

Multiple statements can be added to a procedure body by adding a compound statement. Within a compound statement, any number of SQL statements can be specified. In addition, SQL variables, cursors, and handlers can be declared.

The following example takes as input the department number. It returns the total salary of all the employees in that department and the number of employees in that department who get a bonus.

```

CREATE PROCEDURE RETURN_DEPT_SALARY
  (IN DEPT_NUMBER CHAR(3),
   OUT DEPT_SALARY DECIMAL(15,2),
   OUT DEPT_BONUS_CNT INT)
LANGUAGE SQL READS SQL DATA
P1: BEGIN
  DECLARE EMPLOYEE_SALARY DECIMAL(9,2);
  DECLARE EMPLOYEE_BONUS DECIMAL(9,2);
  DECLARE TOTAL_SALARY DECIMAL(15,2)DEFAULT 0;
  DECLARE BONUS_CNT INT DEFAULT 0;
  DECLARE END_TABLE INT DEFAULT 0;
  DECLARE C1 CURSOR FOR
    SELECT SALARY, BONUS FROM CORPDATA.EMPLOYEE
    WHERE WORKDEPT = DEPT_NUMBER;
  DECLARE CONTINUE HANDLER FOR NOT FOUND
    SET END_TABLE = 1;
  DECLARE EXIT HANDLER FOR SQLEXCEPTION
    SET DEPT_SALARY = NULL;
  OPEN C1;
  FETCH C1 INTO EMPLOYEE_SALARY, EMPLOYEE_BONUS;
  WHILE END_TABLE = 0 DO
    SET TOTAL_SALARY = TOTAL_SALARY + EMPLOYEE_SALARY + EMPLOYEE_BONUS;
    IF EMPLOYEE_BONUS > 0 THEN
      SET BONUS_CNT = BONUS_CNT + 1;
    END IF;
    FETCH C1 INTO EMPLOYEE_SALARY, EMPLOYEE_BONUS;
  END WHILE;
  CLOSE C1;
  SET DEPT_SALARY = TOTAL_SALARY;
  SET DEPT_BONUS_CNT = BONUS_CNT;
END P1

```

This CREATE PROCEDURE statement:

- Names the procedure RETURN_DEPT_SALARY.
- Defines parameter DEPT_NUMBER which is an input parameter and is a character data type of length 3, parameter DEPT_SALARY which is an output parameter and is a decimal data type, and parameter DEPT_BONUS_CNT which is an output parameter and is an integer data type.
- Indicates the procedure is an SQL procedure that reads SQL data
- Defines the procedure body.
 - Declares SQL variables EMPLOYEE_SALARY and TOTAL_SALARY as decimal fields.
 - Declares SQL variables BONUS_CNT and END_TABLE which are integers and are initialized to 0.
 - Declares cursor C1 that selects the columns from the employee table.
 - Declares a continue handler for NOT FOUND, which, when called sets variable END_TABLE to 1. This handler is called when the FETCH has no more rows to return. When the handler is called, SQLCODE and SQLSTATE are reinitialized to 0.
 - Declares an exit handler for SQLEXCEPTION. If called, DEPT_SALARY is set to NULL and the processing of the compound statement is terminated. This handler is called if any errors occur, that is, the SQLSTATE class is not '00', '01' or '02'. Since indicators are always passed to SQL procedures, the indicator value for DEPT_SALARY is -1 when the procedure returns. If this handler is called, SQLCODE and SQLSTATE are reinitialized to 0.

If the handler for `SQLXCEPTION` is not specified and an error occurs that is not handled in another handler, execution of the compound statement is terminated and the error is returned in the `SQLCA`. Similar to indicators, the `SQLCA` is always returned from `SQL` procedures.

- Includes an `OPEN`, `FETCH`, and `CLOSE` of cursor `C1`. If a `CLOSE` of the cursor is not specified, the cursor is closed at the end of the compound statement since `SET RESULT SETS` is not specified in the `CREATE PROCEDURE` statement.
- Includes a `WHILE` statement which loops until the last record is fetched. For each row retrieved, the `TOTAL_SALARY` is incremented and, if the employee's bonus is more than 0, the `BONUS_CNT` is incremented.
- Returns `DEPT_SALARY` and `DEPT_BONUS_CNT` as output parameters.

Compound statements can be made atomic so if an error occurs that is not expected, the statements within the atomic statement are rolled back. The atomic compound statements are implemented using `SAVEPOINTS`. If the compound statement is successful, the transaction is committed.

The following example takes as input the department number. It ensures the `EMPLOYEE_BONUS` table exists, and inserts the name of all employees in the department who get a bonus. The procedure returns the total count of all employees who get a bonus.

```
CREATE PROCEDURE CREATE_BONUS_TABLE
(IN DEPT_NUMBER CHAR(3),
 INOUT CNT INT)
LANGUAGE SQL MODIFIES SQL DATA
CS1: BEGIN ATOMIC
DECLARE NAME VARCHAR(30) DEFAULT NULL;
DECLARE CONTINUE HANDLER FOR SQLSTATE '42710'
SELECT COUNT(*) INTO CNT
FROM DATALIB.EMPLOYEE_BONUS;
DECLARE CONTINUE HANDLER FOR SQLSTATE '23505'
SET CNT = CNT - 1;
DECLARE UNDO HANDLER FOR SQLXCEPTION
SET CNT = NULL;
IF DEPT_NUMBER IS NOT NULL THEN
CREATE TABLE DATALIB.EMPLOYEE_BONUS
(FULLNAME VARCHAR(30),
 BONUS DECIMAL(10,2),
 PRIMARY KEY (FULLNAME));
FOR_1:FOR V1 AS C1 CURSOR FOR
SELECT FIRSTNME, MIDINIT, LASTNAME, BONUS
FROM CORPDATA.EMPLOYEE
WHERE WORKDEPT = CREATE_BONUS_TABLE.DEPT_NUMBER
DO
IF BONUS > 0 THEN
SET NAME = FIRSTNME CONCAT ' ' CONCAT
MIDINIT CONCAT ' ' CONCAT LASTNAME;
INSERT INTO DATALIB.EMPLOYEE_BONUS
VALUES(CS1.NAME, FOR_1.BONUS);
SET CNT = CNT + 1;
END IF;
END FOR FOR_1;
END IF;
END CS1
```

This `CREATE PROCEDURE` statement:

- Names the procedure `CREATE_BONUS_TABLE`.
- Defines parameter `DEPT_NUMBER` which is an input parameter and is a character data type of length 3 and parameter `CNT` which is an input/output parameter and is an integer data type.
- Indicates the procedure is an `SQL` procedure that modifies `SQL` data
- Defines the procedure body.
 - Declares `SQL` variable `NAME` as varying character.
 - Declares a continue handler for `SQLSTATE 42710`, table already exists. If the `EMPLOYEE_BONUS` table already exists, the handler is called and retrieves the number of records in the table. The `SQLCODE` and `SQLSTATE` are reset to 0 and processing continues with the `FOR` statement.

- Declares a continue handler for SQLSTATE 23505, duplicate key. If the procedure attempts to insert a name that already exists in the table, the handler is called and decrements CNT. Processing continues on the SET statement following the INSERT statement.
- Declares an UNDO handler for SQLEXCEPTION. If called, the previous statements are rolled back, CNT is set to 0, and processing continues after the compound statement. In this case, since there is no statement following the compound statement, the procedure returns.
- Uses the FOR statement to declare cursor C1 to read the records from the EMPLOYEE table. Within the FOR statement, the column names from the select list are used as SQL variables that contain the data from the row fetched. For each row, data from columns FIRSTNME, MIDINIT, and LASTNAME are concatenated together with a blank in between and the result is put in SQL variable NAME. SQL variables NAME and BONUS are inserted into the EMPLOYEE_BONUS table. Because the data type of the select list items must be known when the procedure is created, the table specified in the FOR statement must exist when the procedure is created.

An SQL variable name can be qualified with the label name of the FOR statement or compound statement in which it is defined. In the example, FOR_1.BONUS refers to the SQL variable that contains the value of column BONUS for each row selected. CS1.NAME is the variable NAME defined in the compound statement with the beginning label CS1. Parameter names can also be qualified with the procedure name. CREATE_BONUS_TABLE.DEPT_NUMBER is the DEPT_NUMBER parameter for the procedure CREATE_BONUS_TABLE. If unqualified SQL variable names are used in SQL statements where column names are also allowed, and the variable name is the same as a column name, the name will be used to refer to the column.

You can also use dynamic SQL in an SQL procedure. The following example creates a table that contains all employees in a specific department. The department number is passed as input to the procedure and is concatenated to the table name.

```
CREATE PROCEDURE CREATE_DEPT_TABLE (IN P_DEPT CHAR(3))
LANGUAGE SQL
BEGIN
  DECLARE STMT CHAR(1000);
  DECLARE MESSAGE CHAR(20);
  DECLARE TABLE_NAME CHAR(30);
  DECLARE CONTINUE HANDLER FOR SQLEXCEPTION
    SET MESSAGE = 'ok';
  SET TABLE_NAME = 'CORPDATA.DEPT_' CONCAT P_DEPT CONCAT '_T';
  SET STMT = 'DROP TABLE ' CONCAT TABLE_NAME;
  PREPARE S1 FROM STMT;
  EXECUTE S1;
  SET STMT = 'CREATE TABLE ' CONCAT TABLE_NAME CONCAT
    '( EMPNO CHAR(6) NOT NULL,
      FIRSTNME VARCHAR(12) NOT NULL,
      MIDINIT CHAR(1) NOT NULL,
      LASTNAME CHAR(15) NOT NULL,
      SALARY DECIMAL(9,2))';
  PREPARE S2 FROM STMT;
  EXECUTE S2;
  SET STMT = 'INSERT INTO ' CONCAT TABLE_NAME CONCAT
    'SELECT EMPNO, FIRSTNME, MIDINIT, LASTNAME, SALARY
    FROM CORPDATA.EMPLOYEE
    WHERE WORKDEPT = ?';
  PREPARE S3 FROM STMT;
  EXECUTE S3 USING P_DEPT;
END
```

This CREATE PROCEDURE statement:

- Names the procedure CREATE_DEPT_TABLE
- Defines parameter P_DEPT which is an input parameter and is a character data type of length 3.
- Indicates the procedure is an SQL procedure.
- Defines the procedure body.
 - Declares SQL variable STMT and an SQL variable TABLE_NAME as character.
 - Declares a CONTINUE handler. The procedure attempts to DROP the table in case it already exists. If the table does not exist, the first EXECUTE fails. With the handler, processing will continue.

- Sets variable TABLE_NAME to 'DEPT_' followed by the characters passed in parameter P_DEPT, followed by '_T'.
- Sets variable STMT to the DROP statement, and prepares and executes the statement.
- Sets variable STMT to the CREATE statement, and prepares and executes the statement.
- Sets variable STMT to the INSERT statement, and prepares and executes the statement. A parameter marker is specified in the where clause. When the statement is executed, the variable P_DEPT is passed on the USING clause.

If the procedure is called passing value 'D21' for the department, table DEPT_D21_T is created and the table is initialized with all the employees that are in department 'D21'.

Defining a procedure with default parameters

External and SQL procedures can be created with optional parameters. Optional procedure parameters are defined to have a default value.

Suppose you have a procedure that is defined with parameters as follows. Whether this is part of an SQL procedure or an external procedure statement doesn't matter; only the parameter definitions are being discussed here.

```
CREATE PROCEDURE UPDATE_EMPLOYEE_INFO
(IN EMPLOYEE_NUMBER CHAR(10),
 IN EMP_DEPT CHAR(3),
 IN PHONE_NUMBER CHAR(4))
. . .
```

This procedure has been in use for a long time and is invoked from many places. Now, someone has suggested that it would be useful to have this procedure update a few other columns in the same table, JOB and EDLEVEL. Finding and changing all the calls to this procedure is a huge job, but if you add the new parameters so they have default values it is very easy.

The parameter definitions in the following CREATE PROCEDURE statement will allow all of the columns except the employee number to be passed in optionally.

```
CREATE OR REPLACE PROCEDURE UPDATE_EMPLOYEE_INFO
(IN EMPLOYEE_NUMBER CHAR(10),
 IN EMP_DEPT CHAR(3) DEFAULT NULL,
 IN PHONE_NUMBER CHAR(4) DEFAULT NULL,
 IN JOB CHAR(8) DEFAULT NULL,
 IN EDLEVEL SMALLINT DEFAULT NULL)
. . .
```

The code for this procedure, either an SQL routine or an external program, needs to be modified to handle the new parameters and to correctly process the two existing parameters when a NULL value is passed. Since default parameters are optional, any existing call to this procedure will not need to change; the two new parameters will pass a value of NULL to the procedure code. Any caller who needs the new parameters can include them on the SQL CALL statement.

Although this example uses NULL for all the default values, almost any expression can be used. It can be a simple constant or a complex query. It cannot reference any of the other parameters.

There are several ways to have the defaults used for the CALL statement.

- Omit the parameters at the end that you do not need to use.

```
CALL UPDATE_EMPLOYEE_INFO('123456', 'D11', '4424')
```

The defaults will be used for the JOB and EDLEVEL parameters.

- Use the DEFAULT keyword for any parameters that are omitted.

```
CALL UPDATE_EMPLOYEE_INFO('123456', DEFAULT, '4424', DEFAULT, DEFAULT)
```

All the parameters are represented in this statement. The defaults will be used for the EMP_DEPT, JOB, and EDLEVEL parameters.

- Explicitly name some of the arguments with the corresponding parameter name and omit parameters that are not used.

```
CALL UPDATE_EMPLOYEE_INFO('123456', EDLEVEL => 18)
```

By using the parameter name, the other three parameters do not need to be represented in this CALL statement. The defaults will be used for the EMP_DEPT, PHONE_NUMBER, and JOB parameters.

Named arguments can be in any order in the CALL statement. Unnamed arguments must match the order of the parameter definitions for the procedure and must be specified ahead of any named arguments. Once a named argument is used in the statement, all arguments that follow it must also be named. Any parameters that do not have an argument in the CALL statement must have a default defined.

In the following example, the procedure creates a table containing all employees in a specified department. The schema where it gets created has always been hard-coded for the environment where it is used. For testing, however, it would be convenient to create the table in a test schema.

```
CREATE OR REPLACE PROCEDURE CREATE_DEPT_TABLE2
    (IN P_DEPT CHAR(3),
     IN SCHEMA_NAME VARCHAR(128) DEFAULT 'CORPDATA')
BEGIN
    DECLARE DYNAMIC_STMT VARCHAR(1000);
    DECLARE MESSAGE CHAR(20);
    DECLARE TABLE_NAME VARCHAR(200);
    DECLARE CONTINUE HANDLER FOR SQLEXCEPTION
        SET MESSAGE = 'ok';

    SET TABLE_NAME = ''' CONCAT SCHEMA_NAME CONCAT
        '''.DEPT_' CONCAT P_DEPT CONCAT '_T';

    SET DYNAMIC_STMT = 'DROP TABLE ' CONCAT TABLE_NAME;
    EXECUTE IMMEDIATE DYNAMIC_STMT;

    SET DYNAMIC_STMT = 'CREATE TABLE ' CONCAT TABLE_NAME CONCAT
        '( EMPNO CHAR(6) NOT NULL,
        FIRSTNME VARCHAR(12) NOT NULL,
        MIDINIT CHAR(1) NOT NULL,
        LASTNAME CHAR(15) NOT NULL,
        SALARY DECIMAL(9,2))';
    EXECUTE IMMEDIATE DYNAMIC_STMT;

    SET DYNAMIC_STMT = 'INSERT INTO ' CONCAT TABLE_NAME CONCAT
        'SELECT EMPNO, FIRSTNME, MIDINIT, LASTNAME, SALARY
        FROM CORPDATA.EMPLOYEE
        WHERE WORKDEPT = ?';
    PREPARE INSERT_INTO_DEPARTMENT_STMT FROM DYNAMIC_STMT;
    EXECUTE INSERT_INTO_DEPARTMENT_STMT USING P_DEPT;
END;
```

A second parameter is defined to pass a schema name. It has a default of 'CORPDATA'. This is the value that has been used by the procedure in the past.

When run in the production environment, the CALL statement might be:

```
CALL CREATE_DEPT_TABLE2('D21')
```

Since the SCHEMA_NAME parameter is not specified, the default parameter value is used. The table DEPT_D21 is created in CORPDATA.

When run in the test environment, the CALL statement might be:

```
CALL CREATE_DEPT_TABLE2('D21', 'TESTSCHEMA')
```

This creates the table DEPT_D21 in the specified schema, TESTSCHEMA.

Calling a stored procedure

The SQL CALL statement calls a stored procedure.

On the CALL statement, the name of the stored procedure and any arguments are specified. Arguments may be constants, special registers, host variables, or expressions. The external stored procedure

specified in the CALL statement does not need to have a corresponding CREATE PROCEDURE statement. Programs created by SQL procedures can only be called by invoking the procedure name specified on the CREATE PROCEDURE statement.

Although procedures are system program objects, using the CALL CL command will not typically work to call a procedure. The CALL CL command does not use the procedure definition to map the input and output parameters, nor does it pass parameters to the program using the procedure's parameter style.

The following types of CALL statements need to be addressed because the Db2 for i database has different rules for each type:

- Embedded or dynamic CALL statement where a procedure definition exists
- Embedded CALL statement where no procedure definition exists
- Dynamic CALL statement where no CREATE PROCEDURE exists

Notes:

Dynamic here refers to:

- A dynamically prepared and executed CALL statement.
- A CALL statement issued in an interactive environment (for example, through Run SQL Scripts or Query Manager).
- A CALL statement executed in an EXECUTE IMMEDIATE statement.

Using the CALL statement where procedure definition exists

This type of CALL statement reads all the information about the procedure and the argument attributes from the CREATE PROCEDURE catalog definition.

The following PL/I example shows a CALL statement that corresponds to the CREATE PROCEDURE statement shown.

```
DCL HV1 CHAR(10);
DCL IND1 FIXED BIN(15);
:
EXEC SQL CREATE P1 PROCEDURE
      (INOUT PARM1 CHAR(10))
      EXTERNAL NAME MYLIB.PROC1
      LANGUAGE C
      GENERAL WITH NULLS;
:
EXEC SQL CALL P1 (:HV1 :IND1);
:
```

When this CALL statement is issued, a call to program MYLIB/PROC1 is made and two arguments are passed. Because the language of the program is ILE C, the first argument is a C NUL-terminated string, 11 characters long, which contains the contents of host variable HV1. On a call to an ILE C procedure, SQL adds one character to the parameter declaration if the parameter is declared to be a character, graphic, date, time, or timestamp variable. The second argument is the indicator array. In this case, it is one short integer because there is only one parameter in the CREATE PROCEDURE statement. This argument contains the contents of indicator variable IND1 on entry to the procedure.

Since the first parameter is declared as INOUT, SQL updates the host variable HV1 and the indicator variable IND1 with the values returned from MYLIB.PROC1 before returning to the user program.

Notes:

1. The procedure names specified on the CREATE PROCEDURE and CALL statements must match EXACTLY in order for the link between the two to be made during the SQL precompile of the program.
2. For an embedded CALL statement where both a CREATE PROCEDURE and a DECLARE PROCEDURE statement exist, the DECLARE PROCEDURE statement will be used.

Using the embedded CALL statement where no procedure definition exists

A static CALL statement without a corresponding CREATE PROCEDURE statement is processed with these rules.

- All host variable arguments are treated as INOUT type parameters.
- The CALL type is GENERAL (no indicator argument is passed).
- The program to call is determined based on the procedure name specified on the CALL, and, if necessary, the naming convention.
- The language of the program to call is determined based on information retrieved from the system about the program.

Example: Embedded CALL statement where no procedure definition exists

The following PL/I example shows an embedded CALL statement where no procedure definition exists:

```
DCL HV2 CHAR(10);  
      :  
EXEC SQL CALL P2 (:HV2);  
      :
```

When the CALL statement is issued, SQL attempts to find the program based on standard SQL naming conventions. For the preceding example, assume that the naming option of *SYS (system naming) is used and that a DFTRDBCOL parameter is not specified on the Create SQL PL/I Program (CRTSQLPLI) command. In this case, the library list is searched for a program named P2. Because the call type is GENERAL, no additional argument is passed to the program for indicator variables.

Note: If an indicator variable is specified on the CALL statement and its value is less than zero when the CALL statement is executed, an error results because there is no way to pass the indicator to the procedure.

Assuming program P2 is found in the library list, the contents of host variable HV2 are passed in to the program on the CALL and the argument returned from P2 is mapped back to the host variable after P2 has completed execution.

For numeric constants passed on a CALL statement, the following rules apply:

- All integer constants are passed as fullword binary integers.
- All decimal constants are passed as packed decimal values. Precision and scale are determined based on the constant value. For instance, a value of 123.45 is passed as a packed decimal(5,2). Likewise, a value of 001.01 is also passed with a precision of 5 and a scale of 2.
- All floating point constants are passed as double-precision floating point.

Special registers specified on a dynamic CALL statement are passed as their defined data type and length with the following exceptions:

CURRENT DATE

Passed as a 10-byte character string in ISO format.

CURRENT TIME

Passed as an 8-byte character string in ISO format.

CURRENT TIMESTAMP

Passed as a 26-byte character string in IBM SQL format.

Using the embedded CALL statement with an SQLDA

In either type of embedded CALL statement (where a procedure definition might or might not exist), an SQLDA or an SQL descriptor, rather than a parameter list, can be passed.

The following C examples illustrates executing a CALL statement using an SQLDA structure. Assume that the stored procedure is expecting 2 parameters, the first of type SHORT INT and the second of type CHAR with a length of 4.

Note: By using the code examples, you agree to the terms of the [“Code license and disclaimer information”](#) on page 396.

```
#define SQLDA_HV_ENTRIES 2
#define SHORTINT 500
#define NUL_TERM_CHAR 460

exec sql include sqlca;
exec sql include sqlda;
...
typedef struct sqlda Sqlda;
typedef struct sqlda* Sqldap;
...
main()
{
    Sqldap dap;
    short col1;
    char col2[4];
    int bc;
    dap = (Sqldap) malloc(bc=SQLDASIZE(SQLDA_HV_ENTRIES));
    /* SQLDASIZE is a macro defined in the sqlda include */
    col1 = 431;
    strcpy(col2,"abc");
    strncpy(dap->sqldaid,"SQLDA  ",8);
    dap->sqldabc = bc; /* bc set in the malloc statement above */
    dap->sqln = SQLDA_HV_ENTRIES;
    dap->sqld = SQLDA_HV_ENTRIES;
    dap->sqlvar[0].sqltype = SHORTINT;
    dap->sqlvar[0].sqlllen = 2;
    dap->sqlvar[0].sqldata = (char*) &col1;
    dap->sqlvar[0].sqlname.length = 0;
    dap->sqlvar[1].sqltype = NUL_TERM_CHAR;
    dap->sqlvar[1].sqlllen = 4;
    dap->sqlvar[1].sqldata = col2;
    ...
    EXEC SQL CALL P1 USING DESCRIPTOR :*dap;
    ...
}
```

The name of the called procedure may also be stored in a host variable and the host variable used in the CALL statement, instead of the hard-coded procedure name. For example:

```
...
main()
{
    char proc_name[15];
    ...
    strcpy (proc_name, "MYLIB.P3");
    ...
    EXEC SQL CALL :proc_name ...;
    ...
}
```

In the above example, if MYLIB.P3 is expecting parameters, either a parameter list or an SQLDA passed with the USING DESCRIPTOR clause may be used, as shown in the previous example.

When a host variable containing the procedure name is used in the CALL statement and a CREATE PROCEDURE catalog definition exists, it will be used. The procedure name cannot be specified as a parameter marker.

Using the dynamic CALL statement where no CREATE PROCEDURE exists

These rules pertain to the processing of a dynamic CALL statement when there is no CREATE PROCEDURE definition.

- All arguments are treated as IN type parameters.
- The CALL type is GENERAL (no indicator argument is passed).
- The program to call is determined based on the procedure name specified on the CALL and the naming convention.
- The language of the program to call is determined based on information retrieved from the system about the program.

Example: Dynamic CALL statement where no CREATE PROCEDURE exists

The following C example shows a dynamic CALL statement:

```
char hv3[10],string[100];
:
strcpy(string,"CALL MYLIB.P3 ('P3 TEST')");
EXEC SQL EXECUTE IMMEDIATE :string;
:
```

This example shows a dynamic CALL statement executed through an EXECUTE IMMEDIATE statement. The call is made to program MYLIB.P3 with one parameter passed as a character variable containing 'P3 TEST'.

When executing a CALL statement and passing a constant, as in the previous example, the length of the expected argument in the program must be kept in mind. If program MYLIB.P3 expected an argument of only 5 characters, the last 2 characters of the constant specified in the example is lost to the program.

Note: For this reason, it is always safer to use host variables on the CALL statement so that the attributes of the procedure can be matched exactly and so that characters are not lost. For dynamic SQL, host variables can be specified for CALL statement arguments if the PREPARE and EXECUTE statements are used to process it.

Examples: CALL statements

These examples show how the arguments of a CALL statement are passed to a procedure for several languages, and how the arguments are received into local variables in the procedure.

Example 1: ILE C and PL/I procedures called from an ILE C program

This example shows an ILE C program that uses the CREATE PROCEDURE definitions to call the P1 and P2 procedures. Procedure P1 is written in ILE C and has 10 parameters. Procedure P2 is written in PL/I and also has 10 parameters.

Defining the P1 and P2 procedures

```
EXEC SQL CREATE PROCEDURE P1 (INOUT PARM1 CHAR(10),
                             INOUT PARM2 INTEGER,
                             INOUT PARM3 SMALLINT,
                             INOUT PARM4 FLOAT(22),
                             INOUT PARM5 FLOAT(53),
                             INOUT PARM6 DECIMAL(10,5),
                             INOUT PARM7 VARCHAR(10),
                             INOUT PARM8 DATE,
                             INOUT PARM9 TIME,
                             INOUT PARM10 TIMESTAMP)
    EXTERNAL NAME TEST12.CALLPROC2
    LANGUAGE C GENERAL WITH NULLS

EXEC SQL CREATE PROCEDURE P2 (INOUT PARM1 CHAR(10),
                             INOUT PARM2 INTEGER,
                             INOUT PARM3 SMALLINT,
                             INOUT PARM4 FLOAT(22),
                             INOUT PARM5 FLOAT(53),
                             INOUT PARM6 DECIMAL(10,5),
                             INOUT PARM7 VARCHAR(10),
                             INOUT PARM8 DATE,
                             INOUT PARM9 TIME,
                             INOUT PARM10 TIMESTAMP)
    EXTERNAL NAME TEST12.CALLPROC
    LANGUAGE PLI GENERAL WITH NULLS
```

Note: By using the code examples, you agree to the terms of the [“Code license and disclaimer information”](#) on page 396.

Calling the P1 and P2 procedures

```
/******  
/***** START OF SQL C Application *****/
```

```

#include <stdio.h>
#include <string.h>
#include <decimal.h>
main()
{
EXEC SQL INCLUDE SQLCA;
char PARM1[10];
signed long int PARM2;
signed short int PARM3;
float PARM4;
double PARM5;
decimal(10,5) PARM6;
struct { signed short int parm7l;
        char parm7c[10];
        } PARM7;
char PARM8[10];          /* FOR DATE */
char PARM9[8];          /* FOR TIME */
char PARM10[26];        /* FOR TIMESTAMP */

/*****
/* Initialize variables for the call to the procedures */
*****/
strcpy(PARM1,"PARM1");
PARM2 = 7000;
PARM3 = -1;
PARM4 = 1.2;
PARM5 = 1.0;
PARM6 = 10.555;
PARM7.parm7l = 5;
strcpy(PARM7.parm7c,"PARM7");
strcpy(PARM8,"1994-12-31",10);          /* FOR DATE */
strcpy(PARM9,"12.00.00",8);           /* FOR TIME */
strcpy(PARM10,"1994-12-31-12.00.00.000000",26); /* FOR TIMESTAMP */

/*****
/* Call the C procedure */
/* */
/* */
*****/
EXEC SQL CALL P1 (:PARM1, :PARM2, :PARM3,
                 :PARM4, :PARM5, :PARM6,
                 :PARM7, :PARM8, :PARM9,
                 :PARM10 );
if (strcmp(SQLSTATE,"00000",5))
{
/* Handle error or warning returned on CALL statement */
}

/* Process return values from the CALL. */
:

/*****
/* Call the PLI procedure */
/* */
/* */
*****/
/* Reset the host variables before making the CALL */
/* */
:
EXEC SQL CALL P2 (:PARM1, :PARM2, :PARM3,
                 :PARM4, :PARM5, :PARM6,
                 :PARM7, :PARM8, :PARM9,
                 :PARM10 );
if (strcmp(SQLSTATE,"00000",5))
{
/* Handle error or warning returned on CALL statement */
}
/* Process return values from the CALL. */
:
}

/***** END OF C APPLICATION *****/
/*****

```

Procedure P1

```
/****** START OF C PROCEDURE P1 *****/
/*          PROGRAM TEST12/CALLPROC2          */
/******

#include <stdio.h>
#include <string.h>
#include <decimal.h>
main(argc,argv)
  int argc;
  char *argv[];
  {
    char parm1[11];
    long int parm2;
    short int parm3,i,j,*ind,ind1,ind2,ind3,ind4,ind5,ind6,ind7,
                ind8,ind9,ind10;
    float parm4;
    double parm5;
    decimal(10,5) parm6;
    char parm7[11];
    char parm8[10];
    char parm9[8];
    char parm10[26];
    /* *****/
    /* Receive the parameters into the local variables - */
    /* Character, date, time, and timestamp are passed as */
    /* NUL terminated strings - cast the argument vector to */
    /* the proper data type for each variable. Note that */
    /* the argument vector can be used directly instead of */
    /* copying the parameters into local variables - the copy */
    /* is done here just to illustrate the method. */
    /* *****/

    /* Copy 10 byte character string into local variable */
    strcpy(parm1,argv[1]);

    /* Copy 4 byte integer into local variable */
    parm2 = *(int *) argv[2];

    /* Copy 2 byte integer into local variable */
    parm3 = *(short int *) argv[3];

    /* Copy floating point number into local variable */
    parm4 = *(float *) argv[4];

    /* Copy double precision number into local variable */
    parm5 = *(double *) argv[5];

    /* Copy decimal number into local variable */
    parm6 = *(decimal(10,5) *) argv[6];

    /* *****/
    /* Copy NUL terminated string into local variable. */
    /* Note that the parameter in the CREATE PROCEDURE was */
    /* declared as varying length character. For C, varying */
    /* length are passed as NUL terminated strings unless */
    /* FOR BIT DATA is specified in the CREATE PROCEDURE */
    /* *****/
    strcpy(parm7,argv[7]);

    /* *****/
    /* Copy date into local variable. */
    /* Note that date and time variables are always passed in */
    /* ISO format so that the lengths of the strings are */
    /* known. strcpy works here just as well. */
    /* *****/
    strncpy(parm8,argv[8],10);

    /* Copy time into local variable */
    strncpy(parm9,argv[9],8);

    /* *****/
    /* Copy timestamp into local variable. */
    /* IBM SQL timestamp format is always passed so the length */
    /* of the string is known. */
    /* *****/
    strncpy(parm10,argv[10],26);

    /* *****/
  }
```

```

/* The indicator array is passed as an array of short */
/* integers. There is one entry for each parameter passed */
/* on the CREATE PROCEDURE (10 for this example). */
/* Below is one way to set each indicator into separate */
/* variables. */
/*****
ind = (short int *) argv[11];
ind1 = *(ind++);
ind2 = *(ind++);
ind3 = *(ind++);
ind4 = *(ind++);
ind5 = *(ind++);
ind6 = *(ind++);
ind7 = *(ind++);
ind8 = *(ind++);
ind9 = *(ind++);
ind10 = *(ind++);
:
/* Perform any additional processing here */
:
return;
}
/***** END OF C PROCEDURE P1 *****/

```

Procedure P2

```

/***** START OF PL/I PROCEDURE P2 *****/
/***** PROGRAM TEST12/CALLPROC *****/
/*****

CALLPROC :PROC( PARM1,PARM2,PARM3,PARM4,PARM5,PARM6,PARM7,
                PARM8,PARM9,PARM10,PARM11);
DCL SYSPRINT FILE STREAM OUTPUT EXTERNAL;
OPEN FILE(SYSPRINT);
DCL PARM1 CHAR(10);
DCL PARM2 FIXED BIN(31);
DCL PARM3 FIXED BIN(15);
DCL PARM4 BIN FLOAT(22);
DCL PARM5 BIN FLOAT(53);
DCL PARM6 FIXED DEC(10,5);
DCL PARM7 CHARACTER(10) VARYING;
DCL PARM8 CHAR(10); /* FOR DATE */
DCL PARM9 CHAR(8); /* FOR TIME */
DCL PARM10 CHAR(26); /* FOR TIMESTAMP */
DCL PARM11(10) FIXED BIN(15); /* Indicators */

/* PERFORM LOGIC - Variables can be set to other values for */
/* return to the calling program. */

:

END CALLPROC;

```

Example 2: A REXX procedure called from an ILE C program

This example shows a REXX procedure called from an ILE C program.

Defining the REXX procedure

```

EXEC SQL CREATE PROCEDURE REXXPROC
      (IN PARM1 CHARACTER(20),
       IN PARM2 INTEGER,
       IN PARM3 DECIMAL(10,5),
       IN PARM4 DOUBLE PRECISION,
       IN PARM5 VARCHAR(10),
       IN PARM6 GRAPHIC(4),
       IN PARM7 VARGRAPHIC(10),
       IN PARM8 DATE,
       IN PARM9 TIME,
       IN PARM10 TIMESTAMP)
      EXTERNAL NAME 'TEST.CALLSRC(CALLREXX)'
      LANGUAGE REXX GENERAL WITH NULLS

```

Note: By using the code examples, you agree to the terms of the [“Code license and disclaimer information”](#) on page 396.

Calling the REXX procedure

```

/***** START OF SQL C Application *****/

#include <decimal.h>
#include <stdio.h>
#include <string.h>
#include <wchar.h>
/*-----*/
exec sql include sqlca;
exec sql include sqlda;
/* *****/
/* Declare host variable for the CALL statement */
/* *****/
char parm1[20];
signed long int parm2;
decimal(10,5) parm3;
double parm4;
struct { short dlen;
        char dat[10];
        } parm5;
wchar_t parm6[4] = { 0xC1C1, 0xC2C2, 0xC3C3, 0x0000 };
struct { short dlen;
        wchar_t dat[10];
        } parm7 = {0x0009, 0xE2E2,0xE3E3,0xE4E4, 0xE5E5, 0xE6E6,
                  0xE7E7, 0xE8E8, 0xE9E9, 0xC1C1, 0x0000 };

char parm8[10];
char parm9[8];
char parm10[26];
main()
{

/* *****/
/* Call the procedure - on return from the CALL statement the */
/* SQLCODE should be 0. If the SQLCODE is non-zero, */
/* the procedure detected an error. */
/* *****/
strcpy(parm1,"TestingREXX");
parm2 = 12345;
parm3 = 5.5;
parm4 = 3e3;
parm5.dlen = 5;
strcpy(parm5.dat,"parm6");
strcpy(parm8,"1994-01-01");
strcpy(parm9,"13.01.00");
strcpy(parm10,"1994-01-01-13.01.00.000000");

EXEC SQL CALL REXXPROC (:parm1, :parm2,
                       :parm3,:parm4,
                       :parm5, :parm6,
                       :parm7,
                       :parm8, :parm9,
                       :parm10);

if (strncpy(SQLSTATE,"00000",5))
{
/* handle error or warning returned on CALL */
:
}
:
}

/***** END OF SQL C APPLICATION *****/
/***** START OF REXX MEMBER TEST/CALLSRC CALLREXX *****/
/***** REXX source member TEST/CALLSRC CALLREXX *****/
/* Note the extra parameter being passed for the indicator*/
/* array. */

```

```

/*
/* ACCEPT THE FOLLOWING INPUT VARIABLES SET TO THE
/* SPECIFIED VALUES :
/* AR1 CHAR(20) = 'TestingREXX'
/* AR2 INTEGER = 12345
/* AR3 DECIMAL(10,5) = 5.5
/* AR4 DOUBLE PRECISION = 3e3
/* AR5 VARCHAR(10) = 'parm6'
/* AR6 GRAPHIC = G'C1C1C2C2C3C3'
/* AR7 VARGRAPHIC =
/* G'E2E2E3E3E4E4E5E5E6E6E7E7E8E8E9E9EAEA'
/* AR8 DATE = '1994-01-01'
/* AR9 TIME = '13.01.00'
/* AR10 TIMESTAMP =
/* '1994-01-01-13.01.00.000000'
/* AR11 INDICATOR ARRAY = +0+0+0+0+0+0+0+0+0
*/

/*****
/* Parse the arguments into individual parameters
*****/
parse arg ar1 ar2 ar3 ar4 ar5 ar6 ar7 ar8 ar9 ar10 ar11

/*****
/* Verify that the values are as expected
*****/
if ar1<>'TestingREXX' then signal ar1tag
if ar2<>12345 then signal ar2tag
if ar3<>5.5 then signal ar3tag
if ar4<>3e3 then signal ar4tag
if ar5<>'parm6' then signal ar5tag
if ar6 <>'G'AABBCC' then signal ar6tag
if ar7 <>'G'SSTTUUVVWXXYYZZAA' then ,
signal ar7tag
if ar8 <> "'1994-01-01'" then signal ar8tag
if ar9 <> "'13.01.00'" then signal ar9tag
if ar10 <> "'1994-01-01-13.01.00.000000'" then signal ar10tag
if ar11 <> "+0+0+0+0+0+0+0+0+0" then signal ar11tag

/*****
/* Perform other processing as necessary ..
*****/
:
/*****
/* Indicate the call was successful by exiting with a
/* return code of 0
*****/
exit(0)

ar1tag:
say "ar1 did not match" ar1
exit(1)
ar2tag:
say "ar2 did not match" ar2
exit(1)
:
:

/***** END OF REXX MEMBER *****/

```

Returning result sets from stored procedures

In addition to returning output parameters, a stored procedure can return a result set (that is, a result table associated with a cursor opened in the stored procedure) to the application that issues the CALL statement. The application can then issue fetch requests to read the rows of the result set cursor.

Whether a result set gets returned depends on the returnability attribute of the cursor. The cursor's returnability attribute can be explicitly given in the DECLARE CURSOR statement or it can be defaulted. The SET RESULT SETS statement also allows for an indication of where the result sets should be returned. By default, cursors which are opened in a stored procedure are defined to have a returnability attribute of RETURN TO CALLER. To return the result set associated with the cursor to the application which called the outermost procedure in the call stack, the returnability attribute of RETURN TO CLIENT is specified on the DECLARE CURSOR statement. This will allow inner procedures to return result sets when the application calls nested procedures. For cursors whose result sets are never to be returned to caller or client, the returnability attribute of WITHOUT RETURN is specified on the DECLARE CURSOR statement.

Note: When you use COBOL, the result sets are automatically closed because of the setup of the COBOL program. Change the EXIT PROGRAM statement to EXIT PROGRAM AND CONTINUE RUN UNIT and the result sets should be returned.

There are many cases where opening the cursor in a stored procedure and returning its result set provides advantages over opening the cursor directly in the application. For instance, security to the tables referenced in the query can be adopted from the stored procedure so that users of the application do not need to be granted direct authority to the tables. Instead, they are given authority to call the stored procedure, which is compiled with adequate authority to access the tables. Another advantage to opening the cursors in the stored procedure is that multiple result sets can be returned from a single call to the stored procedure, which can be more efficient than opening the cursors separately from the calling application. Additionally, each call to the same stored procedure may return a different number of result sets, providing some application versatility.

The interfaces that can work with stored procedure result sets include JDBC, CLI, and ODBC. An example of how to use these API interfaces for working with stored procedure result sets is included in the following examples.

Example 1: Calling a stored procedure that returns a single result set

This example shows the API calls that an Open Database Connectivity (ODBC) application can use to call a stored procedure to return a result set.

Note that in this example the DECLARE CURSOR statement does not have an explicit returnability specified. When there is only a single stored procedure on the call stack, the returnability attribute of RETURN TO CALLER as well as that of RETURN TO CLIENT will make the result set available to the caller of the application. Also note that the stored procedure is defined with a DYNAMIC RESULT SETS clause. For SQL procedures, this clause is required if the stored procedure will be returning result sets.

Defining the stored procedure:

```
PROCEDURE prod.reset

CREATE PROCEDURE prod.reset () LANGUAGE SQL
  DYNAMIC RESULT SETS 1
BEGIN
  DECLARE C1 CURSOR FOR SELECT * FROM QIWS.QCUSTCDT;
  OPEN C1;
  RETURN;
END
```

ODBC application

Note: Some of the logic has been removed.

Note: By using the code examples, you agree to the terms of the [“Code license and disclaimer information”](#) on page 396.

```
:
strcpy(stmt,"call prod.reset()");
rc = SQLExecDirect(hstmt,stmt,SQL_NTS);
if (rc == SQL_SUCCESS)
{
  // CALL statement has executed successfully. Process the result set.
  // Get number of result columns for the result set.
  rc = SQLNumResultCols(hstmt, &wNum);
  if (rc == SQL_SUCCESS)
  // Get description of result columns in result set
  { rc = SQLDescribeCol(hstmt,à);
    if (rc == SQL_SUCCESS)
      :
  }
  // Bind result columns based on attributes returned
  //
  rc = SQLBindCol(hstmt,à);
  :
  // FETCH records until EOF is returned
  rc = SQLFetch(hstmt);
```



```

while (rc == SQL_SUCCESS)
  { // process result returned on the SQLFetch
    :
    rc = SQLFetch(hstmt);
  }
:
}
// Close the result set cursor when done with it.
rc = SQLFreeStmt(hstmt,SQL_CLOSE);
:

```

Example 2: Calling a stored procedure that returns a result set from a nested procedure

This example shows how a nested stored procedure can open and return a result set to the outermost procedure.

To return a result set to the outermost procedure in an environment where there are nested stored procedures, the RETURN TO CLIENT returnability attribute should be used on the DECLARE CURSOR statement or on the SET RESULT SETS statement to indicate that the cursors are to be returned to the application which called the outermost procedure. Note that this nested procedure returns two result sets to the client; the first, an array result set, and the second a cursor result set. Both an ODBC and a JDBC client application are shown below along with the stored procedures.

Defining the stored procedures

```

CREATE PROCEDURE prod.rtnnested () LANGUAGE CL DYNAMIC RESULT SET 2
EXTERNAL NAME prod.rtnnested GENERAL

```

```

CREATE PROCEDURE prod.rtnclient () LANGUAGE RPGLE
EXTERNAL NAME prod.rtnclient GENERAL

```

Note: By using the code examples, you agree to the terms of the [“Code license and disclaimer information”](#) on page 396.

CL source for stored procedure prod.rtnnested

```

PGM
CALL PGM(PROD/RTNCLIENT)

```

ILE RPG source for stored procedure prod.rtnclient

```

DRESULT          DS          OCCURS(20)
D COL1           1          16A
C   1            DO          10          X          2 0
C   X            OCCUR      RESULT
C               EVAL       COL1='array result set'
C               ENDDO
C               EVAL       X=X-1
C/EXEC SQL DECLARE C2 CURSOR WITH RETURN TO CLIENT
C+ FOR SELECT LSTNAM FROM QIWS.QCUSTCDT FOR FETCH ONLY
C/END-EXEC
C/EXEC SQL
C+ OPEN C2
C/END-EXEC
C/EXEC SQL
C+ SET RESULT SETS FOR RETURN TO CLIENT ARRAY :RESULT FOR :X ROWS,
C+ CURSOR C2
C/END-EXEC
C               SETON
C               RETURN
LR

```

ODBC application

```
//*****  
//  
// Module:  
//   Examples.C  
//  
// Purpose:  
//   Perform calls to stored procedures to get back result sets.  
  
//  
// *****  
  
#include "common.h"  
#include "stdio.h"  
  
// *****  
//  
// Local function prototypes.  
//  
// *****  
  
SWORD   FAR PASCAL RetClient(lpSERVERINFO lpSI);  
BOOL    FAR PASCAL Bind_Params(HSTMT);  
BOOL    FAR PASCAL Bind_First_RS(HSTMT);  
BOOL    FAR PASCAL Bind_Second_RS(HSTMT);  
  
// *****  
//  
// Constant strings definitions for SQL statements used in  
// the auto test.  
//  
// *****  
//  
// Declarations of variables global to the auto test.  
//  
// *****  
#define ARRAYCOL_LEN 16  
#define LSTNAM_LEN 8  
char  stmt[2048];  
char  buf[2000];  
  
UDWORD rowcnt;  
char  arraycol[ARRAYCOL_LEN+1];  
char  lstnam[LSTNAM_LEN+1];  
SDWORD cbcol1,cbcol2;  
  
lpSERVERINFO lpSI; /* Pointer to a SERVERINFO structure. */  
  
// *****  
//  
// Define the auto test name and the number of test cases  
// for the current auto test. These informations will  
// be returned by AutoTestName().  
//  
// *****  
  
LPSTR szAutoTestName = CREATE_NAME("Result Sets Examples");  
UINT  iNumOfTestCases = 1;  
  
// *****  
//  
// Define the structure for test case names, descriptions,  
// and function names for the current auto test.  
// Test case names and descriptions will be returned by  
// AutoTestDesc(). Functions will be run by  
// AutoTestFunc() if the bits for the corresponding test cases  
// are set in the rglMask member of the SERVERINFO  
// structure.  
//  
// *****  
struct TestCase TestCasesInfo[] =  
{  
    "Return to Client",  
    "2 result sets  ",  
    RetClient
```

```

};

// *****
//
// Sample return to Client:
// Return to Client result sets. Call a CL program which in turn
// calls an RPG program which returns 2 result sets. The first
// result set is an array result set and the second is a cursor
// result set.
//
// *****
SWORD FAR PASCAL RetClient(lpSERVERINFO lpSI)
{
    SWORD      src = SUCCESS;
    RETCODE    returncode;
    HENV       henv;
    HDBC       hdbc;
    HSTMT      hstmt;

    if (FullConnect(lpSI, &henv, &hdbc, &hstmt) == FALSE)
    {
        src = FAIL;
        goto ExitNoDisconnect;
    }
    // *****
    // Call CL program PROD.RTNNESTED, which in turn calls RPG
    // program RTNCLIENT.
    // *****
    strcpy(stmt, "CALL PROD.RTNNESTED()");
    // *****
    // Call the CL program prod.rtnnested. This program will in turn
    // call the RPG program proc.rtnclient, which will open 2 result
    // sets for return to this ODBC application.
    // *****
    returncode = SQLExecDirect(hstmt, stmt, SQL_NTS);
    if (returncode != SQL_SUCCESS)
    {
        vWrite(lpSI, "CALL PROD.RTNNESTED is not Successful", TRUE);
    }
    else
    {
        vWrite(lpSI, "CALL PROC.RTNNESTED was Successful", TRUE);
    }
    // *****
    // Bind the array result set output column. Note that the result
    // sets are returned to the application in the order that they
    // are specified on the SET RESULT SETS statement.
    // *****
    if (Bind_First_RS(hstmt) == FALSE)
    {
        myRETCheck(lpSI, henv, hdbc, hstmt, SQL_SUCCESS,
            returncode, "Bind_First_RS");
        src = FAIL;
        goto ErrorRet;
    }
    else
    {
        vWrite(lpSI, "Bind_First_RS Complete...", TRUE);
    }
    // *****
    // Fetch the rows from the array result set. After the last row
    // is read, a returncode of SQL_NO_DATA_FOUND will be returned to
    // the application on the SQLFetch request.
    // *****
    returncode = SQLFetch(hstmt);
    while(returncode == SQL_SUCCESS)
    {
        wsprintf(stmt, "array column = %s", arraycol);
        vWrite(lpSI, stmt, TRUE);
        returncode = SQLFetch(hstmt);
    }
    if (returncode == SQL_NO_DATA_FOUND) ;
    else {
        myRETCheck(lpSI, henv, hdbc, hstmt, SQL_SUCCESS_WITH_INFO,
            returncode, "SQLFetch");
        src = FAIL;
        goto ErrorRet;
    }
}

```

```

    }
// *****
// Get any remaining result sets from the call. The next
// result set corresponds to cursor C2 opened in the RPG
// Program.
// *****
returncode = SQLMoreResults(hstmt);
if (returncode != SQL_SUCCESS)
{
    myRETCHCK(lpSI, henv, hdbc, hstmt, SQL_SUCCESS, returncode, "SQLMoreResults");
    sRC = FAIL;
    goto ErrorRet;
}
// *****
// Bind the cursor result set output column. Note that the result
// sets are returned to the application in the order that they
// are specified on the SET RESULT SETS statement.
// *****

if (Bind_Second_RS(hstmt) == FALSE)
{
    myRETCHCK(lpSI, henv, hdbc, hstmt, SQL_SUCCESS,
              returncode, "Bind_Second_RS");
    sRC = FAIL;
    goto ErrorRet;
}
else
{
    vWrite(lpSI, "Bind_Second_RS Complete...", TRUE);
}
// *****
// Fetch the rows from the cursor result set. After the last row
// is read, a returncode of SQL_NO_DATA_FOUND will be returned to
// the application on the SQLFetch request.
// *****
returncode = SQLFetch(hstmt);
while(returncode == SQL_SUCCESS)
{
    wsprintf(stmt, "lstmt = %s", lstmt);
    vWrite(lpSI, stmt, TRUE);
    returncode = SQLFetch(hstmt);
}
if (returncode == SQL_NO_DATA_FOUND) ;
else {
    myRETCHCK(lpSI, henv, hdbc, hstmt, SQL_SUCCESS_WITH_INFO,
              returncode, "SQLFetch");
    sRC = FAIL;
    goto ErrorRet;
}

returncode = SQLFreeStmt(hstmt, SQL_CLOSE);
if (returncode != SQL_SUCCESS)
{
    myRETCHCK(lpSI, henv, hdbc, hstmt, SQL_SUCCESS,
              returncode, "Close statement");
    sRC = FAIL;
    goto ErrorRet;
}
else
{
    vWrite(lpSI, "Close statement...", TRUE);
}

ErrorRet:
FullDisconnect(lpSI, henv, hdbc, hstmt);
if (sRC == FAIL)
{
    // a failure in an ODBC function that prevents completion of the
    // test - for example, connect to the server
    vWrite(lpSI, "\t\t *** Unrecoverable RTNClient Test FAILURE ***", TRUE);
} /* endif */

ExitNoDisconnect:
    return(sRC);
} // RetClient

```

```

BOOL FAR PASCAL Bind_First_RS(HSTMT hstmt)
{
    RETCODE rc = SQL_SUCCESS;
    rc = SQLBindCol(hstmt,1,SQL_C_CHAR,arraycol,ARRAYCOL_LEN+1, &cbcol1);
    if (rc != SQL_SUCCESS) return FALSE;
    return TRUE;
}
BOOL FAR PASCAL Bind_Second_RS(HSTMT hstmt)
{
    RETCODE rc = SQL_SUCCESS;
    rc = SQLBindCol(hstmt,1,SQL_C_CHAR,lstnam,LSTNAM_LEN+1,&dbcol2);
    if (rc != SQL_SUCCESS) return FALSE;
    return TRUE;
}

```

JDBC application

```

//-----
// Call Nested procedures which return result sets to the
// client, in this case a JDBC client.
//-----
import java.sql.*;
public class callNested
{
    public static void main (String argv[])           // Main entry point
    {
        try {
            Class.forName("com.ibm.db2.jdbc.app.DB2Driver");
        }
        catch (ClassNotFoundException e) {
            e.printStackTrace();
        }

        try {
            Connection jdbcCon =
DriverManager.getConnection("jdbc:db2:lp066ab","userid","xxxxxxx");
            jdbcCon.setAutoCommit(false);
            CallableStatement cs = jdbcCon.prepareCall("CALL PROD.RTNNESTED");
            cs.execute();
            ResultSet rs1 = cs.getResultSet();
            int r = 0;
            while (rs1.next())
            {
                r++;
                String s1 = rs1.getString(1);
                System.out.print("Result set 1 Row: " + r + ": ");
                System.out.print(s1 + " ");
                System.out.println();
            }
            cs.getMoreResults();
            r = 0;
            ResultSet rs2 = cs.getResultSet();
            while (rs2.next())
            {
                r++;
                String s2 = rs2.getString(1);
                System.out.print("Result set 2 Row: " + r + ": ");
                System.out.print(s2 + " ");
                System.out.println();
            }
        }
        catch ( SQLException e ) {
            System.out.println( "SQLState: " + e.getSQLState() );
            System.out.println( "Message : " + e.getMessage() );
            e.printStackTrace();
        }
    } // main
}

```

Writing a program or SQL procedure to receive the result sets from a stored procedure

You can write a program to receive results sets from a stored procedure for either a fixed number of result sets, for which you know the contents, or a variable number of result sets, for which you do not know the contents.

Returning a known number of result sets is simpler to write, but if you write the code to handle a varying number of result sets you do not need to make major modifications to your program if the stored procedure changes.

The basic steps for receiving result sets are as follows:

1. Declare a locator variable for each result set that will be returned.

If you do not know how many result sets will be returned, declare enough result set locators for the maximum number of result sets that might be returned.

2. Call the stored procedure and check the SQL return code.

If the SQLCODE from the CALL statement is +466, the stored procedure has returned result sets.

3. Determine how many result sets the stored procedure is returning.

If you already know how many result sets the stored procedure returns, you can skip this step.

Use the SQL statement DESCRIBE PROCEDURE to determine the number of result sets. DESCRIBE PROCEDURE places information about the result sets in an SQLDA or SQL descriptor.

For an SQL descriptor, when the DESCRIBE PROCEDURE statement completes, the following values can be retrieved:

- DB2_RESULT_SETS_COUNT contains the number of result sets returned by the stored procedure.
- One descriptor area item is returned for each result set:
 - DB2_CURSOR_NAME contains the name of the cursor used by the stored procedure to return the result set.
 - The DB2_RESULT_SET_ROWS contains the estimated number of rows in the result set. A value of -1 indicates that no estimate of the number of rows in the result set is available.
 - DB2_RESULT_SET_LOCATOR contains the value of the result set locator associated with the result set.

For an SQLDA, make the SQLDA large enough to hold the maximum number of result sets that the stored procedure might return. When the DESCRIBE PROCEDURE statement completes, the fields in the SQLDA contain the following values:

- SQLD contains the number of result sets returned by the stored procedure.
- Each SQLVAR entry gives information about a result set. In an SQLVAR entry:
 - The SQLNAME field contains the name of the cursor used by the stored procedure to return the result set.
 - The SQLIND field contains the estimated number of rows in the result set. A value of -1 indicates that no estimate of the number of rows in the result set is available.
 - The SQLDATA field contains the value of the result set locator, which is the address of the result set.

4. Link result set locators to result sets.

You can use the SQL statement ASSOCIATE LOCATORS to link result set locators to result sets. The ASSOCIATE LOCATORS statement assigns values to the result set locator variables. If you specify more locators than the number of result sets returned, the extra locators will be ignored.

If you executed the DESCRIBE PROCEDURE statement previously, the result set locator values can be retrieved from the DB2_RESULT_SET_LOCATOR in the SQL descriptor or from the SQLDATA fields of

the SQLDA. You can copy the values from these fields to the result set locator variables manually, or you can execute the ASSOCIATE LOCATORS statement to do it for you.

The stored procedure name that you specify in an ASSOCIATE LOCATORS or DESCRIBE PROCEDURE statement must be a procedure name that has already been used in the CALL statement that returns the result sets.

5. Allocate cursors for fetching rows from the result sets.

Use the SQL statement ALLOCATE CURSOR to link each result set with a cursor. Execute one ALLOCATE CURSOR statement for each result set. The cursor names can be different from the cursor names in the stored procedure.

6. Determine the contents of the result sets.

If you already know the format of the result set, you can skip this step.

Use the SQL statement DESCRIBE CURSOR to determine the format of a result set and put this information in an SQL descriptor or an SQLDA. For each result set, you need an SQLDA big enough to hold descriptions of all columns in the result set.

You can use DESCRIBE CURSOR only for cursors for which you executed ALLOCATE CURSOR previously.

After you execute DESCRIBE CURSOR, if the cursor for the result set is declared WITH HOLD, for an SQL descriptor DB2_CURSOR_HOLD can be checked. For an SQLDA the high-order bit of the eighth byte of field SQLDAID in the SQLDA is set to 1.

7. Fetch rows from the result sets into host variables by using the cursors that you allocated with the ALLOCATE CURSOR statements.

If you executed the DESCRIBE CURSOR statement, perform these steps before you fetch the rows:

- a) Allocate storage for host variables and indicator variables. Use the contents of the SQL descriptor or SQLDA from the DESCRIBE CURSOR statement to determine how much storage you need for each host variable.
- b) Put the address of the storage for each host variable in the appropriate SQLDATA field of the SQLDA.
- c) Put the address of the storage for each indicator variable in the appropriate SQLIND field of the SQLDA.

Fetching rows from a result set is the same as fetching rows from a table.

The following examples show C language code that accomplishes each of these steps. Coding for other languages is similar.

The following example demonstrates how you receive result sets when you know how many result sets are returned and what is in each result set.

```
/* *****  
/* Declare result set locators. For this example, */  
/* assume you know that two result sets will be returned. */  
/* Also, assume that you know the format of each result set. */  
/* *****  
EXEC SQL BEGIN DECLARE SECTION;  
static volatile SQL TYPE IS RESULT_SET_LOCATOR loc1, loc2;  
EXEC SQL END DECLARE SECTION;  
.  
.  
.  
/* *****  
/* Call stored procedure P1. */  
/* Check for SQLCODE +466, which indicates that result sets */  
/* were returned. */  
/* *****  
EXEC SQL CALL P1(:parm1, :parm2, ...);  
if(SQLCODE==+466)  
{  
/* *****  
/* Establish a link between each result set and its */  
/* locator using the ASSOCIATE LOCATORS. */
```

```

/*****
EXEC SQL ASSOCIATE LOCATORS (:loc1, :loc2) WITH PROCEDURE P1;
.
.
/*****
/* Associate a cursor with each result set. */
/*****
EXEC SQL ALLOCATE C1 CURSOR FOR RESULT SET :loc1;
EXEC SQL ALLOCATE C2 CURSOR FOR RESULT SET :loc2;
/*****
/* Fetch the result set rows into host variables. */
/*****
while(SQLCODE==0)
{
EXEC SQL FETCH C1 INTO :order_no, :cust_no;
.
.
}
while(SQLCODE==0)
{
EXEC SQL FETCH C2 :order_no, :item_no, :quantity;
.
.
}
}

```

The following example demonstrates how you receive result sets when you do not know how many result sets are returned or what is in each result set.

```

/*****
/* Declare result set locators. For this example, */
/* assume that no more than three result sets will be */
/* returned, so declare three locators. Also, assume */
/* that you do not know the format of the result sets. */
/*****
EXEC SQL BEGIN DECLARE SECTION;
static volatile SQL TYPE IS RESULT_SET_LOCATOR loc1, loc2, loc3;
EXEC SQL END DECLARE SECTION;
.
.
/*****
/* Call stored procedure P2. */
/* Check for SQLCODE +466, which indicates that result sets */
/* were returned. */
/*****
EXEC SQL CALL P2(:parm1, :parm2, ..);
if(SQLCODE==+466)
{
/*****
/* Determine how many result sets P2 returned, using the */
/* statement DESCRIBE PROCEDURE. :proc_da is an SQLDA */
/* with enough storage to accommodate up to three SQLVAR */
/* entries. */
/*****
EXEC SQL DESCRIBE PROCEDURE P2 INTO :proc_da;
.
.
/*****
/* Now that you know how many result sets were returned, */
/* establish a link between each result set and its */
/* locator using the ASSOCIATE LOCATORS. For this example, */
/* we assume that three result sets are returned. */
/*****
EXEC SQL ASSOCIATE LOCATORS (:loc1, :loc2, :loc3) WITH PROCEDURE P2;
.
.
/*****
/* Associate a cursor with each result set. */
/*****
EXEC SQL ALLOCATE C1 CURSOR FOR RESULT SET :loc1;
EXEC SQL ALLOCATE C2 CURSOR FOR RESULT SET :loc2;
EXEC SQL ALLOCATE C3 CURSOR FOR RESULT SET :loc3;
/*****

```



```

/* Use the statement DESCRIBE CURSOR to determine the      */
/* format of each result set.                             */
/*****
EXEC SQL DESCRIBE CURSOR C1 INTO :res_da1;
EXEC SQL DESCRIBE CURSOR C2 INTO :res_da2;
EXEC SQL DESCRIBE CURSOR C3 INTO :res_da3;
.
.
.
/*****
/* Assign values to the SQLDATA and SQLIND fields of the  */
/* SQLDAs that you used in the DESCRIBE CURSOR statements.*/
/* These values are the addresses of the host variables and*/
/* indicator variables into which DB2 will put result set  */
/* rows.                                                    */
/*****
.
.
.
/*****
/* Fetch the result set rows into the storage areas       */
/* that the SQLDAs point to.                              */
/*****
while(SQLCODE==0)
{
    EXEC SQL FETCH C1 USING :res_da1;
    .
    .
    .
}
while(SQLCODE==0)
{
    EXEC SQL FETCH C2 USING :res_da2;
    .
    .
    .
}
while(SQLCODE==0)
{
    EXEC SQL FETCH C3 USING :res_da3;
    .
    .
    .
}
}

```

The following example demonstrates how you receive result sets using an SQL descriptor.

This is the SQL procedure that will be called:

```

create procedure owntbl()
dynamic result sets 1
begin
    declare c1 cursor for
        select name, dbname from qsys2.systables
        where creator = system_user ;
    open c1 ;
    return ;
end

```

This is the program that will process the result sets:

```

#include <string.h>
#include <stdio.h>
#include <stdlib.h>

EXEC SQL INCLUDE SQLCA;
/*****
/* Declare result set locators. For this example,        */
/* you know that only one result set will be returned,   */
/* so only one locator is declared.                      */
/*****
EXEC SQL BEGIN DECLARE SECTION;
static volatile SQL TYPE IS RESULT_SET_LOCATOR loc1;
struct {
    short len;
    char data[128];
} tblName; /* table name */

```

```

struct {
    short len;
    char data[128];
} schName; /* schema name */
EXEC SQL END DECLARE SECTION;

void main(int argc, char* argv[])
{
    /******
    /* Call the procedure that might return a result set. Check */
    /* the returned SQLCODE to see if result sets were returned. */
    /******
    int noMoreData = 0;
    EXEC SQL WHENEVER SQLERROR GOTO error;
    EXEC SQL CALL OWNTBL ;
    if (SQLCODE != 466) {
        goto error;
    }
    /******
    /* Since you know only one result set can be returned from */
    /* this procedure, associate a locator with the result set */
    /* and define a cursor to be used with it. */
    /******
    EXEC SQL ASSOCIATE LOCATORS (:loc1) WITH PROCEDUREOWNTBL ;
    EXEC SQL ALLOCATE C1 CURSOR FOR RESULT SET :loc1 ;
    /******
    /* Define the descriptor to use for fetching data from the */
    /* cursor. */
    /******
    EXEC SQL ALLOCATE DESCRIPTOR 'desc' WITH MAX 10 ;
    EXEC SQL DESCRIBE CURSOR C1 USING SQL DESCRIPTOR 'desc' ;
    EXEC SQL WHENEVER NOT FOUND GOTO enddata;
    while ( noMoreData == 0 ) {
        EXEC SQL FETCH C1 INTO SQL DESCRIPTOR 'desc' ;
        memset(tblName.data,0x00,sizeof(tblName.data));
        memset(schName.data,0x00,sizeof(schName.data));
        EXEC SQL GET DESCRIPTOR 'desc' VALUE 1 :tblName = DATA;
        EXEC SQL GET DESCRIPTOR 'desc' VALUE 2 :schName = DATA;
        printf("Table: %s Schema: %s \n",
            tblName.data,schName.data);
    }

enddata:
    printf("All rows fetched.\n");
    return;

error:
    printf("Unexpected error, SQLCODE = %d \n", SQLCODE);
    return;
}

```

The following example demonstrates how you can use an SQL procedure to receive result sets. It is just a fragment of a larger SQL procedure.

```

DECLARE RESULT1 RESULT_SET_LOCATOR VARYING;
DECLARE RESULT2 RESULT_SET_LOCATOR VARYING;
.
.
.
CALL TARGETPROCEDURE();

ASSOCIATE RESULT SET LOCATORS(RESULT1,RESULT2)
WITH PROCEDURE TARGETPROCEDURE;
ALLOCATE RSCUR1 CURSOR FOR RESULT1;
ALLOCATE RSCUR2 CURSOR FOR RESULT2;

WHILE AT_END = 0 DO
    FETCH RSCUR1 INTO VAR1;
    SET TOTAL1 = TOTAL1 + VAR1;
END WHILE;

WHILE AT_END = 0 DO
    FETCH RSCUR2 INTO VAR2;
    SET TOTAL2 = TOTAL2 + VAR2;
END WHILE;
.
.
.

```

Parameter passing conventions for stored procedures and user-defined functions

The CALL statement and a function call can pass arguments to programs written in all supported host languages and REXX procedures.

Each language supports different data types that are tailored to it, as shown in the following tables. The SQL data type is contained in the leftmost column of each table. Other columns in that row contain an indication of whether that data type is supported as a parameter type for a particular language. If the column is blank, the data type is not supported as a parameter type for that language. A host variable declaration indicates that Db2 for i supports this data type as a parameter in this language. The declaration indicates how host variables must be declared to be received and set properly by the procedure or function. When an SQL procedure or function is called, all SQL data types are supported so no column is provided in the table.

SQL data type	C and C++	CL	COBOL and ILE COBOL
SMALLINT	short		PIC S9(4) BINARY
INTEGER	long		PIC S9(9) BINARY
BIGINT	long long		PIC S9(18) BINARY Note: Only supported for ILE COBOL.
DECIMAL(p,s)	decimal(p,s)	TYPE(*DEC) LEN(p s)	PIC S9(p-s)V9(s) PACKED-DECIMAL Note: Precision must not be greater than 18.
NUMERIC(p,s)			PIC S9(p-s)V9(s) DISPLAY SIGN LEADING SEPARATE Note: Precision must not be greater than 18.
DECFLOAT	_Decimal32, _Decimal64, _Decimal128 Note: Only supported for C.		
REAL or FLOAT(p)	float		COMP-1 Note: Only supported for ILE COBOL.
DOUBLE PRECISION or FLOAT or FLOAT(p)	double		COMP-2 Note: Only supported for ILE COBOL.
CHARACTER(n)	char ... [n+1]	TYPE(*CHAR) LEN(n)	PIC X(n)
VARCHAR(n)	char ... [n+1]		Varying-Length Character String
VARCHAR(n) FOR BIT DATA	VARCHAR structured form		Varying-Length Character String

<i>Table 50. Data types of parameters (continued)</i>			
SQL data type	C and C++	CL	COBOL and ILE COBOL
CLOB	CLOB structured form		CLOB structured form Note: Only supported for ILE COBOL.
GRAPHIC(n)	wchar_t ... [n+1]		PIC G(n) DISPLAY-1 or PIC N(n) Note: Only supported for ILE COBOL.
VARGRAPHIC(n)	VARGRAPHIC structured form		Varying-Length Graphic String Note: Only supported for ILE COBOL.
DBCLOB	DBCLOB structured form		DBCLOB structured form Note: Only supported for ILE COBOL.
BINARY	BINARY structured form		BINARY structured form
VARBINARY	VARBINARY structured form		VARBINARY structured form
BLOB	BLOB structured form		BLOB structured form Note: Only supported for ILE COBOL.
DATE	char ... [11]	TYPE(*CHAR) LEN(10)	PIC X(10) Note: For ILE COBOL only, FORMAT DATE.
XML	XML structured form		XML structured form
TIME	char ... [9]	TYPE(*CHAR) LEN(8)	PIC X(8) Note: For ILE COBOL only, FORMAT TIME.
TIMESTAMP(n)	char ... [20] when n = 0 char ... [n+21] when n > 0	TYPE(*CHAR) LEN(19) when n = 0 TYPE(*CHAR) LEN(n+20) when n > 0	PIC X(19) when n = 0 PIC X(n+20) when n > 0 Note: For ILE COBOL only, FORMAT TIMESTAMP.
ROWID	ROWID structured form		ROWID structured form
DataLink			
Array			
Indicator variable	short		PIC S9(4) BINARY

Table 51. Data types of parameters

SQL data type	Java™ parameter style JAVA	Java parameter style DB2GENERAL	PL/I
SMALLINT	short	short	FIXED BIN(15)
INTEGER	int	int	FIXED BIN(31)
BIGINT	long	long	
DECIMAL(p,s)	BigDecimal	BigDecimal	FIXED DEC(p,s)
NUMERIC(p,s)	BigDecimal	BigDecimal	
DECFLOAT	BigDecimal	BigDecimal	
REAL or FLOAT(p)	float	float	FLOAT BIN(p)
DOUBLE PRECISION or FLOAT or FLOAT(p)	double	double	FLOAT BIN(p)
CHARACTER(n)	String	String	CHAR(n)
VARCHAR(n)	String	String	CHAR(n) VAR
VARCHAR(n) FOR BIT DATA	byte[]	com.ibm.db2.app.Blob	CHAR(n) VAR
CLOB	java.sql.Clob	com.ibm.db2.app.Clob	CLOB structured form
GRAPHIC(n)	String	String	
VARGRAPHIC(n)	String	String	
DBCLOB	java.sql.Clob	com.ibm.db2.app.Clob	DBCLOB structured form
BINARY	byte[]	com.ibm.db2.app.Blob	BINARY structured form
VARBINARY	byte[]	com.ibm.db2.app.Blob	VARBINARY structured form
BLOB	java.sql.Blob	com.ibm.db2.app.Blob	BLOB structured form
XML AS CLOB	java.sql.CLOB		
XML AS BLOB	java.sql.BLOB		
DATE	Date	String	CHAR(10)
TIME	Time	String	CHAR(8)
TIMESTAMP(n)	Timestamp	String	CHAR(19) when n = 0 CHAR(n+20) when n > 0
ROWID	byte[]	com.ibm.db2.app.Blob	ROWID structured form
DataLink			
Array	java.sql.Array		
Indicator variable			FIXED BIN(15)

Table 52. Data types of parameters

SQL data type	REXX	RPG	ILE RPG
SMALLINT		Data structure that contains a single sub-field. B in position 43, length must be 2, and 0 in position 52 of the sub-field specification.	Data specification. B in position 40, length must be <= 4, and 00 in positions 41-42 of the sub-field specification. or Data specification. I in position 40, length must be 5, and 00 in positions 41-42 of the sub-field specification.
INTEGER	Numeric string with no decimal (and an optional leading sign)	Data structure that contains a single sub-field. B in position 43, length must be 4, and 0 in position 52 of the sub-field specification.	Data specification. B in position 40, length must be <=09 and >=05, and 00 in positions 41-42 of the sub-field specification. or Data specification. I in position 40, length must be 10, and 00 in positions 41-42 of the sub-field specification.
BIGINT			Data specification. I in position 40, length must be 20, and 00 in positions 41-42 of the sub-field specification.
DECIMAL(p,s)	Numeric string with a decimal (and an optional leading sign)	Data structure that contains a single sub-field. P in position 43 and 0 through 9 in position 52 of the sub-field specification. or A numeric input field or calculation result field.	Data specification. P in position 40 and 00 through 31 in positions 41-42 of the sub-field specification.
NUMERIC(p,s)		Data structure that contains a single sub-field. Blank in position 43 and 0 through 9 in position 52 of the sub-field specification.	Data specification. S in position 40, or Blank in position 40 and 00 through 31 in position 41-42 of the sub-field specification.
DECFLOAT			
REAL or FLOAT(p)	String with digits, then an E, (then an optional sign), then digits		Data specification. F in position 40, length must be 4.
DOUBLE PRECISION or FLOAT or FLOAT(p)	String with digits, then an E, (then an optional sign), then digits		Data specification. F in position 40, length must be 8.

Table 52. Data types of parameters (continued)

SQL data type	REXX	RPG	ILE RPG
CHARACTER(n)	String with n characters within two apostrophes	Data structure field without sub-fields or data structure that contains a single sub-field. Blank in position 43 and 52 of the sub-field specification. or A character input field or calculation result field.	Data specification. A in position 40, or Blank in position 40 and 41-42 of the sub-field specification.
VARCHAR(n)	String with n characters within two apostrophes		Data specification. A in position 40, or Blank in position 40 and 41-42 of the sub-field specification and the keyword VARYING in positions 44-80.
VARCHAR(n) FOR BIT DATA	String with n characters within two apostrophes		Data specification. A in position 40, or Blank in position 40 and 41-42 of the sub-field specification and the keyword VARYING in positions 44-80.
CLOB			CLOB structured form
GRAPHIC(n)	String starting with G', then n double-byte characters, then '		Data specification. G in position 40 of the sub-field specification.
VARGRAPHIC(n)	String starting with G', then n double-byte characters, then '		Data specification. G in position 40 of the sub-field specification and the keyword VARYING in positions 44-80.
DBCLOB			DBCLOB structured form
BINARY			BINARY structured form
VARBINARY			VARBINARY structured form
BLOB			BLOB structured form
XML			XML structured form
DATE	String with 10 characters within two apostrophes	Data structure field without sub-fields or data structure that contains a single sub-field. Blank in position 43 and 52 of the sub-field specification. Length is 10. or A character input field or calculation result field.	Data specification. D in position 40 of the sub-field specification. DATFMT(*ISO) in position 44-80.
TIME	String with 8 characters within two apostrophes	Data structure field without sub-fields or data structure that contains a single sub-field. Blank in position 43 and 52 of the sub-field specification. Length is 8. or A character input field or calculation result field.	Data specification. T in position 40 of the sub-field specification. TIMFMT(*ISO) in position 44-80.

Table 52. Data types of parameters (continued)			
SQL data type	REXX	RPG	ILE RPG
TIMESTAMP(n)	String with 26 characters within two apostrophes	Data structure field without sub-fields or data structure that contains a single sub-field. Blank in position 43 and 52 of the sub-field specification. Length is 19 for n = 0. Length is n+20 for n > 0.	Timestamp data type with length 19 for n = 0, length n+20 for n > 0.
ROWID			ROWID structured form
DataLink			
Array			
Indicator variable	Numeric string with no decimal (and an optional leading sign).	Data structure that contains a single sub-field. B in position 43, length must be 2, and 0 in position 52 of the sub-field specification.	Data specification. B in position 40, length must be <=4, and 00 in positions 41-42 of the sub-field specification.

Related concepts

[Embedded SQL programming](#)

[Java SQL routines](#)

Indicator variables and stored procedures

Host variables with indicator variables can be used with the CALL statement to pass additional information to and from a procedure.

To indicate that the associated host variable contains the null value, the indicator variable is set to a negative value of -1, -2, -3, -4, or -6. A CALL statement with indicator variables is processed as follows:

- If the indicator variable is negative, a default value is passed for the associated host variable on the CALL statement and the indicator variable is passed unchanged.
- If the indicator variable is not negative, the host variable and the indicator variable are passed unchanged.

When an SQL procedure or an external procedure that was compiled without the *EXTIND option is called, the extended indicator values of -5 and -7 cannot be passed. An error is then issued on the CALL statement. When an external procedure that was compiled with the *EXTIND option is called, the extended indicator values can be passed.

The processing rules are the same for input parameters to the procedure as well as output parameters returned from the procedure. When indicator variables are used, the correct coding method is to check the value of the indicator variable first before using the associated host variable.

The following example illustrates the handling of indicator variables in CALL statements. Notice that the logic checks the value of the indicator variable before using the associated variable. Also note how the indicator variables are passed into procedure PROC1 (as a third argument that consists of an array of 2-byte values).

Note: By using the code examples, you agree to the terms of the [“Code license and disclaimer information”](#) on page 396.

Assume that a procedure is defined as follows. The ILE RPG program was compiled to not allow extended indicators.

```
CREATE PROCEDURE PROC1
  (INOUT DECIMALOUT DECIMAL(7,2), INOUT DECOUT2 DECIMAL(7,2))
  EXTERNAL NAME LIB1.PROC1 LANGUAGE RPGLE
```

GENERAL WITH NULLS)

```

+++++
Program CRPG
+++++
D INOUT1          S          7P 2
D INOUT1IND       S          4B 0
D INOUT2          S          7P 2
D INOUT2IND       S          4B 0
C
C          EVAL      INOUT1 = 1
C          EVAL      INOUT1IND = 0
C          EVAL      INOUT2 = 1
C          EVAL      INOUT2IND = -2
C/EXEC SQL CALL PROC1 (:INOUT1 :INOUT1IND , :INOUT2
C+                :INOUT2IND)
C/END-EXEC
C          EVAL      INOUT1 = 1
C          EVAL      INOUT1IND = 0
C          EVAL      INOUT2 = 1
C          EVAL      INOUT2IND = -2
C/EXEC SQL CALL PROC1 (:INOUT1 :INOUT1IND , :INOUT2
C+                :INOUT2IND)
C/END-EXEC
C      INOUT1IND      IFLT      0
C*      :
C*      HANDLE NULL INDICATOR
C*      :
C      ELSE
C*      :
C*      INOUT1 CONTAINS VALID DATA
C*      :
C      ENDIF
C*      :
C*      HANDLE ALL OTHER PARAMETERS
C*      IN A SIMILAR FASHION
C*      :
C      RETURN
+++++
End of PROGRAM CRPG
+++++

```

```

+++++
Program PROC1
+++++
D INOUTP          S          7P 2
D INOUTP2         S          7P 2
D NULLARRAY       S          4B 0 DIM(2)
C      *ENTRY      PLIST
C          PARM          INOUTP
C          PARM          INOUTP2
C          PARM          NULLARRAY
C      NULLARRAY(1) IFLT      0
C*      :
C*      CODE FOR INOUTP DOES NOT CONTAIN MEANINGFUL DATA
C*      :
C      ELSE
C*      :
C*      CODE FOR INOUTP CONTAINS MEANINGFUL DATA
C*      :
C      ENDIF
C*      PROCESS ALL REMAINING VARIABLES
C*
C*      BEFORE RETURNING, SET OUTPUT VALUE FOR FIRST
C*      PARAMETER AND SET THE INDICATOR TO A NON-NEGATIVE
C*      VALUE SO THAT THE DATA IS RETURNED TO THE CALLING
C*      PROGRAM
C*
C          EVAL      INOUTP2 = 20.5
C          EVAL      NULLARRAY(2) = 0
C*
C*      INDICATE THAT THE SECOND PARAMETER IS TO CONTAIN
C*      THE NULL VALUE UPON RETURN. THERE IS NO POINT
C*      IN SETTING THE VALUE IN INOUTP SINCE IT WON'T BE
C*      PASSED BACK TO THE CALLER.
C          EVAL      NULLARRAY(1) = -1
C      RETURN
+++++

```

Returning a completion status to the calling program

SQL and external procedures return status information to the calling program in different ways.

For SQL procedures, any errors that are not handled in the procedure are returned to the caller in the SQLCA. The SIGNAL and RESIGNAL control statements can be used to send error information as well.

For external procedures, there are two ways to return status information. One method of returning a status to the SQL program issuing the CALL statement is to code an extra INOUT type parameter and set it before returning from the procedure. When the procedure being called is an existing program, this is not always possible.

Another method of returning a status to the SQL program issuing the CALL statement is to send an escape message to the calling program (an operating system program) which calls the external procedure. Each language has methods for signalling conditions and sending messages. Refer to the respective language reference to determine the proper way to signal a message. When the message is signalled, the error is returned as SQLCODE/SQLSTATE -443/38501.

Related reference

[SQL control statements](#)

Passing parameters from Db2 to external procedures

Db2 provides storage for all parameters that are passed to a procedure. Therefore, parameters are passed to an external procedure by address.

This is the normal parameter passing method for programs. For service programs, ensure that the parameters are defined correctly in the procedure code.

When defining and using the parameters in the external procedure, care should be taken to ensure that no more storage is referenced for a given parameter than is defined for that parameter. The parameters are all stored in the same space and exceeding a given parameter's storage space can overwrite another parameter's value. This, in turn, can cause the procedure to see invalid input data or cause the value returned to the database to be invalid.

There are several supported parameter styles available to external procedures. For the most part, the styles differ in how many parameters are passed to the external program or service program.

Parameter style SQL

The SQL parameter style conforms to the industry standard SQL.

With parameter style SQL, the parameters are passed into the external program as follows:

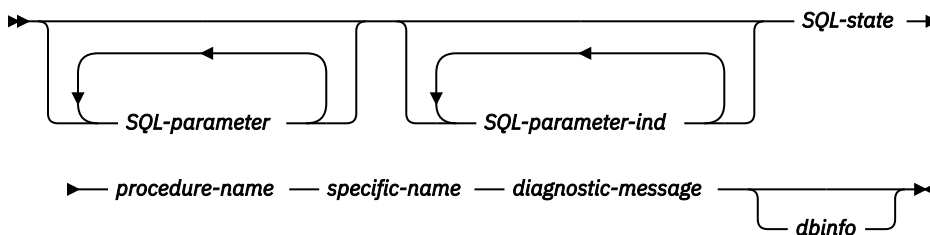

SQL-parameter

This argument is set by Db2 before calling the procedure. This value repeats *n* times, where *n* is the number of parameters specified in the procedure definition. The value of each of these parameters is taken from the expression specified in the CALL statement. It is expressed in the data type of the defined parameter in the CREATE PROCEDURE statement. Note: Changes to any parameters that are defined as INPUT will be ignored by Db2 upon return.

SQL-parameter-ind

This argument is set by Db2 before calling the procedure. It can be used by the procedure to determine if the corresponding *SQL-parameter* is null or not. The *n*th *SQL-parameter-ind* corresponds to the *n*th *SQL-parameter*, described previously. Each indicator is defined as a two-byte signed integer. It is set to one of the following values:

0

The parameter is present and not null.

-1

The parameter is null.

Note: Changes to any indicators that correspond to INPUT parameters are ignored by Db2 upon return.

SQL-state

This argument is a CHAR(5) value that represents the SQLSTATE.

This parameter is passed in from the database set to '00000' and can be set by the procedure as a result state for the procedure. While normally the SQLSTATE is not set by the procedure, it can be used to signal an error or warning to the database as follows:

01Hxx

The procedure code detected a warning situation. This results in an SQL warning. Here *xx* may be one of several possible strings.

38xxx

The procedure code detected an error situation. It results in a SQL error. Here *xxx* may be one of several possible strings.

procedure-name

This argument is set by Db2 before calling the procedure. It is a VARCHAR(139) value that contains the name of the procedure on whose behalf the procedure code is being called.

The form of the procedure name that is passed is:

```
<schema-name>.<procedure-name>
```

This parameter is useful when the procedure code is being used by multiple procedure definitions so that the code can distinguish which definition is being called. Note: This parameter is treated as input only; any changes to the parameter value made by the procedure are ignored by Db2.

specific-name

This argument is set by Db2 before calling the procedure. It is a VARCHAR(128) value that contains the specific name of the procedure on whose behalf the procedure code is being called.

Like *procedure-name*, this parameter is useful when the procedure code is being used by multiple procedure definitions so that the code can distinguish which definition is being called. Note: This parameter is treated as input only; any changes to the parameter value made by the procedure are ignored by Db2.

diagnostic-message

This argument is set by Db2 before calling the procedure. It is a VARCHAR(70) value that can be used by the procedure to send message text back when an SQLSTATE warning or error is signaled by the procedure.

It is initialized by the database on input to the procedure and may be set by the procedure with descriptive information. Message text is ignored by Db2 unless the *SQL-state* parameter is set by the procedure.

dbinfo

This argument is set by Db2 before calling the procedure. It is only present if the CREATE PROCEDURE statement for the procedure specifies the DBINFO keyword. The argument is a structure whose definition is contained in the `sqludf` include.

Parameter style GENERAL

With the GENERAL parameter style, the parameters are passed to an external program just as they are specified in the CREATE PROCEDURE statement.

The format is:

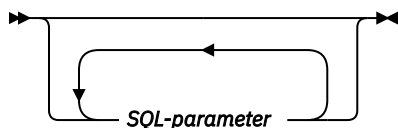

SQL-parameter

This argument is set by Db2 before calling the procedure. This value repeats n times, where n is the number of parameters specified in the procedure call. The value of each of these parameters is taken from the expression specified in the CALL statement. It is expressed in the data type of the defined parameter in the CREATE PROCEDURE statement. Note: Changes to any parameters that are defined as INPUT will be ignored by Db2 upon return.

Parameter style GENERAL WITH NULLS

The GENERAL WITH NULLS parameter style passes both parameter values and null indicator values to an external program.

With this parameter style, the parameters are passed into the program as follows:

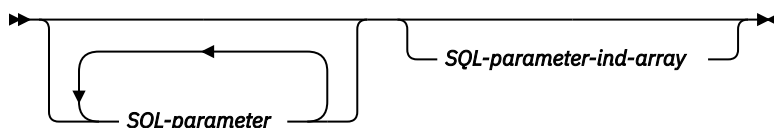

SQL-parameter

This argument is set by Db2 before calling the procedure. This value repeats n times, where n is the number of parameters specified in the procedure call. The value of each of these parameters is taken from the expression specified in the CALL statement. It is expressed in the data type of the defined parameter in the CREATE PROCEDURE statement. Note: Changes to any parameters that are defined as INPUT will be ignored by Db2 upon return.

SQL-parameter-ind-array

This argument is set by Db2 before calling the procedure. It can be used by the procedure to determine if one or more *SQL-parameters* are null or not. It is an array of two-byte signed integers (indicators). The n th array argument corresponds to the n th *SQL-parameter*. Each array entry is set to one of the following values:

0

The parameter is present and not null.

-1

The parameter is null.

The procedure should check for null input. Note: Changes to any indicator array entries that correspond to parameters that are defined as INPUT will be ignored by Db2 upon return.

Parameter style DB2GENERAL

The DB2GENERAL parameter style is used by Java procedures.

Related concepts

[Java SQL routines](#)

Parameter style Java

The Java parameter style is the style specified by the SQLJ Part 1: SQL Routines standard.

Related concepts

[Java SQL routines](#)

Dynamic compound statement

A dynamic compound statement is similar to an SQL procedure except that it does not require a permanent object to be created. For example, a dynamic compound statement can be used to add logic to scripts.

When a dynamic compound statement is executed, it has the overhead of creating, executing, and dropping a program. Because of this overhead, an SQL procedure should be used for situations where the statement needs to be run frequently. There are no input or output parameters for a dynamic compound statement; you can use global variables instead to pass input values and return values.

Suppose you have a script that needs to set up a table that contains constant values. For example, you have a table that has a row for every day of the year (integers 1 through 366).

```
CREATE TABLE day_numbers (day_value INT)
```

If you don't know that the table contains all the correct values, you need to delete all the rows and insert them again. By introducing a compound (dynamic) statement in the script, when the table is already built correctly, it does not need to be repopulated.

```
BEGIN
  DECLARE day_count INT;
  DECLARE unique_day_count INT DEFAULT 0;
  DECLARE insert_cnt INT;

  DECLARE CONTINUE HANDLER FOR SQLSTATE VALUE '42704'
    /* Handle table does not exist error */
    CREATE TABLE day_numbers (day_value INT);

  SELECT COUNT(DISTINCT day_value) , COUNT(day_value)
    INTO unique_day_count, day_count
    FROM day_numbers;

  IF day_count = 366 AND unique_day_count = 366 THEN
    BEGIN END; /* Table correctly populated */
  ELSE
    BEGIN
      DELETE FROM day_numbers; /* Remove all rows */
      SET insert_cnt = 1;
      WHILE insert_cnt < 367 DO
        INSERT INTO day_numbers VALUES insert_cnt;
        SET insert_cnt = insert_cnt + 1;
      END WHILE;
    END;
  END IF;
END
```

Related reference

[compound \(dynamic\) statement](#)

Using user-defined functions

In writing SQL applications, you can implement some actions or operations as a user-defined function (UDF) or as a subroutine in your application. Although it might appear easier to implement new operations as subroutines, you might want to consider the advantages of using a UDF instead.

For example, if the new operation is something that other users or programs can take advantage of, a UDF can help to reuse it. In addition, the function can be called directly in SQL wherever an expression can be used. The database takes care of many data type promotions of the function arguments automatically. For example, with DECIMAL to DOUBLE, the database allows your function to be applied to different, but compatible data types.

In certain cases, calling the UDF directly from the database engine instead of from your application can have a considerable performance advantage. You will notice this advantage in cases where the function may be used in the qualification of data for further processing. These cases occur when the function is used in row selection processing.

Consider a simple scenario where you want to process some data. You can meet some selection criteria which can be expressed as a function `SELECTION_CRITERIA()`. Your application can issue the following select statement:

```
SELECT A, B, C FROM T
```

When it receives each row, it runs the program's `SELECTION_CRITERIA` function against the data to decide if it is interested in processing the data further. Here, every row of table `T` must be passed back to the application. But, if `SELECTION_CRITERIA()` is implemented as a UDF, your application can issue the following statement:

```
SELECT C FROM T WHERE SELECTION_CRITERIA(A,B)=1
```

In this case, only the rows and one column of interest are passed across the interface between the application and the database.

Another case where a UDF can offer a performance benefit is when you deal with large objects (LOBs). Suppose that you have a function that extracts some information from a value of a LOB. You can perform this extraction right on the database server and pass only the extracted value back to the application. This is more efficient than passing the entire LOB value back to the application and then performing the extraction. The performance value of packaging this function as a UDF can be enormous, depending on the particular situation.

Related concepts

User-defined functions

A *user-defined function* is a program that can be called like any built-in functions.

UDF concepts

A *user-defined function* (UDF) is a function that is defined to the Db2 database system through the `CREATE FUNCTION` statement and that can be referenced in SQL statements. A UDF can be an external function or an SQL function.

Types of function

There are several types of functions:

- *Built-in*. These are functions provided by and shipped with the database. `SUBSTR()` is an example.
- *System-generated*. These are functions implicitly generated by the database engine when a `DISTINCT TYPE` is created. These functions provide casting operations between the `DISTINCT TYPE` and its base type.
- *User-defined*. These are functions created by users and registered to the database. Some system provided services such as `QSYS2.DISPLAY_JOURNAL` are considered user-defined functions even though they are defined and maintained by the system.

In addition, each function can be further classified as a *scalar* function, an *aggregate* function, or a *table* function.

A *scalar function* returns a single value answer each time it is called. For example, the built-in function `SUBSTR()` is a scalar function, as are many built-in functions. System-generated functions are always scalar functions. Scalar UDFs can either be external (coded in a programming language such as C), written in SQL, or sourced (using the implementation of an existing function).

An *aggregate function* receives a set of like values (a column of data) and returns a single value answer from this set of values. Some built-in functions are aggregate functions. An example of an aggregate function is the built-in function `AVG()`. An external UDF cannot be defined as an aggregate function. However, a sourced UDF is defined to be an aggregate function if it is sourced on one of the built-in aggregate functions. The latter is useful for distinct types. For example, if a distinct type `SHOESIZE` exists that is defined with base type `INTEGER`, you can define a UDF, `AVG(SHOESIZE)`, as an aggregate function sourced on the existing built-in aggregate function, `AVG(INTEGER)`.

A *table function* returns a table to the SQL statement that references it. It must be referenced in the FROM clause of a SELECT. A table function can be used to apply SQL language processing power to data that is not Db2 data, or to convert such data into a Db2 table. It can, for example, take a file and convert it to a table, sample data from the World Wide Web and tabularize it, or access a Lotus Notes® database and return information about mail messages, such as the date, sender, and the text of the message. This information can be joined with other tables in the database. A table function can be defined as an external function or an SQL function; it cannot be defined as a sourced function.

Full name of a function

The full name of a function using *SQL naming is <schema-name>.<function-name>.

The full name of a function in *SYS naming is <schema-name>/<function-name> or <schema-name>.<function-name>. Function names cannot be qualified using the slash in *SYS naming in DML statements.

You can use this full name anywhere you refer to a function. For example:

```
QGPL.SNOWBLOWER_SIZE    SMITH.FOO    QSYS2.SUBSTR    QSYS2.FLOOR
```

However, you may also omit the <schema-name>., in which case, Db2 must determine the function to which you are referring. For example:

```
SNOWBLOWER_SIZE    FOO    SUBSTR    FLOOR
```

Path

The concept of *path* is central to Db2's resolution of *unqualified* references that occur when schema-name is not specified. The path is an ordered list of schema names that is used for resolving unqualified references to UDFs and UDTs. In cases where a function reference matches a function in more than one schema in the path, the order of the schemas in the path is used to resolve this match. The path is established by means of the SQLPATH option on the precompile commands for static SQL. The path is set by the SET PATH statement for dynamic SQL. When the first SQL statement that runs in an activation group runs with SQL naming, the path has the following default value:

```
"QSYS", "QSYS2", "<ID>"
```

This applies to both static and dynamic SQL, where <ID> represents the current statement authorization ID.

When the first SQL statement in an activation group runs with system naming, the default path is *LIBL.

Overloaded function names

Function names can be *overloaded*. Overloaded means that multiple functions, even in the same schema, can have the same name. Two functions cannot, however, have the same *signature*. A function signature is the qualified function name and the data types of all the function parameters in the order in that they are defined.

Function resolution

It is the *function resolution algorithm* that takes into account the facts of overloading and function path to choose the *best fit* for every function reference, whether it is a qualified or an unqualified reference. All functions, even built-in functions, are processed through the function selection algorithm. The function resolution algorithm does not take into account the type of a function. So a table function may be resolved to as the *best fit* function, even though the usage of the reference requires an scalar function, or vice versa.

Length of time that the UDF runs

UDFs are called from within an SQL statement execution, which is normally a query operation that potentially runs against thousands of rows in a table. Because of this, the UDF needs to be called from a low level of the database.

As a consequence of being called from such a low level, there are certain resources (locks and seizures) being held at the time the UDF is called and for the duration of the UDF execution. These resources are primarily locks on any tables and indexes involved in the SQL statement that is calling the UDF. Due to these held resources, it is important that the UDF not perform operations that may take an extended period of time (minutes or hours). Because of the critical nature of holding resources for long periods of time, the database only waits for a certain period of time for the UDF to finish. If the UDF does not finish in the time allocated, the SQL statement calling the UDF will fail.

The default UDF wait time used by the database should be more than sufficient to allow a normal UDF to run to completion. However, if you have a long running UDF and want to increase the wait time, this can be done using the UDF_TIME_OUT option in the query INI file. Note, however, that there is a maximum time limit that the database will not exceed, regardless of the value specified for UDF_TIME_OUT.

Since resources are held while the UDF is run, it is important that the UDF not operate on the same tables or indexes allocated for the original SQL statement or, if it does, that it does not perform an operation that conflicts with the one being performed in the SQL statement. Specifically, the UDF should not try to perform any insert, update, or delete row operation on those tables.

Related tasks

[Controlling queries dynamically with the query options file QAAQINI](#)

Related reference

[Determining the best fit](#)

Writing UDFs as SQL functions

An *SQL function* is a user-defined function (UDF) that you define, write, and register using the CREATE FUNCTION statement.

An SQL function is written in the SQL procedural language, called SQL PL, and its definition is completely contained within one CREATE FUNCTION statement. The creation of an SQL function causes the registration of the UDF, generates the executable code for the function, and defines to the database the details of how parameters are passed.

Example: SQL scalar UDFs

This example shows a scalar function that returns a priority based on a date.

```
CREATE FUNCTION PRIORITY(indate DATE) RETURNS CHAR(7)
LANGUAGE SQL
BEGIN
RETURN(
CASE WHEN indate>CURRENT DATE-3 DAYS THEN 'HIGH'
      WHEN indate>CURRENT DATE-7 DAYS THEN 'MEDIUM'
      ELSE 'LOW'
END
);
END
```

The function can then be called as:

```
SELECT ORDERNBR, PRIORITY(ORDERDUEDATE) FROM ORDERS
```

Example: SQL table UDFs

These examples show both a non-pipelined table function and a pipelined table function that return data using the same underlying query.

This non-pipelined table function returns data based on a date. The RETURN statement must contain a query.

```
CREATE FUNCTION PROJFUNC(indate DATE)
  RETURNS TABLE (PROJNO CHAR(6), ACTNO SMALLINT, ACSTAFF DECIMAL(5,2),
                 ACSTDATE DATE, ACENDATE DATE)
BEGIN
  RETURN SELECT * FROM PROJACT
         WHERE ACSTDATE<=indate;
END
```

The function can be invoked as:

```
SELECT * FROM TABLE(PROJFUNC(:datehv)) X
```

Non-pipelined SQL table functions are required to have one and only one RETURN statement.

This pipelined table function returns data based on a date. In addition to the column values returned by the query, it also returns an indication of whether the project has been carried over from a prior year.

```
CREATE FUNCTION PROJFUNC(indate DATE)
  RETURNS TABLE (PROJNO CHAR(6), ACTNO SMALLINT, ACSTAFF DECIMAL(5,2),
                 ACSTDATE DATE, ACENDATE DATE, CARRYOVER CHAR(1))
BEGIN
  FOR C1 CURSOR FOR SELECT * FROM PROJACT
    WHERE ACSTDATE<=indate DO
    IF YEAR(ACSTDATE) < YEAR(indate) THEN
      PIPE (PROJNO, ACTNO, ACSTAFF, ACSTDATE, ACENDATE, 'Y');
    ELSE
      PIPE (PROJNO, ACTNO, ACSTAFF, ACSTDATE, ACENDATE, 'N');
    END IF;
  END FOR;
  RETURN;
END
```

The function can be invoked the same way as a non-pipelined function:

```
SELECT * FROM TABLE(PROJFUNC(:datehv)) X
```

Pipelined SQL table functions can contain any number of PIPE statements. Each PIPE statement must return a value for every result column. A RETURN statement must be executed at the end of processing. The body of a pipelined function is not limited to querying tables. It could call another program, get information from an API, query data from some other system, and then combine the results and use one or more PIPE statements to determine what row values to return as the result table.

Writing UDFs as external functions

You can write the executable code of a user-defined function (UDF) in a language other than SQL.

While this method is slightly more cumbersome than an SQL function, it provides the flexibility for you to use whatever language is most effective for you. The executable code can be contained in either a program or service program.

External functions can also be written in Java.

Related concepts

[Java SQL routines](#)

Registering UDFs

A user-defined function (UDF) must be registered in the database before the function can be recognized and used by SQL. You can register a UDF using the CREATE FUNCTION statement.

The statement allows you to specify the language and name of the program, along with options such as DETERMINISTIC, ALLOW PARALLEL, and RETURNS NULL ON NULL INPUT. These options help to more specifically identify to the database the intention of the function and how calls to the database can be optimized.

You should register an external UDF after you have written and completely tested the actual code. It is possible to define the UDF before actually writing it. However, to avoid any problems with running your UDF, you are encouraged to write and test it extensively before registering it.

Related reference

[CREATE FUNCTION](#)

Example: Exponentiation

Suppose that you write an external function to perform exponentiation of floating point values, and you want to register it in the MATH schema.

```
CREATE FUNCTION MATH.EXPON (DOUBLE, DOUBLE)
  RETURNS DOUBLE
  EXTERNAL NAME 'MYLIB/MYPGM(MYENTRY)'
  LANGUAGE C
  PARAMETER STYLE DB2SQL
  NO SQL
  DETERMINISTIC
  NO EXTERNAL ACTION
  RETURNS NULL ON NULL INPUT
  ALLOW PARALLEL
```

In this example, the RETURNS NULL ON NULL INPUT is specified since you want the result to be NULL if either argument is NULL. As there is no reason why EXPON cannot be parallel, the ALLOW PARALLEL value is specified.

Example: String search

Suppose that you write a user-defined function (UDF) to look for a given string, passed as an argument, within a given character large object (CLOB) value that is also passed as an argument. The UDF returns the position of the string within the CLOB if it finds the string, or zero if it does not.

The C program was written to return a FLOAT result. Suppose you know that when it is used in SQL, it should always return an INTEGER. You can create the following function:

```
CREATE FUNCTION FINDSTRING (CLOB(500K), VARCHAR(200))
  RETURNS INTEGER
  CAST FROM FLOAT
  SPECIFIC FINDSTRING
  EXTERNAL NAME 'MYLIB/MYPGM(FINDSTR)'
  LANGUAGE C
  PARAMETER STYLE DB2SQL
  NO SQL
  DETERMINISTIC
  NO EXTERNAL ACTION
  RETURNS NULL ON NULL INPUT
```

Note that a CAST FROM clause is used to specify that the UDF program really returns a FLOAT value, but you want to cast this to INTEGER before returning the value to the SQL statement which used the UDF. Also, you want to provide your own specific name for the function. Because the UDF was not written to handle NULL values, you use the RETURNS NULL ON NULL INPUT.

Example: BLOB string search

Suppose that you want the FINDSTRING function to work on binary large objects (BLOBs) as well as on character large objects (CLOBs). To do this, you define another FINDSTRING function that takes BLOB as the first parameter.

```
CREATE FUNCTION FINDSTRING (BLOB(500K), VARCHAR(200))
RETURNS INTEGER
CAST FROM FLOAT
SPECIFIC FINDSTRING_BLOB
EXTERNAL NAME 'MYLIB/MYPGM(FINDSTR)'
LANGUAGE C
PARAMETER STYLE DB2SQL
NO SQL
DETERMINISTIC
NO EXTERNAL ACTION
RETURNS NULL ON NULL INPUT
```

This example illustrates overloading of the UDF name and shows that multiple UDFs can share the same program. Note that although a BLOB cannot be assigned to a CLOB, the same source code can be used. There is no programming problem in the above example as the interface for BLOB and CLOB between Db2 and the UDF program is the same: length followed by data.

Example: String search over a user-defined type (UDT)

Suppose that you are satisfied with the FINDSTRING function from the binary large object (BLOB) string search, but now you want to define a distinct type BOAT with source type BLOB.

You also want FINDSTRING to operate on values having data type BOAT, so you create another FINDSTRING function. This function is sourced on the FINDSTRING which operates on BLOB values. Note the further overloading of FINDSTRING in this example:

```
CREATE FUNCTION FINDSTRING (BOAT, VARCHAR(200))
RETURNS INT
SPECIFIC "slick_fboat"
SOURCE SPECIFIC FINDSTRING_BLOB
```

Note that this FINDSTRING function has a different signature from the FINDSTRING functions in [“Example: BLOB string search” on page 207](#), so there is no problem overloading the name. Because you are using the SOURCE clause, you cannot use the EXTERNAL NAME clause or any of the related keywords specifying function attributes. These attributes are taken from the source function. Finally, observe that in identifying the source function you are using the specific function name explicitly provided in [“Example: BLOB string search” on page 207](#). Because this is an unqualified reference, the schema in which this source function resides must be in the function path, or the reference will not be resolved.

Example: AVG over a user-defined type (UDT)

This example implements the AVG aggregate function over the CANADIAN_DOLLAR distinct type.

Strong typing prevents you from using the built-in AVG function on a distinct type. It turns out that the source type for CANADIAN_DOLLAR was DECIMAL, and so you implement the AVG by sourcing it on the AVG(DECIMAL) built-in function.

```
CREATE FUNCTION AVG (CANADIAN_DOLLAR)
RETURNS CANADIAN_DOLLAR
SOURCE "QSYS2".AVG(DECIMAL(9,2))
```

Note that in the SOURCE clause you have qualified the function name, just in case there might be some other AVG function lurking in your SQL path.

Example: Counting

Your simple counting function returns a 1 the first time and increments the result by one each time it is called. This function takes no SQL arguments. By definition, it is a NOT DETERMINISTIC function because its answer varies from call to call.

It uses the SCRATCHPAD to save the last value returned. Each time it is called, the function increments this value and returns it.

```
CREATE FUNCTION COUNTER ()  
RETURNS INT  
EXTERNAL NAME 'MYLIB/MYFUNCS(CTR)'  
LANGUAGE C  
PARAMETER STYLE DB2SQL  
NO SQL  
NOT DETERMINISTIC  
NOT FENCED  
SCRATCHPAD 4  
DISALLOW PARALLEL
```

Note that no parameter definitions are provided, just empty parentheses. The above function specifies SCRATCHPAD and uses the default specification of NO FINAL CALL. In this case, the size of the scratchpad is set to only 4 bytes, which is sufficient for a counter. Since the COUNTER function requires that a single scratchpad be used to operate properly, DISALLOW PARALLEL is added to prevent Db2 from operating it in parallel.

Example: Table function returning document IDs

Suppose that you write a table function that returns a row consisting of a single document identifier column for each known document that matches a given subject area (the first parameter) and contains the given string (second parameter).

This user-defined function (UDF) quickly identifies the documents:

```
CREATE FUNCTION DOCMATCH (VARCHAR(30), VARCHAR(255))  
RETURNS TABLE (DOC_ID CHAR(16))  
EXTERNAL NAME 'DOCFUNCS/UDFMATCH(udfmatch)'  
LANGUAGE C  
PARAMETER STYLE DB2SQL  
NO SQL  
DETERMINISTIC  
NO EXTERNAL ACTION  
NOT FENCED  
SCRATCHPAD  
NO FINAL CALL  
DISALLOW PARALLEL  
CARDINALITY 20
```

Within the context of a single session it will always return the same table, and therefore it is defined as DETERMINISTIC. The RETURNS clause defines the output from DOCMATCH, including the column name DOC_ID. FINAL CALL does not need to be specified for this table function. The DISALLOW PARALLEL keyword is required since table functions cannot operate in parallel. Although the size of the output from DOCMATCH can be a large table, CARDINALITY 20 is a representative value, and is specified to help the optimizer make good decisions.

Typically, this table function is used in a join with the table containing the document text, as follows:

```
SELECT T.AUTHOR, T.DOCTEXT  
FROM DOCS AS T, TABLE(DOCMATCH('MATHEMATICS', 'ZORN'S LEMMA')) AS F  
WHERE T.DOCID = F.DOC_ID
```

Note the special syntax (TABLE keyword) for specifying a table function in a FROM clause. In this invocation, the DOCMATCH() table function returns a row containing the single column DOC_ID for each MATHEMATICS document referencing ZORN'S LEMMA. These DOC_ID values are joined to the master document table, retrieving the author's name and document text.

Passing arguments from Db2 to external functions

Db2 provides storage for all parameters that are passed to a user-defined function (UDF). Therefore, parameters are passed to an external function by address.

This is the normal parameter passing method for programs. For service programs, ensure that the parameters are defined correctly in the function code.

When defining and using the parameters in the UDF, care should be taken to ensure that no more storage is referenced for a given parameter than is defined for that parameter. The parameters are all stored in the same space and exceeding a given parameter's storage space can overwrite another parameter's value. This, in turn, can cause the function to see invalid input data or cause the value returned to the database to be invalid.

There are several supported parameter styles available to external UDFs. For the most part, the styles differ in how many parameters are passed to the external program or service program.

Parameter style SQL

The SQL parameter style conforms to the industry standard SQL. This parameter style can be used with scalar or table user-defined functions (UDFs).

With parameter style SQL, the parameters are passed into the external program as follows (in the order specified):

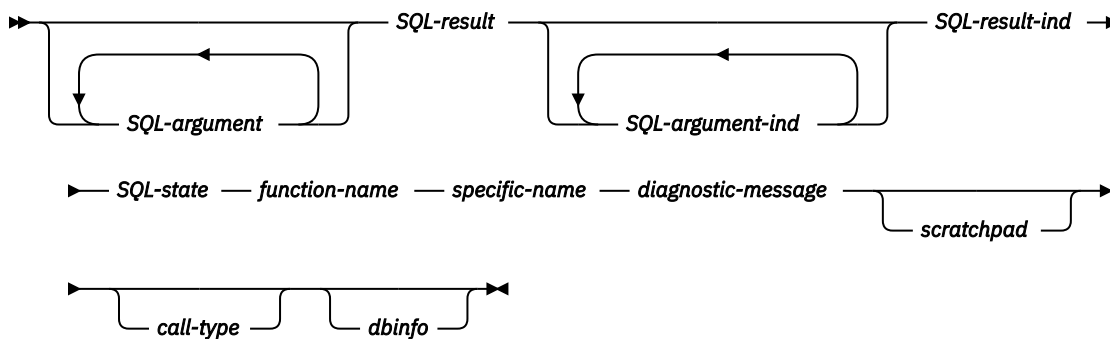

SQL-argument

This argument is set by Db2 before calling the UDF. This value repeats n times, where n is the number of arguments specified in the function reference. The value of each of these arguments is taken from the expression specified in the function invocation. It is expressed in the data type of the defined parameter in the create function statement. Note: These parameters are treated as input only; any changes to the parameter values made by the UDF are ignored by Db2.

SQL-result

This argument is set by the UDF before returning to Db2. The database provides the storage for the return value. Since the parameter is passed by address, the address is of the storage where the return value should be placed. The database provides as much storage as needed for the return value as defined on the CREATE FUNCTION statement. If the CAST FROM clause is used in the CREATE FUNCTION statement, Db2 assumes the UDF returns the value as defined in the CAST FROM clause, otherwise Db2 assumes the UDF returns the value as defined in the RETURNS clause.

SQL-argument-ind

This argument is set by Db2 before calling the UDF. It can be used by the UDF to determine if the corresponding *SQL-argument* is null or not. The n th *SQL-argument-ind* corresponds to the n th *SQL-argument*, described previously. Each indicator is defined as a two-byte signed integer. It is set to one of the following values:

- 0** The argument is present and not null.
- 1** The argument is null.

If the function is defined with RETURNS NULL ON NULL INPUT, the UDF does not need to check for a null value. However, if it is defined with CALLS ON NULL INPUT, any argument can be NULL and the UDF should check for null input. Note: these parameters are treated as input only; any changes to the parameter values made by the UDF are ignored by Db2.

SQL-result-ind

This argument is set by the UDF before returning to Db2. The database provides the storage for the return value. The argument is defined as a two-byte signed integer. If set to a negative value, the database interprets the result of the function as null. If set to zero or a positive value, the database uses the value returned in *SQL-result*. The database provides the storage for the return value indicator. Since the parameter is passed by address, the address is of the storage where the indicator value should be placed.

SQL-state

This argument is a CHAR(5) value that represents the SQLSTATE.

This parameter is passed in from the database set to '00000' and can be set by the function as a result state for the function. While normally the SQLSTATE is not set by the function, it can be used to signal an error or warning to the database as follows:

01Hxx

The function code detected a warning situation. This results in an SQL warning. Here xx may be one of several possible strings.

38xxx

The function code detected an error situation. It results in a SQL error. Here xxx may be one of several possible strings.

function-name

This argument is set by Db2 before calling the UDF. It is a VARCHAR(139) value that contains the name of the function on whose behalf the function code is being called.

The form of the function name that is passed is:

```
<schema-name>.<function-name>
```

This parameter is useful when the function code is being used by multiple UDF definitions so that the code can distinguish which definition is being called. Note: This parameter is treated as input only; any changes to the parameter value made by the UDF are ignored by Db2.

specific-name

This argument is set by Db2 before calling the UDF. It is a VARCHAR(128) value that contains the specific name of the function on whose behalf the function code is being called.

Like function-name, this parameter is useful when the function code is being used by multiple UDF definitions so that the code can distinguish which definition is being called. Note: This parameter is treated as input only; any changes to the parameter value made by the UDF are ignored by Db2.

diagnostic-message

This argument is set by Db2 before calling the UDF. It is a VARCHAR(70) value that can be used by the UDF to send message text back when an SQLSTATE warning or error is signaled by the UDF.

It is initialized by the database on input to the UDF and may be set by the UDF with descriptive information. Message text is ignored by Db2 unless the SQL-state parameter is set by the UDF.

scratchpad

This argument is set by Db2 before calling the UDF. It is only present if the CREATE FUNCTION statement for the UDF specified the SCRATCHPAD keyword. This argument is a structure with the following elements:

- An INTEGER containing the length of the scratchpad.
- The actual scratchpad, initialized to all binary 0's by Db2 before the first call to the UDF.

The scratchpad can be used by the UDF either as working storage or as persistent storage, since it is maintained across UDF invocations.

For table functions, the scratchpad is initialized as above before the FIRST call to the UDF if FINAL CALL is specified on the CREATE FUNCTION. After this call, the scratchpad content is totally under control of the table function. Db2 does not examine or change the content of the scratchpad thereafter. The scratchpad is passed to the function on each invocation. The function can be re-entrant, and Db2 preserves its state information in the scratchpad.

If NO FINAL CALL was specified or defaulted for a table function, then the scratchpad is initialized as above for each OPEN call, and the scratchpad content is completely under control of the table function between OPEN calls. This can be very important for a table function used in a join or subquery. If it is necessary to maintain the content of the scratchpad across OPEN calls, then FINAL CALL must be specified in your CREATE FUNCTION statement. With FINAL CALL specified, in addition to the normal OPEN, FETCH, and CLOSE calls, the table function will also receive FIRST and FINAL calls, for the purpose of scratchpad maintenance and resource release.

call-type

This argument is set by Db2 before calling the UDF. For scalar functions, it is only present if the CREATE FUNCTION statement for the UDF specified the FINAL CALL keyword. However, for table functions it is *always* present. It follows the *scratchpad* argument; or the *diagnostic-message* argument if the scratchpad argument is not present. This argument takes the form of an INTEGER value.

For scalar functions:

-1

This is the *first call* to the UDF for this statement. A first call is a *normal call* in that all SQL argument values are passed.

0

This is a *normal call*. (All the normal input argument values are passed).

1

This is a *final call*. No *SQL-argument* or *SQL-argument-ind* values are passed. A UDF should not return any answer using the SQL-result, SQL-result-ind arguments, SQL-state, or diagnostic-message arguments. These arguments are ignored by the system when returned from the UDF.

For table functions:

-2

This is the *first call* to the UDF for this statement. A first call is a *normal call* in that all SQL argument values are passed.

-1

This is the *open call* to the UDF for this statement. The scratchpad is initialized if NO FINAL CALL is specified, but not necessarily otherwise. All SQL argument values are passed.

0

This is a *fetch call*. Db2 expects the table function to return either a row comprising the set of return values, or an end-of-table condition indicated by SQLSTATE value '02000'.

1

This is a *close call*. This call balances the OPEN call, and can be used to perform any external CLOSE processing and resource release.

2

This is a *final call*. No *SQL-argument* or *SQL-argument-ind* values are passed. A UDF should not return any answer using the SQL-result, SQL-result-ind arguments, SQL-state, or diagnostic-message arguments. These arguments are ignored by the system when returned from the UDF.

dbinfo

This argument is set by Db2 before calling the UDF. It is only present if the CREATE FUNCTION statement for the UDF specifies the DBINFO keyword. The argument is a structure whose definition is contained in the `sqludf` include.

Related reference

[SQL messages and codes](#)

Parameter style GENERAL

With the GENERAL parameter style, the parameters are passed to an external service program just as they are specified in the CREATE FUNCTION statement. This parameter style can be used only with scalar user-defined functions (UDFs).

The format is:

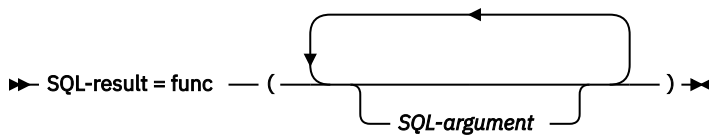

SQL-argument

This argument is set by Db2 before calling the UDF. This value repeats n times, where n is the number of arguments specified in the function reference. The value of each of these arguments is taken from the expression specified in the function invocation. It is expressed in the data type of the defined parameter in the CREATE FUNCTION statement. Note: These parameters are treated as input only; any changes to the parameter values made by the UDF are ignored by Db2.

SQL-result

This value is returned by the UDF. Db2 copies the value into database storage. In order to return the value correctly, the function code must be a value-returning function. The database copies only as much of the value as defined for the return value as specified on the CREATE FUNCTION statement. If the CAST FROM clause is used in the CREATE FUNCTION statement, Db2 assumes the UDF returns the value as defined in the CAST FROM clause, otherwise Db2 assumes the UDF returns the value as defined in the RETURNS clause.

Because of the requirement that the function code be a value-returning function, any function code used for parameter style GENERAL must be created into a service program.

Parameter style GENERAL WITH NULLS

The GENERAL WITH NULLS parameter style can be used only with scalar user-defined functions (UDFs).

With this parameter style, the parameters are passed into the service program as follows (in the order specified):

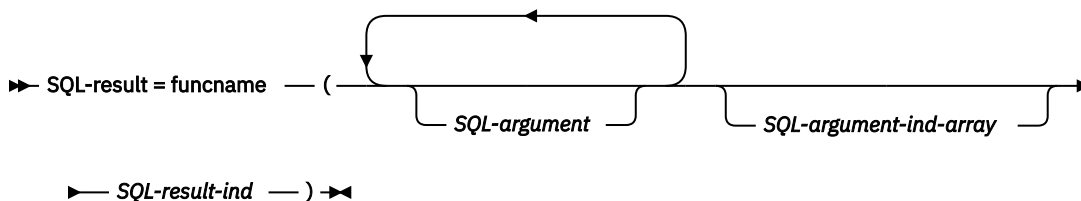

SQL-argument

This argument is set by Db2 before calling the UDF. This value repeats n times, where n is the number of arguments specified in the function reference. The value of each of these arguments is taken from the expression specified in the function invocation. It is expressed in the data type of the defined parameter in the CREATE FUNCTION statement. Note: These parameters are treated as input only; any changes to the parameter values made by the UDF are ignored by Db2.

SQL-argument-ind-array

This argument is set by Db2 before calling the UDF. It can be used by the UDF to determine if one or more *SQL-arguments* are null or not. It is an array of two-byte signed integers (indicators). The n th array argument corresponds to the n th *SQL-argument*. Each array entry is set to one of the following values:

- 0**
The argument is present and not null.
- 1**
The argument is null.

The UDF should check for null input. Note: This parameter is treated as input only; any changes to the parameter value made by the UDF is ignored by Db2.

SQL-result-ind

This argument is set by the UDF before returning to Db2. The database provides the storage for the return value. The argument is defined as a two-byte signed integer. If set to a negative value, the database interprets the result of the function as null. If set to zero or a positive value, the database uses the value returned in *SQL-result*. The database provides the storage for the return value indicator. Since the parameter is passed by address, the address is of the storage where the indicator value should be placed.

SQL-result

This value is returned by the UDF. Db2 copies the value into database storage. In order to return the value correctly, the function code must be a value-returning function. The database copies only as much of the value as defined for the return value as specified on the CREATE FUNCTION statement. If the CAST FROM clause is used in the CREATE FUNCTION statement, Db2 assumes the UDF returns the value as defined in the CAST FROM clause, otherwise Db2 assumes the UDF returns the value as defined in the RETURNS clause.

Because of the requirement that the function code be a value-returning function, any function code used for parameter style GENERAL WITH NULLS must be created into a service program.

Notes:

1. The external name specified on the CREATE FUNCTION statement can be specified either with or without single quotation marks. If the name is not quoted, it is uppercased before it is stored; if it is quoted, it is stored as specified. This becomes important when naming the actual program, as the database searches for the program that has a name that exactly matches the name stored with the function definition. For example, if a function was created as:

```
CREATE FUNCTION X(INT) RETURNS INT
LANGUAGE C
EXTERNAL NAME 'MYLIB/MYPGM(MYENTRY)'
```

and the source for the program was:

```
void myentry(
    int*in
    int*out,
    .
    .
    . .
```

the database will not find the entry because it is in lowercase *myentry* and the database was instructed to look for uppercase *MYENTRY*.

2. For service programs with C++ modules, make sure in the C++ source code to precede the program function definition with *extern "C"*. Otherwise, the C++ compiler will perform 'name mangling' of the function's name and the database will not find it.

Parameter style DB2GENERAL

The DB2GENERAL parameter style is used by Java user-defined functions (UDFs).

Related concepts

[Java SQL routines](#)

Parameter style Java

The Java parameter style is the style specified by the SQLJ Part 1: SQL Routines standard.

Related concepts

[Java SQL routines](#)

Table function considerations

An external table function is a user-defined function (UDF) that delivers a table to the SQL statement in which it is referenced. A table function reference is valid only in a FROM clause of a SELECT statement.

When using table functions, observe the following:

- Even though a table function delivers a table, the physical interface between Db2 and the UDF is one-row-at-a-time. There are five types of calls made to a table function: OPEN, FETCH, CLOSE, FIRST, and FINAL. The existence of FIRST and FINAL calls depends on how you define the UDF. The same *call-type* mechanism that can be used for scalar functions is used to distinguish these calls.
- The standard interface used between Db2 and user-defined scalar functions is extended to accommodate table functions. The *SQL-result* argument repeats for table functions; each instance corresponding to a column to be returned as defined in the RETURNS TABLE clause of the CREATE FUNCTION statement. The *SQL-result-idx* argument likewise repeats, each instance related to the corresponding *SQL-result* instance.
- Not every result column defined in the RETURNS clause of the CREATE FUNCTION statement for the table function has to be returned. The DBINFO keyword of CREATE FUNCTION, and corresponding *dbinfo* argument enable the optimization that only those columns needed for a particular table function reference need be returned.
- The individual column values returned conform in format to the values returned by scalar functions.
- The CREATE FUNCTION statement for a table function has a CARDINALITY *n* specification. This specification enables the definer to inform the Db2 optimizer of the approximate size of the result so that the optimizer can make better decisions when the function is referenced. Regardless of what has been specified as the CARDINALITY of a table function, exercise caution against writing a function with infinite cardinality; that is, a function that always returns a row on a FETCH call. Db2 expects the *end-of-table* condition, as a catalyst within its query processing. So a table function that never returns the end-of-table condition (SQL-state value '02000') can cause an infinite processing loop.

Error processing for UDFs

When an error occurs in processing a user-defined function (UDF), the system follows a specified model to handle the error.

Table function error processing

The error processing model for table function calls is as follows:

1. If FIRST call fails, no further calls are made.
2. If FIRST call succeeds, the nested OPEN, FETCH, and CLOSE calls are made, and the FINAL call is always made.
3. If OPEN call fails, no FETCH or CLOSE call is made.
4. If OPEN call succeeds, then FETCH and CLOSE calls are made.
5. If a FETCH call fails, no further FETCH calls are made, but the CLOSE call is made.

Note: This model describes the ordinary error processing for table UDFs. In the event of a system failure or communication problem, a call indicated by the error processing model may not be made.

Scalar function error processing

The error processing model for scalar UDFs, which are defined with the FINAL CALL specification, is as follows:

1. If FIRST call fails, no further calls are made.
2. If FIRST call succeeds, then further NORMAL calls are made as warranted by the processing of the statement, and a FINAL call is always made.
3. If NORMAL call fails, no further NORMAL calls are made, but the FINAL call is made (if you have specified FINAL CALL). This means that if an error is returned on a FIRST call, the UDF must clean up before returning, because no FINAL call will be made.

Note: This model describes the ordinary error processing for scalar UDFs. In the event of a system failure or communication problem, a call indicated by the error processing model may not be made.

Threads considerations

A user-defined function (UDF) that is defined as FENCED runs in the same job as the SQL statement that calls the function. However, the UDF runs in a system thread, separate from the thread that is running the SQL statement.

Because the UDF runs in the same job as the SQL statement, it shares much of the same environment as the SQL statement. However, because it runs under a separate thread, the following threads considerations apply:

- The UDF will conflict with thread level resources held by the SQL statement's thread. Primarily, these are the table resources discussed above.
- UDFs do not inherit any program adopted authority that may have been active at the time the SQL statement was called. UDF authority comes from either the authority associated with the UDF program itself or the authority of the user running the SQL statement.
- The UDF cannot perform any operation that is blocked from being run in a secondary thread.

Related reference

[Multithreaded applications](#)

[Fenced or unfenced considerations](#)

When you create a user-defined function (UDF), consider whether to make the UDF an unfenced UDF.

Parallel processing

A user-defined function (UDF) can be defined to allow parallel processing.

This means that the same UDF program can be running in multiple threads at the same time. Therefore, if ALLOW PARALLEL is specified for the UDF, ensure that it is thread safe.

Related reference

[Multithreaded applications](#)

Fenced or unfenced considerations

When you create a user-defined function (UDF), consider whether to make the UDF an unfenced UDF.

By default, UDFs are created as fenced UDFs. Fenced indicates that the database should run the UDF in a separate thread. For complex UDFs, this separation is meaningful as it will avoid potential problems such as generating unique SQL cursor names. Not having to be concerned about resource conflicts is one reason to stick with the default and create the UDF as a fenced UDF. A UDF created with the NOT FENCED option indicates to the database that the user is requesting that the UDF can run within the same thread that initiated the UDF. Unfenced is a suggestion to the database, which can still decide to run the UDF in the same manner as a fenced UDF.

```
CREATE FUNCTION QGPL.FENCED (parameter1 INTEGER)
RETURNS INTEGER LANGUAGE SQL
BEGIN
RETURN parameter1 * 3;
END;

CREATE FUNCTION QGPL.UNFENCED1 (parameter1 INTEGER)
RETURNS INTEGER LANGUAGE SQL NOT FENCED
-- Build the UDF to request faster execution via the NOT FENCED option
BEGIN
RETURN parameter1 * 3;
END;
```

Related reference

[Threads considerations](#)

A user-defined function (UDF) that is defined as FENCED runs in the same job as the SQL statement that calls the function. However, the UDF runs in a system thread, separate from the thread that is running the SQL statement.

Save and restore considerations

When an external function associated with an ILE external program or service program is created, an attempt is made to save the attributes of the function in the associated program or service program object.

If the *PGM or *SRVPGM object is saved and then restored to this or another system, the catalogs are automatically updated with those attributes. If the function's attribute cannot be saved, then the catalogs will not be automatically updated and the user must create the external function on the new system. The attributes can be saved for external functions subject to the following restrictions:

- The external program library must not be QSYS, QSYS2, SYSIBM, SYSPROC, or SYSIBMADM.
- The external program must exist when the CREATE FUNCTION statement is issued.
- The external program must be an ILE *PGM or *SRVPGM object.

If the program object cannot be updated, the function will still be created and a SQL7909 warning is returned. The SQL7909 warning includes a reason code that indicates why the program could not be updated.

Defining UDFs with default parameters

You can define parameters for UDFs to have default values.

A default value for a parameter means that the parameter is not required on the function invocation. Using defaults allows flexibility by not requiring every invocation of a function to pass all parameter values. This can be useful when modifying existing functions.

A default can be a simple value such as a constant or the null value. It can also be an SQL expression, so it can be very complex. A default cannot be defined using the value of another parameter as part of its default expression. Any objects referenced in a parameter default must exist when the function is created.

Suppose you have a table function that is passed one parameter that is a project number and returns all rows from the project activity table that are registered with that number. If you get a request to limit the number of rows returned to a range of start dates, that is easy to do by adding default parameters for a date range.

```
CREATE FUNCTION ActProj (ProjNum CHAR(6),
                        StartAfterDate DATE DEFAULT NULL,
                        StartBeforeDate DATE DEFAULT NULL)
  RETURNS TABLE (PROJNO CHAR(6),
                 ACTNO SMALLINT,
                 STARTDATE DATE)
```

The function logic needs to be modified to accept two new parameters that might contain dates or might be the NULL value. Any invocation of the function that does not have a reason to pass a date range does not need to be changed. It would continue to look like this:

```
ActProj (:projnum)
```

Any application that needs the date range can pass one or both of the date parameters:

```
ActProj (:projnum, :StartDate, :EndDate)
```

Defaults can be defined for SQL or external functions.

Examples: UDF code

These examples show how to implement user-defined function (UDF) code by using SQL functions and external functions.

Example: Square of a number UDF

Suppose that you want a function that returns the square of a number.

The query statement is:

```
SELECT SQUARE(myint) FROM mytable
```

Note: By using the code examples, you agree to the terms of the [“Code license and disclaimer information”](#) on page 396.

The following examples show how to define the UDF in several different ways.

Using an SQL function

The CREATE FUNCTION statement:

```
CREATE FUNCTION SQUARE( inval INT) RETURNS INT
LANGUAGE SQL
SET OPTION DBGVIEW=*SOURCE
BEGIN
RETURN(inval*inval);
END
```

This creates an SQL function that you can debug.

Using an external function, parameter style SQL

The CREATE FUNCTION statement:

```
CREATE FUNCTION SQUARE(INT) RETURNS INT CAST FROM FLOAT
LANGUAGE C
EXTERNAL NAME 'MYLIB/MATH(SQUARE) '
DETERMINISTIC
NO SQL
NO EXTERNAL ACTION
PARAMETER STYLE SQL
ALLOW PARALLEL
```

The code:

```
void SQUARE(int *inval,
double *outval,
short *inind,
short *outind,
char *sqlstate,
char *funcname,
char *specname,
char *msgtext)
{
if (*inind<0)
*outind=-1;
else
{
*outval=*inval;
*outval=(*outval)*(*outval);
*outind=0;
}
return;
}
```

To create the external service program so it can be debugged:

```
CRTCMOD MODULE(mylib/square) DBGVIEW(*SOURCE)
CRTSRVPGM SRVPGM(mylib/math) MODULE(mylib/square)
EXPORT(*ALL) ACTGRP(*CALLER)
```

Using an external function, parameter style GENERAL

The CREATE FUNCTION statement:

```
CREATE FUNCTION SQUARE(INT) RETURNS INT CAST FROM FLOAT
LANGUAGE C
EXTERNAL NAME 'MYLIB/MATH(SQUARE)'
DETERMINISTIC
NO SQL
NO EXTERNAL ACTION
PARAMETER STYLE GENERAL
ALLOW PARALLEL
```

The code:

```
double SQUARE(int *inval)
{
    double outval;
    outval=*inval;
    outval=outval*outval;
    return(outval);
}
```

To create the external service program so it can be debugged:

```
CRTCMOD MODULE(mylib/square) DBGVIEW(*SOURCE)

CRTSRVPGM SRVPGM(mylib/math) MODULE(mylib/square)
EXPORT(*ALL) ACTGRP(*CALLER)
```

Example: Counter

Suppose that you want to number the rows in a SELECT statement. So you write a user-defined function (UDF) that increments and returns a counter.

Note: By using the code examples, you agree to the terms of the [“Code license and disclaimer information”](#) on page 396.

This example uses an external function with Db2 SQL parameter style and a scratchpad.

```
CREATE FUNCTION COUNTER()
RETURNS INT
SCRATCHPAD
NOT DETERMINISTIC
NO SQL
NO EXTERNAL ACTION
LANGUAGE C
PARAMETER STYLE DB2SQL
EXTERNAL NAME 'MYLIB/MATH(ctr)'
DISALLOW PARALLEL

/* structure scr defines the passed scratchpad for the function "ctr" */
struct scr {
    long len;
    long countr;
    char not_used[92];
};

void ctr (
    long *out,
    short *outnull,
    char *sqlstate,
    char *funcname,
    char *specname,
    char *mesgtext,
    struct scr *scratchptr) {
    /* output answer (counter) */
    /* output NULL indicator */
    /* SQL STATE */
    /* function name */
    /* specific function name */
    /* message text insert */
    /* scratch pad */
```

```

    *out = ++scratchptr->count;      /* increment counter & copy out */
    *outnull = 0;
    return;
}
/* end of UDF : ctr */

```

For this UDF, observe that:

- It has no input SQL arguments defined, but returns a value.
- It appends the scratchpad input argument after the four standard trailing arguments, namely *SQL-state*, *function-name*, *specific-name*, and *message-text*.
- It includes a structure definition to map the scratchpad which is passed.
- No input parameters are defined. This agrees with the code.
- SCRATCHPAD is coded, causing Db2 to allocate, properly initialize and pass the scratchpad argument.
- You have specified it to be NOT DETERMINISTIC, because it depends on more than the SQL input arguments, (none in this case).
- You have correctly specified DISALLOW PARALLEL, because correct functioning of the UDF depends on a single scratchpad.

Example: Weather table function

Suppose that you write a table function that returns weather information for various cities in the United States.

Note: By using the code examples, you agree to the terms of the [“Code license and disclaimer information”](#) on page 396.

The weather data for these cities is read in from an external file, as indicated in the comments contained in the example program. The data includes the name of a city followed by its weather information. This pattern is repeated for the other cities.

```

#include <stdlib.h>
#include <string.h>
#include <stdio.h>
#include <sqludf.h> /* for use in compiling User Defined Function */

#define SQL_NOTNULL 0 /* Nulls Allowed - Value is not Null */
#define SQL_ISNULL -1 /* Nulls Allowed - Value is Null */
#define SQL_TYP_VARCHAR 448
#define SQL_TYP_INTEGER 496
#define SQL_TYP_FLOAT 480

/* Short and long city name structure */
typedef struct {
    char * city_short ;
    char * city_long ;
} city_area ;

/* Scratchpad data */ (See note 1)
/* Preserve information from one function call to the next call */
typedef struct {
    /* FILE * file_ptr; if you use weather data text file */
    int file_pos ; /* if you use a weather data buffer */
} scratch_area ;

/* Field descriptor structure */
typedef struct {
    char fld_field[31] ; /* Field data */
    int fld_ind ; /* Field null indicator data */
    int fld_type ; /* Field type */
    int fld_length ; /* Field length in the weather data */
    int fld_offset ; /* Field offset in the weather data */
} fld_desc ;

/* Short and long city name data */
city_area cities[] = {
    { "alb", "Albany, NY" },
    { "atl", "Atlanta, GA" },
    .

```

```

.
{ "wbc", "Washington DC, DC" },
/* You may want to add more cities here */

/* Do not forget a null termination */
{ ( char * ) 0, ( char * ) 0 }
};

/* Field descriptor data */
fld_desc fields[] = {
{ "", SQL_ISNULL, SQL_TYP_VARCHAR, 30, 0 }, /* city */
{ "", SQL_ISNULL, SQL_TYP_INTEGER, 3, 2 }, /* temp_in_f */
{ "", SQL_ISNULL, SQL_TYP_INTEGER, 3, 7 }, /* humidity */
{ "", SQL_ISNULL, SQL_TYP_VARCHAR, 5, 13 }, /* wind */
{ "", SQL_ISNULL, SQL_TYP_INTEGER, 3, 19 }, /* wind_velocity */
{ "", SQL_ISNULL, SQL_TYP_FLOAT, 5, 24 }, /* barometer */
{ "", SQL_ISNULL, SQL_TYP_VARCHAR, 25, 30 }, /* forecast */
/* You may want to add more fields here */

/* Do not forget a null termination */
{ ( char ) 0, 0, 0, 0, 0 }
};

/* Following is the weather data buffer for this example. You */
/* may want to keep the weather data in a separate text file. */
/* Uncomment the following fopen() statement. Note that you */
/* need to specify the full path name for this file. */
char * weather_data[] = {
"alb.forecast",
" 34 28% wnw 3 30.53 clear",
"atl.forecast",
" 46 89% east 11 30.03 fog",
.
.
"wbc.forecast",
" 38 96% ene 16 30.31 light rain",
/* You may want to add more weather data here */

/* Do not forget a null termination */
( char * ) 0
};

#ifdef __cplusplus
extern "C"
#endif
/* This is a subroutine. */
/* Find a full city name using a short name */
int get_name( char * short_name, char * long_name ) {

int name_pos = 0 ;

while ( cities[name_pos].city_short != ( char * ) 0 ) {
if ( strcmp( short_name, cities[name_pos].city_short ) == 0 ) {
strcpy( long_name, cities[name_pos].city_long ) ;
/* A full city name found */
return( 0 ) ;
}
name_pos++ ;
}
/* can not find such city in the city data */
strcpy( long_name, "Unknown City" ) ;
return( -1 ) ;

}

#ifdef __cplusplus
extern "C"
#endif
/* This is a subroutine. */
/* Clean all field data and field null indicator data */
int clean_fields( int field_pos ) {

while ( fields[field_pos].fld_length !=0 ) {
memset( fields[field_pos].fld_field, '\0', 31 ) ;
fields[field_pos].fld_ind = SQL_ISNULL ;
field_pos++ ;
}
return( 0 ) ;

}
}

```



```

#ifdef __cplusplus
extern "C"
#endif
/* This is a subroutine. */
/* Fills all field data and field null indicator data ... */
/* ... from text weather data */
int get_value( char * value, int field_pos ) {

    fld_desc * field ;
    char field_buf[31] ;
    double * double_ptr ;
    int * int_ptr, buf_pos ;

    while ( fields[field_pos].fld_length != 0 ) {
        field = &fields[field_pos] ;
        memset( field_buf, '\0', 31 ) ;
        memcpy( field_buf,
                ( value + field->fld_offset ),
                field->fld_length ) ;
        buf_pos = field->fld_length ;
        while ( ( buf_pos > 0 ) &&
                ( field_buf[buf_pos] == ' ' ) )
            field_buf[buf_pos--] = '\0' ;
        buf_pos = 0 ;
        while ( ( buf_pos < field->fld_length ) &&
                ( field_buf[buf_pos] == ' ' ) )
            buf_pos++ ;
        if ( strlen( ( char * ) ( field_buf + buf_pos ) ) > 0 ||
            strcmp( ( char * ) ( field_buf + buf_pos ), "n/a" ) != 0 ) {
            field->fld_ind = SQL_NOTNULL ;

            /* Text to SQL type conversion */
            switch( field->fld_type ) {
                case SQL_TYP_VARCHAR:
                    strcpy( field->fld_field,
                            ( char * ) ( field_buf + buf_pos ) ) ;
                    break ;
                case SQL_TYP_INTEGER:
                    int_ptr = ( int * ) field->fld_field ;
                    *int_ptr = atoi( ( char * ) ( field_buf + buf_pos ) ) ;
                    break ;
                case SQL_TYP_FLOAT:
                    double_ptr = ( double * ) field->fld_field ;
                    *double_ptr = atof( ( char * ) ( field_buf + buf_pos ) ) ;
                    break ;
                /* You may want to add more text to SQL type conversion here */
            }
        }

        field_pos++ ;
    }
    return( 0 ) ;
}

#ifdef __cplusplus
extern "C"
#endif
void SQL_API_FN weather( /* Return row fields */
                        SQLUDF_VARCHAR * city,
                        SQLUDF_INTEGER * temp_in_f,
                        SQLUDF_INTEGER * humidity,
                        SQLUDF_VARCHAR * wind,
                        SQLUDF_INTEGER * wind_velocity,
                        SQLUDF_DOUBLE * barometer,
                        SQLUDF_VARCHAR * forecast,
                        /* You may want to add more fields here */

                        /* Return row field null indicators */
                        SQLUDF_NULLIND * city_ind,
                        SQLUDF_NULLIND * temp_in_f_ind,
                        SQLUDF_NULLIND * humidity_ind,
                        SQLUDF_NULLIND * wind_ind,
                        SQLUDF_NULLIND * wind_velocity_ind,
                        SQLUDF_NULLIND * barometer_ind,
                        SQLUDF_NULLIND * forecast_ind,
                        /* You may want to add more field indicators here */

                        /* UDF always-present (trailing) input arguments */
                        SQLUDF_TRAIL_ARGS_ALL
                        ) {

```

```

scratch_area * save_area ;
char line_buf[81] ;
int line_buf_pos ;

/* SQLUDF_SCRAT is part of SQLUDF_TRAIL_ARGS_ALL */
/* Preserve information from one function call to the next call */
save_area = ( scratch_area * ) ( SQLUDF_SCRAT->data ) ;

/* SQLUDF_CALLT is part of SQLUDF_TRAIL_ARGS_ALL */
switch( SQLUDF_CALLT ) {

    /* First call UDF: Open table and fetch first row */
    case SQL_TF_OPEN:
        /* If you use a weather data text file specify full path */
        /* save_area->file_ptr = fopen("tblsrv.dat","r"); */
        save_area->file_ptr = 0 ;
        break ;

    /* Normal call UDF: Fetch next row */ (See note 2)
    case SQL_TF_FETCH:
        /* If you use a weather data text file */
        /* memset(line_buf, '\0', 81); */
        /* if (fgets(line_buf, 80, save_area->file_ptr) == NULL) { */
        if ( weather_data[save_area->file_ptr] == ( char * ) 0 ) {

            /* SQLUDF_STATE is part of SQLUDF_TRAIL_ARGS_ALL */
            strcpy( SQLUDF_STATE, "02000" ) ;

            break ;
        }
        memset( line_buf, '\0', 81 ) ;
        strcpy( line_buf, weather_data[save_area->file_ptr] ) ;
        line_buf[3] = '\0' ;

        /* Clean all field data and field null indicator data */
        clean_fields( 0 ) ;

        /* Fills city field null indicator data */
        fields[0].fld_ind = SQL_NOTNULL ;

        /* Find a full city name using a short name */
        /* Fills city field data */
        if ( get_name( line_buf, fields[0].fld_field ) == 0 ) {
            save_area->file_ptr++ ;
            /* If you use a weather data text file */
            /* memset(line_buf, '\0', 81); */
            /* if (fgets(line_buf, 80, save_area->file_ptr) == NULL) { */
            if ( weather_data[save_area->file_ptr] == ( char * ) 0 ) {
                /* SQLUDF_STATE is part of SQLUDF_TRAIL_ARGS_ALL */
                strcpy( SQLUDF_STATE, "02000" ) ;
                break ;
            }
            memset( line_buf, '\0', 81 ) ;
            strcpy( line_buf, weather_data[save_area->file_ptr] ) ;
            line_buf_pos = strlen( line_buf ) ;
            while ( line_buf_pos > 0 ) {
                if ( line_buf[line_buf_pos] >= ' ' )
                    line_buf_pos = 0 ;
                else {
                    line_buf[line_buf_pos] = '\0' ;
                    line_buf_pos-- ;
                }
            }
        }

        /* Fills field data and field null indicator data ... */
        /* ... for selected city from text weather data */
        get_value( line_buf, 1 ) ; /* Skips city field */

        /* Builds return row fields */
        strcpy( city, fields[0].fld_field ) ;
        memcpy( (void *) temp_in_f,
            fields[1].fld_field,
            sizeof( SQLUDF_INTEGER ) ) ;
        memcpy( (void *) humidity,
            fields[2].fld_field,
            sizeof( SQLUDF_INTEGER ) ) ;
        strcpy( wind, fields[3].fld_field ) ;
        memcpy( (void *) wind_velocity,
            fields[4].fld_field,
            sizeof( SQLUDF_INTEGER ) ) ;

```

```

memcpy( (void *) barometer,
        fields[5].fld_field,
        sizeof( SQLUDF_DOUBLE ) );
strcpy( forecast, fields[6].fld_field );

/* Builds return row field null indicators */
memcpy( (void *) city_ind,
        &(fields[0].fld_ind),
        sizeof( SQLUDF_NULLIND ) );
memcpy( (void *) temp_in_f_ind,
        &(fields[1].fld_ind),
        sizeof( SQLUDF_NULLIND ) );
memcpy( (void *) humidity_ind,
        &(fields[2].fld_ind),
        sizeof( SQLUDF_NULLIND ) );
memcpy( (void *) wind_ind,
        &(fields[3].fld_ind),
        sizeof( SQLUDF_NULLIND ) );
memcpy( (void *) wind_velocity_ind,
        &(fields[4].fld_ind),
        sizeof( SQLUDF_NULLIND ) );
memcpy( (void *) barometer_ind,
        &(fields[5].fld_ind),
        sizeof( SQLUDF_NULLIND ) );
memcpy( (void *) forecast_ind,
        &(fields[6].fld_ind),
        sizeof( SQLUDF_NULLIND ) );

/* Next city weather data */
save_area->file_pos++;

break ;

/* Special last call UDF for clean up (no real args!): Close table */ (See note 3)
case SQL_TF_CLOSE:
/* If you use a weather data text file */
/* fclose(save_area->file_ptr); */
/* save_area->file_ptr = NULL; */
save_area->file_pos = 0 ;
break ;

}

}

```

Referring to the embedded notes in this UDF code, note the following points:

1. The scratchpad is defined. The row variable is initialized on the OPEN call, and the `iptr` array and `nbr_rows` variable are filled in by the `mystery` function at open time.
2. FETCH traverses the `iptr` array, using row as an index, and moves the values of interest from the current element of `iptr` to the location pointed to by `out_c1`, `out_c2`, and `out_c3` result value pointers.
3. CLOSE frees the storage acquired by OPEN and anchored in the scratchpad.

Following is the CREATE FUNCTION statement for this UDF:

```

CREATE FUNCTION tfweather_u()
  RETURNS TABLE (CITY VARCHAR(25),
                 TEMP_IN_F INTEGER,
                 HUMIDITY INTEGER,
                 WIND VARCHAR(5),
                 WIND_VELOCITY INTEGER,
                 BAROMETER FLOAT,
                 FORECAST VARCHAR(25))
  SPECIFIC tfweather_u
  DISALLOW PARALLEL
  NOT FENCED
  DETERMINISTIC
  NO SQL
  NO EXTERNAL ACTION
  SCRATCHPAD
  NO FINAL CALL
  LANGUAGE C
  PARAMETER STYLE DB2SQL
  EXTERNAL NAME 'LIB1/WEATHER(weather)';

```

For this table function definition, note the following points:

- It does not take any input, and it returns seven output columns.
- SCRATCHPAD is specified, so Db2 allocates, properly initializes, and passes the scratchpad argument.
- NO FINAL CALL is specified.
- The function is specified as NOT DETERMINISTIC, because it depends on more than the SQL input arguments. That is, it depends on the mystery function and we assume that the content can vary from execution to execution.
- CARDINALITY 100, the default, is an estimate of the expected number of rows returned, which is provided to the Db2 optimizer.
- DBINFO is not used, and the optimization to only return the columns needed by the particular statement referencing the function is not implemented.

To select all of the rows generated by this table function, use the following query:

```
SELECT *  
FROM TABLE (tfweather_u())x
```

Using UDFs in SQL statements

Scalar and column user-defined functions (UDFs) can be called within an SQL statement almost everywhere an expression is valid. Table UDFs can be called in the FROM clause of a SELECT statement. Listed here are a few restrictions on the use of UDFs.

- UDFs and system generated functions cannot be specified in check constraints. Check constraints also cannot contain references to some built-in functions that are implemented by the system as UDFs.
- External UDFs, SQL UDFs and the built-in functions DLVALUE, DLURLPATH, DLURLPATHONLY, DLURLSCHEME, DLURLCOMPLETE, and DLURLSERVER cannot be referenced in an ORDER BY or GROUP BY clause, unless the SQL statement is read-only and allows temporary processing (ALWCPYDTA(*YES) or (*OPTIMIZE)).

Using parameter markers or the NULL values as function arguments

You can use a parameter marker or a NULL value as a function argument. Function resolution has rules about how an untyped argument is used during the function selection process.

Assuming your path is set up correctly, you can code the following:

```
BLOOP(?)
```

or

```
BLOOP(NULL)
```

You can use the CAST specification to provide a data type for the parameter marker or NULL value that function resolution can use to find the correct function:

```
BLOOP(CAST(? AS INTEGER))
```

or

```
BLOOP(CAST(NULL AS INTEGER))
```

Related reference

[Determining the best fit](#)

Using qualified function references

If you use a qualified function reference, you restrict the search for a matching function to the specified schema.

For example, you have the following statement:

```
SELECT PABLO.BLOOP(COLUMN1) FROM T
```

Only the BLOOP functions in schema PABLO are considered. It does not matter that user SERGE has defined a BLOOP function, or whether there is a built-in BLOOP function. Now suppose that user PABLO has defined two BLOOP functions in his schema:

```
CREATE FUNCTION BLOOP (INTEGER) RETURNS ...
CREATE FUNCTION BLOOP (DOUBLE) RETURNS ...
```

BLOOP is thus overloaded within the PABLO schema, and the function selection algorithm chooses the best BLOOP, depending on the data type of the argument, COLUMN1. In this case, both of the PABLO.BLOOPS take numeric arguments. If COLUMN1 is not castable to a numeric type, the statement will fail. If COLUMN1 is a character or graphic type, the castable process for function resolution will resolve to the second BLOOP function. If COLUMN1 is either SMALLINT or INTEGER, function selection will resolve to the first BLOOP, while if COLUMN1 is DECIMAL or DOUBLE, the second BLOOP will be chosen.

Several points about this example:

1. It illustrates argument promotion. The first BLOOP is defined with an INTEGER parameter, yet you can pass it a SMALLINT argument. The function selection algorithm supports promotions among the built-in data types and Db2 performs the appropriate data value conversions.
2. If for some reason you want to call the second BLOOP with a SMALLINT or INTEGER argument, you need to take an explicit action in your statement as follows:

```
SELECT PABLO.BLOOP(DOUBLE(COLUMN1)) FROM T
```

3. If you want to call the first BLOOP with a DECIMAL or DOUBLE argument, you have your choice of explicit actions, depending on your intent:

```
SELECT PABLO.BLOOP(INTEGER(COLUMN1)) FROM T
SELECT PABLO.BLOOP(FLOOR(COLUMN1)) FROM T
```

Related reference

[Using unqualified function references](#)

You can use an unqualified function reference instead of a qualified function reference. When searching for a matching function, Db2 normally uses the function path to qualify the reference.

[Defining a UDT](#)

You define a user-defined type (UDT) using the CREATE DISTINCT TYPE statement.

Using unqualified function references

You can use an unqualified function reference instead of a qualified function reference. When searching for a matching function, Db2 normally uses the function path to qualify the reference.

In the case of the DROP FUNCTION and COMMENT ON FUNCTION statements, the reference is qualified using the current authorization ID, if they are unqualified for *SQL naming, or *LIBL for *SYS naming. Thus, it is important that you know what your function path is, and what, if any, conflicting functions exist in the schemas of your current function path. For example, suppose that you are PABLO and your static SQL statement is as follows, where COLUMN1 is data type INTEGER:

```
SELECT BLOOP(COLUMN1) FROM T
```

You have created the two BLOOP functions in the section Using qualified function reference, and you want and expect one of them to be chosen. If the following default function path is used, the first BLOOP is chosen (since COLUMN1 is INTEGER), if there is no conflicting BLOOP in QSYS or QSYS2:

```
"QSYS", "QSYS2", "PABLO"
```

However, suppose you have forgotten that you are using a script for precompiling and binding which you previously wrote for another purpose. In this script, you explicitly coded your SQLPATH parameter to specify the following function path for another reason that does not apply to your current work:

```
"KATHY", "QSYS", "QSYS2", "PABLO"
```

If there is a BLOOP function in schema KATHY, the function selection can very well resolve to that function, and your statement executes without error. You are not notified because Db2 assumes that you know what you are doing. It is your responsibility to identify the incorrect output from your statement and make the required correction.

Related reference

Using qualified function references

If you use a qualified function reference, you restrict the search for a matching function to the specified schema.

Invoking UDFs with named arguments

A UDF can be invoked by passing the parameter name along with the parameter value.

When invoking a function, the parameters are traditionally listed in the order they are defined for the function. You can also list them in any order by using the parameter name. Arguments for parameters that have defaults can be omitted completely. This is true for any user defined function, SQL or external.

Suppose you define a function like this:

```
CREATE FUNCTION testfunc (parm1 INT, parm2 INT, parm3 INT DEFAULT 10, parm4 INT DEFAULT -1) ...
```

Since the first two parameters do not have defaults, they must be included somewhere in the function invocation. The last two parameters can be omitted, since they have defaults. All of the following are valid and pass identical values to the function:

```
testfunc(10, 20, DEFAULT, 22)
testfunc(parm1=>10, parm2 => 20, parm3 => DEFAULT, parm4 => 22)
testfunc(10, 20, parm4=> 22)
testfunc(parm4 => 22, parm2 => 20, parm1 =>10)
```

Summary of function references

For both qualified and unqualified function references, the function selection algorithm looks at all the applicable functions, both built-in and user-defined functions, that have the given name, the same number of defined parameters as arguments, and each parameter identical to or promotable from the type of the corresponding argument.

Applicable functions means functions in the named schema for a qualified reference, or functions in the schemas of the function path for an unqualified reference. The algorithm looks for an exact match, or failing that, a best match among these functions. The current function path is used, in the case of an unqualified reference only, as the deciding factor if two identically good matches are found in different schemas.

An interesting feature is that function references can be nested, even references to the same function. This is generally true for built-in functions as well as UDFs. However, there are some limitations when aggregate functions are involved.

Refining an earlier example:

```
CREATE FUNCTION BLOOP (INTEGER) RETURNS INTEGER ...
CREATE FUNCTION BLOOP (DOUBLE) RETURNS INTEGER ...
```

Now consider the following statement:

```
SELECT BLOOP( BLOOP(COLUMN1)) FROM T
```

If COLUMN1 is a DECIMAL or DOUBLE column, the inner BLOOP reference resolves to the second BLOOP defined above. Because this BLOOP returns an INTEGER, the outer BLOOP resolves to the first BLOOP.

Alternatively, if COLUMN1 is a SMALLINT or INTEGER column, the inner BLOOP reference resolves to the first BLOOP defined above. Because this BLOOP returns an INTEGER, the outer BLOOP also resolves to the first BLOOP. In this case, you are seeing nested references to the same function.

A few additional points important for function references are:

- You can define a function with the name of one of the SQL operators. For example, suppose you can attach some meaning to the "+" operator for values which have distinct type BOAT. You can define the following UDF:

```
CREATE FUNCTION "+" (BOAT, BOAT) RETURNS ...
```

Then you can write the following valid SQL statement:

```
SELECT "+"(BOAT_COL1, BOAT_COL2)
FROM BIG_BOATS
WHERE BOAT_OWNER = 'Nelson Mattos'
```

You are not permitted to overload the built-in conditional operators such as >, =, LIKE, IN, and so on, in this way.

- The function selection algorithm does not consider the context of the reference in resolving to a particular function. Look at these BLOOP functions, modified a bit from before:

```
CREATE FUNCTION BLOOP (INTEGER) RETURNS INTEGER ...
CREATE FUNCTION BLOOP (DOUBLE) RETURNS CHAR(10)...
```

Now suppose you write the following SELECT statement:

```
SELECT 'ABCDEFG' CONCAT BLOOP(SMALLINT_COL) FROM T
```

Because the best match, resolved using the SMALLINT argument, is the first BLOOP defined above, the second operand of the CONCAT resolves to data type INTEGER. The statement might not return the expected result since the returned integer will be cast as a VARCHAR before the CONCAT is performed. If the first BLOOP was not present, the other BLOOP is chosen and the statement execution is successful.

- UDFs can be defined with parameters or results having any of the LOB types: BLOB, CLOB, or DBCLOB. The system will materialize the entire LOB value in storage before calling such a function, even if the source of the value is a *LOB locator* host variable. For example, consider the following fragment of a C language application:

```
EXEC SQL BEGIN DECLARE SECTION;
SQL TYPE IS CLOB(150K) clob150K ;          /* LOB host var */
SQL TYPE IS CLOB_LOCATOR clob_locator1; /* LOB locator host var */
char string[40];                          /* string host var */
EXEC SQL END DECLARE SECTION;
```

Either host variable :clob150K or :clob_locator1 is valid as an argument for a function whose corresponding parameter is defined as CLOB(500K). Referring to the FINDSTRING defined in [“Example: String search” on page 206](#) both of the following are valid in the program:

```
... SELECT FINDSTRING (:clob150K, :string) FROM ...
... SELECT FINDSTRING (:clob_locator1, :string) FROM ...
```

- External UDF parameters or results which have one of the LOB types can be created with the AS LOCATOR modifier. In this case, the entire LOB value is not materialized before invocation. Instead, a LOB LOCATOR is passed to the UDF.

You can also use this capability on UDF parameters or results which have a distinct type that is based on a LOB. This capability is limited to external UDFs. Note that the argument to such a function can be any LOB value of the defined type; it does not need to be a host variable defined as one of the LOCATOR types. The use of host variable locators as arguments is completely unrelated to the use of AS LOCATOR in UDF parameters and result definitions.

- UDFs can be defined with distinct types as parameters or as the result. Db2 will pass the value to the UDF in the format of the source data type of the distinct type.

Distinct type values that originate in a host variable and which are used as arguments to a UDF which has its corresponding parameter defined as a distinct type must be explicitly cast to the distinct type by the user. There is no host language type for distinct types. Db2's strong typing necessitates this. Otherwise your results may be ambiguous. So, consider the BOAT distinct type that is defined over a BLOB that takes an object of type BOAT as its argument. In the following fragment of a C language application, the host variable `:ship` holds the BLOB value that is to be passed to the `BOAT_COST` function:

```
EXEC SQL BEGIN DECLARE SECTION;  
SQL TYPE IS BLOB(150K) ship;  
EXEC SQL END DECLARE SECTION;
```

Both of the following statements correctly resolve to the `BOAT_COST` function, because both cast the `:ship` host variable to type `BOAT`:

```
... SELECT BOAT_COST (BOAT(:ship)) FROM ...  
... SELECT BOAT_COST (CAST(:ship AS BOAT)) FROM ...
```

If there are multiple `BOAT` distinct types in the database, or `BOAT` UDFs in other schema, you must be careful with your function path. Otherwise your results may be unpredictable.

Related reference

[Determining the best fit](#)

Triggers

A *trigger* is a set of actions that runs automatically when a specified change operation is performed on a specified table or view.

The change operation can be an SQL INSERT, UPDATE, or DELETE statement, or an insert, an update, or a delete high-level language statement in an application program. Triggers are useful for tasks such as enforcing business rules, validating input data, and keeping an audit trail.

Triggers can be defined as SQL or external.

For an external trigger, the `ADDPFTRG` CL command is used. The program containing the set of trigger actions can be defined in any supported high level language. External triggers can be insert, update, delete, or read triggers.

For an SQL trigger, the `CREATE TRIGGER` statement is used. The trigger program is defined entirely using SQL. SQL triggers can be insert, update, or delete triggers. An SQL trigger can also be defined to have more than one of these events within a single trigger program.

Once a trigger is associated with a table or view, the trigger support calls the trigger program whenever a change operation is initiated against the table or view, or any logical file or view created over the table or view. SQL triggers and external triggers can be defined for the same table. Only SQL triggers can be defined for a view. Up to 300 triggers can be defined for a single table or view.

Each change operation for a table can call a trigger before or after the change operation occurs. Additionally, you can add a *read* trigger that is called every time the table is accessed. Thus, a table can be associated with many types of triggers.

- Before delete trigger
- Before insert trigger
- Before update trigger

- After delete trigger
- After insert trigger
- After update trigger
- Read-only trigger (external trigger only)

Each change operation for a view can call an instead of trigger which will perform some set of actions instead of the insert, update, or delete. A view can be associated with an:

- Instead of delete trigger
- Instead of insert trigger
- Instead of update trigger

Related tasks

[Triggering automatic events in your database](#)

SQL triggers

The SQL CREATE TRIGGER statement provides a way for the database management system to actively control, monitor, and manage a group of tables and views whenever an insert, an update, or a delete operation is performed. The body of the trigger is written in the SQL procedural language, SQL PL.

The statements specified in the SQL trigger are executed each time an insert, update, or delete operation is performed. An SQL trigger may call stored procedures or user-defined functions to perform additional processing when the trigger is executed.

Unlike stored procedures, an SQL trigger cannot be directly called from an application. Instead, an SQL trigger is invoked by the database management system on the execution of a triggering insert, update, or delete operation. The definition of the SQL trigger is stored in the database management system and is invoked by the database management system when the SQL table or view that the trigger is defined on, is modified.

An SQL trigger can be created by specifying the CREATE TRIGGER SQL statement. All objects referred to in the CREATE TRIGGER statement (such as tables and functions) must exist; otherwise, the trigger will not be created. If an object does not exist when the trigger is being created, dynamic SQL can be used to generate a statement that references the object. The statements in the routine-body of the SQL trigger are transformed by SQL into a program (*PGM) object. The program is created in the schema specified by the trigger name qualifier. The specified trigger is registered in the SYSTRIGGERS, SYSTRIGDEP, SYSTRIGCOL, and SYSTRIGUPD SQL catalogs.

Related concepts

[Debugging an SQL routine](#)

By specifying SET OPTION DBGVIEW = *SOURCE in the CREATE PROCEDURE, CREATE FUNCTION, or CREATE TRIGGER statement, you can debug the generated program or module at the SQL statement level.

Related reference

[SQL control statements](#)

[CREATE TRIGGER](#)

BEFORE SQL triggers

BEFORE triggers cannot change tables, but they can be used to verify input column values and to change column values that are inserted or updated in a table.

In the following example, the trigger is used to set the fiscal quarter for the corporation before inserting the row into the target table.

```
CREATE TABLE TransactionTable (DateOfTransaction DATE, FiscalQuarter SMALLINT)

CREATE TRIGGER TransactionBeforeTrigger BEFORE INSERT ON TransactionTable
REFERENCING NEW AS new_row
FOR EACH ROW MODE DB2ROW
BEGIN
```

```

DECLARE newmonth SMALLINT;
SET newmonth = MONTH(new_row.DateOfTransaction);
IF newmonth < 4 THEN
  SET new_row.FiscalQuarter=3;
ELSEIF newmonth < 7 THEN
  SET new_row.FiscalQuarter=4;
ELSEIF newmonth < 10 THEN
  SET new_row.FiscalQuarter=1;
ELSE
  SET new_row.FiscalQuarter=2;
END IF;
END

```

For the SQL insert statement below, the "FiscalQuarter" column is set to 2, if the current date is November 14, 2000.

```

INSERT INTO TransactionTable(DateOfTransaction)
VALUES(CURRENT DATE)

```

SQL triggers have access to and can use user-defined types (UDTs) and stored procedures. In the following example, the SQL trigger calls a stored procedure to execute some predefined business logic, in this case, to set a column to a predefined value for the business.

```

CREATE DISTINCT TYPE enginesize AS DECIMAL(5,2) WITH COMPARISONS
CREATE DISTINCT TYPE engineclass AS VARCHAR(25) WITH COMPARISONS
CREATE PROCEDURE SetEngineClass(IN SizeInLiters enginesize,
                                OUT CLASS engineclass)
LANGUAGE SQL CONTAINS SQL
BEGIN
  IF SizeInLiters<2.0 THEN
    SET CLASS = 'Mouse';
  ELSEIF SizeInLiters<3.1 THEN
    SET CLASS = 'Economy Class';
  ELSEIF SizeInLiters<4.0 THEN
    SET CLASS = 'Most Common Class';
  ELSEIF SizeInLiters<4.6 THEN
    SET CLASS = 'Getting Expensive';
  ELSE
    SET CLASS = 'Stop Often for Fillups';
  END IF;
END

CREATE TABLE EngineRatings (VariousSizes enginesize, ClassRating engineclass)

CREATE TRIGGER SetEngineClassTrigger BEFORE INSERT ON EngineRatings
REFERENCING NEW AS new_row
FOR EACH ROW MODE DB2ROW
  CALL SetEngineClass(new_row.VariousSizes, new_row.ClassRating)

```

For the SQL insert statement below, the "ClassRating" column is set to "Economy Class", if the "VariousSizes" column has the value of 3.0.

```

INSERT INTO EngineRatings(VariousSizes) VALUES(3.0)

```

SQL requires all tables, user-defined functions, procedures and user-defined types to exist before creating an SQL trigger. In the examples above, all of the tables, stored procedures, and user-defined types are defined before the trigger is created.

AFTER SQL triggers

An after trigger runs after the corresponding insert, update, or delete changes are applied to the table.

The WHEN condition can be used in an SQL trigger to specify a condition. If the condition evaluates to true, the SQL statements in the SQL trigger routine body are run. If the condition evaluates to false, the SQL statements in the SQL trigger routine body are not run, and control is returned to the database system.

In the following example, a query is evaluated to determine if the statements in the trigger routine body should be run when the trigger is activated.

```
CREATE TABLE TodaysRecords(TodaysMaxBarometricPressure FLOAT,
    TodaysMinBarometricPressure FLOAT)

CREATE TABLE OurCitysRecords(RecordMaxBarometricPressure FLOAT,
    RecordMinBarometricPressure FLOAT)

CREATE TRIGGER UpdateMaxPressureTrigger
AFTER UPDATE OF TodaysMaxBarometricPressure ON TodaysRecords
REFERENCING NEW AS new_row
FOR EACH ROW MODE DB2ROW
WHEN (new_row.TodaysMaxBarometricPressure >
    (SELECT MAX(RecordMaxBarometricPressure) FROM
        OurCitysRecords))
UPDATE OurCitysRecords
    SET RecordMaxBarometricPressure =
        new_row.TodaysMaxBarometricPressure

CREATE TRIGGER UpdateMinPressureTrigger
AFTER UPDATE OF TodaysMinBarometricPressure
ON TodaysRecords
REFERENCING NEW AS new_row
FOR EACH ROW MODE DB2ROW
WHEN (new_row.TodaysMinBarometricPressure <
    (SELECT MIN(RecordMinBarometricPressure) FROM
        OurCitysRecords))
UPDATE OurCitysRecords
    SET RecordMinBarometricPressure =
        new_row.TodaysMinBarometricPressure
```

First the current values are initialized for the tables.

```
INSERT INTO TodaysRecords VALUES(0.0,0.0)
INSERT INTO OurCitysRecords VALUES(0.0,0.0)
```

For the SQL update statement below, the RecordMaxBarometricPressure in OurCitysRecords is updated by the UpdateMaxPressureTrigger.

```
UPDATE TodaysRecords SET TodaysMaxBarometricPressure = 29.95
```

But tomorrow, if the TodaysMaxBarometricPressure is only 29.91, then the RecordMaxBarometricPressure is not updated.

```
UPDATE TodaysRecords SET TodaysMaxBarometricPressure = 29.91
```

SQL allows the definition of multiple triggers for a single triggering action. In the previous example, there are two AFTER UPDATE triggers: UpdateMaxPressureTrigger and UpdateMinPressureTrigger. These triggers are activated only when specific columns of the table TodaysRecords are updated.

AFTER triggers may modify tables. In the example above, an UPDATE operation is applied to a second table. Note that recursive insert and update operations should be avoided. The database management system terminates the operation if the maximum trigger nesting level is reached. You can avoid recursion by adding conditional logic so that the insert or update operation is exited before the maximum nesting level is reached. The same situation needs to be avoided in a network of triggers that recursively cascade through the network of triggers.

Multiple event SQL triggers

A single trigger can be defined for more than one insert, update, or delete event.

A trigger can be defined to handle one, two, or all three of the insert, update, and delete events. The only restriction is that the events must share a common BEFORE, AFTER, or INSTEAD OF triggering time. Trigger event predicates can be used within the trigger body to distinguish which event caused the trigger to be activated.

In the following example, several warning SQLSTATEs are grouped into a single trigger definition.

```
CREATE TABLE PARTS (INV_NUM INT, PART_NAME CHAR(20), ON_HAND INT, MAX_INV INT,
                    PRIMARY KEY (INV_NUM))

CREATE OR REPLACE TRIGGER INVENTORY_WARNINGS
AFTER DELETE OR INSERT OR UPDATE OF ON_HAND ON PARTS
REFERENCING NEW AS N_INV
                OLD AS O_INV
FOR EACH ROW MODE DB2SQL
BEGIN
  IF INSERTING THEN
    IF (N_INV.ON_HAND > N_INV.MAX_INV) THEN
      BEGIN
        SIGNAL SQLSTATE '75001' ('Inventory on hand exceeds maximum allowed.');
```

In the trigger body the INSERTING, UPDATING, and DELETING predicates are used to determine which event caused the trigger to activate. A distinct piece of code is executed for each of the defined events. For each event, a warning condition is handled.

In the next example, the trigger event predicates are used in an INSERT statement to generate a row for a transaction history table.

```
CREATE TABLE TRANSACTION_HISTORY(INV_NUM INT, POSTTIME TIMESTAMP,
                                  TRANSACTION_TYPE CHAR(1))

CREATE TRIGGER SET_TRANS_HIST
AFTER INSERT OR UPDATE OR DELETE ON PARTS
REFERENCING NEW AS N
                OLD AS O
FOR EACH ROW MODE DB2SQL
BEGIN
  INSERT INTO TRANSACTION_HISTORY VALUES (
    CASE
      WHEN INSERTING OR UPDATING
      THEN N.INV_NUM
      WHEN DELETING
      THEN O.INV_NUM
    END,
    CURRENT_TIMESTAMP,
    CASE
      WHEN INSERTING
      THEN 'I'
      WHEN UPDATING
      THEN 'U'
      WHEN DELETING
      THEN 'D'
    END
  );
END
```

For this trigger, the same routine logic is used by all three trigger events. The trigger event predicates are used to determine whether the inventory number needs to be read from the before or after row value and a second time to set the type of transaction.

INSTEAD OF SQL triggers

An INSTEAD OF trigger is an SQL trigger that is processed “instead of” an SQL UPDATE, DELETE or INSERT statement. Unlike SQL BEFORE and AFTER triggers, an INSTEAD OF trigger can be defined only on a view, not a table.

An INSTEAD OF trigger allows a view, which is not inherently insertable, updatable, or deletable, to be inserted into, updated, or deleted from. See [CREATE VIEW](#) for more information about deleteable, updatable, and insertable views.

After an SQL INSTEAD OF trigger is added to a view, the view which previously could only be read from can be used as the target of an insert, update, or delete operation. The INSTEAD OF trigger defines the operations which need to be performed to maintain the view.

A view can be used to control access to tables. INSTEAD OF triggers can simplify the maintenance of access control to tables.

Using an INSTEAD OF trigger

The definition of the following view V1 is updatable, deletable, and insertable:

```
CREATE TABLE T1 (C1 VARCHAR(10), C2 INT)
CREATE VIEW V1(X1) AS SELECT C1 FROM T1 WHERE C2 > 10
```

For the following insert statement, C1 in table T1 will be assigned a value of 'A'. C2 will be assigned the NULL value. The NULL value would cause the new row to not match the selection criteria C2 > 10 for the view V1.

```
INSERT INTO V1 VALUES('A')
```

Adding the INSTEAD OF trigger IOT1 can provide a different value for the row that will be selected by the view:

```
CREATE TRIGGER IOT1 INSTEAD OF INSERT ON V1
REFERENCING NEW AS NEW_ROW
FOR EACH ROW MODE DB2SQL
INSERT INTO T1 VALUES(NEW_ROW.X1, 15)
```

Making a view deletable

The definition of the following join view V3 is not updatable, deletable, or insertable:

```
CREATE TABLE A (A1 VARCHAR(10), A2 INT)
CREATE VIEW V1(X1) AS SELECT A1 FROM A

CREATE TABLE B (B1 VARCHAR(10), B2 INT)
CREATE VIEW V2(Y1) AS SELECT B1 FROM B

CREATE VIEW V3(Z1, Z2) AS SELECT V1.X1, V2.Y1 FROM V1, V2 WHERE V1.X1 = 'A' AND V2.Y1 > 'B'
```

Adding the INSTEAD OF trigger IOT2 makes the view V3 deletable:

```
CREATE TRIGGER IOT2 INSTEAD OF DELETE ON V3
REFERENCING OLD AS OLD_ROW
FOR EACH ROW MODE DB2SQL
BEGIN
    DELETE FROM A WHERE A1 = OLD_ROW.Z1;
    DELETE FROM B WHERE B1 = OLD_ROW.Z2;
END
```

With this trigger, the following DELETE statement is allowed. It deletes all rows from table A having an A1 value of 'A', and all rows from table B having a B1 value of 'X'.

```
DELETE FROM V3 WHERE Z1 = 'A' AND Z2 = 'X'
```

INSTEAD OF triggers with views defined on views

The following definition of view V2 defined on V1 is not inherently insertable, updatable, or deletable:

```
CREATE TABLE T1 (C1 VARCHAR(10), C2 INT)
CREATE TABLE T2 (D1 VARCHAR(10), D2 INT)
CREATE VIEW V1(X1, X2) AS SELECT C1, C2 FROM T1
UNION SELECT D1, D2 FROM T2

CREATE VIEW V2(Y1, Y2) AS SELECT X1, X2 FROM V1
```

Adding the INSTEAD OF trigger IOT1 to V1 does not make V2 updatable:

```
CREATE TRIGGER IOT1 INSTEAD OF UPDATE ON V1
REFERENCING OLD AS OLD_ROW NEW AS NEW_ROW
FOR EACH ROW MODE DB2SQL
BEGIN
  UPDATE T1 SET C1 = NEW_ROW.X1, C2 = NEW_ROW.X2 WHERE
    C1 = OLD_ROW.X1 AND C2 = OLD_ROW.X2;
  UPDATE T2 SET D1 = NEW_ROW.X1, D2 = NEW_ROW.D2 WHERE
    D1 = OLD_ROW.X1 AND D2 = OLD_ROW.X2;
END
```

View V2 remains not updatable since the original definition of view V2 remains not updatable.

Using INSTEAD OF triggers with BEFORE and AFTER triggers

The addition of an INSTEAD OF trigger to a view does not cause any conflicts with BEFORE and AFTER triggers defined on the base tables:

```
CREATE TABLE T1 (C1 VARCHAR(10), C2 DATE)
CREATE TABLE T2 (D1 VARCHAR(10))

CREATE TRIGGER AFTER1 AFTER DELETE ON T1
REFERENCING OLD AS OLD_ROW
FOR EACH ROW MODE DB2SQL
  DELETE FROM T2 WHERE D1 = OLD_ROW.C1

CREATE VIEW V1(X1, X2) AS SELECT SUBSTR(T1.C1, 1, 1), DAYOFWEEK_ISO(T1.C2) FROM T1

CREATE TRIGGER IOT1 INSTEAD OF DELETE ON V1
REFERENCING OLD AS OLD_ROW
FOR EACH ROW MODE DB2SQL
  DELETE FROM T1 WHERE C1 LIKE (OLD_ROW.X1 CONCAT '%')
```

Any delete operations for view V1 result in the AFTER DELETE trigger AFTER1 being activated also because trigger IOT1 performs a delete on table T1. The delete for table T1 causes the AFTER1 trigger to be activated.

Dependent views and INSTEAD OF triggers

When adding an INSTEAD OF trigger to a view, if the view definition references views that also have INSTEAD OF triggers defined, you should define INSTEAD OF triggers for all three operations, UPDATE, DELETE, and INSERT, to avoid confusion on what capabilities the view being defined contains versus what the capabilities of any dependent views have.

Handlers in SQL triggers

A handler in an SQL trigger gives the SQL trigger the ability to recover from an error or log information about an error that has occurred while processing the SQL statements in the trigger routine body.

In the following example, there are two handlers defined: one to handle the overflow condition and a second handler to handle SQL exceptions.

```
CREATE TABLE ExcessInventory(Description VARCHAR(50), ItemWeight SMALLINT)
CREATE TABLE YearToDateTotals(TotalWeight SMALLINT)
CREATE TABLE FailureLog(Item VARCHAR(50), ErrorMessage VARCHAR(50), ErrorCode INT)
```

```

CREATE TRIGGER InventoryDeleteTrigger
AFTER DELETE ON ExcessInventory
REFERENCING OLD AS old_row
FOR EACH ROW MODE DB2ROW
BEGIN
    DECLARE sqlcode INT;
    DECLARE invalid_number condition FOR '22003';
    DECLARE exit handler FOR invalid_number
    INSERT INTO FailureLog VALUES(old_row.Description,
    'Overflow occurred in YearToDateTotals', sqlcode);
    DECLARE exit handler FOR sqlexception
    INSERT INTO FailureLog VALUES(old_row.Description,
    'SQL Error occurred in InventoryDeleteTrigger', sqlcode);
    UPDATE YearToDateTotals SET TotalWeight=TotalWeight +
    old_row.itemWeight;
END

```

First, the current values for the tables are initialized.

```

INSERT INTO ExcessInventory VALUES('Desks',32500)
INSERT INTO ExcessInventory VALUES('Chairs',500)
INSERT INTO YearToDateTotals VALUES(0)

```

When the first SQL delete statement below is executed, the ItemWeight for the item "Desks" is added to the column total for TotalWeight in the table YearToDateTotals. When the second SQL delete statement is executed, an overflow occurs when the ItemWeight for the item "Chairs" is added to the column total for TotalWeight, as the column only handles values up to 32767. When the overflow occurs, the invalid_number exit handler is executed and a row is written to the FailureLog table. The sqlexception exit handler runs, for example, if the YearToDateTotals table was deleted by accident. In this example, the handlers are used to write a log so that the problem can be diagnosed at a later time.

```

DELETE FROM ExcessInventory WHERE Description='Desks'
DELETE FROM ExcessInventory WHERE Description='Chairs'

```

SQL trigger transition tables

An SQL trigger might need to refer to all of the affected rows for an SQL insert, update, or delete operation. For example, a trigger needs to apply aggregate functions, such as MIN or MAX, to a specific column of the affected rows. The OLD_TABLE and NEW_TABLE transition tables can be used for this purpose.

In the following example, the trigger applies the aggregate function MAX to all of the affected rows of the table StudentProfiles.

```

CREATE TABLE StudentProfiles(StudentsName VARCHAR(125),
    StudentsYearInSchool SMALLINT, StudentsGPA DECIMAL(5,2))

CREATE TABLE CollegeBoundStudentsProfile
    (YearInSchoolMin SMALLINT, YearInSchoolMax SMALLINT, StudentGPAMin
    DECIMAL(5,2), StudentGPAMax DECIMAL(5,2))

CREATE TRIGGER UpdateCollegeBoundStudentsProfileTrigger
AFTER UPDATE ON StudentProfiles
REFERENCING NEW_TABLE AS ntable
FOR EACH STATEMENT MODE DB2SQL
BEGIN
    DECLARE maxStudentYearInSchool SMALLINT;
    SET maxStudentYearInSchool =
    (SELECT MAX(StudentsYearInSchool) FROM ntable);
    IF maxStudentYearInSchool >
    (SELECT MAX (YearInSchoolMax) FROM
    CollegeBoundStudentsProfile) THEN
        UPDATE CollegeBoundStudentsProfile SET YearInSchoolMax =
        maxStudentYearInSchool;
    END IF;
END

```

In the preceding example, the trigger is processed a single time following the processing of a triggering update statement because it is defined as a FOR EACH STATEMENT trigger. You will need to consider the processing overhead required by the database management system for populating the transition tables when you define a trigger that references transition tables.

External triggers

For an external trigger, the program that contains the set of trigger actions can be defined in any supported high-level language that creates a *PGM object.

The trigger program can have SQL embedded in it. To define an external trigger, you must create a trigger program and add it to a table using the Add Physical File Trigger (ADDPFTRG) CL command or you can add it using System i Navigator. To add a trigger to a table, you must do the following things:

- Identify the table.
- Identify the kind of operation.
- Identify the program that performs the actions that you want.

Related tasks

[Triggering automatic events in your database](#)

Varying length parameter lists for external procedures and functions

To determine the number of parameters passed to an ILE service program, external procedures and functions written in ILE RPG can use the %PARMS built-in function and all ILE languages can use the ILE _NPMPARMLISTADDR built-in function.

When a procedure within an ILE service program is written to accept a varying number of input parameters, SQL procedures and functions that call the program set the operational descriptor to indicate the parameter count. This number can be relied on by the ILE service program to determine the parameter count.

In the following example, two SQL functions are defined to use the same entry point name in an RPG service program, each passing a different number of parameters. This same service program could be called from many other ILE programs. The ILE RPG %PARMS built-in function is used to determine how many parameters are passed.

To avoid the need for additional SQL parameters, using PARAMETER STYLE GENERAL is recommended on the routine definitions.

```
CREATE FUNCTION RFUNC1 (P1 CHAR(5))
  RETURNS INT
  LANGUAGE RPGLE
  PARAMETER STYLE GENERAL
  EXTERNAL NAME 'TSTLIB/TSTSRVPGM(RPGPGM1) '

CREATE FUNCTION RFUNC2 (P1 CHAR(5),
                       P2 CHAR(10))
  RETURNS INT
  LANGUAGE RPGLE
  PARAMETER STYLE GENERAL
  EXTERNAL NAME 'TSTLIB/TSTSRVPGM(RPGPGM1) '
```

In the RPG code, the number of parameters can be obtained by using the %PARMS built-in function.

```
DCL-PROC RPGPGM1 EXPORT;
DCL-PI *N INT(10);
  P1 CHAR(5)  CONST OPTIONS(*NOPASS);
  P2 CHAR(10) CONST OPTIONS(*NOPASS);
END-PI;
  DCL-S nbr INT(10);
  DCL-S result INT(10);
  nbr = %PARMS;
  // logic can use the number of parameters to determine how to calculate the result
  RETURN result;
END-PROC;
```

For other ILE languages, this information is available by using the _NPMPARMLISTADDR built-in function.

Using the INCLUDE statement

The INCLUDE statement can be used in SQL procedures, functions, and triggers to allow reuse of common code. There is no limit to the number of INCLUDE statements that can be used within a single routine body.

When SQL procedures, functions, or triggers are created, Db2 for i generates ILE C code that is precompiled and bound into a program or service program. The INCLUDE statement can be used within SQL procedures, functions, and triggers to include source that is either strictly SQL code or ILE C code.

INCLUDE SQL code

Including SQL allows you to share common declarations, handlers, or routine body code. The INCLUDE statement is replaced with the content of the include file. You must embed the INCLUDE statement at a statement boundary and the source in the include file must be valid at the point where it is included. For example, you can only include declarations in the routine at a point where declarations are allowed.

The resulting source after all the SQL includes are processed is used to create the procedure, function, or trigger. If the content of an include causes an SQL syntax error, the error message will be associated with the position of the INCLUDE statement. If you are unable to determine the cause of the error within the included source, you can temporarily copy the include source into the routine and request the create again.

INCLUDE C code

Including C code directly in a routine body allows you to easily interface with system APIs and other low level ILE code. It can reduce the need to create external procedures and functions to perform these types of operations.

The following are some best practices when including C code in an SQL procedure, function, or trigger.

- Use an open brace ({) at the start of the C code and a close brace (}) at the end of the C code. This will allow the C code to be inserted cleanly into the routine or trigger. Without the braces, some C code will not work properly (such as declaring local variables).
- Use a label for an SQL compound statement so that the C code can easily reference the variable name. The variable name to use in the C code will be *label-name.variable-name*. Procedure and function parameters can be referenced as *routine-name.variable-name*.
- When an SQL variable is referenced within C code, the C code must be aware of the data type of the SQL variable to make sure it is referenced correctly.
- Check for null values within the SQL code rather than in the C code whenever possible. Checking SQL indicator variables within the C code is difficult due to the generated indicator names. If you need to check for a null value within C code, assign the indicator value to an SQL variable to be used in the C code.
- To return an error condition from the C code, assign the error information to an SQL variable.

If C code directly checks an indicator value or is written assuming some other specific code generation from the SQL procedure parser, that code could potentially stop working in the future if the SQL procedure parser needs to change the code generation. Use the best practices provided to write the C code so it is as general as possible.

Example of directly calling a C interface

This example creates a procedure named LPRINTF which accepts a VARCHAR parameter. The body of the procedure writes the input parameter to the job log using the Qp0zLprintf interface. Notice that checking the input parameter for the null value is done in the SQL code. When C code is included, the INCLUDE statement must explicitly specify the library where the source file is located. Using *LIBL is not supported.

In this example, you can also see how you would supply additional bind information. If this weren't a built-in C routine, you would need to provide the bind information using the SET OPTION. Any parameter values supplied on the BINDOPT will be used during the bind step during the creation of the C program.

```
CREATE OR REPLACE PROCEDURE LPRINTF(Print_string VARCHAR(1000))
-- SET OPTION BINDOPT = 'BNDSRVPGM(QSYS/QP0ZCPA)'
BEGIN
  IF Print_string IS NOT NULL THEN
    INCLUDE MYLIB/QCSRC(MYLPRINTF);
  END IF;
END;
```

This is the content of MYLIB/QCSRC(MYLPRINTF). Observe that this code is aware that the input parameter is qualified with the procedure name. It also knows that the parameter is a varying length character, so correctly references the length and the data parts of the generated declaration.

```
{
  /* declare prototype for Qp0zLprintf */
  extern int Qp0zLprintf (char *format, ...);

  /* print input parameter to job log */
  Qp0zLprintf("%.*s\n", LPRINTF.PRINT_STRING.LEN, LPRINTF.PRINT_STRING.DAT);
}
```

Example of directly calling a C interface with different parameter types

The previous example showed how tightly connected the C code and SQL need to be when they are compiled as a unit. Sometimes you need access to C code just as utility procedures. In this next example, the C code is wrapped in an SQL procedure that can be called from any SQL routine or trigger. It would be easy to modify these definitions to be functions with the same names that get invoked based on the data type of the input argument.

These procedures each print the value of an input variable to the job log. The first three handle CHAR, VARCHAR, and CLOB as input type. The fourth procedure prints a CLOB variable, but it uses a return code variable ERROR_VAR to indicate if an error occurred during the print of the variable. Following each procedure definition is the C code that is included.

Each of these procedures are written to provide the included C code a predictable variable name to use.

This procedure prints a CHAR variable to the job log.

```
CREATE OR REPLACE PROCEDURE PRINT_CHAR (Print_string CHAR(100))
BEGIN
  IF Print_string IS NOT NULL THEN
    LPRINTF: BEGIN
      DECLARE C_STRING CHAR(100);
      SET C_STRING = Print_string;
      INCLUDE MYLIB/QCSRC(CPRCHAR);
    END;
  END IF;
END;
```

This is the content of MYLIB/QCSRC(CPRCHAR).

```
{
  /* declare prototype for Qp0zLprintf */
  extern int Qp0zLprintf (char *format, ...);

  /* print CHAR variable to job log */
  Qp0zLprintf("%.*s\n", sizeof(LPRINTF.C_STRING), LPRINTF.C_STRING);
}
```

This procedure prints a VARCHAR variable to the job log.

```
CREATE OR REPLACE PROCEDURE PRINT_VARCHAR (Print_string IN VARCHAR(1000))
BEGIN
  IF Print_string IS NOT NULL THEN
    LPRINTF: BEGIN
      DECLARE C_STRING VARCHAR(1000);
      SET C_STRING = Print_string;
```

```

        INCLUDE MYLIB/QCSRC(CPRVARCHAR);
    END;
END IF;
END;

```

This is the content of MYLIB/QCSRC(CPRVARCHAR).

```

{
/* declare prototype for Qp0zLprintf */
extern int  Qp0zLprintf (char *format, ...);

/* print VARCHAR variable to job log */
Qp0zLprintf("%.*s\n", LPRINTF.C_STRING.LEN, LPRINTF.C_STRING.DAT);
}

```

This procedure prints a CLOB variable to the job log. You must have QSYSINC in your library list to find the C #includes.

```

CREATE OR REPLACE PROCEDURE PRINT_CLOB (Print_string CLOB(10000))
SET OPTION COMMIT = *CHG
BEGIN
IF Print_string IS NOT NULL THEN
LPRINTF: BEGIN
DECLARE C_STRING CLOB(10000);
SET C_STRING = Print_string;
INCLUDE MYLIB/QCSRC(CPRCLOB);
END;
END IF;
END;

```

This is the content of QCSRC(CPRCLOB).

```

{
#include "qp0ztrc.h"                /* for Qp0zLprintf          */
#include "sqludf.h"                 /* for sqludf_length/sqludf_substr */

long lob_length;
int rc;

rc = sqludf_length(&LPRINTF.C_STRING, &lob_length);
if ((rc == 0) && (lob_length > 0)) {
unsigned char* lob = malloc(lob_length);

rc = sqludf_substr(&LPRINTF.C_STRING, 1, lob_length,
lob, &lob_length);

if (rc == 0) {
/* print CLOB variable to job log */
Qp0zLprintf("%.*s\n", lob_length, lob);
}
free(lob);
}
}
}

```

This procedure prints a CLOB variable to the job log and handles a return code. You must have QSYSINC in your library list to find the C #includes.

```

CREATE OR REPLACE PROCEDURE PRINT_CLOB_WITH_RC (Print_string IN CLOB(1M))
SET OPTION COMMIT = *CHG
BEGIN
IF Print_string IS NOT NULL THEN
LPRINTF: BEGIN
DECLARE C_STRING CLOB(1M);
DECLARE ERROR_VAR INT;

SET C_STRING = Print_string;
SET ERROR_VAR = 0;
INCLUDE MYLIB/QCSRC(CPRCLOBEC);
IF ERROR_VAR <> 0 THEN
BEGIN
DECLARE MSG_STRING VARCHAR(100);
SET MSG_STRING = 'Failed in PRINT_CLOB_WITH_RC, ERROR CODE'
CONCAT ERROR_VAR;
SIGNAL SQLSTATE 'XXXXX' SET MESSAGE_TEXT = MSG_STRING;
END;
END IF;
END;

```

```

END IF;
END;

```

This is the content of QCSRC(CPRCLOBEC).

```

{
#include "qp0ztrc.h"          /* for Qp0zLprintf          */
#include "sqludf.h"          /* for sqludf_length/sqludf_substr */

long lob_length;
int rc;

rc = sqludf_length(&LPRINTF.C_STRING, &lob_length);
if (rc == 0) {
    if (lob_length > 0) {
        unsigned char* lob = malloc(lob_length);

        rc = sqludf_substr(&LPRINTF.C_STRING, 1, lob_length,
                           lob, &lob_length);

        if (rc == 0) {
            /* print CLOB variable to job log */
            Qp0zLprintf("%.*s\n", lob_length, lob);
        }
        else {
            LPRINTF.ERROR_VAR = rc; /* indicate error */
        }
        free(lob);
    }
}
else {
    LPRINTF.ERROR_VAR = rc; /* indicate error */
}
}

```

Example using SQL and C includes:

Now we will create a procedure that includes a common SQL error handler. The include for the handler is located in the source after any local declarations and before the routine body logic starts, which is where all handlers must be defined.

```

CREATE OR REPLACE PROCEDURE DROP_TABLE (Drop_schema IN VARCHAR(258),
                                         Drop_table IN VARCHAR(258))
BEGIN
    DECLARE STATEMENT_TEXT VARCHAR(1000);
    INCLUDE SQL MYLIB/QSQLSRC(SQL_INUSE);
    SET STATEMENT_TEXT = 'DROP TABLE ' || Drop_schema || '.' || Drop_table;
    EXECUTE IMMEDIATE STATEMENT_TEXT;
END;

```

This is the content of QSQLSRC(SQL_INUSE). It uses two IBM i services to log information about the lock failure and uses built-in global variables to indicate the failing routine. The logged information can be queried after the failure to examine the lock information. The handler also uses the PRINT_VARCHAR procedure to log a message to the job log.

```

--
-- Common handler for SQL0913, object in use.
--
-- This handler retrieves the message tokens for the error to determine
-- the table name encountering the error.
-- It gets the most recent 5 rows from the joblog and saves them in a table.
-- It uses the name of the table to find the lock status information
-- and saves the lock information in a different table.
-- In both tables, rows are tagged with the routine name that
-- received the error and a common timestamp.
-- Finally, it prints a notification to the joblog.
--
-- This handler assumes the following two tables have been created:
-- CREATE TABLE APPLIB.HARD_TO_DEBUG_PROBLEMS AS
-- (SELECT SYSIBM.ROUTINE_SCHEMA, SYSIBM.ROUTINE_SPECIFIC_NAME,
--         CURRENT_TIMESTAMP AS LOCK_ERROR_TIMESTAMP,
--         X.* FROM TABLE(QSYS2.JOBLOG_INFO('*')) X) WITH NO DATA;
-- CREATE TABLE APPLIB.HARD_TO_DEBUG_LOCK_PROBLEMS AS
-- (SELECT SYSIBM.ROUTINE_SCHEMA, SYSIBM.ROUTINE_SPECIFIC_NAME,
--         CURRENT_TIMESTAMP AS LOCK_ERROR_TIMESTAMP,
--         X.* FROM QSYS2.OBJECT_LOCK_INFO X) WITH NO DATA;
--

```

```

DECLARE CONTINUE HANDLER FOR SQLSTATE '57033'
BEGIN
  DECLARE SCHEMA_NAME VARCHAR(128);
  DECLARE TABLE_NAME VARCHAR(128);
  DECLARE DOT_LOCATION INTEGER;
  DECLARE MSG_TOKEN VARCHAR(1000);
  DECLARE ERROR_TIMESTAMP TIMESTAMP;

  GET DIAGNOSTICS CONDITION 1 MSG_TOKEN = DB2_ORDINAL_TOKEN_1;
  SET DOT_LOCATION = LOCATE_IN_STRING(MSG_TOKEN, '.');
  SET SCHEMA_NAME = SUBSTR(MSG_TOKEN, 1, DOT_LOCATION - 1);
  SET TABLE_NAME = SUBSTR(MSG_TOKEN, DOT_LOCATION + 1,
    LENGTH(MSG_TOKEN) - DOT_LOCATION);
  SET ERROR_TIMESTAMP = CURRENT_TIMESTAMP;

  INSERT INTO APPLIB.HARD_TO_DEBUG_PROBLEMS
  SELECT SYSIBM.ROUTINE_SCHEMA, SYSIBM.ROUTINE_SPECIFIC_NAME,
    ERROR_TIMESTAMP, J.*
  FROM TABLE(QSYS2.JOBLOG_INFO('*')) J
  ORDER BY A.ORDINAL_POSITION DESC
  FETCH FIRST 5 ROWS ONLY;

  INSERT INTO APPLIB.HARD_TO_DEBUG_LOCK_PROBLEMS
  SELECT SYSIBM.ROUTINE_SCHEMA, SYSIBM.ROUTINE_SPECIFIC_NAME,
    ERROR_TIMESTAMP, L.*
  FROM QSYS2.OBJECT_LOCK_INFO L
  WHERE OBJECT_SCHEMA = SCHEMA_NAME AND
    OBJECT_NAME = TABLE_NAME;

  CALL PRINT_VARCHAR('Unexpected lock on table ' CONCAT MSG_TOKEN
    CONCAT '. Information logged to debug tables.');
```

END;

Array support in SQL procedures and functions

SQL procedures and SQL scalar functions support parameters and variables of array types. Arrays are a convenient way of passing transient collections of data between an application and a stored procedure, between two stored procedures, or on a function invocation.

Within SQL procedures and functions, arrays can be manipulated like arrays are in conventional programming languages. Furthermore, arrays are integrated within the relational model in such a way that data represented as an array can be easily converted into a table and data in a table column can be aggregated into an array. The examples below illustrate several operations on arrays.

Example 1

This example shows two procedures, `sum` and `main`. Procedure `main` creates an array of 6 integers using an array constructor. It then passes the array to procedure `sum`, which computes the sum of all the elements in the input array and returns the result to `main`. Procedure `sum` illustrates the use of array subindexing and of the `CARDINALITY` function, which returns the number of elements in an array.

```

CREATE TYPE intArray AS INTEGER ARRAY[100]

CREATE PROCEDURE sum(IN inList intArray, OUT total INTEGER)
BEGIN
  DECLARE i, n INTEGER;

  SET n = CARDINALITY(inList);

  SET i = 1;
  SET total = 0;

  WHILE (i <= n) DO
    SET total = total + inList[i];
    SET i = i + 1;
  END WHILE;

  END

CREATE PROCEDURE main(OUT arrayTotal INTEGER)
BEGIN
  DECLARE numList intArray;

  SET numList = ARRAY[1,2,3,4,5,6];
```

```
CALL sum(numList,arrayTotal);
END
```

Example 2

This example is similar to Example 1 but uses one procedure, main, to invoke a function named sum.

```
CREATE TYPE intArray AS INTEGER ARRAY[100]

CREATE FUNCTION sum(inList intArray) RETURNS INTEGER
BEGIN
  DECLARE i, n, total INTEGER;

  SET n = CARDINALITY(inList);

  SET i = 1;
  SET total = 0;

  WHILE (i <= n) DO
    SET total = total + inList[i];
    SET i = i + 1;
  END WHILE;

  RETURN total;

END

CREATE PROCEDURE main(OUT arrayTotal INTEGER)
BEGIN
  DECLARE numList intArray;

  SET numList = ARRAY[1,2,3,4,5,6];

  SET arrayTotal = sum(numList);

END
```

Example 3

In this example, we use two array data types (intArray and stringArray), and a persons table with two columns (id and name). Procedure processPersons adds three additional persons to the table, and returns an array with the person names that contain the letter 'a', ordered by id. The ids and names of the three persons to be added are represented as two arrays (ids and names). These arrays are used as arguments to the UNNEST function, which turns the arrays into a two-column table, whose elements are then inserted into the persons table. Finally, the last set statement in the procedure uses the ARRAY_AGG aggregate function to compute the value of the output parameter.

```
CREATE TYPE intArray AS INTEGER ARRAY[100]

CREATE TYPE stringArray AS VARCHAR(10) ARRAY[100]

CREATE TABLE persons (id INTEGER, name VARCHAR(10))

INSERT INTO persons VALUES(2, 'Tom'),
                           (4, 'Gina'),
                           (1, 'Kathy'),
                           (3, 'John')

CREATE PROCEDURE processPersons(OUT witha stringArray)
BEGIN
  DECLARE ids intArray;
  DECLARE names stringArray;

  SET ids = ARRAY[5,6,7];
  SET names = ARRAY['Denise', 'Randy', 'Sue'];

  INSERT INTO persons(id, name)
    (SELECT t.i, t.n FROM UNNEST(ids, names) AS t(i, n));

  SET witha = (SELECT ARRAY_AGG(name ORDER BY id)
              FROM persons
```

END

```
WHERE name LIKE '%a%');
```

Debugging an SQL routine

By specifying `SET OPTION DBGVIEW = *SOURCE` in the `CREATE PROCEDURE`, `CREATE FUNCTION`, or `CREATE TRIGGER` statement, you can debug the generated program or module at the SQL statement level.

You can also specify `DBGVIEW(*SOURCE)` as a parameter on a `RUNSQLSTM` command and it will apply to all routines within the `RUNSQLSTM`.

The source view will be created by the system from your original routine body into source file `QSQDSRC` in the routine library. If the library cannot be determined, `QSQDSRC` is created in `QTEMP`. If the specific name is a valid system name, it is used as the name of the member in the `QSQDSRC` file. If the specific name is not a valid system name, a unique name is generated using the rules for generating system table names. If the `QSQDSRC` file already has a member with the name, regardless of the routine it represents, the member is overlaid. The source view is not saved with the program or service program. The source is broken into lines that correspond to places you can stop in debug. The text, including parameter and variable names, is folded to uppercase. Delimited names and character literals are not folded to uppercase.

You can step through an SQL routine in debug using the SQL Object Processor Root View. Each step instruction will take you to the next SQL statement, not the next underlying generated C statement. This makes it easy to follow the flow of the routine logic.

SQL routines can be debugged using either the SQL Object Processor Root view or the ILE C listing view. The debugger can be used to evaluate both SQL variables and C variables in the generated program or service program. The preferred approach is to debug using the SQL Object Processor Root view, but the ILE C listing view can be used as necessary to obtain additional execution information.

SQL Object Processor Root View

This view uses the routine source in `QSQDSRC`. To evaluate an SQL variable, add the prefix `'%%'` to the variable name to indicate the name represents an SQL variable. Any SQL variable must be prefixed with `'%%'` when it is referenced in a debugger command. SQL variable names are not case sensitive. Both undelimited and delimited identifiers can be referenced. When an SQL variable name is specified, the debugger will determine which C variable represents the SQL variable and then display the name and contents of the corresponding C variable. When an SQL parameter or variable which has an indicator is referenced, the debugger will return `'NULL'` if the indicator is set to indicate the null value.

There is no need to qualify a variable name unless there is ambiguity. In that case, the variable should be qualified by the label of its containing compound SQL block to avoid the ambiguity. C variables can be referenced while debugging in the SQL Object Processor view. A variable name without the prefix `'%%'` is considered to be a C variable.

ILE C listing view

This view uses the generated C source for the SQL routine.

All variables and parameters are generated as part of a structure. The structure name must be used when evaluating a variable in debug. Variables are qualified by the current label name. Parameters are qualified by the procedure or function name. Transition variables in a trigger are qualified by the appropriate correlation name. It is highly recommended that you specify a label name for each compound statement or `FOR` statement. If you don't specify one, the system will generate one for you. This will make it nearly impossible to evaluate variables. Remember that all variables and parameters must be evaluated as an uppercase name. You can also evaluate the name of the structure. This will show you all the variables within the structure. If a variable or parameter is nullable, the indicator for that variable or parameter immediately follows it in the structure.

Because SQL routines are generated in C, there are some rules for C that affect SQL source debug. Delimited names that are specified in the SQL routine body cannot be specified in C. Names are generated

for these names, which again makes it difficult to debug or evaluate them. In order to evaluate the contents of any character variable, specify an * prior to the name of the variable.

Since the system generates indicators for most variable and parameter names, there is no way to check directly to see if a variable has the SQL null value. Evaluating a variable will always show a value, even if the indicator is set to indicate the null value.

SQL variables cannot be directly referenced (using the '%' prefix) while debugging in the ILE C view.

In order to determine if a handler is getting called, set a breakpoint on the first statement within the handler. Variables that are declared in a compound statement or FOR statement within the handler can be evaluated.

SQL array debug

The SQL array data type, which is only supported in SQL procedures and SQL functions, has special debugging rules since the array variables do not have permanent storage in the generated C program. Unlike C arrays, SQL arrays are 1 based. To display the fifth element of the array, specify array index 5 on the EVAL command (EVAL TSTARR.ABC[5]). Specifying an array variable name without specifying an array index is not supported; this will result in a variable not found error. To see a range of values in the array, an EVAL command with array index ranges can be used. For example, to see the first 25 elements in an array, EVAL TSTARR.ABC[1..25]. The EVAL command will indicate when an array variable has the NULL value. An expression containing a reference to an array variable that is NULL evaluates to NULL. The numeric array types can be used in expressions; the other types cannot. The non-prefixed string types will be displayed as a string, not a pointer.

Not all debug commands support the SQL array type. They cannot be used on the left side of an assignment (EVAL TSTARR.ABC[5] = 3). They cannot be used as the target of the '&' address operator (EVAL &TSTARR.ABC[3]). Arrays cannot be used with the WATCH debug command, either. Array variables will not be displayed by the EVAL %LOCALVARS command because they are not in the debug symbol table.

Obfuscating an SQL routine or SQL trigger

SQL functions, procedures, and triggers can be obfuscated so that their routine body logic and statements are not visible on a system.

Once testing of an SQL procedure, function, or trigger is complete, you can obfuscate the text so it is not readable to anyone on the system. To do this, use the WRAP SQL function or the CREATE_WRAPPED SQL procedure. Both are system provided routines in schema SYSIBMADM.

The WRAP scalar function returns an obfuscated form of the SQL statement that was provided as an input argument. The CREATE_WRAPPED procedure will obfuscate the SQL statement and then execute it.

When an obfuscated routine is created, the routine body will not be visible in the catalog tables or in the program object. No listing will be generated and any temporary files used during creation of the routine will be deleted. The routine will always be created as not debuggable so no debug view containing the routine content will exist.

The Generate SQL feature of System i Navigator has an option to make it easy to obfuscate many SQL routines at one time.

Once a routine is obfuscated, the program or service program object for the SQL routine can be saved and restored to other systems. It can be used as an object for the Generate SQL feature of System i Navigator. Db2 for i will understand how to process the statement correctly and it will remain obfuscated.

For example, suppose your procedure is:

```
CREATE PROCEDURE UPDATE_STAFF (  
    IN P_EmpNo CHAR(6),  
    IN P_NewJob CHAR(5),  
    IN P_Dept INTEGER)  
BEGIN  
    UPDATE STAFF  
        SET JOB = P_NewJob
```



```
WHERE DEPT = P_Dept and ID = P_EmpNo;
END;
```

After testing the procedure to make sure it works, you can generate an obfuscated form of the statement by using the WRAP function.

```
VALUES(SYSIBMADM.WRAP(
'CREATE PROCEDURE UPDATE_STAFF (
    IN P_EmpNo CHAR(6),
    IN P_NewJob CHAR(5),
    IN P_Dept INTEGER)
BEGIN
    UPDATE STAFF
    SET JOB = P_NewJob
    WHERE DEPT = P_Dept and ID = P_EmpNo;
END'
));
```

The result from this statement is a CLOB value that contains a value that looks something like the following statement. Since the timestamp is used during the obfuscation process, your result can be different every time. The value is shown here on several lines for convenience. New line characters are not allowed in the wrapped part of the statement text.

```
CREATE PROCEDURE UPDATE_STAFF ( IN P_EMPNO CHAR ( 6 ) , IN P_NEWJOB CHAR ( 5 )
, IN P_DEPT INTEGER ) WRAPPED QS007010 aacxw8p1w8FjG8pnG8VzG8FD68Fj68:H18:dY_p
B2qpdW8pdW8pdW_praqebaqaGEMj_vsPBs5b0JUuqnHVayE1_ogAlGwqz2jJCIE1dQEjt33hd5Sps
5cYGVid1uiv7vGKe0cC4CwpCibbmeMfsW3XzXWn1plyX9wun0CqqF1DqaB1
```

This is an executable SQL statement. It can be run just like the original SQL statement. Altering any of the characters that follow the WRAPPED keyword will cause the statement to fail.

To deploy this statement, the obfuscated form can be embedded in a RUNSQLSTM source member or source stream file. You need to be very careful to include exactly the characters in the obfuscated version.

A second way of obfuscating an SQL routine is to use the CREATE_WRAPPED SQL procedure:

```
CALL SYSIBMADM.CREATE_WRAPPED(
'CREATE PROCEDURE UPDATE_STAFF (
    IN P_EmpNo CHAR(6),
    IN P_NewJob CHAR(5),
    IN P_Dept INTEGER)
BEGIN
    UPDATE STAFF
    SET JOB = P_NewJob
    WHERE DEPT = P_Dept and ID = P_EmpNo;
END'
);
```

This will create the procedure and the entire SQL routine body will be obfuscated. Looking at the ROUTINE_DEFINITION column in SYSROUTINES will show the obfuscated form of the routine body, starting with the WRAPPED keyword. You must save the original routine source if you might need it for future reference since there is no way to generate the original source from the obfuscated text.

Related reference

[WRAP scalar function](#)

[CREATE_WRAPPED procedure](#)

Managing SQL and external routine objects

SQL and external functions and procedures are implemented using system programs and service programs. When managed correctly, these objects can regenerate the routine registration in the QSYS2/SYSROUTINES, QSYS2/SYSPARMS, and QSYS2/SYSROUTINEDEP system catalogs.

When an SQL procedure or function is created or altered, an ILE C program or service program is generated. In addition to containing executable statements, this object contains all the information used to define it as an SQL routine.

When an external procedure or function is created and is associated with an ILE program or service program object, information about the routine definition is saved in the *PGM or *SRVPGM object. By

successfully adding the routine information to the object, maintaining the object requires less manual effort.

The external procedure or function definition can only be saved when:

- The external program is an ILE *PGM or *SRVPGM object.
- The program or service program is not in QSYS, QSYS2, SYSIBM, SYSPROC, or SYSIBMADM.
- The program exists when the CREATE PROCEDURE or CREATE FUNCTION statement is issued and the program can be found.
- The CREATE or ALTER statement can get an exclusive lock on the program.

Message SQL7909 will be issued when an external routine is created, changed, or dropped and the *PGM or *SRVPGM could not be modified. This message includes a reason code.

When these procedure and function *PGM and *SRVPGM objects are administered like other system objects, the information saved in the object is used to maintain the SYSROUTINES and SYSPARMS catalog information. The following CL commands (and their API counterparts) will keep the catalogs in sync with the executable object for procedures and functions.

Save/Restore (SAVOBJ/RSTOBJ and SAVLIB/RSTLIB)

A row is inserted into the SYSROUTINES catalog for each routine. The EXTERNAL_NAME column contains the name of the newly restored executable object.

An SQL routine cannot be restored into QTEMP.

Create Duplicate Object (CRTDUPOBJ)

A new row is inserted into the SYSROUTINES catalog. The EXTERNAL_NAME column contains the name of the newly duplicated executable object.

Copy Library (CPYLIB)

A new row is inserted into the SYSROUTINES catalog. The EXTERNAL_NAME column contains the name of the newly duplicated executable object.

Rename Object (RNMOBJ)

The existing row in SYSROUTINES is modified. The EXTERNAL_NAME column contains the name of the renamed executable object.

Move Object (MOV OBJ)

The existing row in SYSROUTINES is modified. The EXTERNAL_NAME column contains the name of the moved executable object.

Clear Library (CLRLIB)

All rows in SYSROUTINES are deleted where the SPECIFIC_SCHEMA column matches the name of the library being cleared.

Delete Program (DLTPGM) and Delete Service Program (DLTSRVPGM)

For an SQL routine, the corresponding rows in SYSROUTINES are deleted using the SPECIFIC_NAME and SPECIFIC_SCHEMA columns. No updates are made for external routines.

Message SQL9015 will be issued when a *PGM or *SRVPGM is operated upon using a system command and the catalog entries for the associated routine(s) could not be updated.

Improving performance of procedures and functions

When creating a stored procedure or a user-defined function (UDF), the SQL procedural language processor does not always generate the most efficient code. However, you can reduce the number of database engine calls and improve performance.

Some changes are in the design of a routine and some are in the implementation. For example, differences between how the C language compiler handles host variables and the way the SQL procedural processor requires the host variables to be handled can cause many calls to the database engine. These calls are very expensive and, when done many times, can significantly degrade performance.

The IBM i 6.1 release contained significant improvements to the performance of the code generated within SQL routines. If you have SQL procedures or functions that have not been rebuilt since before IBM

i 6.1, it is recommended that you drop and recreate them to guarantee that your procedure or function is running with the improved code generation.

Another simple action which will improve the performance of SQL procedures is to use the PROGRAM TYPE SUB clause. When omitted or PROGRAM TYPE MAIN is used on the CREATE PROCEDURE (SQL) statement, an ILE C program (*PGM) is built for the procedure. PROGRAM TYPE SUB results in an ILE C service program (*SRVPGM) being built for the procedure. The use of PROGRAM TYPE SUB is most relevant for procedures that are frequently called within a performance critical application. PROGRAM TYPE SUB procedures perform better due to the fact that ILE service programs are activated a single time per activation group, while ILE programs are activated on every call. The cost of an ILE activation is related to the procedure size, complexity, number of parameters, number of variables, and the size of the parameters and variables.

The only functional difference to be noted when using PROGRAM TYPE SUB is that the QSYS2.SYSROUTINES catalog entry for the EXTERNAL_NAME column is formatted to show an export name along with the service program name.

Improving implementation of procedures and functions

These coding techniques help reduce the processing time of a function or procedure.

The following tips are especially important for functions because a function tends to be called multiple times from many different procedures:

- Use the NOT FENCED option so UDFs run in the same thread as the caller.
- Use the DETERMINISTIC option on procedures and UDFs that return the same results for identical inputs. This allows the optimizer to cache the results of a function call or order where the function is called in the execution stream to reduce the run time.
- Use the NO EXTERNAL ACTION option on UDFs that do not take an action outside the scope of the function. An example of an external action is a function that initiates a different process to fulfill a transaction request.

The use of pipelined table functions can improve performance in some situations.

- Avoid the overhead of creating and populating a temporary table by returning the results directly.
- Return only a subset of the data, rather than all the rows from a query, with the flexibility of combining SQL routine logic with the PIPE statement.

Coding techniques used for the SQL routine body can have a major impact on the runtime performance of the generated C program. By writing your routine to allow greater use of C code for assignments and comparisons, the overhead of an equivalent SQL statement is avoided. The following tips should help your routine generate more C code and fewer SQL statements.

- Declare host variables as NOT NULL when possible. This saves the generated code from having to check and set the null value flags. Do not automatically set all variables to NOT NULL. When you specify NOT NULL, you need to also give a default value. If a variable is always used in the routine, a default value might help. However, if a variable is not always used, having a default value set may cause additional initialization overhead that is not needed. A default value is best for numeric values, where an additional database call to process the assignment of the default value is not needed.
- Avoid character and date data types when possible. An example of this is a variable used as a flag with a value of 0, 1, 2, or 3. If this value is declared as a single character variable instead of an integer, it causes calls to the database engine that can be avoided.
- Use integer instead of decimal with zero scale, especially when the variable is used as a counter.
- Do not use temporary variables. Look at the following example:

```
IF M_days<=30 THEN
  SET I = M_days-7;
  SET J = 23
  RETURN decimal(M_week_1 + ((M_month_1 - M_week_1)*I)/J,16,7);
END IF
```

This example can be rewritten without the temporary variables:

```
IF M_days<=30 THEN
  Return decimal(M-week_1 + ((M_month_1 - M_week_1)* (M_days-7))/23,16,7);
END IF
```

- Combine sequences of complex SET statements into one statement. This applies to statements where C code only cannot be generated because of CCSIDs or data types.

```
SET var1 = function1(var2);
SET var2 = function2();
```

Can be rewritten into one statement:

```
SET var1 = function1(var2), var2 = function2();
```

- Simple array element assignments can be implemented in C code when only one assignment is performed in a SET statement.

```
SET array_var[1] = 10, array_var[2] = 20;
```

Should be rewritten as:

```
SET array_var[1] = 10;
SET array_var[2] = 20;
```

- Use IF () ELSE IF () ... ELSE ... constructs instead of IF (x AND y) to avoid unnecessary comparisons.
- Do as much in SELECT statements as possible:

```
SELECT A INTO Y FROM B;
SET Y=Y CONCAT 'X';
```

Rewrite this example:

```
SELECT A CONCAT 'X' INTO Y FROM B
```

- Avoid doing character or date comparisons inside of loops when not necessary. In some cases the loop can be rewritten to move a comparison to precede the loop and have the comparison set an integer variable that is used within the loop. This causes the complex expression to be evaluated only one time. An integer comparison within the loop is more efficient since it can be done with generated C code.
- Avoid setting variables that might not be used. For example, if a variable is set outside of the an IF statement, be sure that the variable will actually be used in all instances of the IF statement. If not, then set the variable only in the portion of the IF statement that is it actually used.
- Replace sections of code with a single SELECT statement when possible. Look at the following code snippet:

```
SET vnb_decimal = 4;
cdecimal:
  FOR vdec AS cdec CURSOR FOR
    SELECT nb_decimal
    FROM K$FX_RULES
    WHERE first_currency=Pi_cur1 AND second_currency=P1_cur2
    DO
      SET vnb_decimal=SMALLINT(cdecimal.nb_decimal);
    END FOR cdecimal;

  IF vnb_decimal IS NULL THEN
    SET vnb_decimal=4;
  END IF;
  SET vrate=ROUND(vrate1/vrate2,vnb_decimal);
  RETURN vrate;
```

This code snippet can be more efficient if rewritten in the following way:

```
RETURN( SELECT
  CASE
    WHEN MIN(nb_decimal) IS NULL THEN ROUND(Vrate1/Vrate2,4)
    ELSE ROUND(Vrate1/Vrate2,SMALLINT(MIN(nb_decimal)))
```

```

END
FROM K$FX_RULES
WHERE first_currency=Pi_cur1 AND second_currency=Pi_cur2);

```

- C code can only be used for assignments and comparisons of character data if the CCSIDs of both operands are the same, if one of the CCSIDs is 65535, if the CCSID is not UTF-8, and if truncation of character data is not possible. If the CCSID of the variable is not specified, the CCSID is not determined until the procedure is called. In this case, code must be generated to determine and compare the CCSID at runtime. If an alternate collating sequence is specified or if *JOB RUN is specified, C code cannot be generated for character comparisons.
- C code can only be used for assignments and comparisons of graphic data if the CCSIDs of both operands are the same, if the CCSID is not UTF-16, and if truncation of graphic data is not possible. If an alternate collating sequence is specified or if *JOB RUN is specified, C code cannot be generated for graphic comparisons.
- Use the same data type, length and scale for numeric variables that are used together in assignments. C code can only be generated if truncation is not possible.

```

DECLARE v1, v2 INT;
SET v1 = 100;
SET v1 = v2;

```

- Using identical attributes to set or retrieve array elements may result in the generation of C code for integer, character, varchar, decimal, and numeric types. Character variables that require CCSID processing can require an SQL SET statement to be generated.
- Comparisons using array elements are never generated in C. Some comparisons could result in better performance if the element value is assigned to a local variable first that can be used in the comparison.

Redesigning routines for performance

Even if you follow all of the implementation tips, a procedure or function still might not perform well. In this case, you need to look at the design of the procedure or user-defined function (UDF) and see whether there are any changes that can be made to improve the performance.

Here are the different types of design changes that you can look at.

The first change is to reduce the number of database calls or function calls that a procedure makes, a process similar to looking for blocks of code that can be converted to SQL statements. Many times you can reduce the number of calls by adding additional logic to your code.

A more difficult design change is to restructure a whole function to get the same result a different way. For example, your function uses a SELECT statement to find a route that meets a particular set of criteria and then executes that statement dynamically. By looking at the work that the function is performing, you might be able to change the logic so that the function can use a static SELECT query to find the answer, thereby improving your performance.

You should also use nested compound statements to localize exception handling and cursors. If several specific handlers are specified, code is generated to check to see if the error occurred after each statement. Code is also generated to close cursors and process savepoints if an error occurs in a compound statement. In routines with a single compound statement with multiple handlers and multiple cursors, code is generated to process each handler and cursor after every SQL statement. If you scope the handlers and cursors to a nested compound statement, the handlers and cursors are only checked within the nested compound statement.

In the following routine, code to check the SQLSTATE '22H11' error will only be generated for the statements within the lab2 compound statement. Specific checking for this error will not be done for any statements in the routine outside of the lab2 block. Code to check the SQLEXCEPTION error will be generated for all statements in both the lab1 and lab2 blocks. Likewise, error handling for closing cursor c1 will be limited to the statements in the lab2 block.

```

Lab1: BEGIN
  DECLARE var1 INT;
  DECLARE EXIT HANDLER FOR SQLEXCEPTION
    RETURN -3;

```

```

lab2: BEGIN
    DECLARE EXIT HANDLER FOR SQLSTATE '22H11'
        RETURN -1;
    DECLARE c1 CURSOR FOR SELECT col1 FROM table1;
    OPEN c1;
    CLOSE c1;
END lab2;
END Lab1

```

Because redesigning a whole routine takes a lot of effort, examine routines that are showing up as key performance bottlenecks rather than looking at the application as a whole. More important than redesigning existing performance bottlenecks is to spend time during the design of the application thinking about the performance impacts of the design. Focusing on areas of the application that are expected to be high use areas and making sure that they are designed with performance in mind saves you from having to do a redesign of those areas later.

Processing special data types

Most data types, such as INTEGER and CHARACTER, do not have any special processing characteristics. However, a few data types require special functions or locators to use them effectively.

Large objects

A large object (LOB) is a string data type with a size ranging from 0 bytes to 2 GB (GB equals 1 073 741 824 bytes).

The VARCHAR, VARGRAPHIC, and VARBINARY data types have a limit of 32 KB (where KB equals 1024 bytes) of storage. While this might be sufficient for small to medium-sized text data, applications often need to store large text documents. They might also need to store a wide variety of additional data types, such as audio, video, drawings, mixed text and graphics, and images. Some data types can store these data objects as strings of up to 2 GB.

These data types are binary large objects (BLOBs), single-byte character large objects (CLOBs), and double-byte character large objects (DBCLOBs). Each table can have a large amount of associated LOB data. Although a single row that contains one or more LOB values cannot exceed 3.5 GB, a table can contain nearly 256 GB of LOB data.

You can refer to and manipulate LOBs using host variables as you do any other data type. However, host variables use the program's storage that might not be large enough to hold LOB values, so you might need to manipulate large values in other ways. *Locators* are useful for identifying and manipulating a large object value at the database server and for extracting pieces of the LOB value. *File reference variables* are useful for physically moving a large object value (or a large part of it) to and from the client.

Large object data types

Here are the definitions of binary large objects (BLOBs), character large objects (CLOBs), and double-byte character large objects (DBCLOBs).

- Binary large objects (BLOBs) — A binary string made up of bytes with no associated code page. This data type can store binary data larger than VARBINARY (32K limit). This data type is good for storing image, voice, graphical, and other types of business or application-specific data.
- Character large objects (CLOBs) — A character string made up of single-byte characters with an associated code page. This data type is appropriate for storing text-oriented information where the amount of information can grow beyond the limits of a regular VARCHAR data type (upper limit of 32K bytes). Code page conversion of the information is supported.
- Double-byte character large objects (DBCLOBs) — A character string made up of double-byte characters with an associated code page. This data type is appropriate for storing text-oriented information where double-byte character sets are used. Again, code page conversion of the information is supported.

Large object locators

A large object (LOB) locator is a small, easily managed value that is used to refer to a much larger value.

Specifically, a LOB locator is a 4-byte value stored in a host variable that a program uses to refer to a LOB value held in the database server. Using a LOB locator, a program can manipulate the LOB value as if it were stored in a regular host variable. When you use the LOB locator, there is no need to transport the LOB value from the server to the application (and possibly back again).

The LOB locator is associated with a LOB value, not a row or physical storage location in the database. Therefore, after selecting a LOB value into a locator, you cannot perform an operation on the original row(s) or table(s) that have any effect on the value referenced by the locator. The value associated with the locator is valid until the unit of work ends, or the locator is explicitly freed, whichever comes first. The FREE LOCATOR statement releases a locator from its associated value. In a similar way, a commit or rollback operation frees all LOB locators associated with the transaction.

LOB locators can also be passed to and returned from UDFs. Within the UDF, those functions that work on LOB data can be used to manipulate the LOB values using LOB locators.

When selecting a LOB value, you have three options.

- Select the entire LOB value into a host variable. The entire LOB value is copied into the host variable.
- Select the LOB value into a LOB locator. The LOB value remains on the server; it is not copied to the host variable.
- Select the entire LOB value into a file reference variable. The LOB value is moved to an integrated file system file.

How a LOB value is used within the program can help the programmer to determine which method is best. If the LOB value is very large and is needed only as an input value for one or more subsequent SQL statements, keep the value in a locator.

If the program needs the entire LOB value regardless of the size, then there is no choice but to transfer the LOB. Even in this case, there are still options available to you. You can select the entire value into a regular or file reference host variable. You may also select the LOB value into a locator and read it piecemeal from the locator into a regular host variable.

Related reference

[LOB file reference variables](#)

File reference variables are similar to host variables except that they are used to transfer data to and from integrated file system files (not to and from memory buffers).

[Example: Using a locator to work with a CLOB value](#)

Suppose that you want your application program to retrieve a locator for a character large object (CLOB) value and then use the locator to extract data from the CLOB value.

Example: Using a locator to work with a CLOB value

Suppose that you want your application program to retrieve a locator for a character large object (CLOB) value and then use the locator to extract data from the CLOB value.

Using this method, the program allocates only enough storage for one piece of CLOB data (the size is determined by the program). In addition, the program needs to issue only one fetch call using the cursor.

How the example LOBLOC program works

The example program has three sections that work with the CLOB locator variables:

1. **Declare host variables.** CLOB locator host variables are declared.
2. **Fetch the CLOB value into the locator host variable.** A CURSOR and FETCH routine is used to obtain the location of a CLOB field in the database to a locator host variable.
3. **Free the CLOB locators.** The CLOB locators used in this example are freed, releasing the locators from their previously associated values.

Related concepts

Large object locators

A large object (LOB) locator is a small, easily managed value that is used to refer to a much larger value.

Example: LOBLOC in C

This example program, written in C, uses a locator to retrieve a CLOB value.

Note: By using the code examples, you agree to the terms of the [“Code license and disclaimer information”](#) on page 396.

```
#include <stdio.h>
#include <stdlib.h>
#include <string.h>

EXEC SQL INCLUDE SQLCA;

int main(int argc, char *argv[]) {

    EXEC SQL BEGIN DECLARE SECTION;
        char number[7];
        long deptInfoBeginLoc;
        long deptInfoEndLoc;
        SQL TYPE IS CLOB_LOCATOR resume;      [1]
        SQL TYPE IS CLOB_LOCATOR deptBuffer;
        short lobind;
        char buffer[1000]="";
        char userid[9];
        char passwd[19];
    EXEC SQL END DECLARE SECTION;

    printf( "Sample C program: LOBLOC\n" );

    if (argc == 1) {
        EXEC SQL CONNECT TO sample;
    }
    else if (argc == 3) {
        strcpy (userid, argv[1]);
        strcpy (passwd, argv[2]);
        EXEC SQL CONNECT TO sample USER :userid USING :passwd;
    }
    else {
        printf ("\nUSAGE: lobloc [userid passwd]\n\n");
        return 1;
    } /* endif */

    /* Employee A10030 is not included in the following select, because
       the lobeval program manipulates the record for A10030 so that it is
       not compatible with lobloc */

    EXEC SQL DECLARE c1 CURSOR FOR
        SELECT empno, resume FROM emp_resume WHERE resume_format='ascii'
        AND empno <> 'A00130';

    EXEC SQL OPEN c1;

    do {
        EXEC SQL FETCH c1 INTO :number, :resume :lobind; [2]
        if (SQLCODE != 0) break;
        if (lobind < 0) {
            printf ("NULL LOB indicated\n");
        } else {
            /* EVALUATE the LOB LOCATOR */
            /* Locate the beginning of "Department Information" section */
            EXEC SQL VALUES (POSSTR(:resume, 'Department Information'))
                INTO :deptInfoBeginLoc;

            /* Locate the beginning of "Education" section (end of "Dept.Info" */
            EXEC SQL VALUES (POSSTR(:resume, 'Education'))
                INTO :deptInfoEndLoc;

            /* Obtain ONLY the "Department Information" section by using SUBSTR */
            EXEC SQL VALUES(SUBSTR(:resume, :deptInfoBeginLoc,
                :deptInfoEndLoc - :deptInfoBeginLoc)) INTO :deptBuffer;

            /* Append the "Department Information" section to the :buffer var. */
            EXEC SQL VALUES(:buffer || :deptBuffer) INTO :buffer;
        } /* endif */
    } while ( 1 );
```



```

printf ("%s\n",buffer);

EXEC SQL FREE LOCATOR :resume, :deptBuffer; [3]

EXEC SQL CLOSE c1;

EXEC SQL CONNECT RESET;
return 0;
}
/* end of program : LOBLOC */

```

Example: LOBLOC in COBOL

This example program, written in COBOL, uses a locator to retrieve a CLOB value.

Note: By using the code examples, you agree to the terms of the [“Code license and disclaimer information”](#) on page 396.

```

Identification Division.
Program-ID. "lobloc".

Data Division.
Working-Storage Section.
EXEC SQL INCLUDE SQLCA END-EXEC.

EXEC SQL BEGIN DECLARE SECTION END-EXEC.
01 userid          pic x(8).
01 passwd.
   49 passwd-length pic s9(4) comp-5 value 0.
   49 passwd-name   pic x(18).
01 empnum         pic x(6).
01 di-begin-loc   pic s9(9) comp-5.
01 di-end-loc     pic s9(9) comp-5.
01 resume         USAGE IS SQL TYPE IS CLOB-LOCATOR. [1]
01 di-buffer      USAGE IS SQL TYPE IS CLOB-LOCATOR.
01 lobind        pic s9(4) comp-5.
01 buffer        USAGE IS SQL TYPE IS CLOB(1K).
EXEC SQL END DECLARE SECTION END-EXEC.

Procedure Division.
Main Section.
display "Sample COBOL program: LOBLOC".

* Get database connection information.
display "Enter your user id (default none): "
with no advancing.
accept userid.

if userid = spaces
EXEC SQL CONNECT TO sample END-EXEC
else
display "Enter your password : " with no advancing
accept passwd-name.

* Passwords in a CONNECT statement must be entered in a VARCHAR
* format with the length of the input string.
inspect passwd-name tallying passwd-length for characters
before initial " ".

EXEC SQL CONNECT TO sample USER :userid USING :passwd
END-EXEC.

* Employee A10030 is not included in the following select, because
* the lobeval program manipulates the record for A10030 so that it is
* not compatible with lobloc

EXEC SQL DECLARE c1 CURSOR FOR
SELECT empno, resume FROM emp_resume
WHERE resume_format = 'ascii'
AND empno <> 'A00130' END-EXEC.

EXEC SQL OPEN c1 END-EXEC.

Move 0 to buffer-length.

perform Fetch-Loop thru End-Fetch-Loop
until SQLCODE not equal 0.

* display contents of the buffer.

```

```

display buffer-data(1:buffer-length).

EXEC SQL FREE LOCATOR :resume, :di-buffer END-EXEC. [3]

EXEC SQL CLOSE c1 END-EXEC.

EXEC SQL CONNECT RESET END-EXEC.
End-Main.
  go to End-Prog.

Fetch-Loop Section.
EXEC SQL FETCH c1 INTO :empnum, :resume :lobind [2]
END-EXEC.

  if SQLCODE not equal 0
    go to End-Fetch-Loop.

* check to see if the host variable indicator returns NULL.
  if lobind less than 0 go to NULL-lob-indicated.

* Value exists. Evaluate the LOB locator.
* Locate the beginning of "Department Information" section.
EXEC SQL VALUES (POSSTR(:resume, 'Department Information'))
  INTO :di-begin-loc END-EXEC.

* Locate the beginning of "Education" section (end of Dept.Info)
EXEC SQL VALUES (POSSTR(:resume, 'Education'))
  INTO :di-end-loc END-EXEC.

  subtract di-begin-loc from di-end-loc.

* Obtain ONLY the "Department Information" section by using SUBSTR
EXEC SQL VALUES (SUBSTR(:resume, :di-begin-loc,
  :di-end-loc))
  INTO :di-buffer END-EXEC.

* Append the "Department Information" section to the :buffer var
EXEC SQL VALUES (:buffer || :di-buffer) INTO :buffer
END-EXEC.

  go to End-Fetch-Loop.

NULL-lob-indicated.
  display "NULL LOB indicated".

End-Fetch-Loop. exit.

End-Prog.
  stop run.

```

Indicator variables and LOB locators

For normal host variables in an application program, when selecting a NULL value into a host variable, a negative value is assigned to the indicator variable signifying that the value is NULL. In the case of LOB locators, however, the meaning of indicator variables is slightly different.

Since a locator host variable itself can never be NULL, a negative indicator variable value indicates that the LOB value represented by the LOB locator is NULL. The NULL information is kept local to the client using the indicator variable value. The server does not track NULL values with valid locators.

LOB file reference variables

File reference variables are similar to host variables except that they are used to transfer data to and from integrated file system files (not to and from memory buffers).

A file reference variable represents (rather than contains) the file, just as a LOB locator represents (rather than contains) the LOB value. Database queries, updates, and inserts may use file reference variables to store, or to retrieve, single LOB values.

For very large objects, files are natural containers. It is likely that most LOBs begin as data stored in files on the client before they are moved to the database on the server. The use of file reference variables helps move LOB data. Programs use file reference variables to transfer LOB data from the integrated file

system file directly to the database engine. To carry out the movement of LOB data, the application does not need to write utility routines to read and write files using host variables.

Note: The file referenced by the file reference variable must be accessible from (but not necessarily resident on) the system on which the program runs. For a stored procedure, this is the server.

A file reference variable has a data type of BLOB, CLOB, or DBCLOB. It is used either as the source of data (input) or as the target of data (output). The file reference variable may have a relative file name or a complete path name of the file (the latter is advised). The file name length is specified within the application program. The data length portion of the file reference variable is unused during input. During output, the data length is set by the application requester code to the length of the new data that is written to the file.

When using file reference variables there are different options on both input and output. You must choose an action for the file by setting the `file_options` field in the file reference variable structure. Choices for assignment to the field covering both input and output values are shown below.

Values (shown for C) and options when using input file reference variables are as follows:

- **SQL_FILE_READ** (Regular file) — This option has a value of 2. This is a file that can be open, read, and closed. Db2 determines the length of the data in the file (in bytes) when opening the file. Db2 then returns the length through the `data_length` field of the file reference variable structure. The value for COBOL is SQL-FILE-READ.

Values and options when using output file reference variables are as follows:

- **SQL_FILE_CREATE** (New file) — This option has a value of 8. This option creates a new file. Should the file already exist, an error message is returned. The value for COBOL is SQL-FILE-CREATE.
- **SQL_FILE_OVERWRITE** (Overwrite file) — This option has a value of 16. This option creates a new file if none already exists. If the file already exists, the new data overwrites the data in the file. The value for COBOL is SQL-FILE-OVERWRITE.
- **SQL_FILE_APPEND** (Append file) — This option has a value of 32. This option has the output appended to the file, if it exists. Otherwise, it creates a new file. The value for COBOL is SQL-FILE-APPEND.

Note: If a LOB file reference variable is used in an OPEN statement, do not delete the file associated with the LOB file reference variable until the cursor is closed.

Related concepts

Large object locators

A large object (LOB) locator is a small, easily managed value that is used to refer to a much larger value.

Integrated file system

Example: Extracting CLOB data to a file

Suppose that you need to retrieve character large object (CLOB) elements from a table into an external file.

How the example LOBFILE program works

The example program has three sections that work with the CLOB file reference variable:

1. **Declare host variables.** A CLOB file reference host variable is declared. The declaration is expanded as a structure that includes declarations for a file name, file name length, and file options.
2. **CLOB file reference host variable is set up.** The attributes of the file reference are set up. A file name without a fully declared path is, by default, placed in the user's current directory. If the path name does not begin with the forward slash (/) character, it is not qualified.
3. **Select into the CLOB file reference host variable.** The data from the `resume` field is selected into the file name that is referenced by the host variable.

Example: LOBFILE in C

This example program, written in C, extracts CLOB data from a table to an external file.

Note: By using the code examples, you agree to the terms of the [“Code license and disclaimer information”](#) on page 396.

```
#include <stdio.h>
#include <stdlib.h>
#include <string.h>
#include <sql.h>

EXEC SQL INCLUDE SQLCA;

int main(int argc, char *argv[]) {

    EXEC SQL BEGIN DECLARE SECTION;
        SQL TYPE IS CLOB_FILE resume;      [1]
        short lobind;
        char userid[9];
        char passwd[19];
    EXEC SQL END DECLARE SECTION;

    printf( "Sample C program: LOBFILE\n" );

    if (argc == 1) {
        EXEC SQL CONNECT TO sample;

    else if (argc == 3) {
        strcpy (userid, argv[1]);
        strcpy (passwd, argv[2]);
        EXEC SQL CONNECT TO sample USER :userid USING :passwd;

    else {
        printf ("\nUSAGE: lobfile [userid passwd]\n\n");
        return 1;
    } /* endif */

    strcpy (resume.name, "RESUME.TXT");    [2]
    resume.name_length = strlen("RESUME.TXT");
    resume.file_options = SQL_FILE_OVERWRITE;

    EXEC SQL SELECT resume INTO :resume :lobind FROM emp_resume [3]
        WHERE resume_format='ascii' AND empno='000130';

    if (lobind < 0) {
        printf ("NULL LOB indicated \n");
    } else {
        printf ("Resume for EMPNO 000130 is in file : RESUME.TXT\n");
    } /* endif */

    EXEC SQL CONNECT RESET;
    return 0;
}
/* end of program : LOBFILE */
```

Example: LOBFILE in COBOL

This example program, written in COBOL, extracts CLOB data from a table to an external file.

Note: By using the code examples, you agree to the terms of the [“Code license and disclaimer information”](#) on page 396.

```
Identification Division.
Program-ID. "lobfile".

Data Division.
Working-Storage Section.
    EXEC SQL INCLUDE SQLCA END-EXEC.

    EXEC SQL BEGIN DECLARE SECTION END-EXEC.
01 userid          pic x(8).
01 passwd.
    49 passwd-length pic s9(4) comp-5 value 0.
    49 passwd-name   pic x(18).
01 resume         USAGE IS SQL TYPE IS CLOB-FILE. [1]
01 lobind         pic s9(4) comp-5.
    EXEC SQL END DECLARE SECTION END-EXEC.
```

```

Procedure Division.
Main Section.
    display "Sample COBOL program: LOBFILE".

* Get database connection information.
    display "Enter your user id (default none): "
        with no advancing.
    accept userid.

    if userid = spaces
        EXEC SQL CONNECT TO sample END-EXEC
    else
        display "Enter your password : " with no advancing
        accept passwd-name.

* Passwords in a CONNECT statement must be entered in a VARCHAR
* format with the length of the input string.
    inspect passwd-name tallying passwd-length for characters
        before initial " ".

    EXEC SQL CONNECT TO sample USER :userid USING :passwd
        END-EXEC.

    move "RESUME.TXT" to resume-NAME.           [2]
    move 10 to resume-NAME-LENGTH.
    move SQL-FILE-OVERWRITE to resume-FILE-OPTIONS.

    EXEC SQL SELECT resume INTO :resume :lobind   [3]
        FROM emp_resume
        WHERE resume_format = 'ascii'
        AND empno = '000130' END-EXEC.
    if lobind less than 0 go to NULL-LOB-indicated.

    display "Resume for EMPNO 000130 is in file : RESUME.TXT".
    go to End-Main.

NULL-LOB-indicated.
    display "NULL LOB indicated".

End-Main.
    EXEC SQL CONNECT RESET END-EXEC.
End-Prog.
    stop run.

```

Example: Inserting data into a CLOB column

This example shows how to insert data from a regular file referenced by :hv_text_file into a character large object (CLOB) column.

In the path description of the following C program segment:

- userid represents the directory for one of your users.
- dirname represents a subdirectory name of "userid".
- filnam.1 can become the name of one of your documents that you want to insert into the table.
- clobtab is the name of the table with the CLOB data type.

```

strcpy(hv_text_file.name, "/home/userid/dirname/filnam.1");
hv_text_file.name_length = strlen("/home/userid/dirname/filnam.1");
hv_text_file.file_options = SQL_FILE_READ; /* this is a 'regular' file */

EXEC SQL INSERT INTO CLOBTAB
    VALUES(:hv_text_file);

```

Displaying the layout of LOB columns

When you use CL commands, such as Display Physical File Member (DSPPFM), to display a row of data from a table that holds large object (LOB) columns, the LOB data stored in the row is not displayed. Instead, the database shows a special value for the LOB columns.

The layout of this special value is as follows:

- 13 to 28 bytes of hexadecimal zeros.

- 16 bytes beginning with *POINTER and followed by blanks.

The number of bytes in the first portion of the value is set to the number needed to 16 byte boundary align the second part of the value.

For example, say you have a table that holds three columns: ColumnOne Char(10), ColumnTwo CLOB(40K), and ColumnThree BLOB(10M). If you were to issue a DSPPFM of this table, each row of data looks as follows.

- For ColumnOne: 10 bytes filled with character data.
- For ColumnTwo: 22 bytes filled with hexadecimal zeros and 16 bytes filled with '*POINTER '.
- For ColumnThree: 16 bytes filled with hexadecimal zeros and 16 bytes filled with '*POINTER '.

The full set of commands that display LOB columns in this way is:

- Display Physical File Member (DSPPFM)
- Copy File (CPYF) when the value *PRINT is specified for the TOFILE keyword
- Display Journal (DSPJRN)
- Retrieve Journal Entry (RTVJRNE)
- Receive Journal Entry (RCVJRNE) when the values *TYPE1, *TYPE2, *TYPE3 and *TYPE4 are specified for the ENTFMT keyword.

Journal entry layout of LOB columns

These commands return a buffer that gives the user addressability to the large object (LOB) data that has been journaled.

- Receive Journal Entry (RCVJRNE) CL command, when the value *TYPEPTR is specified for the ENTFMT keyword
- Retrieve Journal Entries (QjoRetrieveJournalEntries) API

The layout of the LOB columns in these entries is as follows:

- 0 to 15 bytes of hex zeros
- 1 byte of system information set to '00'x
- 4 bytes holding the length of the LOB data addressed by the pointer, below
- 8 bytes of hex zeros
- 16 bytes holding a pointer to the LOB data stored in the Journal Entry.

The first part of this layout is intended to 16 byte boundary align the pointer to the LOB data. The number of bytes in this area depends on the length of the columns that proceed the LOB column. Refer to the section above on the Display Layout of LOB Columns for an example of how the length of this first part is calculated.

User-defined distinct types

A user-defined distinct type (UDT) is a mechanism to extend Db2 capabilities beyond the built-in data types that are available.

User-defined distinct types enable you to define new data types to Db2, which gives you considerable power because you are no longer restricted to using the system-supplied built-in data types to model your business and capture the semantics of your data. Distinct data types allow you to map on a one-to-one basis to existing database types.

These benefits are associated with UDTs:

- **Extensibility.**

By defining new types, you can indefinitely increase the set of types provided by Db2 to support your applications.

- **Flexibility.**

You can specify any semantics and behavior for your new type by using user-defined functions (UDFs) to augment the diversity of the types available in the system.

- **Consistent behavior.**

Strong typing ensures that your UDTs will behave appropriately. It guarantees that only functions defined on your UDT can be applied to instances of the UDT.

- **Encapsulation.**

The behavior of your UDTs is restricted by the functions and operators that can be applied on them. This provides flexibility in the implementation since running applications do not depend on the internal representation that you chose for your type.

- **Extensible behavior.**

The definition of user-defined functions on types can augment the functionality provided to manipulate your UDT at any time.

- **Foundation for object-oriented extensions.**

UDTs are the foundation for most object-oriented features. They represent the most important step toward object-oriented extensions.

Related concepts

User-defined types

A *user-defined type* is a data type that you can define independently of the data types that are provided by the database management system.

Defining a UDT

You define a user-defined type (UDT) using the CREATE DISTINCT TYPE statement.

For the CREATE DISTINCT TYPE statement, note that:

1. The name of the new UDT can be a qualified or an unqualified name.
2. The source type of the UDT is the type used by the system to internally represent the UDT. For this reason, it must be a built-in data type. Previously defined UDTs cannot be used as source types of other UDTs.

As part of a UDT definition, the system always generates cast functions to:

- Cast from the UDT to the source type, using the standard name of the source type. For example, if you create a distinct type based on FLOAT, the cast function called DOUBLE is created.
- Cast from the source type to the UDT.

These functions are important for the manipulation of UDTs in queries.

The function path is used to resolve any references to an unqualified type name or function, except if the type name or function is the main object of a CREATE, DROP, or COMMENT ON statement.

Related reference

Using qualified function references

If you use a qualified function reference, you restrict the search for a matching function to the specified schema.

CREATE TYPE

Example: Money

Suppose that you are writing applications that handle different currencies and want to ensure that Db2 does not allow these currencies to be compared or manipulated directly with one another in queries.

Remember that conversions are necessary whenever you want to compare values of different currencies. So you define as many UDTs as you need; one for each currency that you may need to represent:

```

CREATE DISTINCT TYPE US_DOLLAR AS DECIMAL (9,2)
CREATE DISTINCT TYPE CANADIAN_DOLLAR AS DECIMAL (9,2)
CREATE DISTINCT TYPE EURO AS DECIMAL (9,2)

```

Example: Résumé

Suppose that you want to keep the application forms that are filled out by applicants to your company in a table, and that you are going to use functions to extract information from these forms.

Because these functions cannot be applied to regular character strings (because they are certainly not able to find the information they are supposed to return), you define a UDT to represent the filled forms:

```

CREATE DISTINCT TYPE PERSONAL.APPLICATION_FORM AS CLOB(32K)

```

Defining tables with UDTs

After you have defined several user-defined types (UDTs), you can start defining tables with columns whose types are UDTs.

Example: Sales

Suppose that you want to define tables to keep your company's sales in different countries.

You create the tables as follows:

```

CREATE TABLE US_SALES
(PRODUCT_ITEM INTEGER,
 MONTH        INTEGER CHECK (MONTH BETWEEN 1 AND 12),
 YEAR         INTEGER CHECK (YEAR > 1985),
 TOTAL        US_DOLLAR)

CREATE TABLE CANADIAN_SALES
(PRODUCT_ITEM INTEGER,
 MONTH        INTEGER CHECK (MONTH BETWEEN 1 AND 12),
 YEAR         INTEGER CHECK (YEAR > 1985),
 TOTAL        CANADIAN_DOLLAR)

CREATE TABLE GERMAN_SALES
(PRODUCT_ITEM INTEGER,
 MONTH        INTEGER CHECK (MONTH BETWEEN 1 AND 12),
 YEAR         INTEGER CHECK (YEAR > 1985),
 TOTAL        EURO)

```

The UDTs in the preceding examples are created with the same CREATE DISTINCT TYPE statements in “[Example: Money](#)” on page 259. Note that the preceding examples use check constraints.

Example: Application forms

Suppose that you need to define a table to keep the forms that are filled out by applicants.

Create the table as follows:

```

CREATE TABLE APPLICATIONS
(ID          INTEGER,
 NAME       VARCHAR (30),
 APPLICATION_DATE DATE,
 FORM       PERSONAL.APPLICATION_FORM)

```

You have fully qualified the UDT name because its qualifier is not the same as your authorization ID and you have not changed the default function path. Remember that whenever type and function names are not fully qualified, Db2 searches through the schemas listed in the current function path and looks for a type or function name matching the given unqualified name.

Manipulating UDTs

Strong typing is an important concept associated with user-defined types (UDTs). Strong typing guarantees that only functions and operators defined on a UDT can be applied to its instances.

Strong typing is important to ensure that the instances of your UDTs are correct. For example, if you have defined a function to convert US dollars to Canadian dollars according to the current exchange rate, you do not want this same function to be used to convert Euros to Canadian dollars because it will certainly return the wrong amount.

As a consequence of strong typing, Db2 does not allow you to write queries that compare, for example, UDT instances with instances of the UDT source type. For the same reason, Db2 will not let you apply functions defined on other types to UDTs. If you want to compare instances of UDTs with instances of another type, you need to cast the instances of one or the other type. In the same sense, you need to cast the UDT instance to the type of the parameter of a function that is not defined on a UDT if you want to apply this function to a UDT instance.

Examples: Using UDTs

These examples show the use of user-defined types (UDTs) in various situations.

Example: Comparisons between UDTs and constants

Suppose that you want to know which products had total sales of over US \$100 000.00 in the U.S. in the month of July 1998.

```
SELECT PRODUCT_ITEM
FROM   US_SALES
WHERE  TOTAL > US_DOLLAR (100000)
AND    month = 7
AND    year  = 1998
```

Because you cannot compare U.S. dollars with instances of the source type of U.S. dollars (that is, DECIMAL) directly, you have used the cast function provided by Db2 to cast from DECIMAL to U.S. dollars. You can also use the other cast function provided by Db2 (that is, the one to cast from U.S. dollars to DECIMAL) and cast the column total to DECIMAL. Either way you decide to cast, from or to the UDT, you can use the cast specification notation to perform the casting, or the functional notation. You might have written the above query as:

```
SELECT PRODUCT_ITEM
FROM   US_SALES
WHERE  TOTAL > CAST (100000 AS us_dollar)
AND    MONTH = 7
AND    YEAR  = 1998
```

Example: Casting between UDTs

Suppose that you want to define a user-defined function (UDF) that converts Canadian dollars to U.S. dollars.

You can obtain the current exchange rate from a file managed outside of Db2. Then define a UDF that obtains a value in Canadian dollars, accesses the exchange rate file, and returns the corresponding amount in U.S. dollars.

At first glance, such a UDF may appear easy to write. However, not all C compilers support DECIMAL values. The UDTs representing different currencies have been defined as DECIMAL. Your UDF will need to receive and return DOUBLE values, since this is the only data type provided by C that allows the representation of a DECIMAL value without losing the decimal precision. Your UDF should be defined as follows:

```
CREATE FUNCTION CDN_TO_US_DOUBLE(DOUBLE) RETURNS DOUBLE
EXTERNAL NAME 'MYLIB/CURRENCIES(C_CDN_US)'
LANGUAGE C
PARAMETER STYLE DB2SQL
NO SQL
NOT DETERMINISTIC
```

The exchange rate between Canadian and U.S. dollars may change between two invocations of the UDF, so you declare it as NOT DETERMINISTIC.

The question now is, how do you pass Canadian dollars to this UDF and get U.S. dollars from it? The Canadian dollars must be cast to DECIMAL values. The DECIMAL values must be cast to DOUBLE. You also need to have the returned DOUBLE value cast to DECIMAL and the DECIMAL value cast to U.S. dollars.

Such casts are performed automatically by Db2 anytime you define sourced UDFs, whose parameter and return type do not exactly match the parameter and return type of the source function. Therefore, you need to define two sourced UDFs. The first brings the DOUBLE values to a DECIMAL representation. The second brings the DECIMAL values to the UDT. Define the following:

```
CREATE FUNCTION CDN_TO_US_DEC (DECIMAL(9,2)) RETURNS DECIMAL(9,2)
SOURCE CDN_TO_US_DOUBLE (DOUBLE)

CREATE FUNCTION US_DOLLAR (CANADIAN_DOLLAR) RETURNS US_DOLLAR
SOURCE CDN_TO_US_DEC (DECIMAL())
```

Note that an invocation of the US_DOLLAR function as in US_DOLLAR(C1), where C1 is a column whose type is Canadian dollars, has the same effect as invoking:

```
US_DOLLAR (DECIMAL(CDN_TO_US_DOUBLE (DOUBLE (DECIMAL (C1))))))
```

That is, C1 (in Canadian dollars) is cast to decimal which in turn is cast to a double value that is passed to the CDN_TO_US_DOUBLE function. This function accesses the exchange rate file and returns a double value (representing the amount in U.S. dollars) that is cast to decimal, and then to U.S. dollars.

A function to convert Euros to U.S. dollars is similar to the example above:

```
CREATE FUNCTION EURO_TO_US_DOUBLE(DOUBLE)
RETURNS DOUBLE
EXTERNAL NAME 'MYLIB/CURRENCIES(C_EURO_US)'
LANGUAGE C
PARAMETER STYLE DB2SQL
NO SQL
NOT DETERMINISTIC

CREATE FUNCTION EURO_TO_US_DEC (DECIMAL(9,2))
RETURNS DECIMAL(9,2)
SOURCE EURO_TO_US_DOUBLE(DOUBLE)

CREATE FUNCTION US_DOLLAR(EURO) RETURNS US_DOLLAR
SOURCE EURO_TO_US_DEC (DECIMAL())
```

Example: Comparisons involving UDTs

Suppose that you want to know which products had higher sales in the U.S. than in Canada and Germany for the month of March 2003.

Issue the following SELECT statement:

```
SELECT US.PRODUCT_ITEM, US.TOTAL
FROM US_SALES AS US, CANADIAN_SALES AS CDN, GERMAN_SALES AS GERMAN
WHERE US.PRODUCT_ITEM = CDN.PRODUCT_ITEM
AND US.PRODUCT_ITEM = GERMAN.PRODUCT_ITEM
AND US.TOTAL > US_DOLLAR (CDN.TOTAL)
AND US.TOTAL > US_DOLLAR (GERMAN.TOTAL)
AND US.MONTH = 3
AND US.YEAR = 2003
AND CDN.MONTH = 3
AND CDN.YEAR = 2003
AND GERMAN.MONTH = 3
AND GERMAN.YEAR = 2003
```

Because you cannot directly compare U.S. dollars with Canadian dollars or Euros, you use the UDF to cast the amount in Canadian dollars to U.S. dollars, and the UDF to cast the amount in Euros to U.S. dollars. You cannot cast them all to DECIMAL and compare the converted DECIMAL values because the amounts are not monetarily comparable as they are not in the same currency.

Example: Sourced UDFs involving UDTs

Suppose that you have defined a sourced user-defined function (UDF) on the built-in SUM function to support SUM on Euros.

The function statement is as follows:

```
CREATE FUNCTION SUM (EURO)
  RETURNS EURO
  SOURCE SYSIBM.SUM (DECIMAL())
```

You want to know the total of sales in Germany for each product in the year of 2004. You want to obtain the total sales in U.S. dollars:

```
SELECT PRODUCT_ITEM, US_DOLLAR (SUM (TOTAL))
  FROM GERMANY_SALES
  WHERE YEAR = 2004
  GROUP BY PRODUCT_ITEM
```

You cannot write `SUM (US_DOLLAR (TOTAL))`, unless you had defined a SUM function on U.S. dollar in a manner similar to the above.

Related reference

[Example: Assignments involving different UDTs](#)

Suppose that you have defined these sourced user-defined functions (UDFs) on the built-in SUM function to support SUM on U.S. and Canadian dollars.

Example: Assignments involving UDTs

Suppose that you want to store the form that is filled out by a new applicant into the database.

You have defined a host variable containing the character string value used to represent the filled form:

```
EXEC SQL BEGIN DECLARE SECTION;
  SQL TYPE IS CLOB(32K) hv_form;
EXEC SQL END DECLARE SECTION;

/* Code to fill hv_form */

INSERT INTO APPLICATIONS
  VALUES (134523, 'Peter Holland', CURRENT DATE, :hv_form)
```

You do not explicitly invoke the cast function to convert the character string to the UDT `personal.application_form`. This is because Db2 allows you to assign instances of the source type of a UDT to targets having that UDT.

Related reference

[Example: Assignments in dynamic SQL](#)

If you want to store the application form using dynamic SQL, you can use parameter markers.

Example: Assignments in dynamic SQL

If you want to store the application form using dynamic SQL, you can use parameter markers.

The statement is as follows:

```
EXEC SQL BEGIN DECLARE SECTION;
  long id;
  char name[30];
  SQL TYPE IS CLOB(32K) form;
  char command[80];
EXEC SQL END DECLARE SECTION;

/* Code to fill host variables */

strcpy(command, "INSERT INTO APPLICATIONS VALUES");
strcat(command, "(?, ?, CURRENT DATE, ?)");

EXEC SQL PREPARE APP_INSERT FROM :command;
EXEC SQL EXECUTE APP_INSERT USING :id, :name, :form;
```

You made use of Db2's cast specification to tell Db2 that the type of the parameter marker is CLOB(32K), a type that is assignable to the UDT column. Remember that you cannot declare a host variable of a UDT type, since host languages do not support UDTs. Therefore, you cannot specify that the type of a parameter marker is a UDT.

Related reference

[Example: Assignments involving UDTs](#)

Suppose that you want to store the form that is filled out by a new applicant into the database.

Example: Assignments involving different UDTs

Suppose that you have defined these sourced user-defined functions (UDFs) on the built-in SUM function to support SUM on U.S. and Canadian dollars.

```
CREATE FUNCTION SUM (CANADIAN_DOLLAR)
  RETURNS CANADIAN_DOLLAR
  SOURCE SYSIBM.SUM (DECIMAL ())

CREATE FUNCTION SUM (US_DOLLAR)
  RETURNS US_DOLLAR
  SOURCE SYSIBM.SUM (DECIMAL ())
```

Now suppose your supervisor requests that you maintain the annual total sales in U.S. dollars of each product and in each country, in separate tables:

```
CREATE TABLE US_SALES_04
  (PRODUCT_ITEM INTEGER,
   TOTAL        US_DOLLAR)

CREATE TABLE GERMAN_SALES_04
  (PRODUCT_ITEM INTEGER,
   TOTAL        US_DOLLAR)

CREATE TABLE CANADIAN_SALES_04
  (PRODUCT_ITEM INTEGER,
   TOTAL        US_DOLLAR)

INSERT INTO US_SALES_04
  SELECT PRODUCT_ITEM, SUM (TOTAL)
  FROM US_SALES
  WHERE YEAR = 2004
  GROUP BY PRODUCT_ITEM

INSERT INTO GERMAN_SALES_04
  SELECT PRODUCT_ITEM, US_DOLLAR (SUM (TOTAL))
  FROM GERMAN_SALES
  WHERE YEAR = 2004
  GROUP BY PRODUCT_ITEM

INSERT INTO CANADIAN_SALES_04
  SELECT PRODUCT_ITEM, US_DOLLAR (SUM (TOTAL))
  FROM CANADIAN_SALES
  WHERE YEAR = 2004
  GROUP BY PRODUCT_ITEM
```

You explicitly cast the amounts in Canadian dollars and Euros to U.S. dollars since different UDTs are not directly assignable to each other. You cannot use the cast specification syntax because UDTs can only be cast to their own source type.

Related reference

[Example: Sourced UDFs involving UDTs](#)

Suppose that you have defined a sourced user-defined function (UDF) on the built-in SUM function to support SUM on Euros.

Example: Using UDTs in UNION

Suppose that you want to provide your U.S. users with a query to show the sales of every product of your company.

The SELECT statement is as follows:

```

SELECT PRODUCT_ITEM, MONTH, YEAR, TOTAL
FROM US_SALES
UNION
SELECT PRODUCT_ITEM, MONTH, YEAR, US_DOLLAR (TOTAL)
FROM CANADIAN_SALES
UNION
SELECT PRODUCT_ITEM, MONTH, YEAR, US_DOLLAR (TOTAL)
FROM GERMAN_SALES

```

You cast Canadian dollars to U.S. dollars and Euros to U.S. dollars because UDTs are union compatible only with the same UDT. You must use the functional notation to cast between UDTs since the cast specification only allows you to cast between UDTs and their source types.

Examples: Using UDTs, UDFs, and LOBs

These examples show how to use user-defined types (UDTs), user-defined functions (UDFs), and large objects (LOBs) together in complex applications.

Example: Defining the UDT and UDFs

Suppose that you want to keep the electronic mail (e-mail) that is sent to your company in a table.

Ignoring any issues of privacy, you plan to write queries over such e-mail to find out their subject, how often your e-mail service is used to receive customer orders, and so on. E-mail can be quite large, and it has a complex internal structure (a sender, a receiver, the subject, date, and the e-mail content). Therefore, you decide to represent the e-mail by means of a UDT whose source type is a large object. You define a set of UDFs on your e-mail type, such as functions to extract the subject of the e-mail, the sender, the date, and so on. You also define functions that can perform searches on the content of the e-mail. You do the above using the following CREATE statements:

```

CREATE DISTINCT TYPE E_MAIL AS BLOB (1M)

CREATE FUNCTION SUBJECT (E_MAIL)
  RETURNS VARCHAR (200)
  EXTERNAL NAME 'LIB/PGM(SUBJECT)'
  LANGUAGE C
  PARAMETER STYLE DB2SQL
  NO SQL
  DETERMINISTIC
  NO EXTERNAL ACTION

CREATE FUNCTION SENDER (E_MAIL)
  RETURNS VARCHAR (200)
  EXTERNAL NAME 'LIB/PGM(SENDER)'
  LANGUAGE C
  PARAMETER STYLE DB2SQL
  NO SQL
  DETERMINISTIC
  NO EXTERNAL ACTION

CREATE FUNCTION RECEIVER (E_MAIL)
  RETURNS VARCHAR (200)
  EXTERNAL NAME 'LIB/PGM(RECEIVER)'
  LANGUAGE C
  PARAMETER STYLE DB2SQL
  NO SQL
  DETERMINISTIC
  NO EXTERNAL ACTION

CREATE FUNCTION SENDING_DATE (E_MAIL)
  RETURNS DATE CAST FROM VARCHAR(10)
  EXTERNAL NAME 'LIB/PGM(SENDING_DATE)'
  LANGUAGE C
  PARAMETER STYLE DB2SQL
  NO SQL
  DETERMINISTIC
  NO EXTERNAL ACTION

CREATE FUNCTION CONTENTS (E_MAIL)
  RETURNS BLOB (1M)
  EXTERNAL NAME 'LIB/PGM(CONTENTS)'
  LANGUAGE C
  PARAMETER STYLE DB2SQL

```

```

NO SQL
DETERMINISTIC
NO EXTERNAL ACTION

CREATE FUNCTION CONTAINS (E_MAIL, VARCHAR (200))
RETURNS INTEGER
EXTERNAL NAME 'LIB/PGM(CONTAINS)'
LANGUAGE C
PARAMETER STYLE DB2SQL
NO SQL
DETERMINISTIC
NO EXTERNAL ACTION

CREATE TABLE ELECTRONIC_MAIL
(ARRIVAL_TIMESTAMP TIMESTAMP,
MESSAGE_E_MAIL)

```

Example: Using the LOB function to populate the database

Suppose that you populate your table by transferring your e-mail that is maintained in files into the Db2 for i database.

Run the following INSERT statement multiple times with different values of the HV_EMAIL_FILE until you have stored all your e-mail:

```

EXEC SQL BEGIN DECLARE SECTION
SQL TYPE IS BLOB_FILE HV_EMAIL_FILE;

EXEC SQL END DECLARE SECTION
strcpy (HV_EMAIL_FILE.NAME, "/u/mail/email/mbox");
HV_EMAIL_FILE.NAME_LENGTH = strlen(HV_EMAIL_FILE.NAME);
HV_EMAIL_FILE.FILE_OPTIONS = 2;

EXEC SQL INSERT INTO ELECTRONIC_MAIL
VALUES (CURRENT_TIMESTAMP, :hv_email_file);

```

All the function provided by Db2 LOB support is applicable to UDTs whose source type are LOBs. Therefore, you have used LOB file reference variables to assign the contents of the file into the UDT column. You have not used the cast function to convert values of BLOB type into your e-mail type. This is because Db2 allows you to assign values of the source type of a distinct type to targets of the distinct type.

Example: Using UDFs to query instances of UDTs

Suppose that you need to know how much e-mail was sent by a specific customer regarding customer orders and you have the e-mail addresses of your customers in the customers table.

The statement is as follows:

```

SELECT COUNT (*)
FROM ELECTRONIC_MAIL AS EMAIL, CUSTOMERS
WHERE SUBJECT (EMAIL.MESSAGE) = 'customer order'
AND CUSTOMERS.EMAIL_ADDRESS = SENDER (EMAIL.MESSAGE)
AND CUSTOMERS.NAME = 'Customer X'

```

You have used the UDFs defined on the UDT in this SQL query since they are the only means to manipulate the UDT. In this sense, your UDT e-mail is completely encapsulated. Its internal representation and structure are hidden and can only be manipulated by the defined UDFs. These UDFs know how to interpret the data without the need to expose its representation.

Suppose you need to know the details of all the e-mail your company received in 1994 that had to do with the performance of your products in the marketplace.

```

SELECT SENDER (MESSAGE), SENDING_DATE (MESSAGE), SUBJECT (MESSAGE)
FROM ELECTRONIC_MAIL
WHERE CONTAINS (MESSAGE,
'"performance" AND "products" AND "marketplace"') = 1

```

You have used the contains UDF that is capable of analyzing the contents of the message searching for relevant keywords or synonyms.

Example: Using LOB locators to manipulate UDT instances

Suppose that you want to obtain information about specific e-mail without having to transfer the entire e-mail into a host variable in your application program.

Remember that e-mail can be quite large. Because your user-defined type (UDT) is defined as a large object (LOB), you can use LOB locators for that purpose:

```
EXEC SQL BEGIN DECLARE SECTION
  long hv_len;
  char hv_subject[200];
  char hv_sender[200];
  char hv_buf[4096];
  char hv_current_time[26];
  SQL TYPE IS BLOB_LOCATOR hv_email_locator;
EXEC SQL END DECLARE SECTION

EXEC SQL SELECT MESSAGE
  INTO :hv_email_locator
  FROM ELECTRONIC_MAIL
  WHERE ARRIVAL_TIMESTAMP = :hv_current_time;

EXEC SQL VALUES (SUBJECT (E_MAIL(:hv_email_locator)))
  INTO :hv_subject;
.... code that checks if the subject of the e_mail is relevant ....
.... if the e_mail is relevant, then.....

EXEC SQL VALUES (SENDER (CAST (:hv_email_locator AS E_MAIL)))
  INTO :hv_sender;
```

Because your host variable is of type BLOB locator (the source type of the UDT), you have explicitly converted the BLOB locator to your UDT, whenever it was used as an argument of a UDF defined on the UDT.

Using DataLinks

The DataLink data type is one of the basic building blocks for extending the types of data that can be stored in database files. The idea of a DataLink is that the actual data stored in the column is only a pointer to the object.

This object can be anything, an image file, a voice recording, a text file, and so on. The method used for resolving to the object is to store a Uniform Resource Locator (URL). This means that a row in a table can be used to contain information about the object in traditional data types, and the object itself can be referenced using the DataLink data type. The user can use SQL scalar functions to get back the path to the object and the server on which the object is stored (see Built-in functions in the SQL Reference). With the DataLink data type, there is a fairly loose relationship between the row and the object. For instance, deleting a row will sever the relationship to the object referenced by the DataLink, but the object itself might not be deleted.

A table created with a DataLink column can be used to hold information about an object, without actually containing the object itself. This concept gives the user much more flexibility in the types of data that can be managed using a table. If, for instance, the user has thousands of video clips stored in the integrated file system of their server, they may want to use an SQL table to contain information about these video clips. But since the user already has the objects stored in a directory, they only want the SQL table to contain references to the objects, not the actual bytes of storage. A good solution is to use DataLinks. The SQL table uses traditional SQL data types to contain information about each clip, such as title, length, date, and so on. But the clip itself is referenced using a DataLink column. Each row in the table stores a URL for the object and an optional comment. Then an application that is working with the clips can retrieve the URL using SQL interfaces, and then use a browser or other playback software to work with the URL and display the video clip.

There are several advantages of using this technique:

- The integrated file system can store any type of stream file.

- The integrated file system can store extremely large objects, that does not fit into a character column, or perhaps even a LOB column.
- The hierarchical nature of the integrated file system is well-suited to organizing and working with the stream file objects.
- By leaving the bytes of the object outside the database and in the integrated file system, applications can achieve better performance by allowing the SQL runtime engine to handle queries and reports, and allowing the file system to handle streaming of video, displaying images, text, and so on.

Using DataLinks also gives control over the objects while they are in "linked" status. A DataLink column can be created such that the referenced object cannot be deleted, moved, or renamed while there is a row in the SQL table that references that object. This object is considered linked. Once the row containing that reference is deleted, the object is unlinked. To understand this concept fully, one should know the levels of control that can be specified when creating a DataLink column.

Related reference

[Data types](#)

Linking control levels in DataLinks

You can create a DataLink column with different link controls.

NO LINK CONTROL

If a DataLink column is created with NO LINK CONTROL, no linking takes place when rows are added to the SQL table.

The URL is verified to be syntactically correct, but there is no check to make sure that the server is accessible, or that the file even exists.

FILE LINK CONTROL with FS permissions

If a DataLink column is created with FILE LINK CONTROL with file system (FS) permissions, the system verifies that each DataLink value is a valid URL, with a valid server name and file name.

The file must exist when the row is being inserted into the SQL table. When the object is found, it is marked as linked. This means that the object cannot be moved, deleted, or renamed during the time it is linked. Also, an object cannot be linked more than once. If the server name portion of the URL specifies a remote system, that system must be accessible. If a row that contains a DataLink value is deleted, the object is unlinked. If a DataLink value is updated to a different value, the old object is unlinked and the new object is linked.

The integrated file system is still responsible for managing permissions for the linked object. The permissions are not modified during the link or unlink processes. This option provides control of the object's existence for the duration of time that it is linked.

FILE LINK CONTROL with DB permissions

If a DataLink column is created with FILE LINK CONTROL with database (DB) permissions, the URL is verified, and all existing permissions to the object are removed.

The ownership of the object is changed to a special system-supplied user profile. During the time that the object is linked, the only access to the object is by obtaining the URL from the SQL table that has the object linked. This is handled by using a special access token that is appended to the URL returned by SQL. Without the access token, all attempts to access the object will fail with an authority violation. If the URL with the access token is retrieved from the SQL table by normal means (FETCH, SELECT INTO, and so on.) the file system filter will validate the access token and allow the access to the object.

This option provides the control of preventing updates to the linked object for users trying to access the object by direct means. Since the only access to the object is by obtaining the access token from an SQL operation, an administrator can effectively control access to the linked objects by using the database permissions to the SQL table that contains the DataLink column.

Working with DataLinks

To work with DataLinks, you need to understand the DataLink processing environment.

Support for the DataLink data type can be broken down into the following different components:

1. The Db2 database support has a data type called DATALINK. This can be specified on SQL statements such as CREATE TABLE and ALTER TABLE. The column cannot have any default other than NULL. Access to the data must be using SQL interfaces. This is because the DataLink itself is not compatible with any host variable type. SQL scalar functions can be used to retrieve the DataLink value in character form. There is a DLVALUE scalar function that must be used in SQL to INSERT and UPDATE the values in the column.
2. The DataLink File Manager (DLFM) is the component that maintains the link status for the files on a server and keeps track of metadata for each file. This code handles linking, unlinking, and commitment control issues. An important aspect of DataLinks is that the DLFM does not need to be on the same physical system as the SQL table that contains the DataLink column. So an SQL table can link an object that resides in either the same system's integrated file system or a remote server's integrated file system.
3. The DataLink filter must be run when the file system tries operations against files that are in directories designated as containing linked objects. This component determines if the file is linked, and optionally, if the user is authorized to access the file. If the file name includes an access token, the token will be verified. Because there is extra overhead in this filter process, it is only run when the accessed object exists in one of the directories within a DataLink prefix. See the following discussion on prefixes.

When working with DataLinks, there are several steps that must be taken to properly configure the system:

- TCP/IP must be configured on any systems that are going to be used when working with DataLinks. This includes the systems on which the SQL tables with DataLink columns are going to be created, as well as the systems that will contain the objects to be linked. In most cases, this will be the same system. Since the URL that is used to reference the object contains a TCP/IP server name, this name must be recognized by the system that is going to contain the DataLink. The command CFGTCP can be used to configure the TCP/IP names, or to register a TCP/IP name server.
- The system that contains the SQL tables must have the Relational Database Directory updated to reflect the local database system, and any optional remote systems. The command WRKRDBDIRE can be used to add or modify information in this directory. For consistency, it is recommended that the same names be used as the TCP/IP server name and the Relational Database name.
- The DLFM server must be started on any systems that will contain objects to be linked. The command STRTCPSVR *DLFM can be used to start the DLFM server. The DLFM server can be ended by using the CL command ENDTCPSPVR *DLFM.

Once the DLFM has been started, there are some steps needed to configure the DLFM. These DLFM functions are available via an executable script that can be entered from the QShell interface. To get to the interactive shell interface, use the CL command QSH. This will open a command entry screen from which you can enter the DLFM script commands. The script command dfmadmin -help can be used to display help text and syntax diagrams. For the most commonly used functions, CL commands have also been provided. Using the CL commands, most or all of the DLFM configuration can be accomplished without using the script interface. Depending on your preferences, you can choose to use either the script commands from the QSH command entry screen or the CL commands from the CL command entry screen.

Since these functions are meant for a system administrator or a database administrator, they all require the *IOSYSCFG special authority.

Adding a prefix

A prefix is a path or directory that will contain objects to be linked. When setting up the Data Links File Manager (DLFM) on a system, the administrator must add any prefixes that will be used for DataLinks. The

script command `dfmadmin -add_prefix` is used to add prefixes. The CL command to add prefixes is Add Prefix to DataLink File Manager (`ADDPFXDLFM`) command.

For instance, on server TESTSYS1, there is a directory called `/mydir/datalinks/` that contains the objects that will be linked. The administrator uses the command `ADDPFXDLFM PREFIX('/mydir/datalinks/')` to add the prefix. The following links for URLs are valid because their paths have valid prefixes:

```
http://TESTSYS1/mydir/datalinks/videos/file1.mpg
or
file://TESTSYS1/mydir/datalinks/text/story1.txt
```

It is also possible to remove a prefix using the script command `dfmadmin -del_prefix`. This is not a commonly used function since it can only be run if there are no linked objects anywhere in the directory structure contained within the prefix name.

Notes:

1. The following directories, or any of their subdirectories, should not be used as prefixes for DataLinks:
 - /QIBM
 - /QReclaim
 - /QSR
 - /QFPNWSSTG
2. Additionally, common base directories such as the following should not be used unless the prefix is a subdirectory within one of the base directories:
 - /home
 - /dev
 - /bin
 - /etc
 - /tmp
 - /usr
 - /lib

Adding a host database

A host database is a relational database system from which a link request originates. If the DLFM is on the same system as the SQL tables that will contain the DataLinks, then only the local database name needs to be added. If the DLFM will have link requests coming from remote systems, then all of their names must be registered with the DLFM. The script command to add a host database is `dfmadmin -add_db` and the CL command is Add Host Database to DataLink File Manager (`ADDHDBDLFM`) command. This function also requires that the libraries containing the SQL tables also be registered.

For instance, on server TESTSYS1 where you have already added the `/mydir/datalinks/` prefix, you want SQL tables on the local system in either TESTDB or PRODDB library to be allowed to link objects on this server. Use the following:

```
ADDHDBDLFM HOSTDBLIB((TESTDB) (PRODDB)) HOSTDB(TESTSYS1)
```

Once the DLFM has been started, and the prefixes and host database names have been registered, you can begin linking objects in the file system.

HTTP functions overview

These HTTP functions are used to make HTTP requests that use web services. These functions allow the SQL programmer to use Representational State Transfer (RESTful) via SQL, including Embedded SQL. They provide the same capabilities as the SYSTOOLS HTTP functions without the overhead of creating a

JVM. The functions use the HTTP Transport APIs that are part of the Integrated Web Services (IWS) client for ILE support.

To use the HTTP functions, 5770SS1 option 3 (Extended Base Directory Support) and 5770SS1 option 34 (Digital Certificate Manager) must be installed on the system.

These HTTP functions exist in QSYS2 and have lower overhead than the SYSTOOLS HTTP functions. Additional benefits of the QSYS2 HTTP functions are HTTP authentication, proxy support, configurable redirection attempts, and configurable SSL options.

The URL parameter supports *http:* and *https:* URLs. The *https:* URL indicates that network communication should take place over a secure communication channel. An https request uses TLS (Transport Layer Security) to create the secure channel. This secure channel encrypts any transmitted data and also prevents man-in-the-middle attacks. Any communication that contains secure information should use https instead of http. Because of the sensitive nature of userids and passwords, HTTP authentication is not allowed for http URLs.

The HTTP services are implemented using the QSYS/QSQAXISC service program. The system administrator can disable access to the HTTP services by modifying authority on the QSYS/QSQAXISC service program. The authority associated with the QSYS/QSQAXISC service program applies to all the HTTP functions.

Foundational HTTP functions

The foundational functions are named according to the two dimensions used when making HTTP requests.

- The first dimension is the HTTP operation. There are 5 different HTTP operations: GET, PATCH, PUT, POST, and DELETE.
- The second dimension indicates whether the verbose version of the function should be used. The non-verbose functions are scalar functions that return the response as a CLOB. The verbose functions are table functions that return a single row, which includes the return header information that is sent from the HTTP server. The header information is formatted as JSON.

The names of the functions reflect these dimensions. For example, HTTP_GET_VERBOSE uses the GET operation from the first dimension and the VERBOSE setting from the second dimension. All the functions return CLOB data.

The following table summarizes the functions.

Function	Description	Documentation link
HTTP_DELETE	Make an HTTP DELETE request and return CLOB data.	HTTP_DELETE scalar function
HTTP_DELETE_VERBOSE	Make an HTTP DELETE request and return CLOB data and response header.	HTTP_DELETE_VERBOSE table function
HTTP_GET	Make an HTTP GET request and return CLOB data.	HTTP_GET scalar function
HTTP_GET_VERBOSE	Make an HTTP GET request and return CLOB data and response header.	HTTP_GET_VERBOSE table function
HTTP_PATCH	Make an HTTP PATCH request and return CLOB data.	HTTP_PATCH scalar function

Table 53. Foundational HTTP functions (continued)

Function	Description	Documentation link
HTTP_PATCH_VERBOSE	Make an HTTP PATCH request and return CLOB data and response header.	HTTP_PATCH_VERBOSE table function
HTTP_POST	Make an HTTP POST request and return CLOB data.	HTTP_POST scalar function
HTTP_POST_VERBOSE	Make an HTTP POST request and return CLOB data and response header.	HTTP_POST_VERBOSE table function
HTTP_PUT	Make an HTTP PUT request and return CLOB data.	HTTP_PUT scalar function
HTTP_PUT_VERBOSE	Make an HTTP PUT request and return CLOB data and response header.	HTTP_PUT_VERBOSE table function

These HTTP functions are passed parameters that indicate the HTTP server to access, the settings of the HTTP headers, and any data to be sent to the server. The parameters are the same for each HTTP function.

- The first parameter is the URL used to access the server.
- The second parameter is a string which indicates the options to be used on the request. These options include the setting of the HTTP headers. The string is a JSON object with the following format:

```
{"option": "option-setting", "option": "option-setting"}
```

The options are described here: [HTTP options](#).

Utility HTTP functions

Some additional HTTP functions are utility functions for working with HTTP requests.

Table 54. HTTP utility functions

Function	Description	Documentation link
BASE64_DECODE	Returns a bit data string that has been Base64 decoded.	BASE64_DECODE scalar function
BASE64_ENCODE	Returns the Base64 encoded version of a character string.	BASE64_ENCODE scalar function
URL_DECODE	Decodes a URL encoded string.	URL_DECODE scalar function
URL_ENCODE	Encodes a string using URL encoding.	URL_ENCODE scalar function

SSL considerations

By default, the HTTP functions use the system default certificate store: /QIBM/USERDATA/ICSS/CERT/SERVER/DEFAULT.KDB. By default, this certificate store does not exist. The Digital Certificate Manager (DCM) can be used to create this certificate store and add certificates to this certificate store.

If your application chooses to trust the certificates used by the JVM, the following SQL statements can be used to create a certificate store (/home/javaTrustStore/fromJava.KDB) that can be used by the HTTP functions. This process uses the /QOpenSys/QIBM/ProdData/JavaVM/jdk80/64bit/jre/lib/security/cacerts java trust store included when the 64-bit Java 8 is

installed. This script may be changed to use a more recent Java trust store. The script also uses Qshell, which requires 5770SS1 Option 30.

In this example *changeit* is the default password for the cacerts file shipped with Java. A temporary password of *xyz789* is used during the setup, which is immediately replaced by the final password. *abc123* is the final password for the newly created certificate store.

This procedure requires that the user is authorized to create the `/home/javaTrustStore` directory and has permission to read the cacerts file.

```
-- The following SQL script generates a KDB trust store from a Java trust
-- store using an intermediate JKS trust store. The IFS directory and
-- name of the KDB trust store are set in the NEW_TRUST_DIRECTORY and
-- NEW_TRUST_STORE variables below.
--
-- Create an SQL schema to contain temporary variables.
-- The user must have permission to create a schema.
--
CREATE SCHEMA FROM JAVA_TRUST_STORE;
SET SCHEMA FROM JAVA_TRUST_STORE;
SET PATH CURRENT PATH, FROM JAVA_TRUST_STORE;

--
-- Define global variables for parameters to the procedure for generating new trust store.
--

-- Specify the IFS directory to use for the new trust store.
-- In this example, we use /home/javaTrustStore
-- The user must have *W authority to /home in order to create this
-- directory.
CREATE OR REPLACE VARIABLE NEW_TRUST_DIRECTORY VARCHAR(80) CCSID 37;
SET NEW_TRUST_DIRECTORY='/home/javaTrustStore';

-- Specify the name of the new trust store name
-- In this example, the name is fromJava.KDB
CREATE OR REPLACE VARIABLE NEW_TRUST_STORE VARCHAR(80) CCSID 37;
SET NEW_TRUST_STORE = NEW_TRUST_DIRECTORY CONCAT '/fromJava.KDB';

-- Specify the password for the trust store. This
-- should be changed to keep the new trust store secure.
CREATE OR REPLACE VARIABLE NEW_TRUST_STORE_PASSWORD VARCHAR(80) CCSID 37;
SET NEW_TRUST_STORE_PASSWORD= 'abc123';

-- Specify the Java trust store to use.
CREATE OR REPLACE VARIABLE JAVA_TRUST_STORE VARCHAR(80) CCSID 37;
SET JAVA_TRUST_STORE='/QOpenSys/QIBM/ProdData/JavaVM/jdk80/64bit/jre/lib/security/cacerts';

-- Specify the Java trust store password. The default password is changeit.
-- If the password has been changed on the system, the correct value will need to be used.
CREATE OR REPLACE VARIABLE JAVA_TRUST_STORE_PASSWORD VARCHAR(80) CCSID 37;
SET JAVA_TRUST_STORE_PASSWORD = 'changeit';

-- Specify the name of a temporary JKS format TRUST STORE.
-- In this example, jksExport is used.
CREATE OR REPLACE VARIABLE JKS_TRUST_STORE VARCHAR(80) CCSID 37;
SET JKS_TRUST_STORE = NEW_TRUST_DIRECTORY CONCAT '/jksExport';

-- Specify the password of the temporary JKS format TRUST STORE.
-- In this example, xyz789 is used as the password.
CREATE OR REPLACE VARIABLE JKS_TRUST_STORE_PASSWORD VARCHAR(80) CCSID 37;
SET JKS_TRUST_STORE_PASSWORD = 'xyz789' ;

-- Step 1. Use QCMDEXC and QSH and mkdir to create a directory in which
-- to save the new store file
CALL QSYS2.QCMDEXC( 'QSH CMD(''mkdir ' CONCAT NEW_TRUST_DIRECTORY CONCAT ''')');

-- Step 2. Use QCMDEXC and QSH to run the keytool command to export
-- the default java certificate store in PKCS12 format
CALL QSYS2.QCMDEXC(
'QSH CMD(''keytool -importkeystore ' CONCAT
'-srcstorepass ' CONCAT JAVA_TRUST_STORE_PASSWORD CONCAT
'-srckeystore ' CONCAT JAVA_TRUST_STORE CONCAT
'-destkeystore ' CONCAT JKS_TRUST_STORE CONCAT
'-srcstoretype JKS -deststoretype PKCS12 ' CONCAT
'-deststorepass ' CONCAT JKS_TRUST_STORE_PASSWORD CONCAT ''')');
```

```

-- Step 3. Create an SQL procedure that will call the QSYS/QYMKIMPK API to
-- create a keystore from the PKCS12 keystore. A SQL7909 warning from
-- this step can be ignored.
CREATE OR REPLACE PROCEDURE ImportKeyStore(
    STOREPATH CHAR(100) CCSID 37,
    STOREPATHLEN INT,
    STOREFORMAT CHAR(9) CCSID 37,
    STOREPASSWORD CHAR(100) CCSID 37,
    STOREPASSWORDLEN INT,
    STOREPASSWORDCCSID INT,
    IMPORTPATH CHAR(100) CCSID 37,
    IMPORTPATHLEN INT,
    IMPORTFORMAT CHAR(9) CCSID 37,
    IMPORTVERSION CHAR(11) CCSID 37,
    IMPORTPASSWORD CHAR(100) CCSID 37,
    IMPORTPASSWORDLEN INT,
    IMPORTPASSWORDCCSID INT,
    ERRORCODE CHAR(100) FOR BIT DATA)
LANGUAGE C PARAMETER STYLE GENERAL EXTERNAL NAME 'QSYS/QYMKIMPK';

-- Step 4. Call the SQL procedure to call the QSYS/QYMKIMPK API to
-- create the new keystore to be used.
CALL IMPORTKEYSTORE(
    STOREPATH => NEW_TRUST_STORE,
    STOREPATHLEN => LENGTH(NEW_TRUST_STORE),
    STOREFORMAT => 'OBJN0100',
    STOREPASSWORD => NEW_TRUST_STORE_PASSWORD,
    STOREPASSWORDLEN => LENGTH(NEW_TRUST_STORE_PASSWORD),
    STOREPASSWORDCCSID => 37,
    IMPORTPATH => JKS_TRUST_STORE,
    IMPORTPATHLEN => LENGTH(JKS_TRUST_STORE),
    IMPORTFORMAT => 'OBJN0100',
    IMPORTVERSION => '*PKCS12V3 ',
    IMPORTPASSWORD => JKS_TRUST_STORE_PASSWORD,
    IMPORTPASSWORDLEN => LENGTH(JKS_TRUST_STORE_PASSWORD),
    IMPORTPASSWORDCCSID => 37,
    ERRORCODE => X'0000000000000000000000000000000000000000000000000000000000000000');

-- Use the new trust store to verify it works.
-- This step assumes that the system has a connection to the internet and that
-- a network firewall is not interposing its own TLS certificate on the connection.
values http_get(
    URL => 'https://www.ibm.com/support/pages/sites/default/files/inline-files/xmlldoc.xml',
    OPTIONS => '{"sslCertificateStoreFile":"' CONCAT NEW_TRUST_STORE CONCAT '"}');

-- Cleanup the schema
DROP SCHEMA FROM_JAVA_TRUST_STORE;

```

Common errors

When an error occurs, use the VERBOSE form of the function to get additional information about the error. These functions will return error information in the RESPONSE_MESSAGE column. For example, the following invocation will return information about a page not found error.

```
SELECT * FROM TABLE(QSYS2.HTTP_GET_VERBOSE('http://www.w3.org/notfound.html',''));
```

The following are some common errors that may be encountered when using the HTTP functions.

- If the current system does not have internet access, the following error may be encountered.

```
AXISC ERROR : HTTPTransportException: Channel I/O operation timed
out. Failed to open connection to server at host 192.168.1.233 and port 80.
Error is 3447 - A remote host did not respond within the timeout period.
```

- If DNS is not configured on the system, the following error may be encountered.

```
AXISC ERROR : AxisTransportException: Cannot open a channel to the
remote end. Failed to open connection to server at host XXXXX and port 80.
Error is 3401 - Permission denied
```

- If https is being used, the connection uses SSL. In order to work properly, the server must use a certificate signed by a certificate authority present in the certificate store specified by the sslCertificateStoreFile option.

```
AXISC ERROR : HTTPTransportException: Cannot initialize a channel
to the remote end. Failed to establish SSL connection to server, the operation
gsk_secure_soc_init() failed. GSKit Error is 6000 - Certificate is not signed
by a trusted certificate authority.
```

- http Authentication must be specified using the basicAuth option. An attempt to use basic authentication on the URL (for example `https://userid:password@example.com/login`) results in the following error.

```
AXISC ERROR : AxisTransportException: Cannot open a channel to the
remote end. Failed to open connection to server at host userid and port 0.
Error is 3421 - Address not available.
```

Debugging considerations

You should use IBM i Access Client Solutions (ACS) Run SQL Scripts to execute the HTTP functions in order to see error information. Using STRSQL to invoke HTTP functions will not provide useful problem information.

Because the HTTP functions use the networking functions provided by AXISC and GSKit, any networking problem may not be exposed to the SQL level with enough detail to diagnose the problem. If the HTTP functions fail with an SQL4302 error and the information is not useful, an AXISC trace may provide more information.

Information about enabling the AXISC trace can be found at [Enabling a Client Trace for a Web Services Client](#).

Working with JSON data

Db2 for i can consume and generate formatted JSON data.

JSON concepts

JSON (JavaScript Object Notation) is a popular format for interchanging information. It has a simple structure and is easily read by humans and machines. Due to its simplicity, it is used as an alternative to XML and does not require predetermined schema designs. While initially created for use with JavaScript, it is language independent and portable. Db2 for i conforms to the industry standard SQL support for JSON.

BSON is a standardized binary representation format for serializing JSON text. It allows for fast traversal of JSON. BSON does not provide any storage savings over JSON.

JSON objects, arrays, and scalar values

A JSON document consists of an object, which is a collection of *key:value* pairs. Each value may be a string, a number, the null value, an array, or another object. The *key:value* pairs are separated by commas. The key and value are separated by a colon. An example of a simple JSON object with two *key:value* pairs is: `{"name":"John","age":7}`

In a *key:value* pair, the key is always a string. For Db2, the value may be one of the following types:

- **Number** – an integer, decimal, or floating point number. The decimal point is always represented by a period.

Examples: 1, 3.14, 3E20

- **String** – a sequence of characters surrounded by quotes. Any special characters are escaped.

Examples: "John", "computer", "line 1\nline 2"

- **Null** – the omission of a value, indicated by *null*

- **Array** – square brackets surrounding an ordered list of zero or more values. The list of values may contain different types. The values in the array are separated using commas.

Examples: [1,2,3,"yes"]

```
{{"name":"Matt"},"{"name":"Tim"}}
```

- **Object** - another object

```
Examples: {"isbn":"123-456-222","author": ["Jones","Smith"]}
```

```
{"isbn":"123-456-222","author": [{"name":"Jones"},"{"name":"Smith"}]}
```

Whitespace is allowed between pieces of JSON. However, when Db2 generates JSON, no whitespace is added.

The following escape sequences are recognized.

Escape sequence	Description
\b	backspace
\f	form feed
\n	newline
\r	carriage return
\t	tab
\"	quotation mark
\\	backslash
\/	forward slash
\unnnn	Unicode hex value

JSON path

In order to retrieve elements from a JSON object, a path expression is used. An SQL/JSON path expression begins with a JSON path mode, which is either *lax* or *strict*. This mode will be discussed below. The JSON path mode is followed by an *sql-json-path-expression*. This path expression begins with the context identifier, \$, which is followed by accessors to navigate to the next key or array element. A key accessor begins with a period and is followed by a keyname. An array accessor begins with a left square bracket, followed by a zero-based index value, and ends with a right square bracket. The following table illustrates some examples of using the SQL/JSON path language to navigate to the various elements of a JSON object. The initial JSON is:

```
{"isbn": "123-456-222", "author": [{"name": "Jones"}, {"name": "Smith"}]}
```

Path	Value
\$	{ "isbn": "123-456-222", "author": [{"name": "Jones"}, {"name": "Smith"}] }
\$.isbn	"123-456-222"
\$.author	[{"name": "Jones"}, {"name": "Smith"}]
\$.author[0]	{ "name": "Jones" }
\$.author[1]	{ "name": "Smith" }
\$.author[0].name	"Jones"

For more information on SQL/JSON path expressions, see [sql-json-path-expression](#).

Strict and lax modes

Two modes can be used for JSON path expressions: *strict* and *lax*.

- In *strict* mode, if a structural error is encountered while using the JSON path (such as specifying a key that does not exist or referencing an object with an array accessor), an error is reported.

- In *lax* mode, automatic handling of some structural problems is performed. Non-structural errors are reported in *lax* mode.
 - **Automatic unnesting of arrays:** If a key accessor in an SQL/JSON path expression encounters an array instead of an object, the array is converted to a sequence containing the array elements. The key accessor (and remaining path in the path expression) is then applied to each element in the sequence. This has the same effect as if the array accessor [***] was present before the key accessor.
 - **Automatic wrapping of values into single element arrays:** If an array accessor encounters a JSON value other than an array, the JSON value is converted to a single element array before the array accessor handles the value.
 - **Error handling:** If a structural error cannot be handled by automatic nesting or wrapping, the result of the path navigation is an empty SQL/JSON sequence.

Using *strict* mode can be useful to help determine why unexpected results (including no results) are returned when using a path. Since *lax* mode is forgiving, it can modify an incorrect path specification and return something other than what you intended. By changing to *strict* mode, any structural errors are diagnosed and returned to you as an error.

JSON formats

When working with formatted JSON data, there are two formats that can be used to represent the data: FORMAT JSON and FORMAT BSON. All the SQL functions and predicates provide an option for you to specify the format of incoming JSON data and the format of any generated JSON data.

If a format is not specified for an input value, the data type will be used to determine the format. If the data type is character or graphic, the JSON will be interpreted as FORMAT JSON. If the data type is a binary type, the JSON will be interpreted as FORMAT BSON.

JSON data generated using the publishing functions defaults to FORMAT JSON.

FORMAT JSON

The data is constructed as a string of characters. This data can be stored as:

- a character string data type with any EBCDIC or Unicode CCSID except 65535
- a Unicode graphic data type
- a binary data type where it can be encoded in either a UTF8 or UTF16 representation

Data formatted as JSON has strings enclosed in quotes and special characters are escaped.

FORMAT BSON

The data is encoded in the binary form of JSON. This form of data must be stored as a VARBINARY or BLOB data type. FORMAT BSON data should never be copied into a fixed length binary data type since every byte of a BSON value is important; appending additional trailing bytes, even hex zeros, changes the value and will invalidate it.²

When a decimal number is converted into FORMAT BSON, either explicitly or implicitly, it becomes a double precision floating point number. This means that its precision will be no more than 15 digits.

Processing for JSON_TABLE, JSON_QUERY, JSON_VALUE and JSON_EXISTS is performed using the FORMAT BSON representation. If the input to these functions is already FORMAT BSON, an additional conversion will be avoided. If you store a JSON document in a table and intend to use one of these functions to interpret it, it is recommended that you store it as FORMAT BSON.

When using the JSON_OBJECT, JSON_ARRAY, JSON_OBJECTAGG, and JSON_ARRAYAGG functions to build a JSON document, Db2 uses FORMAT JSON for processing. It is recommended that the result of each function that is input to another function returns FORMAT JSON (the default). If you need the final result to be FORMAT BSON, add the result data type and the FORMAT BSON clause to the outermost scalar function.

² As part of an earlier JSON technology preview, JSON was generated in a non-standard BSON format that was prepended with a single x'03' byte. With the addition of the standard JSON functionality, this format will continue to be recognized but will never be generated. If you have an application that depends on this format, there is an undocumented function, SYSTOOLS.JSON2BSON, that can be used to generate it.

JSON_TO_BSON and BSON_TO_JSON

These two built-in scalar functions can be used to convert between JSON and BSON formatted data. If you have stored JSON data in a table and need to send it to an external site, these functions make it easy to change it to the expected format. The input argument for JSON_TO_BSON must be formatted JSON or the function will fail. Similarly, the input argument for BSON_TO_JSON must be BSON or the function will fail.

IS JSON predicate

The IS JSON predicates can be used in a query to validate JSON data. Since there is not a JSON data type, using this predicate in a trigger can ensure JSON is well-formed before inserting it in a table.

Consuming a JSON document

There are four ways of using a path to extract parts of a JSON document.

JSON construct	Description
JSON_EXISTS predicate	Uses the path to determine whether a value can be located in the JSON document. Since this is a predicate, the result is true, false, or unknown.
JSON_QUERY scalar function	Uses the path to locate and return a JSON scalar value, a JSON array, or a JSON object from a JSON document. The data type of the result is always a string and it contains a FORMAT JSON value.
JSON_VALUE scalar function	Uses the path to locate and return an SQL scalar value from a JSON document. It cannot return a JSON array or a JSON object. The data type of the result is defined as part of the function invocation.
JSON_TABLE table function	Converts all or part of a JSON document into a relational table that can be queried. A distinct path is used to locate values for each result column.

JSON_TABLE is the recommended way to return multiple elements from a JSON document since the JSON document only needs to be deconstructed one time.

Using JSON_TABLE

The JSON_TABLE table function converts a JSON document into a relational table.

We will work with the following table, EMP, which contains four rows with one JSON object per row. By using the JSON_TABLE function we will extract the data so that it can be treated as relational data.

```
CREATE TABLE emp(jsondoc VARCHAR(32000) CCSID 1208);

INSERT INTO emp VALUES
'{"id":901, "name" : { "first":"John", "last":"Doe" }, "office" : "E-334",
"phones" : [ { "type":"home", "number":"555-3762" },
{ "type":"work", "number":"555-7242" } ],
"accounts" : [ { "number":"36232"}, { "number":"73263"} ] }';

INSERT INTO emp VALUES
'{"id":902, "name" : { "first":"Peter", "last":"Pan" }, "office" : "E-216",
"phones" : [ { "type":"work", "number":"555-8925" } ],
"accounts" : [ { "number":"76232"}, { "number":"72963"} ] }';

INSERT INTO emp VALUES
'{"id":903, "name" : { "first":"Mary", "last":"Jones" }, "office" : "E-739",
"phones" : [ { "type":"work", "number":"555-4311" },
{ "type":"home", "number":"555-6312" } ], }';

INSERT INTO emp VALUES
'{"id":904, "name" : { "first":"Sally", "last":"Smith" } }';
```

The JSON_TABLE function consists of three parts.

1. The JSON object to be deconstructed.
2. A path expression that generates zero or more rows from the JSON object.
3. The definition of the result columns to be returned. This includes the column name, the result data type, and a path expression to use to locate the column information.

Returning Simple Information

First we will use `JSON_TABLE` to extract employee names and office numbers from the JSON stored in the `EMP` table.

```
SELECT t.first, t.last, t.office
FROM emp,
     JSON_TABLE(
         emp.jsondoc,
         'lax $'
         COLUMNS (
             first VARCHAR(10) PATH 'lax $.name.first',
             last VARCHAR(10) PATH 'lax $.name.last',
             office VARCHAR(10) PATH 'lax $.office'
         )
     ) AS t;
```

In this example, the first argument indicates the source of the JSON to process, in this case column `JSONDOC` in table `EMP`. The second argument is the path to the starting point in the JSON document. `$` indicates to start at the beginning. Next are the definitions for the result columns. Each has a name, a data type, and the path to use to find the column data in the JSON object. For each of these columns, the column path is specified to use the current context (`$`), followed by the key name for the values.

The result of this query is:

FIRST	LAST	OFFICE
John	Doe	E-334
Peter	Pan	E-216
Mary	Jones	E-739
Sally	Smith	(null)

Notice that the structural error due to Sally Smith not having an office is returned as the null value. There are two factors that affect this behavior. Since `lax` was used for the office column's path, the structural error was ignored and null was returned. If `strict` had been used for the office path, the path navigation would have returned an error. The default behavior for `JSON_TABLE` when an error is returned for a column is to return the null value. You can override this for `strict` mode by adding the `ERROR ON ERROR` clause to the column definition.

Returning JSON Formatted Data

`JSON_TABLE` has the ability to return a column that contains data formatted as JSON. This is accomplished by using the keywords `FORMAT JSON` in the column definition. The result must consist of a single value: a JSON object, a JSON array, or a scalar value.

Here is an example of using `JSON_TABLE` to extract the employee name information as JSON data.

```
SELECT t.id, t.name, t.office
FROM emp,
     JSON_TABLE(
         emp.jsondoc,
         'lax $'
         COLUMNS (
             id INTEGER PATH 'lax $.id',
             name VARCHAR(100) FORMAT JSON PATH 'lax $.name',
             office VARCHAR(10) FORMAT JSON PATH 'lax $.office'
         )
     ) AS t;
```

This query produces the following result:

ID	NAME	OFFICE
901	{"first":"John","last":"Doe"}	"E-334"
902	{"first":"Peter","last":"Pan"}	"E-216"
903	{"first":"Mary","last":"Jones"}	"E-739"
904	{"first":"Sally","last":"Smith"}	(null)

Note that the NAME column returns strings which represent JSON formatted objects.

When the path for a FORMAT JSON column results in a string value, the default behavior is to return the quotes for string values. This is the result shown for the OFFICE column. The OMIT QUOTES ON SCALAR STRING clause can be used to remove the quotes from scalar strings.

There is another option not demonstrated here that applies when returning FORMAT JSON data. If the path locates a sequence of JSON objects, they must be wrapped in an array in order to be successfully returned as a JSON value. This can be done using the WITH ARRAY WRAPPER clause. The default is to not add a wrapper, which would result in an error.

Handling a JSON array

When returning information from a JSON array, each array element is returned as a separate row in the result table. Now we are going to use JSON_TABLE to extract the telephone types and numbers which are in a JSON array.

```
SELECT t.type, t.number
FROM emp,
     JSON_TABLE(
         emp.jsondoc,
         'lax $.phones[*]'
         COLUMNS (
             type VARCHAR(20) PATH 'lax $.type',
             number VARCHAR(20) PATH 'lax $.number'
         )
     ) AS t;
```

In this example, the path expression is \$.phones[*] meaning all the elements of the phones array. The column path expression used to find the column data in the JSON object is the context item, \$, followed by the key name for the value to be returned. In this case, the context item is the result of the parent path expression, \$.phones[*].

The result of this query is:

TYPE	NUMBER
home	555-3762
work	555-7242
work	555-8925
work	555-4311
home	555-6312

Handling nested information

In the previous example, returning only the phone numbers isn't very useful because the information about the person associated with the number is not returned. In order to get this information, we need to define a nested column. A nested column allows array values to be associated with data items that exist at a higher level in a multi-level JSON object.

In this example we use nested columns to return the names associated with the phone numbers.

```
SELECT t.*
FROM emp,
```

```

JSON_TABLE(
  emp.jsondoc,
  'lax $'
  COLUMNS (
    outer_ordinality FOR ORDINALITY,
    first VARCHAR(10) PATH 'lax $.name.first',
    last VARCHAR(10) PATH 'lax $.name.last',
    NESTED PATH 'lax $.phones[*]'
      COLUMNS (
        nested_ordinality FOR ORDINALITY,
        type VARCHAR(20) PATH 'lax $.type',
        number VARCHAR(20) PATH 'lax $.number'
      )
  )
) AS t;

```

The row path expression is \$, meaning the top level of the JSON object. The first and second columns return the first and last names. This is followed by a nested column definition. The path lax \$. phone [*] for the nested path means to process all the elements of the phones array. Within that array, the type and number values of the array elements are returned as the final two columns in the table.

This query also demonstrates the concept of an ordinality column. This is a column that generates a number, starting from 1, for each result row for each invocation of JSON_TABLE.

The result of this query is:

OUTER_ORDINALITY	FIRST	LAST	NESTED_ORDINALITY	TYPE	NUMBER
1	John	Doe	1	home	555-3762
1	John	Doe	2	work	555-7242
1	Peter	Pan	1	work	555-8925
1	Mary	Jones	1	work	555-4311
1	Mary	Jones	2	home	555-6312
1	Sally	Smith	1	(null)	(null)

In this example, there is a parent/child relationship between the nested levels. A LEFT OUTER JOIN is used to combine the information in the parent/child relationship. Since Sally Smith has no phone information, the LEFT OUTER JOIN returns NULL values for the phone columns.

Now let's examine the two ordinality columns. At the parent level, every row has the same ordinality value. While you might expect to see each row numbered sequentially, this query performs a separate invocation of JSON_TABLE for each JSONDOC row. For each invocation, the numbering starts at 1, so every row in the result ends up with 1 for OUTER_ORDINALITY. If the JSON used for this example had been one object containing all four employees, OUTER_ORDINALITY would have incremented for each employee object. For NESTED_ORDINALITY, the numbering restarts at 1 every time the parent changes.

Sibling Nesting

Nested columns can exist at the same level. The following example uses sibling nested columns to return both phone and account information. The first nested column clause accesses the phone information. A second nested column clause accesses the account information.

```

SELECT t.first, t.last, t.type, t.number, t.account
FROM emp,
  JSON_TABLE(
    emp.jsondoc,
    'lax $'
    COLUMNS (
      first VARCHAR(10) PATH 'lax $.name.first',
      last VARCHAR(10) PATH 'lax $.name.last',
      NESTED PATH 'lax $.phones[*]'
        COLUMNS (
          type VARCHAR(20) PATH 'lax $.type',
          number VARCHAR(20) PATH 'lax $.number'
        )
    )
  ) AS t;

```

```

),
NESTED PATH 'lax $.accounts[*]'
COLUMNS (
    account VARCHAR(20) PATH 'lax $.number'
)
) AS t;

```

The result of this query is:

FIRST	LAST	TYPE	NUMBER	ACCOUNT
John	Doe	home	555-3762	(null)
John	Doe	work	555-7242	(null)
John	Doe	(null)	(null)	36232
John	Doe	(null)	(null)	73263
Peter	Pan	work	555-8925	(null)
Peter	Pan	(null)	(null)	76232
Peter	Pan	(null)	(null)	72963
Mary	Jones	work	555-4311	(null)
Mary	Jones	home	555-6312	(null)
Mary	Jones	(null)	(null)	(null)
Sally	Smith	(null)	(null)	(null)
Sally	Smith	(null)	(null)	(null)

In this example, there is a sibling relationship between phone and account information. For sibling related nesting, a UNION is used to combine the information. Since the phone and account information are at the same level in the JSON document, there is no result row that contains both pieces of information.

Generating JSON data

By using SQL functions, you can generate formatted JSON data from relational tables.

We are going to work with relational data to generate JSON. We will start with the data in two tables. One contains basic employee data. The other one contains account information. They are created and populated as shown here.

```

create table empdata (id int,
    last_name varchar(10),
    first_name varchar(10),
    office_number varchar(10),
    work_phone varchar(20),
    home_phone varchar(20));

create table emp_account (id int,
    account varchar(20));

insert into empdata values (901, 'Doe', 'John', 'E-334', '555-7242', '555-3762');
insert into emp_account values (901, '36232'), (901, '73263');

insert into empdata values (902, 'Pan', 'Peter', 'E-216', '555-8925', null);
insert into emp_account values (902, '76232'), (902, '72963');

insert into empdata values (903, 'Jones', 'Mary', 'E-739', '555-4311', '555-6312');

insert into empdata values (904, 'Smith', 'Sally', null, null, null);

```

Our goal is to generate four pieces of employee information in JSON that look like the following JSON objects that were used as input for the JSON_TABLE examples.

```

{"id":901, "name" : { "first":"John", "last":"Doe" }, "office" : "E-334",
  "phones" : [ { "type":"home", "number":"555-3762" },
    { "type":"work", "number":"555-7242" } ],
  "accounts" : [ { "number":"36232"}, { "number":"73263"}] }

{"id":902, "name" : { "first":"Peter", "last":"Pan" }, "office" : "E-216",
  "phones" : [ { "type":"work", "number":"555-8925" } ],
  "accounts" : [ { "number":"76232"}, { "number":"72963"}] }

{"id":903, "name" : { "first":"Mary", "last":"Jones" }, "office" : "E-739",
  "phones" : [ { "type":"home", "number":"555-6312" },
    { "type":"work", "number":"555-4311" } ], }

{"id":904, "name" : { "first":"Sally", "last":"Smith" } }

```

Building a basic JSON object

Let's start with a simple example to see how easy it is to generate a basic JSON object.

```

select json_object ('id' value id,
                   'name' value last_name,
                   'office' value office_number)
from empdata;

```

This example uses the `JSON_OBJECT` scalar function to generate a JSON object. It defines three *key:value* pairs using the `ID`, `LAST_NAME`, and `OFFICE_NUMBER` columns from the `EMPDATA` table for the values. Each key name is specified as a character string exactly as it will appear in the output. The result of this query is four rows, one for each row in the `EMPDATA` table.

```

{"id":901,"name":"Doe","office":"E-334"}
{"id":902,"name":"Pan","office":"E-216"}
{"id":903,"name":"Jones","office":"E-739"}
{"id":904,"name":"Smith","office":null}

```

That is a good start toward our final goal, but maybe we want to omit the `office` value when it is null rather than including it. That is easy to do by using the `ABSENT ON NULL` clause. This indicates that when any of the values for the JSON object are the null value, the null *key:value* pair should not be included in the result.

```

select json_object ('id' value id,
                   'name' value last_name,
                   'office' value office_number
                   absent on null)
from empdata;

```

Now there is no `office` value for 904.

```

{"id":901,"name":"Doe","office":"E-334"}
{"id":902,"name":"Pan","office":"E-216"}
{"id":903,"name":"Jones","office":"E-739"}
{"id":904,"name":"Smith"}

```

Nesting JSON objects

Next, we will work to embed the compound name object. First, let's generate it on its own.

```

select json_object ('first' value first_name,
                   'last' value last_name)
from empdata;

```

The result of this query is:

```

{"first":"John","last":"Doe"}
{"first":"Peter","last":"Pan"}
{"first":"Mary","last":"Jones"}
{"first":"Sally","last":"Smith"}

```

Since that looks correct, we will include it in the master query. All we need to do is embed this name JSON object within the outer one.

```
select json_object ('id' value id,
                  'name' value json_object ( 'first' value first_name,
                                           'last' value last_name),
                  'office' value office_number
                  absent on null)
from empdata;
```

Now our result looks like this, with a name object nested within the outer JSON object:

```
{ "id": 901, "name": { "first": "John", "last": "Doe" }, "office": "E-334" }
{ "id": 902, "name": { "first": "Peter", "last": "Pan" }, "office": "E-216" }
{ "id": 903, "name": { "first": "Mary", "last": "Jones" }, "office": "E-739" }
{ "id": 904, "name": { "first": "Sally", "last": "Smith" } }
```

Building a JSON array

Next we will tackle the phone array. This needs to be a JSON array, not a JSON object. That means we will use the JSON_ARRAY scalar function. To avoid generating array entries for phone numbers that are not provided, a CASE statement is used. If neither phone number exists, an empty JSON array will be generated. Since we know whether we are generating the home or work phone numbers, we specify type values as home and work.

```
select json_array
      (case when home_phone is not null then
        json_object('type' value 'home',
                   'number' value home_phone) end,
       case when work_phone is not null then
        json_object('type' value 'work',
                   'number' value work_phone) end
      )
from empdata;
```

Here is the result. The output for each entry is broken across two lines to show the complete result.

```
["{\\"type\\":\\"home\\",\\"number\\":\\"555-3762\\"}",
  {"\\type\\":\\"work\\",\\"number\\":\\"555-7242\\"}"]
["{\\"type\\":\\"work\\",\\"number\\":\\"555-8925\\"}"]
["{\\"type\\":\\"home\\",\\"number\\":\\"555-6312\\"}",
  {"\\type\\":\\"work\\",\\"number\\":\\"555-4311\\"}"]
[]
```

This is a bit unexpected. Why are all those extra `\` characters in the result? This demonstrates the difference between processing normal character data and character data that has already been formatted as JSON. When JSON_ARRAY (or any of the JSON publishing functions) is looking at its arguments, it recognizes when the argument is the direct result of another JSON function. If it is, the string is interpreted as already formatted JSON data. That means that the function will not escape any of the special characters in the string. If the argument is not the direct result of a JSON function, it is interpreted as non-JSON character data and escape processing is performed on the value. Since this example embedded the JSON_OBJECT in a CASE expression, the fact that the string was already formatted JSON is not known. To avoid these unwanted escape sequences, you need to explicitly tell JSON_ARRAY that the argument is already JSON by using the FORMAT JSON clause.

With that knowledge, let's try it again.

```
select json_array
      (case when home_phone is not null then
        json_object('type' value 'home',
                   'number' value home_phone) end
       format json,
       case when work_phone is not null then
        json_object('type' value 'work',
                   'number' value work_phone) end
       format json)
from empdata;
```

Now the result is:

```
[{"type": "home", "number": "555-3762"}, {"type": "work", "number": "555-7242"}]
[{"type": "work", "number": "555-8925"}]
[{"type": "home", "number": "555-6312"}, {"type": "work", "number": "555-4311"}]
[]
```

Now this information is ready to include as the next piece of our larger JSON object.

```
select json_object ('id' value id,
                  'name' value json_object ( 'first' value first_name,
                                           'last' value last_name),
                  'office' value office_number,
                  'phones' value json_array
                        (case when home_phone is not null then
                          json_object('type' value 'home',
                                      'number' value home_phone
                                   ) end format json,
                        case when work_phone is not null then
                          json_object('type' value 'work',
                                      'number' value work_phone
                                   ) end format json)
                        absent on null)
from empdata;
```

This returns:

```
{"id": 901, "name": {"first": "John", "last": "Doe"}, "office": "E-334",
 "phones": [{"type": "home", "number": "555-3762"}, {"type": "work", "number": "555-7242"}]}
{"id": 902, "name": {"first": "Peter", "last": "Pan"}, "office": "E-216",
 "phones": [{"type": "work", "number": "555-8925"}]}
{"id": 903, "name": {"first": "Mary", "last": "Jones"}, "office": "E-739",
 "phones": [{"type": "home", "number": "555-6312"}, {"type": "work", "number": "555-4311"}]}
{"id": 904, "name": {"first": "Sally", "last": "Smith"},
 "phones": []}
```

Building an array from multiple rows of data

We are almost done. We need to pick up the account information which is stored in a separate table and put it in an array. Let's generate an array of objects that contain account numbers.

```
select json_array(json_object('number' value account))
from emp_account;
```

The result of this query is:

```
[{"number": "36232"}]
[{"number": "73263"}]
[{"number": "76232"}]
[{"number": "72963"}]
```

That generated one array for each account number. What we need is one array for each ID value. That requires aggregating all the number JSON objects for a single ID value into a single array.

```
select json_arrayagg(json_object('number' value account))
from emp_account group by id;
```

JSON_ARRAYAGG is an aggregate function that works on groups of data. In this case, we are grouping on the ID column. Each account for an ID generates an object, then all of those objects are aggregated into a single array. This query returns only two rows, one for each ID value which is exactly what we were looking for.

```
[{"number": "36232"}, {"number": "73263"}]
[{"number": "76232"}, {"number": "72963"}]
```

This piece can be added to what we have so far to complete the generated JSON object. To return only the accounts from the EMP_ACCOUNT table for the current ID, a WHERE clause is needed. Also note that

since the account array is being returned from a query, a FORMAT JSON clause needs to be added so the outer JSON_OBJECT correctly identifies the value as JSON that is already formatted.

```
select json_object ('id' value id,
                  'name' value json_object ( 'first' value first_name,
                                           'last' value last_name),
                  'office' value office_number,
                  'phones' value json_array
                    (case when home_phone is not null then
                      json_object('type' value 'home',
                                  'number' value home_phone
                                ) end format json,
                    case when work_phone is not null then
                      json_object('type' value 'work',
                                  'number' value work_phone
                                ) end format json),
                  'accounts' value (select json_arrayagg(
                                   json_object('number' value account))
                                   from emp_account a
                                   where a.id = e.id group by id) format json
                    absent on null)
from empdata e;
```

Now we have arrived at our final result.

```
{ "id": 901, "name": { "first": "John", "last": "Doe" }, "office": "E-334",
  "phones": [ { "type": "home", "number": "555-3762" },
              { "type": "work", "number": "555-7242" } ],
  "accounts": [ { "number": "36232" }, { "number": "73263" } ] }

{ "id": 902, "name": { "first": "Peter", "last": "Pan" }, "office": "E-216",
  "phones": [ { "type": "work", "number": "555-8925" } ],
  "accounts": [ { "number": "76232" }, { "number": "72963" } ] }

{ "id": 903, "name": { "first": "Mary", "last": "Jones" }, "office": "E-739",
  "phones": [ { "type": "home", "number": "555-6312" },
              { "type": "work", "number": "555-4311" } ] }

{ "id": 904, "name": { "first": "Sally", "last": "Smith" }, "phones": [] }
```

Combining JSON into one object

Let's take this one step further. Sometimes you need a single JSON document containing all the information. We will take the individual results and bundle them together.

```
select json_object('employees' value json_arrayagg(
  json_object ('id' value id,
              'name' value json_object ( 'first' value first_name,
                                       'last' value last_name),
              'office' value office_number,
              'phones' value json_array
                (case when home_phone is not null then
                  json_object('type' value 'home',
                              'number' value home_phone
                            ) end format json,
                case when work_phone is not null then
                  json_object('type' value 'work',
                              'number' value work_phone
                            ) end format json),
              'accounts' value (select json_arrayagg(
                               json_object('number' value account))
                               from emp_account a
                               where a.id = e.id group by id) format json
                absent on null)))
from empdata e;
```

First we wrap the results with a JSON_ARRAYAGG to create an array of employee information. Then we wrap the array with a JSON_OBJECT so the final result is a single JSON object. Now the result is one JSON object.

```
{ "employees": [
  { "id": 901, "name": { "first": "John", "last": "Doe" }, "office": "E-334",
    "phones": [ { "type": "home", "number": "555-3762" },
                { "type": "work", "number": "555-7242" } ],
    "accounts": [ { "number": "36232" }, { "number": "73263" } ] }
  ] }
```

```

    "accounts": [{ "number": "36232"}, { "number": "73263" } ] },
  { "id": 902, "name": { "first": "Peter", "last": "Pan" }, "office": "E-216",
    "phones": [{ "type": "work", "number": "555-8925" } ],
    "accounts": [{ "number": "76232"}, { "number": "72963" } ] },
  { "id": 903, "name": { "first": "Mary", "last": "Jones" }, "office": "E-739",
    "phones": [{ "type": "home", "number": "555-6312" },
      { "type": "work", "number": "555-4311" } ] },
  { "id": 904, "name": { "first": "Sally", "last": "Smith" }, "phones": [ ] }
] }

```

Setting the result data type

Each of the publishing functions allows you to specify the data type and format of the function's result. If you omit the RETURNING clause, the result will be a CLOB with a length of 2G and a CCSID of 1208. It will be formatted as FORMAT JSON. If you require a different result such as BSON in a VARBINARY(2000) column, add the RETURNING clause as shown here:

```

select json_object ('id' value id,
                  'name' value last_name,
                  'office' value office_number
                  returning varbinary(2000) format bson)
from empdata;

```

Using a common table expression to aggregate distinct values

Suppose we want to aggregate the sales information for each sales person, listing each region in which a sale was made. In the SALES table there is an entry for every sale that was made. We need a list of the unique sales people and a list of the regions for each sales person. These are generated by using a common table expression for each one. These temporary results are used for generating the JSON objects, one for each sales person.

```

with sales_tmp(sales_person) as (
  select distinct(sales_person) from sales),
  region_tmp(region,sales_person) as (
  select distinct region, sales_person from sales)

select json_object( key sales_person
                  value (select JSON_ARRAYAGG(region order by region)
                        from region_tmp r where r.sales_person = s.sales_person)
                  format json)
FROM sales_tmp s order by sales_person;

```

From the sample table, the following three rows are returned:

```

{"GOUNOT":["Manitoba","Ontario-North","Ontario-South","Quebec"]}
{"LEE":["Manitoba","Ontario-North","Ontario-South","Quebec"]}
{"LUCCHESSI":["Manitoba","Ontario-South","Quebec"]}

```

If you want to return a single JSON object containing all the results, the following query using JSON_OBJECTAGG will generate it for you.

```

with sales_tmp(sales_person) as (
  select distinct(sales_person) from sales),
  region_tmp(region,sales_person) as (
  select distinct region, sales_person from sales)

select json_objectagg( key sales_person
                    value (select JSON_ARRAYAGG(region order by region)
                          from region_tmp r where r.sales_person = s.sales_person)
                    format json)
FROM sales_tmp s;

```

This returns one row containing one JSON object. It is broken into several lines here to make it easy to read.

```

{"LEE":["Manitoba","Ontario-North","Ontario-South","Quebec"],
"GOUNOT":["Manitoba","Ontario-North","Ontario-South","Quebec"],
"LUCCHESSI":["Manitoba","Ontario-South","Quebec"]}

```

Using SQL in different environments

You can use SQL in many different environments.

Using a cursor

When SQL runs a SELECT statement, the resulting rows comprise the result table. A cursor provides a way to access a result table.

It is used within an SQL program to maintain a position in the result table. SQL uses a cursor to work with the rows in the result table and to make them available to your program. Your program can have several cursors, although each must have a unique name.

Statements related to using a cursor include the following:

- A DECLARE CURSOR statement to define and name the cursor and specify the rows to be retrieved with the embedded select statement.
- OPEN and CLOSE statements to open and close the cursor for use within the program. The cursor must be opened before any rows can be retrieved.
- A FETCH statement to retrieve rows from the cursor's result table or to position the cursor on another row.
- An UPDATE ... WHERE CURRENT OF statement to update the current row of a cursor.
- A DELETE ... WHERE CURRENT OF statement to delete the current row of a cursor.

Related reference

[Updating data as it is retrieved from a table](#)

You can update rows of data as you retrieve them by using a cursor.

[CLOSE](#)

[DECLARE CURSOR](#)

[DELETE](#)

[FETCH](#)

[UPDATE](#)

Types of cursors

SQL supports serial and scrollable cursors. The type of cursor determines the positioning methods that can be used with the cursor.

Serial cursor

A serial cursor is one defined without the SCROLL keyword.

For a serial cursor, each row of the result table can be fetched only once per OPEN of the cursor. When the cursor is opened, it is positioned before the first row in the result table. When a FETCH is issued, the cursor is moved to the next row in the result table. That row is then the current row. If host variables are specified (with the INTO clause on the FETCH statement), SQL moves the current row's contents into your program's host variables.

This sequence is repeated each time a FETCH statement is issued until the end-of-data (SQLCODE = 100) is reached. When you reach the end-of-data, close the cursor. You cannot access any rows in the result table after you reach the end-of-data. To use a serial cursor again, you must first close the cursor and then re-issue the OPEN statement. You can never back up using a serial cursor.

Scrollable cursor

For a scrollable cursor, the rows of the result table can be fetched many times. The cursor is moved through the result table based on the position option specified on the FETCH statement. When the cursor is opened, it is positioned before the first row in the result table. When a FETCH is issued, the cursor

is positioned to the row in the result table that is specified by the position option. That row is then the current row. If host variables are specified (with the INTO clause on the FETCH statement), SQL moves the current row's contents into your program's host variables. Host variables cannot be specified for the BEFORE and AFTER position options.

This sequence is repeated each time a FETCH statement is issued. The cursor does not need to be closed when an end-of-data or beginning-of-data condition occurs. The position options enable the program to continue fetching rows from the table.

The following scroll options are used to position the cursor when issuing a FETCH statement. These positions are relative to the current cursor location in the result table.

NEXT	Positions the cursor on the next row. This is the default if no position is specified.
PRIOR	Positions the cursor on the previous row.
FIRST	Positions the cursor on the first row.
LAST	Positions the cursor on the last row.
BEFORE	Positions the cursor before the first row.
AFTER	Positions the cursor after the last row.
CURRENT	Does not change the cursor position.
RELATIVE n	Evaluates a host variable or integer <i>n</i> in relationship to the cursor's current position. For example, if <i>n</i> is -1, the cursor is positioned on the previous row of the result table. If <i>n</i> is +3, the cursor is positioned three rows after the current row.

For a scrollable cursor, the end of the table can be determined by the following:

```
FETCH AFTER FROM C1
```

Once the cursor is positioned at the end of the table, the program can use the PRIOR or RELATIVE scroll options to position and fetch data starting from the end of the table.

Examples: Using a cursor

These examples show the SQL statements that you can include in a program to define and work with a serial and a scrollable cursor.

Suppose that your program examines data about people in department D11. You can use either a serial or a scrollable cursor to obtain information about the department from the CORPDATA.EMPLOYEE table.

For the serial cursor example, the program processes all of the rows from the table, updating the job for all members of department D11 and deleting the records of employees from the other departments.

Table 55. A serial cursor example

Serial cursor SQL statement	Described in section
<pre>EXEC SQL DECLARE THISEMP CURSOR FOR SELECT EMPNO, LASTNAME, WORKDEPT, JOB FROM CORPDATA.EMPLOYEE FOR UPDATE OF JOB END-EXEC.</pre>	<p>“Step 1: Defining the cursor” on page 291.</p>

Table 55. A serial cursor example (continued)

Serial cursor SQL statement	Described in section
EXEC SQL OPEN THISEMP END-EXEC.	“Step 2: Opening the cursor” on page 292.
EXEC SQL WHENEVER NOT FOUND GO TO CLOSE-THISEMP END-EXEC.	“Step 3: Specifying what to do when the end of data is reached” on page 292.
EXEC SQL FETCH THISEMP INTO :EMP-NUM, :NAME2, :DEPT, :JOB-CODE END-EXEC.	“Step 4: Retrieving a row using a cursor” on page 293.
... for all employees in department D11, update the JOB value:	“Step 5a: Updating the current row” on page 293.
EXEC SQL UPDATE CORPDATA.EMPLOYEE SET JOB = :NEW-CODE WHERE CURRENT OF THISEMP END-EXEC.	
... then print the row.	
... for other employees, delete the row:	“Step 5b: Deleting the current row” on page 294.
EXEC SQL DELETE FROM CORPDATA.EMPLOYEE WHERE CURRENT OF THISEMP END-EXEC.	
Branch back to fetch and process the next row.	
CLOSE-THISEMP. EXEC SQL CLOSE THISEMP END-EXEC.	“Step 6: Closing the cursor” on page 294.

For the scrollable cursor example, the program uses the RELATIVE position option to obtain a representative sample of salaries from department D11.

Table 56. A scrollable cursor example

Scrollable cursor SQL statement	Described in section
<pre>EXEC SQL DECLARE THISEMP DYNAMIC SCROLL CURSOR FOR SELECT EMPNO, LASTNAME, SALARY FROM CORPDATA.EMPLOYEE WHERE WORKDEPT = 'D11' END-EXEC.</pre>	“Step 1: Defining the cursor” on page 291.
<pre>EXEC SQL OPEN THISEMP END-EXEC.</pre>	“Step 2: Opening the cursor” on page 292.
<pre>EXEC SQL WHENEVER NOT FOUND GO TO CLOSE-THISEMP END-EXEC.</pre>	“Step 3: Specifying what to do when the end of data is reached” on page 292.
<pre>...initialize program summation salary variable EXEC SQL FETCH RELATIVE 3 FROM THISEMP INTO :EMP-NUM, :NAME2, :JOB-CODE END-EXEC. ...add the current salary to program summation salary ...branch back to fetch and process the next row.</pre>	“Step 4: Retrieving a row using a cursor” on page 293.
<pre>...calculate the average salary</pre>	
<pre>CLOSE-THISEMP. EXEC SQL CLOSE THISEMP END-EXEC.</pre>	“Step 6: Closing the cursor” on page 294.

Step 1: Defining the cursor

To define a cursor to access the result table, use the DECLARE CURSOR statement.

The DECLARE CURSOR statement names a cursor and specifies a select-statement. The select-statement defines a set of rows that, conceptually, make up the result table. For a serial cursor, the statement looks like this (the FOR UPDATE OF clause is optional):

```
EXEC SQL
DECLARE cursor-name CURSOR FOR
SELECT column-1, column-2 ,...
FROM table-name , ...
FOR UPDATE OF column-2 ,...
END-EXEC.
```

For a scrollable cursor, the statement looks like this (the WHERE clause is optional):

```
EXEC SQL
  DECLARE cursor-name SCROLL CURSOR FOR
  SELECT column-1, column-2 ,...
  FROM table-name ,...
  WHERE column-1 = expression ...
END-EXEC.
```

The select-statements shown here are rather simple. However, you can code several other types of clauses in a select-statement within a DECLARE CURSOR statement for a serial and a scrollable cursor.

If you intend to update any columns in any or all of the rows of the identified table (the table named in the FROM clause), include the FOR UPDATE OF clause. It names each column you intend to update. If you do not specify the names of columns, and you specify either the ORDER BY clause or FOR READ ONLY clause, a negative SQLCODE is returned if an update is attempted. If you do not specify the FOR UPDATE OF clause, the FOR READ ONLY clause, the ORDER BY clause, and the result table is not read-only and the cursor is not scrollable, you can update any of the columns of the specified table.

You can update a column of the identified table even though it is not part of the result table. In this case, you do not need to name the column in the SELECT statement. When the cursor retrieves a row (using FETCH) that contains a column value you want to update, you can use UPDATE ... WHERE CURRENT OF to update the row.

For example, assume that each row of the result table includes the *EMPNO*, *LASTNAME*, and *WORKDEPT* columns from the CORPDATA.EMPLOYEE table. If you want to update the *JOB* column (one of the columns in each row of the CORPDATA.EMPLOYEE table), the DECLARE CURSOR statement should include FOR UPDATE OF JOB ... even though JOB is omitted from the SELECT statement.

For information about when the result table and cursor are read-only, see [DECLARE CURSOR](#) in the SQL reference topic collection.

Step 2: Opening the cursor

To begin processing the rows of the result table, issue the OPEN statement.

When your program issues the OPEN statement, SQL processes the select-statement within the DECLARE CURSOR statement to identify a set of rows, called a result table, using the current value of any host variables specified in the select-statement. A result table can contain zero, one, or many rows, depending on the extent to which the search condition is satisfied. The OPEN statement looks like this:

```
EXEC SQL
  OPEN cursor-name
END-EXEC.
```

Step 3: Specifying what to do when the end of data is reached

The end-of-data condition occurs when the FETCH statement has retrieved the last row in the result table and your program issues a subsequent FETCH statement.

To find out when the end of the result table is reached, test the SQLCODE field for a value of 100 or test the SQLSTATE field for a value of '02000' (that is, end of data).

For example:

```
...
IF SQLCODE =100 GO TO DATA-NOT-FOUND.

or

IF SQLSTATE = '02000' GO TO DATA-NOT-FOUND.
```

An alternative to this technique is to code the `WHENEVER` statement. Using `WHENEVER NOT FOUND` can result in a branch to another part of your program, where a `CLOSE` statement is issued. The `WHENEVER` statement looks like this:

```
EXEC SQL
  WHENEVER NOT FOUND GO TO symbolic-address
END-EXEC.
```

Your program should anticipate an end-of-data condition whenever a cursor is used to fetch a row, and should be prepared to handle this situation when it occurs.

When you are using a serial cursor and the end of data is reached, every subsequent `FETCH` statement returns the end-of-data condition. You cannot position the cursor on rows that are already processed. The `CLOSE` statement is the only operation that can be performed on the cursor.

When you are using a scrollable cursor and the end of data is reached, the result table can still process more data. You can position the cursor anywhere in the result table using a combination of the position options. You do not need to close the cursor when the end of data is reached.

Step 4: Retrieving a row using a cursor

To move the contents of a selected row into the host variables of your program, use the `FETCH` statement.

The `SELECT` statement within the `DECLARE CURSOR` statement identifies rows that contain the column values your program wants. However, SQL does not retrieve any data for your application program until the `FETCH` statement is issued.

When your program issues the `FETCH` statement, SQL uses the current cursor position as a starting point to locate the requested row in the result table. This changes that row to the **current row**. If an `INTO` clause was specified, SQL moves the current row's contents into your program's host variables. This sequence is repeated each time the `FETCH` statement is issued.

SQL maintains the position of the current row (that is, the cursor points to the current row) until the next `FETCH` statement for the cursor is issued. The `UPDATE` statement does not change the position of the current row within the result table, although the `DELETE` statement does.

The serial cursor `FETCH` statement looks like this:

```
EXEC SQL
  FETCH cursor-name
  INTO :host variable-1[, :host variable-2] ...
END-EXEC.
```

The scrollable cursor `FETCH` statement looks like this:

```
EXEC SQL
  FETCH RELATIVE integer
  FROM cursor-name
  INTO :host variable-1[, :host variable-2] ...
END-EXEC.
```

Step 5a: Updating the current row

When your program has positioned the cursor on a row, you can update the row by using the `UPDATE` statement with the `WHERE CURRENT OF` clause. The `WHERE CURRENT OF` clause specifies a cursor that points to the row that you want to update.

The `UPDATE ... WHERE CURRENT OF` statement looks like this:

```
EXEC SQL
  UPDATE table-name
  SET column-1 = value [, column-2 = value] ...
  WHERE CURRENT OF cursor-name
END-EXEC.
```

When used with a cursor, the `UPDATE` statement:

- Updates only one row—the current row

- Identifies a cursor that points to the row to be updated
- Requires that the columns updated be named previously in the FOR UPDATE OF clause of the DECLARE CURSOR statement, if an ORDER BY clause was also specified

After you update a row, the cursor's position remains on that row (that is, the current row of the cursor does not change) until you issue a FETCH statement for the next row.

Step 5b: Deleting the current row

When your program has retrieved the current row, you can delete the row by using the DELETE statement with the WHERE CURRENT OF clause. The WHERE CURRENT OF clause specifies a cursor that points to the row that you want to delete.

The DELETE ... WHERE CURRENT OF statement looks like this:

```
EXEC SQL
  DELETE FROM table-name
  WHERE CURRENT OF cursor-name
END-EXEC.
```

When used with a cursor, the DELETE statement:

- Deletes only one row—the current row
- Uses the WHERE CURRENT OF clause to identify a cursor that points to the row to be deleted

After you delete a row, you cannot update or delete another row using that cursor until you issue a FETCH statement to position the cursor.

You can use the DELETE statement to delete all rows that meet a specific search condition. You can also use the FETCH and DELETE ... WHERE CURRENT OF statements when you want to obtain a copy of the row, examine it, and then delete it.

Step 6: Closing the cursor

If you have processed the rows of a result table using a serial cursor, and you want to use the cursor again, issue a CLOSE statement to close the cursor before opening it again.

The statement looks like this:

```
EXEC SQL
  CLOSE cursor-name
END-EXEC.
```

If you processed the rows of a result table and you do not want to use the cursor again, you can let the system close the cursor. The system automatically closes the cursor when:

- A COMMIT without HOLD statement is issued and the cursor is not declared using the WITH HOLD clause.
- A ROLLBACK without HOLD statement is issued.
- The job ends.
- The activation group ends and CLOSQLCSR(*ENDACTGRP) was specified on the precompile.
- The first SQL program in the call stack ends and neither CLOSQLCSR(*ENDJOB) or CLOSQLCSR(*ENDACTGRP) was specified when the program was precompiled.
- The connection to the application server is ended using the DISCONNECT statement.
- The connection to the application server was released and a successful COMMIT occurred.
- An *RUW CONNECT occurred.

Because an open cursor still holds locks on referred-to-tables or views, you should explicitly close any open cursors as soon as they are no longer needed.

Example: Using the OFFSET clause with a cursor

This example shows how you can use the OFFSET clause with a cursor to read a logical page of data.

For some applications, you want to read a number of rows starting at a certain position in the result set. To do this, define your cursor using the OFFSET and the FETCH n ROWS clauses. The OFFSET clause indicates how many rows to skip in the result set before returning data. The FETCH n ROWS clause indicates the maximum number of rows to return. For example, if you have a query that returns 1000 rows but you only want to consume 50 rows starting with row 701, you would use OFFSET 700 ROWS FETCH NEXT 50 ROWS ONLY³.

In this example, define a procedure to return a cursor where the caller decides the offset position and the page size. The items returned will be ordered from least expensive to most expensive.

```
CREATE PROCEDURE GET_CATALOG_ROWS
  (offset_value INT DEFAULT 0,
   page_size INT DEFAULT 1000)
  RESULT SETS 1
  BEGIN
    DECLARE catalog_page CURSOR FOR
      SELECT * FROM catalog_list
      ORDER BY item_price
      OFFSET offset_value ROWS
      FETCH NEXT page_size ROWS ONLY;

    OPEN catalog_page;
  END
```

To call this procedure, you can pass the values for the offset and fetch clauses. If you omit the values, the defaults for the parameters will be used to always return the first 1000 rows. The following 3 calls to the procedure will return a cursor open to a result set of 100 rows skipping the number of rows identified by the first argument.

```
CALL GET_CATALOG_ROWS (0, 100);
CALL GET_CATALOG_ROWS (500, 100);
CALL GET_CATALOG_ROWS (250, 100);
```

Note that the ordering for this query is not deterministic if any items in the catalog have the same price. This means that when these items cross "page" boundaries, multiple calls to the procedure could return the same item for more than one page or an item could never be returned. It is important to take this into consideration when defining an ordering for your query.

When using a cursor to read through the resulting data, you cannot read any rows prior to the OFFSET position or beyond where FETCH NEXT n ROWS ends. These cases are treated as if you reached the beginning or end of the data. If the offset value is greater than the number of rows in the result query, no rows are returned.

Using the multiple-row FETCH statement

The multiple-row FETCH statement can be used to retrieve multiple rows from a table or view with a single FETCH statement. The program controls the blocking of rows by the number of rows requested on the FETCH statement (The Override Database File (OVRDBF) command has no effect.).

The maximum number of rows that can be requested on a single fetch call is 32 767. After the data is retrieved, the cursor is positioned on the last row retrieved.

There are two ways to define the storage where fetched rows are placed: a host structure array or a row storage area with an associated descriptor. Both methods can be coded in all of the languages supported by the SQL precompilers, with the exception of the host structure array in REXX. Both forms of the multiple-row FETCH statement allow the application to code a separate indicator array. The indicator array should contain one indicator for each host variable that is null capable.

³ You can use this alternate supported syntax: LIMIT 50 OFFSET 700.

The multiple-row FETCH statement can be used with both serial and scrollable cursors. The operations used to define, open, and close a cursor for a multiple-row FETCH remain the same. Only the FETCH statement changes to specify the number of rows to retrieve and the storage where the rows are placed.

After each multiple-row FETCH, information is returned to the program through the SQLCA. In addition to the SQLCODE and SQLSTATE fields, the SQLERRD provides the following information:

- SQLERRD3 contains the number of rows retrieved on the multiple-row FETCH statement. If SQLERRD3 is less than the number of rows requested, then an error or end-of-data condition occurred.
- SQLERRD4 contains the length of each row retrieved.
- SQLERRD5 contains an indication that the last row in the table was fetched. It can be used to detect the end-of-data condition in the table being fetched when the cursor does not have immediate sensitivity to updates. Cursors which do have immediate sensitivity to updates should continue fetching until an SQLCODE +100 is received to detect an end-of-data condition.

Related concepts

[Embedded SQL programming](#)

Multiple-row FETCH using a host structure array

To use the multiple-row FETCH statement with the host structure array, the application must define a host structure array that can be used by SQL.

Each language has its own conventions and rules for defining a host structure array. Host structure arrays can be defined by using variable declarations or by using compiler directives to retrieve External File Descriptions (such as the COBOL COPY directive).

The host structure array consists of an array of structures. Each structure corresponds to one row of the result table. The first structure in the array corresponds to the first row, the second structure in the array corresponds to the second row, and so on. SQL determines the attributes of elementary items in the host structure array based on the declaration of the host structure array. To maximize performance, the attributes of the items that make up the host structure array should match the attributes of the columns being retrieved.

Consider the following COBOL example:

Note: By using the code examples, you agree to the terms of the [“Code license and disclaimer information”](#) on page 396.

```
EXEC SQL INCLUDE SQLCA
END-EXEC.

...

01 TABLE-1.
  02 DEPT OCCURS 10 TIMES.
    05 EMPNO PIC X(6).
    05 LASTNAME.
      49 LASTNAME-LEN PIC S9(4) BINARY.
      49 LASTNAME-TEXT PIC X(15).
    05 WORKDEPT PIC X(3).
    05 JOB PIC X(8).
01 TABLE-2.
  02 IND-ARRAY OCCURS 10 TIMES.
    05 INDS PIC S9(4) BINARY OCCURS 4 TIMES.

...

EXEC SQL
DECLARE D11 CURSOR FOR
SELECT EMPNO, LASTNAME, WORKDEPT, JOB
FROM CORPDATA.EMPLOYEE
WHERE WORKDEPT = "D11"
END-EXEC.

...

EXEC SQL
OPEN D11
END-EXEC.
PERFORM FETCH-PARA UNTIL SQLCODE NOT EQUAL TO ZERO.
```

```

ALL-DONE.
EXEC SQL CLOSE D11 END-EXEC.

...

FETCH-PARA.
EXEC SQL WHENEVER NOT FOUND GO TO ALL-DONE END-EXEC.
EXEC SQL FETCH D11 FOR 10 ROWS INTO :DEPT :IND-ARRAY
END-EXEC.

...

```

In this example, a cursor was defined for the CORPDATA.EMPLOYEE table to select all rows where the WORKDEPT column equals 'D11'. The result table contains eight rows. The DECLARE CURSOR and OPEN statements do not have any special syntax when they are used with a multiple-row FETCH statement. Another FETCH statement that returns a single row against the same cursor can be coded elsewhere in the program. The multiple-row FETCH statement is used to retrieve all of the rows in the result table. Following the FETCH, the cursor position remains on the last row retrieved.

The host structure array DEPT and the associated indicator array IND-ARRAY are defined in the application. Both arrays have a dimension of ten. The indicator array has an entry for each column in the result table.

The attributes of type and length of the DEPT host structure array elementary items match the columns that are being retrieved.

When the multiple-row FETCH statement has successfully completed, the host structure array contains the data for all eight rows. The indicator array, IND_ARRAY, contains zeros for every column in every row because no NULL values were returned.

The SQLCA that is returned to the application contains the following information:

- SQLCODE contains 0
- SQLSTATE contains '00000'
- SQLERRD3 contains 8, the number of rows fetched
- SQLERRD4 contains 34, the length of each row
- SQLERRD5 contains +100, indicating the last row in the result table is in the block

Related reference

[SQLCA \(SQL communication area\)](#)

Multiple-row FETCH using a row storage area

Before using a multiple-row FETCH statement with the row storage area, the application must define a row storage area and an associated description area.

The row storage area is a host variable defined in the application. The row storage area contains the results of the multiple-row FETCH statement. A row storage area can be a character variable with enough bytes to hold all of the rows that are requested on the multiple-row FETCH statement.

An SQLDA that contains the SQLTYPE and SQLLEN for each returned column is defined by the associated descriptor used on the row storage area form of the multiple-row FETCH. The information provided in the descriptor determines the data mapping from the database to the row storage area. To maximize performance, the attribute information in the descriptor should match the attributes of the columns retrieved.

Consider the following PL/I example:

Note: By using the code examples, you agree to the terms of the [“Code license and disclaimer information”](#) on page 396.

```

*...+...1...+...2...+...3...+...4...+...5...+...6...+...7...*
EXEC SQL INCLUDE SQLCA;
EXEC SQL INCLUDE SQLDA;

...

```

```

DCL DEPTPTR PTR;
DCL 1 DEPT(20) BASED(DEPTPTR),
    3 EMPNO CHAR(6),
    3 LASTNAME CHAR(15) VARYING,
    3 WORKDEPT CHAR(3),
    3 JOB CHAR(8);
DCL I BIN(31) FIXED;
DEC J BIN(31) FIXED;
DCL ROWAREA CHAR(2000);

```

...

```

ALLOCATE SQLDA SET(SQLDAPTR);
EXEC SQL
  DECLARE D11 CURSOR FOR
  SELECT EMPNO, LASTNAME, WORKDEPT, JOB
  FROM CORPDATA.EMPLOYEE
  WHERE WORKDEPT = 'D11';

```

...

```

EXEC SQL
  OPEN D11;
/* SET UP THE DESCRIPTOR FOR THE MULTIPLE-ROW FETCH */
/* 4 COLUMNS ARE BEING FETCHED */
SQLD = 4;
SQLN = 4;
SQLDABC = 366;
SQLTYPE(1) = 452; /* FIXED LENGTH CHARACTER - */
/* NOT NULLABLE */
SQLLEN(1) = 6;
SQLTYPE(2) = 456; /*VARYING LENGTH CHARACTER */
/* NOT NULLABLE */
SQLLEN(2) = 15;
SQLTYPE(3) = 452; /* FIXED LENGTH CHARACTER - */
SQLLEN(3) = 3;
SQLTYPE(4) = 452; /* FIXED LENGTH CHARACTER - */
/* NOT NULLABLE */
SQLLEN(4) = 8;
/*ISSUE THE MULTIPLE-ROW FETCH STATEMENT TO RETRIEVE*/
/*THE DATA INTO THE DEPT ROW STORAGE AREA */
/*USE A HOST VARIABLE TO CONTAIN THE COUNT OF */
/*ROWS TO BE RETURNED ON THE MULTIPLE-ROW FETCH */
J = 20; /*REQUESTS 20 ROWS ON THE FETCH */

```

```

...
EXEC SQL
  WHENEVER NOT FOUND
  GOTO FINISHED;
EXEC SQL
  WHENEVER SQLERROR
  GOTO FINISHED;
EXEC SQL
  FETCH D11 FOR :J ROWS
  USING DESCRIPTOR :SQLDA INTO :ROWAREA;
/* ADDRESS THE ROWS RETURNED */
DEPTPTR = ADDR(ROWAREA);
/*PROCESS EACH ROW RETURNED IN THE ROW STORAGE */
/*AREA BASED ON THE COUNT OF RECORDS RETURNED */
/*IN SQLERRD3. */
DO I = 1 TO SQLERRD(3);
  IF EMPNO(I) = '000170' THEN
    DO;
      :
    END;
  END;
END;
IF SQLERRD(5) = 100 THEN
  DO;
    /* PROCESS END OF FILE */
  END;
FINISHED:

```

In this example, a cursor has been defined for the CORPDATA.EMPLOYEE table to select all rows where the WORKDEPT column equal 'D11'. The sample EMPLOYEE table in the Sample Tables shows the result table contains multiple rows. The DECLARE CURSOR and OPEN statements do not have special syntax when they are used with a multiple-row FETCH statement. Another FETCH statement that returns a single

row against the same cursor can be coded elsewhere in the program. The multiple-row FETCH statement is used to retrieve all rows in the result table. Following the FETCH, the cursor position remains on the final row in the block.

The row area, ROWAREA, is defined as a character array. The data from the result table is placed in the host variable. In this example, a pointer variable is assigned to the address of ROWAREA. Each item in the rows that are returned is examined and used with the based structure DEPT.

The attributes (type and length) of the items in the descriptor match the columns that are retrieved. In this case, no indicator area is provided.

After the FETCH statement is completed, the ROWAREA contains all of the rows that equal 'D11', in this case 11 rows. The SQLCA that is returned to the application contains the following:

- SQLCODE contains 0
- SQLSTATE contains '00000'
- SQLERRD3 contains 11, the number of rows returned
- SQLERRD4 contains 34, for the length of the row fetched
- SQLERRD5 contains +100, indicating the last row in the result table was fetched

In this example, the application has taken advantage of the fact that SQLERRD5 contains an indication of the end of the file being reached. As a result, the application does not need to call SQL again to attempt to retrieve more rows. If the cursor has immediate sensitivity to inserts, you should call SQL in case any records were added. Cursors have immediate sensitivity when the commitment control level is something other than *RR.

Related reference

[SQLDA \(SQL descriptor area\)](#)

Unit of work and open cursors

When your program completes a unit of work, it should commit or roll back the changes that you have made.

Unless you specified HOLD on the COMMIT or ROLLBACK statement, all open cursors are automatically closed by SQL. Cursors that are declared with the WITH HOLD clause are not automatically closed on COMMIT. They are automatically closed on a ROLLBACK (the WITH HOLD clause specified on the DECLARE CURSOR statement is ignored).

If you want to continue processing from the current cursor position after a COMMIT or ROLLBACK, you must specify COMMIT HOLD or ROLLBACK HOLD. When HOLD is specified, any open cursors are left open and keep their cursor position so processing can resume. On a COMMIT statement, the cursor position is maintained. On a ROLLBACK statement, the cursor position is restored to just after the last row retrieved from the previous unit of work. All record locks are still released.

After issuing a COMMIT or ROLLBACK statement without HOLD, all locks are released and all cursors are closed. You can open the cursor again, but you will begin processing at the first row of the result table.

Note: Specification of the ALWBLK(*ALLREAD) parameter of the Create SQL (CRTSQLxxx) commands can change the restoration of the cursor position for read-only cursors. For information about the use of the ALWBLK parameter and other performance-related options on the CRTSQLxxx commands, see [“Dynamic SQL applications”](#) on page 300.

Related concepts

[Commitment control](#)

Dynamic SQL applications

Dynamic SQL allows an application to define and run SQL statements at program run time. An application that uses dynamic SQL either accepts an SQL statement as input or builds an SQL statement in the form of a character string. The application does not need to know the type of the SQL statement.

The application:

- Builds or accepts as input an SQL statement
- Prepares the SQL statement for running
- Runs the statement
- Handles SQL return codes

Notes:

- Programs that contain an EXECUTE or EXECUTE IMMEDIATE statement and that use a FOR READ ONLY clause to make a cursor read-only experience better performance because blocking is used to retrieve rows for the cursor.

The ALWBLK(*ALLREAD) CRTSQLxxx option will imply a FOR READ ONLY declaration for all cursors that do not explicitly code FOR UPDATE OF or have positioned deletes or updates that refer to the cursor. Cursors with an implied FOR READ ONLY will benefit from the second item in this list.

Some dynamic SQL statements require the use of pointer variables. RPG/400 programs require the aid of PL/I, COBOL, C, or ILE RPG programs to manage the pointer variables.

Related concepts

[Using interactive SQL](#)

Interactive SQL allows a programmer or a database administrator to quickly and easily define, update, delete, or look at data for testing, problem analysis, and database maintenance.

Related reference

[Actions allowed on SQL statements](#)

[Process Extended Dynamic SQL \(QSQPRCED\) API](#)

[Unit of work and open cursors](#)

When your program completes a unit of work, it should commit or roll back the changes that you have made.

Running dynamic SQL statements

To issue a dynamic SQL statement, use either an EXECUTE statement or an EXECUTE IMMEDIATE statement, because dynamic SQL statements are prepared at run time, not at precompile time.

The EXECUTE IMMEDIATE statement causes the SQL statement to be prepared and run dynamically at program run time.

There are two basic types of dynamic SQL statements: SELECT statements and non-SELECT statements. Non-SELECT statements include such statements as DELETE, INSERT, and UPDATE.

Client/server applications that use interfaces such as Open Database Connectivity (ODBC) typically use dynamic SQL to access the database.

Related concepts

[System i Access for Windows: Programming](#)

CCSID of dynamic SQL statements

An SQL statement is normally a host variable. The coded character set identifier (CCSID) of the host variable is used as the CCSID of the statement text.

Dynamic SQL statements are processed using the CCSID of the statement text. This affects variant characters. For example, the not sign (¬) is located at 'BA'X in CCSID 500. This means that if the CCSID of your statement text is 500, SQL expects the not sign (¬) to be represented by the value 'BA'X.

If the statement text CCSID is 65535, SQL processes variant characters as if they had a CCSID of 37. This means that SQL looks for the not sign (¬) at '5F'X.

Processing non-SELECT statements

Before building a dynamic SQL non-SELECT statement, you need to verify that this SQL statement is allowed to be run dynamically.

To run a dynamic SQL non-SELECT statement:

1. Run the SQL statement using EXECUTE IMMEDIATE, or PREPARE the SQL statement, then EXECUTE the prepared statement.
2. Handle any SQL return codes that might result.

The following is an example of an application running a dynamic SQL non-SELECT statement (stmtstrg):

```
EXEC SQL  
EXECUTE IMMEDIATE :stmtstrg;
```

Related concepts

Using interactive SQL

Interactive SQL allows a programmer or a database administrator to quickly and easily define, update, delete, or look at data for testing, problem analysis, and database maintenance.

Using the PREPARE and EXECUTE statements

If the non-SELECT statement does not contain parameter markers, you can run it dynamically using the EXECUTE IMMEDIATE statement. However, if the non-SELECT statement contains parameter markers, you must run it using the PREPARE and EXECUTE statements.

The PREPARE statement prepares the non-SELECT statement (for example, the DELETE statement) and gives it a statement name you choose. If DLYPRP (*YES) is specified on the CRTSQLxxx command, the preparation is delayed until the first time the statement is used in an EXECUTE or DESCRIBE statement, unless the USING clause is specified on the PREPARE statement. After the statement has been prepared, it can be run many times within the same program, using different values for the parameter markers. The following example is of a prepared statement being run multiple times:

```
DSTRING = 'DELETE FROM CORPDATA.EMPLOYEE WHERE EMPNO = ?';  
  
/*The ? is a parameter marker which denotes  
that this value is a host variable that is  
to be substituted each time the statement is run.*/  
  
EXEC SQL PREPARE S1 FROM :DSTRING;  
  
/*DSTRING is the delete statement that the PREPARE statement is  
naming S1.*/  
  
DO UNTIL (EMP =0);  
/*The application program reads a value for EMP from the  
display station.*/  
EXEC SQL  
EXECUTE S1 USING :EMP;  
  
END;
```

In routines similar to the example above, you must know the number of parameter markers and their data types, because the host variables that provide the input data are declared when the program is being written.

Note: All prepared statements that are associated with an application server are destroyed whenever the connection to the application server ends. Connections are ended by a CONNECT (Type 1) statement, a DISCONNECT statement, or a RELEASE followed by a successful COMMIT.

Processing SELECT statements and using a descriptor

The basic types of SELECT statements are fixed list and varying list.

To process a fixed-list SELECT statement, an SQL descriptor is not necessary.

To process a varying-list SELECT statement, you must first declare an SQL descriptor area (SQLDA) structure or ALLOCATE an SQLDA. Both forms of SQL descriptors can be used to pass host variable input values from an application program to SQL and to receive output values from SQL. In addition, information about SELECT list expressions can be returned in a PREPARE or DESCRIBE statement.

Fixed-list SELECT statements

In dynamic SQL, a fixed-list SELECT statement retrieves data of a predictable number and type. When using this statement, you can anticipate and define host variables to accommodate the retrieved data so that an SQL descriptor area (SQLDA) is not necessary.

Each successive FETCH returns the same number of values as the last, and these values have the same data formats as those returned for the last FETCH. You can specify host variables in the same manner as for any SQL application.

You can use fixed-list dynamic SELECT statements with any SQL-supported application program.

To run fixed-list SELECT statements dynamically, your application must:

1. Place the input SQL statement into a host variable.
2. Issue a PREPARE statement to validate the dynamic SQL statement and put it into a form that can be run. If DLYPRP (*YES) is specified on the CRTSQLxxx command, the preparation is delayed until the first time the statement is used in an EXECUTE or DESCRIBE statement, unless the USING clause is specified on the PREPARE statement.
3. Declare a cursor for the statement name.
4. Open the cursor.
5. FETCH a row into a fixed list of variables (rather than into a descriptor area, as if you were using a varying-list SELECT statement).
6. When end of data occurs, close the cursor.
7. Handle any SQL return codes that result.

For example:

```
MOVE 'SELECT EMPNO, LASTNAME FROM CORPDATA.EMPLOYEE WHERE EMPNO>?'
TO DSTRING.
EXEC SQL
  PREPARE S2 FROM :DSTRING END-EXEC.

EXEC SQL
  DECLARE C2 CURSOR FOR S2 END-EXEC.

EXEC SQL
  OPEN C2 USING :EMP END-EXEC.

PERFORM FETCH-ROW UNTIL SQLCODE NOT=0.

EXEC SQL
  CLOSE C2 END-EXEC.
STOP-RUN.
FETCH-ROW.
EXEC SQL
  FETCH C2 INTO :EMP, :EMPNAME END-EXEC.
```

Note: Remember that because the SELECT statement, in this case, always returns the same number and type of data items as previously run fixed-list SELECT statements, you do not need to use an SQL descriptor area.

Varying-list SELECT statements

In dynamic SQL, a varying-list SELECT statement is used when the number and format of the result columns are not predictable; that is, you do not know the data types or the number of variables that you need.

Therefore, you cannot define host variables in advance to accommodate the result columns returned.

If your application accepts varying-list SELECT statements, your program has to:

1. Place the input SQL statement into a host variable.
2. Issue a PREPARE statement to validate the dynamic SQL statement and put it into a form that can be run. If DLYPRP (*YES) is specified on the CRTSQLxxx command, the preparation is delayed until the first time the statement is used in an EXECUTE or DESCRIBE statement, unless the USING clause is specified on the PREPARE statement.
3. Declare a cursor for the statement name.
4. Open the cursor (declared in step 3) that includes the name of the dynamic SELECT statement.
5. For an allocated SQL descriptor, run an ALLOCATE DESCRIPTOR statement to define the descriptor you intend to use.
6. Issue a DESCRIBE statement to request information from SQL about the type and size of each column of the result table.

Notes:

- a. You can also code the PREPARE statement with an INTO clause to perform the functions of PREPARE and DESCRIBE with a single statement.
- b. If using an SQLDA and the SQLDA is not large enough to contain column descriptions for each retrieved column, the program must determine how much space is needed, get storage for that amount of space, build a new SQLDA, and reissue the DESCRIBE statement.

If using an allocated SQL descriptor and the descriptor is not large enough, deallocate the descriptor, allocate it with a larger number of entries, and reissue the DESCRIBE statement.

7. For an SQLDA descriptor, allocate the amount of storage needed to contain a row of retrieved data.
8. For an SQLDA descriptor, put storage addresses into the SQLDA to tell SQL where to put each item of retrieved data.
9. FETCH a row.
10. Process the data returned in the SQL descriptor.
11. Handle any SQL return codes that might result.
12. When end of data occurs, close the cursor.
13. For an allocated SQL descriptor, run a DEALLOCATE DESCRIPTOR statement to delete the descriptor.

Related reference

Example: A SELECT statement for allocating storage for SQLDA

Suppose that your application needs to handle a dynamic SELECT statement that changes from one use to the next. This statement can be read from a display, passed in from another application, or built dynamically by your application.

SQL descriptor areas

Dynamic SQL uses an SQL descriptor area to pass information about an SQL statement between SQL and your application.

A descriptor is required for running the DESCRIBE, DESCRIBE INPUT and DESCRIBE TABLE statements, and can also be used on the PREPARE, OPEN, FETCH, CALL, and EXECUTE statements.

The meaning of the information in a descriptor depends on its use. In PREPARE and DESCRIBE, a descriptor provides information to an application program about a prepared statement. In DESCRIBE INPUT, the SQL descriptor area provides information to an application program about parameter markers in a prepared statement. In DESCRIBE TABLE, the descriptor provides information to an application

program about the columns in a table or view. In OPEN, EXECUTE, CALL, and FETCH, a descriptor provides information about host variables. For example, you can read values into the descriptor by using a DESCRIBE statement, change the data values in the descriptor to use the host variables, and then reuse the same descriptor in a FETCH statement.

If your application allows you to have several cursors open at the same time, you can code several descriptors, one for each dynamic SELECT statement.

There are two types of descriptors. One is defined with the ALLOCATE DESCRIPTOR statement. The other is defined with the SQLDA structure.

ALLOCATE DESCRIPTOR is not supported in REXX. SQLDAs can be used in C, C++, COBOL, PL/I, REXX, and RPG. Because RPG/400 does not provide a way to set pointers, the SQLDA must be set outside the RPG/400 program by a PL/I, C, C++, COBOL, or an ILE RPG program. That program must then call the RPG/400 program.

Related reference

[SQLCA \(SQL communication area\)](#)

[SQLDA \(SQL descriptor area\)](#)

SQLDA format

An SQL descriptor area (SQLDA) consists of four variables followed by an arbitrary number of occurrences of a sequence of six variables collectively named SQLVAR.

Note: The SQLDA in REXX is different.

When an SQLDA is used in OPEN, FETCH, CALL, and EXECUTE, each occurrence of SQLVAR describes a host variable.

The fields of the SQLDA are as follows:

SQLDAID

SQLDAID is as used an 'eyecatcher" for storage dumps. It is a string of 8 characters that have the value 'SQLDA' after the SQLDA is used in a PREPARE or DESCRIBE statement. This variable is not used for FETCH, OPEN, CALL, or EXECUTE.

Byte 7 can be used to determine if more than one SQLVAR entry is needed for each column. Multiple SQLVAR entries may be needed if there are any LOB or distinct type columns. This flag is set to a blank if there are not any LOBs or distinct types.

SQLDAID is not applicable in REXX.

SQLDABC

SQLDABC indicates the length of the SQLDA. It is a 4-byte integer that has the value $SQLN * LENGTH(SQLVAR) + 16$ after the SQLDA is used in a PREPARE or DESCRIBE statement. SQLDABC must have a value equal to or greater than $SQLN * LENGTH(SQLVAR) + 16$ before it is used by FETCH, OPEN, CALL, or EXECUTE.

SQLABC is not applicable in REXX.

SQLN

SQLN is a 2-byte integer that specifies the total number of occurrences of SQLVAR. It must be set before being used by any SQL statement to a value greater than or equal to 0.

SQLN is not applicable in REXX.

SQLD

SQLD is a 2-byte integer that specifies the number of occurrences of SQLVAR, in other words, the number of host variables or columns described by the SQLDA. This field is set by SQL on a DESCRIBE or PREPARE statement. In other statements, this field must be set before being used to a value greater than or equal to 0 and less than or equal to SQLN.

SQLVAR

This group of values are repeated once for each host variable or column. These variables are set by SQL on a DESCRIBE or PREPARE statement. In other statements, they must be set before being used. These variables are defined as follows:

SQLTYPE

SQLTYPE is a 2-byte integer that specifies the data type of the host variable or column. See [SQLTYPE](#) and [SQLLEN](#) for a table of the valid values. Odd values for SQLTYPE show that the host variable has an associated indicator variable addressed by SQLIND.

SQLLEN

SQLLEN is a 2-byte integer variable that specifies the length attribute of the host variable or column.

SQLRES

SQLRES is a 12-byte reserved area for boundary alignment purposes. Note that, in IBM i, pointers *must* be on a quad-word boundary.

SQLRES is not applicable in REXX.

SQLDATA

SQLDATA is a 16-byte pointer variable that specifies the address of the host variables when the SQLDA is used on OPEN, FETCH, CALL, and EXECUTE.

When the SQLDA is used on PREPARE and DESCRIBE, this area is overlaid with the following information:

The CCSID of a character or graphic field is stored in the third and fourth bytes of SQLDATA. For BIT data, the CCSID is 65535. In REXX, the CCSID is returned in the variable SQLCCSID.

SQLIND

SQLIND is a 16-byte pointer that specifies the address of a small integer host variable that is used as an indication of null or not null when the SQLDA is used on OPEN, FETCH, CALL, and EXECUTE. A negative value indicates null and a non-negative indicates not null. This pointer is only used if SQLTYPE contains an odd value.

When the SQLDA is used on PREPARE and DESCRIBE, this area is reserved for future use.

SQLNAME

SQLNAME is a variable-length character variable with a maximum length of 30. After a PREPARE or DESCRIBE, this variable contains the name of selected column, label, or system column name. In OPEN, FETCH, EXECUTE, or CALL, this variable can be used to pass the CCSID of character strings. CCSIDs can be passed for character and graphic host variables.

The SQLNAME field in an SQLVAR array entry of an input SQLDA can be set to specify the CCSID. See [CCSID values in SQLDATA or SQLNAME](#) for the layout of the CCSID data in this field.

Note: It is important to remember that the SQLNAME field is only for overriding the CCSID. Applications that use the defaults do not need to pass CCSID information. If a CCSID is not passed, the default CCSID for the job is used.

The default for graphic host variables is the associated double-byte CCSID for the job CCSID. If an associated double-byte CCSID does not exist, 65535 is used.

SQLVAR2

This is the Extended SQLVAR structure that contains 3 fields. Extended SQLVARs are needed for all columns of the result if the result includes any distinct type or LOB columns. For distinct types, they contain the distinct type name. For LOBs, they contain the length attribute of the host variable and a pointer to the buffer that contains the actual length. If locators are used to represent LOBs, these entries are not necessary. The number of Extended SQLVAR occurrences needed depends on the statement that the SQLDA was provided for and the data types of the columns or parameters being described. Byte 7 of SQLDAID is always set to the number of sets of SQLVARs necessary.

If SQLD is not set to a sufficient number of SQLVAR occurrences:

- SQLD is set to the total number of SQLVAR occurrences needed for all sets.

- A +237 warning is returned in the SQLCODE field of the SQLCA if at least enough were specified for the Base SQLVAR Entries. The Base SQLVAR entries are returned, but no Extended SQLVARs are returned.
- A +239 warning is returned in the SQLCODE field of the SQLCA if enough SQLVARs were not specified for even the Base SQLVAR Entries. No SQLVAR entries are returned.

SQLLONGLEN

SQLLONGLEN is a 4-byte integer variable that specifies the length attribute of a LOB (BLOB, CLOB, or DBCLOB) host variable or column.

SQLDATALEN

SQLDATALEN is a 16-byte pointer variable that specifies the address of the length of the host variable. This variable is used for LOB (BLOB, CLOB, and DBCLOB) host variables only. It is not used for DESCRIBE or PREPARE.

If this field is NULL, then the actual length of the data is stored in the 4 bytes immediately before the start of the data, and SQLDATA points to the first byte of the field length. The length indicates the number of bytes for a BLOB or CLOB, and the number of characters for a DBCLOB.

If this field is not NULL, it contains a pointer to a 4-byte long buffer that contains the actual length in bytes (even for DBCLOB) of the data in the buffer pointed to by the SQLDATA field in the matching base SQLVAR.

SQLDATATYPE_NAME

SQLDATATYPE_NAME is a variable-length character variable with a maximum length of 30. It is only used for DESCRIBE or PREPARE. This variable is set to one of the following:

- For a distinct type column, the database manager sets this to the fully qualified distinct type name. If the qualified name is longer than 30 bytes, it is truncated.
- For a label, the database manager sets this to the first 20 bytes of the label.
- For a column name, the database manager sets this to the column name.

Related tasks

[Coding SQL statements in REXX applications](#)

Related reference

[Example: A SELECT statement for allocating storage for SQLDA](#)

Suppose that your application needs to handle a dynamic SELECT statement that changes from one use to the next. This statement can be read from a display, passed in from another application, or built dynamically by your application.

Example: A SELECT statement for allocating storage for SQLDA

Suppose that your application needs to handle a dynamic SELECT statement that changes from one use to the next. This statement can be read from a display, passed in from another application, or built dynamically by your application.

In other words, you don't know exactly what this statement is going to be returning every time. Your application needs to handle the varying number of result columns with data types that are unknown ahead of time.

For example, the following statement needs to be processed:

```
SELECT WORKDEPT, PHONENO
FROM CORPDATA.EMPLOYEE
WHERE LASTNAME = 'PARKER'
```

Note: This SELECT statement has no INTO clause. Dynamic SELECT statements must *not* have an INTO clause, even if they return only one row.

The statement is assigned to a host variable. The host variable, in this case named DSTRING, is then processed by using the PREPARE statement as shown:

```
EXEC SQL
PREPARE S1 FROM :DSTRING;
```

Next, you need to determine the number of result columns and their data types. To do this, you need an SQLDA.

The first step in defining an SQLDA is to allocate storage for it. (Allocating storage is not necessary in REXX.) The techniques for acquiring storage are language-dependent. The SQLDA must be allocated on a 16-byte boundary. The SQLDA consists of a fixed-length header that is 16 bytes in length. The header is followed by a varying-length array section (SQLVAR), each element of which is 80 bytes in length.

The amount of storage that you need to allocate depends on how many elements you want to have in the SQLVAR array. Each column you select must have a corresponding SQLVAR array element. Therefore, the number of columns listed in your SELECT statement determines how many SQLVAR array elements you should allocate. Because this SELECT statement is specified at run time, it is impossible to know exactly how many columns will be accessed. Consequently, you must estimate the number of columns. Suppose, in this example, that no more than 20 columns are ever expected to be accessed by a single SELECT statement. In this case, the SQLVAR array should have a dimension of 20, ensuring that each item in the select-list has a corresponding entry in SQLVAR. This makes the total SQLDA size 20 x 80, or 1600, plus 16 for a total of 1616 bytes

Having allocated what you estimated to be enough space for your SQLDA, you need to set the SQLN field of the SQLDA equal to the number of SQLVAR array elements, in this case 20.

Having allocated storage and initialized the size, you can now issue a DESCRIBE statement.

```
EXEC SQL
DESCRIBE S1 INTO :SQLDA;
```

When the DESCRIBE statement is run, SQL places values in the SQLDA that provide information about the select-list for your statement. The following tables show the contents of the SQLDA after the DESCRIBE is run. Only the entries that are meaningful in this context are shown.

Description	Value
SQLAID	'SQLDA'
SQLDABC	1616
SQLN	20
SQLD	2

SQLDAID is an identifier field initialized by SQL when a DESCRIBE is run. SQLDABC is the byte count or size of the SQLDA. The SQLDA header is followed by 2 occurrences of the SQLVAR structure, one for each column in the result table of the SELECT statement being described:

Description	Value
SQLTYPE	453
SQLLEN	3
SQLDATA (3:4)	37
SQLNAME	8 WORKDEPT

Table 59. SQLVAR element 2

Description	Value
SQLTYPE	453
SQLLEN	4
SQLDATA(3:4)	37
SQLNAME	7 PHONENO

Your program might need to alter the SQLN value if the SQLDA is not large enough to contain the described SQLVAR elements. For example, suppose that instead of the estimated maximum of 20 columns, the SELECT statement actually returns 27. SQL cannot describe this select-list because the SQLVAR needs more elements than the allocated space allows. Instead, SQL sets the SQLD to the actual number of columns specified by the SELECT statement and the remainder of the structure is ignored. Therefore, after a DESCRIBE, you should compare the SQLN value to the SQLD value. If the value of SQLD is greater than the value of SQLN, allocate a larger SQLDA based on the value in SQLD, as follows, and perform the DESCRIBE again:

```
EXEC SQL
    DESCRIBE S1 INTO :SQLDA;
IF SQLN <= SQLD THEN
DO;

/*Allocate a larger SQLDA using the value of SQLD.*/
/*Reset SQLN to the larger value.*/

EXEC SQL
    DESCRIBE S1 INTO :SQLDA;
END;
```

If you use DESCRIBE on a non-SELECT statement, SQL sets SQLD to 0. Therefore, if your program is designed to process both SELECT and non SELECT statements, you can describe each statement after it is prepared to determine whether it is a SELECT statement. This example is designed to process only SELECT statements; the SQLD value is not checked.

Your program must now analyze the elements of SQLVAR returned from the successful DESCRIBE. The first item in the select-list is WORKDEPT. In the SQLTYPE field, the DESCRIBE returns a value for the data type of the expression and whether nulls are applicable or not.

In this example, SQL sets SQLTYPE to 453 in SQLVAR element 1. This specifies that WORKDEPT is a fixed-length character string result column and that nulls are permitted in the column.

SQL sets SQLLEN to the length of the column. Because the data type of WORKDEPT is CHAR, SQL sets SQLLEN equal to the length of the character column. For WORKDEPT, that length is 3. Therefore, when the SELECT statement is later run, a storage area large enough to hold a CHAR(3) string will be needed.

Because the data type of WORKDEPT is CHAR FOR SBCS DATA, the first 4 bytes of SQLDATA were set to the CCSID of the character column.

The last field in an SQLVAR element is a varying-length character string called SQLNAME. The first 2 bytes of SQLNAME contain the length of the character data. The character data itself is typically the name of a column used in the SELECT statement, in this case WORKDEPT. The exceptions to this are select-list items that are unnamed, such as functions (for example, SUM(SALARY)), expressions (for example, A+B-C), and constants. In these cases, SQLNAME is an empty string. SQLNAME can also contain a label rather than a name. One of the parameters associated with the PREPARE and DESCRIBE statements is the USING clause. You can specify it this way:

```
EXEC SQL
    DESCRIBE S1 INTO:SQLDA
    USING LABELS;
```

If you specify:

NAMES (or omit the USING parameter entirely)

Only column names are placed in the SQLNAME field.

SYSTEM NAMES

Only the system column names are placed in the SQLNAME field.

LABELS

Only labels associated with the columns listed in your SQL statement are entered here.

ANY

Labels are placed in the SQLNAME field for those columns that have labels; otherwise, the column names are entered.

BOTH

Names and labels are both placed in the field with their corresponding lengths. Remember to double the size of the SQLVAR array because you are including twice the number of elements.

ALL

Column names, labels, and system column names are placed in the field with their corresponding lengths. Remember to triple the size of the SQLVAR array

In this example, the second SQLVAR element contains the information for the second column used in the select: PHONENO. The 453 code in SQLTYPE specifies that PHONENO is a CHAR column. SQLLEN is set to 4.

Now you need to set up to use the SQLDA to retrieve values when running the SELECT statement.

After analyzing the result of the DESCRIBE, you can allocate storage for variables that are to contain the result of the SELECT statement. For WORKDEPT, a character field of length 3 must be allocated; for PHONENO, a character field of length 4 must be allocated. Since both of these results can be the NULL value, an indicator variable must be allocated for each field as well.

After the storage is allocated, you must set SQLDATA and SQLIND to point to the allocated storage areas. For each element of the SQLVAR array, SQLDATA points to the place where the result value is to be put. SQLIND points to the place where the null indicator value is to be put. The following tables show what the structure looks like now. Only the entries that are meaningful in this context are shown:

<i>Table 60. SQLDA header</i>	
Description	Value
SQLAID	'SQLDA'
SQLDABC	1616
SQLN	20
SQLD	2

<i>Table 61. SQLVAR element 1</i>	
Description	Value
SQLTYPE	453
SQLLEN	3
SQLDATA	Pointer to area for CHAR(3) result
SQLIND	Pointer to 2 byte integer indicator for result column

<i>Table 62. SQLVAR element 2</i>	
Description	Value
SQLTYPE	453

Table 62. SQLVAR element 2 (continued)	
Description	Value
SQLLEN	4
SQLDATA	Pointer to area for CHAR(4) result
SQLIND	Pointer to 2 byte integer indicator for result column

You are now ready to retrieve the SELECT statements results. Dynamically defined SELECT statements must not have an INTO statement. Therefore, all dynamically defined SELECT statements must use a cursor. Special forms of the DECLARE, OPEN, and FETCH are used for dynamically defined SELECT statements.

The DECLARE statement for the example statement is:

```
EXEC SQL DECLARE C1 CURSOR FOR S1;
```

As you can see, the only difference is that the name of the prepared SELECT statement (S1) is used instead of the SELECT statement itself. The actual retrieval of result rows is made as follows:

```
EXEC SQL
  OPEN C1;
EXEC SQL
  FETCH C1 USING DESCRIPTOR :SQLDA;
DO WHILE (SQLCODE = 0);
/*Process the results pointed to by SQLDATA*/
EXEC SQL
  FETCH C1 USING DESCRIPTOR :SQLDA;
END;
EXEC SQL
  CLOSE C1;
```

The cursor is opened. The result rows from the SELECT are then returned one at a time using a FETCH statement. On the FETCH statement, there is no list of output host variables. Instead, the FETCH statement tells SQL to return results into areas described by your SQLDA. The results are returned into the storage areas pointed to by the SQLDATA and SQLIND fields of the SQLVAR elements. After the FETCH statement has been processed, the SQLDATA pointer for WORKDEPT has its referenced value set to 'E11'. Its corresponding indicator value is 0 since a non-null value was returned. The SQLDATA pointer for PHONENO has its referenced value set to '4502'. Its corresponding indicator value is also 0 since a non-null value was returned.

Related reference

Varying-list SELECT statements

In dynamic SQL, a varying-list SELECT statement is used when the number and format of the result columns are not predictable; that is, you do not know the data types or the number of variables that you need.

SQLDA format

An SQL descriptor area (SQLDA) consists of four variables followed by an arbitrary number of occurrences of a sequence of six variables collectively named SQLVAR.

Example: A SELECT statement using an allocated SQL descriptor

Suppose that your application needs to handle a dynamic SELECT statement that changes from one use to the next. This statement can be read from a display, passed from another application, or built dynamically by your application.

In other words, you don't know exactly what this statement is going to be returning every time. Your application needs to be able to handle the varying number of result columns with data types that are unknown ahead of time.

For example, the following statement needs to be processed:

```
SELECT WORKDEPT, PHONENO
FROM CORPDATA.EMPLOYEE
WHERE LASTNAME = 'PARKER'
```

Note: This SELECT statement has no INTO clause. Dynamic SELECT statements must *not* have an INTO clause, even if they return only one row.

The statement is assigned to a host variable. The host variable, in this case named DSTRING, is then processed by using the PREPARE statement as shown:

```
EXEC SQL
PREPARE S1 FROM :DSTRING;
```

Next, you need to determine the number of result columns and their data types. To do this, you need to allocate the largest number of entries for an SQL descriptor that you think you will need. Assume that no more than 20 columns are ever expected to be accessed by a single SELECT statement.

```
EXEC SQL
ALLOCATE DESCRIPTOR 'mydescr' WITH MAX 20;
```

Now that the descriptor is allocated, the DESCRIBE statement can be done to get the column information.

```
EXEC SQL
DESCRIBE S1 USING DESCRIPTOR 'mydescr';
```

When the DESCRIBE statement is run, SQL places values that provide information about the statement's select-list into the SQL descriptor area defined by 'mydescr'.

If the DESCRIBE determines that not enough entries were allocated in the descriptor, SQLCODE +239 is issued. As part of this diagnostic, the second replacement text value indicates the number of entries that are needed. The following code sample shows how this condition can be detected and shows the descriptor allocated with the larger size.

```
/* Determine the returned SQLCODE from the DESCRIBE statement */
EXEC SQL
  GET DIAGNOSTICS CONDITION 1: returned_sqlcode = DB2_RETURNED_SQLCODE;

if returned_sqlcode = 239 then do;

/* Get the second token for the SQLCODE that indicated
   not enough entries were allocated */

EXEC SQL
  GET DIAGNOSTICS CONDITION 1: token = DB2_ORDINAL_TOKEN_2;
/* Move the token variable from a character host variable into an integer host variable */
EXEC SQL
  SET :var1 = :token;
/* Deallocate the descriptor that is too small */
EXEC SQL
  DEALLOCATE DESCRIPTOR 'mydescr';
/* Allocate the new descriptor to be the size indicated by the retrieved token */
EXEC SQL
  ALLOCATE DESCRIPTOR 'mydescr' WITH MAX :var1;
/* Perform the describe with the larger descriptor */
EXEC SQL
  DESCRIBE s1 USING DESCRIPTOR 'mydescr';
end;
```

At this point, the descriptor contains the information about the SELECT statement. Now you are ready to retrieve the SELECT statement results. For dynamic SQL, the SELECT INTO statement is not allowed. You must use a cursor.

```
EXEC SQL
DECLARE C1 CURSOR FOR S1;
```

You will notice that the prepared statement name is used in the cursor declaration instead of the complete SELECT statement. Now you can loop through the selected rows, processing them as you read them. The following code sample shows how this is done.

```
EXEC SQL
  OPEN C1;

EXEC SQL
  FETCH C1 INTO SQL DESCRIPTOR 'mydescr';
do while not at end of data;

  /* process current data returned (see below for discussion of doing this) */
  /* then read the next row */

EXEC SQL
  FETCH C1 INTO SQL DESCRIPTOR 'mydescr';
end;

EXEC SQL
  CLOSE C1;
```

The cursor is opened. The result rows from the SELECT statement are then returned one at a time using a FETCH statement. On the FETCH statement, there is no list of output host variables. Instead, the FETCH statement tells SQL to return results into the descriptor area.

After the FETCH has been processed, you can use the GET DESCRIPTOR statement to read the values. First, you must read the header value that indicates how many descriptor entries were used.

```
EXEC SQL
  GET DESCRIPTOR 'mydescr' :count = COUNT;
```

Next you can read information about each of the descriptor entries. After you determine the data type of the result column, you can do another GET DESCRIPTOR to return the actual value. To get the value of the indicator, specify the INDICATOR item. If the value of the INDICATOR item is negative, the value of the DATA item is not defined. Until another FETCH is done, the descriptor items will maintain their values.

```
do i = 1 to count;
  GET DESCRIPTOR 'mydescr' VALUE :i /* set entry number to get */
                                :type = TYPE, /* get the data type */
                                :length = LENGTH, /* length value */
                                :result_ind = INDICATOR;
  if result_ind >= 0 then
    if type = character
      GET DESCRIPTOR 'mydescr' VALUE :i
                          :char_result = DATA; /* read data into character field */
    else
      if type = integer
        GET DESCRIPTOR 'mydescr' VALUE :i
                              :int_result = DATA; /* read data into integer field */
      else
        /* continue checking and processing for all data types that might be returned */
    end;
end;
```

There are several other descriptor items that you might need to check to determine how to handle the result data. PRECISION, SCALE, DB2_CCSID, and DATETIME_INTERVAL_CODE are among them. The host variable that has the DATA value read into it must have the same data type and CCSID as the data being read. If the data type is varying length, the host variable can be declared longer than the actual data. For all other data types, the length must match exactly.

NAME, DB2_SYSTEM_COLUMN_NAME, and DB2_LABEL can be used to get name-related values for the result column. See [GET DESCRIPTOR](#) for more information about the items returned for a GET DESCRIPTOR statement and for the definition of the TYPE values

Parameter markers

A *parameter marker* is a question mark (?) that appears in a dynamic statement string. The question mark can appear where a host variable might appear if the statement string were a static SQL statement.

In the example used, the SELECT statement that was dynamically run had a constant value in the WHERE clause:

```
WHERE LASTNAME = 'PARKER'
```

If you want to run the same SELECT statement several times, using different values for LASTNAME, you can use an SQL statement that looks like this:

```
SELECT WORKDEPT, PHONENO  
FROM CORPDATA.EMPLOYEE  
WHERE LASTNAME = ?
```

When using parameter markers, your application does not need to set the data types and values for the parameters until run time. By specifying a descriptor on the OPEN statement, you can substitute the values for the parameter markers in the SELECT statement.

To code such a program, you need to use the OPEN statement with a descriptor clause. This SQL statement is used to not only open a cursor, but to replace each parameter marker with the value of the corresponding descriptor entry. The descriptor name that you specify with this statement must identify a descriptor that contains a valid definition of the values. This descriptor is not used to return information about data items that are part of a SELECT list. It provides information about values that are used to replace parameter markers in the SELECT statement. It gets this information from the application, which must be designed to place appropriate values into the fields of the descriptor. The descriptor is then ready to be used by SQL for replacing parameter markers with the actual values.

When you use an SQLDA for input to the OPEN statement with the USING DESCRIPTOR clause, not all of its fields need to be filled in. Specifically, SQLDAID, SQLRES, and SQLNAME can be left blank (SQLNAME can be set if a specific CCSID is needed.) Therefore, when you use this method for replacing parameter markers with values, you need to determine:

- How many parameter markers there are
- The data types and attributes of these parameters markers (SQLTYPE, SQLLEN, and SQLNAME)
- Whether an indicator variable is needed

In addition, if the routine is to handle both SELECT and non-SELECT statements, you might want to determine what category of statement it is.

If your application uses parameter markers, your program has to perform the following steps. This can be done using either an SQLDA or an allocated descriptor.

1. Read a statement into the DSTRING varying-length character string host variable.
2. Determine the number of parameter markers.
3. Allocate an SQLDA of that size or use ALLOCATE DESCRIPTOR to allocate a descriptor with that number of entries. This is not applicable in REXX.
4. For an SQLDA, set SQLN and SQLD to the number of parameter markers. SQLN is not applicable in REXX. For an allocated descriptor, use SET DESCRIPTOR to set the COUNT entry to the number of parameter markers.
5. For an SQLDA, set SQLDABC equal to SQLN*LENGTH(SQLVAR) + 16. This is not applicable in REXX.
6. For each parameter marker:
 - a. Determine the data types, lengths, and indicators.
 - b. For an SQLDA, set SQLTYPE and SQLLEN for each parameter marker. For an allocated descriptor, use SET DESCRIPTOR to set the entries for TYPE, LENGTH, PRECISION, and SCALE for each parameter marker.
 - c. For an SQLDA, allocate storage to hold the input values.

- d. For an SQLDA, set these values in storage.
- e. For an SQLDA, set SQLDATA and SQLIND (if applicable) for each parameter marker. For an allocated descriptor, use SET DESCRIPTOR to set entries for DATA and INDICATOR (if applicable) for each parameter marker.
- f. If character variables are used and they have a CCSID other than the job default CCSID, or graphic variables are used and they have a CCSID other than the associated DBCS CCSID for the job CCSID,
 - For an SQLDA, set SQLNAME (SQLCCSID in REXX) accordingly.
 - For an allocated SQL descriptor, use SET DESCRIPTOR to set the DB2_CCSID value.
- g. Issue the OPEN statement with a USING DESCRIPTOR clause (for an SQLDA) or USING SQL DESCRIPTOR clause (for an allocated descriptor) to open your cursor and substitute values for each of the parameter markers.

The statement can then be processed normally.

Related reference

Example: A SELECT statement for allocating storage for SQLDA

Suppose that your application needs to handle a dynamic SELECT statement that changes from one use to the next. This statement can be read from a display, passed in from another application, or built dynamically by your application.

Example: A SELECT statement using an allocated SQL descriptor

Suppose that your application needs to handle a dynamic SELECT statement that changes from one use to the next. This statement can be read from a display, passed from another application, or built dynamically by your application.

Using interactive SQL

Interactive SQL allows a programmer or a database administrator to quickly and easily define, update, delete, or look at data for testing, problem analysis, and database maintenance.

A programmer, using interactive SQL, can insert rows into a table and test the SQL statements before running them in an application program. A database administrator can use interactive SQL to grant or revoke privileges, create or drop schemas, tables, or views, or select information from system catalog tables.

After an interactive SQL statement is run, a completion message or an error message is displayed. In addition, status messages are normally displayed during long-running statements.

You can see help about a message by positioning the cursor on the message and pressing F1 (Help).

The basic functions supplied by interactive SQL are:

- The **statement entry** function allows you to:
 - Type in an interactive SQL statement and run it.
 - Retrieve and edit statements.
 - Prompt for SQL statements.
 - Page through previous statements and messages.
 - Call session services.
 - Start the list selection function.
 - Exit interactive SQL.
- The **prompt** function allows you to type either a complete SQL statement or a partial SQL statement, press F4 (Prompt), and then be prompted for the syntax of the statement. It also allows you to press F4 to get a menu of supported SQL statements. From this menu, you can select a statement and be prompted for the syntax of the statement.
- The **list selection** function allows you to select from lists of your authorized relational databases, schemas, tables, views, columns, constraints, or SQL packages.

be changed to a slash (/). The GRANT and REVOKE statements do not support prompting when using the period in *SYS naming.

You have two options when using the prompter:

- Type the verb of the statement before pressing F4=Prompt.

The statement is parsed and the clauses that are completed are filled in on the prompt displays.

If you type SELECT and press F4=Prompt, the following display appears:

```

Specify SELECT Statement
Type SELECT statement information. Press F4 for a list.

FROM tables . . . . . -----
SELECT columns . . . . . -----
WHERE conditions . . . . . -----
GROUP BY columns . . . . . -----
HAVING conditions . . . . . -----
ORDER BY columns . . . . . -----
FOR UPDATE OF columns . . . -----

Type choices, press Enter.
DISTINCT rows in result table . . . . . N Y=Yes, N=No
UNION with another SELECT . . . . . N Y=Yes, N=No
Specify additional options . . . . . N Y=Yes, N=No

F3=Exit      F4=Prompt  F5=Refresh  F6=Insert line  F9=Specify subquery
F10=Copy line F12=Cancel  F14=Delete line F15=Split line F24=More keys
Bottom

```

- Press F4=Prompt before typing anything on the Enter SQL Statements display. You are shown a list of statements. The list of statements varies and depends on the current interactive SQL statement processing mode. For syntax check mode with a language other than *NONE, the list includes all SQL statements. For run and validate modes, only statements that can be run in interactive SQL are shown. You can select the number of the statement you want to use. The system prompts you for the statement you selected.

If you press F4=Prompt without typing anything, the following display appears:

```

Select SQL Statement
Select one of the following:

1. ALTER TABLE
2. CALL
3. COMMENT ON
4. COMMIT
5. CONNECT
6. CREATE ALIAS
7. CREATE COLLECTION
8. CREATE INDEX
9. CREATE PROCEDURE
10. CREATE TABLE
11. CREATE VIEW
12. DELETE
13. DISCONNECT
14. DROP ALIAS

Selection
--
F3=Exit  F12=Cancel
More...

```

If you press F21=Display Statement on a prompt display, the prompter displays the formatted SQL statement as it was filled in to that point.

When Enter is pressed within prompting, the statement that was built through the prompt screens is inserted into the session. If the statement processing mode is *RUN, the statement is run. The prompter remains in control if an error is encountered.

Syntax checking

The syntax of the SQL statement is checked when it enters the prompter.

The prompter does not accept a syntactically incorrect statement. You must correct the syntax or remove the incorrect part of the statement or prompting will not be allowed.

Statement processing mode

The statement processing mode can be selected on the Change Session Attributes display.

In *RUN (run) or *VLD (validate) mode, only statements that are allowed to run in interactive SQL can be prompted. In *SYN (syntax check) mode, all SQL statements are allowed. The statement is not actually run in *SYN or *VLD modes; only the syntax and existence of objects are checked.

Subqueries

Subqueries can be selected on any display that has a WHERE or HAVING clause.

To see the subquery display, press F9=Specify subquery when the cursor is on a WHERE or HAVING input line. A display appears that allows you to type in subselect information. If the cursor is within the parentheses of the subquery when F9 is pressed, the subquery information is filled in on the next display. If the cursor is outside the parentheses of the subquery, the next display is blank.

CREATE TABLE prompting

You can enter column definitions individually when you are prompted for a CREATE TABLE statement.

Place your cursor in the column definition section of the display, and press F4=Prompt. A display that provides room for entering all the information for one column definition is shown.

To enter a column name longer than 18 characters, press F20=Display entire name. A window with enough space for a 30 character name will be displayed.

The editing keys, F6=Insert line, F10=Copy line, and F14=Delete line, can be used to add and delete entries in the column definition list.

Entering DBCS data

The rules for processing double-byte character set (DBCS) data across multiple lines are the same on the Enter SQL Statements display and in the SQL prompter.

Each line must contain the same number of shift-in and shift-out characters. When processing a DBCS data string that requires more than one line for entering, the extra shift-in and shift-out characters are removed. If the last column on a line contains a shift-in and the first column of the next line contains a shift-out, the shift-in and shift-out characters are removed by the prompter when the two lines are assembled. If the last two columns of a line contain a shift-in followed by a single-byte blank and the first column of the next line contains a shift-out, the shift-in, blank, shift-out sequence is removed when the two lines are assembled. This removal allows DBCS information to be read as one continuous character string.

As an example, suppose the following WHERE condition were entered. The shift characters are shown here at the beginning and end of the string sections on each of the two lines.

Specify SELECT Statement

Type SELECT statement information. Press F4 for a list.

```
FROM tables . . . . . TABLE1_____
SELECT columns . . . . . *_____
WHERE conditions . . . . . COL1 = '<AABBCCDDEEFFGGHHIIJJKLLMMNNOOPPQQ>
<RRSS>'_____
GROUP BY columns . . . . . _____
HAVING conditions . . . . . _____
ORDER BY columns . . . . . _____
FOR UPDATE OF columns . . . . . _____
```

When Enter is pressed, the character string is put together, removing the extra shift characters. The statement looks like this on the Enter SQL Statements display:

```
SELECT * FROM TABLE1 WHERE COL1 = '<AABBCCDDEEFFGGHHIIJJKLLMMNNOOPPQQRRSS>'
```

Using the list selection function

You can access the list selection function by pressing F4 (Prompt) on certain prompt displays. To access the function on the Enter SQL Statements display, press F16 (Select collections), F17 (Select tables), or F18 (Select columns).

After pressing the function key, you are given a list of authorized relational databases, schemas, tables, views, aliases, columns, constraints, procedures, parameters, or packages from which to choose. If you request a list of tables, but you have not previously selected a schema, you are asked to select a schema first.

On a list, you can select one or more items, numerically specifying the order in which you want them to appear in the statement. When the list function is exited, the selections you made are inserted at the position of the cursor on the display you came from.

Always select the list you are primarily interested in. For example, if you want a list of columns, but you believe that the columns you want are in a table not currently selected, press F18. Then, from the column list, press F17 to change the table. If the table list were selected first, the table name will be inserted into your statement. You do not have a choice for selecting columns.

You can request a list at any time while typing an SQL statement on the Enter SQL Statements display. The selections you make from the lists are inserted on the Enter SQL Statements display. They are inserted where the cursor is located in the numeric order that you specified on the list display. Although the selected list information is added for you, you must type the keywords for the statement.

The list function tries to provide qualifications that are necessary for the selected columns, tables, and SQL packages. However, sometimes the list function cannot determine the intent of the SQL statement. You need to review the SQL statement and verify that the selected columns, tables, and SQL packages are properly qualified.

Related reference

Starting interactive SQL

To start using interactive SQL, enter STRSQL from an IBM i command line.

Example: Using the list selection function

This example shows how to use the list selection function to build a SELECT statement.

Assume you have:

- Just entered interactive SQL by typing STRSQL on an IBM i command line.
- Made no list selections or entries.
- Selected *SQL for the naming convention.

Note: The example shows lists that are not on your server. They are used as an example only.

Begin using SQL statements:

1. Type SELECT on the first statement entry line.
2. Type FROM on the second statement entry line.
3. Leave the cursor positioned after FROM.

```

Enter SQL Statements

Type SQL statement, press Enter.
===> SELECT
      FROM _

```

4. Press F17=Select tables to obtain a list of tables, because you want the table name to follow FROM.

Instead of a list of tables appearing as you expected, a list of collections appears (the Select and Sequence collections display). You have just entered the SQL session and have not selected a schema to work with.
5. Type a 1 in the Seq column next to YOURCOLL2 schema.

```

Select and Sequence Collections

Type sequence numbers (1-999) to select collection, press Enter.

Seq  Collection      Type  Text
1    YOURCOLL1       SYS   Company benefits
    YOURCOLL2       SYS   Employee personal data
    YOURCOLL3       SYS   Job classifications/requirements
    YOURCOLL4       SYS   Company insurances

```

6. Press Enter.

The Select and Sequence Tables display appears, showing the tables existing in the YOURCOLL2 schema.
7. Type a 1 in the Seq column next to PEOPLE table.

```

Select and Sequence Tables

Type sequence numbers (1-999) to select tables, press Enter.

Seq  Table              Collection  Type  Text
1    EMPLCO             YOURCOLL2  TAB   Employee company data
    PEOPLE           YOURCOLL2  TAB   Employee personal data
    EMPLEXP          YOURCOLL2  TAB   Employee experience
    EMPLEVL          YOURCOLL2  TAB   Employee evaluation reports
    EMPLBEN          YOURCOLL2  TAB   Employee benefits record
    EMPLMED          YOURCOLL2  TAB   Employee medical record
    EMPLINVEST       YOURCOLL2  TAB   Employee investments record

```

8. Press Enter.

The Enter SQL Statements display appears again with the table name, YOURCOLL2 . PEOPLE, inserted after FROM. The table name is qualified by the schema name in the *SQL naming convention.

```

Enter SQL Statements

Type SQL statement, press Enter.
===> SELECT
      FROM YOURCOLL2.PEOPLE _

```

9. Position the cursor after SELECT.
10. Press F18=Select columns to obtain a list of columns, because you want the column name to follow SELECT.

The Select and Sequence Columns display appears, showing the columns in the PEOPLE table.

11. Type a 2 in the *Seq* column next to the *NAME* column.
12. Type a 1 in the *Seq* column next to the *SOCSEC* column.

Select and Sequence Columns					
Type sequence numbers (1-999) to select columns, press Enter.					
Seq	Column	Table	Type	Length	Scale
2	NAME	PEOPLE	CHARACTER	6	
	EMPLNO	PEOPLE	CHARACTER	30	
1	SOCSEC	PEOPLE	CHARACTER	11	
	STRADDR	PEOPLE	CHARACTER	30	
	CITY	PEOPLE	CHARACTER	20	
	ZIP	PEOPLE	CHARACTER	9	
	PHONE	PEOPLE	CHARACTER	20	

13. Press Enter.

The Enter SQL Statements display appears again with SOCSEC, NAME appearing after SELECT.

Enter SQL Statements	
Type SQL statement, press Enter.	
===>	SELECT SOCSEC, NAME FROM YOURCOLL2.PEOPLE

14. Press Enter.

The statement you created is now run.

Once you have used the list function, the values you selected remain in effect until you change them or until you change the list of schemas on the Change Session Attributes display.

Session services description

You can change session attributes from the Session Services display. You can also print, clear, or save the session to a source file.

To access the Session Services display, press F13 (Services) on the Enter SQL Statements display.

Option 1 (Change session attributes) displays the Change Session Attributes display, which allows you to select the current values that are in effect for your interactive SQL session. The options shown on this display change based on the statement processing option selected.

The following session attributes can be changed:

- Commitment control attributes.
- The statement processing control.
- The SELECT output device.
- The list of schemas.
- The list type to select either all your system and SQL objects, or only your SQL objects.
- The data refresh option when displaying data.
- The allow copy data option.
- The naming option.

- The programming language.
- The date format.
- The time format.
- The date separator.
- The time separator.
- The decimal point representation.
- The SQL string delimiter.
- The sort sequence.
- The language identifier.
- The SQL rules.
- The CONNECT password option.

Option 2 (Print current session) accesses the Change Printer display, which lets you print the current session immediately and then continue working. You are prompted for printer information. All the SQL statements you entered and all the messages displayed are printed just as they appear on the Enter SQL Statements display.

Option 3 (Remove all entries from current session) lets you remove all the SQL statements and messages from the Enter SQL Statements display and the session history. You are prompted to ensure that you really want to delete the information.

Option 4 (Save session in source file) accesses the Change Source File display, which lets you save the session in a source file. You are prompted for the source file name. This function lets you embed the source file into a host language program by using the source entry utility (SEU).

Note: Option 4 allows you to embed prototyped SQL statements in a high-level language (HLL) program that uses SQL. The source file created by option 4 may be edited and used as the input source file for the Run SQL Statements (RUNSQLSTM) command.

Exiting interactive SQL

To exit the interactive SQL environment, press F3 (Exit) on the Enter SQL Statements display. Several options are available for exiting.

- Save and exit session. Leave interactive SQL. Your current session will be saved and used the next time you start interactive SQL.
- Exit without saving session. Leave interactive SQL without saving your session.
- Resume session. Remain in interactive SQL and return to the Enter SQL Statements display. The current session parameters remain in effect.
- Save session in source file. Save the current session in a source file. The Change Source File display is shown to allow you to select where to save the session. You cannot recover and work with this session again in interactive SQL.

Notes:

1. Option 4 allows you to embed prototype SQL statements in a high-level language (HLL) program that uses SQL. Use the source entry utility (SEU) to copy the statements into your program. The source file can also be edited and used as the input source file for the Run SQL Statements (RUNSQLSTM) command.
2. If rows have been changed and locks are currently being held for this unit of work and you attempt to exit interactive SQL, a warning message is displayed.

Using an existing SQL session

If you saved only one interactive SQL session by selecting option 1 (Save and exit session) on the Exit Interactive SQL display, you can resume the session at any workstation.

However, if you use option 1 to save two or more sessions on different workstations, interactive SQL will first attempt to resume a session that matches your workstation. If no matching sessions are available, then interactive SQL will increase the scope of the search to include all sessions that belong to your user ID. If no sessions for your user ID are available, the system will create a new session for your user ID and current workstation.

For example, you saved a session on workstation 1 and saved another session on workstation 2 and you are currently working at workstation 1. Interactive SQL will first attempt to resume the session saved for workstation 1. If that session is currently in use, interactive SQL will then attempt to resume the session that was saved for workstation 2. If that session is also in use, then the system will create a second session for workstation 1.

However, suppose you are working at workstation 3 and want to use the ISQL session associated with workstation 2. You then may need to first delete the session from workstation 1 by using Option 2 (Exit without saving session) on the Exit Interactive SQL display.

Recovering an SQL session

If the previous SQL session ended abnormally, interactive SQL presents the Recover SQL Session display at the start of the next session when you enter the Start SQL Interactive Session (STRSQL) command.

From this display, you can choose to do either of the following two things.

- Recover the old session by selecting option 1 (Attempt to resume existing SQL session).
- Delete the old session and start a new session by selecting option 2 (Delete existing SQL session and start a new session).

If you choose to delete the old session and continue with the new session, the parameters you specified when you entered STRSQL are used. If you choose to recover the old session, or are entering a previously saved session, the parameters you specified when you entered STRSQL are ignored and the parameters from the old session are used. A message is returned to indicate which parameters were changed from the specified value to the old session value.

Accessing remote databases with interactive SQL

In interactive SQL, you can communicate with a remote relational database by using the SQL CONNECT statement. Interactive SQL uses the CONNECT (Type 2) semantics (distributed unit of work) for CONNECT statements.

Interactive SQL establishes an implicit connection to the local relational database when starting an SQL session. When the CONNECT statement is completed, a message shows the relational database connection that was established. If interactive SQL is starting a new session and COMMIT(*NONE) was not specified, or if interactive SQL is restoring a saved session and the commitment control level saved with the session was not *NONE, the connection will be registered with commitment control. This implicit connection and possible commitment control registration might influence subsequent connections to remote databases. It is suggested that you perform one of the following tasks before connecting to the remote database:

- When you are connecting to an application server that does not support distributed unit of work, issue a RELEASE ALL statement followed by a COMMIT statement to end previous connections, including the implicit connection to the local database.
- When you are connecting to an application server other than Db2 for i, issue a RELEASE ALL statement followed by a COMMIT statement to end previous connections, including the implicit connection to the local database, and change the commitment control level to at least *CHG.

When you are connecting to an application server other than Db2 for i, some session attributes are changed to attributes that are supported by that application server. The following table shows the attributes that change.

Table 63. Values table

Session attribute	Original value	New value
Date format	*YMD *DMY *MDY *JUL	*ISO *EUR *USA *USA
Time format	*HMS with a : separator *HMS with any other separator	*JIS *EUR
Commitment control	*CHG, *NONE *ALL	*CS Repeatable Read
Naming convention	*SYS	*SQL
Allow copy data	*NO, *YES	*OPTIMIZE
Data refresh	*ALWAYS	*FORWARD
Decimal point	*SYSVAL	*PERIOD
Sort sequence	Any value other than *HEX	*HEX

Note: When you are connected to a Db2 for Linux®, UNIX, and Windows or Db2 for z/OS application server, the date and time formats specified must be the same.

After the connection is completed, a message is sent stating that the session attributes have been changed. The changed session attributes can be displayed by using the session services display. While interactive SQL is running, no other connection can be established for the default activation group.

When connected to a remote system with interactive SQL, a statement processing mode of syntax-only checks the syntax of the statement against the syntax supported by the local system instead of the remote system. Similarly, the SQL prompter and list support use the statement syntax and naming conventions supported by the local system. The statement is run, however, on the remote system. Because of differences in the level of SQL support between the two systems, syntax errors may be found in the statement on the remote system at run time.

Lists of schemas and tables are available when you are connected to the local relational database. Lists of columns are available only when you are connected to a relational database manager that supports the DESCRIBE TABLE statement.

When you exit interactive SQL with connections that have pending changes or connections that use protected conversations, the connections remain. If you do not perform additional work over the connections, the connections are ended during the next COMMIT or ROLLBACK operation. You can also end the connections by doing a RELEASE ALL and a COMMIT before exiting interactive SQL.

Using interactive SQL for remote access to application servers other than Db2 for i might require some setup.

Note: In the output of a communications trace, there may be a reference to a 'CREATE TABLE XXX' statement. This is used to determine package existence; it is part of normal processing, and can be ignored.

Related concepts

[Distributed database programming](#)

Related reference

[Determining the connection type](#)

When a remote SQL connection is established, it uses either an unprotected or a protected network connection.

Using the SQL statement processor

The SQL statement processor allows SQL statements to be run from a source member or a source stream file. The statements in the source can be run repeatedly or changed without compiling the source. This makes the setup of a database environment easier.

The SQL statement processor is available through the Run SQL Statements (RUNSQLSTM) command.

The following statements can be used with the SQL statement processor:

- ALTER FUNCTION
- ALTER MASK
- ALTER PERMISSION
- ALTER PROCEDURE
- ALTER SEQUENCE
- ALTER TABLE
- ALTER TRIGGER
- CALL
- COMMENT
- COMMIT
- compound (dynamic)
- CREATE ALIAS
- CREATE FUNCTION
- CREATE INDEX
- CREATE MASK
- CREATE PERMISSION
- CREATE PROCEDURE
- CREATE SCHEMA
- CREATE SEQUENCE
- CREATE TABLE
- CREATE TRIGGER
- CREATE TYPE
- CREATE VARIABLE
- CREATE VIEW
- DECLARE GLOBAL TEMPORARY TABLE
- DELETE
- DROP
- GRANT
- INSERT

- LABEL
- LOCK TABLE
- MERGE
- REFRESH TABLE
- RELEASE SAVEPOINT
- RENAME
- REVOKE
- ROLLBACK
- SAVEPOINT
- SET CURRENT DECFLOAT ROUNDING MODE
- SET CURRENT DEGREE
- SET CURRENT IMPLICIT XMLPARSE OPTION
- SET CURRENT TEMPORAL SYSTEM_TIME
- SET ENCRYPTION PASSWORD
- SET PATH
- SET SCHEMA
- SET TRANSACTION
- TRANSFER OWNERSHIP
- TRUNCATE
- UPDATE

In the source, SQL statements do not begin with EXEC SQL. Each statement ends with a semicolon. For a source member, the default right margin is 80. If the record length of the source member is longer than 80, only the first 80 characters are read. You can change the right margin to some other value by using the MARGINS parameter on the RUNSQLSTM command. For a source stream file, the entire file is read; no margin is used.

Comments in the source can be either line comments or block comments. Line comments begin with a double hyphen (--) and end at the end of the line. Block comments start with /* and can continue across many lines until the corresponding */ is reached. Block comments can be nested.

SQL statements, CL commands, and comments are allowed in the source file. A CL command must be prefixed by 'CL:'. For example:

```
CL: ADDLIB MYLIB;
INSERT INTO T1 VALUES('A', 17);
```

The output listing containing the resulting messages for the SQL statements and CL commands is sent to a print file. The default print file is QSYSPRT.

The OPTION parameter lets you choose to get an output listing or to have errors written to the joblog. There is also an option to generate a listing only when errors are encountered during processing.

To perform syntax checking only on all statements in the source, specify the PROCESS(*SYN) parameter on the RUNSQLSTM command. To see more details for error messages in the listing, specify the SECLVLTXT(*YES) parameter.

Related reference

[Run SQL Statement \(RUNSQLSTM\) command](#)

Execution of statements after errors occur

If a statement returns an error with a severity higher than the value specified for the error level (ERRLVL) parameter of the Run SQL Statements (RUNSQLSTM) command, the statement fails.

The rest of the statements in the source are parsed to check for syntax errors, and will not be run. Most SQL errors have a severity of 30. If you want to continue processing after an SQL statement fails, set the ERRLVL parameter of the RUNSQLSTM command to 30 or higher. DROP statements issue a severity level 20 error if the object is not found to be dropped. Setting the ERRLVL parameter to have a value of 20 allows you to ignore these errors for DROP statements while not allowing processing to continue for other higher severity errors.

Commitment control in the SQL statement processor

A commitment-control level is specified on the Run SQL Statements (RUNSQLSTM) command.

If a commitment-control level other than *NONE is specified, the SQL statements are run under commitment control. If all of the statements successfully runs, a COMMIT is done at the completion of the SQL statement processor. Otherwise, a ROLLBACK is done. A statement is considered successful if its return code severity is less than or equal to the value specified on the ERRLVL parameter of the RUNSQLSTM command.

The SET TRANSACTION statement can be used within the source member to override the level of commitment control specified on the RUNSQLSTM command.

Note: The job must be at a unit of work boundary to use the SQL statement processor with commitment control.

Source listing for the SQL statement processor

This example shows an output source listing for the SQL statement processor.

Note: By using the code examples, you agree to the terms of [“Code license and disclaimer information”](#) on page 396

```
xxxxSS1 VxRxMx yymmdd      Run SQL Statements      SCHEMA      02/15/08 15:35:18      Page      1
Source file.....CORPDATA/SRC
Member.....SCHEMA
Commit.....*NONE
Naming.....*SYS
Generation level.....10
Date format.....*JOB
Date separator.....*JOB
Right margin.....80
Time format.....*HMS
Time separator.....*JOB
Default collection.....*NONE
IBM SQL flagging.....*NOFLAG
ANS flagging.....*NONE
Decimal point.....*JOB
Sort sequence.....*JOB
Language ID.....*JOB
Printer file.....*LIBL/QSYSPRT
Source file CCSID.....65535
Job CCSID.....37
Statement processing.....*RUN
Allow copy of data.....*OPTIMIZE
Allow blocking.....*ALLREAD
SQL rules.....*DB2
Decimal result options:
  Maximum precision.....31
  Maximum scale.....31
  Minimum divide scale....0
Source member changed on 11/01/07 11:54:10
```

Figure 1. QSYSPRT listing for SQL statement processor

```

xxxxSS1 VxRxMx yymmdd      Run SQL Statements          SCHEMA          02/15/08 15:35:18  Page  2
Record *...+... 1 ...+... 2 ...+... 3 ...+... 4 ...+... 5 ...+... 6 ...+... 7 ...+... 8 SEQNBR Last
change
1
2   DROP SCHEMA DEPT;
3   DROP SCHEMA MANAGER;
4
5   CREATE SCHEMA DEPT
6       CREATE TABLE EMP (EMPNAME CHAR(50), EMPNBR INT)
7           -- EMP will be created in schema DEPT
8       CREATE INDEX EMPIND ON EMP(EMPNBR)
9           -- EMPIND will be created in DEPT
10      GRANT SELECT ON EMP TO PUBLIC; -- grant authority
11
12      INSERT INTO DEPT/EMP VALUES('JOHN SMITH', 1234);
13          /* table must be qualified since no
14             longer in the schema */
15
16      CREATE SCHEMA AUTHORIZATION MANAGER
17          -- this schema will use MANAGER's
18          -- user profile
19      CREATE TABLE EMP_SALARY (EMPNBR INT, SALARY DECIMAL(7,2),
20          LEVEL CHAR(10))
21      CREATE VIEW LEVEL AS SELECT EMPNBR, LEVEL
22          FROM EMP_SALARY
23      CREATE INDEX SALARYIND ON EMP_SALARY(EMPNBR,SALARY)
24
25      GRANT ALL ON LEVEL TO JONES GRANT SELECT ON EMP_SALARY TO CLERK
26          -- Two statements can be on the same line
***** END OF SOURCE *****

```

Figure 2. QSYSPRT listing for SQL statement processor (continued)

```

xxxxSS1 VxRxMx yymmdd      Run SQL Statements          SCHEMA          02/15/08 15:35:18  Page  3
Record *...+... 1 ...+... 2 ...+... 3 ...+... 4 ...+... 5 ...+... 6 ...+... 7 ...+... 8 SEQNBR Last
change
MSG ID  SEV  RECORD  TEXT
SQL7953  0      1      Position 1 Drop of DEPT in QSYS complete.
SQL7953  0      3      Position 3 Drop of MANAGER in QSYS complete.
SQL7952  0      5      Position 3 Schema DEPT created.
SQL7950  0      6      Position 8 Table EMP created in DEPT.
SQL7954  0      8      Position 8 Index EMPIND created in DEPT on table EMP in
DEPT.
SQL7966  0     10      Position 8 GRANT of authority to EMP in DEPT completed.
SQL7956  0     10      Position 40 1 rows inserted in EMP in DEPT.
SQL7952  0     13      Position 28 Schema MANAGER created.
SQL7950  0     19      Position 9 Table EMP_SALARY created in schema
MANAGER.
SQL7951  0     21      Position 9 View LEVEL created in MANAGER.
SQL7954  0     23      Position 9 Index SALARYIND created in MANAGER on table
EMP_SALARY in MANAGER.
SQL7966  0     25      Position 9 GRANT of authority to LEVEL in MANAGER
completed.
SQL7966  0     25      Position 37 GRANT of authority to EMP_SALARY in MANAGER
completed.

Message Summary
Total   Info   Warning   Error   Severe   Terminal
13     13     0         0         0         0
00 level severity errors found in source
***** END OF LISTING *****

```

Figure 3. QSYSPRT listing for SQL statement processor (continued)

Using the RUNSQL CL command

The RUNSQL CL command allows an SQL statement to be run from within a CL program without needing a source file.

The following statements can be used by RUNSQL:

- ALTER FUNCTION
- ALTER MASK
- ALTER PERMISSION
- ALTER PROCEDURE
- ALTER SEQUENCE
- ALTER TABLE

- ALTER TRIGGER
- CALL
- COMMENT
- COMMIT
- compound (dynamic)
- CREATE ALIAS
- CREATE FUNCTION
- CREATE INDEX
- CREATE MASK
- CREATE PERMISSION
- CREATE PROCEDURE
- CREATE SCHEMA
- CREATE SEQUENCE
- CREATE TABLE
- CREATE TRIGGER
- CREATE TYPE
- CREATE VARIABLE
- CREATE VIEW
- DECLARE GLOBAL TEMPORARY TABLE
- DELETE
- DROP
- GRANT
- INSERT
- LABEL
- MERGE
- REFRESH TABLE
- RELEASE SAVEPOINT
- RENAME
- REVOKE
- ROLLBACK
- SAVEPOINT
- SET CURRENT DECFLOAT ROUNDING MODE
- SET CURRENT DEGREE
- SET CURRENT IMPLICIT XMLPARSE OPTION
- SET CURRENT TEMPORAL SYSTEM_TIME
- SET ENCRYPTION PASSWORD
- SET PATH
- SET SCHEMA
- SET TRANSACTION
- TRANSFER OWNERSHIP
- TRUNCATE
- UPDATE

The statement string can be up to 5000 characters long. It must not end with a semicolon.

Comments are allowed in the statement string. A line comment begins with a double hyphen (--) and ends at the end of the line (a carriage return and/or line feed) or at the end of the string. Block comments start with /* and continue until the corresponding */ is reached. Block comments can be nested.

If any file is opened by RUNSQL, it is closed before control is returned to the caller. If commitment control is active, it is up to the user's application to perform the commit or rollback.

The command runs in the invoker's activation group. If RUNSQL is included in a compiled CL program, the activation group of the program is used.

No output listing is generated by default. If a failure occurs, the SQL message is sent as an escape message to the caller. For a complex SQL statement that returns a syntax error, you can use the database monitor to help find the cause of the error. Start a database monitor, run the RUNSQL command, and analyze the database monitor using System i Navigator. You can use the OPTION, PRTFILE, and SECLVLTXT parameters on the command to generate a listing.

Run an INSERT statement from CL:

```
RUNSQL SQL('INSERT INTO prodLib/work_table VALUES(1, CURRENT_TIMESTAMP)')
```

In a CL program, you could use the Receive File (RCVF) command to read the results of the table generated for this query:

```
RUNSQL SQL('CREATE TABLE qtemp.worktable AS
(SELECT * FROM qsys2.systables WHERE table_schema = 'MYSCHEMA') WITH DATA')
COMMIT(*NONE) NAMING(*SQL)
```

Create a CL program that constructs and runs an SQL statement using an input parameter as part of the statement:

```
RUNSQL1: PGM PARM(&LIB)
DCL &LIB TYPE(*CHAR) LEN(10)
DCL &SQLSTMT TYPE(*CHAR) LEN(1000)
CHGVAR VAR(&SQLSTMT) +
VALUE('DELETE FROM qtemp.worktable1 +
WHERE table_schema = ' || &LIB || ' ')
RUNSQL SQL(&SQLSTMT) COMMIT(*NONE) NAMING(*SQL)
ENDPGM
```

Distributed relational database function and SQL

A *distributed relational database* consists of a set of SQL objects that are spread across interconnected computer systems.

These relational databases can be of the same type (for example, the Db2 for i database) or of different types (Db2 for z/OS, Db2 for VSE and VM, or non-IBM database management systems that support Distributed Relational Database Architecture (DRDA)). Each relational database has a relational database manager to manage the tables in its environment. The database managers communicate and cooperate with each other in a way that allows a given database manager access to run SQL statements on a relational database on another system.

The application requester supports the application side of a connection. The application server is the local or remote database to which an application requester is connected. Db2 for i provides support for DRDA to allow an application requester to communicate with application servers. In addition, Db2 for i can call exit programs to allow access to data on other database management systems that do not support DRDA. These exit programs are called *application requester driver (ARD) programs*.

Db2 for i supports the following levels of distributed relational database:

- Remote unit of work (RUW)

A *remote unit of work* is where the preparation and running of SQL statements occurs at only one application server during a unit of work. Db2 for i supports RUW over either Advanced Program-to-Program Communication (APPC) or TCP/IP.

- Distributed unit of work (DUW)

A *distributed unit of work* is where the preparation and running of SQL statements can occur at multiple application servers during a unit of work. However, a single SQL statement can only refer to objects located at a single application server. Db2 for i supports DUW over APPC and DUW over TCP/IP.

Related concepts

[Introduction to Db2 for i Structured Query Language](#)

Structured Query Language (SQL) is a standardized language for defining and manipulating data in a relational database. These topics describe the IBM i implementation of the SQL using the Db2 for i database and the IBM DB2® Query Manager and SQL Development Kit for i licensed program.

[SQL packages](#)

An *SQL package* is an object that contains the control structure produced when the SQL statements in an application program are bound to a remote relational database management system (DBMS).

[Distributed database programming](#)

Db2 for i distributed relational database support

The IBM DB2 Query Manager and SQL Development Kit for i licensed program supports interactive access to distributed databases.

Db2 Query Manager and SQL Development Kit for IBM i provides distributed relational database support through the following SQL statements:

- CONNECT
- SET CONNECTION
- DISCONNECT
- RELEASE
- DROP PACKAGE
- GRANT PACKAGE
- REVOKE PACKAGE

Additional support is provided by the development kit through parameters on the SQL precompiler commands:

- Create SQL ILE C Object (CRTSQLCI) command
- Create SQL ILE C++ Object (CRTSQLCPPI) command
- Create SQL COBOL Program (CRTSQLCBL) command
- Create SQL ILE COBOL Object (CRTSQLCBLI) command
- Create SQL PL/I Program (CRTSQLPLI) command
- Create SQL RPG Program (CRTSQLRPG) command
- Create SQL ILE RPG Object (CRTSQLRPGI) command

Related tasks

[Preparing and running a program with SQL statements](#)

Related reference

[Db2 for i CL command descriptions](#)

Db2 for i provides these CL commands for SQL.

[CONNECT \(Type 1\)](#)

[CONNECT \(Type 2\)](#)

[DISCONNECT](#)

[DROP](#)

[GRANT \(Package Privileges\)](#)

[REVOKE \(Package Privileges\)](#)

[RELEASE \(Connection\)](#)

[SET CONNECTION](#)

Db2 for i distributed relational database example program

A relational database example program that uses remote unit of work is included with the SQL product. Several files and members within the QSQL library can help you set up an environment that runs a distributed Db2 for i example program.

To use these files and members, you need to run the SETUP batch job located in the file QSQL/QSQSAMP. The SETUP batch job allows you to customize the example to do the following:

- Create the QSQSAMP library at the local and remote locations.
- Set up relational database directory entries at the local and remote locations.
- Create application panels at the local location.
- Precompile, compile, and run programs to create distributed example application schemas, tables, indexes, and views.
- Load data into the tables at the local and remote locations.
- Precompile and compile programs.
- Create SQL packages at the remote location for the application programs.
- Precompile, compile, and run the program to update the location column in the department table.

Before running the SETUP, you may need to edit the SETUP member of the QSQL/QSQSAMP file. Instructions are included in the member as comments. To run the SETUP, specify the following command on the system command line:

```
=====> SBMDBJOB QSQL/QSQSAMP SETUP
```

Wait for the batch job to complete.

To use the example program, specify the following command on the command line:

```
=====> ADDLIB QSQSAMP
```

To call the first display that allows you to customize the example program, specify the following command on the command line.

```
=====> CALL QSQ8HC3
```

The following display opens. From this display, you can customize your database example program.

SAMPLE ORGANIZATION APPLICATION

ACTION.....:	A (ADD)	E (ERASE)
	D (DISPLAY)	U (UPDATE)
OBJECT.....:	DE (DEPARTMENT)	EM (EMPLOYEE)
	DS (DEPT STRUCTURE)	
SEARCH CRITERIA...:	DI (DEPARTMENT ID)	MN (MANAGER NAME)
	DN (DEPARTMENT NAME)	EI (EMPLOYEE ID)
	MI (MANAGER ID)	EN (EMPLOYEE NAME)
LOCATION.....:	(BLANK IMPLIES LOCAL LOCATION)	
DATA.....:		

Bottom

F3=Exit

SQL package support

The IBM i operating system supports SQL packages. The object type is *SQLPKG.

The SQL package contains the control structures and access plans necessary to process SQL statements on the application server when running a distributed program. An SQL package can be created when:

- The RDB parameter is specified on the CRTSQLxxx command and the program object is successfully created. The SQL package will be created on the system specified by the RDB parameter.

If the compile is unsuccessful or the compile only creates the module object, the SQL package will not be created.

- Using the CRTSQLPKG command. The CRTSQLPKG can be used to create a package when the package was not created at precompile time or if the package is needed at an RDB other than the one specified on the precompile command.

The Delete SQL Package (DLTSQLPKG) command allows you to delete an SQL package on the local system.

An SQL package is not created unless the privileges held by the authorization ID associated with the creation of the SQL package includes appropriate authority for creating a package on the remote system (the application server). To run the program, the authorization ID must include EXECUTE privileges on the SQL package. On the IBM i operating system, the EXECUTE privilege includes system authority of *OBJOPR and *EXECUTE.

Related reference

[Create SQL Package \(CRTSQLPKG\) command](#)

Valid SQL statements in an SQL package

Programs that are connected to another server can use any of the SQL statements except the SET TRANSACTION statement.

Programs compiled with Db2 for i that refer to a remote database that is not Db2 for i can use executable SQL statements supported by the remote database. The precompiler continues to issue diagnostic messages for statements that it does not understand. These statements are sent to the remote system during the creation of the SQL package. The runtime support returns an SQLCODE of -84 or -525 when the statement cannot be run on the current application server. For example, multiple-row FETCH, blocked INSERT, and scrollable cursor support are allowed only in distributed programs where both the application requester and the application server are running on the OS/400® V5R2 or IBM i V5R3, or later, with the following exception. An application requester that is not running on the IBM i operating system can issue read-only, insensitive scrollable cursor operations on an IBM i V5R3 application server. A further restriction on the use of multiple-row FETCH statements, blocked INSERT statements, and scrollable cursors is that the transmission of binary large object (BLOB), character large object (CLOB), and double-byte character large object (DBCLOB) data is not allowed when those functions are used.

Related information

[Characteristics of SQL statements](#)

Considerations for creating an SQL package

When you create an SQL package, consider these aspects.

CRTSQLPKG authorization

When you create an SQL package on the IBM i operating system, the authorization ID used must have *USE authority to the Create SQL Package (CRTSQLPKG) command.

Creating a package on a database other than Db2 for i

When you create a program or an SQL package on a database other than Db2 for i, and try to use SQL statements that are unique to the other database, you must set the GENLVL parameter on the Create SQL (CRTSQLxxx) commands to 30.

The program will be created unless a message with a severity level of greater than 30 is issued. If a message is issued with a severity level of greater than 30, the statement is probably not valid for any relational database. For example, undefined or unusable host variables or constants that are not valid generate a message severity greater than 30.

The precompiler listing should be checked for unexpected messages when running with a GENLVL value greater than 10. When you are creating a package for a Db2 product, you must set the GENLVL parameter to a value less than 20.

If the RDB parameter specifies a database that is not Db2 for i, the following options should not be used on the CRTSQLxxx command:

- COMMIT(*NONE)
- OPTION(*SYS)
- DATFMT(*MDY)
- DATFMT(*DMY)
- DATFMT(*JUL)
- DATFMT(*YMD)
- DATFMT(*JOB)
- DYNUSRPRF(*OWNER)
- TIMFMT(*HMS) if TIMSEP(*BLANK) or TIMSEP(',') is specified
- SRTSEQ(*JOB RUN)
- SRTSEQ(*LANGIDUNQ)
- SRTSEQ(*LANGIDSHR)
- SRTSEQ(library-name/table-name)

Note: When you connect to a Db2 server, the following additional rules apply:

- The specified date and time formats must be the same format
- A value of *BLANK must be used for the TEXT parameter
- Default schemas (DFTRDBCOL) are not supported
- The CCSID of the source program from which the package is being created must not be 65535; if 65535 is used, an empty package is created.

Target release (TGTRLS) parameter

When you create the package, the SQL statements are checked to determine which release can support the function.

This release is set as the restore level of the package. For example, if the package contains a CREATE TABLE statement which adds a FOREIGN KEY constraint to the table, then the restore level of the package will be Version 3 Release 1, because FOREIGN KEY constraints were not supported before this release. TGTRLS message are suppressed when the TGTRLS parameter is *CURRENT.

SQL statement size

The create SQL package function might not be able to handle an SQL statement of the same size that the precompiler can process.

While the SQL program is being precompiled, the SQL statement is placed into the associated space of the program. When this occurs, each token is separated by a blank. In addition, when the RDB parameter is specified, the host variables of the source statement are replaced with an 'H'. The create SQL package function passes this statement to the application server, along with a list of the host variables for that statement. The addition of the blanks between the tokens and the replacement of host variables can cause the statement to exceed the maximum SQL statement size (SQL0101 reason 5).

Statements that do not require a package

In some cases, you might try to create an SQL package, but the SQL package is not created and the program still runs. This situation occurs when the program contains only SQL statements that do not require an SQL package to run.

For example, a program that contains only the SQL statement DESCRIBE TABLE will generate message SQL5041 during SQL package creation. The SQL statements that do not require an SQL package are:

- COMMIT
- CONNECT
- DESCRIBE TABLE
- DISCONNECT
- RELEASE
- RELEASE SAVEPOINT
- ROLLBACK
- SAVEPOINT
- SET CONNECTION

Package object type

SQL packages are always created as non-ILE objects and always run in the default activation group.

ILE programs and service programs

ILE programs and service programs that bind several modules containing SQL statements must have a separate SQL package for each module.

Package creation connection

The type of connection used for the package creation is based on the type of connection specified by the RDBCNNMTH parameter.

If RDBCNNMTH(*DUW) was specified, commitment control is used and the connection may be a read-only connection. If the connection is read-only, then the package creation will fail.

Unit of work

Because package creation implicitly performs a commit or rollback, the commit definition must be at a unit of work boundary before the package creation is attempted.

The following conditions must all be true for a commit definition to be at a unit of work boundary:

- SQL is at a unit of work boundary.
- There are no local or DDM files open using commitment control and no closed local or DDM files with pending changes.
- There are no API resources registered.
- There are no LU 6.2 resources registered that are not associated with DRDA or DDM.

Creating packages locally

The name specified on the RDB parameter can be the name of the local system.

If it is the name of the local system, the SQL package is created on the local system. The SQL package can be saved (Save Object (SAVOBJ) command) and then restored (Restore Object (RSTOBJ) command) to another system. When you run the program with a connection to the local system, the SQL package is not used. If you specify *LOCAL for the RDB parameter, an *SQLPKG object is not created, but the package information is saved in the *PGM object.

Labels

You can use the LABEL ON statement to create a description for an SQL package.

Consistency token

The program and its associated SQL package contain a consistency token that is checked when a call is made to the SQL package.

The consistency tokens must match; otherwise, the package cannot be used. It is possible for the program and SQL package to appear to be uncoordinated. Assume that the program and the application server are on two distinct IBM i operating systems. The program is running in session A and it is re-created in session B (where the SQL package is also re-created). The next call to the program in session A might cause a consistency token error. To avoid locating the SQL package on each call, SQL maintains a list of addresses for SQL packages that are used by each session. When session B re-creates the SQL package, the old SQL package is moved to the QRPLOBJ library. The address to the SQL package in session A is still valid. You can avoid this situation by creating the program and SQL package from the session that is running the program, or by submitting a remote command to delete the old SQL package before creating the program.

To use the new SQL package, you should end the connection with the remote system. You can either sign off the session and then sign on again, or you can use the interactive SQL (STRSQL) command to issue a DISCONNECT for unprotected network connections or a RELEASE followed by a COMMIT for protected connections. RCLDDMCNV should then be used to end the network connections. Call the program again.

SQL and recursion

If you start SQL from an attention key program while you are already precompiling, you will receive unpredictable results.

The Create SQL (CRTSQLxxx), Create SQL Package (CRTSQLPKG), and Start SQL Interactive Session (STRSQL) commands and the SQL runtime environment are not recursive. They produce unpredictable results if recursion is attempted. Recursion occurs if, while one of the commands is running (or running a program with embedded SQL statements), the job is interrupted before the command has completed, and another SQL function is started.

CCSID considerations for SQL

If you are running a distributed application and one of your systems is not an IBM i product, the server on the IBM i platform cannot have the job coded character set identifier (CCSID) value set to 65535.

Before requesting that the remote system create an SQL package, the application requester always converts the name specified on the RDB parameter, the SQL package name, the library name, and the text of the SQL package from the CCSID of the job to CCSID 500. This is required by Distributed Relational Database Architecture (DRDA). When the remote system is an IBM i product, the names are not converted from CCSID 500 to the job CCSID.

It is recommended that delimited identifiers not be used for table, view, index, schema, library, or SQL package names. Conversion of names does not occur between systems with different CCSIDs. Consider the following example with system A running with a CCSID of 37 and system B running with a CCSID of 500.

- Create a program that creates a table with the name "a-b|c" on system A.
- Save program "a-b|c" on system A, then restore it to system B.

- The code point for – in CCSID 37 is x'5F' while in CCSID 500 it is x'BA'.
- On system B the name displays "a[b]c". If you created a program that referenced the table whose name was "a–b|c.", the program will not find the table.

The at sign (@), pound sign (#), and dollar sign (\$) characters should not be used in SQL object names. Their code points depend on the CCSID used. If you use delimited names or the three national extenders, the name resolution functions may possibly fail in a future release.

Connection management and activation groups

SQL connections are managed at the activation group level. Each activation group within a job manages its own connections and these connections are not shared across activation groups.

Before the use of TCP/IP by Distributed Relational Database Architecture (DRDA), the term *connection* was not ambiguous. It referred to a connection from the SQL point of view. That is, a connection starts when you run the CONNECT TO statement to connect to some relational database (RDB), and ends when you run the DISCONNECT or RELEASE ALL statement followed by a successful COMMIT operation. The Advanced Program-to-Program Communication (APPC) conversation might or might not have been kept up, depending on the DDMCNV attribute value of the job and whether the conversation was with an IBM i product or with other types of systems.

TCP/IP terminology does not include the term *conversation*. A similar concept exists, however. With the advent of TCP/IP support by DRDA, use of the term *conversation* is replaced, in this topic, by the more general term *connection*, unless the discussion is specifically about an APPC conversation. Therefore, there are now two different types of connections about which the reader must be aware: SQL connections of the type described above, and network connections which replace the term *conversation*.

Where there might be the possibility of confusion between the two types of connections, the word will be qualified by SQL or network to help the reader to understand the intended meaning.

The following is an example of an application that runs in multiple activation groups. This example is used to illustrate the interaction between activation groups, connection management, and commitment control. It is **not** a recommended coding style.

Source code for PGM1

Here is the source code for PGM1.

```

...
EXEC SQL
  CONNECT TO SYSB
END-EXEC.
EXEC SQL
  SELECT ...
END-EXEC.
CALL PGM2.
...

```

Figure 4. Source code for PGM1

Command to create program and SQL package for PGM1:

```
CRTSQLCBL PGM(PGM1) COMMIT(*NONE) RDB(SYSB)
```

Source code for PGM2

Here is the source code for PGM2.

```
...
EXEC SQL
  CONNECT TO SYSC;
EXEC SQL
  DECLARE C1 CURSOR FOR
    SELECT ...;
EXEC SQL
  OPEN C1;
do {
  EXEC SQL
    FETCH C1 INTO :st1;
  EXEC SQL
    UPDATE ...
      SET COL1 = COL1+10
      WHERE CURRENT OF C1;
  PGM3(st1);
} while SQLCODE == 0;
EXEC SQL
  CLOSE C1;
EXEC SQL COMMIT;
...
```

Figure 5. Source code for PGM2

Command to create program and SQL package for PGM2:

```
CRTSQLCI OBJ(PGM2) COMMIT(*CHG) RDB(SYSC) OBJTYPE(*PGM)
```

Source code for PGM3

Here is the source code for PGM3.

```
...
EXEC SQL
  INSERT INTO TAB VALUES(:st1);
EXEC SQL COMMIT;
...
```

Figure 6. Source code for PGM3

Commands to create program and SQL package for PGM3:

```
CRTSQLCI OBJ(PGM3) COMMIT(*CHG) RDB(SYSD) OBJTYPE(*MODULE)
CRTPGM PGM(PGM3) ACTGRP(APPGRP)
CRTSQLPKG PGM(PGM3) RDB(SYSD)
```

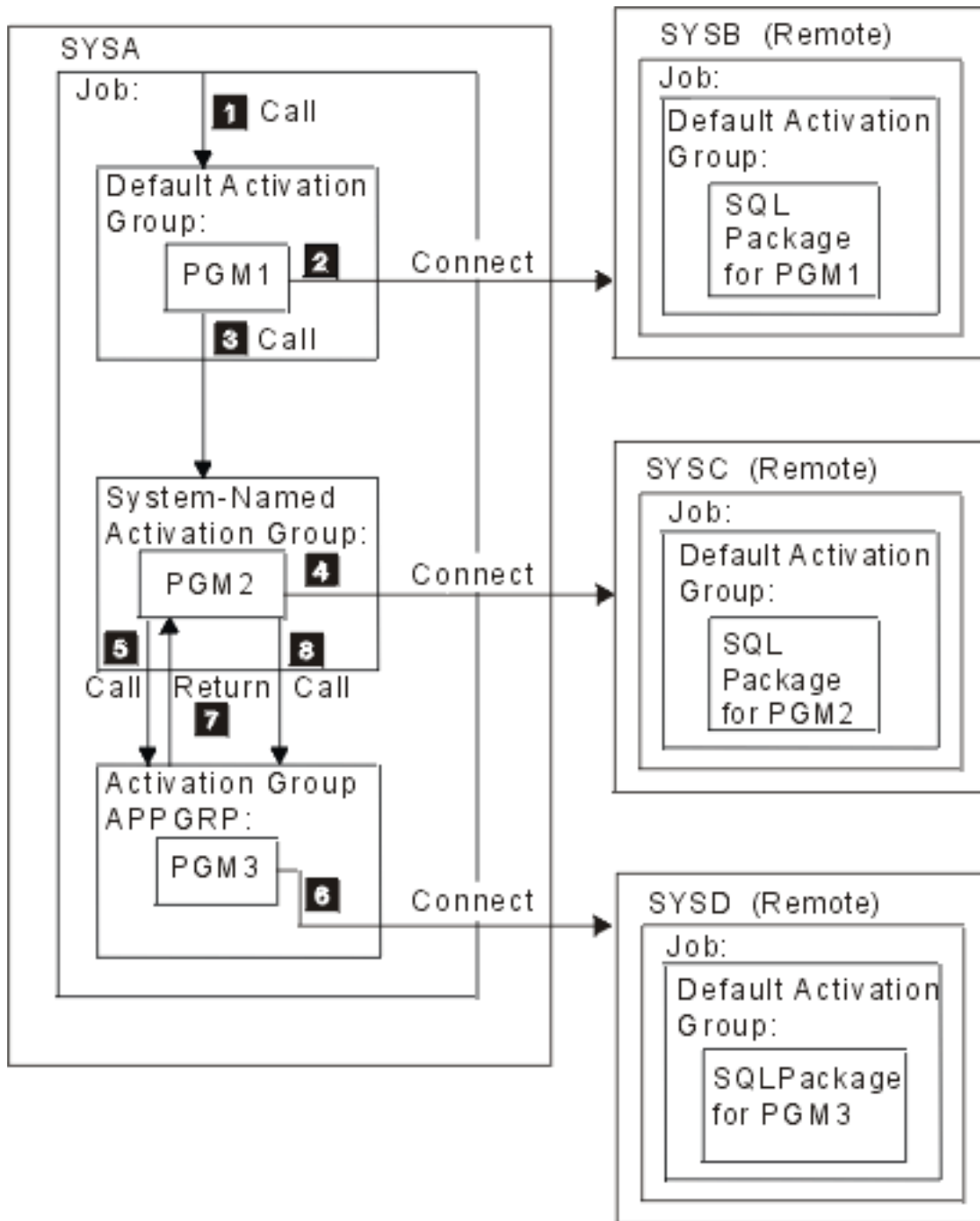

In this example, PGM1 is a non-ILE program created using the CRTSQLCBL command. This program runs in the default activation group. PGM2 is created using the CRTSQLCI command, and it runs in a system-named activation group. PGM3 is also created using the CRTSQLCI command, but it runs in the activation group named APPGRP. Because APPGRP is not the default value for the ACTGRP parameter, the CRTPGM command is issued separately. The CRTPGM command is followed by a CRTSQLPKG command that creates the SQL package object on the SYSD relational database. In this example, the user has not explicitly started the job level commitment definition. SQL implicitly starts commitment control.

1. PGM1 is called and runs in the default activation group.
2. PGM1 connects to relational database SYSB and runs a SELECT statement.
3. PGM1 then calls PGM2, which runs in a system-named activation group.
4. PGM2 does a connect to relational database SYSC. Because PGM1 and PGM2 are in different activation groups, the connection started by PGM2 in the system-named activation group does not disconnect the connection started by PGM1 in the default activation group. Both connections are active. PGM2

opens the cursor and fetches and updates a row. PGM2 is running under commitment control, is in the middle of a unit of work, and is not at a connectable state.

5. PGM2 calls PGM3, which runs in activation group APPGRP.
6. The INSERT statement is the first statement run in activation group APPGRP. The first SQL statement causes an implicit connect to relational database SYSD. A row is inserted into table TAB located at relational database SYSD. The insert is then committed. The pending changes in the system-named activation group are not committed, because commitment control was started by SQL with a commit scope of activation group.
7. PGM3 is then exited and control returns to PGM2. PGM2 fetches and updates another row.
8. PGM3 is called again to insert the row. An implicit connect was done on the first call to PGM3. It is not done on subsequent calls because the activation group did not end between calls to PGM3. Finally, all the rows are processed by PGM2 and the unit of work associated with the system-named activation group is committed.

Multiple connections to the same relational database

If different activation groups are connected to the same relational database, each SQL connection has its own network connection and its own application server job.

If activation groups are run with commitment control, changes committed in one activation group do not commit changes in other activation groups unless the job-level commitment definition is used.

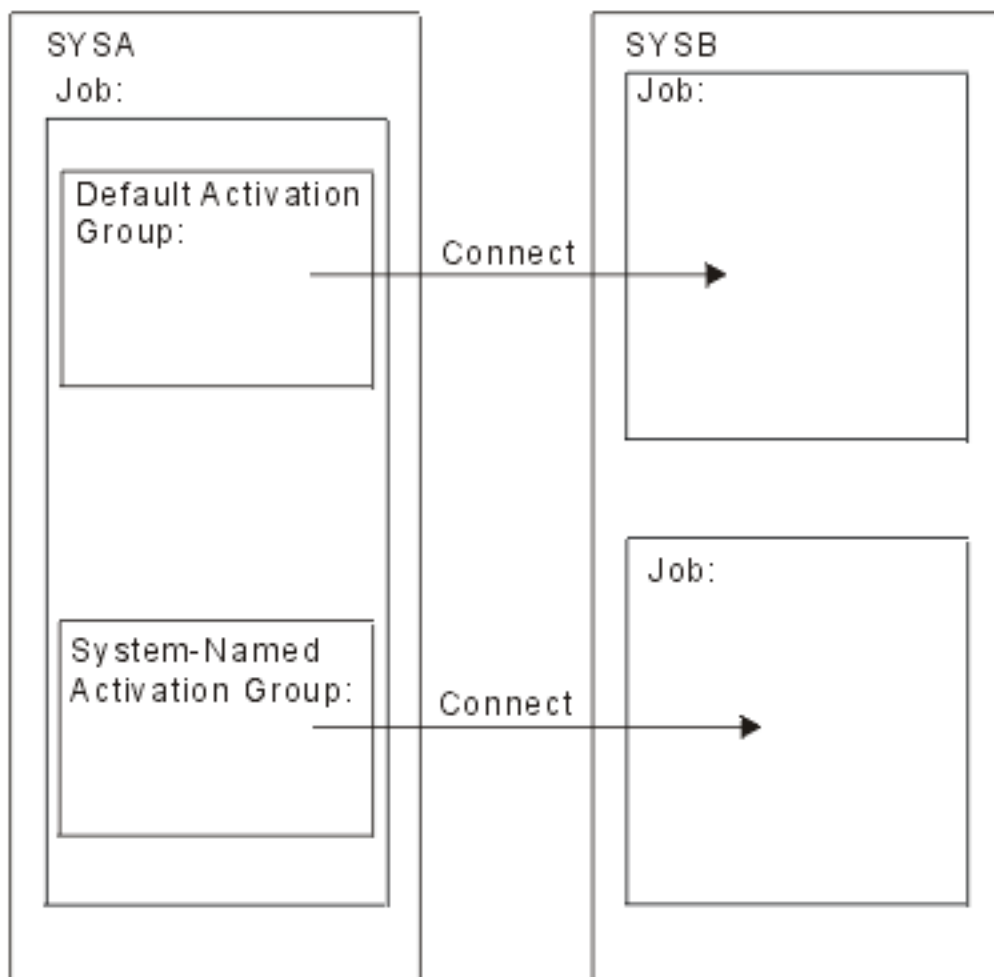

Implicit connection management for the default activation group

An application requester can be implicitly connected to an application server.

Implicit SQL connection occurs when the application requester detects the first SQL statement is being issued by the first active SQL program for the default activation group and the following items are true:

- The SQL statement being issued is not a CONNECT statement with parameters.
- SQL is not active in the default activation group.

For a distributed program, the implicit SQL connection is to the relational database specified on the RDB parameter. For a nondistributed program, the implicit SQL connection is to the local relational database.

SQL will end any active connections in the default activation group when SQL becomes not active. SQL becomes not active when:

- The application requester detects the first active SQL program for the process has ended and the following are all true:
 - There are no pending SQL changes
 - A SET TRANSACTION statement is not active
 - No programs that were precompiled with CLOSQLCSR(*ENDJOB) were run.

If there are pending changes, protected connections, or an active SET TRANSACTION statement, SQL is placed in the exited state. If programs precompiled with CLOSQLCSR(*ENDJOB) were run, SQL will remain active for the default activation group until the job ends.

- At the end of a unit of work, if SQL is in the exited state. This occurs when you issue a COMMIT or ROLLBACK command outside of an SQL program.
- At the end of a job.

Related reference

Ending connections

Because remote SQL connections use resources, you need to end the connections that are no longer used, as soon as possible. You can end connections implicitly or explicitly.

Implicit connection management for nondefault activation groups

An application requester can be implicitly connected to an application server. Implicit SQL connection occurs when the application requester detects that the first SQL statement issued for the activation group is not a CONNECT statement with parameters.

For a distributed program, the implicit SQL connection is made to the relational database specified on the RDB parameter. For a nondistributed program, the implicit SQL connection is made to the local relational database.

Implicit disconnect can occur at the following times in a process:

- When the activation group ends, if commitment control is not active, activation group level commitment control is active, or the job level commitment definition is at a unit of work boundary.

If the job level commitment definition is active and not at a unit of work boundary, SQL is placed in the exited state.

- If SQL is in the exited state, when the job level commitment definition is committed or rolled back.
- At the end of a job.

Related reference

Ending connections

Because remote SQL connections use resources, you need to end the connections that are no longer used, as soon as possible. You can end connections implicitly or explicitly.

Distributed support

Db2 for i supports these levels of distributed relational database.

- Remote unit of work (RUW)

Remote unit of work is where the preparation and running of SQL statements occurs at only one application server during a unit of work. An activation group with an application process at an application requester can connect to an application server and, within one or more units of work, run any number of static or dynamic SQL statements that refer to objects on the application server. Remote unit of work is also referred to as DRDA level 1.

- Distributed unit of work (DUW)

Distributed unit of work is where the preparation and running of SQL statements can occur at multiple applications servers during a unit of work. However, a single SQL statement can only refer to objects located at a single application server. Distributed unit of work is also referred to as DRDA level 2.

Distributed unit of work allows:

- Update access to multiple application servers in one logical unit of work
- or
- Update access to a single application server with read access to multiple application servers, in one logical unit of work.

Whether multiple application servers can be updated in a unit of work is dependent on the existence of a sync point manager at the application requester, sync point managers at the application servers, and two-phase commit protocol support between the application requester and the application servers.

The sync point manager is a system component that coordinates commit and rollback operations among the participants in the two-phase commit protocol. When running distributed updates, the sync point managers on the different systems cooperate to ensure that resources reach a consistent state. The protocols and flows used by sync point managers are also referred to as two-phase commit protocols. If two-phase commit protocols will be used, the connection is a protected resource; otherwise the connection is an unprotected resource.

Determining the connection type

When a remote SQL connection is established, it uses either an unprotected or a protected network connection.

With regards to committable updates, this SQL connection may be read-only, updatable, or unknown whether it is updatable when the connection is established. A committable update is any insert, delete, update, or DDL statement that is run under commitment control. If the connection is read-only, changes using COMMIT(*NONE) can still be run. After a CONNECT or SET CONNECTION, SQLERRD(4) of the SQLCA and DB2_CONNECTION_TYPE of the SQL diagnostic area indicate the type of connection.

DB2_CONNECTION_TYPE specific values are:

1. The connection is to the local relational database and the connection is protected.
2. The connection is to a remote relational database and the connection is unprotected.
3. The connection is to a remote relational database and the connection is protected.
4. The connection is to an application requester driver program and the connection is protected.

SQLERRD(4) specific values are:

1. The connection is to a remote relational database and the connection is unprotected. Committable updates can be performed on the connection. This will occur when any of the following are true:
 - The connection is established using remote unit of work (RUW).

- If the connection is established using distributed unit of work (DUW) then all the following are true:
 - The connection is not local.
 - The application server does not support distributed unit of work.
 - The commitment control level of the program issuing the connect is not *NONE.
 - Either no connections to other application servers (including local) exist that can perform committable updates or all connections are read-only connections to application servers that do not support distributed unit of work.
 - There are no open updatable local files under commitment control for the commitment definition.
 - There are no open updatable DDM files that use a different connection under commitment control for the commitment definition.
 - There are no API commitment control resources for the commitment definition.
 - There are no protected connections registered for the commitment definition.

If running with commitment control, SQL will register a one-phase updatable DRDA resource for remote connections or a two-phase updatable DRDA resource for local and ARD connections.

2. The connection is to a remote relational database and the connection is unprotected. The connection is read-only. This will occur only when the following are true:

- The connection is not local.
- The application server does not support distributed unit of work
- At least one of the following is true:
 - The commitment control level of the program issuing the connect is *NONE.
 - Another connection exists to an application server that does not support distributed unit-of-work and that application server can perform committable updates
 - Another connection exists to an application server that supports distributed unit-of-work (including local).
 - There are open updatable local files under commitment control for the commitment definition.
 - There are open updatable DDM files that use a different connection under commitment control for the commitment definition.
 - There are no one-phase API commitment control resources for the commitment definition.
 - There are protected connections registered for the commitment definition.

If running with commitment control, SQL will register a one-phase DRDA read-only resource.

3. The connection is to a remote relational database and the connection is protected. It is unknown if committable updates can be performed. This will occur when all of the following are true:

- The connection is not local.
- The commitment control level of the program issuing the connect is not *NONE.
- The application server supports both distributed unit of work and two-phase commit protocol (protected connections).

If running with commitment control, SQL will register a two-phase DRDA undetermined resource.

4. The connection is to a remote relational database and the connection is unprotected. It is unknown if committable updates can be performed. This will occur only when all of the following are true:

- The connection is not local.
- The application server supports distributed unit of work
- Either the application server does not support two-phase commit protocols (protected connections) or the commitment control level of the program issuing the connect is *NONE.

If running with commitment control, SQL will register a one-phase DRDA undetermined resource.

5. The connection is to the local database or an application requester driver (ARD) program and the connection is protected. It is unknown if committable updates can be performed. If running with commitment control, SQL will register a two-phase DRDA undetermined resource.

The following table summarizes the type of connection that will result for remote distributed unit of work connections. SQLERRD(4) is set on successful CONNECT and SET CONNECTION statements.

Table 64. Summary of connection type

Connect under commitment control	Application server supports two-phase commit	Application server supports distributed unit of work	Other updatable one-phase resource registered	SQLERRD(4)
No	No	No	No	2
No	No	No	Yes	2
No	No	Yes	No	4
No	No	Yes	Yes	4
No	Yes	No	No	2
No	Yes	No	Yes	2
No	Yes	Yes	No	4
No	Yes	Yes	Yes	4
Yes	No	No	No	1
Yes	No	No	Yes	2
Yes	No	Yes	No	4
Yes	No	Yes	Yes	4
Yes	Yes	No	No	N/A ¹
Yes	Yes	No	Yes	N/A ¹
Yes	Yes	Yes	No	3
Yes	Yes	Yes	Yes	3

¹DRDA does not allow protected connections to be used to application servers that support only remote unit of work (DRDA1). This includes all Db2 for IBM i TCP/IP connections.

Related concepts

[Commitment control](#)

Related reference

[Accessing remote databases with interactive SQL](#)

In interactive SQL, you can communicate with a remote relational database by using the SQL CONNECT statement. Interactive SQL uses the CONNECT (Type 2) semantics (distributed unit of work) for CONNECT statements.

Connect and commitment control restrictions

There are restrictions on when you can establish the connection using commitment control. The restrictions also apply if you attempt to run statements using commitment control, but you specified COMMIT(*NONE) on the connection.

If a two-phase undetermined or updatable resource is registered or a one-phase updatable resource is registered, another one-phase updatable resource cannot not be registered.

Furthermore, when protected connections are inactive and the DDMCNV job attribute is *KEEP, these unused DDM connections will also cause the CONNECT statements in programs compiled with RUW connection management to fail.

If running with RUW connection management and using the job-level commitment definition, then there are some restrictions.

- If the job-level commitment definition is used by more than one activation group, all RUW connections must be to the local relational database.
- If the connection is remote, only one activation group may use the job-level commitment definition for RUW connections.

Determining the connection status

A CONNECT statement without parameters can be used to determine whether the current connection is updatable or read-only for the current unit of work.

A value of 1 or 2 is returned in SQLERRD(3) in the SQLCA or DB2_CONNECTION_STATUS in the SQL diagnostic area. The value is determined as follows:

1. Committable updates can be performed on the connection for the unit of work.

This will occur when one of the following is true:

- The connection is established using remote unit of work (RUW).
- If the connection is established using distributed unit of work (DUW) and all of the following are true:
 - No connection exists to an application server that does not support distributed unit of work which can perform committable updates.
 - One of the following is true:
 - The first committable update is performed on a connection that uses a protected connection, is performed on the local database, or is performed on a connection to an ARD program.
 - There are open updatable local files under commitment control. .
 - There are open updatable DDM files that use protected connections.
 - There are two-phase API commitment control resources.
 - No committable updates have been made.
- If the connection is established using distributed unit of work (DUW) and all of the following are true:
 - No other connections exist to an application server that does not support distributed unit of work which can perform committable updates.
 - The first committable update is performed on this connection or no committable updates have been made.
 - There are no open updatable DDM files that use protected connections.
 - There are no open updatable local files under commitment control.
 - There are no two-phase API commitment control resources.

2. No committable updates can be performed on the connection for this unit of work.

This will occur when one of the following is true:

- If the connection is established using distributed unit of work (DUW) and one of the following are true:
 - A connection exists to an updatable application server that only supports remote unit of work.
 - The first committable update is performed on a connection that uses an unprotected connection.
- If the connection is established using distributed unit of work (DUW) and one of the following are true:
 - A connection exists to an updatable application server that only supports remote unit of work.

- The first committable update was not performed on this connection.
- There are open updatable DDM files that use protected connections.
- There are open updatable local files under commitment control.
- There are two-phase API commitment control resources.

The following table summarizes how the connection status is determined based on the connection type value, if there is an updatable connection to an application server that only supports remote unit of work, and where the first committable update occurred.

Table 65. Summary of determining connection status values

Connection method	Connection exists to updatable remote unit of work application server	Where first committable update occurred ¹	SQLERRD(3) or DB2_CONNECTION_STATUS
RUW			1
DUW	Yes		2
DUW	No	no updates	1
DUW	No	one-phase	2
DUW	No	this connection	1
DUW	No	two-phase	1

¹The terms in this column are defined as:

- *No updates* indicates no committable updates have been performed, no DDM files open for update using a protected connection, no local files are open for update, and no commitment control APIs are registered.
- *One-phase* indicates the first committable update was performed using an unprotected connection or DDM files are open for update using unprotected connections.
- *Two-phase* indicates a committable update was performed on a two-phase distributed-unit-of-work application server, DDM files are open for update using a protected connection, commitment control APIs are registered, or local files are open for update under commitment control.

If an attempt is made to perform a committable update over a read-only connection, the unit of work will be placed in a rollback required state. If an unit of work is in a rollback required state, the only statement allowed is a ROLLBACK statement; all other statements will result in SQLCODE -918.

Distributed unit of work connection considerations

When you connect in a distributed unit of work application, consider these points.

- If the unit of work will perform updates at more than one application server and commitment control will be used, all connections over which updates will be done should be made using commitment control. If the connections are done not using commitment control and later committable updates are performed, read-only connections for the unit of work are likely to result.
- Other non-SQL commit resources, such as local files, DDM files, and commitment control API resources, will affect the updatable and read-only status of a connection.
- If you connect using commitment control to an application server that does not support distributed unit of work (for example, a V4R5 system using TCP/IP), that connection is either updatable or read-only. If the connection is updatable, it is the only updatable connection. Since V5R3, Distributed Relational Database Architecture (DRDA) two-phase-commit operations have taken the following updates into consideration:
 - Updates done as a result of triggers
 - Updates done as a result of user-defined functions that are activated during a database query

Ending connections

Because remote SQL connections use resources, you need to end the connections that are no longer used, as soon as possible. You can end connections implicitly or explicitly.

Connections can be explicitly ended by either the DISCONNECT statement or the RELEASE statement followed by a successful COMMIT. The DISCONNECT statement can only be used with connections that use unprotected connections or with local connections. The DISCONNECT statement will end the connection when the statement is run. The RELEASE statement can be used with either protected or unprotected connections. When the RELEASE statement is run, the connection is not ended but instead placed into the released state. A connection that is in the release state can still be used. The connection is not ended until a successful COMMIT is run. A ROLLBACK or an unsuccessful COMMIT will not end a connection in the released state.

When a remote SQL connection is established, a distributed data management (DDM) network connection (Advanced Program-to-Program Communication (APPC) conversation or TCP/IP connection) is used. When the SQL connection is ended, the network connection might either be placed in the unused state or dropped. Whether a network connection is dropped or placed in the unused state depends on the DDMCNV job attribute. If the job attribute value is *KEEP and the connection is to a server on the IBM i platform, the connection becomes unused. If the job attribute value is *DROP and the connection is to a server on the IBM i platform, the connection is dropped. If the connection is to a server on a non-IBM i platform, the connection is always dropped. *DROP is desirable in the following situations:

- When the cost of maintaining the unused connection is high and the connection will not be used relatively soon.
- When running with a mixture of programs, some compiled with RUW connection management and some programs compiled with DUW connection management. Attempts to run programs compiled with RUW connection management to remote locations will fail when protected connections exist.
- When running with protected connections using either DDM or DRDA. Additional overhead is incurred on commits and rollbacks for unused protected connections.

The Reclaim DDM connections (RCLDDMCNV) command may be used to end all unused connections, if they are at a commit boundary.

Related reference

[Implicit connection management for the default activation group](#)

An application requester can be implicitly connected to an application server.

[Implicit connection management for nondefault activation groups](#)

An application requester can be implicitly connected to an application server. Implicit SQL connection occurs when the application requester detects that the first SQL statement issued for the activation group is not a CONNECT statement with parameters.

Distributed unit of work

Distributed unit of work (DUW) allows access to multiple application servers within the same unit of work.

Each SQL statement can access only one application server. Using distributed unit of work allows changes at multiple application servers to be committed or rolled back within a single unit of work.

Managing distributed unit of work connections

You can use the CONNECT, SET CONNECTION, DISCONNECT, and RELEASE statements to manage connections in the distributed unit of work (DUW) environment.

A distributed unit of work CONNECT is run when the program is precompiled using RDBCNNMTH(*DUW), which is the default. This form of the CONNECT statement does not disconnect existing connections but instead places the previous connection in the dormant state. The relational database specified on the CONNECT statement becomes the current connection. The CONNECT statement can only be used to start new connections; if you want to switch between existing connections, the SET CONNECTION statement must be used. Because connections use system resources, connections should be ended when they

are no longer needed. The RELEASE or DISCONNECT statement can be used to end connections. The RELEASE statement must be followed by a successful commit in order for the connections to end.

The following is an example of a C program running in a DUW environment that uses commitment control.

```

...
EXEC SQL WHENEVER SQLERROR GO TO done;
EXEC SQL WHENEVER NOT FOUND GO TO done;
...
EXEC SQL
  DECLARE C1 CURSOR WITH HOLD FOR
  SELECT PARTNO, PRICE
    FROM PARTS
    WHERE SITES_UPDATED = 'N'
    FOR UPDATE OF SITES_UPDATED;
/* Connect to the systems */
EXEC SQL CONNECT TO LOCALSYS;
EXEC SQL CONNECT TO SYSB;
EXEC SQL CONNECT TO SYSC;
/* Make the local system the current connection */
EXEC SQL SET CONNECTION LOCALSYS;
/* Open the cursor */
EXEC SQL OPEN C1;

while (SQLCODE==0)
{
  /* Fetch the first row */
  EXEC SQL FETCH C1 INTO :partnumber,:price;
  /* Update the row which indicates that the updates have been
     propagated to the other sites */
  EXEC SQL UPDATE PARTS SET SITES_UPDATED='Y'
    WHERE CURRENT OF C1;
  /* Check if the part data is on SYSB */
  if ((partnumber > 10) && (partnumber < 100))
  {
    /* Make SYSB the current connection and update the price */
    EXEC SQL SET CONNECTION SYSB;
    EXEC SQL UPDATE PARTS
      SET PRICE=:price
      WHERE PARTNO=:partnumber;
  }

  /* Check if the part data is on SYSC */
  if ((partnumber > 50) && (partnumber < 200))
  {
    /* Make SYSC the current connection and update the price */
    EXEC SQL SET CONNECTION SYSC;
    EXEC SQL UPDATE PARTS
      SET PRICE=:price
      WHERE PARTNO=:partnumber;
  }
  /* Commit the changes made at all 3 sites */
  EXEC SQL COMMIT;
  /* Set the current connection to local so the next row
     can be fetched */
  EXEC SQL SET CONNECTION LOCALSYS;
}
done:

EXEC SQL WHENEVER SQLERROR CONTINUE;
/* Release the connections that are no longer being used */
EXEC SQL RELEASE SYSB;
EXEC SQL RELEASE SYSC;
/* Close the cursor */
EXEC SQL CLOSE C1;
/* Do another commit which will end the released connections.
   The local connection is still active because it was not
   released. */
EXEC SQL COMMIT;
...

```

Figure 7. Example of distributed unit of work program

In this program, there are three application servers active: LOCALSYS which the local system, and two remote systems, SYSB and SYSC. SYSB and SYSC also support distributed unit of work and two-phase commit.

Initially all connections are made active by using the `CONNECT` statement for each of the application servers involved in the transaction. When using DUW, a `CONNECT` statement does not disconnect the previous connection, but instead places the previous connection in the dormant state. After all the application servers have been connected, the local connection is made the current connection using the `SET CONNECTION` statement. The cursor is then opened and the first row of data fetched. It is then determined at which application servers the data needs to be updated. If SYSB needs to be updated, then SYSB is made the current connection using the `SET CONNECTION` statement and the update is run. The same is done for SYSC. The changes are then committed.

Because two-phase commit is being used, it is guaranteed that the changes are committed at the local system and the two remote systems. Because the cursor was declared `WITH HOLD`, it remains open after the commit. The current connection is then changed to the local system so that the next row of data can be fetched. This set of fetches, updates, and commits is repeated until all the data has been processed.

After all the data has been fetched, the connections for both remote systems are released. They cannot be disconnected because they use protected connections. After the connections are released, a commit is issued to end the connections. The local system is still connected and continues processing.

Checking the connection status

When it is possible to have a read-only connection, your program should check the status of the connection before doing any committable updates. This prevents the unit of work from entering the rollback required state.

The following COBOL example shows how to check the connection status.

```
...
EXEC SQL
  SET CONNECTION SYS5
END-EXEC.
...
* Check if the connection is updatable.
EXEC SQL CONNECT END-EXEC.
* If connection is updatable, update sales information otherwise
* inform the user.
IF SQLERRD(3) = 1 THEN
  EXEC SQL
    INSERT INTO SALES_TABLE
      VALUES (:SALES-DATA)
  END-EXEC
ELSE
  DISPLAY 'Unable to update sales information at this time'.
...

```

Figure 8. Example of checking connection status

Cursors and prepared statements

Cursors and prepared statements are scoped to the compilation unit and also to the connection.

Scoping to the compilation unit means that a program called from another separately compiled program cannot use a cursor or prepared statement that was opened or prepared by the calling program. Scoping to the connection means that each connection within a program can have its own separate instance of a cursor or prepared statement.

The following distributed unit of work example shows how the same cursor name is opened in two different connections, resulting in two instances of cursor C1.

```

...
EXEC SQL DECLARE C1 CURSOR FOR
        SELECT * FROM CORPDATA.EMPLOYEE;
/* Connect to local and open C1 */
EXEC SQL CONNECT TO LOCALSYS;
EXEC SQL OPEN C1;
/* Connect to the remote system and open C1 */
EXEC SQL CONNECT TO SYSA;
EXEC SQL OPEN C1;
/* Keep processing until done */
while (NOT_DONE) {
    /* Fetch a row of data from the local system */
    EXEC SQL SET CONNECTION LOCALSYS;
    EXEC SQL FETCH C1 INTO :local_emp_struct;
    /* Fetch a row of data from the remote system */
    EXEC SQL SET CONNECTION SYSA;
    EXEC SQL FETCH C1 INTO :rmt_emp_struct;
    /* Process the data */
    ...
}
/* Close the cursor on the remote system */
EXEC SQL CLOSE C1;
/* Close the cursor on the local system */
EXEC SQL SET CONNECTION LOCALSYS;
EXEC SQL CLOSE C1;
...

```

Figure 9. Example of cursors in a DUW program

DRDA stored procedure considerations

The IBM i Distributed Relational Database Architecture (DRDA) server supports the return of one or more result sets in a stored procedure.

You can generate result sets in a stored procedure by opening one or more SQL cursors associated with SELECT statements. In addition, a maximum of one array result set can also be returned. Before V5R3, only one instance of a query opened in a stored procedure was allowed to be open at one time. Now you can make multiple calls to the same stored procedure without closing the result set cursors so that more than one instance of a query can be opened simultaneously.

Related concepts

[Stored procedures](#)

A *procedure* (often called a stored procedure) is a program that can be called to perform operations. A procedure can include both host language statements and SQL statements. Procedures in SQL provide the same benefits as procedures in a host language.

[Distributed database programming](#)

Related reference

[SET RESULT SETS](#)

[CREATE PROCEDURE \(SQL\)](#)

[CREATE PROCEDURE \(External\)](#)

WebSphere MQ with Db2

WebSphere® MQ is a message handling system that enables applications to communicate in a distributed environment across different operating systems and networks.

WebSphere MQ handles the communication from one program to another by using application programming interfaces (APIs). You can use any of the following APIs to interact with the WebSphere MQ message handling system:

- Message Queue Interface (MQI)
- WebSphere MQ classes for Java
- WebSphere MQ classes for Java Message Service (JMS)

Db2 provides its own application programming interface to the WebSphere MQ message handling system through a set of external user-defined functions, which are called Db2 MQ functions. You can use these functions in SQL statements to combine Db2 database access with WebSphere MQ message handling. The Db2 MQ functions use the MQI APIs.

WebSphere MQ messages

WebSphere MQ uses messages to pass information between applications.

Messages consist of the following parts:

- The message attributes, which identify the message and its properties.
- The message data, which is the application data that is carried in the message.

WebSphere MQ message handling

Conceptually, the WebSphere MQ message handling system takes a piece of information (the message) and sends it to its destination. MQ guarantees delivery despite any network disruptions that might occur.

In WebSphere MQ, a destination is called a message queue, and a queue resides in a queue manager. Applications can put messages on queues or get messages from them.

Db2 communicates with the WebSphere message handling system through a set of external user-defined functions, which are called Db2 MQ functions. These functions use the MQI APIs.

When you send a message by using the MQI APIs, you must specify following three components:

message data

Defines what is sent from one program to another.

service

Defines where the message is going to or coming from. The parameters for managing a queue are defined in the service, which is typically defined by a system administrator. The complexity of the parameters in the service is hidden from the application program.

policy

Defines how the message is handled. Policies control such items as:

- The attributes of the message, for example, the priority.
- Options for send and receive operations, for example, whether an operation is part of a unit of work.

MQ functions use the services and policies that are defined in two Db2 tables, SYSIBM.MQSERVICE_TABLE and SYSIBM.MQPOLICY_TABLE. These tables are automatically created by Db2, but once created, they are user-managed and typically maintained by a system administrator. Db2 initially provides each table with a row for the default service and default policy. The default service is Db2.DEFAULT.SERVICE and the default policy is Db2.DEFAULT.POLICY.

The application program does not need to know the details of the services and policies that are defined in these tables. The application need only specify which service and policy to use for each message that it sends and receives. The application specifies this information when it invokes a Db2 MQ function.

Db2 MQ services

A service describes a destination to which an application sends messages or from which an application receives messages. Db2 MQ services are defined in the Db2 table SYSIBM.MQSERVICE_TABLE.

When an application program invokes a Db2 MQ function, the program selects a service from SYSIBM.MQSERVICE_TABLE by specifying it as a parameter.

The SYSIBM.MQSERVICE_TABLE is automatically created by Db2, but once created, it is user-managed and typically maintained by a system administrator. Db2 initially provides a row for the default service. The default service is DB2.DEFAULT.SERVICE.

A new service can be added simply by issuing an INSERT statement. For example, the following statement adds a new service called MYSERVICE. The MQ default queue manager and the MYQUEUE input queue will be used for this new service.

```
INSERT INTO SYSIBM.MQSERVICE_TABLE (SERVICENAME, QUEUEMANAGER, INPUTQUEUE)  
VALUES('MYSERVICE', SPACE(48), 'MYQUEUE')
```

A service can be changed (including the default service) simply by issuing an UPDATE statement. For performance reasons, Db2 caches the service information so any existing job that has already used an MQ function will typically not detect a concurrent change to a service. The following statement updates the service called MYSERVICE by changing the input queue to MYQUEUE2.

```
UPDATE SYSIBM.MQSERVICE_TABLE  
SET INPUTQUEUE = 'MYQUEUE2'  
WHERE SERVICENAME = 'MYSERVICE'
```

Note: The default input queue initially used by the default service DB2.DEFAULT.SERVICE is the MQ model queue called SYSTEM.DEFAULT.LOCAL.QUEUE. The default input queue used by other Db2 products is DB2MQ_DEFAULT_Q. For compatibility with other Db2 products, you may wish to create a new input queue called DB2MQ_DEFAULT_Q and update the default service. For example:

```
CL: CRTMQMQ QNAME(DB2MQ_DEFAULT_Q) QTYPE(*LCL);  
UPDATE SYSIBM.MQSERVICE_TABLE  
SET INPUTQUEUE = 'DB2MQ_DEFAULT_Q'  
WHERE SERVICENAME = 'DB2.DEFAULT.SERVICE'
```

Db2 MQ policies

A policy controls how the MQ messages are handled. Db2 MQ policies are defined in the Db2 table SYSIBM.MQPOLICY_TABLE. When an application program invokes a Db2 MQ function, the program selects a policy from SYSIBM.MQPOLICY_TABLE by specifying it as a parameter.

The SYSIBM.MQPOLICY_TABLE is automatically created by Db2, but once created, it is user-managed and typically maintained by a system administrator. Db2 initially provides a row for the default policy. The default policy is DB2.DEFAULT.POLICY.

A new policy can be added simply by issuing an INSERT statement. For example, the following statement adds a new policy called MYPOLICY. Since the value of the SYNCPOINT column is 'N', any MQ functions that use MYPOLICY will not run under a transaction.

```
INSERT INTO SYSIBM.MQPOLICY_TABLE (POLICYNAME, SYNCPOINT, DESCRIPTION)  
VALUES('MYPOLICY', 'N', 'Policy to not run under a transaction')
```

A policy can be changed (including the default policy) simply by issuing an UPDATE statement. For performance reasons, Db2 caches the policy information so any existing job that has already used an MQ function will typically not detect a concurrent change to a policy. The following statement updates the policy called MYPOLICY by changing the retry interval to 5 seconds.

```
UPDATE SYSIBM.MQPOLICY_TABLE  
SET SEND_RETRY_INTERVAL = 5000  
WHERE POLICYNAME = 'MYPOLICY'
```

Db2 MQ functions

You can use the Db2 MQ functions to send messages to a message queue or to receive messages from the message queue. You can send a request to a message queue and receive a response.

The Db2 MQ functions support the following types of operations:

- Send and forget, where no reply is needed.
- Read or receive, where one or all messages are either read without removing them from the queue, or received and removed from the queue.
- Request and response, where a sending application needs a response to a request.

The WebSphere MQ server is located on the same IBM i as Db2. The Db2 MQ functions are registered with Db2 and provide access to the WebSphere MQ server by using the MQI APIs.

The following table describes the Db2 MQ scalar functions.

<i>Table 66. Db2 MQ Scalar Functions</i>	
Scalar function	Description
MQREAD	MQREAD returns a message in a VARCHAR variable from the MQ location specified by <i>receive-service</i> , using the policy defined in <i>service-policy</i> . This operation does not remove the message from the head of the queue but instead returns it. If no messages are available to be returned, a null value is returned.
MQREADCLOB	MQREADCLOB returns a message in a CLOB variable from the MQ location specified by <i>receive-service</i> , using the policy defined in <i>service-policy</i> . This operation does not remove the message from the head of the queue but instead returns it. If no messages are available to be returned, a null value is returned.
MQRECEIVE	MQRECEIVE returns a message in a VARCHAR variable from the MQ location specified by <i>receive-service</i> , using the policy defined in <i>service-policy</i> . This operation removes the message from the queue. If <i>correlation-id</i> is specified, the first message with a matching correlation identifier is returned; if <i>correlation-id</i> is not specified, the message at the beginning of queue is returned. If no messages are available to be returned, a null value is returned.
MQRECEIVECLOB	MQRECEIVECLOB returns a message in a CLOB variable from the MQ location specified by <i>receive-service</i> , using the policy defined in <i>service-policy</i> . This operation removes the message from the queue. If <i>correlation-id</i> is specified, the first message with a matching correlation identifier is returned; if <i>correlation-id</i> is not specified, the message at the head of queue is returned. If no messages are available to be returned, a null value is returned.
MQSEND	MQSEND sends the data in a VARCHAR or CLOB variable <i>msg-data</i> to the MQ location specified by <i>send-service</i> , using the policy defined in <i>service-policy</i> . An optional user-defined message correlation identifier can be specified by <i>correlation-id</i> . The return value is 1 if successful or 0 if not successful.
Notes:	
1. You can send or receive messages in VARCHAR variables or CLOB variables. The maximum length for a message in a VARCHAR variable is 32000. The maximum length for a message in a CLOB variable is 2 MB.	

The following table describes the Db2 MQ table functions.

<i>Table 67. Db2 MQ Table Functions</i>	
Table function	Description
MQREADALL	MQREADALL returns a table that contains the messages and message metadata in VARCHAR variables from the MQ location specified by <i>receive-service</i> , using the policy defined in <i>service-policy</i> . This operation does not remove the messages from the queue. If <i>num-rows</i> is specified, a maximum of <i>num-rows</i> messages is returned; if <i>num-rows</i> is not specified, all available messages are returned.
MQREADALLCLOB	MQREADALLCLOB returns a table that contains the messages and message metadata in CLOB variables from the MQ location specified by <i>receive-service</i> , using the policy defined in <i>service-policy</i> . This operation does not remove the messages from the queue. If <i>num-rows</i> is specified, a maximum of <i>num-rows</i> messages is returned; if <i>num-rows</i> is not specified, all available messages are returned.

Table 67. Db2 MQ Table Functions (continued)

Table function	Description
MQRECEIVEALL	MQRECEIVEALL returns a table that contains the messages and message metadata in VARCHAR variables from the MQ location specified by <i>receive-service</i> , using the policy defined in <i>service-policy</i> . This operation removes the messages from the queue. If <i>correlation-id</i> is specified, only those messages with a matching correlation identifier are returned; if <i>correlation-id</i> is not specified, all available messages are returned. If <i>num-rows</i> is specified, a maximum of <i>num-rows</i> messages is returned; if <i>num-rows</i> is not specified, all available messages are returned.
MQRECEIVEALLCLOB	MQRECEIVEALLCLOB returns a table that contains the messages and message metadata in CLOB variables from the MQ location specified by <i>receive-service</i> , using the policy defined in <i>service-policy</i> . This operation removes the messages from the queue. If <i>correlation-id</i> is specified, only those messages with a matching correlation identifier are returned; if <i>correlation-id</i> is not specified, all available messages are returned. If <i>num-rows</i> is specified, a maximum of <i>num-rows</i> messages is returned; if <i>num-rows</i> is not specified, all available messages are returned.
Notes:	
<ol style="list-style-type: none"> 1. You can send or receive messages in VARCHAR variables or CLOB variables. The maximum length for a message in a VARCHAR variable is 32000. The maximum length for a message in a CLOB variable is 2 MB. 2. The first column of the result table of a Db2 MQ table function contains the message. 	

Db2 MQ dependencies

In order to use the Db2 MQ functions, IBM MQSeries® for IBM i must be installed, configured, and operational.

Detailed information on installation and configuration can be found in the Websphere MQSeries Information Center. At a minimum, the following steps are necessary once you have completed the install of IBM MQSeries for IBM i:

1. Start the MQSeries subsystem

```
CL: STRSBS SBSDB(QMQM/QMQM);
```

2. Create a default MQ message queue manager. For example:

```
CL: ADDLIB QMQM;
CL: CRTMQM MQMNAME(MJAQM) DFTQMGR(*YES);
```

Ensure that the job default CCSID is set to the primary use for MQ since the CCSID of the MQ message queue manager is set to the job default CCSID when it is created.

3. Start the default MQ message queue manager.

```
CL: STRMQM MQMNAME(MJAQM);
```

Db2 MQ tables

The Db2 MQ tables contain service and policy definitions that are used by the Db2 MQ functions.

The Db2 MQ tables are SYSIBM.MQSERVICE_TABLE and SYSIBM.MQPOLICY_TABLE. These tables are user-managed. The tables are initially created by Db2 and populated with one default service (DB2.DEFAULT.SERVICE) and one default policy (DB2.DEFAULT.POLICY). You may modify the attributes

of the default service and policy by updating the rows in the tables. You can add additional services and policies by inserting additional rows in the tables.

The following table describes the columns for SYSIBM.MQSERVICE_TABLE.

<i>Table 68. SYSIBM.MQSERVICE_TABLE column descriptions</i>	
Column name	Description
SERVICENAME	This column contains the service name, which is an optional input parameter of the MQ functions. This column is the primary key for the SYSIBM.MQSERVICE_TABLE table.
QUEUEMANAGER	This column contains the name of the queue manager where the MQ functions are to establish a connection. If the column consists of 48 blanks, the name of the default MQSeries queue manager is used.
INPUTQUEUE	This column contains the name of the queue from which the MQ functions are to send and retrieve messages.
CODEDCHARSETID	This column contains the character set identifier (CCSID) for data in the messages that are sent and received by the MQ functions. This column corresponds to the CodedCharSetId field (MDCSI) in the message descriptor (MQMD). MQ functions use the value in this column to set the CodedCharSetId field. The default value for this column is -3, which causes Db2 to set the CodedCharSetId field (MDCSI) to the default job CCSID.
ENCODING	This column contains the encoding value for the numeric data in the messages that are sent and received by the MQ functions. This column corresponds to the Encoding field (MDENC) in the message descriptor (MQMD). MQ functions use the value in this column to set the Encoding field. The default value for this column is 0, which sets the Encoding field (MDENC) to the value MQENC_NATIVE.
DESCRIPTION	This column contains the detailed description of the service.

The following table describes the columns for SYSIBM.MQPOLICY_TABLE.

<i>Table 69. SYSIBM.MQPOLICY_TABLE column descriptions</i>	
Column name	Description
POLICYNAME	This column contains the policy name, which is an optional input parameter of the MQ functions. This column is the primary key for the SYSIBM.MQPOLICY_TABLE table.
SEND_PRIORITY	This column contains the priority of the message. This column corresponds to the Priority field in the message descriptor (MQMD). MQ functions use the value in this column to set the Priority field. The default value for this column is -1, which sets the Priority field in the MQMD to the value MQQPRI_PRIORITY_AS_Q_DEF.

Table 69. SYSIBM.MQPOLICY_TABLE column descriptions (continued)

Column name	Description
SEND_PERSISTENCE	<p>This column indicates whether the message persists despite any system failures or instances of restarting the queue manager.</p> <p>This column corresponds to the Persistence field in the message descriptor (MQMD). MQ functions use the value in this column to set the Persistence field.</p> <p>This column can have the following values:</p> <p>Q Sets the Persistence field in the MQMD to the value MQPER_PERSISTENCE_AS_Q_DEF. This value is the default.</p> <p>Y Sets the Persistence field in the MQMD to the value MQPER_PERSISTENT.</p> <p>N Sets the Persistence field in the MQMD to the value MQPER_NOT_PERSISTENT.</p>
SEND_EXPIRY	<p>This column contains the message expiration time, in tenths of a second.</p> <p>This column corresponds to the Expiry field in the message descriptor (MQMD). MQ functions use the value in this column to set the Expiry field.</p> <p>The default value is -1, which sets the Expiry field to the value MQEI_UNLIMITED.</p>
SEND_RETRY_COUNT	<p>This column contains the number of times that the MQ function is to try to send a message if the procedure fails.</p> <p>The default value is 5.</p>
SEND_RETRY_INTERVAL	<p>This column contains the interval, in milliseconds, between each attempt to send a message.</p> <p>The default value is 1000.</p>
SEND_NEW_CORRELID	<p>This column specifies how the correlation identifier is to be set if a correlation identifier is not passed as an input parameter in the MQ function. The correlation identifier is set in the CorrelId field in the message descriptor (MQMD).</p> <p>This column can have one of the following values:</p> <p>N Sets the CorrelId field in the MQMD to binary zeros. This value is the default.</p> <p>Y Specifies that the queue manager is to generate a new correlation identifier and set the CorrelId field in the MQMD to that value. This 'Y' value is equivalent to setting the MQPMO_NEW_CORREL_ID option in the Options field in the put message options (MQPMO).</p>

Table 69. SYSIBM.MQPOLICY_TABLE column descriptions (continued)

Column name	Description
SEND_RESPONSE_MSGID	<p>This column specifies how the MsgId field in the message descriptor (MQMD) is to be set for report and reply messages.</p> <p>This column corresponds to the Report field in the MQMD. MQ functions use the value in this column to set the Report field.</p> <p>This column can have one of the following values:</p> <p>N Sets the MQRO_NEW_MSG_ID option in the Report field in the MQMD. This value is the default.</p> <p>P Sets the MQRO_PASS_MSG_ID option in the Report field in the MQMD.</p>
SEND_RESPONSE_CORRELID	<p>This column specifies how the CorrelID field in the message descriptor (MQMD) is to be set for report and reply messages.</p> <p>This column corresponds to the Report field in the MQMD. MQ functions use the value in this column to set the Report field.</p> <p>This column can have one of the following values:</p> <p>C Sets the MQRO_COPY_MSG_ID_TO_CORREL_ID option in the Report field in the MQMD. This value is the default.</p> <p>P Sets the MQRO_PASS_CORREL_ID option in the Report field in the MQMD.</p>
SEND_EXCEPTION_ACTION	<p>This column specifies what to do with the original message when it cannot be delivered to the destination queue.</p> <p>This column corresponds to the Report field in the message descriptor (MQMD). MQ functions use the value in this column to set the Report field.</p> <p>This column can have one of the following values:</p> <p>Q Sets the MQRO_DEAD_LETTER_Q option in the Report field in the MQMD. This value is the default.</p> <p>D Sets the MQRO_DISCARD_MSG option in the Report field in the MQMD.</p> <p>P Sets the MQRO_PASS_DISCARD_AND_EXPIRY option in the Report field in the MQMD.</p>

Table 69. SYSIBM.MQPOLICY_TABLE column descriptions (continued)

Column name	Description
SEND_REPORT_EXCEPTION	<p>This column specifies whether an exception report message is to be generated when a message cannot be delivered to the specified destination queue and if so, what that report message should contain.</p> <p>This column corresponds to the Report field in the message descriptor (MQMD). MQ functions use the value in this column to set the Report field.</p> <p>This column can have one of the following values:</p> <p>N Specifies that an exception report message is not to be generated. No options in the Report field are set. This value is the default.</p> <p>E Sets the MQRO_EXCEPTION option in the Report field in the MQMD.</p> <p>D Sets the MQRO_EXCEPTION_WITH_DATA option in the Report field in the MQMD.</p> <p>F Sets the MQRO_EXCEPTION_WITH_FULL_DATA option in the Report field in the MQMD.</p>
SEND_REPORT_COA	<p>This column specifies whether the queue manager is to send a confirm-on-arrival (COA) report message when the message is placed in the destination queue, and if so, what that COA message is to contain.</p> <p>This column corresponds to the Report field in the message descriptor (MQMD). MQ functions use the value in this column to set the Report field.</p> <p>This column can have one of the following values:</p> <p>N Specifies that a COA message is not to be sent. No options in the Report field are set. This value is the default</p> <p>C Sets the MQRO_COA option in the Report field in the MQMD</p> <p>D Sets the MQRO_COA_WITH_DATA option in the Report field in the MQMD.</p> <p>F Sets the MQRO_COA_WITH_FULL_DATA option in the Report field in the MQMD.</p>

Table 69. SYSIBM.MQPOLICY_TABLE column descriptions (continued)

Column name	Description
SEND_REPORT_COD	<p>This column specifies whether the queue manager is to send a confirm-on-delivery (COD) report message when an application retrieves and deletes a message from the destination queue, and if so, what that COD message is to contain.</p> <p>This column corresponds to the Report field in the message descriptor (MQMD). MQ functions use the value in this column to set the Report field.</p> <p>This column can have one of the following values:</p> <p>N Specifies that a COD message is not to be sent. No options in the Report field are set. This value is the default.</p> <p>C Sets the MQRO_COD option in the Report field in the MQMD.</p> <p>D Sets the MQRO_COD_WITH_DATA option in the Report field in the MQMD.</p> <p>F Sets the MQRO_COD_WITH_FULL_DATA option in the Report field in the MQMD.</p>
SEND_REPORT_EXPIRY	<p>This column specifies whether the queue manager is to send an expiration report message if a message is discarded before it is delivered to an application, and if so, what that message is to contain.</p> <p>This column corresponds to the Report field in the message descriptor (MQMD). MQ functions use the value in this column to set the Report field.</p> <p>This column can have one of the following values:</p> <p>N Specifies that an expiration report message is not to be sent. No options in the Report field are set. This value is the default.</p> <p>C Sets the MQRO_EXPIRATION option in the Report field in the MQMD.</p> <p>D Sets the MQRO_EXPIRATION_WITH_DATA option in the Report field in the MQMD.</p> <p>F Sets the MQRO_EXPIRATION_WITH_FULL_DATA option in the Report field in the MQMD.</p>

Table 69. SYSIBM.MQPOLICY_TABLE column descriptions (continued)

Column name	Description
SEND_REPORT_ACTION	<p>This column specifies whether the receiving application sends a positive action notification (PAN), a negative action notification (NAN), or both.</p> <p>This column corresponds to the Report field in the message descriptor (MQMD). MQ functions use the value in this column to set the Report field.</p> <p>This column can have one of the following values:</p> <p>N Specifies that neither notification is to be sent. No options in the Report field are set. This value is the default.</p> <p>P Sets the MQRO_PAN option in the Report field in the MQMD.</p> <p>T Sets the MQRO_NAN option in the Report field in the MQMD.</p> <p>B Sets both the MQRO_PAN and MQRO_NAN options in the Report field in the MQMD.</p>
SEND_MSG_TYPE	<p>This column contains the type of message.</p> <p>This column corresponds to the MsgType field in the message descriptor (MQMD). MQ functions use the value in this column to set the MsgType field.</p> <p>This column can have one of the following values:</p> <p>DTG Sets the MsgType field in the MQMD to MQMT_DATAGRAM. This value is the default.</p> <p>REQ Sets the MsgType field in the MQMD to MQMT_REQUEST.</p> <p>RLY Sets the MsgType field in the MQMD to MQMT_REPLY.</p> <p>RPT Sets the MsgType field in the MQMD to MQMT_REPORT.</p>
REPLY_TO_Q	<p>This column contains the name of the message queue to which the application that issued the MQGET call is to send reply and report messages.</p> <p>This column corresponds to the ReplyToQ field in the message descriptor (MQMD). MQ functions use the value in this column to set the ReplyToQ field.</p> <p>The default value for this column is SAME AS INPUT_Q, which sets the name to the queue name that is defined in the service that was used for sending the message. If no service was specified, the name is set to the name of the queue manager for the default service.</p>

Table 69. SYSIBM.MQPOLICY_TABLE column descriptions (continued)

Column name	Description
REPLY_TO_QMGR	<p>This column contains the name of the queue manager to which the reply and report messages are to be sent.</p> <p>This column corresponds to the ReplyToQMgr field in the message descriptor (MQMD). MQ functions use the value in this column to set the ReplyToQMgr field.</p> <p>The default value for this column is SAME AS INPUT_QMGR, which sets the name to the queue manager name that is defined in the service that was used for sending the message. If no service was specified, the name is set to the name of the queue manager for the default service.</p>
RCV_WAIT_INTERVAL	<p>This column contains the time, in milliseconds, that Db2 is to wait for messages to arrive in the queue.</p> <p>This column corresponds to the WaitInterval field in the get message options (MQGMO). MQ functions use the value in this column to set the WaitInterval field.</p> <p>The default is 10.</p>
RCV_CONVERT	<p>This column indicates whether to convert the application data in the message to conform to the CodedCharSetId and Encoding values that are defined in the service used for the function.</p> <p>This column corresponds to the Options field in the get message options (MQGMO). MQ functions use the value in this column to set the Options field.</p> <p>This column can have one of the following values:</p> <p>Y Sets the MQGMO_CONVERT option in the Options field in the MQGMO. This value is the default.</p> <p>N Specifies that no data is to be converted.</p>
RCV_ACCEPT_TRUNC_MSG	<p>This column specifies the behavior of the MQ function when oversized messages are retrieved.</p> <p>This column corresponds to the Options field in the get message options (MQGMO). MQ functions use the value in this column to set the Options field.</p> <p>This column can have one of the following values:</p> <p>Y Sets the MQGMO_ACCEPT_TRUNCATED_MSG option in the Options field in the MQGMO. This value is the default.</p> <p>N Specifies that no messages are to be truncated. If the message is too large to fit in the buffer, the MQ function terminates with an error.</p> <p>Recommendation: Set this column to Y. In this case, if the message buffer is too small to hold the complete message, the MQ function can fill the buffer with as much of the message as the buffer can hold.</p>

Table 69. SYSIBM.MQPOLICY_TABLE column descriptions (continued)

Column name	Description
REV_OPEN_SHARED	<p>This column specifies the input queue mode when messages are retrieved.</p> <p>This column corresponds to the Options parameter for an MQOPEN call. MQ functions use the value in this column to set the Options parameter.</p> <p>This column can have one of the following values:</p> <p>S Sets the MQOO_INPUT_SHARED option. This value is the default.</p> <p>E Sets the MQ option MQOO_INPUT_EXCLUSIVE option.</p> <p>D Sets the MQ option MQOO_INPUT_AS_Q_DEF option.</p>
SYNCPOINT	<p>This column indicates whether the MQ function is to operate within the protocol for a normal unit of work.</p> <p>This column can have one of the following values:</p> <p>Y Specifies that the MQ function is to operate within the protocol for a normal unit of work. Use this value if you want the MQ function to run under a transaction. This value is the default.</p> <p>N Specifies that the MQ function is to operate outside the protocol for a normal unit of work. Use this value if you do not want the MQ function to run under a transaction.</p>
DESCRIPTION	This column contains the long description of the policy.

Db2 MQ CCSID conversion

When a message is sent, the message sent may be converted to the job CCSID by Db2. When a message is read or received, it may be converted to a specified CCSID by Websphere MQ.

The *msg-data* parameter on the MQSEND function is defined to be in the job CCSID. If a string is passed for *msg-data*, it will be converted to the job CCSID. For example, if a string is passed for *msg-data* that has a CCSID 1200, it will be converted to the job CCSID before the message data is passed to Websphere MQ. If the string is defined to be bit data or the CCSID of the string is the job CCSID, no conversion will occur.

Websphere MQ does not perform CCSID conversions of the message data when MQSEND is executed. The message data passed from Db2 will be sent unchanged along with a CCSID which will inform the receiver of the message how to interpret the message data. The CCSID that is sent depends on the value specified for the CODEDCHARSETID of the service used on the MQSEND function. The default for CODEDCHARSETID is -3 which indicates that the CCSID passed will be the job default CCSID. If a value other than -3 is used for CODEDCHARSETID, the invoker must ensure that the message data passed to MQSEND will not get converted to the job CCSID by Db2 and that the string is encoded in that specified CCSID.

When a message is read or received by a Db2 MQ scalar or table function, the *msg-data* return parameter (and the MSG result column for the Db2 MQ table functions) are also defined to be in job default CCSID. Db2 does no conversions and relies on Websphere MQ to perform any necessary conversions. Whether Websphere will convert the message data can be controlled by setting the RCV_CONVERT value to 'N' in the specified policy.

If the specified service has a value for CODEDCHARSETID of -3, Db2 will instruct Websphere MQ to convert any message read or received into the job CCSID. If a value other than -3 is used for CODEDCHARSETID, Db2 will instruct Websphere MQ to convert any message read or received into that

CCSID. Specifying something other than -3 for CODEDCHARSETID in a service used to read or receive messages is not recommended since the *msg-data* return parameter and MSG result column are defined by Db2 to be in job default CCSID.

When reading or receiving a message, truncation may occur. If the specified policy has a value for RCV_ACCEPT_TRUNC_MSG of 'Y', the message may be truncated without any warning. If the value for RCV_ACCEPT_TRUNC_MSG is 'N' and the message is too long, the function ends with an error.

Websphere MQ transactions

Websphere MQ can send and receive messages as part of a transaction or outside a transaction. If a message is sent or received as part of a transaction, the transaction can include other resource such as Db2 operations.

Websphere MQ can serve as the transaction manager itself or participate as a resource manager to other transaction managers (such as CICS®, Encina, and Tuxedo). Detailed information on transactions and supported external transaction managers can be found in the Websphere MQSeries Information Center.

Websphere can also participate in transactions managed by IBM i commitment control. Commitment control is automatically started by Db2 when an SQL statement is executed and it is determined that commitment control is not yet started. By default, the commitment definition scope is *ACTGRP. In order for MQ functions and Db2 operations that occur in the same job to participate in the same transaction managed by IBM i commitment control, commitment control must be started with a scope of *JOB. For example, the following two CL commands end the current commitment definition and starts one with a scope of *JOB:

```
ENDCMTCTL
STRCMTCTL LCKLVL(*CHG) CMTSCOPE(*JOB)
```

In order to start commitment control with a scope of *JOB in a server job, the end and start commitment control CL commands must be performed together in a procedure. The following steps will create a sample procedure called START_JOB_LEVEL_COMMIT which can then be called with an SQL CALL statement :

1. Enter the following source in a source file member JOBSCOPE in MJASRC/CL:

```
PGM
ENDCMTCTL
STRCMTCTL LCKLVL(*CHG) CMTSCOPE(*JOB)
ENDPGM
```

2. Create the CL program using the following default MQ message queue manager:

```
CRTCLPGM PGM(MJATST/JOBSCOPE) SRCFILE(MJASRC/CL)
```

3. Create the SQL external procedure that references the CL program:

```
CREATE PROCEDURE MJATST.START_JOB_LEVEL_COMMIT ()
EXTERNAL NAME 'MJATST/JOBSCOPE'
PARAMETER STYLE GENERAL
```

The procedure can typically be called once in a job. Once the commitment definition with a *JOB scope is started, MQ operations and Db2 operations can be performed as part of a transaction. For example, the following INSERT statement and the MQSEND function will be performed under the same transaction. If the transaction is committed, both operations are committed. If the transaction is rolled back, both operations are rolled back.

```
CALL MJATST.START_JOB_LEVEL_COMMIT;
INSERT INTO MJATST.T1
VALUES(1);
VALUES MQSEND('A commit test message');
COMMIT;
```

```
INSERT INTO MJATST.T1
VALUES(2);
VALUES MQSEND('A rollback test message');
ROLLBACK;
```

WebSphere MQ can send and receive messages as part of a transaction or outside a transaction. In a Db2 MQ function this is controlled by the specified policy. Each policy has a SYNCPOINT attribute. If the SYNCPOINT column for a policy has a value of 'N', any Db2 MQ function that uses that policy will not participate in a transaction. If the SYNCPOINT column for a policy has a value of 'Y', any Db2 MQ function that uses that policy and changes the input queue will participate in a transaction.

Basic messaging with WebSphere MQ

The most basic form of messaging with the Db2 MQ functions occurs when all database applications connect to the same Db2 database server. Clients can be local to the database server or distributed in a network environment.

In a simple scenario, client A invokes the MQSEND function to send a user-defined string to the location that is defined by the default service. Db2 executes the MQ functions that perform this operation on the database server. At some later time, client B invokes the MQRECEIVE function to remove the message at the head of the queue that is defined by the default service, and return it to the client. Db2 executes the MQ functions that perform this operation on the database server.

Database clients can use simple messaging in a number of ways:

- Data collection

Information is received in the form of messages from one or more sources. An information source can be any application. The data is received from queues and stored in database tables for additional processing.

- Workload distribution

Work requests are posted to a queue that is shared by multiple instances of the same application. When an application instance is ready to perform some work, it receives a message that contains a work request from the head of the queue. Multiple instances of the application can share the workload that is represented by a single queue of pooled requests.

- Application signaling

In a situation where several processes collaborate, messages are often used to coordinate their efforts. These messages might contain commands or requests for work that is to be performed. For more information about this technique, see [“Application to application connectivity with WebSphere MQ” on page 366](#).

The following scenario extends basic messaging to incorporate remote messaging. Assume that machine A sends a message to machine B.

1. The Db2 client executes an MQSEND function call, specifying a target service that has been defined to be a remote queue on machine B.
2. The MQ functions perform the work to send the message. The WebSphere MQ server on machine A accepts the message and guarantees that it will deliver it to the destination that is defined by the service and the current MQ configuration of machine A. The server determines that the destination is a queue on machine B. The server then attempts to deliver the message to the WebSphere MQ server on machine B, retrying as needed.
3. The WebSphere MQ server on machine B accepts the message from the server on machine A and places it in the destination queue on machine B.
4. A WebSphere MQ client on machine B requests the message at the head of the queue.

If an error is returned from an MQI API, the specified Db2 MQ function will return an error. The error will contain the name of the MQ API that failed and the MQ condition code and MQ reason code. To determine the cause of the failure it is necessary to refer to the Websphere MQSeries Information Center.

For example, if a service contains the name of an MQSeries queue manager that does not exist, the following error is returned:

```
SQL State: 38401
Vendor Code: -443
Message: [SQL0443] cc=2:rc=2058:MQCONN FAILED
```

The message indicates that the MQCONN API failed for reason code 2058. The Websphere MQSeries Information Center contains the detailed description of reason code 2058.

Sending messages with WebSphere MQ

When you send messages with WebSphere MQ, you choose what data to send, where to send it and when to send it. This type of messaging is called send and forget; the sender sends a message and relies on WebSphere MQ to ensure that the message reaches its destination.

To send messages with WebSphere MQ, use MQSEND. If you send more than one column of information, separate the columns with a blank character. For example:

```
VALUES MQSEND(LASTNAME CONCAT ' ' CONCAT FIRSTNAME);
```

The following example uses the default service DB2.DEFAULT.SERVICE and the default policy DB2.DEFAULT.POLICY which has a SYNCPOINT value of 'Y'. Because this MQSEND function runs under a transaction, the COMMIT statement ensures that the message is added to the queue.

```
VALUES MQSEND('Testing msg');
COMMIT;
```

When you use a policy that contains a SYNCPOINT value of 'N', you do not need to use a COMMIT statement. For example, assume that policy MYPOLICY2 has a SYNCPOINT value of 'N'. The following SQL statement causes the message to be added to the queue without the need for a COMMIT statement.

```
VALUES MQSEND('DB2.DEFAULT.SERVICE', 'MYPOLICY2', 'Testing msg')
```

Message content can be any combination of SQL statements, expressions, functions, and user-specified data. Assume that you have an EMPLOYEE table, with VARCHAR columns LASTNAME, FIRSTNAME, and DEPARTMENT. To send a message that contains this information for each employee in DEPARTMENT 5LGA, issue the following SQL SELECT statement:

```
SELECT MQSEND(LASTNAME CONCAT ' ' CONCAT FIRSTNAME CONCAT ' ' CONCAT DEPARTMENT)
FROM EMPLOYEE
WHERE DEPARTMENT = '5LGA';
COMMIT;
```

Retrieving messages with WebSphere MQ

With WebSphere MQ, programs can read or receive messages. Both reading and receiving operations return the message at the head of the queue. However, the reading operation does not remove the message from the queue, whereas the receiving operation does.

A message that is retrieved using a receive operation can be retrieved only once, whereas a message that is retrieved using a read operation allows the same message to be retrieved many times.

The following SQL statement reads the message at the head of the queue that is specified by the default service and policy. The SQL statement returns a VARCHAR(32000) string. If no messages are available to be read, a null value is returned. Because MQREAD does not change the queue, you do not need to use a COMMIT statement.

VALUES MQREAD()

The following SQL statement causes the contents of a queue to be returned as a result set. The result table T of the table function consists of all the messages in the queue, which is defined by the default service, and the metadata about those messages. The first column of the materialized result table is the message itself, and the remaining columns contain the metadata. The SELECT statement returns both the messages and the metadata.

```
SELECT T.*
FROM TABLE ( MQREADALL() ) AS T;
```

The following statement only returns the messages. The result table T of the table function consists of all the messages in the queue, which is defined by the default service, and the metadata about those messages.

```
SELECT T.MSG
FROM TABLE ( MQREADALL() ) AS T;
```

The following SQL statement receives (removes) the message at the head of the queue. The SELECT statement returns a VARCHAR(32000) string. Because this MQRECEIVE function runs under a transaction, the COMMIT statement ensures that the message is removed from the queue. If no messages are available to be retrieved, a null value is returned, and the queue does not change.

```
VALUES MQRECEIVE()
COMMIT;
```

Assume that you have a MESSAGES table with a single VARCHAR(32000) column. The following SQL INSERT statement inserts all of the messages from the default service queue into the MESSAGES table:

```
INSERT INTO MESSAGES
SELECT T.MSG
FROM TABLE ( MQRECEIVEALL() ) AS T;
COMMIT;
```

Application to application connectivity with WebSphere MQ

Application-to-application connectivity is typically used when putting together a diverse set of application subsystems. To facilitate application integration, WebSphere MQ provides the means to interconnect applications.

The *request-and-reply* communication method enables one application to request the services of another application. One way to do this is for the requester to send a message to the service provider to request that some work be performed. When the work has been completed, the provider might decide to send results, or just a confirmation of completion, back to the requester. Unless the requester waits for a reply before continuing, WebSphere MQ must provide a way to associate the reply with its request.

WebSphere MQ provides a correlation identifier to correlate messages in an exchange between a requester and a provider. The requester marks a message with a known correlation identifier. The provider marks its reply with the same correlation identifier. To retrieve the associated reply, the requester provides that correlation identifier when receiving messages from the queue. The first message with a matching correlation identifier is returned to the requester.

The following SQL SELECT statement sends a message consisting of the string "Msg with corr id" to the service MYSERVICE, using the policy MYPOLICY with correlation identifier CORRID1. Because the policy

MYPOLICY has the SYNCPOINT attribute of 'N', WebSphere MQ adds the message to the queue, and you do not need to use a COMMIT statement.

```
VALUES MQSEND('MYSERVICE', 'MYPOLICY', 'Msg with corr id', 'CORRID1')
```

The following SQL statement receives the first message that matches the identifier CORRID1 from the queue that is specified by the service MYSERVICE, using the policy MYPOLICY. The SQL statement returns a VARCHAR(32000) string. If no messages are available with this correlation identifier, a null value is returned, and the queue does not change.

```
VALUES MQRECEIVE('MYSERVICE', 'MYPOLICY', 'CORRID1')
```

Db2 for i sample tables

These sample tables are referred to and used in the SQL programming and the SQL reference topic collections.

One set of tables contain basic data types and table constructs. A second set of tables provide data containing XML values.

Sample tables

This group of tables includes information that describes employees, departments, projects, and activities. This information forms a sample application that demonstrates some of the features of SQL. All examples assume that the tables are in a schema named CORPDATA (for corporate data).

A stored procedure is included as part of the system that contains the data definition language (DDL) statements to create all of these tables and the INSERT statements to populate them. The procedure creates the schema specified on the call to the procedure. Because this is an external stored procedure, it can be called from any SQL interface, including interactive SQL and IBM i Access Client Solutions (ACS). To call the procedure where SAMPLE is the schema that you want to create, issue the following statement:

```
CALL QSYS.CREATE_SQL_SAMPLE ('SAMPLE')
```

The schema name must be specified in uppercase. The schema must not already exist.

Note: In the sample table data descriptions, a question mark (?) indicates a null value.

Department table (DEPARTMENT)

The department table describes each department in the enterprise and identifies its manager and the department that it reports to.

The department table is created with the following CREATE TABLE and ALTER TABLE statements:

```
CREATE TABLE DEPARTMENT
  (DEPTNO    CHAR(3)          NOT NULL,
   DEPTNAME  VARCHAR(36)     NOT NULL,
   MGRNO     CHAR(6)          NOT NULL,
   ADMRDEPT  CHAR(3)          NOT NULL,
   LOCATION  CHAR(16)        NOT NULL,
   PRIMARY KEY (DEPTNO))

ALTER TABLE DEPARTMENT
  ADD FOREIGN KEY ROD (ADMRDEPT)
  REFERENCES DEPARTMENT
  ON DELETE CASCADE
```

The following foreign key is added later.

```
ALTER TABLE DEPARTMENT
  ADD FOREIGN KEY RDE (MGRNO)
```

**REFERENCES EMPLOYEE
ON DELETE SET NULL**

The following indexes are created.

```
CREATE UNIQUE INDEX XDEPT1
ON DEPARTMENT (DEPTNO)

CREATE INDEX XDEPT2
ON DEPARTMENT (MGRNO)

CREATE INDEX XDEPT3
ON DEPARTMENT (ADMRDEPT)
```

The following alias is created for the table.

```
CREATE ALIAS DEPT FOR DEPARTMENT
```

The following table shows the content of the columns.

Table 70. Columns of the department table

Column name	Description
DEPTNO	Department number or ID.
DEPTNAME	A name describing the general activities of the department.
MGRNO	Employee number (EMPNO) of the department manager.
ADMRDEPT	The department (DEPTNO) to which this department reports; the department at the highest level reports to itself.
LOCATION	Location of the department.

DEPARTMENT

Here is a complete listing of the data in the DEPARTMENT table.

DEPTNO	DEPTNAME	MGRNO	ADMRDEPT	LOCATION
A00	SPIFFY COMPUTER SERVICE DIV.	000010	A00	?
B01	PLANNING	000020	A00	?
C01	INFORMATION CENTER	000030	A00	?
D01	DEVELOPMENT CENTER	?	A00	?
D11	MANUFACTURING SYSTEMS	000060	D01	?
D21	ADMINISTRATION SYSTEMS	000070	D01	?
E01	SUPPORT SERVICES	000050	A00	?
E11	OPERATIONS	000090	E01	?
E21	SOFTWARE SUPPORT	000100	E01	?
F22	BRANCH OFFICE F2	?	E01	?
G22	BRANCH OFFICE G2	?	E01	?
H22	BRANCH OFFICE H2	?	E01	?
I22	BRANCH OFFICE I2	?	E01	?
J22	BRANCH OFFICE J2	?	E01	?

Employee table (EMPLOYEE)

The employee table identifies every employee by an employee number and lists basic personnel information.

The employee table is created with the following CREATE TABLE and ALTER TABLE statements:

```
CREATE TABLE EMPLOYEE
(EMPNO      CHAR(6)      NOT NULL,
 FIRSTNME   VARCHAR(12)   NOT NULL,
 MIDINIT    CHAR(1)     NOT NULL,
 LASTNAME   VARCHAR(15)  NOT NULL,
 WORKDEPT   CHAR(3)     ,
 PHONENO    CHAR(4)     ,
 HIREDATE   DATE        ,
 JOB        CHAR(8)     ,
 EDLEVEL    SMALLINT   NOT NULL,
 SEX        CHAR(1)     ,
 BIRTHDATE  DATE        ,
 SALARY     DECIMAL(9,2) ,
 BONUS      DECIMAL(9,2) ,
 COMM       DECIMAL(9,2) ,
 PRIMARY KEY (EMPNO))

ALTER TABLE EMPLOYEE
ADD FOREIGN KEY RED (WORKDEPT)
REFERENCES DEPARTMENT
ON DELETE SET NULL

ALTER TABLE EMPLOYEE
ADD CONSTRAINT NUMBER
CHECK (PHONENO >= '0000' AND PHONENO <= '9999')
```

The following indexes are created:

```
CREATE UNIQUE INDEX XEMP1
ON EMPLOYEE (EMPNO)

CREATE INDEX XEMP2
ON EMPLOYEE (WORKDEPT)
```

The following alias is created for the table:

```
CREATE ALIAS EMP FOR EMPLOYEE
```

The table below shows the content of the columns.

Column name	Description
EMPNO	Employee number
FIRSTNME	First name of employee
MIDINIT	Middle initial of employee
LASTNAME	Family name of employee
WORKDEPT	ID of department in which the employee works
PHONENO	Employee telephone number
HIREDATE	Date of hire
JOB	Job held by the employee
EDLEVEL	Number of years of formal education
SEX	Sex of the employee (M or F)
BIRTHDATE	Date of birth
SALARY	Yearly salary in dollars

Column name	Description
BONUS	Yearly bonus in dollars
COMM	Yearly commission in dollars

EMPLOYEE

Here is a complete listing of the data in the EMPLOYEE table.

EMP NO COMM	FIRST NAME	MID INIT	LASTNAME	WORK DEPT	PHONE NO	HIRE DATE	JOB	ED LEVEL	SEX	BIRTH DATE	SAL - ARY	BONUS
000010 4220	CHRISTINE	I	HAAS	A00	3978	1965-01-01	PRES	18	F	1933-08-24	52750	1000
000020 3300	MICHAEL	L	THOMPSON	B01	3476	1973-10-10	MANAGER	18	M	1948-02-02	41250	800
000030 3060	SALLY	A	KWAN	C01	4738	1975-04-05	MANAGER	20	F	1941-05-11	38250	800
000050 3214	JOHN	B	GEYER	E01	6789	1949-08-17	MANAGER	16	M	1925-09-15	40175	800
000060 2580	IRVING	F	STERN	D11	6423	1973-09-14	MANAGER	16	M	1945-07-07	32250	500
000070 2893	EVA	D	PULASKI	D21	7831	1980-09-30	MANAGER	16	F	1953-05-26	36170	700
000090 2380	EILEEN	W	HENDERSON	E11	5498	1970-08-15	MANAGER	16	F	1941-05-15	29750	600
000100 2092	THEODORE	Q	SPENSER	E21	0972	1980-06-19	MANAGER	14	M	1956-12-18	26150	500
000110 3720	VINCENZO	G	LUCCHESSI	A00	3490	1958-05-16	SALESREP	19	M	1929-11-05	46500	900
000120 2340	SEAN		O'CONNELL	A00	2167	1963-12-05	CLERK	14	M	1942-10-18	29250	600
000130 1904	DOLORES	M	QUINTANA	C01	4578	1971-07-28	ANALYST	16	F	1925-09-15	23800	500
000140 2274	HEATHER	A	NICHOLLS	C01	1793	1976-12-15	ANALYST	18	F	1946-01-19	28420	600
000150 2022	BRUCE		ADAMSON	D11	4510	1972-02-12	DESIGNER	16	M	1947-05-17	25280	500
000160 1780	ELIZABETH	R	PIANKA	D11	3782	1977-10-11	DESIGNER	17	F	1955-04-12	22250	400
000170 1974	MASATOSHI	J	YOSHIMURA	D11	2890	1978-09-15	DESIGNER	16	M	1951-01-05	24680	500
000180 1707	MARILYN	S	SCOUTTEN	D11	1682	1973-07-07	DESIGNER	17	F	1949-02-21	21340	500
000190 1636	JAMES	H	WALKER	D11	2986	1974-07-26	DESIGNER	16	M	1952-06-25	20450	400
000200 2217	DAVID		BROWN	D11	4501	1966-03-03	DESIGNER	16	M	1941-05-29	27740	600
000210 1462	WILLIAM	T	JONES	D11	0942	1979-04-11	DESIGNER	17	M	1953-02-23	18270	400
000220 2387	JENNIFER	K	LUTZ	D11	0672	1968-08-29	DESIGNER	18	F	1948-03-19	29840	600
000230 1774	JAMES	J	JEFFERSON	D21	2094	1966-11-21	CLERK	14	M	1935-05-30	22180	400
000240 2301	SALVATORE	M	MARINO	D21	3780	1979-12-05	CLERK	17	M	1954-03-31	28760	600
000250 1534	DANIEL	S	SMITH	D21	0961	1969-10-30	CLERK	15	M	1939-11-12	19180	400
000260 1380	SYBIL	P	JOHNSON	D21	8953	1975-09-11	CLERK	16	F	1936-10-05	17250	300
000270 2190	MARIA	L	PEREZ	D21	9001	1980-09-30	CLERK	15	F	1953-05-26	27380	500
000280 2100	ETHEL	R	SCHNEIDER	E11	8997	1967-03-24	OPERATOR	17	F	1936-03-28	26250	500
000290 1227	JOHN	R	PARKER	E11	4502	1980-05-30	OPERATOR	12	M	1946-07-09	15340	300
000300 1420	PHILIP	X	SMITH	E11	2095	1972-06-19	OPERATOR	14	M	1936-10-27	17750	400
000310 1272	MAUDE	F	SETRIGHT	E11	3332	1964-09-12	OPERATOR	12	F	1931-04-21	15900	300
000320 1596	RAMLAL	V	MEHTA	E21	9990	1965-07-07	FILEREP	16	M	1932-08-11	19950	400
000330 2030	WING		LEE	E21	2103	1976-02-23	FILEREP	14	M	1941-07-18	25370	500
000340 1907	JASON	R	GOUNOT	E21	5698	1947-05-05	FILEREP	16	M	1926-05-17	23840	500
200010 4220	DIAN	J	HEMMINGER	A00	3978	1965-01-01	SALESREP	18	F	1933-08-14	46500	1000
200120 2340	GREG		ORLANDO	A00	2167	1972-05-05	CLERK	14	M	1942-10-18	29250	600
200140 2274	KIM	N	NATZ	C01	1793	1976-12-15	ANALYST	18	F	1946-01-19	28420	600
200170 1974	KIYOSHI		YAMAMOTO	D11	2890	1978-09-15	DESIGNER	16	M	1951-01-05	24680	500
200220 2387	REBA	K	JOHN	D11	0672	1968-08-29	DESIGNER	18	F	1948-03-19	29840	600
200240 2301	ROBERT	M	MONTEVERDE	D21	3780	1979-12-05	CLERK	17	M	1954-03-31	28760	600
200280 2100	EILEEN	R	SCHWARTZ	E11	8997	1967-03-24	OPERATOR	17	F	1936-03-28	26250	500
200310 1272	MICHELLE	F	SPRINGER	E11	3332	1964-09-12	OPERATOR	12	F	1931-04-21	15900	300
200330 2030	HELENA		WONG	E21	2103	1976-02-23	FIELDREP	14	F	1941-07-18	25370	500
200340 1907	ROY	R	ALONZO	E21	5698	1947-05-05	FIELDREP	16	M	1926-05-17	23840	500

Employee photo table (EMP_PHOTO)

The employee photo table contains a photo of each employee identified by an employee number.

The employee photo table is created with the following CREATE TABLE and ALTER TABLE statements:

```
CREATE TABLE EMP_PHOTO
  (EMPNO CHAR(6) NOT NULL,
   PHOTO_FORMAT VARCHAR(10) NOT NULL,
   PICTURE BLOB(100K),
   EMP_ROWID CHAR(40) NOT NULL DEFAULT '',
   PRIMARY KEY (EMPNO,PHOTO_FORMAT))

ALTER TABLE EMP_PHOTO
  ADD COLUMN DL_PICTURE DATALINK(1000)
  LINKTYPE URL NO LINK CONTROL

ALTER TABLE EMP_PHOTO
  ADD FOREIGN KEY (EMPNO)
  REFERENCES EMPLOYEE
  ON DELETE RESTRICT
```

The following index is created:

```
CREATE UNIQUE INDEX XEMP_PHOTO
  ON EMP_PHOTO (EMPNO,PHOTO_FORMAT)
```

The table below shows the content of the columns.

Column name	Description
EMPNO	Employee number
PHOTO_FORMAT	Format of image stored in PICTURE
PICTURE	Photo image
EMP_ROWID	Unique row ID, not currently used

EMP_PHOTO

Here is a complete listing of the data in the EMP_PHOTO table.

EMPNO	PHOTO_FORMAT	PICTURE	EMP_ROWID
000130	bitmap	?	
000130	gif	?	
000140	bitmap	?	
000140	gif	?	
000150	bitmap	?	
000150	gif	?	
000190	bitmap	?	
000190	gif	?	

Employee resumé table (EMP_RESUME)

The employee resumé table contains a resumé for each employee identified by an employee number.

The employee resumé table is created with the following CREATE TABLE and ALTER TABLE statements:

```
CREATE TABLE EMP_RESUME
  (EMPNO CHAR(6) NOT NULL,
   RESUME_FORMAT VARCHAR(10) NOT NULL,
   RESUME CLOB(5K),
   EMP_ROWID CHAR(40) NOT NULL DEFAULT '',
```



```

PRIMARY KEY (EMPNO, RESUME_FORMAT))

ALTER TABLE EMP_RESUME
ADD COLUMN DL_RESUME DATALINK(1000)
LINKTYPE URL NO LINK CONTROL

ALTER TABLE EMP_RESUME
ADD FOREIGN KEY (EMPNO)
REFERENCES EMPLOYEE
ON DELETE RESTRICT

```

The following index is created:

```

CREATE UNIQUE INDEX XEMP_RESUME
ON EMP_RESUME (EMPNO, RESUME_FORMAT)

```

The table below shows the content of the columns.

Column name	Description
EMPNO	Employee number
RESUME_FORMAT	Format of text stored in RESUME
RESUME	Resumé
EMP_ROWID	Unique row id, not currently used

EMP_RESUME

Here is a complete listing of the data in the EMP_RESUME table.

EMPNO	RESUME_FORMAT	RESUME	EMP_ROWID
000130	ascii	?	
000130	html	?	
000140	ascii	?	
000140	html	?	
000150	ascii	?	
000150	html	?	
000190	ascii	?	
000190	html	?	

Employee to project activity table (EMPPROJECT)

The employee to project activity table identifies the employee who participates in each activity listed for each project. The employee's level of involvement (full-time or part-time) and the activity schedule are also included in the table.

The employee to project activity table is created with the following CREATE TABLE and ALTER TABLE statements:

```

CREATE TABLE EMPPROJECT
(EMPNO CHAR(6) NOT NULL,
PROJNO CHAR(6) NOT NULL,
ACTNO SMALLINT NOT NULL,
EMPTIME DECIMAL(5,2) ,
EMSTDATE DATE ,
EMENDATE DATE )

ALTER TABLE EMPPROJECT
ADD FOREIGN KEY REPAPA (PROJNO, ACTNO, EMSTDATE)
REFERENCES PROJECT
ON DELETE RESTRICT

```

The following aliases are created for the table:

```
CREATE ALIAS EMPACT FOR EMPPROJACT
CREATE ALIAS EMP_ACT FOR EMPPROJACT
```

The table below shows the content of the columns.

Table 71. Columns of the Employee to project activity table

Column name	Description
EMPNO	Employee ID number
PROJNO	PROJNO of the project to which the employee is assigned
ACTNO	ID of an activity within a project to which an employee is assigned
EMPTIME	A proportion of the employee's full time (between 0.00 and 1.00) to be spent on the project from EMSTDATE to EMENDATE
EMSTDATE	Start date of the activity
EMENDATE	Completion date of the activity

EMPPROJACT

Here is a complete listing of the data in the EMPPROJACT table.

EMPNO	PROJNO	ACTNO	EMPTIME	EMSTDATE	EMENDATE
000010	AD3100	10	.50	1982-01-01	1982-07-01
000070	AD3110	10	1.00	1982-01-01	1983-02-01
000230	AD3111	60	1.00	1982-01-01	1982-03-15
000230	AD3111	60	.50	1982-03-15	1982-04-15
000230	AD3111	70	.50	1982-03-15	1982-10-15
000230	AD3111	80	.50	1982-04-15	1982-10-15
000230	AD3111	180	.50	1982-10-15	1983-01-01
000240	AD3111	70	1.00	1982-02-15	1982-09-15
000240	AD3111	80	1.00	1982-09-15	1983-01-01
000250	AD3112	60	1.00	1982-01-01	1982-02-01
000250	AD3112	60	.50	1982-02-01	1982-03-15
000250	AD3112	60	1.00	1983-01-01	1983-02-01
000250	AD3112	70	.50	1982-02-01	1982-03-15
000250	AD3112	70	1.00	1982-03-15	1982-08-15
000250	AD3112	70	.25	1982-08-15	1982-10-15
000250	AD3112	80	.25	1982-08-15	1982-10-15
000250	AD3112	80	.50	1982-10-15	1982-12-01
000250	AD3112	180	.50	1982-08-15	1983-01-01
000260	AD3113	70	.50	1982-06-15	1982-07-01
000260	AD3113	70	1.00	1982-07-01	1983-02-01

EMPNO	PROJNO	ACTNO	EMPTIME	EMSTDATE	EMENDATE
000260	AD3113	80	1.00	1982-01-01	1982-03-01
000260	AD3113	80	.50	1982-03-01	1982-04-15
000260	AD3113	180	.50	1982-03-01	1982-04-15
000260	AD3113	180	1.00	1982-04-15	1982-06-01
000260	AD3113	180	1.00	1982-06-01	1982-07-01
000270	AD3113	60	.50	1982-03-01	1982-04-01
000270	AD3113	60	1.00	1982-04-01	1982-09-01
000270	AD3113	60	.25	1982-09-01	1982-10-15
000270	AD3113	70	.75	1982-09-01	1982-10-15
000270	AD3113	70	1.00	1982-10-15	1983-02-01
000270	AD3113	80	1.00	1982-01-01	1982-03-01
000270	AD3113	80	.50	1982-03-01	1982-04-01
000030	IF1000	10	.50	1982-06-01	1983-01-01
000130	IF1000	90	1.00	1982-10-01	1983-01-01
000130	IF1000	100	.50	1982-10-01	1983-01-01
000140	IF1000	90	.50	1982-10-01	1983-01-01
000030	IF2000	10	.50	1982-01-01	1983-01-01
000140	IF2000	100	1.00	1982-01-01	1982-03-01
000140	IF2000	100	.50	1982-03-01	1982-07-01
000140	IF2000	110	.50	1982-03-01	1982-07-01
000140	IF2000	110	.50	1982-10-01	1983-01-01
000010	MA2100	10	.50	1982-01-01	1982-11-01
000110	MA2100	20	1.00	1982-01-01	1983-03-01
000010	MA2110	10	1.00	1982-01-01	1983-02-01
000200	MA2111	50	1.00	1982-01-01	1982-06-15
000200	MA2111	60	1.00	1982-06-15	1983-02-01
000220	MA2111	40	1.00	1982-01-01	1983-02-01
000150	MA2112	60	1.00	1982-01-01	1982-07-15
000150	MA2112	180	1.00	1982-07-15	1983-02-01
000170	MA2112	60	1.00	1982-01-01	1983-06-01
000170	MA2112	70	1.00	1982-06-01	1983-02-01
000190	MA2112	70	1.00	1982-01-01	1982-10-01
000190	MA2112	80	1.00	1982-10-01	1983-10-01
000160	MA2113	60	1.00	1982-07-15	1983-02-01
000170	MA2113	80	1.00	1982-01-01	1983-02-01

EMPNO	PROJNO	ACTNO	EMPTIME	EMSTDATE	EMENDATE
000180	MA2113	70	1.00	1982-04-01	1982-06-15
000210	MA2113	80	.50	1982-10-01	1983-02-01
000210	MA2113	180	.50	1982-10-01	1983-02-01
000050	OP1000	10	.25	1982-01-01	1983-02-01
000090	OP1010	10	1.00	1982-01-01	1983-02-01
000280	OP1010	130	1.00	1982-01-01	1983-02-01
000290	OP1010	130	1.00	1982-01-01	1983-02-01
000300	OP1010	130	1.00	1982-01-01	1983-02-01
000310	OP1010	130	1.00	1982-01-01	1983-02-01
000050	OP2010	10	.75	1982-01-01	1983-02-01
000100	OP2010	10	1.00	1982-01-01	1983-02-01
000320	OP2011	140	.75	1982-01-01	1983-02-01
000320	OP2011	150	.25	1982-01-01	1983-02-01
000330	OP2012	140	.25	1982-01-01	1983-02-01
000330	OP2012	160	.75	1982-01-01	1983-02-01
000340	OP2013	140	.50	1982-01-01	1983-02-01
000340	OP2013	170	.50	1982-01-01	1983-02-01
000020	PL2100	30	1.00	1982-01-01	1982-09-15

Project table (PROJECT)

The project table describes each project that the business is currently undertaking. Data contained in each row include the project number, name, person responsible, and schedule dates.

The project table is created with the following CREATE TABLE and ALTER TABLE statements:

```

CREATE TABLE PROJECT
  (PROJNO CHAR(6) NOT NULL,
   PROJNAME VARCHAR(24) NOT NULL DEFAULT,
   DEPTNO CHAR(3) NOT NULL,
   RESPEMP CHAR(6) NOT NULL,
   PRSTAFF DECIMAL(5,2) ,
   PRSTDATE DATE ,
   PRENDATE DATE ,
   MAJPROJ CHAR(6) ,
   PRIMARY KEY (PROJNO))

ALTER TABLE PROJECT
  ADD FOREIGN KEY (DEPTNO)
  REFERENCES DEPARTMENT
  ON DELETE RESTRICT

ALTER TABLE PROJECT
  ADD FOREIGN KEY (RESPEMP)
  REFERENCES EMPLOYEE
  ON DELETE RESTRICT

ALTER TABLE PROJECT
  ADD FOREIGN KEY RPP (MAJPROJ)
  REFERENCES PROJECT
  ON DELETE CASCADE

```

The following indexes are created:

```
CREATE UNIQUE INDEX XPROJ1
ON PROJECT (PROJNO)

CREATE INDEX XPROJ2
ON PROJECT (RESPEMP)
```

The following alias is created for the table:

```
CREATE ALIAS PROJ FOR PROJECT
```

The table below shows the contents of the columns:

Column name	Description
PROJNO	Project number
PROJNAME	Project name
DEPTNO	Department number of the department responsible for the project
RESPEMP	Employee number of the person responsible for the project
PRSTAFF	Estimated mean staffing
PRSTDATE	Estimated start date of the project
PRENDATE	Estimated end date of the project
MAJPROJ	Controlling project number for sub projects

PROJECT

Here is a complete listing of the data in the PROJECT table.

PROJNO	PROJNAME	DEPTNO	RESPEMP	PRSTAFF	PRSTDATE	PRENDATE	MAJPROJ
AD3100	ADMIN SERVICES	D01	000010	6.5	1982-01-01	1983-02-01	?
AD3110	GENERAL ADMIN SYSTEMS	D21	000070	6	1982-01-01	1983-02-01	AD3100
AD3111	PAYROLL PROGRAMMING	D21	000230	2	1982-01-01	1983-02-01	AD3110
AD3112	PERSONNEL PROGRAMMING	D21	000250	1	1982-01-01	1983-02-01	AD3110
AD3113	ACCOUNT PROGRAMMING	D21	000270	2	1982-01-01	1983-02-01	AD3110
IF1000	QUERY SERVICES	C01	000030	2	1982-01-01	1983-02-01	?
IF2000	USER EDUCATION	C01	000030	1	1982-01-01	1983-02-01	?
MA2100	WELD LINE AUTOMATION	D01	000010	12	1982-01-01	1983-02-01	?
MA2110	W L PROGRAMMING	D11	000060	9	1982-01-01	1983-02-01	MA2100
MA2111	W L PROGRAM DESIGN	D11	000220	2	1982-01-01	1982-12-01	MA2110

PROJNO	PROJNAME	DEPTNO	RESPEMP	PRSTAFF	PRSTDATE	PRENDATE	MAJPROJ
MA2112	W L ROBOT DESIGN	D11	000150	3	1982-01-0 1	1982-12-01	MA2110
MA2113	W L PROD CONT PROGS	D11	000160	3	1982-02-1 5	1982-12-01	MA2110
OP1000	OPERATION SUPPORT	E01	000050	6	1982-01-0 1	1983-02-01	?
OP1010	OPERATION	E11	000090	5	1982-01-0 1	1983-02-01	OP1000
OP2000	GEN SYSTEMS SERVICES	E01	000050	5	1982-01-0 1	1983-02-01	?
OP2010	SYSTEMS SUPPORT	E21	000100	4	1982-01-0 1	1983-02-01	OP2000
OP2011	SCP SYSTEMS SUPPORT	E21	000320	1	1982-01-0 1	1983-02-01	OP2010
OP2012	APPLICATIONS SUPPORT	E21	000330	1	1982-01-0 1	1983-02-01	OP2010
OP2013	DB/DC SUPPORT	E21	000340	1	1982-01-0 1	1983-02-01	OP2010
PL2100	WELD LINE PLANNING	B01	000020	1	1982-01-0 1	1982-09-15	MA2100

Project activity table (PROJECT)

The project activity table describes each project activity that the business is currently undertaking. Data contained in each row includes the project number, activity number, and schedule dates.

The project activity table is created with the following CREATE TABLE and ALTER TABLE statements:

```
CREATE TABLE PROJECT
(PROJNO CHAR(6) NOT NULL,
ACTNO SMALLINT NOT NULL,
ACSTAFF DECIMAL(5,2),
ACSTDATE DATE NOT NULL,
ACENDATE DATE,
PRIMARY KEY (PROJNO, ACTNO, ACSTDATE))
```

```
ALTER TABLE PROJECT
ADD FOREIGN KEY RPAP (PROJNO)
REFERENCES PROJECT
ON DELETE RESTRICT
```

The following foreign key is added later:

```
ALTER TABLE PROJECT
ADD FOREIGN KEY RPAA (ACTNO)
REFERENCES ACT
ON DELETE RESTRICT
```

The following index is created:

```
CREATE UNIQUE INDEX XPROJAC1
ON PROJECT (PROJNO, ACTNO, ACSTDATE)
```

The table below shows the contents of the columns:

Column name	Description
PROJNO	Project number
ACTNO	Activity number
ACSTAFF	Estimated mean staffing
ACSTDATE	Activity start date
ACENDATE	Activity end date

PROJACT

Here is a complete listing of the data in the PROJACT table.

PROJNO	ACTNO	ACSTAFF	ACSTDATE	ACENDATE
AD3100	10	?	1982-01-01	?
AD3110	10	?	1982-01-01	?
AD3111	60	?	1982-01-01	?
AD3111	60	?	1982-03-15	?
AD3111	70	?	1982-03-15	?
AD3111	80	?	1982-04-15	?
AD3111	180	?	1982-10-15	?
AD3111	70	?	1982-02-15	?
AD3111	80	?	1982-09-15	?
AD3112	60	?	1982-01-01	?
AD3112	60	?	1982-02-01	?
AD3112	60	?	1983-01-01	?
AD3112	70	?	1982-02-01	?
AD3112	70	?	1982-03-15	?
AD3112	70	?	1982-08-15	?
AD3112	80	?	1982-08-15	?
AD3112	80	?	1982-10-15	?
AD3112	180	?	1982-08-15	?
AD3113	70	?	1982-06-15	?
AD3113	70	?	1982-07-01	?
AD3113	80	?	1982-01-01	?
AD3113	80	?	1982-03-01	?
AD3113	180	?	1982-03-01	?
AD3113	180	?	1982-04-15	?
AD3113	180	?	1982-06-01	?
AD3113	60	?	1982-03-01	?
AD3113	60	?	1982-04-01	?

PROJNO	ACTNO	ACSTAFF	ACSTDATE	ACENDATE
AD3113	60	?	1982-09-01	?
AD3113	70	?	1982-09-01	?
AD3113	70	?	1982-10-15	?
IF1000	10	?	1982-06-01	?
IF1000	90	?	1982-10-01	?
IF1000	100	?	1982-10-01	?
IF2000	10	?	1982-01-01	?
IF2000	100	?	1982-01-01	?
IF2000	100	?	1982-03-01	?
IF2000	110	?	1982-03-01	?
IF2000	110	?	1982-10-01	?
MA2100	10	?	1982-01-01	?
MA2100	20	?	1982-01-01	?
MA2110	10	?	1982-01-01	?
MA2111	50	?	1982-01-01	?
MA2111	60	?	1982-06-15	?
MA2111	40	?	1982-01-01	?
MA2112	60	?	1982-01-01	?
MA2112	180	?	1982-07-15	?
MA2112	70	?	1982-06-01	?
MA2112	70	?	1982-01-01	?
MA2112	80	?	1982-10-01	?
MA2113	60	?	1982-07-15	?
MA2113	80	?	1982-01-01	?
MA2113	70	?	1982-04-01	?
MA2113	80	?	1982-10-01	?
MA2113	180	?	1982-10-01	?
OP1000	10	?	1982-01-01	?
OP1010	10	?	1982-01-01	?
OP1010	130	?	1982-01-01	?
OP2010	10	?	1982-01-01	?
OP2011	140	?	1982-01-01	?
OP2011	150	?	1982-01-01	?
OP2012	140	?	1982-01-01	?
OP2012	160	?	1982-01-01	?

PROJNO	ACTNO	ACSTAFF	ACSTDATE	ACENDATE
OP2013	140	?	1982-01-01	?
OP2013	170	?	1982-01-01	?
PL2100	30	?	1982-01-01	?

Activity table (ACT)

The activity table describes each activity.

The activity table is created with the following CREATE TABLE statement:

```
CREATE TABLE ACT
  (ACTNO SMALLINT NOT NULL,
   ACTKWD CHAR(6) NOT NULL,
   ACTDESC VARCHAR(20) NOT NULL,
   PRIMARY KEY (ACTNO))
```

The following indexes are created:

```
CREATE UNIQUE INDEX XACT1
  ON ACT (ACTNO)

CREATE UNIQUE INDEX XACT2
  ON ACT (ACTKWD)
```

The table below shows the contents of the columns.

Column name	Description
ACTNO	Activity number
ACTKWD	Keyword for activity
ACTDESC	Description of activity

ACT

Here is a complete listing of the data in the ACT table.

ACTNO	ACTKWD	ACTDESC
10	MANAGE	MANAGE/ADVISE
20	ECOST	ESTIMATE COST
30	DEFINE	DEFINE SPECS
40	LEADPR	LEAD PROGRAM/DESIGN
50	SPECS	WRITE SPECS
60	LOGIC	DESCRIBE LOGIC
70	CODE	CODE PROGRAMS
80	TEST	TEST PROGRAMS
90	ADMQS	ADM QUERY SYSTEM
100	TEACH	TEACH CLASSES
110	COURSE	DEVELOP COURSES
120	STAFF	PERS AND STAFFING
130	OPERAT	OPER COMPUTER SYS

ACTNO	ACTKWD	ACTDESC
140	MAINT	MAINT SOFTWARE SYS
150	ADMSYS	ADM OPERATING SYS
160	ADMDB	ADM DATA BASES
170	ADMDC	ADM DATA COMM
180	DOC	DOCUMENT

Class schedule table (CL_SCHED)

The class schedule table describes each class, the start time for the class, the end time for the class, and the class code.

The class schedule table is created with the following CREATE TABLE statement:

```
CREATE TABLE CL_SCHED
(CLASS_CODE          CHAR(7),
"DAY"              SMALLINT,
STARTING           TIME,
ENDING            TIME)
```

The table below gives the contents of the columns.

Column name	Description
CLASS_CODE	Class code (room:teacher)
DAY	Day number of 4 day schedule
STARTING	Class start time
ENDING	Class end time

CL_SCHED

Here is a complete listing of the data in the CL_SCHED table.

CLASS_CODE	DAY	STARTING	ENDING
042:BF	4	12:10:00	14:00:00
553:MJA	1	10:30:00	11:00:00
543:CWM	3	09:10:00	10:30:00
778:RES	2	12:10:00	14:00:00
044:HD	3	17:12:30	18:00:00

In-tray table (IN_TRAY)

The in-tray table describes an electronic in-basket that contains the timestamp when a message is received, the user ID of the person who sent the message, and the content of the message.

The in tray table is created with the following CREATE TABLE statement:

```
CREATE TABLE IN_TRAY
(RECEIVED          TIMESTAMP,
SOURCE            CHAR(8),
SUBJECT           CHAR(64),
NOTE_TEXT         VARCHAR(3000))
```

The table below gives the contents of the columns.

Column name	Description
RECEIVED	Date and time received
SOURCE	User ID of person sending the note
SUBJECT	Brief description of the note
NOTE_TEXT	The note

IN_TRAY

Here is a complete listing of the data in the IN_TRAY table.

RECEIVED	SOURCE	SUBJECT	NOTE_TEXT
1988-12-25-17.1 2.30.000000	BADAMSON	FWD: Fantastic year! 4th Quarter Bonus.	To: JWALKER Cc: QUINTANA, NICHOLLS Jim, Looks like our hard work has paid off. I have some good beer in the fridge if you want to come over to celebrate a bit. Delores and Heather, are you interested as well? Bruce <Forwarding from ISTERN> Subject: FWD: Fantastic year! 4th Quarter Bonus. To: Dept_D11 Congratulations on a job well done. Enjoy this year's bonus. Irv <Forwarding from CHAAS> Subject: Fantastic year! 4th Quarter Bonus. To: All_Managers Our 4th quarter results are in. We pulled together as a team and exceeded our plan! I am pleased to announce a bonus this year of 18%. Enjoy the holidays. Christine Haas
1988-12-23-08.5 3.58.000000	ISTERN	FWD: Fantastic year! 4th Quarter Bonus.	To: Dept_D11 Congratulations on a job well done. Enjoy this year's bonus. Irv <Forwarding from CHAAS> Subject: Fantastic year! 4th Quarter Bonus. To: All_Managers Our 4th quarter results are in. We pulled together as a team and exceeded our plan! I am pleased to announce a bonus this year of 18%. Enjoy the holidays. Christine Haas
1988-12-22-14.0 7.21.136421	CHAAS	Fantastic year! 4th Quarter Bonus.	To: All_Managers Our 4th quarter results are in. We pulled together as a team and exceeded our plan! I am pleased to announce a bonus this year of 18%. Enjoy the holidays. Christine Haas

Organization table (ORG)

The organization table describes the organization of the corporation.

The organization table is created with the following CREATE TABLE statement:

```
CREATE TABLE ORG
(DEPTNUMB SMALLINT NOT NULL,
DEPTNAME VARCHAR(14),
MANAGER SMALLINT,
DIVISION VARCHAR(10),
LOCATION VARCHAR(13))
```

The table below gives the contents of the columns.

Column name	Description
DEPTNUMB	Department number
DEPTNAME	Department name
MANAGER	Manager number for the department
DIVISION	Division of the department
LOCATION	Location of the department

ORG

Here is a complete listing of the data in the ORG table.

DEPTNUMB	DEPTNAME	MANAGER	DIVISION	LOCATION
10	Head Office	160	Corporate	New York
15	New England	50	Eastern	Boston
20	Mid Atlantic	10	Eastern	Washington
38	South Atlantic	30	Eastern	Atlanta
42	Great Lakes	100	Midwest	Chicago
51	Plains	140	Midwest	Dallas
66	Pacific	270	Western	San Francisco
84	Mountain	290	Western	Denver

Staff table (STAFF)

The staff table describes the background information about employees.

The staff table is created with the following CREATE TABLE statement:

```
CREATE TABLE STAFF
(ID SMALLINT NOT NULL,
NAME VARCHAR(9),
DEPT SMALLINT,
JOB CHAR(5),
YEARS SMALLINT,
SALARY DECIMAL(7,2),
COMM DECIMAL(7,2))
```

The table below shows the contents of the columns.

Column name	Description
ID	Employee number

Column name	Description
NAME	Employee name
DEPT	Department number
JOB	Job title
YEARS	Years with the company
SALARY	Employee's annual salary
COMM	Employee's commission

STAFF

Here is a complete listing of the data in the STAFF table.

ID	NAME	DEPT	JOB	YEARS	SALARY	COMM
10	Sanders	20	Mgr	7	18357.50	?
20	Pernal	20	Sales	8	18171.25	612.45
30	Marenghi	38	Mgr	5	17506.75	?
40	O'Brien	38	Sales	6	18006.00	846.55
50	Hanes	15	Mgr	10	20659.80	?
60	Quigley	38	Sales	7	16508.30	650.25
70	Rothman	15	Sales	7	16502.83	1152.00
80	James	20	Clerk	?	13504.60	128.20
90	Koonitz	42	Sales	6	18001.75	1386.70
100	Plotz	42	Mgr	7	18352.80	?
110	Ngan	15	Clerk	5	12508.20	206.60
120	Naughton	38	Clerk	?	12954.75	180.00
130	Yamaguchi	42	Clerk	6	10505.90	75.60
140	Fraye	51	Mgr	6	21150.00	?
150	Williams	51	Sales	6	19456.50	637.65
160	Molinare	10	Mgr	7	22959.20	?
170	Kermisch	15	Clerk	4	12258.50	110.10
180	Abrahams	38	Clerk	3	12009.75	236.50
190	Sneider	20	Clerk	8	14252.75	126.50
200	Scoutten	42	Clerk	?	11508.60	84.20
210	Lu	10	Mgr	10	20010.00	?
220	Smith	51	Sales	7	17654.50	992.80
230	Lundquist	51	Clerk	3	13369.80	189.65
240	Daniels	10	Mgr	5	19260.25	?
250	Wheeler	51	Clerk	6	14460.00	513.30
260	Jones	10	Mgr	12	21234.00	?

ID	NAME	DEPT	JOB	YEARS	SALARY	COMM
270	Lea	66	Mgr	9	18555.50	?
280	Wilson	66	Sales	9	18674.50	811.50
290	Quill	84	Mgr	10	19818.00	?
300	Davis	84	Sales	5	15454.50	806.10
310	Graham	66	Sales	13	21000.00	200.30
320	Gonzales	66	Sales	4	16858.20	844.00
330	Burke	66	Clerk	1	10988.00	55.50
340	Edwards	84	Sales	7	17844.00	1285.00
3650	Gafney	84	Clerk	5	13030.50	188.00

Sales table (SALES)

The sales table describes the information about each sale for each sales person.

The sales table is created with the following CREATE TABLE statement:

```
CREATE TABLE SALES
(SALES_DATE DATE,
SALES_PERSON VARCHAR(15),
REGION VARCHAR(15),
SALES INTEGER)
```

The table below gives the contents of the columns.

Column name	Description
SALES_DATE	Date the sale was made
SALES_PERSON	Person making the sale
REGION	Region where the sale was made
SALES	Number of sales

SALES

Here is a complete listing of the data in the SALES table.

SALES_DATE	SALES_PERSON	REGION	SALES
12/31/1995	LUCCHESSI	Ontario-South	1
12/31/1995	LEE	Ontario-South	3
12/31/1995	LEE	Quebec	1
12/31/1995	LEE	Manitoba	2
12/31/1995	GOUNOT	Quebec	1
03/29/1996	LUCCHESSI	Ontario-South	3
03/29/1996	LUCCHESSI	Quebec	1
03/29/1996	LEE	Ontario-South	2
03/29/1996	LEE	Ontario-North	2
03/29/1996	LEE	Quebec	3

SALES_DATE	SALES_PERSON	REGION	SALES
03/29/1996	LEE	Manitoba	5
03/29/1996	GOUNOT	Ontario-South	3
03/29/1996	GOUNOT	Quebec	1
03/29/1996	GOUNOT	Manitoba	7
03/30/1996	LUCCHESSI	Ontario-South	1
03/30/1996	LUCCHESSI	Quebec	2
03/30/1996	LUCCHESSI	Manitoba	1
03/30/1996	LEE	Ontario-South	7
03/30/1996	LEE	Ontario-North	3
03/30/1996	LEE	Quebec	7
03/30/1996	LEE	Manitoba	4
03/30/1996	GOUNOT	Ontario-South	2
03/30/1996	GOUNOT	Quebec	18
03/30/1996	GOUNOT	Manitoba	1
03/31/1996	LUCCHESSI	Manitoba	1
03/31/1996	LEE	Ontario-South	14
03/31/1996	LEE	Ontario-North	3
03/31/1996	LEE	Quebec	7
03/31/1996	LEE	Manitoba	3
03/31/1996	GOUNOT	Ontario-South	2
03/31/1996	GOUNOT	Quebec	1
04/01/1996	LUCCHESSI	Ontario-South	3
04/01/1996	LUCCHESSI	Manitoba	1
04/01/1996	LEE	Ontario-South	8
04/01/1996	LEE	Ontario-North	?
04/01/1996	LEE	Quebec	8
04/01/1996	LEE	Manitoba	9
04/01/1996	GOUNOT	Ontario-South	3
04/01/1996	GOUNOT	Ontario-North	1
04/01/1996	GOUNOT	Quebec	3
04/01/1996	GOUNOT	Manitoba	7

Sample XML tables

These sample tables can be used for working with XML concepts.

A stored procedure is included as part of the system that contains the data definition language (DDL) statements to create all of these tables and the INSERT statements to populate them. The procedure creates the schema specified on the call to the procedure. Because this is an external stored procedure,

it can be called from any SQL interface, including interactive SQL and IBM i Access Client Solutions (ACS). To call the procedure where SAMPLEXML is the schema that you want to create, issue the following statement:

```
CALL QSYS.CREATE_XML_SAMPLE ('SAMPLEXML')
```

The schema name must be specified in uppercase. The schema will be created if it does not already exist. Make sure your job's CCSID is set to something other than 65535 before calling the procedure or it will get errors.

Note: In the sample table data descriptions, a question mark (?) indicates a null value.

Product table (PRODUCT)

The product table identifies every product by a product ID and lists the product information.

The product table is created with the following CREATE TABLE statement:

```
CREATE TABLE PRODUCT
( PID          VARCHAR(10) NOT NULL,
  NAME         VARCHAR(128),
  PRICE        DECIMAL(30,2),
  PROMOPRICE   DECIMAL(30,2),
  PROMOSTART   DATE,
  PROMOEND     DATE,
  DESCRIPTION  XML,
  PRIMARY KEY (PID) )
```

PRODUCT

Here is a complete listing of the data in the PRODUCT table.

PID	NAME	PRICE	PROMO PRICE	PROMO START	PROMO END	DESCRIPTION, shown as it appears using the XMLSERIALIZE scalar function to convert it to serialized character data
100-100-01	Snow Shovel, Basic 22 inch	9.99	7.25	11/19/2004	12/19/2004	<product pid="100-100-01"><description><name>Snow Shovel, Basic 22 inch</name><details>Basic Snow Shovel, 22 inches wide, straight handle with D-Grip</details><price>9.99</price><weight>1 kg</weight></description></product>
100-101-01	Snow Shovel, Deluxe 24 inch	19.99	15.99	12/18/2005	02/28/2006	<product pid="100-101-01"><description><name>Snow Shovel, Deluxe 24 inch</name><details>A Deluxe Snow Shovel, 24 inches wide, ergonomic curved handle with D-Grip</details><price>19.99</price><weight>2 kg</weight></description></product>

PID	NAME	PRICE	PROMO PRICE	PROMO START	PROMO END	DESCRIPTION, shown as it appears using the XMLSERIALIZE scalar function to convert it to serialized character data
100-103-01	Snow Shovel, Super Deluxe 26 inch	49.99	39.99	12/22/2005	02/22/2006	<product pid="100-103-01"> <description> <name>Snow Shovel, Super Deluxe 26 inch</name> <details>Super Deluxe Snow Shovel, 26 inches wide, ergonomic battery heated curved handle with upgraded D-Grip</details> <price>49.99</price> <weight>3 kg</weight> </description> </product>
100-201-01	Ice Scraper, Windshield 4 inch	3.99	-	-	-	<product pid="100-201-01"> <description> <name>Ice Scraper, Windshield 4 inch</name> <details>Basic Ice Scraper 4 inches wide, foam handle</details> <price>3.99</price> </description> </product>

Purchase order table (PURCHASEORDER)

The purchase order table identifies every purchase order by a purchase order ID and lists basic purchase order information.

The purchase order table is created with the following CREATE TABLE and ALTER TABLE statements:

```
CREATE TABLE PURCHASEORDER
( POID          BIGINT NOT NULL,
  STATUS        VARCHAR(10) NOT NULL WITH DEFAULT 'Unshipped',
  CUSTID        BIGINT
  ORDERDATE    DATE
  PORDER       XML
  COMMENTS     VARCHAR(1000),
  PRIMARY KEY (POID) )

ALTER TABLE PURCHASEORDER
ADD FOREIGN KEY FK_PO_CUST(CUSTID)
REFERENCES CUSTOMER(CID)
ON DELETE CASCADE
```

PURCHASEORDER

Here is a complete listing of the data in the PURCHASEORDER table.

POID	STATUS	CUSTID	ORDERDATE	PORDER, shown as it appears using the XMLSERIALIZE scalar function to convert it to serialized character data	COMMENTS
5000	Unshipped	1002	02/18/2006	<pre><PurchaseOrder PoNum="5000" OrderDate="2006-02-18" Status="Unshipped"> <item> <partid>100-100-01</partid> <name>Snow Shovel, Basic 22 inch </name> <quantity>3</quantity> <price>9.99</price> </item> <item> <partid>100-103-01</partid> <name>Snow Shovel, Super Deluxe 26 inch </name> <quantity>5</quantity> <price>49.99</price> </item> </PurchaseOrder></pre>	THIS IS A NEW PURCHASE ORDER
5001	Shipped	1003	02/03/2005	<pre><PurchaseOrder PoNum="5001" OrderDate="2005-02-03" Status="Shipped"> <item> <partid>100-101-01</partid> <name>Snow Shovel, Deluxe 24 inch </name> <quantity>1</quantity> <price>19.99</price> </item> <item> <partid>100-103-01</partid> <name>Snow Shovel, Super Deluxe 26 inch </name> <quantity>2</quantity> <price>49.99</price> </item> <item> <partid>100-201-01</partid> <name>Ice Scraper, Windshield 4 inch </name> <quantity>1</quantity> <price>3.99</price> </item> </PurchaseOrder></pre>	THIS IS A NEW PURCHASE ORDER

POID	STATUS	CUSTID	ORDERDATE	PORDER, shown as it appears using the XMLSERIALIZE scalar function to convert it to serialized character data	COMMENTS
5002	Shipped	1001	02/29/2004	<pre> <PurchaseOrder PoNum="5002" OrderDate="2004-02-29" Status="Shipped"> <item> <partid>100-100-01</partid> <name>Snow Shovel, Basic 22 inch </name> <quantity>3</quantity> <price>9.99</price> </item> <item> <partid>100-101-01</partid> <name>Snow Shovel, Deluxe 24 inch </name> <quantity>5</quantity> <price>19.99</price> </item> <item> <partid>100-201-01</partid> <name>Ice Scraper, Windshield 4 inch </name> <quantity>5</quantity> <price>3.99</price> </item> </PurchaseOrder> </pre>	THIS IS A NEW PURCHASE ORDER
5003	Shipped	1002	02/28/2005	<pre> <PurchaseOrder PoNum="5003" OrderDate="2005-02-28" Status="UnShipped"> <item> <partid>100-100-01</partid> <name>Snow Shovel, Basic 22 inch </name> <quantity>1</quantity> <price>9.99</price> </item> </PurchaseOrder> </pre>	THIS IS A NEW PURCHASE ORDER

POID	STATUS	CUSTID	ORDERDATE	PORDER, shown as it appears using the XMLSERIALIZE scalar function to convert it to serialized character data	COMMENTS
5004	Shipped	1005	11/18/2005	<pre> <PurchaseOrder PoNum="5004" OrderDate="2005-11-18" Status="Shipped"> <item> <partid>100-100-01</partid> <name>Snow Shovel, Basic 22 inch </name> <quantity>4</quantity> <price>9.99</price> </item> < item> <partid>100-103-01</partid> <name>Snow Shovel, Super Deluxe 26 inch </name> <quantity>2</quantity> <price>49.99</price> </item> </PurchaseOrder> </pre>	THIS IS A NEW PURCHASE ORDER
5005	Shipped	1002	03/01/2006	<pre> <PurchaseOrder PoNum="5006" OrderDate="2006-03-01" Status="Shipped"> <item> <partid>100-100-01</partid> <name>Snow Shovel, Basic 22 inch </name> <quantity>3</quantity> <price>9.99</price> </item> <item> <partid>100-101-01</partid> <name>Snow Shovel, Deluxe 24 inch </name> <quantity>5</quantity> <price>19.99</price> </item> <item> <partid>100-201-01</partid> <name>Ice Scraper, Windshield 4 inch </name> <quantity>5</quantity> <price>3.99</price> </item> </PurchaseOrder> </pre>	THIS IS A NEW PURCHASE ORDER

Customer table (CUSTOMER)

The customer table identifies every customer by a customer ID and lists basic customer information.

The customer table is created with the following CREATE TABLE statement:

```
CREATE TABLE CUSTOMER
(
  CID          BIGINT NOT NULL,
  INFO        XML,
  HISTORY     XML,
  PRIMARY KEY (CID) )
```

CUSTOMER

Here is a complete listing of the data in the CUSTOMER table.

CID	INFO, shown as it appears using the XMLSERIALIZE scalar function to convert it to serialized character data	HISTORY
1000	<customerinfo Cid="1000"> <name>Kathy Smith</name> <addr country="Canada"> <street>5 Rosewood</street> <city>Toronto</city> <prov-state>Ontario</prov-state> <pcode-zip>M6W 1E6</pcode-zip> </addr> <phone type="work">416-555-1358</phone> </customerinfo>	?
1001	<customerinfo Cid="1001"> <name>Kathy Smith</name> <addr country="Canada"> <street>25 EastCreek</street> <city>Markham</city> <prov-state>Ontario</prov-state> <pcode-zip>N9C 3T6</pcode-zip> </addr> <phone type="work">905-555-7258</phone> </customerinfo>	?
1002	<customerinfo Cid="1002"> <name>Jim Noodle</name> <addr country="Canada"> <street>25 EastCreek</street> <city>Markham</city> <prov-state>Ontario</prov-state> <pcode-zip>N9C 3T6</pcode-zip> </addr> <phone type="work">905-555-7258</phone> </customerinfo>	?

CID	INFO, shown as it appears using the XMLESERIALIZE scalar function to convert it to serialized character data	HISTORY
1003	<pre><customerinfo Cid="1003"> <name>Robert Shoemaker</name> <addr country="Canada"> <street>1596 Baseline</street> <city>Aurora</city> <prov-state>Ontario</prov-state> <pcode-zip>N8X 7F8</pcode-zip> </addr> <phone type="work">905-555-7258</phone> <phone type="home">416-555-2937</phone> <phone type="cell">905-555-8743</phone> <phone type="cottage">613-555-3278</phone> </customerinfo></pre>	?
1004	<pre><customerinfo Cid="1004"> <name>Matt Foreman</name> <addr country="Canada"> <street>1596 Baseline</street> <city>Toronto</city> <prov-state>Ontario</prov-state> <pcode-zip>M3Z 5H9</pcode-zip> </addr> <phone type="work">905-555-4789</phone> <phone type="home">416-555-3376</phone> <assistant> <name>Gopher Runner</name> <phone type="home">416-555-3426</phone> </assistant> </customerinfo></pre>	?
1005	<pre><customerinfo Cid="1005"> <name>Larry Menard</name> <addr country="Canada"> <street>223 Nature Valley Road</street> <city>Toronto</city> <prov-state>Ontario</prov-state> <pcode-zip>M4C 5K8</pcode-zip> </addr> <phone type="work">905-555-9146</phone> <phone type="home">416-555-6121</phone> <assistant> <name>Goose Defender</name> <phone type="home">416-555-1943</phone> </assistant> </customerinfo></pre>	?

Catalog table (CATALOG)

The catalog table describes each catalog.

The catalog table is created with the following CREATE TABLE statement:

```
CREATE TABLE CATALOG
( NAME          VARCHAR(128) NOT NULL,
  CATLOG       XML,
  PRIMARY KEY (NAME) )
```

CATALOG

The CATALOG table contains no data.

Suppliers table (SUPPLIERS)

The suppliers table identifies every supplier and lists basic supplier information.

The suppliers table is created with the following CREATE TABLE statement:

```
CREATE TABLE SUPPLIERS
( SID          VARCHAR(10) NOT NULL,
  ADDR        XML,
  PRIMARY KEY (SID) )
```

SUPPLIERS

Here is a complete listing of the data in the SUPPLIERS table.

SID	ADDR
100	<pre><supplierinfo xmlns="http://posample.org" Sid="100"> <name>Harry Suppliers</name> <addr country="Canada"> <street>50 EastCreek</street> <city>Markham</city> <prov-state>Ontario</prov-state> <pcode-zip>N9C 3T6</pcode-zip> </addr> </supplierinfo></pre>
101	<pre><supplierinfo xmlns="http://posample.org" Sid="101"> <name>Johnston Suppliers</name> <addr country="Canada"> <street>302 NatureValley Road</street> <city>Toronto</city> <prov-state>Ontario</prov-state> <pcode-zip>M4C 5K8</pcode-zip> </addr> </supplierinfo></pre>

Inventory table (INVENTORY)

The inventory table describes the inventory based on a product ID.

The inventory table is created with the following CREATE TABLE statement:

```
CREATE TABLE INVENTORY
( PID          VARCHAR(10) NOT NULL,
  QUANTITY     INTEGER,
  LOCATION     VARCHAR(128),
  PRIMARY KEY (PID) )
```

INVENTORY

Here is a complete listing of the data in the INVENTORY table.

PID	QUANTITY	LOCATION
100-100-01	5	-
100-101-01	25	Store
100-103-01	55	Store
100-201-01	99	Warehouse

Product Supplier table (PRODUCTSUPPLIER)

The product supplier table describes the relationship between a product and its supplier.

The product supplier table is created with the following CREATE TABLE statement:

```
CREATE TABLE PRODUCTSUPPLIER
( PID          VARCHAR(10) NOT NULL,
  SID          VARCHAR(10) NOT NULL,
  PRIMARY KEY (PID, SID) )
```

PRODUCTSUPPLIER

Here is a complete listing of the data in the PRODUCTSUPPLIER table.

PID	SID
100-101-01	100
100-201-01	101

Db2 for i CL command descriptions

Db2 for i provides these CL commands for SQL.

- [Create SQL Package \(CRTSQLPKG\) command](#)
- [Delete SQL Package \(DLTSQLPKG\) command](#)
- [Print SQL Information \(PRTSQLINF\) command](#)
- [Run SQL Statement \(RUNSQLSTM\) command](#)
- [Start SQL Interactive Session \(STRSQL\) command](#)

Related reference

[Db2 for i distributed relational database support](#)

The IBM DB2 Query Manager and SQL Development Kit for i licensed program supports interactive access to distributed databases.

Code license and disclaimer information

IBM grants you a nonexclusive copyright license to use all programming code examples from which you can generate similar function tailored to your own specific needs.

SUBJECT TO ANY STATUTORY WARRANTIES WHICH CANNOT BE EXCLUDED, IBM, ITS PROGRAM DEVELOPERS AND SUPPLIERS MAKE NO WARRANTIES OR CONDITIONS EITHER EXPRESS OR IMPLIED, INCLUDING BUT NOT LIMITED TO, THE IMPLIED WARRANTIES OR CONDITIONS OF MERCHANTABILITY, FITNESS FOR A PARTICULAR PURPOSE, AND NON-INFRINGEMENT, REGARDING THE PROGRAM OR TECHNICAL SUPPORT, IF ANY.

UNDER NO CIRCUMSTANCES IS IBM, ITS PROGRAM DEVELOPERS OR SUPPLIERS LIABLE FOR ANY OF THE FOLLOWING, EVEN IF INFORMED OF THEIR POSSIBILITY:

1. LOSS OF, OR DAMAGE TO, DATA;
2. DIRECT, SPECIAL, INCIDENTAL, OR INDIRECT DAMAGES, OR FOR ANY ECONOMIC CONSEQUENTIAL DAMAGES; OR
3. LOST PROFITS, BUSINESS, REVENUE, GOODWILL, OR ANTICIPATED SAVINGS.

SOME JURISDICTIONS DO NOT ALLOW THE EXCLUSION OR LIMITATION OF DIRECT, INCIDENTAL, OR CONSEQUENTIAL DAMAGES, SO SOME OR ALL OF THE ABOVE LIMITATIONS OR EXCLUSIONS MAY NOT APPLY TO YOU.

Notices

This information was developed for products and services offered in the U.S.A.

IBM may not offer the products, services, or features discussed in this document in other countries. Consult your local IBM representative for information on the products and services currently available in your area. Any reference to an IBM product, program, or service is not intended to state or imply that only that IBM product, program, or service may be used. Any functionally equivalent product, program, or service that does not infringe any IBM intellectual property right may be used instead. However, it is the user's responsibility to evaluate and verify the operation of any non-IBM product, program, or service.

IBM may have patents or pending patent applications covering subject matter described in this document. The furnishing of this document does not grant you any license to these patents. You can send license inquiries, in writing, to:

IBM Director of Licensing
IBM Corporation
North Castle Drive
Armonk, NY 10504-1785
U.S.A.

For license inquiries regarding double-byte (DBCS) information, contact the IBM Intellectual Property Department in your country or send inquiries, in writing, to:

Intellectual Property Licensing
Legal and Intellectual Property Law
IBM Japan Ltd.
1623-14, Shimotsuruma, Yamato-shi
Kanagawa 242-8502 Japan

The following paragraph does not apply to the United Kingdom or any other country where such provisions are inconsistent with local law: INTERNATIONAL BUSINESS MACHINES CORPORATION PROVIDES THIS PUBLICATION "AS IS" WITHOUT WARRANTY OF ANY KIND, EITHER EXPRESS OR IMPLIED, INCLUDING, BUT NOT LIMITED TO, THE IMPLIED WARRANTIES OF NON-INFRINGEMENT, MERCHANTABILITY OR FITNESS FOR A PARTICULAR PURPOSE. Some states do not allow disclaimer of express or implied warranties in certain transactions, therefore, this statement may not apply to you.

This information could include technical inaccuracies or typographical errors. Changes are periodically made to the information herein; these changes will be incorporated in new editions of the publication. IBM may make improvements and/or changes in the product(s) and/or the program(s) described in this publication at any time without notice.

Any references in this information to non-IBM Web sites are provided for convenience only and do not in any manner serve as an endorsement of those Web sites. The materials at those Web sites are not part of the materials for this IBM product and use of those Web sites is at your own risk.

IBM may use or distribute any of the information you supply in any way it believes appropriate without incurring any obligation to you.

Licensees of this program who wish to have information about it for the purpose of enabling: (i) the exchange of information between independently created programs and other programs (including this one) and (ii) the mutual use of the information which has been exchanged, should contact:

IBM Corporation
Software Interoperability Coordinator, Department YBWA
3605 Highway 52 N
Rochester, MN 55901
U.S.A.

Such information may be available, subject to appropriate terms and conditions, including in some cases, payment of a fee.

The licensed program described in this document and all licensed material available for it are provided by IBM under terms of the IBM Customer Agreement, IBM International Program License Agreement or any equivalent agreement between us.

Any performance data contained herein was determined in a controlled environment. Therefore, the results obtained in other operating environments may vary significantly. Some measurements may have been made on development-level systems and there is no guarantee that these measurements will be the same on generally available systems. Furthermore, some measurements may have been estimated through extrapolation. Actual results may vary. Users of this document should verify the applicable data for their specific environment.

Information concerning non-IBM products was obtained from the suppliers of those products, their published announcements or other publicly available sources. IBM has not tested those products and cannot confirm the accuracy of performance, compatibility or any other claims related to non-IBM products. Questions on the capabilities of non-IBM products should be addressed to the suppliers of those products.

All statements regarding IBM's future direction or intent are subject to change or withdrawal without notice, and represent goals and objectives only.

This information is for planning purposes only. The information herein is subject to change before the products described become available.

This information contains examples of data and reports used in daily business operations. To illustrate them as completely as possible, the examples include the names of individuals, companies, brands, and products. All of these names are fictitious and any similarity to the names and addresses used by an actual business enterprise is entirely coincidental.

COPYRIGHT LICENSE:

This information contains sample application programs in source language, which illustrate programming techniques on various operating platforms. You may copy, modify, and distribute these sample programs in any form without payment to IBM, for the purposes of developing, using, marketing or distributing application programs conforming to the application programming interface for the operating platform for which the sample programs are written. These examples have not been thoroughly tested under all conditions. IBM, therefore, cannot guarantee or imply reliability, serviceability, or function of these programs. The sample programs are provided "AS IS", without warranty of any kind. IBM shall not be liable for any damages arising out of your use of the sample programs.

Each copy or any portion of these sample programs or any derivative work, must include a copyright notice as follows:

© (your company name) (year). Portions of this code are derived from IBM Corp. Sample Programs.

© Copyright IBM Corp. _enter the year or years_.

Programming interface information

This SQL programming publication documents intended Programming Interfaces that allow the customer to write programs to obtain the services of IBM i.

Trademarks

IBM, the IBM logo, and ibm.com are trademarks or registered trademarks of International Business Machines Corp., registered in many jurisdictions worldwide. Other product and service names might be trademarks of IBM or other companies. A current list of IBM trademarks is available on the Web at "[Copyright and trademark information](http://www.ibm.com/legal/copytrade.shtml)" at www.ibm.com/legal/copytrade.shtml.

Adobe, the Adobe logo, PostScript, and the PostScript logo are either registered trademarks or trademarks of Adobe Systems Incorporated in the United States, and/or other countries.

Linux is a registered trademark of Linus Torvalds in the United States, other countries, or both.

Microsoft, Windows, Windows NT, and the Windows logo are trademarks of Microsoft Corporation in the United States, other countries, or both.

UNIX is a registered trademark of The Open Group in the United States and other countries.

Java and all Java-based trademarks and logos are trademarks of Oracle, Inc. in the United States, other countries, or both.

Other product and service names might be trademarks of IBM or other companies.

Terms and conditions

Permissions for the use of these publications is granted subject to the following terms and conditions.

Personal Use: You may reproduce these publications for your personal, noncommercial use provided that all proprietary notices are preserved. You may not distribute, display or make derivative works of these publications, or any portion thereof, without the express consent of IBM.

Commercial Use: You may reproduce, distribute and display these publications solely within your enterprise provided that all proprietary notices are preserved. You may not make derivative works of these publications, or reproduce, distribute or display these publications or any portion thereof outside your enterprise, without the express consent of IBM.

Except as expressly granted in this permission, no other permissions, licenses or rights are granted, either express or implied, to the publications or any information, data, software or other intellectual property contained therein.

IBM reserves the right to withdraw the permissions granted herein whenever, in its discretion, the use of the publications is detrimental to its interest or, as determined by IBM, the above instructions are not being properly followed.

You may not download, export or re-export this information except in full compliance with all applicable laws and regulations, including all United States export laws and regulations.

IBM MAKES NO GUARANTEE ABOUT THE CONTENT OF THESE PUBLICATIONS. THE PUBLICATIONS ARE PROVIDED "AS-IS" AND WITHOUT WARRANTY OF ANY KIND, EITHER EXPRESSED OR IMPLIED, INCLUDING BUT NOT LIMITED TO IMPLIED WARRANTIES OF MERCHANTABILITY, NON-INFRINGEMENT, AND FITNESS FOR A PARTICULAR PURPOSE.



Product Number: 5770-SS1